

ELECTROMAGNETIC EMISSIONS COMPLIANCE REPORT

INTENTIONAL RADIATOR CERTIFICATION TO FCC PART 15 SUBPART C REQUIREMENT AND INDUSTRY CANADA RSS 210

OF

Product Name: AirMax AP

Brand Name: UBIQUITI

Model No.: NBE-M5-19

Model Difference: N/A

FCC ID: SWX-NBEM5

IC: 6545A-NBEM5

Report No.: E2/2013/A0028

Issue Date: Nov. 18, 2013

FCC Rule Part: §15.247, Cat: DTS

IC Rule Part: RSS-210 issue 8 :2010, Annex 8

Prepared for FCC: Ubiquiti Networks, Inc.
12F, No. 105, Song Ren Rd., Sin Yi District,
Taipei 110, Taiwan

Prepared for IC: UBIQUITI NETWORKS
12F, No. 105, Song Ren Rd., Sin Yi District,
Taipei 110, Taiwan

Prepared by: SGS Taiwan Ltd.
Electronics & Communication Laboratory
No.2, Keji 1st Rd., Guishan Township, Taoyuan
County, Taiwan 333



Note: This report shall not be reproduced except in full, without the written approval of SGS Taiwan Ltd. This document may be altered or revised by SGS Taiwan Ltd. personnel only, and shall be noted in the revision section of the document.

Unless otherwise stated the results shown in this test report refer only to the sample(s) tested and such sample(s) are retained for 90 days only.

除非另有說明，此報告結果僅對測試之樣品負責，同時此樣品僅保留90天。本報告未經本公司書面許可，不可部份複製。

This document is issued by the Company subject to its General Conditions of Service printed overleaf, available on request or accessible at www.sgs.com/terms_and_conditions.htm and, for electronic format documents, subject to Terms and Conditions for Electronic Documents at www.sgs.com/terms_e-document.htm. Attention is drawn to the limitation of liability, indemnification and jurisdiction issues defined therein. Any holder of this document is advised that information contained hereon reflects the Company's findings at the time of its intervention only and within the limits of Client's instructions, if any. The Company's sole responsibility is to its Client and this document does not exonerate parties to a transaction from exercising all their rights and obligations under the transaction documents. This document cannot be reproduced except in full, without prior written approval of the Company. Any unauthorized alteration, forgery or falsification of the content or appearance of this document is unlawful and offenders may be prosecuted to the fullest extent of the law.

SGS Taiwan Ltd.

No.134,WuKungRoad,NewTaipeiIndustrialPark,WukuDistrict,NewTaipeiCity,Taiwan24803/新北市五股區新北產業園區五工路 134 號

台灣檢驗科技股份有限公司

t (886-2) 2299-3279

f (886-2) 2298-0488

www.tw.sgs.com

Member of SGS Group

VERIFICATION OF COMPLIANCE

Applicant for FCC: Ubiquiti Networks, Inc.
12F, No. 105, Song Ren Rd., Sin Yi District, Taipei 110, Taiwan

Applicant for IC: UBIQUITI NETWORKS
12F, No. 105, Song Ren Rd., Sin Yi District, Taipei 110, Taiwan

Product Name: AirMax AP

Brand Name: UBIQUITI

Model No.: NBE-M5-19

Model Difference: N/A

FCC ID: SWX-NBEM5

IC: 6545A-NBEM5

File Number: E2/2013/A0028

Date of test: Oct. 22, 2013 ~ Nov. 18, 2013

Date of EUT Received: Oct. 22, 2013

We hereby certify that:

The above equipment was tested by SGS Taiwan Ltd. Electronics & Communication Laboratory. The test data, data evaluation, test procedures, and equipment configurations shown in this report were made in accordance with the procedures given in ANSI C63.4:2009 and RSS-Gen. issue 3. The energy emitted by the sample EUT tested as described in this report is in compliance with conducted and radiated emission limits of FCC Rules Part 15.247 and IC RSS 210 issue 8: 2010 Annex 8.

The test results of this report relate only to the tested sample identified in this report.

Test By: Jazz Huang **Date** Nov. 18, 2013

Jazz Huang / Sr. Engineer

Prepared By: Judy Hsu **Date** Nov. 18, 2013

Judy Hsu / Clerk

Approved By: Jim Chang **Date** Nov. 18, 2013

Jim Chang / Supervisor

Unless otherwise stated the results shown in this test report refer only to the sample(s) tested and such sample(s) are retained for 90 days only.

除非另有說明，此報告結果僅對測試之樣品負責，同時此樣品僅保留90天。本報告未經本公司書面許可，不可部份複製。

This document is issued by the Company subject to its General Conditions of Service printed overleaf, available on request or accessible at www.sgs.com/terms_and_conditions.htm and, for electronic format documents, subject to Terms and Conditions for Electronic Documents at www.sgs.com/terms_e-document.htm. Attention is drawn to the limitation of liability, indemnification and jurisdiction issues defined therein. Any holder of this document is advised that information contained hereon reflects the Company's findings at the time of its intervention only and within the limits of Client's instructions, if any. The Company's sole responsibility is to its Client and this document does not exonerate parties to a transaction from exercising all their rights and obligations under the transaction documents. This document cannot be reproduced except in full, without prior written approval of the Company. Any unauthorized alteration, forgery or falsification of the content or appearance of this document is unlawful and offenders may be prosecuted to the fullest extent of the law.

Version

| Version No. | Date | Description |
|-------------|---------------|------------------------------|
| 00 | Nov. 18, 2013 | Initial creation of document |
| | | |
| | | |

Unless otherwise stated the results shown in this test report refer only to the sample(s) tested and such sample(s) are retained for 90 days only.

除非另有說明，此報告結果僅對測試之樣品負責，同時此樣品僅保留90天。本報告未經本公司書面許可，不可部份複製。

This document is issued by the Company subject to its General Conditions of Service printed overleaf, available on request or accessible at www.sgs.com/terms_and_conditions.htm and, for electronic format documents, subject to Terms and Conditions for Electronic Documents at www.sgs.com/terms_e-document.htm. Attention is drawn to the limitation of liability, indemnification and jurisdiction issues defined therein. Any holder of this document is advised that information contained hereon reflects the Company's findings at the time of its intervention only and within the limits of Client's instructions, if any. The Company's sole responsibility is to its Client and this document does not exonerate parties to a transaction from exercising all their rights and obligations under the transaction documents. This document cannot be reproduced except in full, without prior written approval of the Company. Any unauthorized alteration, forgery or falsification of the content or appearance of this document is unlawful and offenders may be prosecuted to the fullest extent of the law.

SGS Taiwan Ltd.

No.134,WuKungRoad,NewTaipeiIndustrialPark,WukuDistrict,NewTaipeiCity,Taiwan24803/新北市五股區新北產業園區五工路 134 號

台灣檢驗科技股份有限公司

t (886-2) 2299-3279

f (886-2) 2298-0488

www.tw.sgs.com

Member of SGS Group

Table of Contents

| | | |
|----------|--|-----------|
| 1 | GENERAL INFORMATION..... | 6 |
| 1.1 | Product description..... | 6 |
| 1.2 | Related Submittal(s) / Grant (s) | 10 |
| 1.3 | Test Methodology..... | 10 |
| 1.4 | Test Facility..... | 10 |
| 1.5 | Special Accessories..... | 10 |
| 1.6 | Equipment Modifications..... | 10 |
| 2 | SYSTEM TEST CONFIGURATION..... | 11 |
| 2.1 | EUT Configuration..... | 11 |
| 2.2 | EUT Exercise | 11 |
| 2.3 | Test Procedure..... | 11 |
| 2.4 | Configuration of Tested System..... | 12 |
| 3 | SUMMARY OF TEST RESULTS..... | 13 |
| 4 | DESCRIPTION OF TEST MODES..... | 14 |
| 5 | MEASUREMENT UNCERTAINTY | 15 |
| 6 | CONDUCTED EMISSION TEST | 16 |
| 6.1 | Standard Applicable: | 16 |
| 6.2 | Measurement Equipment Used: | 16 |
| 6.3 | EUT Setup:..... | 16 |
| 6.4 | Test SET-UP (Block Diagram of Configuration) | 17 |
| 6.5 | Measurement Procedure:..... | 17 |
| 6.6 | Measurement Result:..... | 17 |
| 7 | PEAK OUTPUT POWER MEASUREMENT | 20 |
| 7.1 | Standard Applicable: | 20 |
| 7.2 | Measurement Equipment Used: | 21 |
| 7.3 | Test Set-up:..... | 21 |
| 7.4 | Measurement Procedure:..... | 22 |
| 7.5 | Measurement Result:..... | 26 |
| 8 | 6dB BANDWIDTH..... | 37 |
| 8.1 | Standard Applicable: | 37 |
| 8.2 | Measurement Equipment Used: | 37 |
| 8.3 | Test Set-up:..... | 37 |
| 8.4 | Measurement Procedure:..... | 38 |
| 8.5 | Measurement Result:..... | 38 |

Unless otherwise stated the results shown in this test report refer only to the sample(s) tested and such sample(s) are retained for 90 days only.

除非另有說明，此報告結果僅對測試之樣品負責，同時此樣品僅保留90天。本報告未經本公司書面許可，不可部份複製。

This document is issued by the Company subject to its General Conditions of Service printed overleaf, available on request or accessible at www.sgs.com/terms_and_conditions.htm and, for electronic format documents, subject to Terms and Conditions for Electronic Documents at www.sgs.com/terms_e-document.htm. Attention is drawn to the limitation of liability, indemnification and jurisdiction issues defined therein. Any holder of this document is advised that information contained hereon reflects the Company's findings at the time of its intervention only and within the limits of Client's instructions, if any. The Company's sole responsibility is to its Client and this document does not exonerate parties to a transaction from exercising all their rights and obligations under the transaction documents. This document cannot be reproduced except in full, without prior written approval of the Company. Any unauthorized alteration, forgery or falsification of the content or appearance of this document is unlawful and offenders may be prosecuted to the fullest extent of the law.

| | | |
|-----------|---|-----------|
| 9 | BAND EDGES MEASUREMENT | 47 |
| 9.1 | Standard Applicable: | 47 |
| 9.2 | Measurement Equipment Used: | 47 |
| 9.3 | Test SET-UP:..... | 49 |
| 9.4 | Measurement Procedure:..... | 50 |
| 9.5 | The Derivation of Limit of Compliance to Unwanted Emissions into Restricted Frequency Bands | 51 |
| 9.6 | Measurement Result:..... | 51 |
| 10 | SPURIOUS EMISSION TEST..... | 55 |
| 10.1 | Standard Applicable | 55 |
| 10.2 | Measurement Equipment Used: | 56 |
| 10.3 | Test SET-UP:..... | 56 |
| 10.4 | Measurement Procedure:..... | 57 |
| 10.5 | Field Strength Calculation..... | 58 |
| 10.6 | Measurement Result:..... | 58 |
| 11 | PEAK POWER SPECTRAL DENSITY..... | 88 |
| 11.1 | Standard Applicable: | 88 |
| 11.2 | Measurement Equipment Used: | 88 |
| 11.3 | Test Set-up:..... | 88 |
| 11.4 | Measurement Procedure (following the measurement procedure 10.2 of KDB558074):..... | 89 |
| 11.5 | Measurement Result:..... | 90 |
| 12 | ANTENNA REQUIREMENT..... | 95 |
| 12.1 | Standard Applicable: | 95 |
| 12.2 | Antenna Connected Construction: | 95 |
| 13 | 99% BANDWIDTH MEASUREMENT..... | 96 |
| 13.1 | Standard Applicable: | 96 |
| 13.2 | Measurement Equipment Used: | 96 |
| 13.3 | Test Set-up:..... | 96 |
| 13.4 | Measurement Procedure:..... | 96 |
| 13.5 | Measurement Result:..... | 97 |

Unless otherwise stated the results shown in this test report refer only to the sample(s) tested and such sample(s) are retained for 90 days only.

除非另有說明，此報告結果僅對測試之樣品負責，同時此樣品僅保留90天。本報告未經本公司書面許可，不可部份複製。

This document is issued by the Company subject to its General Conditions of Service printed overleaf, available on request or accessible at www.sgs.com/terms_and_conditions.htm and, for electronic format documents, subject to Terms and Conditions for Electronic Documents at www.sgs.com/terms_e-document.htm. Attention is drawn to the limitation of liability, indemnification and jurisdiction issues defined therein. Any holder of this document is advised that information contained hereon reflects the Company's findings at the time of its intervention only and within the limits of Client's instructions, if any. The Company's sole responsibility is to its Client and this document does not exonerate parties to a transaction from exercising all their rights and obligations under the transaction documents. This document cannot be reproduced except in full, without prior written approval of the Company. Any unauthorized alteration, forgery or falsification of the content or appearance of this document is unlawful and offenders may be prosecuted to the fullest extent of the law.

SGS Taiwan Ltd.

No.134,WuKungRoad,NewTaipeiIndustrialPark,WukuDistrict,NewTaipeiCity,Taiwan24803/新北市五股區新北產業園區五工路 134 號

台灣檢驗科技股份有限公司

t (886-2) 2299-3279

f (886-2) 2298-0488

www.tw.sgs.com

Member of SGS Group

1 GENERAL INFORMATION

1.1 Product description

General:

| | | |
|-------------------|--------------------------|--|
| Product Name: | AirMax AP | |
| Brand Name: | UBIQUITI | |
| Model No.: | NBE-M5-19 | |
| Model Difference: | N/A | |
| Hardware Version: | N/A | |
| Software Version: | N/A | |
| Power Supply: | 24Vdc from AC/DC adapter | |
| | Adapter: | Model No.: GP-A240-050; Supplier: UBIQUITI |

Unless otherwise stated the results shown in this test report refer only to the sample(s) tested and such sample(s) are retained for 90 days only.

除非另有說明，此報告結果僅對測試之樣品負責，同時此樣品僅保留90天。本報告未經本公司書面許可，不可部份複製。

This document is issued by the Company subject to its General Conditions of Service printed overleaf, available on request or accessible at www.sgs.com/terms_and_conditions.htm and, for electronic format documents, subject to Terms and Conditions for Electronic Documents at www.sgs.com/terms_e-document.htm. Attention is drawn to the limitation of liability, indemnification and jurisdiction issues defined therein. Any holder of this document is advised that information contained hereon reflects the Company's findings at the time of its intervention only and within the limits of Client's instructions, if any. The Company's sole responsibility is to its Client and this document does not exonerate parties to a transaction from exercising all their rights and obligations under the transaction documents. This document cannot be reproduced except in full, without prior written approval of the Company. Any unauthorized alteration, forgery or falsification of the content or appearance of this document is unlawful and offenders may be prosecuted to the fullest extent of the law.

SGS Taiwan Ltd.

No.134,WuKungRoad,NewTaipeiIndustrialPark,WukuDistrict,NewTaipeiCity,Taiwan24803/新北市五股區新北產業園區五工路 134 號

台灣檢驗科技股份有限公司

t (886-2) 2299-3279

f (886-2) 2298-0488

www.tw.sgs.com

Member of SGS Group

WLAN 5.7GHz:

| Wi-Fi | Frequency Range | Channels | Rated Power | Modulation Technology | Type of Emission |
|----------------------|-------------------|----------|--|-----------------------|------------------|
| 11a | 5725-5850 | 5 | a: 24.97dBm | OFDM | 16M5D1D |
| 11n (5GHz) | HT20 5725-5850 | 5 | n: 20.03dBm (MIMO Chain0) n: 23.02dBm (MIMO Chain 1) n: 23.00dBm (MIMO Chain 0+1) | | 17M8D1D |
| 11n (5GHz) | HT40 5725-5850 | 2 | n: 19.32dBm (MIMO Chain0) n: 18.98dBm (MIMO Chain 1) n: 22.07dBm (MIMO Chain 0+1) | | 36M4D1D |
| Antenna Designation: | | | Array of patch Antenna 5GHz Gain (Main): 10.92dBi (5725MHz-5850MHz) 5GHz Gain (Aux): 8.22dBi (5725MHz-5850MHz) 5GHz Gain (MIMO): 9.96dBi (5725MHz-5850MHz) | | |
| Modulation type: | | | 64QAM, 16QAM, QPSK, BPSK for OFDM | | |
| Transition Rate: | | | 802.11 a: 6/9/12/18/24/36/48/54 Mbps; 802.11 n_20MHz: 6.5 – 144Mbps 802.11 n_40MHz: 13.5 – 300Mbps | | |

The max antenna gain is 10.92dBi which was choosing for Radiated Spurious Emission test.

The EUT is in compliance with FCC §15.247 at which the frequency band of 5725~5850MHz has been tested.

Unless otherwise stated the results shown in this test report refer only to the sample(s) tested and such sample(s) are retained for 90 days only.

除非另有說明，此報告結果僅對測試之樣品負責，同時此樣品僅保留90天。本報告未經本公司書面許可，不可部份複製。

This document is issued by the Company subject to its General Conditions of Service printed overleaf, available on request or accessible at www.sgs.com/terms_and_conditions.htm and, for electronic format documents, subject to Terms and Conditions for Electronic Documents at www.sgs.com/terms_e-document.htm. Attention is drawn to the limitation of liability, indemnification and jurisdiction issues defined therein. Any holder of this document is advised that information contained hereon reflects the Company's findings at the time of its intervention only and within the limits of Client's instructions, if any. The Company's sole responsibility is to its Client and this document does not exonerate parties to a transaction from exercising all their rights and obligations under the transaction documents. This document cannot be reproduced except in full, without prior written approval of the Company. Any unauthorized alteration, forgery or falsification of the content or appearance of this document is unlawful and offenders may be prosecuted to the fullest extent of the law.

IEEE 802.11n Spec:

| MCS Index | Nss | Modulation | R | NBPS | NCBPS | | NDBPS | | Datarate(Mbps) | | | |
|-----------|-----|------------|-----|------|-------|-------|-------|-------|----------------|-------|---------|-------|
| | | | | | 20MHz | 40MHz | 20MHz | 40MHz | 800nsGI | | 400nsGI | |
| | | | | | | | | | 20MHz | 40MHz | 20MHz | 40MHz |
| 0 | 1 | BPSK | 1/2 | 1 | 52 | 108 | 26 | 54 | 6.5 | 13.5 | 7.200 | 15 |
| 1 | 1 | QPSK | 1/2 | 2 | 104 | 216 | 52 | 108 | 13.0 | 27.0 | 14.400 | 30 |
| 2 | 1 | QPSK | 3/4 | 2 | 104 | 216 | 78 | 162 | 19.5 | 40.5 | 21.700 | 45 |
| 3 | 1 | 16-QAM | 1/2 | 4 | 208 | 432 | 104 | 216 | 26.0 | 54.0 | 28.900 | 60 |
| 4 | 1 | 16-QAM | 3/4 | 4 | 208 | 432 | 156 | 324 | 39.0 | 81.0 | 43.300 | 90 |
| 5 | 1 | 64-QAM | 2/3 | 6 | 312 | 648 | 208 | 432 | 52.0 | 108.0 | 57.800 | 120 |
| 6 | 1 | 64-QAM | 3/4 | 6 | 312 | 648 | 234 | 486 | 58.5 | 121.5 | 65.000 | 135 |
| 7 | 1 | 64-QAM | 5/6 | 6 | 312 | 648 | 260 | 540 | 65.0 | 135.0 | 72.200 | 150 |

| Symbol | Explanation |
|--------|---|
| NSS | Number of spatial streams |
| R | Code rate |
| NBPS | Number of coded bite per single carrier |
| NCBPS | Number of coded bite per symbol |
| NDBPS | Number of data bite per symbol |
| GI | Guard interval |

802.11n_HT20 MCS8 -15

| MCS Index | Modulation | R | N _{BPS} (i _{SS}) | N _{SD} | N _{SP} | N _{CBPS} | N _{DBPS} | Data rate (Mb/s) | |
|-----------|------------|-----|-------------------------------------|-----------------|-----------------|-------------------|-------------------|------------------|----------------------|
| | | | | | | | | 800 ns GI | 400 ns GI (see NOTE) |
| 8 | BPSK | 1/2 | 1 | 52 | 4 | 104 | 52 | 13.0 | 14.4 |
| 9 | QPSK | 1/2 | 2 | 52 | 4 | 208 | 104 | 26.0 | 28.9 |
| 10 | QPSK | 3/4 | 2 | 52 | 4 | 208 | 156 | 39.0 | 43.3 |
| 11 | 16-QAM | 1/2 | 4 | 52 | 4 | 416 | 208 | 52.0 | 57.8 |
| 12 | 16-QAM | 3/4 | 4 | 52 | 4 | 416 | 312 | 78.0 | 86.7 |
| 13 | 64-QAM | 2/3 | 6 | 52 | 4 | 624 | 416 | 104.0 | 115.6 |
| 14 | 64-QAM | 3/4 | 6 | 52 | 4 | 624 | 468 | 117.0 | 130.0 |
| 15 | 64-QAM | 5/6 | 6 | 52 | 4 | 624 | 520 | 130.0 | 144.4 |

NOTE—The 400 ns GI rate values are rounded to 1 decimal place.

Unless otherwise stated the results shown in this test report refer only to the sample(s) tested and such sample(s) are retained for 90 days only.

除非另有說明，此報告結果僅對測試之樣品負責，同時此樣品僅保留90天。本報告未經本公司書面許可，不可部份複製。

This document is issued by the Company subject to its General Conditions of Service printed overleaf, available on request or accessible at www.sgs.com/terms_and_conditions.htm and, for electronic format documents, subject to Terms and Conditions for Electronic Documents at www.sgs.com/terms_e-document.htm. Attention is drawn to the limitation of liability, indemnification and jurisdiction issues defined therein. Any holder of this document is advised that information contained hereon reflects the Company's findings at the time of its intervention only and within the limits of Client's instructions, if any. The Company's sole responsibility is to its Client and this document does not exonerate parties to a transaction from exercising all their rights and obligations under the transaction documents. This document cannot be reproduced except in full, without prior written approval of the Company. Any unauthorized alteration, forgery or falsification of the content or appearance of this document is unlawful and offenders may be prosecuted to the fullest extent of the law.

802.11n_HT40 MCS8 -15

| MCS Index | Modulation | R | $N_{BPSCS(i_{SS})}$ | N_{SD} | N_{SP} | N_{CBPS} | N_{DBPS} | Data rate (Mb/s) | |
|-----------|------------|-----|---------------------|----------|----------|------------|------------|------------------|-----------|
| | | | | | | | | 800 ns GI | 400 ns GI |
| 8 | BPSK | 1/2 | 1 | 108 | 6 | 216 | 108 | 27.0 | 30.0 |
| 9 | QPSK | 1/2 | 2 | 108 | 6 | 432 | 216 | 54.0 | 60.0 |
| 10 | QPSK | 3/4 | 2 | 108 | 6 | 432 | 324 | 81.0 | 90.0 |
| 11 | 16-QAM | 1/2 | 4 | 108 | 6 | 864 | 432 | 108.0 | 120.0 |
| 12 | 16-QAM | 3/4 | 4 | 108 | 6 | 864 | 648 | 162.0 | 180.0 |
| 13 | 64-QAM | 2/3 | 6 | 108 | 6 | 1296 | 864 | 216.0 | 240.0 |
| 14 | 64-QAM | 3/4 | 6 | 108 | 6 | 1296 | 972 | 243.0 | 270.0 |
| 15 | 64-QAM | 5/6 | 6 | 108 | 6 | 1296 | 1080 | 270.0 | 300.0 |

Unless otherwise stated the results shown in this test report refer only to the sample(s) tested and such sample(s) are retained for 90 days only.

除非另有說明，此報告結果僅對測試之樣品負責，同時此樣品僅保留90天。本報告未經本公司書面許可，不可部份複製。

This document is issued by the Company subject to its General Conditions of Service printed overleaf, available on request or accessible at www.sgs.com/terms_and_conditions.htm and, for electronic format documents, subject to Terms and Conditions for Electronic Documents at www.sgs.com/terms_e-document.htm. Attention is drawn to the limitation of liability, indemnification and jurisdiction issues defined therein. Any holder of this document is advised that information contained hereon reflects the Company's findings at the time of its intervention only and within the limits of Client's instructions, if any. The Company's sole responsibility is to its Client and this document does not exonerate parties to a transaction from exercising all their rights and obligations under the transaction documents. This document cannot be reproduced except in full, without prior written approval of the Company. Any unauthorized alteration, forgery or falsification of the content or appearance of this document is unlawful and offenders may be prosecuted to the fullest extent of the law.

SGS Taiwan Ltd.

No.134,WuKungRoad,NewTaipeiIndustrialPark,WukuDistrict,NewTaipeiCity,Taiwan24803/新北市五股區新北產業園區五工路 134 號

台灣檢驗科技股份有限公司

t (886-2) 2299-3279

f (886-2) 2298-0488

www.tw.sgs.com

Member of SGS Group

1.2 Related Submittal(s) / Grant (s)

This submittal(s) (test report) is intended for **FCC ID: SWX-NBEM5** filing to comply with Section 15.247 of the FCC Part 15, Subpart C Rules. And **IC: 6545A-NBEM5** filing to comply with Industry Canada RSS-210 issue 8: 2010 Annex 8. The composite system (digital device) is compliance with Subpart B under the DoC procedure.

1.3 Test Methodology

Both conducted and radiated testing was performed according to the procedures in ANSI C63.4:2009 and RSS-Gen: 2010. Radiated testing was performed at an antenna to EUT distance 3 meters.

Tested in accordance with Apr 2013 KDB558074 D01 V03 for compliance to FCC 47CFR 15.247 requirements.

1.4 Test Facility

The measurement facilities used to collect the 3m Radiated Emission and AC power line conducted data are located on the address of SGS Taiwan Ltd. Electronics & Communication Laboratory No.134, Wu Kung Road, Wuku Industrial Zone, Taipei County, Taiwan which are constructed and calibrated to meet the FCC requirements in documents ANSI C63.4:2009. FCC Registration Number is: 990257. Canada Registration Number: 4620A-4.

The 10 m Open Area Test Sites located on the address of SGS Taiwan Ltd. Electronics & Communication Laboratory No. 29, Pau-Tou-Tsuo Valley Chia-Pau Tsuen, Linkou Hsiang, Taipei county, which is constructed and calibrated to meet the CISPR 22/EN 55022 requirements. SGS Site No. 1(3 &10 meters) and FCC Registration Number: 94644.

1.5 Special Accessories

There are no special accessories used while test was conducted.

1.6 Equipment Modifications

There was no modification incorporated into the EUT.

Unless otherwise stated the results shown in this test report refer only to the sample(s) tested and such sample(s) are retained for 90 days only.

除非另有說明，此報告結果僅對測試之樣品負責，同時此樣品僅保留90天。本報告未經本公司書面許可，不可部份複製。

This document is issued by the Company subject to its General Conditions of Service printed overleaf, available on request or accessible at www.sgs.com/terms_and_conditions.htm and, for electronic format documents, subject to Terms and Conditions for Electronic Documents at www.sgs.com/terms_e-document.htm. Attention is drawn to the limitation of liability, indemnification and jurisdiction issues defined therein. Any holder of this document is advised that information contained hereon reflects the Company's findings at the time of its intervention only and within the limits of Client's instructions, if any. The Company's sole responsibility is to its Client and this document does not exonerate parties to a transaction from exercising all their rights and obligations under the transaction documents. This document cannot be reproduced except in full, without prior written approval of the Company. Any unauthorized alteration, forgery or falsification of the content or appearance of this document is unlawful and offenders may be prosecuted to the fullest extent of the law.

SGS Taiwan Ltd.

No.134,WuKungRoad,NewTaipeiIndustrialPark,WukuDistrict,NewTaipeiCity,Taiwan24803/新北市五股區新北產業園區五工路 134 號

台灣檢驗科技股份有限公司

t (886-2) 2299-3279

f (886-2) 2298-0488

www.tw.sgs.com

Member of SGS Group

2 SYSTEM TEST CONFIGURATION

2.1 EUT Configuration

The EUT configuration for testing is installed on RF field strength measurement to meet the Commissions requirement and operating in a manner which intends to maximize its emission characteristics in a continuous normal application.

2.2 EUT Exercise

An engineering test mode (software/firmware) that applicant provided was utilized to manipulate the EUT into transmit, selection of the test channel, and modulation scheme.

2.3 Test Procedure

2.3.1 Conducted Emissions

The EUT is a placed on as turn table which is 0.8 m above ground plane. According to the general criterion in Section 7.1 of ANSI C63.4:2009. Conducted emissions from the EUT measured in the frequency range between 0.15 MHz and 30MHz, and the measurement procedure 7.3 in ANSI 63.4:2009 is followed to carry out the test. The CISPR Quasi-Peak and Average detector mode is employed according to §15.107

2.3.2 Radiated Emissions

The EUT is a placed on as turn table which is 0.8 m above ground plane. The turn table shall rotate 360 degrees to determine the position of maximum emission level. EUT is set 3m away from the receiving antenna which varied from 1m to 4m to find out the highest emission. And also, each emission was to be maximized by changing the polarization of receiving antenna both horizontal and vertical. In order to find out the max. emission, the relative positions of this hand-held transmitter (EUT) was rotated through three orthogonal axes and measurement procedures for electric field radiated emissions above 1 GHz the EUT measurement is to be made “while keeping the antenna in the ‘cone of radiation’ from that area and pointed at the area both in azimuth and elevation, with polarization oriented for maximum response.” is still within the 3dB illumination BW of the measurement antenna. according to the requirements in Section 8 and 13 and of ANSI C63.4:2009,

Unless otherwise stated the results shown in this test report refer only to the sample(s) tested and such sample(s) are retained for 90 days only.

除非另有說明，此報告結果僅對測試之樣品負責，同時此樣品僅保留90天。本報告未經本公司書面許可，不可部份複製。

This document is issued by the Company subject to its General Conditions of Service printed overleaf, available on request or accessible at www.sgs.com/terms_and_conditions.htm and, for electronic format documents, subject to Terms and Conditions for Electronic Documents at www.sgs.com/terms_e-document.htm. Attention is drawn to the limitation of liability, indemnification and jurisdiction issues defined therein. Any holder of this document is advised that information contained hereon reflects the Company's findings at the time of its intervention only and within the limits of Client's instructions, if any. The Company's sole responsibility is to its Client and this document does not exonerate parties to a transaction from exercising all their rights and obligations under the transaction documents. This document cannot be reproduced except in full, without prior written approval of the Company. Any unauthorized alteration, forgery or falsification of the content or appearance of this document is unlawful and offenders may be prosecuted to the fullest extent of the law.

SGS Taiwan Ltd.

No.134,WuKungRoad,NewTaipeiIndustrialPark,WukuDistrict,NewTaipeiCity,Taiwan24803/新北市五股區新北產業園區五工路 134 號

台灣檢驗科技股份有限公司

t (886-2) 2299-3279

f (886-2) 2298-0488

www.tw.sgs.com

Member of SGS Group

2.4 Configuration of Tested System

Fig. 2-1 Radiated Emission & Conducted (Antenna Port) Configuration

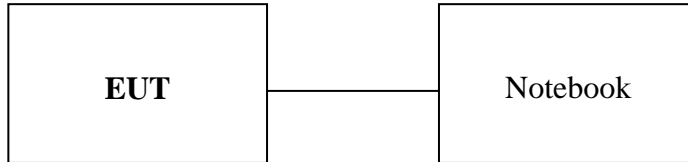

Fig. 2-2 AC Power Line Conducted Emission

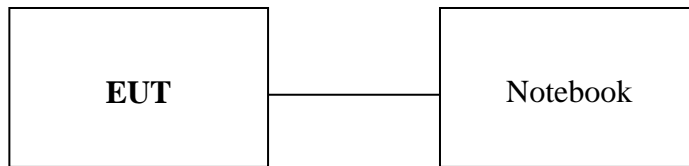

Table 2-1 Equipment Used in Tested System

| Item | Equipment | Mfr/Brand | Model/Type No. | Series No. | Data Cable | Power Cord |
|------|--------------------|-----------|----------------|------------|------------|--------------|
| 1. | WLAN Test Software | N/A | N/A | N/A | N/A | N/A |
| 2. | Notebook | Lenovo | L430 | LR-7HXZA | shielding | Un-shielding |

Unless otherwise stated the results shown in this test report refer only to the sample(s) tested and such sample(s) are retained for 90 days only.

除非另有說明，此報告結果僅對測試之樣品負責，同時此樣品僅保留90天。本報告未經本公司書面許可，不可部份複製。

This document is issued by the Company subject to its General Conditions of Service printed overleaf, available on request or accessible at www.sgs.com/terms_and_conditions.htm and, for electronic format documents, subject to Terms and Conditions for Electronic Documents at www.sgs.com/terms_e-document.htm. Attention is drawn to the limitation of liability, indemnification and jurisdiction issues defined therein. Any holder of this document is advised that information contained hereon reflects the Company's findings at the time of its intervention only and within the limits of Client's instructions, if any. The Company's sole responsibility is to its Client and this document does not exonerate parties to a transaction from exercising all their rights and obligations under the transaction documents. This document cannot be reproduced except in full, without prior written approval of the Company. Any unauthorized alteration, forgery or falsification of the content or appearance of this document is unlawful and offenders may be prosecuted to the fullest extent of the law.

SGS Taiwan Ltd.

No. 134, WuKungRoad, NewTaipeiIndustrialPark, WukuDistrict, NewTaipeiCity, Taiwan24803/新北市五股區新北產業園區五工路 134 號

台灣檢驗科技股份有限公司

t (886-2) 2299-3279

f (886-2) 2298-0488

www.tw.sgs.com

Member of SGS Group

3 SUMMARY OF TEST RESULTS

| FCC / IC Rules | Description Of Test | Result |
|------------------------------------|--|-----------|
| §15.207(a) RSS-Gen §7.2.4 | AC Power Line Conducted Emission | Compliant |
| §15.247(b) (3) RSS-210 §A8.4(4) | Peak Output Power | Compliant |
| §15.247(a)(2) RSS-210 §A8.2 (a) | 6dB Bandwidth | Compliant |
| §15.247(d) RSS-210 §A8.5 | 100 KHz Bandwidth Of Frequency Band Edges | Compliant |
| §15.247(d) RSS-210 §A8.5 | Spurious Emission | Compliant |
| §15.247(e) RSS-210 §A8.2(b) | Peak Power Density | Compliant |
| §15.203 RSS-GEN §7.1.2, | Antenna Requirement | Compliant |
| RSS-Gen §4.6.1 | 99% Power Bandwidth | Compliant |

Unless otherwise stated the results shown in this test report refer only to the sample(s) tested and such sample(s) are retained for 90 days only.

除非另有說明，此報告結果僅對測試之樣品負責，同時此樣品僅保留90天。本報告未經本公司書面許可，不可部份複製。

This document is issued by the Company subject to its General Conditions of Service printed overleaf, available on request or accessible at www.sgs.com/terms_and_conditions.htm and, for electronic format documents, subject to Terms and Conditions for Electronic Documents at www.sgs.com/terms_e-document.htm. Attention is drawn to the limitation of liability, indemnification and jurisdiction issues defined therein. Any holder of this document is advised that information contained hereon reflects the Company's findings at the time of its intervention only and within the limits of Client's instructions, if any. The Company's sole responsibility is to its Client and this document does not exonerate parties to a transaction from exercising all their rights and obligations under the transaction documents. This document cannot be reproduced except in full, without prior written approval of the Company. Any unauthorized alteration, forgery or falsification of the content or appearance of this document is unlawful and offenders may be prosecuted to the fullest extent of the law.

SGS Taiwan Ltd.

No.134,WuKungRoad,NewTaipeiIndustrialPark,WukuDistrict,NewTaipeiCity,Taiwan24803/新北市五股區新北產業園區五工路 134 號

台灣檢驗科技股份有限公司

t (886-2) 2299-3279

f (886-2) 2298-0488

www.tw.sgs.com

Member of SGS Group

4 DESCRIPTION OF TEST MODES

The EUT has been tested under operating condition.

Test program used to control the EUT for staying in continuous transmitting and receiving mode is programmed.

802.11 a mode: Channel low (5745MHz) 、mid (5785MHz) and high (5825MHz) with 6Mbps lowest data rate are chosen for full testing.

802.11 n (5GHz) _20MHz: Lowest (5745MHz), Mid (5785MHz) and high (5825MHz) with 6.5 Mbps lowest data rate are chosen for full testing.

802.11 n (5GHz) _40MHz: Lowest (5755MHz) and high (5795MHz) with 13.5 Mbps lowest data rate are chosen for full testing.

The worst case is determined by the output power that generates the highest emission. As examined in the section of output power measurement, the section 7.5, the lowest data rate at a/n_HT20/n_HT40 resulted the highest level of fundamental emission, and therefore, the lowest data rate is chosen as the worst-case to conduct the remaining of other mandatory test cases.

The field strength of radiation emission was measured as EUT stand-up position (H mode) and lie down position (E1, E2 mode) for 802.11a/n WLAN Transmitter for channel Low, Mid and High, the worst case E1 position was tested as resulted in pre-scanned measurement with respect to 5.8GHz 802.11a/n_HT20/n_HT40.

5 MEASUREMENT UNCERTAINTY

| Test Items | Uncertainty |
|---|--|
| AC Power Line Conducted Emission | +/- 2.586 dB |
| Peak Output Power | +/- 1.55dB (for Spectrum) +/- 1.42 dB (for Power Meter) |
| 6dB Bandwidth | +/- 123.36 Hz |
| 100 KHz Bandwidth Of Frequency Band Edges | +/- 1.55 dB |
| Peak Power Density | +/- 1.55 dB |
| 99% Power Bandwidth | +/- 123.36 Hz |
| Temperature | +/- 0.8 °C |
| Humidity | +/- 4.7 % |
| DC / AC Power Source | DC= +/- 1%, AC= +/- 0.2% |

Radiated Spurious Emission:

| | |
|--|----------------------------|
| Measurement uncertainty (Polarization : Vertical) | 30MHz - 180MHz: +/- 3.37dB |
| | 180MHz -417MHz: +/- 3.19dB |
| | 0.417GHz-1GHz: +/- 3.19dB |
| | 1GHz - 18GHz: +/- 4.04dB |
| | 18GHz - 40GHz: +/- 4.04dB |

| | |
|--|----------------------------|
| Measurement uncertainty (Polarization : Horizontal) | 30MHz - 167MHz: +/- 4.22dB |
| | 167MHz -500MHz: +/- 3.44dB |
| | 0.5GHz-1GHz: +/- 3.39dB |
| | 1GHz - 18GHz: +/- 4.08dB |
| | 18GHz - 40GHz: +/- 4.08dB |

This uncertainty represents an expanded uncertainty expressed at approximately the 95% confidence level using a coverage factor of k=2.

Unless otherwise stated the results shown in this test report refer only to the sample(s) tested and such sample(s) are retained for 90 days only.

除非另有說明，此報告結果僅對測試之樣品負責，同時此樣品僅保留90天。本報告未經本公司書面許可，不可部份複製。

This document is issued by the Company subject to its General Conditions of Service printed overleaf, available on request or accessible at www.sgs.com/terms_and_conditions.htm and, for electronic format documents, subject to Terms and Conditions for Electronic Documents at www.sgs.com/terms_e-document.htm. Attention is drawn to the limitation of liability, indemnification and jurisdiction issues defined therein. Any holder of this document is advised that information contained hereon reflects the Company's findings at the time of its intervention only and within the limits of Client's instructions, if any. The Company's sole responsibility is to its Client and this document does not exonerate parties to a transaction from exercising all their rights and obligations under the transaction documents. This document cannot be reproduced except in full, without prior written approval of the Company. Any unauthorized alteration, forgery or falsification of the content or appearance of this document is unlawful and offenders may be prosecuted to the fullest extent of the law.

6 CONDUCTED EMISSION TEST

6.1 Standard Applicable:

According to §15.207 and RSS-Gen §7.2.4, frequency range within 150KHz to 30MHz shall not exceed the Limit table as below.

| Frequency range MHz | Limits dB(uV) | |
|------------------------|------------------|----------|
| | Quasi-peak | Average |
| 0.15 to 0.50 | 66 to 56 | 56 to 46 |
| 0.50 to 5 | 56 | 46 |
| 5 to 30 | 60 | 50 |

Note

- 1.The lower limit shall apply at the transition frequencies
- 2.The limit decreases linearly with the logarithm of the frequency in the range 0.15 MHz to 0.50 MHz.

6.2 Measurement Equipment Used:

| Conducted Emission Test Site | | | | | |
|------------------------------|-----------------|-----------------------|---------------|------------|------------|
| EQUIPMENT TYPE | MFR | MODEL NUMBER | SERIAL NUMBER | LAST CAL. | CAL DUE. |
| EMI Test Receiver | R&S | ESCI 7 | 100924 | 05/10/2013 | 05/09/2014 |
| Coaxial Cables | N/A | N30N30-1042 -150cm | N/A | 02/07/2013 | 02/06/2014 |
| LISN | SCHWARZB ECK | NSLK 8127 | 8127-648 | 06/17/2012 | 06/16/2014 |
| Pulse Limit | narda | PL01 | 1110X30602 | 08/14/2013 | 08/13/2014 |
| Test Software | Farad | EZ-EMC | Ver. SGS-03A1 | N.C.R. | N.C.R. |

6.3 EUT Setup:

1. The conducted emission tests were performed in the test site, using the setup in accordance with the ANSI C63.4:2009.
2. The AC/DC Power adaptor of EUT was plug-in LISN. The EUT was placed flushed with the rear of the table.
3. The LISN was connected with 120Vac/60Hz power source.

Unless otherwise stated the results shown in this test report refer only to the sample(s) tested and such sample(s) are retained for 90 days only.

除非另有說明，此報告結果僅對測試之樣品負責，同時此樣品僅保留90天。本報告未經本公司書面許可，不可部份複製。

This document is issued by the Company subject to its General Conditions of Service printed overleaf, available on request or accessible at www.sgs.com/terms_and_conditions.htm and, for electronic format documents, subject to Terms and Conditions for Electronic Documents at www.sgs.com/terms_e-document.htm. Attention is drawn to the limitation of liability, indemnification and jurisdiction issues defined therein. Any holder of this document is advised that information contained hereon reflects the Company's findings at the time of its intervention only and within the limits of Client's instructions, if any. The Company's sole responsibility is to its Client and this document does not exonerate parties to a transaction from exercising all their rights and obligations under the transaction documents. This document cannot be reproduced except in full, without prior written approval of the Company. Any unauthorized alteration, forgery or falsification of the content or appearance of this document is unlawful and offenders may be prosecuted to the fullest extent of the law.

6.4 Test SET-UP (Block Diagram of Configuration)

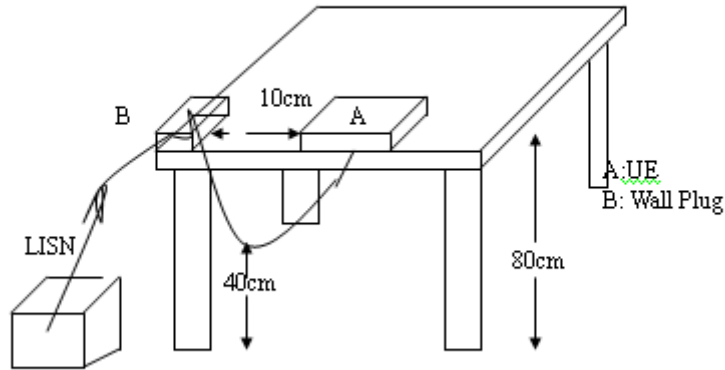

6.5 Measurement Procedure:

1. The EUT was placed on a table which is 0.8m above ground plane.
2. Maximum procedure was performed on the six highest emissions to ensure EUT compliance.
3. Repeat above procedures until all phases of power being supplied by given UE are completed

6.6 Measurement Result:

Note: Refer to next page for measurement data and plots.

Note2: The * reveals the worst-case results that closet to the limit

Unless otherwise stated the results shown in this test report refer only to the sample(s) tested and such sample(s) are retained for 90 days only.

除非另有說明，此報告結果僅對測試之樣品負責，同時此樣品僅保留90天。本報告未經本公司書面許可，不可部份複製。

This document is issued by the Company subject to its General Conditions of Service printed overleaf, available on request or accessible at www.sgs.com/terms_and_conditions.htm and, for electronic format documents, subject to Terms and Conditions for Electronic Documents at www.sgs.com/terms_e-document.htm. Attention is drawn to the limitation of liability, indemnification and jurisdiction issues defined therein. Any holder of this document is advised that information contained hereon reflects the Company's findings at the time of its intervention only and within the limits of Client's instructions, if any. The Company's sole responsibility is to its Client and this document does not exonerate parties to a transaction from exercising all their rights and obligations under the transaction documents. This document cannot be reproduced except in full, without prior written approval of the Company. Any unauthorized alteration, forgery or falsification of the content or appearance of this document is unlawful and offenders may be prosecuted to the fullest extent of the law.

SGS Taiwan Ltd.

No.134,WuKungRoad,NewTaipeiIndustrialPark,WukuDistrict,NewTaipeiCity,Taiwan24803/新北市五股區新北產業園區五工路 134 號

台灣檢驗科技股份有限公司

t (886-2) 2299-3279

f (886-2) 2298-0488

www.tw.sgs.com

Member of SGS Group

AC POWER LINE CONDUCTED EMISSION TEST DATA

| | | | | | |
|-----------------|----------------|-----------|------------|---------------|------|
| Operation Mode: | Operation mode | | Test Date: | Nov. 15, 2013 | |
| Temperature: | 26 °C | Humidity: | 60 % | Test By: | Vito |
| | | | | Probe: | L1/N |

80.0 dBuV

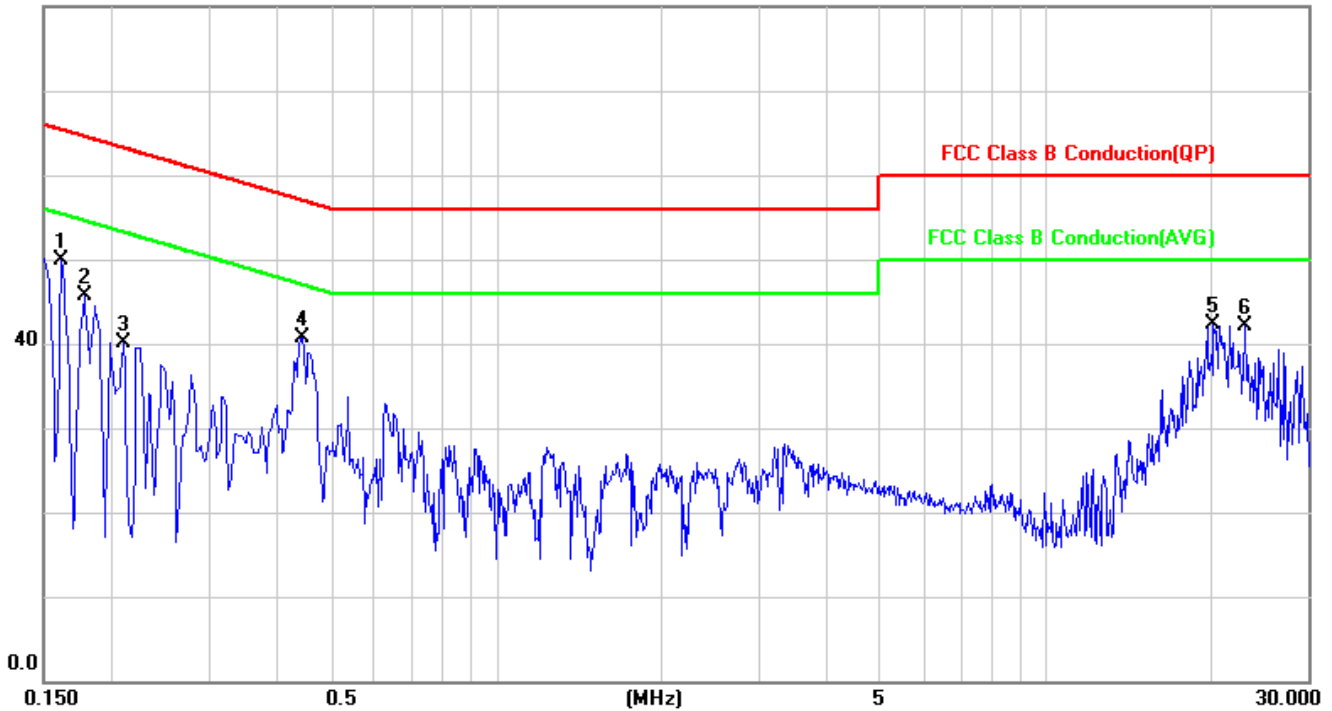

| No. | Alt. | Freq. (MHz) | Reading (dBuV) | Factor (dB) | Measurement (dBuV) | Limit (dBuV) | Over (dB) | Detector | Comment |
|-----|------|----------------|-------------------|----------------|-----------------------|-----------------|--------------|----------|---------|
| 1 | * | 0.1620 | 49.35 | 0.52 | 49.87 | 65.36 | -15.49 | peak | |
| 2 | | 0.1780 | 45.17 | 0.52 | 45.69 | 64.58 | -18.89 | peak | |
| 3 | | 0.2100 | 39.54 | 0.51 | 40.05 | 63.21 | -23.16 | peak | |
| 4 | | 0.4420 | 40.08 | 0.53 | 40.61 | 57.02 | -16.41 | peak | |
| 5 | | 20.2580 | 40.69 | 1.54 | 42.23 | 60.00 | -17.77 | peak | |
| 6 | | 23.1260 | 40.27 | 1.78 | 42.05 | 60.00 | -17.95 | peak | |

Unless otherwise stated the results shown in this test report refer only to the sample(s) tested and such sample(s) are retained for 90 days only.

除非另有說明，此報告結果僅對測試之樣品負責，同時此樣品僅保留90天。本報告未經本公司書面許可，不可部份複製。

This document is issued by the Company subject to its General Conditions of Service printed overleaf, available on request or accessible at www.sgs.com/terms_and_conditions.htm and, for electronic format documents, subject to Terms and Conditions for Electronic Documents at www.sgs.com/terms_e-document.htm. Attention is drawn to the limitation of liability, indemnification and jurisdiction issues defined therein. Any holder of this document is advised that information contained hereon reflects the Company's findings at the time of its intervention only and within the limits of Client's instructions, if any. The Company's sole responsibility is to its Client and this document does not exonerate parties to a transaction from exercising all their rights and obligations under the transaction documents. This document cannot be reproduced except in full, without prior written approval of the Company. Any unauthorized alteration, forgery or falsification of the content or appearance of this document is unlawful and offenders may be prosecuted to the fullest extent of the law.

SGS Taiwan Ltd.

No. 134, WuKungRoad, NewTaipeiIndustrialPark, WukuDistrict, NewTaipeiCity, Taiwan24803/新北市五股區新北產業園區五工路 134 號

台灣檢驗科技股份有限公司

t (886-2) 2299-3279

f (886-2) 2298-0488

www.tw.sgs.com

Member of SGS Group

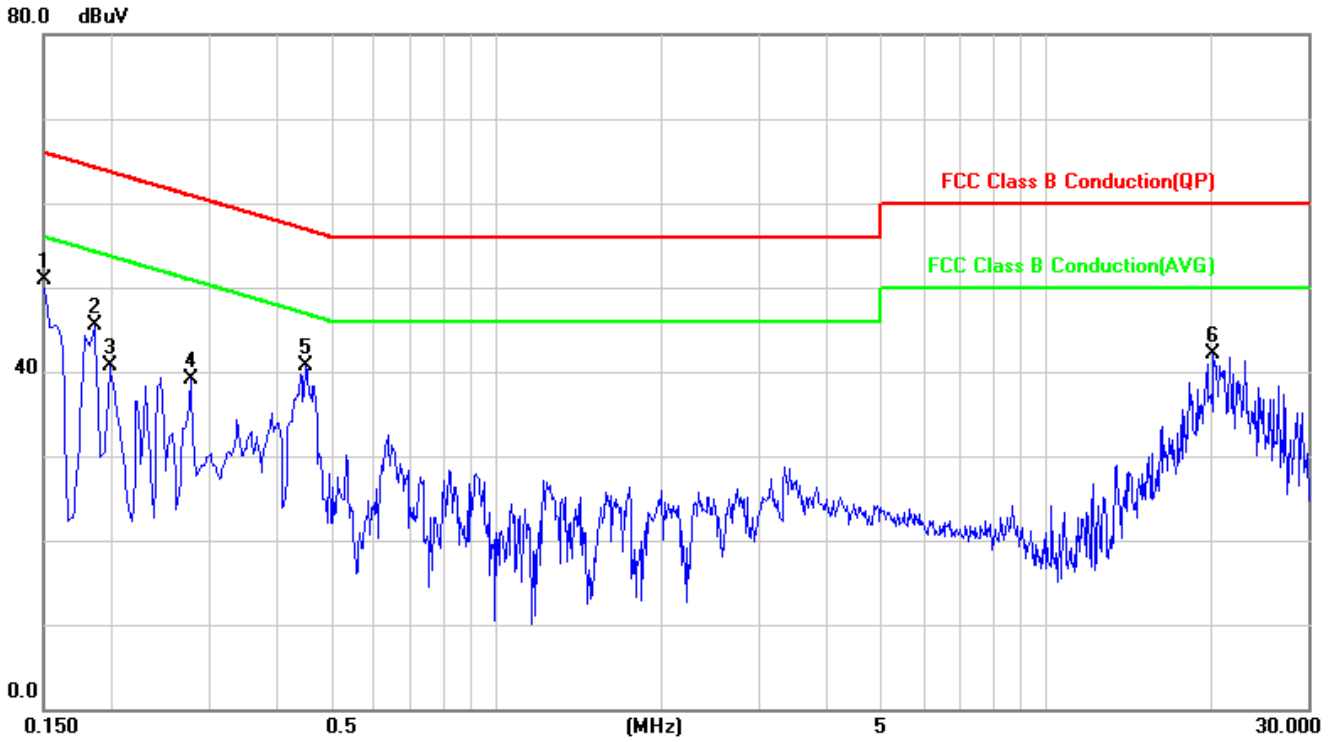

| No. | MHz | Freq. (MHz) | Reading (dBuV) | Factor (dB) | Measurement (dBuV) | Limit (dBuV) | Over (dB) | Detector | Comment |
|-----|-----|-------------|----------------|-------------|--------------------|--------------|-----------|----------|---------|
| 1 | * | 0.1500 | 50.81 | 0.16 | 50.97 | 66.00 | -15.03 | QP | |
| 2 | | 0.1860 | 45.41 | 0.16 | 45.57 | 64.21 | -18.64 | QP | |
| 3 | | 0.1980 | 40.56 | 0.16 | 40.72 | 63.69 | -22.97 | QP | |
| 4 | | 0.2780 | 38.97 | 0.16 | 39.13 | 60.88 | -21.75 | QP | |
| 5 | | 0.4500 | 40.54 | 0.18 | 40.72 | 56.88 | -16.16 | QP | |
| 6 | | 20.2580 | 41.15 | 0.93 | 42.08 | 60.00 | -17.92 | QP | |

Unless otherwise stated the results shown in this test report refer only to the sample(s) tested and such sample(s) are retained for 90 days only.
除非另有說明，此報告結果僅對測試之樣品負責，同時此樣品僅保留90天。本報告未經本公司書面許可，不可部份複製。

This document is issued by the Company subject to its General Conditions of Service printed overleaf, available on request or accessible at www.sgs.com/terms_and_conditions.htm and, for electronic format documents, subject to Terms and Conditions for Electronic Documents at www.sgs.com/terms_e-document.htm. Attention is drawn to the limitation of liability, indemnification and jurisdiction issues defined therein. Any holder of this document is advised that information contained hereon reflects the Company's findings at the time of its intervention only and within the limits of Client's instructions, if any. The Company's sole responsibility is to its Client and this document does not exonerate parties to a transaction from exercising all their rights and obligations under the transaction documents. This document cannot be reproduced except in full, without prior written approval of the Company. Any unauthorized alteration, forgery or falsification of the content or appearance of this document is unlawful and offenders may be prosecuted to the fullest extent of the law.

7 PEAK OUTPUT POWER MEASUREMENT

7.1 Standard Applicable:

According to §15.247 (b)

(3) For systems using digital modulation in the 902-928 MHz, 2400-2483.5 MHz, and 5725-5850 MHz bands: 1 Watt. As an alternative to a peak power measurement, compliance with the one Watt limit can be based on a measurement of the maximum conducted output power. Maximum Conducted Output Power is defined as the total transmit power delivered to all antennas and antenna elements averaged across all symbols in the signaling alphabet when the transmitter is operating at its maximum power control level. Power must be summed across all antennas and antenna elements. The average must not include any time intervals during which the transmitter is off or is transmitting at a reduced power level. If multiple modes of operation are possible (e.g., alternative modulation methods), the maximum conducted output power is the highest total transmit power occurring in any mode.

(4) The conducted output power limit specified in paragraph (b) of this section is based on the use of antennas with directional gains that do not exceed 6 dBi. Except as shown in paragraph (c) of this section, if transmitting antennas of directional gain greater than 6 dBi are used, the conducted output power from the intentional radiator shall be reduced below the stated values in paragraphs (b)(1), (b)(2), and (b)(3) of this section, as appropriate, by the amount in dB that the directional gain of the antenna exceeds 6 dBi.

According to RSS-210 issue 8, §A8.4(4), for systems employing digital modulation techniques operating in the bands 902-928 MHz, 2400-2483.5 MHz and 5725-5850 MHz, the maximum peak conducted output power shall not exceed 1 W. Except as provided in Section A8.4 (5), the e.i.r.p. shall not exceed 4 W.

As an alternative to a peak power measurement, compliance can be based on a measurement of the maximum conducted output power. The maximum conducted output power is the total transmitted power delivered to all antennas and antenna elements, averaged across all symbols in the signaling alphabet when the transmitter is operating at its maximum power control level. Power must be summed across all antennas and antenna elements. The average must not include any time intervals during which the transmitter is off or transmitting at a reduced power level. If multiple modes of operation are implemented, the maximum conducted output power is the highest total transmit power occurring in any mode.

Unless otherwise stated the results shown in this test report refer only to the sample(s) tested and such sample(s) are retained for 90 days only.

除非另有說明，此報告結果僅對測試之樣品負責，同時此樣品僅保留90天。本報告未經本公司書面許可，不可部份複製。

This document is issued by the Company subject to its General Conditions of Service printed overleaf, available on request or accessible at www.sgs.com/terms_and_conditions.htm and, for electronic format documents, subject to Terms and Conditions for Electronic Documents at www.sgs.com/terms_e-document.htm. Attention is drawn to the limitation of liability, indemnification and jurisdiction issues defined therein. Any holder of this document is advised that information contained hereon reflects the Company's findings at the time of its intervention only and within the limits of Client's instructions, if any. The Company's sole responsibility is to its Client and this document does not exonerate parties to a transaction from exercising all their rights and obligations under the transaction documents. This document cannot be reproduced except in full, without prior written approval of the Company. Any unauthorized alteration, forgery or falsification of the content or appearance of this document is unlawful and offenders may be prosecuted to the fullest extent of the law.

SGS Taiwan Ltd.

台灣檢驗科技股份有限公司

No.134,WuKungRoad,NewTaipeiIndustrialPark,WukuDistrict,NewTaipeiCity,Taiwan24803/新北市五股區新北產業園區五工路 134 號

t (886-2) 2299-3279

f (886-2) 2298-0488

www.tw.sgs.com

Member of SGS Group

Note: The antenna gain is greater than 6 dBi in 5GHz MIMO mode so the limit reduce as below:

5725-5850 MHz

Antenna Gain: 9.96dBi – 6dBi = 3.96

$$1+(3.96/6) = 1.66$$

Limit: 30dB – 1.66 dB = 28.34 dB = 0.68W

7.2 Measurement Equipment Used:

| SGS Conducted Room | | | | | |
|---------------------|---------------|--------------|----------------|------------------|-----------------|
| Name of Equipment | Manufacturer | Model | Serial Number | Calibration Date | Calibration Due |
| Spectrum Analyzer | Agilent | N9010A | MY51440121 | 02/13/2012 | 02/12/2014 |
| Power Meter | Anritsu | ML2495A | 1005007 | 02/08/2012 | 02/07/2014 |
| Power Sensor | Anritsu | MA2411B | 917032 | 02/08/2012 | 02/07/2014 |
| DC Power Supply | HOLA | DP-3003 | 001 | N.C.R. | N.C.R. |
| Coaxial Cable | WOKEN | conducted #2 | 001 | 12/21/2012 | 12/20/2013 |
| DC Block | Mini-Circuits | BLK-18-S+ | 002 | 12/21/2012 | 12/20/2013 |
| Splitter | RF-LAMBAD | RFLT2W1G18G | 11-JSPF412-018 | 12/21/2012 | 12/20/2013 |
| Attenuator | Mini-Circuits | BW-S10W2+ | 002 | 12/21/2012 | 12/20/2013 |
| Temperature Chamber | TERCHY | MHK-120LK | 1020582 | 06/20/2013 | 06/19/2014 |

7.3 Test Set-up:

Spectrum:

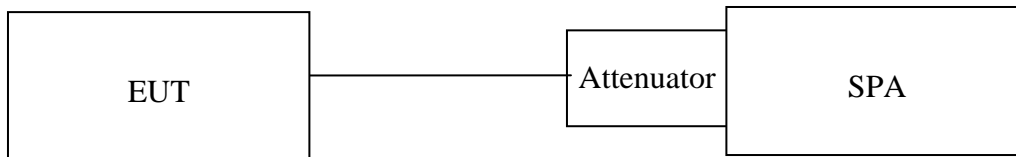

Power Meter:

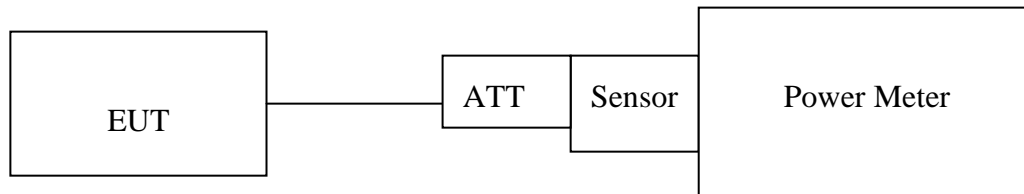

Unless otherwise stated the results shown in this test report refer only to the sample(s) tested and such sample(s) are retained for 90 days only.

除非另有說明，此報告結果僅對測試之樣品負責，同時此樣品僅保留90天。本報告未經本公司書面許可，不可部份複製。

This document is issued by the Company subject to its General Conditions of Service printed overleaf, available on request or accessible at www.sgs.com/terms_and_conditions.htm and, for electronic format documents, subject to Terms and Conditions for Electronic Documents at www.sgs.com/terms_e-document.htm. Attention is drawn to the limitation of liability, indemnification and jurisdiction issues defined therein. Any holder of this document is advised that information contained hereon reflects the Company's findings at the time of its intervention only and within the limits of Client's instructions, if any. The Company's sole responsibility is to its Client and this document does not exonerate parties to a transaction from exercising all their rights and obligations under the transaction documents. This document cannot be reproduced except in full, without prior written approval of the Company. Any unauthorized alteration, forgery or falsification of the content or appearance of this document is unlawful and offenders may be prosecuted to the fullest extent of the law.

7.4 Measurement Procedure:

1. Place the EUT on the table and set it in transmitting mode.
2. Remove the antenna from the EUT and then connect a low loss RF cable from the antenna port to the power meter or spectrum. (**Peak power setting on Spectrum:** Channel power function, RBW = 1MHz, VBW = 3MHz, Span: 30/60MHz, Detector =peak, Sweep = Auto. Setting on spectrum is adjusted based on the mandatory procedure in 9.1.2 of the KDB558074). Power Meter is used as the auxiliary test equipment to conduct the output power measurement. 9.1.3 in KDB558074 is followed.
(**Avg. power setting on Spectrum:** Channel power function, RBW = 1MHz, VBW = 3MHz, Span: 30/60MHz, Detector =Avg., Trace avg =100, Sweep = Auto, Setting on spectrum is adjusted based on the mandatory procedure in 9.2.2.4 of the KDB558074). Power Meter is used as the auxiliary test equipment to conduct the output power measurement. 9.2.3, option 3 in KDB558074 is followed.
3. Record the max. Reading as observed from Spectrum or Power Meter.
4. Repeat above procedures until all frequency of interest measured was complete.
5. For MIMO operation, measurement is done per chain basis, and then sum the simultaneous transmitting output in linear.

Pre-analysis Check: While conducting average power measurement, duty cycle of each mode (a/n_ht20) shall be checked to ensure its duty cycle in order to compensate for the loss due to insufficient ratio of duty cycle. All duty cycle is pre-scanned, resulted as obtained below, and showed only the most representative ones

Tabular results as indicates below entails the results of duty factor for all supported modes.

Formula:

$$\text{Duty Cycle} = \text{Ton} / (\text{Ton} + \text{Toff})$$

Unless otherwise stated the results shown in this test report refer only to the sample(s) tested and such sample(s) are retained for 90 days only.

除非另有說明，此報告結果僅對測試之樣品負責，同時此樣品僅保留90天。本報告未經本公司書面許可，不可部份複製。

This document is issued by the Company subject to its General Conditions of Service printed overleaf, available on request or accessible at www.sgs.com/terms_and_conditions.htm and, for electronic format documents, subject to Terms and Conditions for Electronic Documents at www.sgs.com/terms_e-document.htm. Attention is drawn to the limitation of liability, indemnification and jurisdiction issues defined therein. Any holder of this document is advised that information contained hereon reflects the Company's findings at the time of its intervention only and within the limits of Client's instructions, if any. The Company's sole responsibility is to its Client and this document does not exonerate parties to a transaction from exercising all their rights and obligations under the transaction documents. This document cannot be reproduced except in full, without prior written approval of the Company. Any unauthorized alteration, forgery or falsification of the content or appearance of this document is unlawful and offenders may be prosecuted to the fullest extent of the law.

Test Procedure:

Set span = 0, RBW = 1MHz, VBW = 3MHz, Detector = Peak

Duty Cycle:

| | Duty Cycle | Duty Factor (dB) |
|-----------------------|------------|------------------|
| 802.11a-Single Aux | 0.961 | 0.1734 |
| 802.11n_20 (5G)-MIMO | 0.915 | 0.3834 |
| 802.11n_40 (5G) -MIMO | 0.916 | 0.3789 |

Unless otherwise stated the results shown in this test report refer only to the sample(s) tested and such sample(s) are retained for 90 days only.

除非另有說明，此報告結果僅對測試之樣品負責，同時此樣品僅保留90天。本報告未經本公司書面許可，不可部份複製。

This document is issued by the Company subject to its General Conditions of Service printed overleaf, available on request or accessible at www.sgs.com/terms_and_conditions.htm and, for electronic format documents, subject to Terms and Conditions for Electronic Documents at www.sgs.com/terms_e-document.htm. Attention is drawn to the limitation of liability, indemnification and jurisdiction issues defined therein. Any holder of this document is advised that information contained hereon reflects the Company's findings at the time of its intervention only and within the limits of Client's instructions, if any. The Company's sole responsibility is to its Client and this document does not exonerate parties to a transaction from exercising all their rights and obligations under the transaction documents. This document cannot be reproduced except in full, without prior written approval of the Company. Any unauthorized alteration, forgery or falsification of the content or appearance of this document is unlawful and offenders may be prosecuted to the fullest extent of the law.

SGS Taiwan Ltd.

No.134,WuKungRoad,NewTaipeiIndustrialPark,WukuDistrict,NewTaipeiCity,Taiwan24803/新北市五股區新北產業園區五工路 134 號

台灣檢驗科技股份有限公司

t (886-2) 2299-3279

f (886-2) 2298-0488

www.tw.sgs.com

Member of SGS Group

Duty Factor:
802.11a

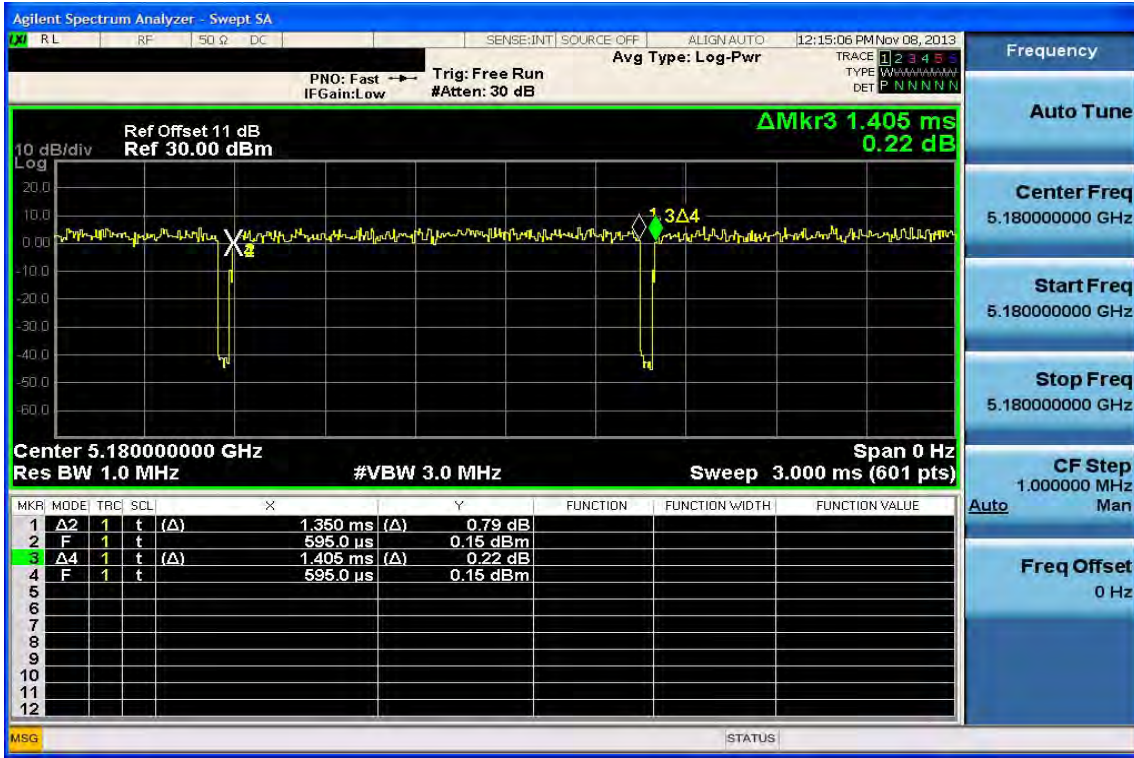

802.11 n (5GHz)_20M

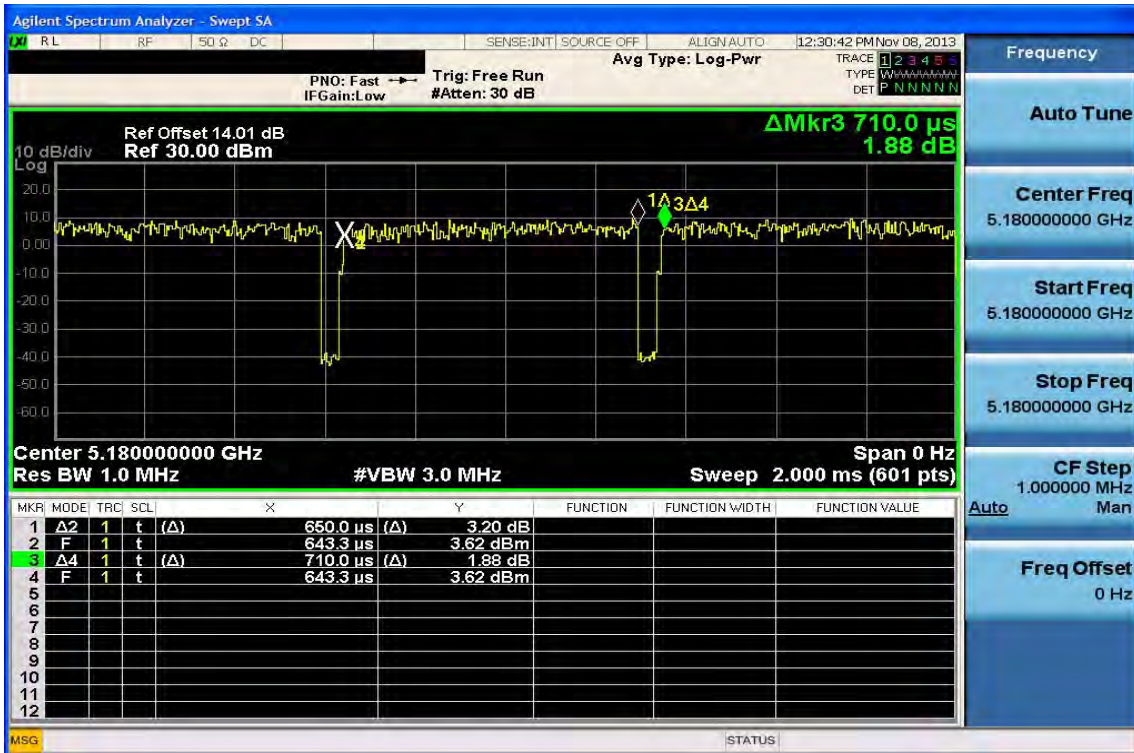

Unless otherwise stated the results shown in this test report refer only to the sample(s) tested and such sample(s) are retained for 90 days only.

除非另有說明，此報告結果僅對測試之樣品負責，同時此樣品僅保留90天。本報告未經本公司書面許可，不可部份複製。

This document is issued by the Company subject to its General Conditions of Service printed overleaf, available on request or accessible at www.sgs.com/terms_and_conditions.htm and, for electronic format documents, subject to Terms and Conditions for Electronic Documents at www.sgs.com/terms_e-document.htm. Attention is drawn to the limitation of liability, indemnification and jurisdiction issues defined therein. Any holder of this document is advised that information contained hereon reflects the Company's findings at the time of its intervention only and within the limits of Client's instructions, if any. The Company's sole responsibility is to its Client and this document does not exonerate parties to a transaction from exercising all their rights and obligations under the transaction documents. This document cannot be reproduced except in full, without prior written approval of the Company. Any unauthorized alteration, forgery or falsification of the content or appearance of this document is unlawful and offenders may be prosecuted to the fullest extent of the law.

SGS Taiwan Ltd.

No. 134, WuKungRoad, NewTaipeiIndustrialPark, WukuDistrict, NewTaipeiCity, Taiwan24803/新北市五股區新北產業園區五工路 134 號

台灣檢驗科技股份有限公司

t (886-2) 2299-3279

f (886-2) 2298-0488

www.tw.sgs.com

Member of SGS Group

802.11 n (5GHz)_40M

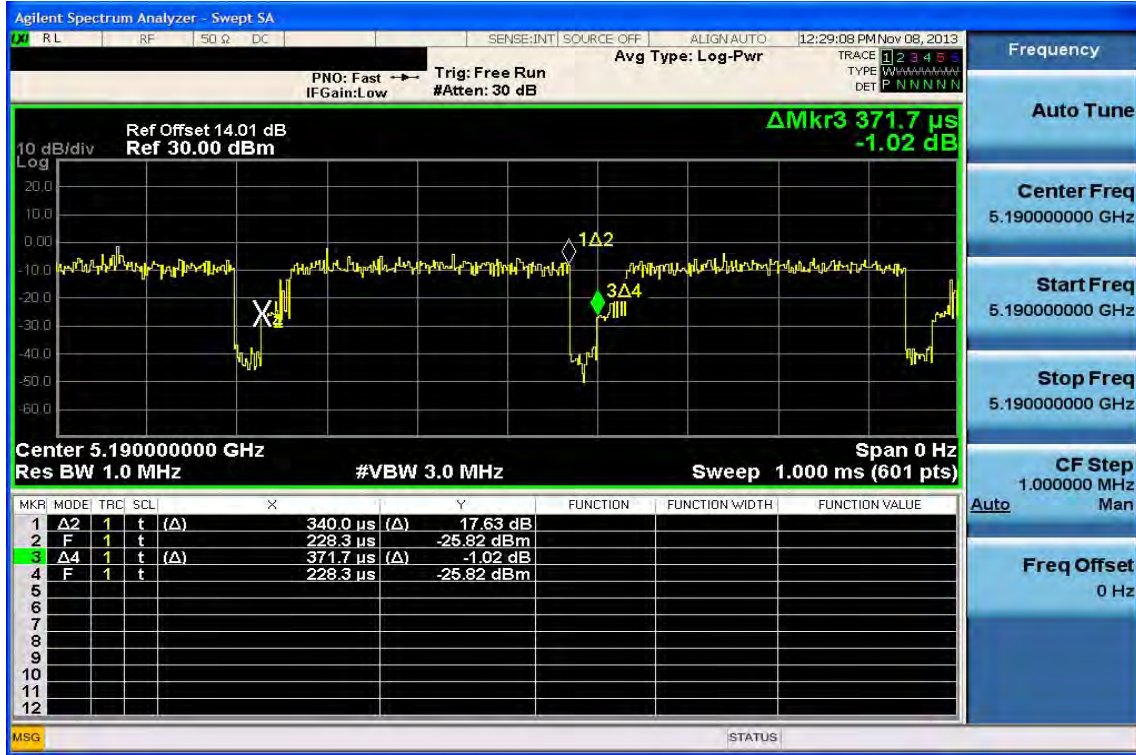

Unless otherwise stated the results shown in this test report refer only to the sample(s) tested and such sample(s) are retained for 90 days only.

除非另有說明，此報告結果僅對測試之樣品負責，同時此樣品僅保留90天。本報告未經本公司書面許可，不可部份複製。

This document is issued by the Company subject to its General Conditions of Service printed overleaf, available on request or accessible at www.sgs.com/terms_and_conditions.htm and, for electronic format documents, subject to Terms and Conditions for Electronic Documents at www.sgs.com/terms_e-document.htm. Attention is drawn to the limitation of liability, indemnification and jurisdiction issues defined therein. Any holder of this document is advised that information contained hereon reflects the Company's findings at the time of its intervention only and within the limits of Client's instructions, if any. The Company's sole responsibility is to its Client and this document does not exonerate parties to a transaction from exercising all their rights and obligations under the transaction documents. This document cannot be reproduced except in full, without prior written approval of the Company. Any unauthorized alteration, forgery or falsification of the content or appearance of this document is unlawful and offenders may be prosecuted to the fullest extent of the law.

SGS Taiwan Ltd.

No. 134, WuKungRoad, NewTaipeiIndustrialPark, WukuDistrict, NewTaipeiCity, Taiwan24803/新北市五股區新北產業園區五工路 134 號

台灣檢驗科技股份有限公司

t (886-2) 2299-3279

f (886-2) 2298-0488

www.tw.sgs.com

Member of SGS Group

7.5 Measurement Result:
802.11a (Main)

| | | Peak Power Output (dBm) | | | | | | | | |
|-----|-----------------|-------------------------|-------|-------|-------|-------|-------|-------|-------|-----------------|
| CH | Frequency (MHz) | Data Rate | | | | | | | | Required Limit |
| | | 6 | 9 | 12 | 18 | 24 | 36 | 48 | 54 | |
| 149 | 5745 | 24.85 | 24.75 | 24.68 | 24.61 | 24.58 | 24.45 | 24.40 | 24.38 | 1 Watt = 30 dBm |
| 157 | 5785 | 24.97 | 24.93 | 24.96 | 24.92 | 24.86 | 24.74 | 24.66 | 24.59 | 1 Watt = 30 dBm |
| 165 | 5825 | 24.61 | 24.58 | 24.50 | 24.43 | 24.32 | 24.26 | 24.15 | 24.03 | 1 Watt = 30 dBm |

| | | Average Power Output(dBm) | | | | | | | | |
|-----|-----------------|---------------------------|-------|-------|-------|-------|-------|-------|-------|-----------------|
| CH | Frequency (MHz) | Data Rate | | | | | | | | Required Limit |
| | | 6 | 9 | 12 | 18 | 24 | 36 | 48 | 54 | |
| 149 | 5745 | 14.53 | 14.36 | 14.21 | 14.10 | 13.95 | 13.76 | 13.63 | 13.49 | 1 Watt = 30 dBm |
| 157 | 5785 | 14.57 | 14.46 | 14.34 | 14.21 | 14.06 | 13.87 | 13.64 | 13.46 | 1 Watt = 30 dBm |
| 165 | 5825 | 14.01 | 13.96 | 13.87 | 13.82 | 13.75 | 13.62 | 13.43 | 13.29 | 1 Watt = 30 dBm |

Unless otherwise stated the results shown in this test report refer only to the sample(s) tested and such sample(s) are retained for 90 days only.

除非另有說明，此報告結果僅對測試之樣品負責，同時此樣品僅保留90天。本報告未經本公司書面許可，不可部份複製。

This document is issued by the Company subject to its General Conditions of Service printed overleaf, available on request or accessible at www.sgs.com/terms_and_conditions.htm and, for electronic format documents, subject to Terms and Conditions for Electronic Documents at www.sgs.com/terms_e-document.htm. Attention is drawn to the limitation of liability, indemnification and jurisdiction issues defined therein. Any holder of this document is advised that information contained hereon reflects the Company's findings at the time of its intervention only and within the limits of Client's instructions, if any. The Company's sole responsibility is to its Client and this document does not exonerate parties to a transaction from exercising all their rights and obligations under the transaction documents. This document cannot be reproduced except in full, without prior written approval of the Company. Any unauthorized alteration, forgery or falsification of the content or appearance of this document is unlawful and offenders may be prosecuted to the fullest extent of the law.

802.11a (Aux)

| | | Peak Power Output (dBm) | | | | | | | | |
|-----|-----------------|-------------------------|-------|-------|-------|-------|-------|-------|-------|-----------------|
| CH | Frequency (MHz) | Data Rate | | | | | | | | Required Limit |
| | | 6 | 9 | 12 | 18 | 24 | 36 | 48 | 54 | |
| 149 | 5745 | 24.11 | 24.08 | 24.05 | 24.03 | 24.06 | 24.01 | 23.98 | 23.96 | 1 Watt = 30 dBm |
| 157 | 5785 | 24.26 | 24.21 | 24.25 | 24.22 | 24.23 | 24.21 | 24.18 | 24.13 | 1 Watt = 30 dBm |
| 165 | 5825 | 24.96 | 24.93 | 24.87 | 24.82 | 24.76 | 24.65 | 24.57 | 24.49 | 1 Watt = 30 dBm |

| | | Average Power Output(dBm) | | | | | | | | |
|-----|-----------------|---------------------------|-------|-------|-------|-------|-------|-------|-------|-----------------|
| CH | Frequency (MHz) | Data Rate | | | | | | | | Required Limit |
| | | 6 | 9 | 12 | 18 | 24 | 36 | 48 | 54 | |
| 149 | 5745 | 14.03 | 13.96 | 13.81 | 13.62 | 13.53 | 13.46 | 13.26 | 13.01 | 1 Watt = 30 dBm |
| 157 | 5785 | 14.25 | 14.21 | 14.18 | 14.11 | 13.92 | 13.87 | 13.65 | 13.46 | 1 Watt = 30 dBm |
| 165 | 5825 | 14.92 | 14.79 | 14.52 | 14.34 | 14.06 | 13.88 | 13.75 | 13.67 | 1 Watt = 30 dBm |

Unless otherwise stated the results shown in this test report refer only to the sample(s) tested and such sample(s) are retained for 90 days only.

除非另有說明，此報告結果僅對測試之樣品負責，同時此樣品僅保留90天。本報告未經本公司書面許可，不可部份複製。

This document is issued by the Company subject to its General Conditions of Service printed overleaf, available on request or accessible at www.sgs.com/terms_and_conditions.htm and, for electronic format documents, subject to Terms and Conditions for Electronic Documents at www.sgs.com/terms_e-document.htm. Attention is drawn to the limitation of liability, indemnification and jurisdiction issues defined therein. Any holder of this document is advised that information contained hereon reflects the Company's findings at the time of its intervention only and within the limits of Client's instructions, if any. The Company's sole responsibility is to its Client and this document does not exonerate parties to a transaction from exercising all their rights and obligations under the transaction documents. This document cannot be reproduced except in full, without prior written approval of the Company. Any unauthorized alteration, forgery or falsification of the content or appearance of this document is unlawful and offenders may be prosecuted to the fullest extent of the law.

SGS Taiwan Ltd.

No.134,WuKungRoad,NewTaipeiIndustrialPark,WukuDistrict,NewTaipeiCity,Taiwan24803/新北市五股區新北產業園區五工路 134 號

台灣檢驗科技股份有限公司

t (886-2) 2299-3279

f (886-2) 2298-0488

www.tw.sgs.com

Member of SGS Group

802.11n (5GHz)_20M (Main)

| | | Peak Power Output(dBm) | | | | | | | | |
|-----|-----------------|------------------------|-------|-------|-------|-------|-------|-------|-------|-----------------|
| CH | Frequency (MHz) | Data Rate | | | | | | | | Required Limit |
| | | MCS0 | MCS1 | MCS2 | MCS3 | MCS4 | MCS5 | MCS6 | MCS7 | |
| 149 | 5745 | 23.73 | 23.68 | 23.66 | 23.61 | 23.56 | 23.47 | 23.41 | 23.32 | 1 Watt = 30 dBm |
| 157 | 5785 | 23.95 | 23.91 | 23.86 | 23.88 | 23.87 | 23.85 | 23.80 | 23.81 | 1 Watt = 30 dBm |
| 165 | 5825 | 23.41 | 23.26 | 23.39 | 23.38 | 23.32 | 23.18 | 23.26 | 23.31 | 1 Watt = 30 dBm |

| | | Average Power Output(dBm) | | | | | | | | |
|-----|-----------------|---------------------------|-------|-------|-------|-------|-------|-------|-------|-----------------|
| CH | Frequency (MHz) | Data Rate | | | | | | | | Required Limit |
| | | MCS0 | MCS1 | MCS2 | MCS3 | MCS4 | MCS5 | MCS6 | MCS7 | |
| 149 | 5745 | 13.37 | 13.35 | 13.31 | 13.36 | 13.32 | 13.28 | 13.25 | 13.21 | 1 Watt = 30 dBm |
| 157 | 5785 | 13.66 | 13.63 | 13.62 | 13.56 | 13.26 | 13.16 | 12.87 | 12.65 | 1 Watt = 30 dBm |
| 165 | 5825 | 13.22 | 13.12 | 12.86 | 12.73 | 12.48 | 12.34 | 12.30 | 12.22 | 1 Watt = 30 dBm |

802.11n (5GHz)_20M (Aux)

| | | Peak Power Output(dBm) | | | | | | | | |
|-----|-----------------|------------------------|-------|-------|-------|-------|-------|-------|-------|-----------------|
| CH | Frequency (MHz) | Data Rate | | | | | | | | Required Limit |
| | | MCS0 | MCS1 | MCS2 | MCS3 | MCS4 | MCS5 | MCS6 | MCS7 | |
| 149 | 5745 | 23.05 | 23.04 | 22.97 | 22.92 | 22.85 | 22.79 | 22.77 | 22.76 | 1 Watt = 30 dBm |
| 157 | 5785 | 23.68 | 23.66 | 23.61 | 23.57 | 23.53 | 23.46 | 23.34 | 23.17 | 1 Watt = 30 dBm |
| 165 | 5825 | 24.15 | 24.11 | 24.04 | 23.96 | 23.96 | 23.91 | 23.86 | 23.83 | 1 Watt = 30 dBm |

| | | Average Power Output(dBm) | | | | | | | | |
|-----|-----------------|---------------------------|-------|-------|-------|-------|-------|-------|-------|-----------------|
| CH | Frequency (MHz) | Data Rate | | | | | | | | Required Limit |
| | | MCS0 | MCS1 | MCS2 | MCS3 | MCS4 | MCS5 | MCS6 | MCS7 | |
| 149 | 5745 | 12.91 | 12.87 | 12.86 | 12.67 | 12.54 | 12.43 | 12.31 | 12.15 | 1 Watt = 30 dBm |
| 157 | 5785 | 13.44 | 13.37 | 13.26 | 13.10 | 12.98 | 12.83 | 12.74 | 12.61 | 1 Watt = 30 dBm |
| 165 | 5825 | 13.86 | 13.67 | 13.52 | 13.24 | 13.06 | 12.97 | 12.94 | 12.87 | 1 Watt = 30 dBm |

Unless otherwise stated the results shown in this test report refer only to the sample(s) tested and such sample(s) are retained for 90 days only.

除非另有說明，此報告結果僅對測試之樣品負責，同時此樣品僅保留90天。本報告未經本公司書面許可，不可部份複製。

This document is issued by the Company subject to its General Conditions of Service printed overleaf, available on request or accessible at www.sgs.com/terms_and_conditions.htm and, for electronic format documents, subject to Terms and Conditions for Electronic Documents at www.sgs.com/terms_e-document.htm. Attention is drawn to the limitation of liability, indemnification and jurisdiction issues defined therein. Any holder of this document is advised that information contained hereon reflects the Company's findings at the time of its intervention only and within the limits of Client's instructions, if any. The Company's sole responsibility is to its Client and this document does not exonerate parties to a transaction from exercising all their rights and obligations under the transaction documents. This document cannot be reproduced except in full, without prior written approval of the Company. Any unauthorized alteration, forgery or falsification of the content or appearance of this document is unlawful and offenders may be prosecuted to the fullest extent of the law.

802.11n (5GHz)_20M MIMO Chain 0

| | | Peak Power Output(dBm) | | | | | | | | Required Limit |
|-----|-----------------|------------------------|-------|-------|-------|-------|-------|-------|-------|-----------------------|
| CH | Frequency (MHz) | Data Rate | | | | | | | | |
| | | MCS8 | MCS9 | MCS10 | MCS11 | MCS12 | MCS13 | MCS14 | MCS15 | |
| 149 | 5745 | 20.01 | 19.76 | 19.23 | 18.95 | 18.67 | 18.42 | 18.17 | 17.97 | 0.68 Watt = 28.34 dBm |
| 157 | 5785 | 20.03 | 19.63 | 19.39 | 19.11 | 18.92 | 18.63 | 18.36 | 17.99 | 0.68 Watt = 28.34 dBm |
| 165 | 5825 | 19.95 | 18.96 | 18.84 | 18.73 | 18.65 | 18.48 | 18.31 | 18.04 | 0.68 Watt = 28.34 dBm |

| | | Average Power Output(dBm) | | | | | | | | Required Limit |
|-----|-----------------|---------------------------|-------|-------|-------|-------|-------|-------|-------|-----------------------|
| CH | Frequency (MHz) | Data Rate | | | | | | | | |
| | | MCS8 | MCS9 | MCS10 | MCS11 | MCS12 | MCS13 | MCS14 | MCS15 | |
| 149 | 5745 | 14.75 | 14.43 | 14.21 | 14.03 | 13.76 | 13.34 | 13.39 | 13.14 | 0.68 Watt = 28.34 dBm |
| 157 | 5785 | 14.91 | 14.49 | 14.33 | 14.13 | 13.68 | 13.47 | 13.15 | 12.81 | 0.68 Watt = 28.34 dBm |
| 165 | 5825 | 14.23 | 14.03 | 13.67 | 13.21 | 13.06 | 12.84 | 12.65 | 12.42 | 0.68 Watt = 28.34 dBm |

802.11n (5GHz)_20M MIMO Chain 1

| | | Peak Power Output(dBm) | | | | | | | | Required Limit |
|-----|-----------------|------------------------|-------|-------|-------|-------|-------|-------|-------|-----------------------|
| CH | Frequency (MHz) | Data Rate | | | | | | | | |
| | | MCS8 | MCS9 | MCS10 | MCS11 | MCS12 | MCS13 | MCS14 | MCS15 | |
| 149 | 5745 | 22.51 | 19.89 | 19.71 | 19.33 | 19.25 | 19.09 | 18.94 | 18.61 | 0.68 Watt = 28.34 dBm |
| 157 | 5785 | 23.02 | 19.79 | 19.64 | 19.29 | 19.10 | 18.95 | 18.13 | 17.86 | 0.68 Watt = 28.34 dBm |
| 165 | 5825 | 22.95 | 19.64 | 19.34 | 19.17 | 18.99 | 18.76 | 18.65 | 18.07 | 0.68 Watt = 28.34 dBm |

| | | Average Power Output(dBm) | | | | | | | | Required Limit |
|-----|-----------------|---------------------------|-------|-------|-------|-------|-------|-------|-------|-----------------------|
| CH | Frequency (MHz) | Data Rate | | | | | | | | |
| | | MCS8 | MCS9 | MCS10 | MCS11 | MCS12 | MCS13 | MCS14 | MCS15 | |
| 149 | 5745 | 13.61 | 13.31 | 13.14 | 12.92 | 12.65 | 12.53 | 12.51 | 12.27 | 0.68 Watt = 28.34 dBm |
| 157 | 5785 | 14.08 | 13.67 | 13.58 | 13.39 | 13.19 | 13.00 | 12.84 | 12.55 | 0.68 Watt = 28.34 dBm |
| 165 | 5825 | 14.48 | 14.34 | 14.21 | 14.08 | 13.86 | 13.67 | 13.31 | 13.02 | 0.68 Watt = 28.34 dBm |

Unless otherwise stated the results shown in this test report refer only to the sample(s) tested and such sample(s) are retained for 90 days only.

除非另有說明，此報告結果僅對測試之樣品負責，同時此樣品僅保留90天。本報告未經本公司書面許可，不可部份複製。

This document is issued by the Company subject to its General Conditions of Service printed overleaf, available on request or accessible at www.sgs.com/terms_and_conditions.htm and, for electronic format documents, subject to Terms and Conditions for Electronic Documents at www.sgs.com/terms_e-document.htm. Attention is drawn to the limitation of liability, indemnification and jurisdiction issues defined therein. Any holder of this document is advised that information contained hereon reflects the Company's findings at the time of its intervention only and within the limits of Client's instructions, if any. The Company's sole responsibility is to its Client and this document does not exonerate parties to a transaction from exercising all their rights and obligations under the transaction documents. This document cannot be reproduced except in full, without prior written approval of the Company. Any unauthorized alteration, forgery or falsification of the content or appearance of this document is unlawful and offenders may be prosecuted to the fullest extent of the law.

802.11n (5GHz)_20M MIMO Chain 0+ Chain1

| | | Peak Power Output(dBm) | | | | | | | | |
|-----|-----------------|------------------------|-------|-------|-------|-------|-------|-------|-------|-----------------------|
| CH | Frequency (MHz) | Data Rate | | | | | | | | Required Limit |
| | | MCS8 | MCS9 | MCS10 | MCS11 | MCS12 | MCS13 | MCS14 | MCS15 | |
| 149 | 5745 | 23.00 | 22.84 | 22.49 | 22.15 | 21.98 | 21.78 | 21.58 | 21.31 | 0.68 Watt = 28.34 dBm |
| 157 | 5785 | 22.99 | 22.72 | 22.53 | 22.21 | 22.02 | 21.80 | 21.26 | 20.94 | 0.68 Watt = 28.34 dBm |
| 165 | 5825 | 23.00 | 22.32 | 22.11 | 21.97 | 21.83 | 21.63 | 21.49 | 21.07 | 0.68 Watt = 28.34 dBm |

| | | Average Power Output(dBm) | | | | | | | | |
|-----|-----------------|---------------------------|-------|-------|-------|-------|-------|-------|-------|-----------------------|
| CH | Frequency (MHz) | Data Rate | | | | | | | | Required Limit |
| | | MCS8 | MCS9 | MCS10 | MCS11 | MCS12 | MCS13 | MCS14 | MCS15 | |
| 149 | 5745 | 17.23 | 16.92 | 16.72 | 16.52 | 16.25 | 15.96 | 15.98 | 15.74 | 0.68 Watt = 28.34 dBm |
| 157 | 5785 | 17.53 | 17.11 | 16.98 | 16.79 | 16.45 | 16.25 | 16.01 | 15.69 | 0.68 Watt = 28.34 dBm |
| 165 | 5825 | 17.37 | 17.20 | 16.96 | 16.68 | 16.49 | 16.29 | 16.00 | 15.74 | 0.68 Watt = 28.34 dBm |

802.11n (5GHz)_40M (Main)

| | | Peak Power Output(dBm) | | | | | | | | |
|-----|-----------------|------------------------|-------|-------|-------|-------|-------|-------|-------|-----------------|
| CH | Frequency (MHz) | Data Rate | | | | | | | | Required Limit |
| | | MCS0 | MCS1 | MCS2 | MCS3 | MCS4 | MCS5 | MCS6 | MCS7 | |
| 151 | 5755 | 19.26 | 18.96 | 18.62 | 18.11 | 17.92 | 17.57 | 17.32 | 17.10 | 1 Watt = 30 dBm |
| 159 | 5795 | 19.37 | 19.02 | 18.77 | 18.42 | 18.04 | 17.68 | 17.46 | 17.08 | 1 Watt = 30 dBm |

| | | Average Power Output(dBm) | | | | | | | | |
|-----|-----------------|---------------------------|------|------|------|------|------|------|------|-----------------|
| CH | Frequency (MHz) | Data Rate | | | | | | | | Required Limit |
| | | MCS0 | MCS1 | MCS2 | MCS3 | MCS4 | MCS5 | MCS6 | MCS7 | |
| 151 | 5755 | 7.25 | 7.02 | 6.93 | 6.74 | 6.58 | 6.41 | 6.34 | 6.17 | 1 Watt = 30 dBm |
| 159 | 5795 | 7.23 | 7.10 | 6.88 | 6.67 | 6.49 | 6.35 | 6.23 | 6.15 | 1 Watt = 30 dBm |

Unless otherwise stated the results shown in this test report refer only to the sample(s) tested and such sample(s) are retained for 90 days only.

除非另有說明，此報告結果僅對測試之樣品負責，同時此樣品僅保留90天。本報告未經本公司書面許可，不可部份複製。

This document is issued by the Company subject to its General Conditions of Service printed overleaf, available on request or accessible at www.sgs.com/terms_and_conditions.htm and, for electronic format documents, subject to Terms and Conditions for Electronic Documents at www.sgs.com/terms_e-document.htm. Attention is drawn to the limitation of liability, indemnification and jurisdiction issues defined therein. Any holder of this document is advised that information contained hereon reflects the Company's findings at the time of its intervention only and within the limits of Client's instructions, if any. The Company's sole responsibility is to its Client and this document does not exonerate parties to a transaction from exercising all their rights and obligations under the transaction documents. This document cannot be reproduced except in full, without prior written approval of the Company. Any unauthorized alteration, forgery or falsification of the content or appearance of this document is unlawful and offenders may be prosecuted to the fullest extent of the law.

802.11n (5GHz)_40M (Aux)

| | | Peak Power Output(dBm) | | | | | | | | Required Limit |
|-----|-----------------|------------------------|-------|-------|-------|-------|-------|-------|-------|-----------------|
| CH | Frequency (MHz) | Data Rate | | | | | | | | |
| | | MCS0 | MCS1 | MCS2 | MCS3 | MCS4 | MCS5 | MCS6 | MCS7 | |
| 151 | 5755 | 19.96 | 19.66 | 19.15 | 18.94 | 18.62 | 18.17 | 17.97 | 17.84 | 1 Watt = 30 dBm |
| 159 | 5795 | 19.92 | 19.58 | 19.22 | 18.95 | 18.74 | 18.39 | 17.92 | 17.76 | 1 Watt = 30 dBm |

| | | Average Power Output(dBm) | | | | | | | | Required Limit |
|-----|-----------------|---------------------------|------|------|------|------|------|------|------|-----------------|
| CH | Frequency (MHz) | Data Rate | | | | | | | | |
| | | MCS0 | MCS1 | MCS2 | MCS3 | MCS4 | MCS5 | MCS6 | MCS7 | |
| 151 | 5755 | 7.91 | 7.78 | 7.54 | 7.38 | 7.08 | 6.94 | 6.83 | 6.77 | 1 Watt = 30 dBm |
| 159 | 5795 | 7.85 | 7.66 | 7.47 | 7.26 | 7.10 | 7.02 | 6.98 | 6.81 | 1 Watt = 30 dBm |

802.11n (5GHz)_40M MIMO Chain 0

| | | Peak Power Output(dBm) | | | | | | | | Required Limit |
|-----|-----------------|------------------------|-------|-------|-------|-------|-------|-------|-------|-----------------------|
| CH | Frequency (MHz) | Data Rate | | | | | | | | |
| | | MCS8 | MCS9 | MCS10 | MCS11 | MCS12 | MCS13 | MCS14 | MCS15 | |
| 151 | 5755 | 19.32 | 19.26 | 19.18 | 19.06 | 19.01 | 18.97 | 18.94 | 18.89 | 0.68 Watt = 28.34 dBm |
| 159 | 5795 | 19.06 | 19.01 | 18.97 | 18.93 | 18.86 | 18.83 | 18.79 | 18.76 | 0.68 Watt = 28.34 dBm |

| | | Average Power Output(dBm) | | | | | | | | Required Limit |
|-----|-----------------|---------------------------|------|-------|-------|-------|-------|-------|-------|-----------------------|
| CH | Frequency (MHz) | Data Rate | | | | | | | | |
| | | MCS8 | MCS9 | MCS10 | MCS11 | MCS12 | MCS13 | MCS14 | MCS15 | |
| 151 | 5755 | 8.62 | 8.55 | 8.37 | 7.96 | 7.64 | 7.03 | 6.84 | 6.68 | 0.68 Watt = 28.34 dBm |
| 159 | 5795 | 8.52 | 8.37 | 8.21 | 7.96 | 7.54 | 7.08 | 6.87 | 6.36 | 0.68 Watt = 28.34 dBm |

Unless otherwise stated the results shown in this test report refer only to the sample(s) tested and such sample(s) are retained for 90 days only.

除非另有說明，此報告結果僅對測試之樣品負責，同時此樣品僅保留90天。本報告未經本公司書面許可，不可部份複製。

This document is issued by the Company subject to its General Conditions of Service printed overleaf, available on request or accessible at www.sgs.com/terms_and_conditions.htm and, for electronic format documents, subject to Terms and Conditions for Electronic Documents at www.sgs.com/terms_e-document.htm. Attention is drawn to the limitation of liability, indemnification and jurisdiction issues defined therein. Any holder of this document is advised that information contained hereon reflects the Company's findings at the time of its intervention only and within the limits of Client's instructions, if any. The Company's sole responsibility is to its Client and this document does not exonerate parties to a transaction from exercising all their rights and obligations under the transaction documents. This document cannot be reproduced except in full, without prior written approval of the Company. Any unauthorized alteration, forgery or falsification of the content or appearance of this document is unlawful and offenders may be prosecuted to the fullest extent of the law.

SGS Taiwan Ltd.

No.134,WuKungRoad,NewTaipeiIndustrialPark,WukuDistrict,NewTaipeiCity,Taiwan24803/新北市五股區新北產業園區五工路 134 號

台灣檢驗科技股份有限公司

t (886-2) 2299-3279

f (886-2) 2298-0488

www.tw.sgs.com

Member of SGS Group

802.11n (5GHz)_40M MIMO Chain 1

| | | Peak Power Output(dBm) | | | | | | | | Required Limit |
|-----|-----------------|------------------------|-------|-------|-------|-------|-------|-------|-------|------------------------------|
| CH | Frequency (MHz) | Data Rate | | | | | | | | |
| | | MCS8 | MCS9 | MCS10 | MCS11 | MCS12 | MCS13 | MCS14 | MCS15 | |
| 151 | 5755 | 18.79 | 18.73 | 18.67 | 18.62 | 18.57 | 18.52 | 18.49 | 18.44 | 0.68 Watt = 28.34 dBm |
| 159 | 5795 | 18.98 | 18.97 | 18.96 | 18.93 | 18.94 | 18.96 | 18.92 | 18.94 | 0.68 Watt = 28.34 dBm |

| | | Average Power Output(dBm) | | | | | | | | Required Limit |
|-----|-----------------|---------------------------|------|-------|-------|-------|-------|-------|-------|------------------------------|
| CH | Frequency (MHz) | Data Rate | | | | | | | | |
| | | MCS8 | MCS9 | MCS10 | MCS11 | MCS12 | MCS13 | MCS14 | MCS15 | |
| 151 | 5755 | 8.42 | 8.22 | 7.93 | 7.67 | 7.26 | 6.97 | 6.78 | 6.24 | 0.68 Watt = 28.34 dBm |
| 159 | 5795 | 8.33 | 8.12 | 7.96 | 7.83 | 7.42 | 7.03 | 6.86 | 6.49 | 0.68 Watt = 28.34 dBm |

802.11n (5GHz)_40M MIMO Chain 0+Chain 1

| | | Peak Power Output(dBm) | | | | | | | | Required Limit |
|-----|-----------------|------------------------|-------|-------|-------|-------|-------|-------|-------|------------------------------|
| CH | Frequency (MHz) | Data Rate | | | | | | | | |
| | | MCS8 | MCS9 | MCS10 | MCS11 | MCS12 | MCS13 | MCS14 | MCS15 | |
| 151 | 5755 | 22.07 | 22.01 | 21.94 | 21.86 | 21.81 | 21.76 | 21.73 | 21.68 | 0.68 Watt = 28.34 dBm |
| 159 | 5795 | 22.03 | 22.00 | 21.98 | 21.94 | 21.91 | 21.91 | 21.87 | 21.86 | 0.68 Watt = 28.34 dBm |

| | | Average Power Output(dBm) | | | | | | | | Required Limit |
|-----|-----------------|---------------------------|-------|-------|-------|-------|-------|-------|-------|------------------------------|
| CH | Frequency (MHz) | Data Rate | | | | | | | | |
| | | MCS8 | MCS9 | MCS10 | MCS11 | MCS12 | MCS13 | MCS14 | MCS15 | |
| 151 | 5755 | 11.53 | 11.40 | 11.17 | 10.83 | 10.46 | 10.01 | 9.82 | 9.48 | 0.68 Watt = 28.34 dBm |
| 159 | 5795 | 11.44 | 11.26 | 11.10 | 10.91 | 10.49 | 10.07 | 9.88 | 9.44 | 0.68 Watt = 28.34 dBm |

** Note: The duty cycle factor is compensated back to obtain the maximum value of the measurement in average.*

Unless otherwise stated the results shown in this test report refer only to the sample(s) tested and such sample(s) are retained for 90 days only.

除非另有說明，此報告結果僅對測試之樣品負責，同時此樣品僅保留90天。本報告未經本公司書面許可，不可部份複製。

This document is issued by the Company subject to its General Conditions of Service printed overleaf, available on request or accessible at www.sgs.com/terms_and_conditions.htm and, for electronic format documents, subject to Terms and Conditions for Electronic Documents at www.sgs.com/terms_e-document.htm. Attention is drawn to the limitation of liability, indemnification and jurisdiction issues defined therein. Any holder of this document is advised that information contained hereon reflects the Company's findings at the time of its intervention only and within the limits of Client's instructions, if any. The Company's sole responsibility is to its Client and this document does not exonerate parties to a transaction from exercising all their rights and obligations under the transaction documents. This document cannot be reproduced except in full, without prior written approval of the Company. Any unauthorized alteration, forgery or falsification of the content or appearance of this document is unlawful and offenders may be prosecuted to the fullest extent of the law.

ERP/EIRP Measurement:

802.11a (Main)

| | | EIRP (dBm) | | | | | | | | Required Limit |
|-----|-----------------|--------------|-------|-------|-------|-------|-------|-------|-------|------------------|
| CH | Frequency (MHz) | Data Rate | | | | | | | | |
| | | 6 | 9 | 12 | 18 | 24 | 36 | 48 | 54 | |
| 149 | 5745 | 25.45 | 25.28 | 25.13 | 25.02 | 24.87 | 24.68 | 24.55 | 24.41 | 4 Watts = 36 dBm |
| 157 | 5785 | 25.49 | 25.38 | 25.26 | 25.13 | 24.98 | 24.79 | 24.56 | 24.38 | 4 Watts = 36 dBm |
| 165 | 5825 | 24.93 | 24.88 | 24.79 | 24.74 | 24.67 | 24.54 | 24.35 | 24.21 | 4 Watts = 36 dBm |

802.11a (Aux)

| | | EIRP (dBm) | | | | | | | | Required Limit |
|-----|-----------------|--------------|-------|-------|-------|-------|-------|-------|-------|------------------|
| CH | Frequency (MHz) | Data Rate | | | | | | | | |
| | | 6 | 9 | 12 | 18 | 24 | 36 | 48 | 54 | |
| 149 | 5745 | 22.25 | 22.18 | 22.03 | 21.84 | 21.75 | 21.68 | 21.48 | 21.23 | 4 Watts = 36 dBm |
| 157 | 5785 | 22.47 | 22.43 | 22.40 | 22.33 | 22.14 | 22.09 | 21.87 | 21.68 | 4 Watts = 36 dBm |
| 165 | 5825 | 23.14 | 23.01 | 22.74 | 22.56 | 22.28 | 22.10 | 21.97 | 21.89 | 4 Watts = 36 dBm |

802.11n (5GHz)_20M (Main)

| | | EIRP (dBm) | | | | | | | | Required Limit |
|-----|-----------------|--------------|-------|-------|-------|-------|-------|-------|-------|------------------|
| CH | Frequency (MHz) | Data Rate | | | | | | | | |
| | | MCS0 | MCS1 | MCS2 | MCS3 | MCS4 | MCS5 | MCS6 | MCS7 | |
| 149 | 5745 | 24.29 | 24.27 | 24.23 | 24.28 | 24.24 | 24.20 | 24.17 | 24.13 | 4 Watts = 36 dBm |
| 157 | 5785 | 24.58 | 24.55 | 24.54 | 24.48 | 24.18 | 24.08 | 23.79 | 23.57 | 4 Watts = 36 dBm |
| 165 | 5825 | 24.14 | 24.04 | 23.78 | 23.65 | 23.40 | 23.26 | 23.22 | 23.14 | 4 Watts = 36 dBm |

Unless otherwise stated the results shown in this test report refer only to the sample(s) tested and such sample(s) are retained for 90 days only.

除非另有說明，此報告結果僅對測試之樣品負責，同時此樣品僅保留90天。本報告未經本公司書面許可，不可部份複製。

This document is issued by the Company subject to its General Conditions of Service printed overleaf, available on request or accessible at www.sgs.com/terms_and_conditions.htm and, for electronic format documents, subject to Terms and Conditions for Electronic Documents at www.sgs.com/terms_e-document.htm. Attention is drawn to the limitation of liability, indemnification and jurisdiction issues defined therein. Any holder of this document is advised that information contained hereon reflects the Company's findings at the time of its intervention only and within the limits of Client's instructions, if any. The Company's sole responsibility is to its Client and this document does not exonerate parties to a transaction from exercising all their rights and obligations under the transaction documents. This document cannot be reproduced except in full, without prior written approval of the Company. Any unauthorized alteration, forgery or falsification of the content or appearance of this document is unlawful and offenders may be prosecuted to the fullest extent of the law.

SGS Taiwan Ltd.

No.134,WuKungRoad,NewTaipeiIndustrialPark,WukuDistrict,NewTaipeiCity,Taiwan24803/新北市五股區新北產業園區五工路 134 號

台灣檢驗科技股份有限公司

t (886-2) 2299-3279

f (886-2) 2298-0488

www.tw.sgs.com

Member of SGS Group

802.11n (5GHz)_20M (Aux)

| | | EIRP (dBm) | | | | | | | | |
|-----|-----------------|--------------|-------|-------|-------|-------|-------|-------|-------|---------------------|
| CH | Frequency (MHz) | Data Rate | | | | | | | | Required Limit |
| | | MCS0 | MCS1 | MCS2 | MCS3 | MCS4 | MCS5 | MCS6 | MCS7 | |
| 149 | 5745 | 21.13 | 21.09 | 21.08 | 20.89 | 20.76 | 20.65 | 20.53 | 20.37 | 4 Watts = 36 dBm |
| 157 | 5785 | 21.66 | 21.59 | 21.48 | 21.32 | 21.20 | 21.05 | 20.96 | 20.83 | 4 Watts = 36 dBm |
| 165 | 5825 | 22.08 | 21.89 | 21.74 | 21.46 | 21.28 | 21.19 | 21.16 | 21.09 | 4 Watts = 36 dBm |

802.11n (5GHz)_20M MIMO Chain 0

| | | EIRP (dBm) | | | | | | | | |
|-----|-----------------|--------------|-------|-------|-------|-------|-------|-------|-------|---------------------|
| CH | Frequency (MHz) | Data Rate | | | | | | | | Required Limit |
| | | MCS8 | MCS9 | MCS10 | MCS11 | MCS12 | MCS13 | MCS14 | MCS15 | |
| 149 | 5745 | 24.71 | 24.39 | 24.17 | 23.99 | 23.72 | 23.30 | 23.35 | 23.10 | 4 Watts = 36 dBm |
| 157 | 5785 | 24.87 | 24.45 | 24.29 | 24.09 | 23.64 | 23.43 | 23.11 | 22.77 | 4 Watts = 36 dBm |
| 165 | 5825 | 24.19 | 23.99 | 23.63 | 23.17 | 23.02 | 22.80 | 22.61 | 22.38 | 4 Watts = 36 dBm |

802.11n (5GHz)_20M MIMO Chain 1

| | | EIRP (dBm) | | | | | | | | |
|-----|-----------------|--------------|-------|-------|-------|-------|-------|-------|-------|---------------------|
| CH | Frequency (MHz) | Data Rate | | | | | | | | Required Limit |
| | | MCS8 | MCS9 | MCS10 | MCS11 | MCS12 | MCS13 | MCS14 | MCS15 | |
| 149 | 5745 | 23.57 | 23.27 | 23.10 | 22.88 | 22.61 | 22.49 | 22.47 | 22.23 | 4 Watts = 36 dBm |
| 157 | 5785 | 24.04 | 23.63 | 23.54 | 23.35 | 23.15 | 22.96 | 22.80 | 22.51 | 4 Watts = 36 dBm |
| 165 | 5825 | 24.44 | 24.30 | 24.17 | 24.04 | 23.82 | 23.63 | 23.27 | 22.98 | 4 Watts = 36 dBm |

Unless otherwise stated the results shown in this test report refer only to the sample(s) tested and such sample(s) are retained for 90 days only.

除非另有說明，此報告結果僅對測試之樣品負責，同時此樣品僅保留90天。本報告未經本公司書面許可，不可部份複製。

This document is issued by the Company subject to its General Conditions of Service printed overleaf, available on request or accessible at www.sgs.com/terms_and_conditions.htm and, for electronic format documents, subject to Terms and Conditions for Electronic Documents at www.sgs.com/terms_e-document.htm. Attention is drawn to the limitation of liability, indemnification and jurisdiction issues defined therein. Any holder of this document is advised that information contained hereon reflects the Company's findings at the time of its intervention only and within the limits of Client's instructions, if any. The Company's sole responsibility is to its Client and this document does not exonerate parties to a transaction from exercising all their rights and obligations under the transaction documents. This document cannot be reproduced except in full, without prior written approval of the Company. Any unauthorized alteration, forgery or falsification of the content or appearance of this document is unlawful and offenders may be prosecuted to the fullest extent of the law.

SGS Taiwan Ltd.

No.134,WuKungRoad,NewTaipeiIndustrialPark,WukuDistrict,NewTaipeiCity,Taiwan24803/新北市五股區新北產業園區五工路 134 號

台灣檢驗科技股份有限公司

t (886-2) 2299-3279

f (886-2) 2298-0488

www.tw.sgs.com

Member of SGS Group

802.11n (5GHz)_20M MIMO Chain 0+Chain 1

| | | EIRP (dBm) | | | | | | | | |
|-----|-----------------|------------|-------|-------|-------|-------|-------|-------|-------|---------------------|
| CH | Frequency (MHz) | Data Rate | | | | | | | | Required Limit |
| | | MCS8 | MCS9 | MCS10 | MCS11 | MCS12 | MCS13 | MCS14 | MCS15 | |
| 149 | 5745 | 27.19 | 26.88 | 26.68 | 26.48 | 26.21 | 25.92 | 25.94 | 25.70 | 4 Watts = 36 dBm |
| 157 | 5785 | 27.49 | 27.07 | 26.94 | 26.75 | 26.41 | 26.21 | 25.97 | 25.65 | 4 Watts = 36 dBm |
| 165 | 5825 | 27.33 | 27.16 | 26.92 | 26.64 | 26.45 | 26.25 | 25.96 | 25.70 | 4 Watts = 36 dBm |

802.11n (5GHz)_40M (Main)

| | | EIRP (dBm) | | | | | | | | |
|-----|-----------------|------------|-------|-------|-------|-------|-------|-------|-------|---------------------|
| CH | Frequency (MHz) | Data Rate | | | | | | | | Required Limit |
| | | MCS8 | MCS9 | MCS10 | MCS11 | MCS12 | MCS13 | MCS14 | MCS15 | |
| 151 | 5755 | 18.17 | 17.94 | 17.85 | 17.66 | 17.50 | 17.33 | 17.26 | 17.09 | 4 Watts = 36 dBm |
| 159 | 5795 | 18.15 | 18.02 | 17.80 | 17.59 | 17.41 | 17.27 | 17.15 | 17.07 | 4 Watts = 36 dBm |

802.11n (5GHz)_40M (Aux)

| | | EIRP (dBm) | | | | | | | | |
|-----|-----------------|------------|-------|-------|-------|-------|-------|-------|-------|---------------------|
| CH | Frequency (MHz) | Data Rate | | | | | | | | Required Limit |
| | | MCS8 | MCS9 | MCS10 | MCS11 | MCS12 | MCS13 | MCS14 | MCS15 | |
| 151 | 5755 | 16.13 | 16.00 | 15.76 | 15.60 | 15.30 | 15.16 | 15.05 | 14.99 | 4 Watts = 36 dBm |
| 159 | 5795 | 16.07 | 15.88 | 15.69 | 15.48 | 15.32 | 15.24 | 15.20 | 15.03 | 4 Watts = 36 dBm |

Unless otherwise stated the results shown in this test report refer only to the sample(s) tested and such sample(s) are retained for 90 days only.

除非另有說明，此報告結果僅對測試之樣品負責，同時此樣品僅保留90天。本報告未經本公司書面許可，不可部份複製。

This document is issued by the Company subject to its General Conditions of Service printed overleaf, available on request or accessible at www.sgs.com/terms_and_conditions.htm and, for electronic format documents, subject to Terms and Conditions for Electronic Documents at www.sgs.com/terms_e-document.htm. Attention is drawn to the limitation of liability, indemnification and jurisdiction issues defined therein. Any holder of this document is advised that information contained hereon reflects the Company's findings at the time of its intervention only and within the limits of Client's instructions, if any. The Company's sole responsibility is to its Client and this document does not exonerate parties to a transaction from exercising all their rights and obligations under the transaction documents. This document cannot be reproduced except in full, without prior written approval of the Company. Any unauthorized alteration, forgery or falsification of the content or appearance of this document is unlawful and offenders may be prosecuted to the fullest extent of the law.

802.11n (5GHz)_40M MIMO Chain 0

| | | EIRP (dBm) | | | | | | | | |
|-----|-----------------|------------|-------|-------|-------|-------|-------|-------|-------|---------------------|
| CH | Frequency (MHz) | Data Rate | | | | | | | | Required Limit |
| | | MCS8 | MCS9 | MCS10 | MCS11 | MCS12 | MCS13 | MCS14 | MCS15 | |
| 151 | 5755 | 18.58 | 18.51 | 18.33 | 17.92 | 17.60 | 16.99 | 16.80 | 16.64 | 4 Watts = 36 dBm |
| 159 | 5795 | 18.48 | 18.33 | 18.17 | 17.92 | 17.50 | 17.04 | 16.83 | 16.32 | 4 Watts = 36 dBm |

802.11n (5GHz)_40M MIMO Chain 1

| | | EIRP (dBm) | | | | | | | | |
|-----|-----------------|------------|-------|-------|-------|-------|-------|-------|-------|---------------------|
| CH | Frequency (MHz) | Data Rate | | | | | | | | Required Limit |
| | | MCS8 | MCS9 | MCS10 | MCS11 | MCS12 | MCS13 | MCS14 | MCS15 | |
| 151 | 5755 | 18.38 | 18.18 | 17.89 | 17.63 | 17.22 | 16.93 | 16.74 | 16.20 | 4 Watts = 36 dBm |
| 159 | 5795 | 18.29 | 18.08 | 17.92 | 17.79 | 17.38 | 16.99 | 16.82 | 16.45 | 4 Watts = 36 dBm |

802.11n (5GHz)_40M MIMO Chain 0+Chain 1

| | | EIRP (dBm) | | | | | | | | |
|-----|-----------------|------------|-------|-------|-------|-------|-------|-------|-------|---------------------|
| CH | Frequency (MHz) | Data Rate | | | | | | | | Required Limit |
| | | MCS8 | MCS9 | MCS10 | MCS11 | MCS12 | MCS13 | MCS14 | MCS15 | |
| 151 | 5755 | 21.49 | 21.36 | 21.13 | 20.79 | 20.42 | 19.97 | 19.78 | 19.44 | 4 Watts = 36 dBm |
| 159 | 5795 | 21.40 | 21.22 | 21.06 | 20.87 | 20.45 | 20.03 | 19.84 | 19.40 | 4 Watts = 36 dBm |

* Note: EIRP = Average Power + Gain, where the nominal gain of the antenna (10.92dBi for 5GHz Main, 8.22dBi for 5GHz Aux and 9.96dBi for 5GHz (MIMO)).

Unless otherwise stated the results shown in this test report refer only to the sample(s) tested and such sample(s) are retained for 90 days only.

除非另有說明，此報告結果僅對測試之樣品負責，同時此樣品僅保留90天。本報告未經本公司書面許可，不可部份複製。

This document is issued by the Company subject to its General Conditions of Service printed overleaf, available on request or accessible at www.sgs.com/terms_and_conditions.htm and, for electronic format documents, subject to Terms and Conditions for Electronic Documents at www.sgs.com/terms_e-document.htm. Attention is drawn to the limitation of liability, indemnification and jurisdiction issues defined therein. Any holder of this document is advised that information contained hereon reflects the Company's findings at the time of its intervention only and within the limits of Client's instructions, if any. The Company's sole responsibility is to its Client and this document does not exonerate parties to a transaction from exercising all their rights and obligations under the transaction documents. This document cannot be reproduced except in full, without prior written approval of the Company. Any unauthorized alteration, forgery or falsification of the content or appearance of this document is unlawful and offenders may be prosecuted to the fullest extent of the law.

8 6dB BANDWIDTH

8.1 Standard Applicable:

According to §15.247(a)(2), Systems using digital modulation techniques may operate in the 902 - 928 MHz, 2400 - 2483.5 MHz, and 5725 - 5850 MHz bands. The minimum 6 dB bandwidth shall be at least 500kHz.

According to RSS 210 issue 8: 2010Annex 8.2. Systems employing digital modulation techniques (which includes direct sequence) can now be certified under RSS-210 provided they comply with the following requirements: The minimum 6 dB bandwidth shall be at least 500 kHz.

8.2 Measurement Equipment Used:

| SGS Conducted Room(ALL) | | | | | |
|-------------------------|---------------|--------------|----------------|------------------|-----------------|
| Name of Equipment | Manufacturer | Model | Serial Number | Calibration Date | Calibration Due |
| Spectrum Analyzer | Agilent | N9010A | MY51440121 | 02/13/2012 | 02/12/2014 |
| Power Meter | Anritsu | ML2495A | 1005007 | 02/08/2012 | 02/07/2014 |
| Power Sensor | Anritsu | MA2411B | 917032 | 02/08/2012 | 02/07/2014 |
| DC Power Supply | HOLA | DP-3003 | 001 | N.C.R. | N.C.R. |
| Coaxial Cable | WOKEN | conducted #2 | 001 | 12/21/2012 | 12/20/2013 |
| DC Block | Mini-Circuits | BLK-18-S+ | 002 | 12/21/2012 | 12/20/2013 |
| Splitter | RF-LAMBAD | RFLT2W1G18G | 11-JSPF412-018 | 12/21/2012 | 12/20/2013 |
| Attenuator | Mini-Circuits | BW-S10W2+ | 002 | 12/21/2012 | 12/20/2013 |
| Temperature Chamber | TERCHY | MHK-120LK | 1020582 | 06/20/2013 | 06/19/2014 |

8.3 Test Set-up:

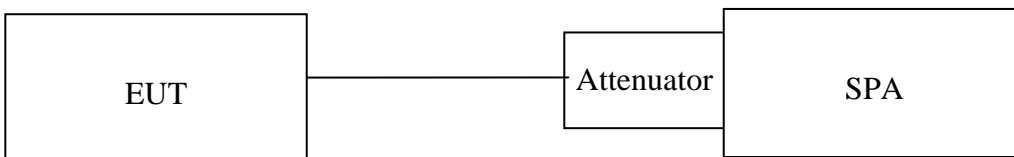

Unless otherwise stated the results shown in this test report refer only to the sample(s) tested and such sample(s) are retained for 90 days only.

除非另有說明，此報告結果僅對測試之樣品負責，同時此樣品僅保留90天。本報告未經本公司書面許可，不可部份複製。

This document is issued by the Company subject to its General Conditions of Service printed overleaf, available on request or accessible at www.sgs.com/terms_and_conditions.htm and, for electronic format documents, subject to Terms and Conditions for Electronic Documents at www.sgs.com/terms_e-document.htm. Attention is drawn to the limitation of liability, indemnification and jurisdiction issues defined therein. Any holder of this document is advised that information contained hereon reflects the Company's findings at the time of its intervention only and within the limits of Client's instructions, if any. The Company's sole responsibility is to its Client and this document does not exonerate parties to a transaction from exercising all their rights and obligations under the transaction documents. This document cannot be reproduced except in full, without prior written approval of the Company. Any unauthorized alteration, forgery or falsification of the content or appearance of this document is unlawful and offenders may be prosecuted to the fullest extent of the law.

SGS Taiwan Ltd.

No.134,WuKungRoad,NewTaipeiIndustrialPark,WukuDistrict,NewTaipeiCity,Taiwan24803/新北市五股區新北產業園區五工路 134 號

台灣檢驗科技股份有限公司

t (886-2) 2299-3279

f (886-2) 2298-0488

www.tw.sgs.com

Member of SGS Group

8.4 Measurement Procedure:

1. Place the EUT on the table and set it in transmitting mode.
2. Remove the antenna from the EUT and then connect a low loss RF cable from the antenna port to the spectrum analyzer.
3. Set the spectrum analyzer as RBW = 100 kHz, VBW = 3*RBW, Span = 30M/50MHz, Detector=Peak, Sweep=auto, the setting on spectrum is adjusted based on the procedure as guide in 8.1 option 1 of KDB558074.
4. Mark the peak frequency and -6dB (upper and lower) frequency.
5. Repeat above procedures until all frequency of interest measured was complete.

8.5 Measurement Result:

802.11a

| Frequency (MHz) | Bandwidth (kHz) | Limit (kHz) | Result |
|-----------------|-----------------|-------------|--------|
| 5745 | 16370 | > 500 | PASS |
| 5785 | 16370 | > 500 | PASS |
| 5825 | 16390 | > 500 | PASS |

802.11n (5GHz)_20M MIMO-Main

| Frequency (MHz) | Bandwidth (kHz) | Limit (kHz) | Result |
|-----------------|-----------------|-------------|--------|
| 5745 | 17670 | > 500 | PASS |
| 5785 | 17670 | > 500 | PASS |
| 5825 | 17690 | > 500 | PASS |

802.11n (5GHz)_20M MIMO-Aux

| Frequency (MHz) | Bandwidth (kHz) | Limit (kHz) | Result |
|-----------------|-----------------|-------------|--------|
| 5745 | 17310 | > 500 | PASS |
| 5785 | 16980 | > 500 | PASS |
| 5825 | 17330 | > 500 | PASS |

Unless otherwise stated the results shown in this test report refer only to the sample(s) tested and such sample(s) are retained for 90 days only.

除非另有說明，此報告結果僅對測試之樣品負責，同時此樣品僅保留90天。本報告未經本公司書面許可，不可部份複製。

This document is issued by the Company subject to its General Conditions of Service printed overleaf, available on request or accessible at www.sgs.com/terms_and_conditions.htm and, for electronic format documents, subject to Terms and Conditions for Electronic Documents at www.sgs.com/terms_e-document.htm. Attention is drawn to the limitation of liability, indemnification and jurisdiction issues defined therein. Any holder of this document is advised that information contained hereon reflects the Company's findings at the time of its intervention only and within the limits of Client's instructions, if any. The Company's sole responsibility is to its Client and this document does not exonerate parties to a transaction from exercising all their rights and obligations under the transaction documents. This document cannot be reproduced except in full, without prior written approval of the Company. Any unauthorized alteration, forgery or falsification of the content or appearance of this document is unlawful and offenders may be prosecuted to the fullest extent of the law.

802.11n (5GHz)_40M MIMO-Main

| Frequency (MHz) | Bandwidth (kHz) | Limit (kHz) | Result |
|--------------------|--------------------|----------------|--------|
| 5755 | 36080 | > 500 | PASS |
| 5795 | 36080 | > 500 | PASS |

802.11n (5GHz)_40M MIMO-Aux

| Frequency (MHz) | Bandwidth (kHz) | Limit (kHz) | Result |
|--------------------|--------------------|----------------|--------|
| 5755 | 35770 | > 500 | PASS |
| 5795 | 35800 | > 500 | PASS |

* Note: Offset 11dB for 5G 802.11a; Offset 14.01dB for 5G 802.11n_20/n_40

* Note: The diamond reveals X decibel level

*Refer to next page for plots

Unless otherwise stated the results shown in this test report refer only to the sample(s) tested and such sample(s) are retained for 90 days only.

除非另有說明，此報告結果僅對測試之樣品負責，同時此樣品僅保留90天。本報告未經本公司書面許可，不可部份複製。

This document is issued by the Company subject to its General Conditions of Service printed overleaf, available on request or accessible at www.sgs.com/terms_and_conditions.htm and, for electronic format documents, subject to Terms and Conditions for Electronic Documents at www.sgs.com/terms_e-document.htm. Attention is drawn to the limitation of liability, indemnification and jurisdiction issues defined therein. Any holder of this document is advised that information contained hereon reflects the Company's findings at the time of its intervention only and within the limits of Client's instructions, if any. The Company's sole responsibility is to its Client and this document does not exonerate parties to a transaction from exercising all their rights and obligations under the transaction documents. This document cannot be reproduced except in full, without prior written approval of the Company. Any unauthorized alteration, forgery or falsification of the content or appearance of this document is unlawful and offenders may be prosecuted to the fullest extent of the law.

SGS Taiwan Ltd.

No.134,WuKungRoad,NewTaipeiIndustrialPark,WukuDistrict,NewTaipeiCity,Taiwan24803/新北市五股區新北產業園區五工路 134 號

台灣檢驗科技股份有限公司

t (886-2) 2299-3279

f (886-2) 2298-0488

www.tw.sgs.com

Member of SGS Group

802.11a

6dB Band Width Test Data CH-Low

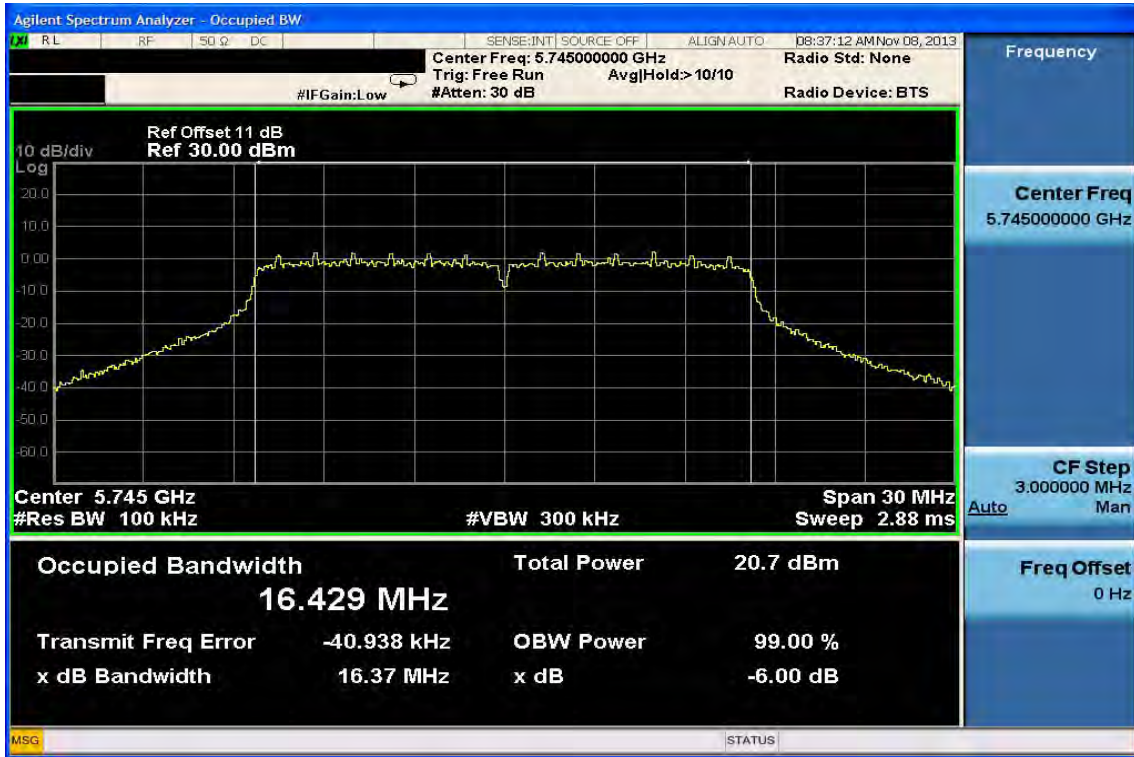

6dB Band Width Test Data CH-Mid

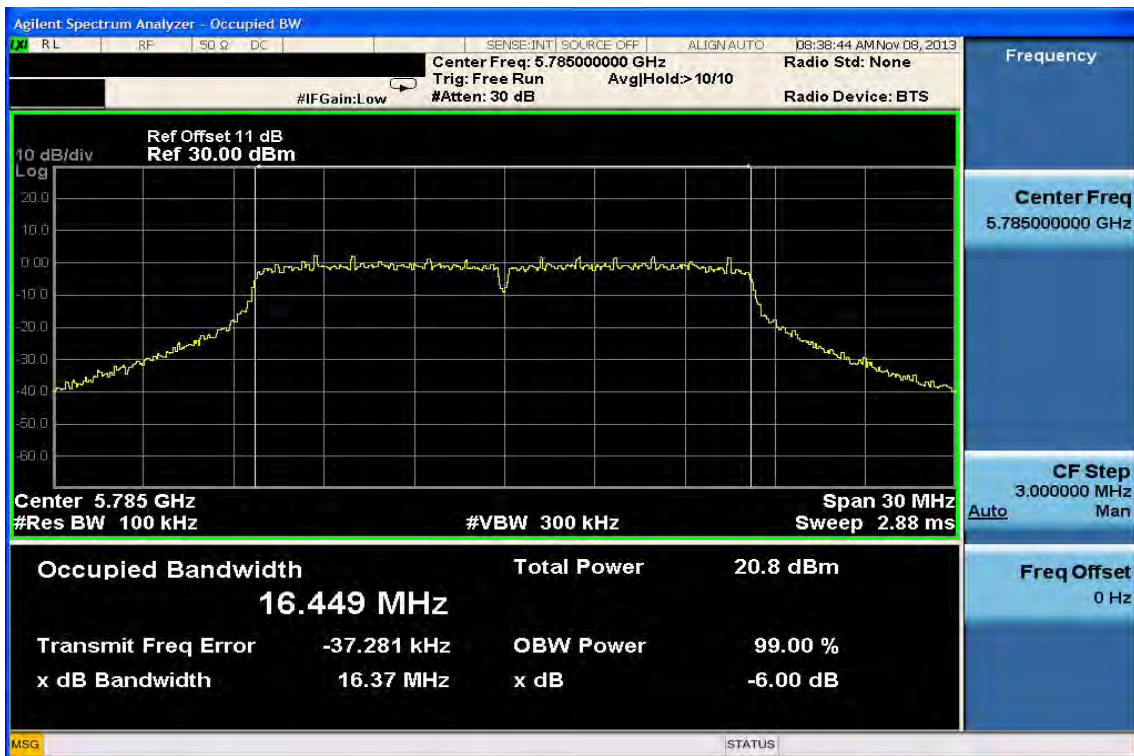

Unless otherwise stated the results shown in this test report refer only to the sample(s) tested and such sample(s) are retained for 90 days only.

除非另有說明，此報告結果僅對測試之樣品負責，同時此樣品僅保留90天。本報告未經本公司書面許可，不可部份複製。

This document is issued by the Company subject to its General Conditions of Service printed overleaf, available on request or accessible at www.sgs.com/terms_and_conditions.htm and, for electronic format documents, subject to Terms and Conditions for Electronic Documents at www.sgs.com/terms_e-document.htm. Attention is drawn to the limitation of liability, indemnification and jurisdiction issues defined therein. Any holder of this document is advised that information contained hereon reflects the Company's findings at the time of its intervention only and within the limits of Client's instructions, if any. The Company's sole responsibility is to its Client and this document does not exonerate parties to a transaction from exercising all their rights and obligations under the transaction documents. This document cannot be reproduced except in full, without prior written approval of the Company. Any unauthorized alteration, forgery or falsification of the content or appearance of this document is unlawful and offenders may be prosecuted to the fullest extent of the law.

SGS Taiwan Ltd.

No. 134, WuKungRoad, NewTaipeiIndustrialPark, WukuDistrict, NewTaipeiCity, Taiwan24803/新北市五股區新北產業園區五工路 134 號

台灣檢驗科技股份有限公司

t (886-2) 2299-3279

f (886-2) 2298-0488

www.tw.sgs.com

Member of SGS Group

6dB Band Width Test Data CH-High

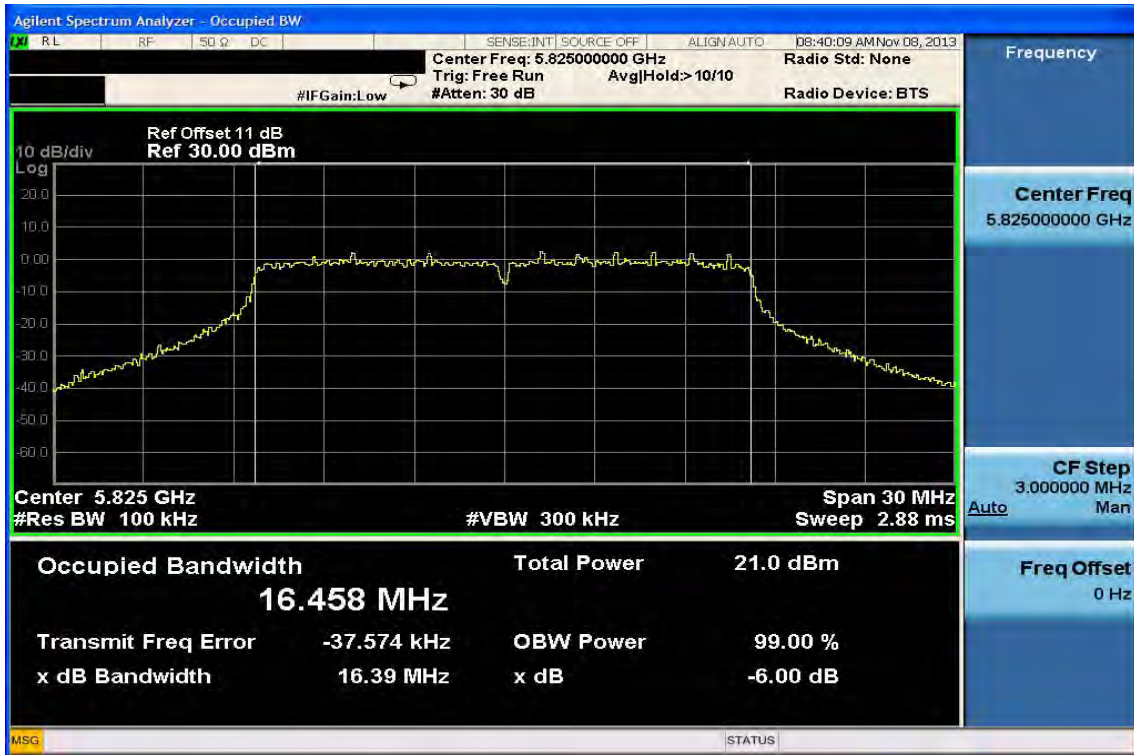

802.11n (5GHz)_20M MIMO-Main

6dB Band Width Test Data CH-Low

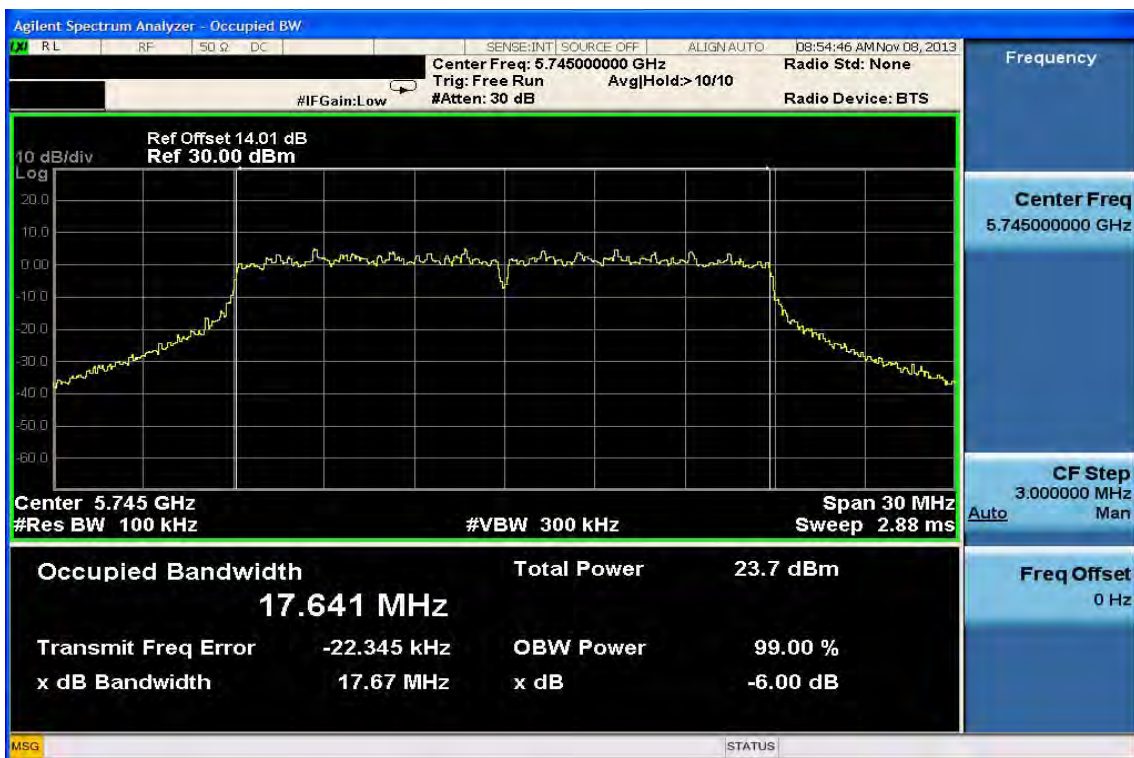

Unless otherwise stated the results shown in this test report refer only to the sample(s) tested and such sample(s) are retained for 90 days only.

除非另有說明，此報告結果僅對測試之樣品負責，同時此樣品僅保留90天。本報告未經本公司書面許可，不可部份複製。

This document is issued by the Company subject to its General Conditions of Service printed overleaf, available on request or accessible at www.sgs.com/terms_and_conditions.htm and, for electronic format documents, subject to Terms and Conditions for Electronic Documents at www.sgs.com/terms_e-document.htm. Attention is drawn to the limitation of liability, indemnification and jurisdiction issues defined therein. Any holder of this document is advised that information contained hereon reflects the Company's findings at the time of its intervention only and within the limits of Client's instructions, if any. The Company's sole responsibility is to its Client and this document does not exonerate parties to a transaction from exercising all their rights and obligations under the transaction documents. This document cannot be reproduced except in full, without prior written approval of the Company. Any unauthorized alteration, forgery or falsification of the content or appearance of this document is unlawful and offenders may be prosecuted to the fullest extent of the law.

SGS Taiwan Ltd.

No. 134, WuKungRoad, NewTaipeiIndustrialPark, WukuDistrict, NewTaipeiCity, Taiwan24803/新北市五股區新北產業園區五工路 134 號

台灣檢驗科技股份有限公司

t (886-2) 2299-3279

f (886-2) 2298-0488

www.tw.sgs.com

Member of SGS Group

6dB Band Width Test Data CH-Mid

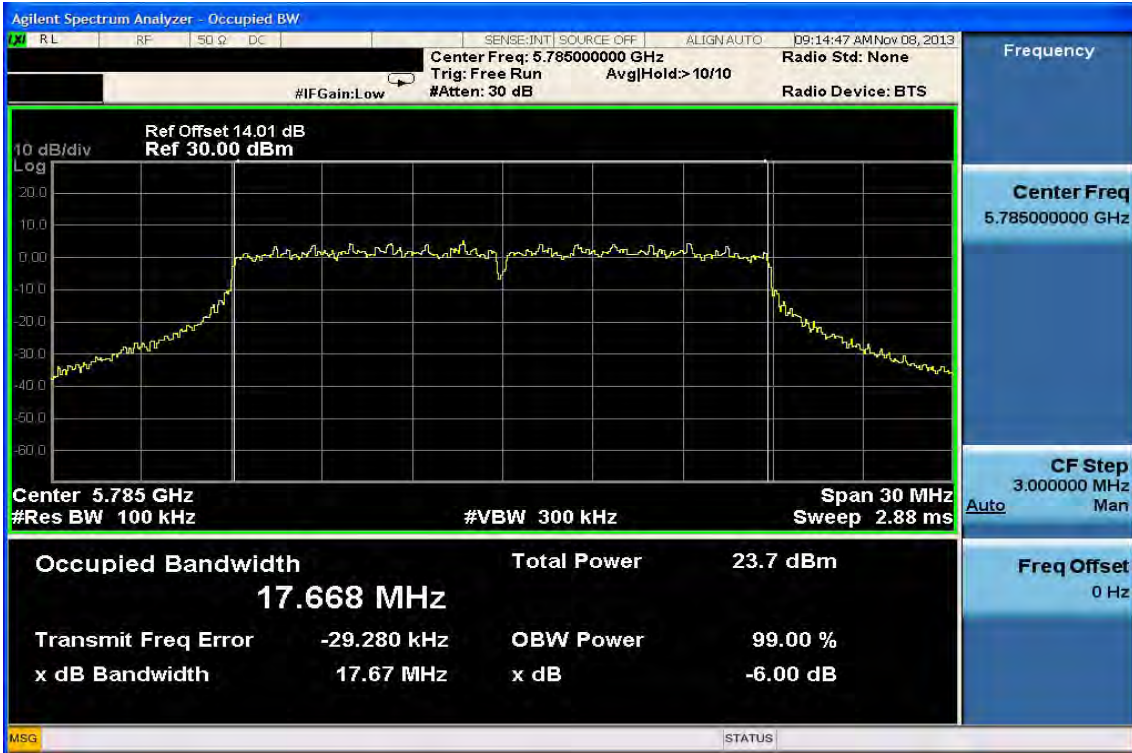

6dB Band Width Test Data CH-High

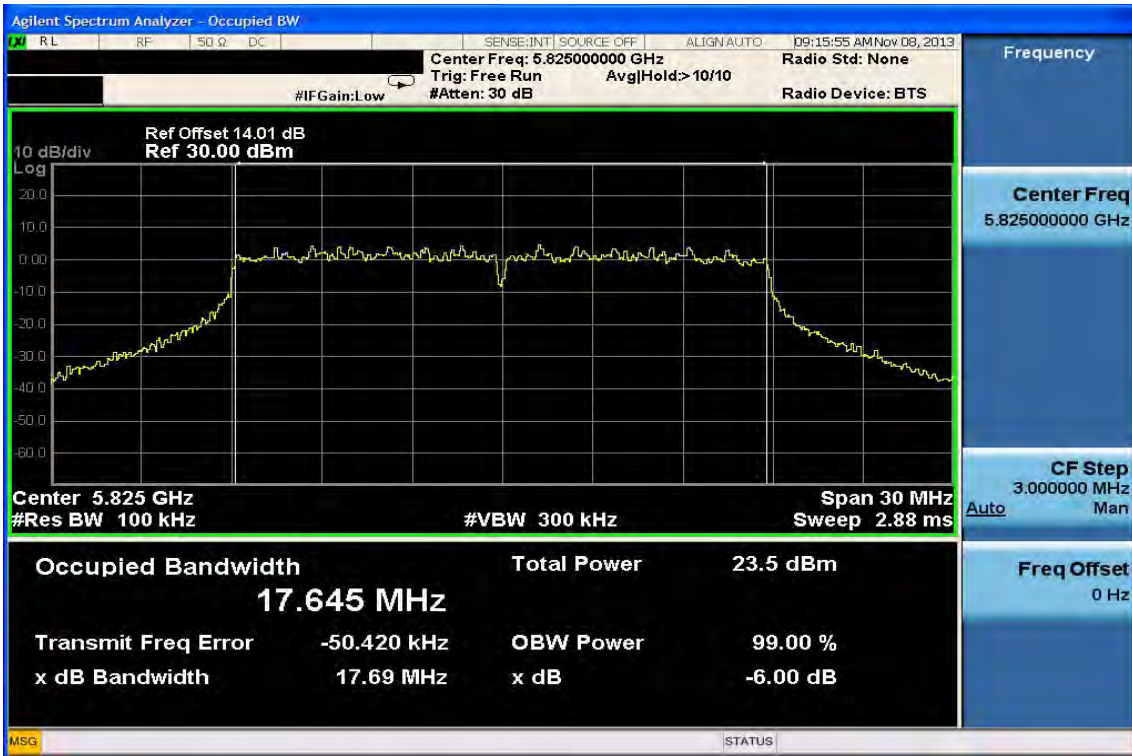

Unless otherwise stated the results shown in this test report refer only to the sample(s) tested and such sample(s) are retained for 90 days only.

除非另有說明，此報告結果僅對測試之樣品負責，同時此樣品僅保留90天。本報告未經本公司書面許可，不可部份複製。

This document is issued by the Company subject to its General Conditions of Service printed overleaf, available on request or accessible at www.sgs.com/terms_and_conditions.htm and, for electronic format documents, subject to Terms and Conditions for Electronic Documents at www.sgs.com/terms_e-document.htm. Attention is drawn to the limitation of liability, indemnification and jurisdiction issues defined therein. Any holder of this document is advised that information contained hereon reflects the Company's findings at the time of its intervention only and within the limits of Client's instructions, if any. The Company's sole responsibility is to its Client and this document does not exonerate parties to a transaction from exercising all their rights and obligations under the transaction documents. This document cannot be reproduced except in full, without prior written approval of the Company. Any unauthorized alteration, forgery or falsification of the content or appearance of this document is unlawful and offenders may be prosecuted to the fullest extent of the law.

SGS Taiwan Ltd.

No. 134, WuKungRoad, NewTaipeiIndustrialPark, WukuDistrict, NewTaipeiCity, Taiwan24803/新北市五股區新北產業園區五工路 134 號

台灣檢驗科技股份有限公司

t (886-2) 2299-3279

f (886-2) 2298-0488

www.tw.sgs.com

Member of SGS Group

802.11n (5GHz)_20M MIMO-Aux
6dB Band Width Test Data CH-Low

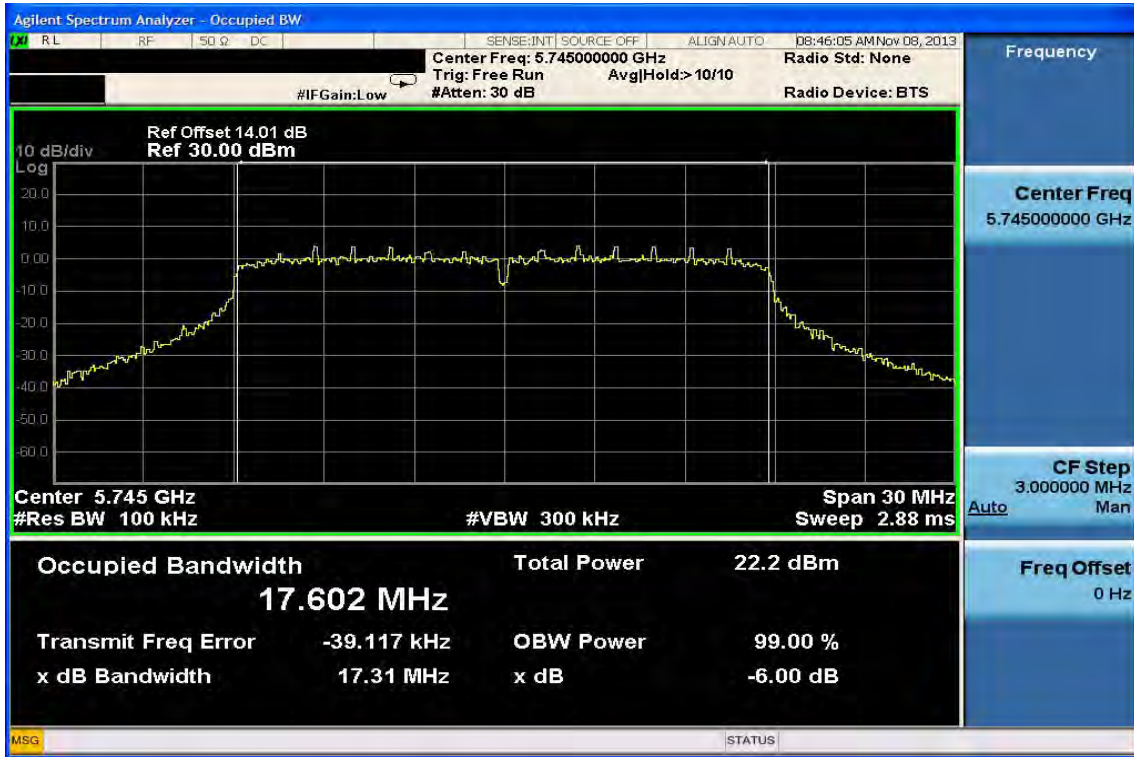

6dB Band Width Test Data CH-Mid

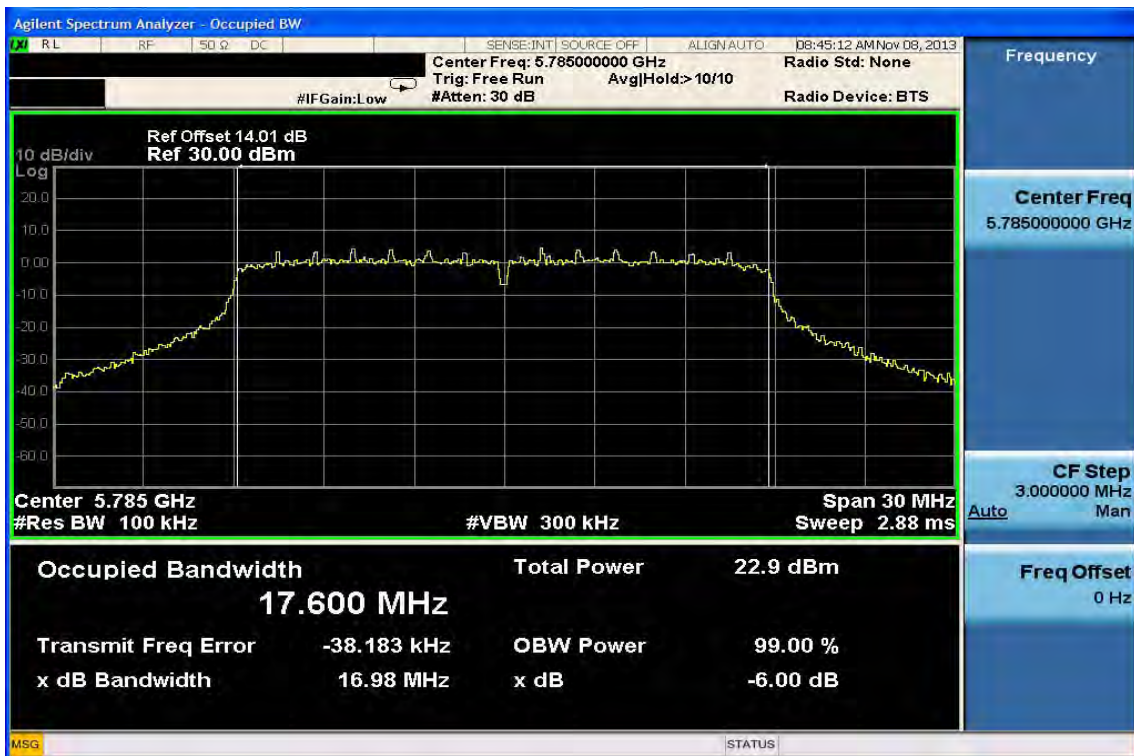

Unless otherwise stated the results shown in this test report refer only to the sample(s) tested and such sample(s) are retained for 90 days only.
除非另有說明，此報告結果僅對測試之樣品負責，同時此樣品僅保留90天。本報告未經本公司書面許可，不可部份複製。

This document is issued by the Company subject to its General Conditions of Service printed overleaf, available on request or accessible at www.sgs.com/terms_and_conditions.htm and, for electronic format documents, subject to Terms and Conditions for Electronic Documents at www.sgs.com/terms_e-document.htm. Attention is drawn to the limitation of liability, indemnification and jurisdiction issues defined therein. Any holder of this document is advised that information contained hereon reflects the Company's findings at the time of its intervention only and within the limits of Client's instructions, if any. The Company's sole responsibility is to its Client and this document does not exonerate parties to a transaction from exercising all their rights and obligations under the transaction documents. This document cannot be reproduced except in full, without prior written approval of the Company. Any unauthorized alteration, forgery or falsification of the content or appearance of this document is unlawful and offenders may be prosecuted to the fullest extent of the law.

6dB Band Width Test Data CH-High

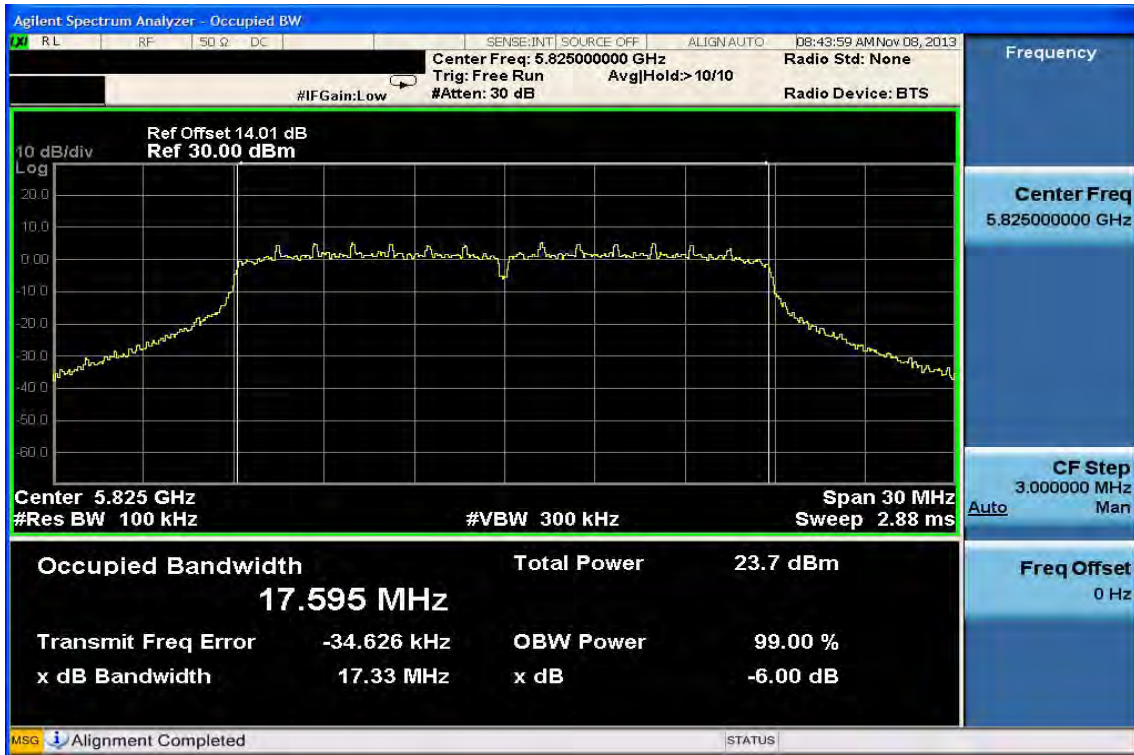

802.11n (5GHz)_40M MIMO-Main

6dB Band Width Test Data CH-Low



Unless otherwise stated the results shown in this test report refer only to the sample(s) tested and such sample(s) are retained for 90 days only.

除非另有說明，此報告結果僅對測試之樣品負責，同時此樣品僅保留90天。本報告未經本公司書面許可，不可部份複製。

This document is issued by the Company subject to its General Conditions of Service printed overleaf, available on request or accessible at www.sgs.com/terms_and_conditions.htm and, for electronic format documents, subject to Terms and Conditions for Electronic Documents at www.sgs.com/terms_e-document.htm. Attention is drawn to the limitation of liability, indemnification and jurisdiction issues defined therein. Any holder of this document is advised that information contained hereon reflects the Company's findings at the time of its intervention only and within the limits of Client's instructions, if any. The Company's sole responsibility is to its Client and this document does not exonerate parties to a transaction from exercising all their rights and obligations under the transaction documents. This document cannot be reproduced except in full, without prior written approval of the Company. Any unauthorized alteration, forgery or falsification of the content or appearance of this document is unlawful and offenders may be prosecuted to the fullest extent of the law.

SGS Taiwan Ltd.

No. 134, WuKungRoad, NewTaipeiIndustrialPark, WukuDistrict, NewTaipeiCity, Taiwan24803/新北市五股區新北產業園區五工路 134 號

台灣檢驗科技股份有限公司

t (886-2) 2299-3279

f (886-2) 2298-0488

www.tw.sgs.com

Member of SGS Group

6dB Band Width Test Data CH-High

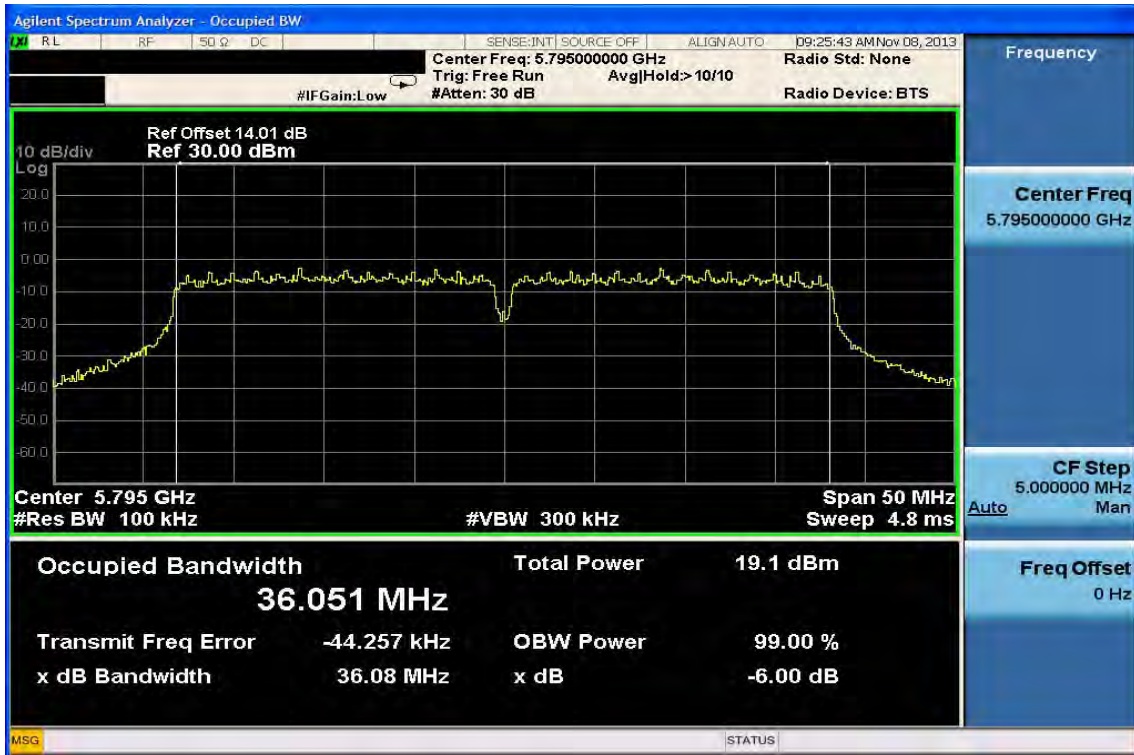

802.11n (5GHz)_40M MIMO-Aux

6dB Band Width Test Data CH-Low

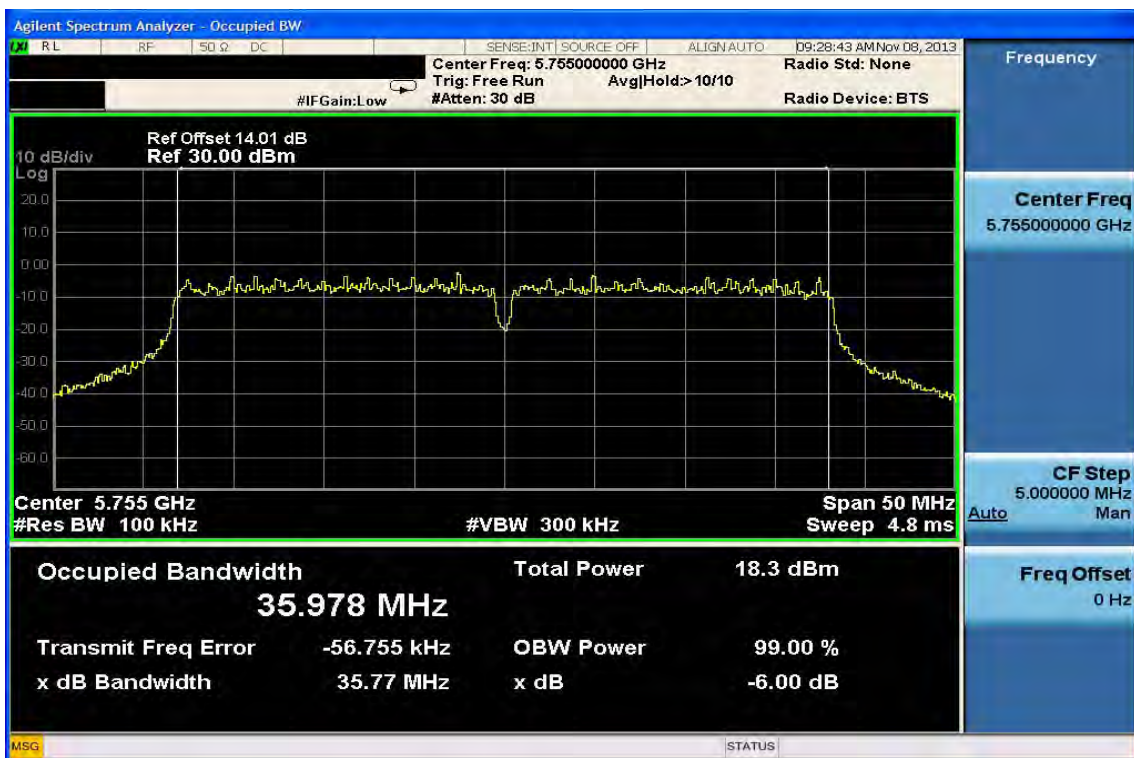

Unless otherwise stated the results shown in this test report refer only to the sample(s) tested and such sample(s) are retained for 90 days only.

除非另有說明，此報告結果僅對測試之樣品負責，同時此樣品僅保留90天。本報告未經本公司書面許可，不可部份複製。

This document is issued by the Company subject to its General Conditions of Service printed overleaf, available on request or accessible at www.sgs.com/terms_and_conditions.htm and, for electronic format documents, subject to Terms and Conditions for Electronic Documents at www.sgs.com/terms_e-document.htm. Attention is drawn to the limitation of liability, indemnification and jurisdiction issues defined therein. Any holder of this document is advised that information contained hereon reflects the Company's findings at the time of its intervention only and within the limits of Client's instructions, if any. The Company's sole responsibility is to its Client and this document does not exonerate parties to a transaction from exercising all their rights and obligations under the transaction documents. This document cannot be reproduced except in full, without prior written approval of the Company. Any unauthorized alteration, forgery or falsification of the content or appearance of this document is unlawful and offenders may be prosecuted to the fullest extent of the law.

SGS Taiwan Ltd.

No. 134, WuKungRoad, NewTaipeiIndustrialPark, WukuDistrict, NewTaipeiCity, Taiwan24803/新北市五股區新北產業園區五工路 134 號

台灣檢驗科技股份有限公司

t (886-2) 2299-3279

f (886-2) 2298-0488

www.tw.sgs.com

Member of SGS Group

6dB Band Width Test Data CH-High

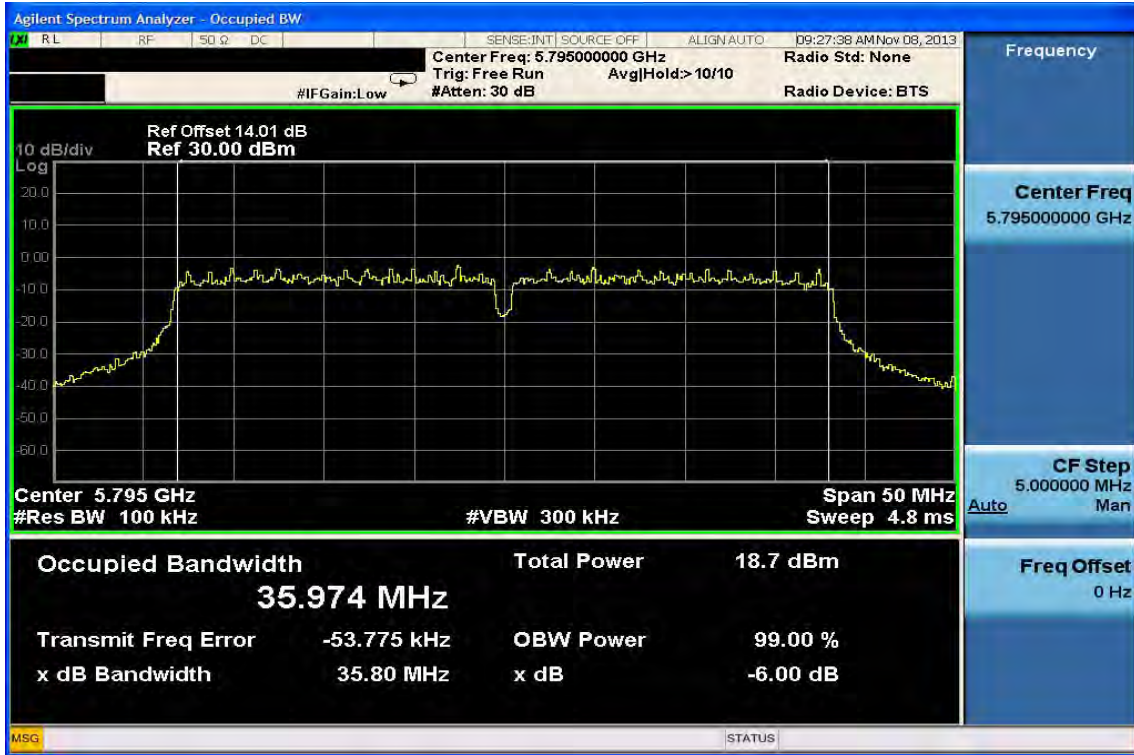

Unless otherwise stated the results shown in this test report refer only to the sample(s) tested and such sample(s) are retained for 90 days only.

除非另有說明，此報告結果僅對測試之樣品負責，同時此樣品僅保留90天。本報告未經本公司書面許可，不可部份複製。

This document is issued by the Company subject to its General Conditions of Service printed overleaf, available on request or accessible at www.sgs.com/terms_and_conditions.htm and, for electronic format documents, subject to Terms and Conditions for Electronic Documents at www.sgs.com/terms_e-document.htm. Attention is drawn to the limitation of liability, indemnification and jurisdiction issues defined therein. Any holder of this document is advised that information contained hereon reflects the Company's findings at the time of its intervention only and within the limits of Client's instructions, if any. The Company's sole responsibility is to its Client and this document does not exonerate parties to a transaction from exercising all their rights and obligations under the transaction documents. This document cannot be reproduced except in full, without prior written approval of the Company. Any unauthorized alteration, forgery or falsification of the content or appearance of this document is unlawful and offenders may be prosecuted to the fullest extent of the law.

SGS Taiwan Ltd.

No. 134, WuKungRoad, NewTaipeiIndustrialPark, WukuDistrict, NewTaipeiCity, Taiwan24803/新北市五股區新北產業園區五工路 134 號

台灣檢驗科技股份有限公司

t (886-2) 2299-3279

f (886-2) 2298-0488

www.tw.sgs.com

Member of SGS Group

9 BAND EDGES MEASUREMENT

9.1 Standard Applicable:

According to §15.247(d), in any 100 kHz bandwidth outside the frequency bands in which the spread spectrum intentional radiator is operating, the radio frequency power that is produced by the intentional radiator shall be at least 20dB below that in the 100 kHz bandwidth within the band that contains the highest level of the desired power. In addition, radiated emissions which fall in the restricted bands, as defined in §15.205(a), must also comply with the radiated emission limits specified in 15.209(a).

According to RSS-Gen §7.2.5 and RSS-210 issue 8, §A8.5, In any 100 kHz bandwidth outside the frequency band in which the spread spectrum or digitally modulated device is operating, the radio frequency power that is produced shall be at least 20 dB below that in the 100 kHz bandwidth within the band that contains the highest level of the desired power, based on either an RF conducted or a radiated measurement, provided the transmitter demonstrates compliance with the peak conducted power limits. If the transmitter complies with the conducted power limits based on the use of RMS averaging over a time interval, as permitted under section A8.4(4), the attenuation required shall be 30 dB instead of 20 dB. Attenuation below the general limits specified in Tables 5 and 6 is not required. In addition, radiated emissions which fall in the restricted bands of Table 3 must also comply with the radiated emission limits specified in Tables 5 and 6.

9.2 Measurement Equipment Used:

9.2.1 Conducted Emission at antenna port:

Refer to section 7.2 for details.

Unless otherwise stated the results shown in this test report refer only to the sample(s) tested and such sample(s) are retained for 90 days only.

除非另有說明，此報告結果僅對測試之樣品負責，同時此樣品僅保留90天。本報告未經本公司書面許可，不可部份複製。

This document is issued by the Company subject to its General Conditions of Service printed overleaf, available on request or accessible at www.sgs.com/terms_and_conditions.htm and, for electronic format documents, subject to Terms and Conditions for Electronic Documents at www.sgs.com/terms_e-document.htm. Attention is drawn to the limitation of liability, indemnification and jurisdiction issues defined therein. Any holder of this document is advised that information contained hereon reflects the Company's findings at the time of its intervention only and within the limits of Client's instructions, if any. The Company's sole responsibility is to its Client and this document does not exonerate parties to a transaction from exercising all their rights and obligations under the transaction documents. This document cannot be reproduced except in full, without prior written approval of the Company. Any unauthorized alteration, forgery or falsification of the content or appearance of this document is unlawful and offenders may be prosecuted to the fullest extent of the law.

SGS Taiwan Ltd.

台灣檢驗科技股份有限公司

No.134,WuKungRoad,NewTaipeiIndustrialPark,WukuDistrict,NewTaipeiCity,Taiwan24803/新北市五股區新北產業園區五工路 134 號

t (886-2) 2299-3279

f (886-2) 2298-0488

www.tw.sgs.com

Member of SGS Group

9.2.2 Radiated emission:

966 Chamber

| Name of Equipment | Manufacturer | Model | Serial Number | Calibration Date | Calibration Due |
|-------------------|----------------------|------------------------|------------------|------------------|-----------------|
| EMI Test Receiver | R&S | ESU 40 | 100363 | 01/30/2013 | 01/29/2014 |
| Broadband Antenna | TESEQ | CBL 6112D | 35240 | 02/04/2013 | 02/03/2014 |
| Horn Antenna | ETS-Lindgren | 3117 | 00143272 | 01/16/2013 | 01/15/2014 |
| Horn Antenna | ETS-Lindgren | 3160-09 | 00117911 | 02/14/2013 | 02/13/2014 |
| Pre-Amplifier | R&S | SCU-18 | 10203 | 01/21/2013 | 01/20/2014 |
| Pre-Amplifier | EM Electronics Corp. | EMC330 | 980096 | 01/04/2013 | 01/03/2014 |
| Pre-Amplifier | EM Electronics Corp. | EMC184045 | 980135 | 01/28/2013 | 01/27/2014 |
| Coaxial Cable | Huber+Suhner | SAC-C TX-30M-1GHz | TX1 | 04/22/2013 | 04/21/2014 |
| Coaxial Cable | Huber+Suhner | SAC-C TX-1-26.5GHz | TX2 | 04/22/2013 | 04/21/2014 |
| Coaxial Cable | Huber+Suhner | SAC-C RX-150k-30MHz | RX1 | 04/22/2013 | 04/21/2014 |
| Coaxial Cable | Huber+Suhner | SAC-C RX-30M-1GHz | RX2 | 04/22/2013 | 04/21/2014 |
| Coaxial Cable | Huber+Suhner | SAC-C RX-1-26.5GHz | RX3 | 04/22/2013 | 04/21/2014 |
| Controller | Chance Most | 886 | N/A | N.C.R. | N.C.R. |
| Antenna Master | Chance Most | N/A | N/A | N.C.R. | N.C.R. |
| Turn Table | Chance Most | N/A | N/A | N.C.R. | N.C.R. |
| Filter Bank | R&S | TS8996 | SCIN.EMC.1023.12 | 04/22/2013 | 04/21/2014 |
| Test Software | World-Pallas | Dr. E | V 3.0 Lite | N.C.R. | N.C.R. |

Unless otherwise stated the results shown in this test report refer only to the sample(s) tested and such sample(s) are retained for 90 days only.

除非另有說明，此報告結果僅對測試之樣品負責，同時此樣品僅保留90天。本報告未經本公司書面許可，不可部份複製。

This document is issued by the Company subject to its General Conditions of Service printed overleaf, available on request or accessible at www.sgs.com/terms_and_conditions.htm and, for electronic format documents, subject to Terms and Conditions for Electronic Documents at www.sgs.com/terms_e-document.htm. Attention is drawn to the limitation of liability, indemnification and jurisdiction issues defined therein. Any holder of this document is advised that information contained hereon reflects the Company's findings at the time of its intervention only and within the limits of Client's instructions, if any. The Company's sole responsibility is to its Client and this document does not exonerate parties to a transaction from exercising all their rights and obligations under the transaction documents. This document cannot be reproduced except in full, without prior written approval of the Company. Any unauthorized alteration, forgery or falsification of the content or appearance of this document is unlawful and offenders may be prosecuted to the fullest extent of the law.

SGS Taiwan Ltd.

No.134,WuKungRoad,NewTaipeiIndustrialPark,WukuDistrict,NewTaipeiCity,Taiwan24803/新北市五股區新北產業園區五工路 134 號

台灣檢驗科技股份有限公司

t (886-2) 2299-3279

f (886-2) 2298-0488

www.tw.sgs.com

Member of SGS Group

9.3 Test SET-UP:

9.3.1 Conducted Emission at antenna port:

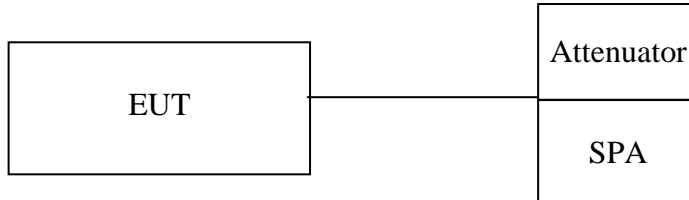

9.3.2 Radiated emission:

(A) Radiated Emission Test Set-Up, Frequency Below 1000MHz

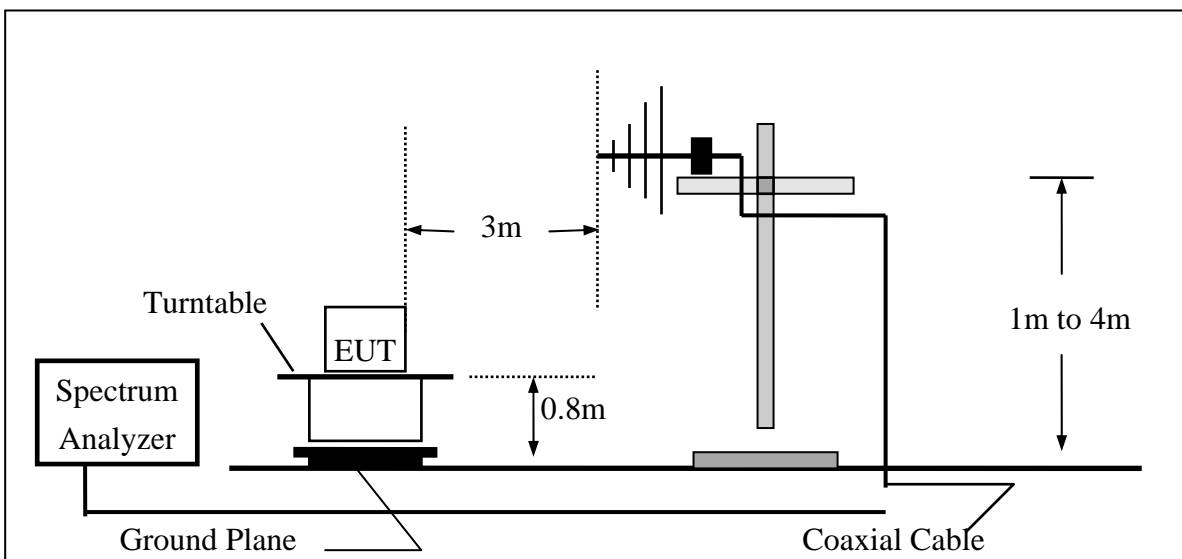

(B) Radiated Emission Test Set-UP Frequency Over 1 GHz

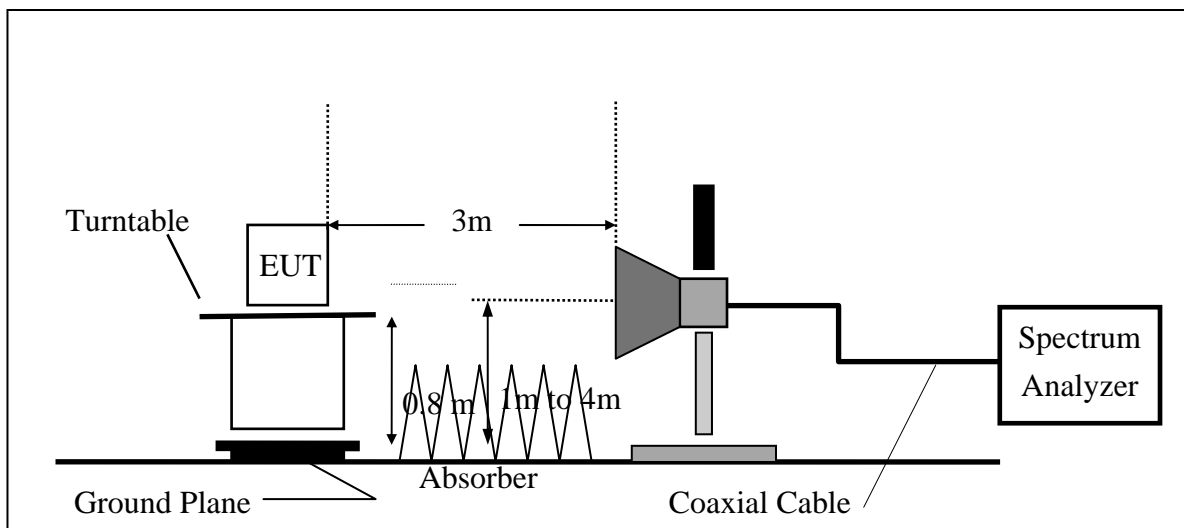

Unless otherwise stated the results shown in this test report refer only to the sample(s) tested and such sample(s) are retained for 90 days only.

除非另有說明，此報告結果僅對測試之樣品負責，同時此樣品僅保留90天。本報告未經本公司書面許可，不可部份複製。

This document is issued by the Company subject to its General Conditions of Service printed overleaf, available on request or accessible at www.sgs.com/terms_and_conditions.htm and, for electronic format documents, subject to Terms and Conditions for Electronic Documents at www.sgs.com/terms_e-document.htm. Attention is drawn to the limitation of liability, indemnification and jurisdiction issues defined therein. Any holder of this document is advised that information contained hereon reflects the Company's findings at the time of its intervention only and within the limits of Client's instructions, if any. The Company's sole responsibility is to its Client and this document does not exonerate parties to a transaction from exercising all their rights and obligations under the transaction documents. This document cannot be reproduced except in full, without prior written approval of the Company. Any unauthorized alteration, forgery or falsification of the content or appearance of this document is unlawful and offenders may be prosecuted to the fullest extent of the law.

9.4 Measurement Procedure:

Unwanted Emissions into Non-Restricted Frequency Bands, Measurement Procedure followed by 11.1 of KDB558074 D01

1. Place the EUT on the table and set it in transmitting mode.
2. Remove the antenna from the EUT and then connect a low loss RF cable from the antenna port to the spectrum analyzer.
3. Set start to edge frequency, and stop frequency of spectrum analyzer so as to encompass the spectrum to be examined.
4. Set the spectrum analyzer as RBW, VBW=300KHz, Detector = Peak, Sweep = auto
5. Mark the highest reading of the emission as the reference level measurement.
6. Set DL as the limit = reading on marker 1 – 20dBm
7. Marker on frequency, 2.3999GHz and 2.4836GHz, and examine shall 100 KHz immediately outside the authorized (2400~2483.5) be attenuated by 20dB at least relative to the maximum emission of power.
8. Repeat above procedures until all default test channel (low, middle, and high) was complete.

Unwanted Emission falling into Restricted Frequency Bands, Measurement Procedure followed by 12.1 of KDB558074 D01

1. The EUT was placed on a turn table which is 0.8m above ground plane.
2. The turn table shall rotate 360 degrees to determine the position of maximum emission level.
3. EUT is set 3m away from the receiving antenna which varied from 1m to 4m to find out the highest emissions.
4. When measurement procedures for electric field radiated emissions above 1 GHz the EUT measurement is to be made “while keeping the antenna in the ‘cone of radiation’ from that area and pointed at the area both in azimuth and elevation, with polarization oriented for maximum response.” is still within the 3dB illumination BW of the measurement antenna.
5. Maximum procedure was performed on the six highest emissions to ensure EUT compliance.
6. And also, each emission was to be maximized by changing the polarization of receiving antenna both horizontal and vertical.
7. On spectrum, following 8.1.2, and RBW = 1MHz, VBW = 3MHz, & Marker 2390MHz, and 2483.5MHz (Peak Measurement). Average Measurement: following 8.2 with the modification span to 1MHz, & RBW = 1MHz, VBW = 3MHz and peak marker function to obtain the highest reading on 2390, and 2483.5MHz.
8. Repeat above procedures until all default test channel (low, middle, and high) was complete

Unless otherwise stated the results shown in this test report refer only to the sample(s) tested and such sample(s) are retained for 90 days only.

除非另有說明，此報告結果僅對測試之樣品負責，同時此樣品僅保留90天。本報告未經本公司書面許可，不可部份複製。

This document is issued by the Company subject to its General Conditions of Service printed overleaf, available on request or accessible at www.sgs.com/terms_and_conditions.htm and, for electronic format documents, subject to Terms and Conditions for Electronic Documents at www.sgs.com/terms_e-document.htm. Attention is drawn to the limitation of liability, indemnification and jurisdiction issues defined therein. Any holder of this document is advised that information contained hereon reflects the Company's findings at the time of its intervention only and within the limits of Client's instructions, if any. The Company's sole responsibility is to its Client and this document does not exonerate parties to a transaction from exercising all their rights and obligations under the transaction documents. This document cannot be reproduced except in full, without prior written approval of the Company. Any unauthorized alteration, forgery or falsification of the content or appearance of this document is unlawful and offenders may be prosecuted to the fullest extent of the law.

Note: For MIMO operation, directional gain and limit are subject to be varied as per 15.247 c)1)i)

Due to correlation of two transmitting signal antenna, directional gain = Gain + 10 Log (N) dBi is used in determination of total power being transmitting while MIMO mode is enabled.

For the measurement of MIMO operation complying with the conducted bandedge test item, Aux with 3dB offset on HT_20 and main with 3dB offset on HT_40 is measured out, and its corresponding resultant plot is captured, respectively. Following the higher emission generated by respective port while signal is being transmitted singularly, 3dB offset with higher value yields worsen and representative data. While measuring HT_20 at single transmission of Aux port, Aux is observed and test out to obtain worsen outcome. Likewise, HT_40 at Main results the worsen data while undertaking single transmission, and therefore offset 3dB would results worsen emission.

Note: Following “measure and add 10 Log (N)” as per KDB 662911 by adding 10 Log (N) on spectrum to measure the conducted emission at MIMO mode.

Offset = cable loss + attenuator + 10 log (N), where N is number of transmitting antenna. N=2 for this given application.

9.5 The Derivation of Limit of Compliance to Unwanted Emissions into Restricted Frequency

Bands

EIRP = the equivalent isotropic radiated power in dBm,

E = electric field strength in dBμV/m,

d = measurement distance in meters.

EIRP = E + 20log(d) – 104.8

Average: 54+20log(3)-104.8= -41.3

The field strength is calculated by adding the Antenna Factor and Cable Factor and subtracting the Amplifier Gain and Duty Cycle Correction Factor (if any) from the measured reading. The basic equation with a sample calculation is as follows:

$$FS = RA + AF + CL - AG$$

| | | |
|-------|------------------------|--|
| Where | FS = Field Strength | CL = Cable Attenuation Factor (Cable Loss) |
| | RA = Reading Amplitude | AG = Amplifier Gain |
| | AF = Antenna Factor | |

9.6 Measurement Result:

Note: Refer to next page spectrum analyzer data chart and tabular data sheets.

Unless otherwise stated the results shown in this test report refer only to the sample(s) tested and such sample(s) are retained for 90 days only.

除非另有說明，此報告結果僅對測試之樣品負責，同時此樣品僅保留90天。本報告未經本公司書面許可，不可部份複製。

This document is issued by the Company subject to its General Conditions of Service printed overleaf, available on request or accessible at www.sgs.com/terms_and_conditions.htm and, for electronic format documents, subject to Terms and Conditions for Electronic Documents at www.sgs.com/terms_e-document.htm. Attention is drawn to the limitation of liability, indemnification and jurisdiction issues defined therein. Any holder of this document is advised that information contained hereon reflects the Company's findings at the time of its intervention only and within the limits of Client's instructions, if any. The Company's sole responsibility is to its Client and this document does not exonerate parties to a transaction from exercising all their rights and obligations under the transaction documents. This document cannot be reproduced except in full, without prior written approval of the Company. Any unauthorized alteration, forgery or falsification of the content or appearance of this document is unlawful and offenders may be prosecuted to the fullest extent of the law.

802.11a - Unwanted Emissions into Non-Restricted Frequency Bands Band Edges Test Data CH-Low



Band Edges Test Data CH-High



Unless otherwise stated the results shown in this test report refer only to the sample(s) tested and such sample(s) are retained for 90 days only.
除非另有說明，此報告結果僅對測試之樣品負責，同時此樣品僅保留90天。本報告未經本公司書面許可，不可部份複製。

This document is issued by the Company subject to its General Conditions of Service printed overleaf, available on request or accessible at www.sgs.com/terms_and_conditions.htm and, for electronic format documents, subject to Terms and Conditions for Electronic Documents at www.sgs.com/terms_e-document.htm. Attention is drawn to the limitation of liability, indemnification and jurisdiction issues defined therein. Any holder of this document is advised that information contained hereon reflects the Company's findings at the time of its intervention only and within the limits of Client's instructions, if any. The Company's sole responsibility is to its Client and this document does not exonerate parties to a transaction from exercising all their rights and obligations under the transaction documents. This document cannot be reproduced except in full, without prior written approval of the Company. Any unauthorized alteration, forgery or falsification of the content or appearance of this document is unlawful and offenders may be prosecuted to the fullest extent of the law.

802.11n (5GHz)_20M - Unwanted Emissions into Non-Restricted Frequency Bands Band Edges Test Data CH-Low

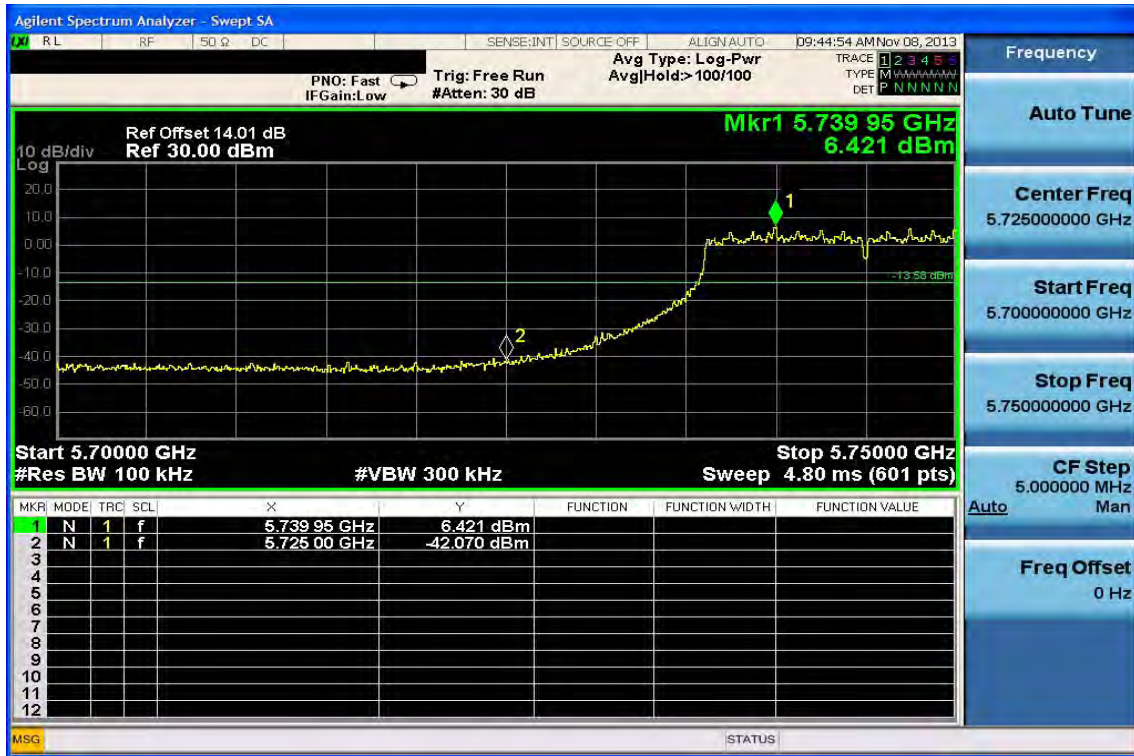

Band Edges Test Data CH-High



Unless otherwise stated the results shown in this test report refer only to the sample(s) tested and such sample(s) are retained for 90 days only.

除非另有說明，此報告結果僅對測試之樣品負責，同時此樣品僅保留90天。本報告未經本公司書面許可，不可部份複製。

This document is issued by the Company subject to its General Conditions of Service printed overleaf, available on request or accessible at www.sgs.com/terms_and_conditions.htm and, for electronic format documents, subject to Terms and Conditions for Electronic Documents at www.sgs.com/terms_e-document.htm. Attention is drawn to the limitation of liability, indemnification and jurisdiction issues defined therein. Any holder of this document is advised that information contained hereon reflects the Company's findings at the time of its intervention only and within the limits of Client's instructions, if any. The Company's sole responsibility is to its Client and this document does not exonerate parties to a transaction from exercising all their rights and obligations under the transaction documents. This document cannot be reproduced except in full, without prior written approval of the Company. Any unauthorized alteration, forgery or falsification of the content or appearance of this document is unlawful and offenders may be prosecuted to the fullest extent of the law.

802.11n (5GHz)_40M - Unwanted Emissions into Non-Restricted Frequency Bands Band Edges Test Data CH-Low

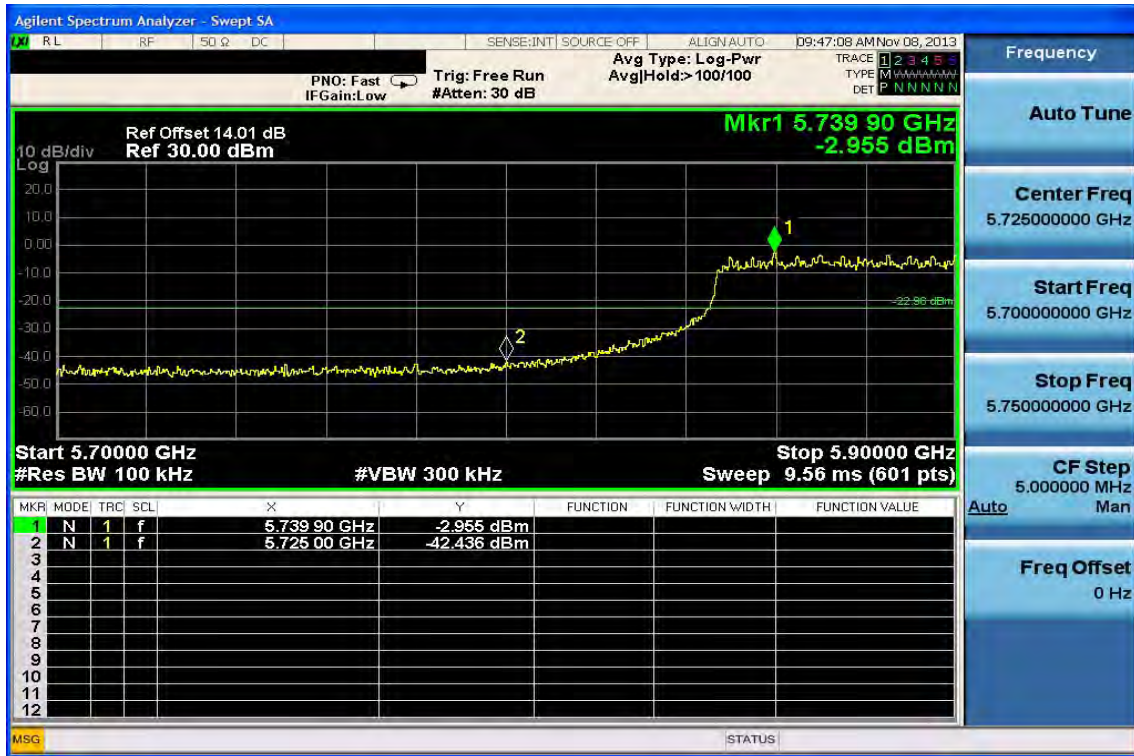

Band Edges Test Data CH-High



Unless otherwise stated the results shown in this test report refer only to the sample(s) tested and such sample(s) are retained for 90 days only.

除非另有說明，此報告結果僅對測試之樣品負責，同時此樣品僅保留90天。本報告未經本公司書面許可，不可部份複製。

This document is issued by the Company subject to its General Conditions of Service printed overleaf, available on request or accessible at www.sgs.com/terms_and_conditions.htm and, for electronic format documents, subject to Terms and Conditions for Electronic Documents at www.sgs.com/terms_e-document.htm. Attention is drawn to the limitation of liability, indemnification and jurisdiction issues defined therein. Any holder of this document is advised that information contained hereon reflects the Company's findings at the time of its intervention only and within the limits of Client's instructions, if any. The Company's sole responsibility is to its Client and this document does not exonerate parties to a transaction from exercising all their rights and obligations under the transaction documents. This document cannot be reproduced except in full, without prior written approval of the Company. Any unauthorized alteration, forgery or falsification of the content or appearance of this document is unlawful and offenders may be prosecuted to the fullest extent of the law.

SGS Taiwan Ltd.

No. 134, WuKungRoad, NewTaipeiIndustrialPark, WukuDistrict, NewTaipeiCity, Taiwan24803/新北市五股區新北產業園區五工路 134 號

台灣檢驗科技股份有限公司

t (886-2) 2299-3279

f (886-2) 2298-0488

www.tw.sgs.com

Member of SGS Group

10 SPURIOUS EMISSION TEST

10.1 Standard Applicable

According to §15.247(d),

Emission at antenna port:

In any 100 kHz bandwidth outside the frequency band in which the spread spectrum or digitally modulated intentional radiator is operating, the radio frequency power that is produced by the intentional radiator shall be at least 20 dB below that in the 100 kHz bandwidth within the band that contains the highest level of the desired power, based on either an RF conducted or a radiated measurement, provided the transmitter demonstrates compliance with the peak conducted power limits. If the transmitter complies with the conducted power limits based on the use of RMS averaging over a time interval, as permitted under paragraph (b)(3) of this section, the attenuation required under this paragraph shall be 30 dB instead of 20 dB.

Radiated Spurious Emission

Attenuation below the general limits specified in § 15.209(a) is not required. In addition, radiated emissions which fall in the restricted bands, as defined in § 15.205(a), must also comply with the radiated emission limits specified in § 15.209(a) (see § 15.205(c)).

And according to §15.33(a) (1), for an intentional radiator operates below 10GHz, the frequency range of measurements: to the tenth harmonic of the highest fundamental frequency or to 40GHz, whichever is lower.

According to RSS-Gen §7.2.5 and RSS-210 issue 8,§A8.5, In any 100 kHz bandwidth outside the frequency band in which the spread spectrum or digitally modulated device is operating, the radio frequency power that is produced shall be at least 20 dB below that in the 100 kHz bandwidth within the band that contains the highest level of the desired power, based on either an RF conducted or a radiated measurement, provided the transmitter demonstrates compliance with the peak conducted power limits. If the transmitter complies with the conducted power limits based on the use of RMS averaging over a time interval, as permitted under section A8.4(4), the attenuation required shall be 30 dB instead of 20 dB. Attenuation below the general limits specified in Tables 5 and 6 is not required. In addition, radiated emissions which fall in the restricted bands of Table 3 must also comply with the radiated emission limits specified in Tables 5 and 6 of RSS-GEN.

Unless otherwise stated the results shown in this test report refer only to the sample(s) tested and such sample(s) are retained for 90 days only.

除非另有說明，此報告結果僅對測試之樣品負責，同時此樣品僅保留90天。本報告未經本公司書面許可，不可部份複製。

This document is issued by the Company subject to its General Conditions of Service printed overleaf, available on request or accessible at www.sgs.com/terms_and_conditions.htm and, for electronic format documents, subject to Terms and Conditions for Electronic Documents at www.sgs.com/terms_e-document.htm. Attention is drawn to the limitation of liability, indemnification and jurisdiction issues defined therein. Any holder of this document is advised that information contained hereon reflects the Company's findings at the time of its intervention only and within the limits of Client's instructions, if any. The Company's sole responsibility is to its Client and this document does not exonerate parties to a transaction from exercising all their rights and obligations under the transaction documents. This document cannot be reproduced except in full, without prior written approval of the Company. Any unauthorized alteration, forgery or falsification of the content or appearance of this document is unlawful and offenders may be prosecuted to the fullest extent of the law.

SGS Taiwan Ltd.

No.134,WuKungRoad,NewTaipeiIndustrialPark,WukuDistrict,NewTaipeiCity,Taiwan24803/新北市五股區新北產業園區五工路 134 號

台灣檢驗科技股份有限公司

t (886-2) 2299-3279

f (886-2) 2298-0488

www.tw.sgs.com

Member of SGS Group

10.2 Measurement Equipment Used:

10.2.1 Conducted Emission at antenna port:

Refer to section 7.2 for details.

10.2.2 Radiated emission:

Refer to section 9.2.2 for details.

10.3 Test SET-UP:

10.3.1 Conducted Emission at antenna port:

Refer to section 7.3 for details.

10.3.2 Radiated emission:

Refer to section 9.3.2 for details.

Unless otherwise stated the results shown in this test report refer only to the sample(s) tested and such sample(s) are retained for 90 days only.

除非另有說明，此報告結果僅對測試之樣品負責，同時此樣品僅保留90天。本報告未經本公司書面許可，不可部份複製。

This document is issued by the Company subject to its General Conditions of Service printed overleaf, available on request or accessible at www.sgs.com/terms_and_conditions.htm and, for electronic format documents, subject to Terms and Conditions for Electronic Documents at www.sgs.com/terms_e-document.htm. Attention is drawn to the limitation of liability, indemnification and jurisdiction issues defined therein. Any holder of this document is advised that information contained hereon reflects the Company's findings at the time of its intervention only and within the limits of Client's instructions, if any. The Company's sole responsibility is to its Client and this document does not exonerate parties to a transaction from exercising all their rights and obligations under the transaction documents. This document cannot be reproduced except in full, without prior written approval of the Company. Any unauthorized alteration, forgery or falsification of the content or appearance of this document is unlawful and offenders may be prosecuted to the fullest extent of the law.

SGS Taiwan Ltd.

No.134,WuKungRoad,NewTaipeiIndustrialPark,WukuDistrict,NewTaipeiCity,Taiwan24803/新北市五股區新北產業園區五工路 134 號

台灣檢驗科技股份有限公司

t (886-2) 2299-3279

f (886-2) 2298-0488

www.tw.sgs.com

Member of SGS Group

10.4 Measurement Procedure:

Radiated Emission:

1. The EUT was placed on a turn table which is 0.8m above ground plane.
2. The turn table shall rotate 360 degrees to determine the position of maximum emission level.
3. EUT is set 3m away from the receiving antenna which varied from 1m to 4m to find out the highest emissions.
4. When measurement procedures for electric field radiated emissions above 1 GHz the EUT measurement is to be made “while keeping the antenna in the ‘cone of radiation’ from that area and pointed at the area both in azimuth and elevation, with polarization oriented for maximum response.” is still within the 3dB illumination BW of the measurement antenna.
5. Maximum procedure was performed on the six highest emissions to ensure EUT compliance.
6. And also, each emission was to be maximized by changing the polarization of receiving antenna both horizontal and vertical. On spectrum, change spectrum mode in linear display mode, and reduce VBW = 10Hz if average reading is measured.
7. Repeat above procedures until all default test channel measured were complete.

Conducted Emission:

1. To connect Antenna Port of EUT to Spectrum.
2. Set RBW = 100K & VBW = 300K on Spectrum.
3. Sweep the frequency to determine spurious emission as seen on spectrum from span of 30 to 3G, 3G to 8G, 8G to 13G, 13G to 18G and 18G to 26.5GHz, 18G to 40GHz (applicable if operation mode is 5GHz)
4. Via Software, combine 5 spans of frequency range into one plot
5. Repeat above procedures until all default test channel measured were complete.

Note: For MIMO operation, directional gain is not subjected to offset back as prescribe in KDB 662911 D01 for relative out-of-band measurement, including conducted bandedge falling into non-restricted frequency band.

Unless otherwise stated the results shown in this test report refer only to the sample(s) tested and such sample(s) are retained for 90 days only.

除非另有說明，此報告結果僅對測試之樣品負責，同時此樣品僅保留90天。本報告未經本公司書面許可，不可部份複製。

This document is issued by the Company subject to its General Conditions of Service printed overleaf, available on request or accessible at www.sgs.com/terms_and_conditions.htm and, for electronic format documents, subject to Terms and Conditions for Electronic Documents at www.sgs.com/terms_e-document.htm. Attention is drawn to the limitation of liability, indemnification and jurisdiction issues defined therein. Any holder of this document is advised that information contained hereon reflects the Company's findings at the time of its intervention only and within the limits of Client's instructions, if any. The Company's sole responsibility is to its Client and this document does not exonerate parties to a transaction from exercising all their rights and obligations under the transaction documents. This document cannot be reproduced except in full, without prior written approval of the Company. Any unauthorized alteration, forgery or falsification of the content or appearance of this document is unlawful and offenders may be prosecuted to the fullest extent of the law.

SGS Taiwan Ltd.

No.134,WuKungRoad,NewTaipeiIndustrialPark,WukuDistrict,NewTaipeiCity,Taiwan24803/新北市五股區新北產業園區五工路 134 號

台灣檢驗科技股份有限公司

t (886-2) 2299-3279

f (886-2) 2298-0488

www.tw.sgs.com

Member of SGS Group

10.5 Field Strength Calculation

The field strength is calculated by adding the Antenna Factor and Cable Factor and subtracting the Amplifier Gain and Duty Cycle Correction Factor (if any) from the measured reading. The basic equation with a sample calculation is as follows:

$$FS = RA + AF + CL - AG$$

| | | |
|-------|------------------------|--|
| Where | FS = Field Strength | CL = Cable Attenuation Factor (Cable Loss) |
| | RA = Reading Amplitude | AG = Amplifier Gain |
| | AF = Antenna Factor | |

10.6 Measurement Result:

Note: Refer to next page spectrum analyzer data chart and tabular data sheets.

Unless otherwise stated the results shown in this test report refer only to the sample(s) tested and such sample(s) are retained for 90 days only.

除非另有說明，此報告結果僅對測試之樣品負責，同時此樣品僅保留90天。本報告未經本公司書面許可，不可部份複製。

This document is issued by the Company subject to its General Conditions of Service printed overleaf, available on request or accessible at www.sgs.com/terms_and_conditions.htm and, for electronic format documents, subject to Terms and Conditions for Electronic Documents at www.sgs.com/terms_e-document.htm. Attention is drawn to the limitation of liability, indemnification and jurisdiction issues defined therein. Any holder of this document is advised that information contained hereon reflects the Company's findings at the time of its intervention only and within the limits of Client's instructions, if any. The Company's sole responsibility is to its Client and this document does not exonerate parties to a transaction from exercising all their rights and obligations under the transaction documents. This document cannot be reproduced except in full, without prior written approval of the Company. Any unauthorized alteration, forgery or falsification of the content or appearance of this document is unlawful and offenders may be prosecuted to the fullest extent of the law.

SGS Taiwan Ltd.

No.134,WuKungRoad,NewTaipeiIndustrialPark,WukuDistrict,NewTaipeiCity,Taiwan24803/新北市五股區新北產業園區五工路 134 號

台灣檢驗科技股份有限公司

t (886-2) 2299-3279

f (886-2) 2298-0488

www.tw.sgs.com

Member of SGS Group

Conducted Spurious Emission Measurement Result (802.11a) Ch Low 30MHz – 6GHz

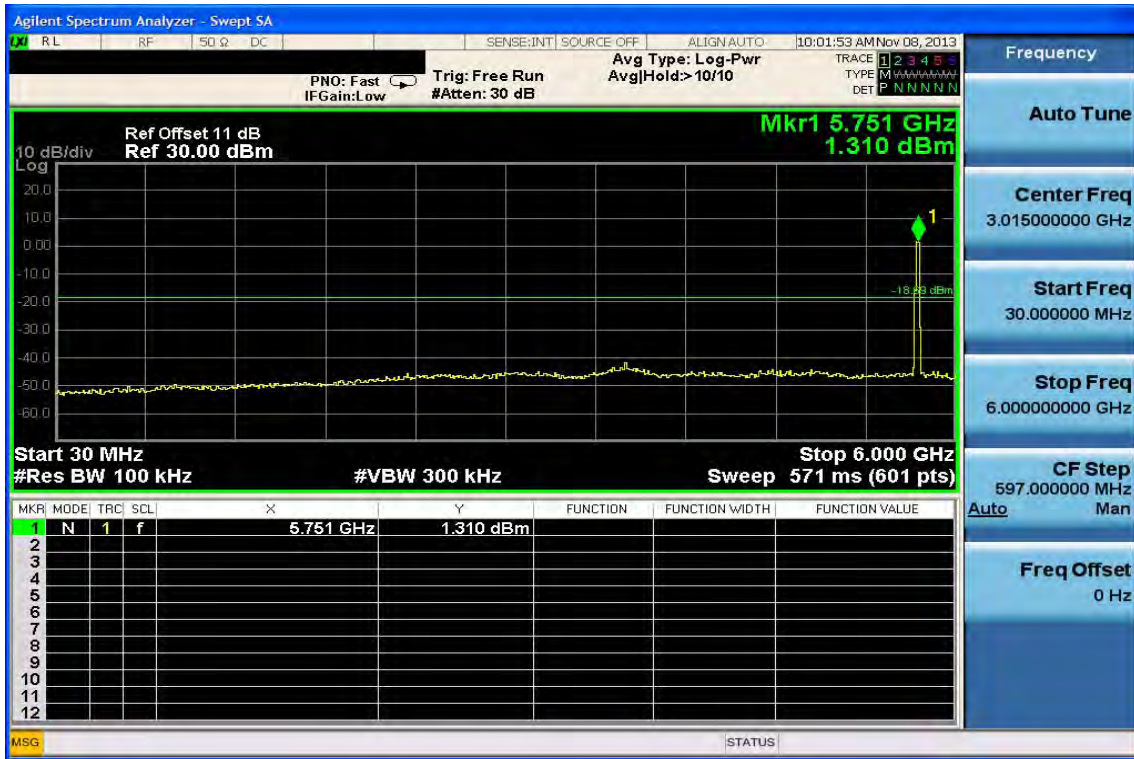

Ch Low 6GHz – 18GHz

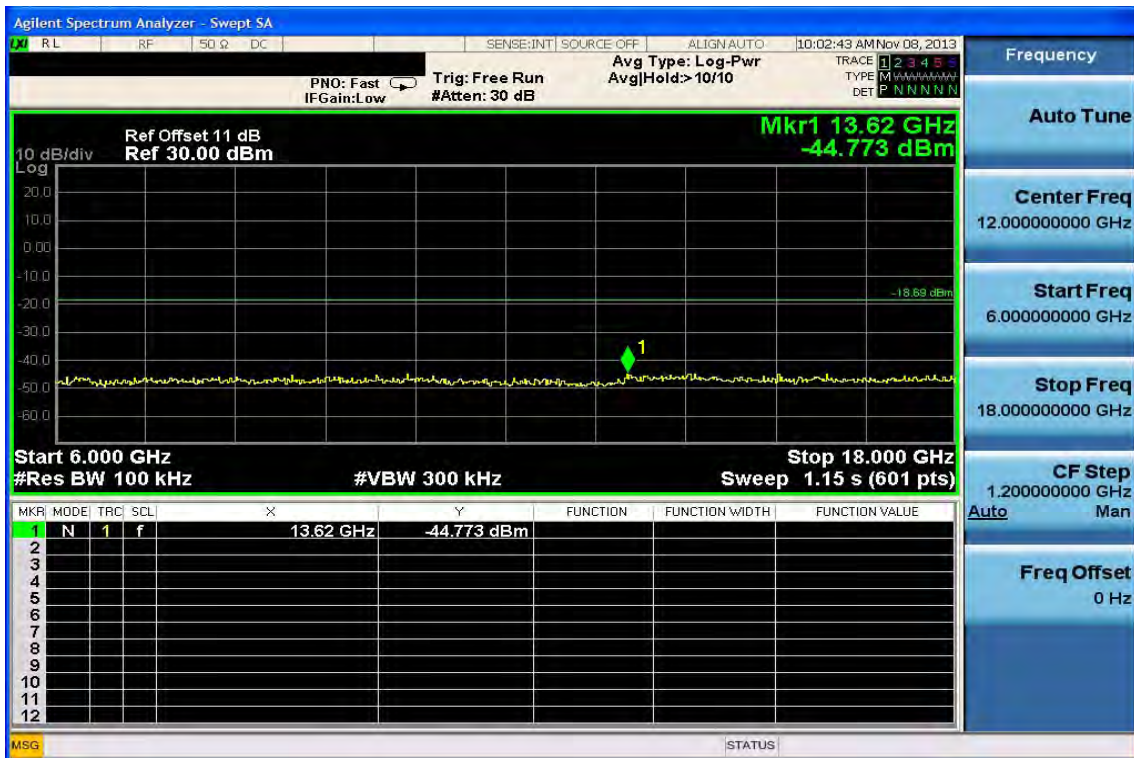

Unless otherwise stated the results shown in this test report refer only to the sample(s) tested and such sample(s) are retained for 90 days only.

除非另有說明，此報告結果僅對測試之樣品負責，同時此樣品僅保留90天。本報告未經本公司書面許可，不可部份複製。

This document is issued by the Company subject to its General Conditions of Service printed overleaf, available on request or accessible at www.sgs.com/terms_and_conditions.htm and, for electronic format documents, subject to Terms and Conditions for Electronic Documents at www.sgs.com/terms_e-document.htm. Attention is drawn to the limitation of liability, indemnification and jurisdiction issues defined therein. Any holder of this document is advised that information contained hereon reflects the Company's findings at the time of its intervention only and within the limits of Client's instructions, if any. The Company's sole responsibility is to its Client and this document does not exonerate parties to a transaction from exercising all their rights and obligations under the transaction documents. This document cannot be reproduced except in full, without prior written approval of the Company. Any unauthorized alteration, forgery or falsification of the content or appearance of this document is unlawful and offenders may be prosecuted to the fullest extent of the law.

Ch Low 18GHz – 40GHz

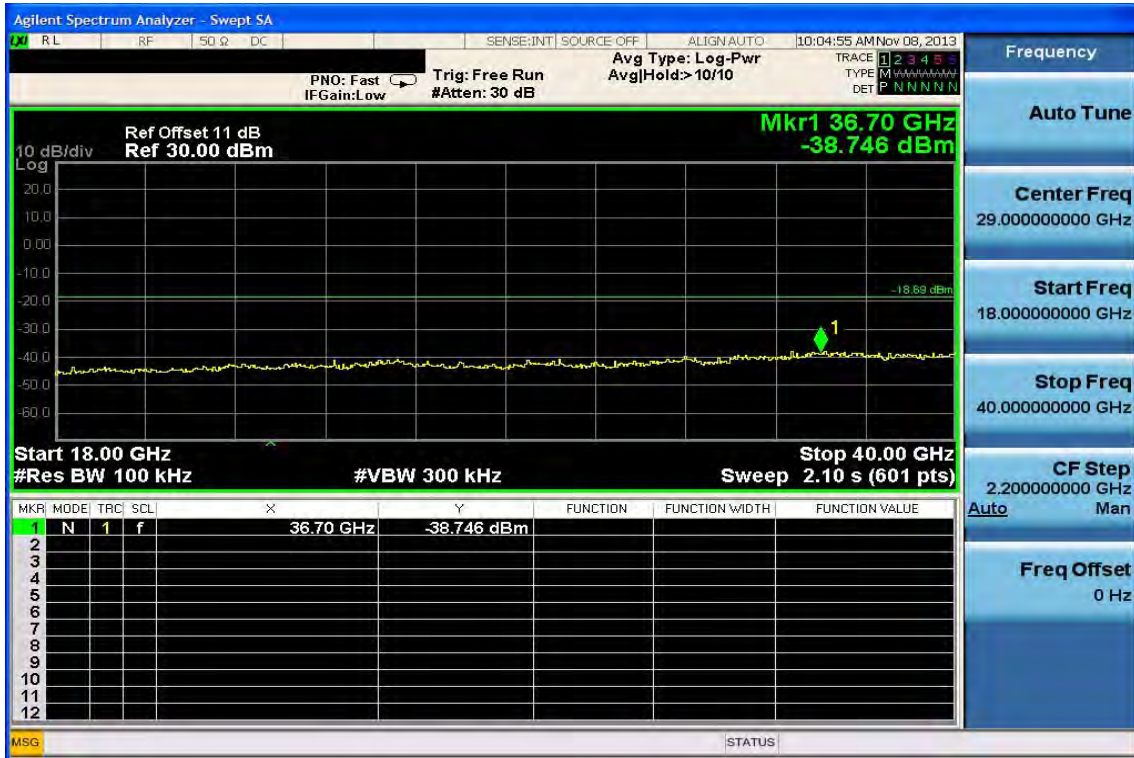

Ch Mid 30MHz – 6GHz



Unless otherwise stated the results shown in this test report refer only to the sample(s) tested and such sample(s) are retained for 90 days only.

除非另有說明，此報告結果僅對測試之樣品負責，同時此樣品僅保留90天。本報告未經本公司書面許可，不可部份複製。

This document is issued by the Company subject to its General Conditions of Service printed overleaf, available on request or accessible at www.sgs.com/terms_and_conditions.htm and, for electronic format documents, subject to Terms and Conditions for Electronic Documents at www.sgs.com/terms_e-document.htm. Attention is drawn to the limitation of liability, indemnification and jurisdiction issues defined therein. Any holder of this document is advised that information contained hereon reflects the Company's findings at the time of its intervention only and within the limits of Client's instructions, if any. The Company's sole responsibility is to its Client and this document does not exonerate parties to a transaction from exercising all their rights and obligations under the transaction documents. This document cannot be reproduced except in full, without prior written approval of the Company. Any unauthorized alteration, forgery or falsification of the content or appearance of this document is unlawful and offenders may be prosecuted to the fullest extent of the law.

Ch Mid 6GHz – 18GHz

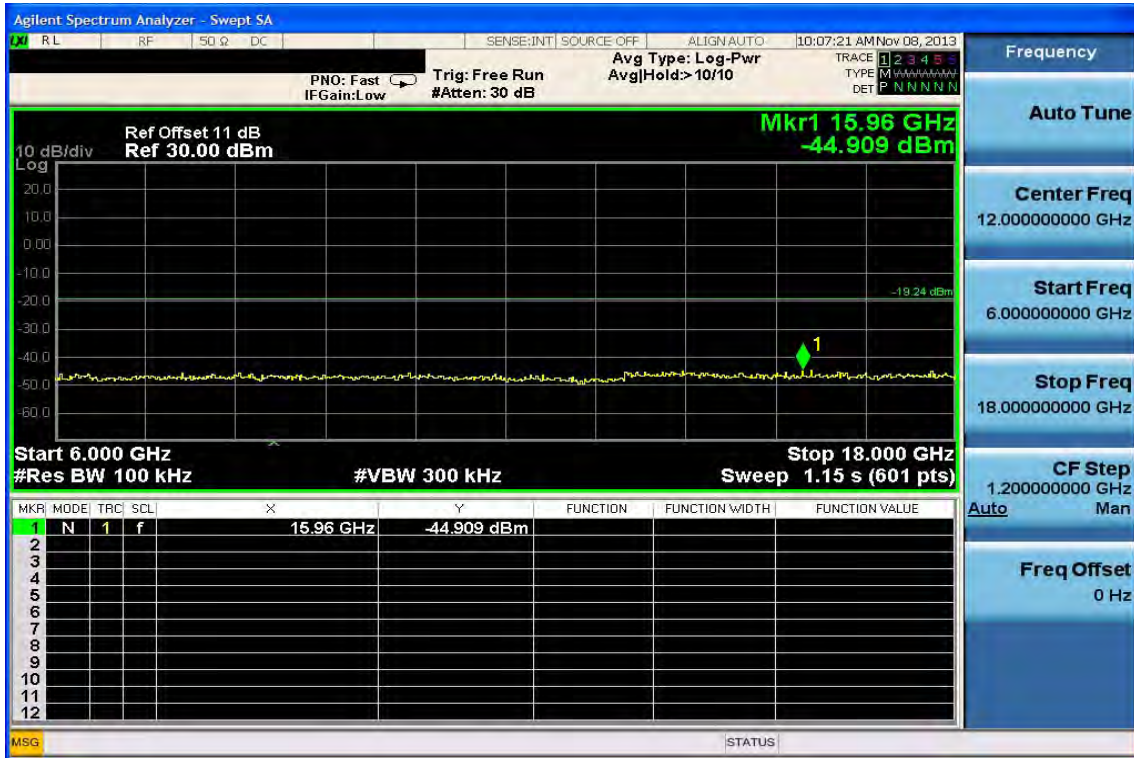

Ch Mid 18GHz – 40GHz

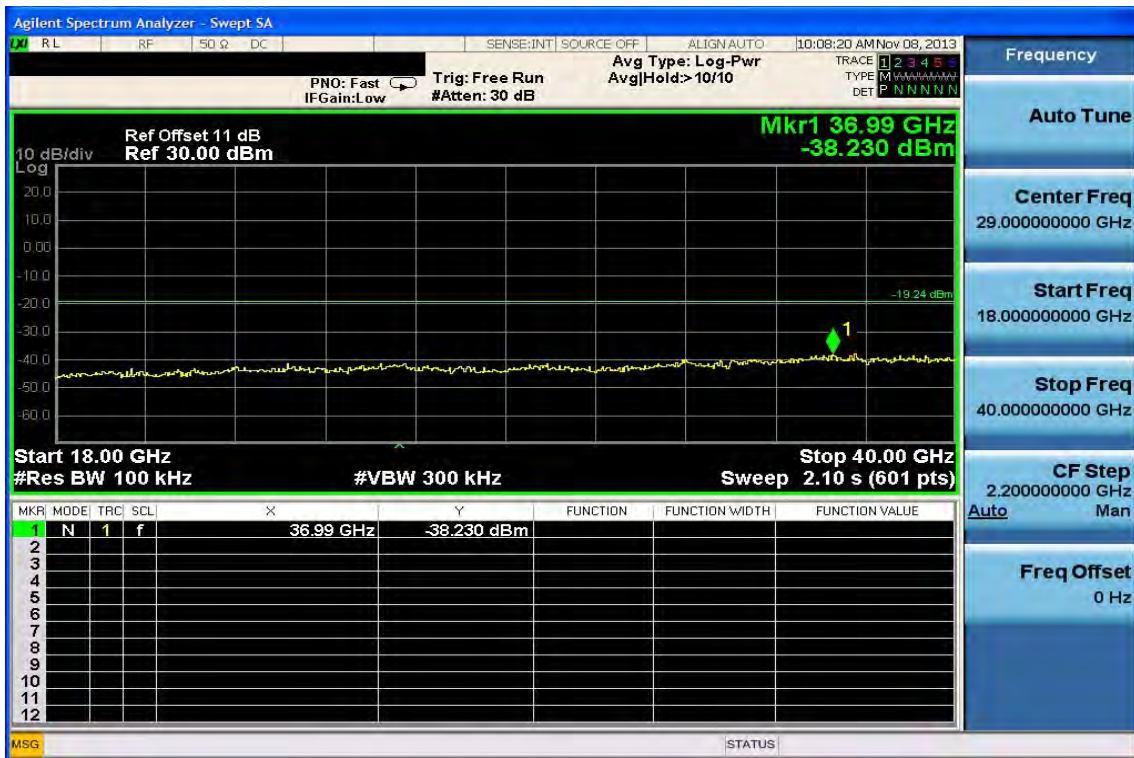

Unless otherwise stated the results shown in this test report refer only to the sample(s) tested and such sample(s) are retained for 90 days only.

除非另有說明，此報告結果僅對測試之樣品負責，同時此樣品僅保留90天。本報告未經本公司書面許可，不可部份複製。

This document is issued by the Company subject to its General Conditions of Service printed overleaf, available on request or accessible at www.sgs.com/terms_and_conditions.htm and, for electronic format documents, subject to Terms and Conditions for Electronic Documents at www.sgs.com/terms_e-document.htm. Attention is drawn to the limitation of liability, indemnification and jurisdiction issues defined therein. Any holder of this document is advised that information contained hereon reflects the Company's findings at the time of its intervention only and within the limits of Client's instructions, if any. The Company's sole responsibility is to its Client and this document does not exonerate parties to a transaction from exercising all their rights and obligations under the transaction documents. This document cannot be reproduced except in full, without prior written approval of the Company. Any unauthorized alteration, forgery or falsification of the content or appearance of this document is unlawful and offenders may be prosecuted to the fullest extent of the law.

Ch High 30MHz – 6GHz

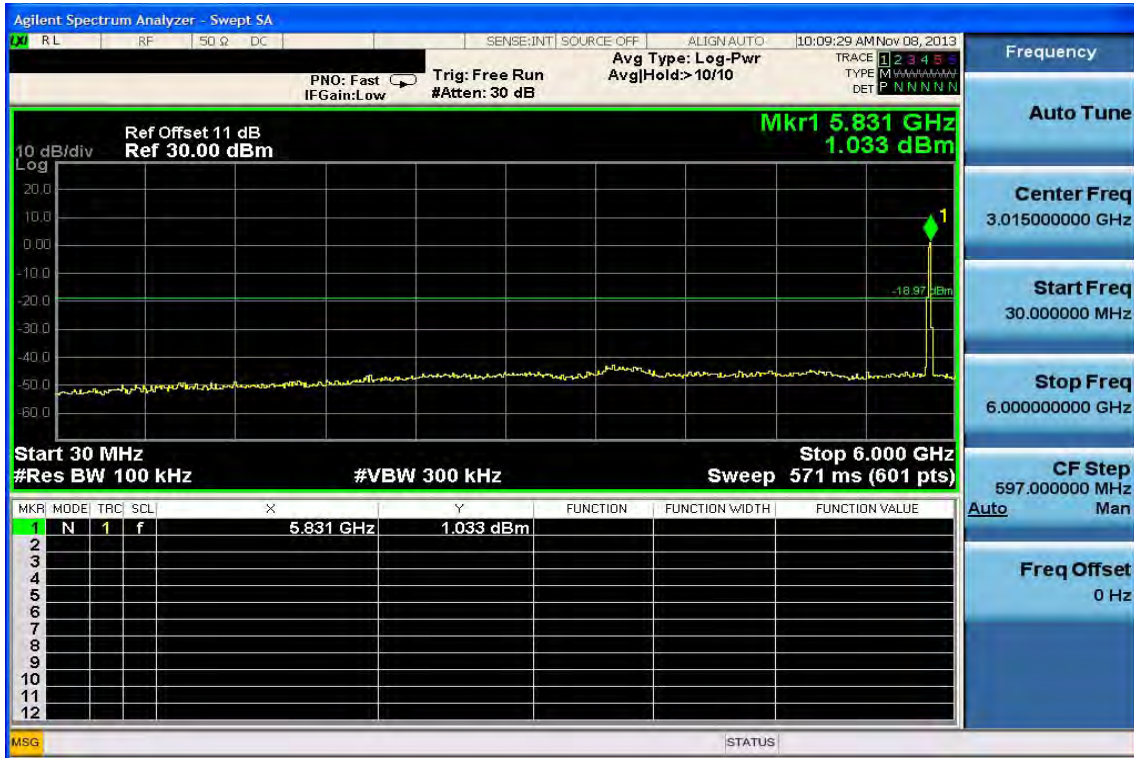

Ch High 6GHz – 18GHz

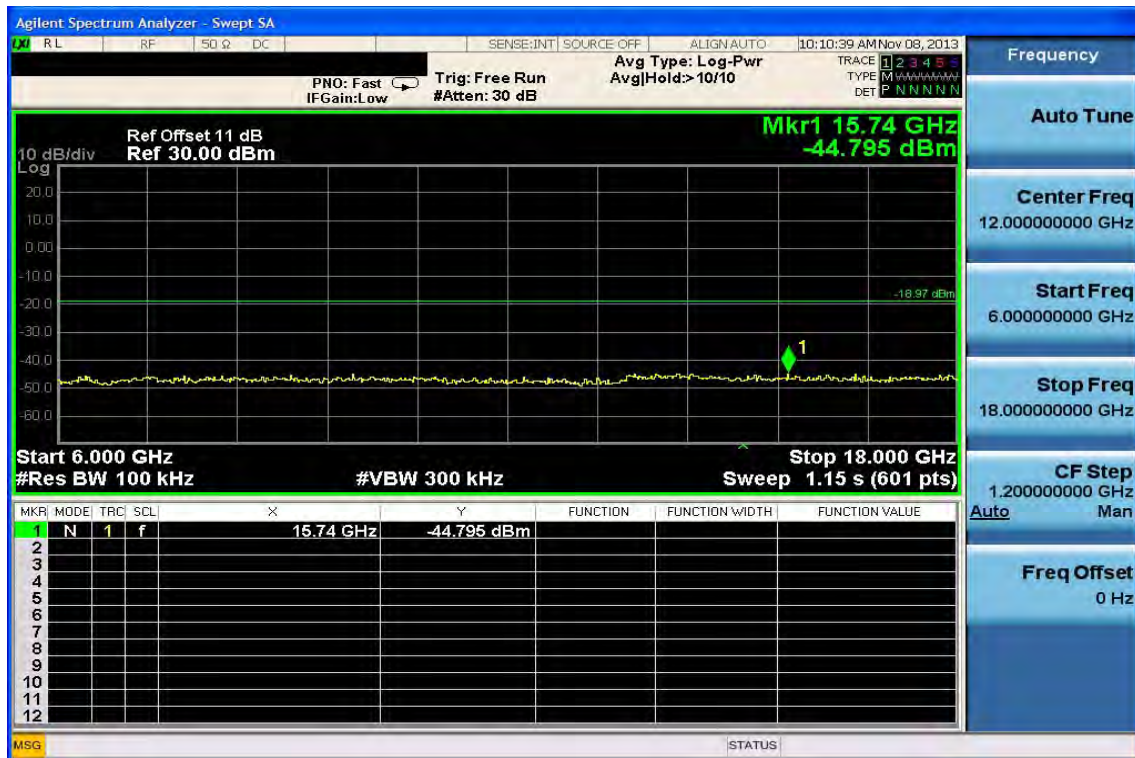

Unless otherwise stated the results shown in this test report refer only to the sample(s) tested and such sample(s) are retained for 90 days only.

除非另有說明，此報告結果僅對測試之樣品負責，同時此樣品僅保留90天。本報告未經本公司書面許可，不可部份複製。

This document is issued by the Company subject to its General Conditions of Service printed overleaf, available on request or accessible at www.sgs.com/terms_and_conditions.htm and, for electronic format documents, subject to Terms and Conditions for Electronic Documents at www.sgs.com/terms_e-document.htm. Attention is drawn to the limitation of liability, indemnification and jurisdiction issues defined therein. Any holder of this document is advised that information contained hereon reflects the Company's findings at the time of its intervention only and within the limits of Client's instructions, if any. The Company's sole responsibility is to its Client and this document does not exonerate parties to a transaction from exercising all their rights and obligations under the transaction documents. This document cannot be reproduced except in full, without prior written approval of the Company. Any unauthorized alteration, forgery or falsification of the content or appearance of this document is unlawful and offenders may be prosecuted to the fullest extent of the law.

SGS Taiwan Ltd.

No. 134, WuKungRoad, NewTaipeiIndustrialPark, WukuDistrict, NewTaipeiCity, Taiwan24803/新北市五股區新北產業園區五工路 134 號

台灣檢驗科技股份有限公司

t (886-2) 2299-3279

f (886-2) 2298-0488

www.tw.sgs.com

Member of SGS Group

Ch High 18GHz – 40GHz

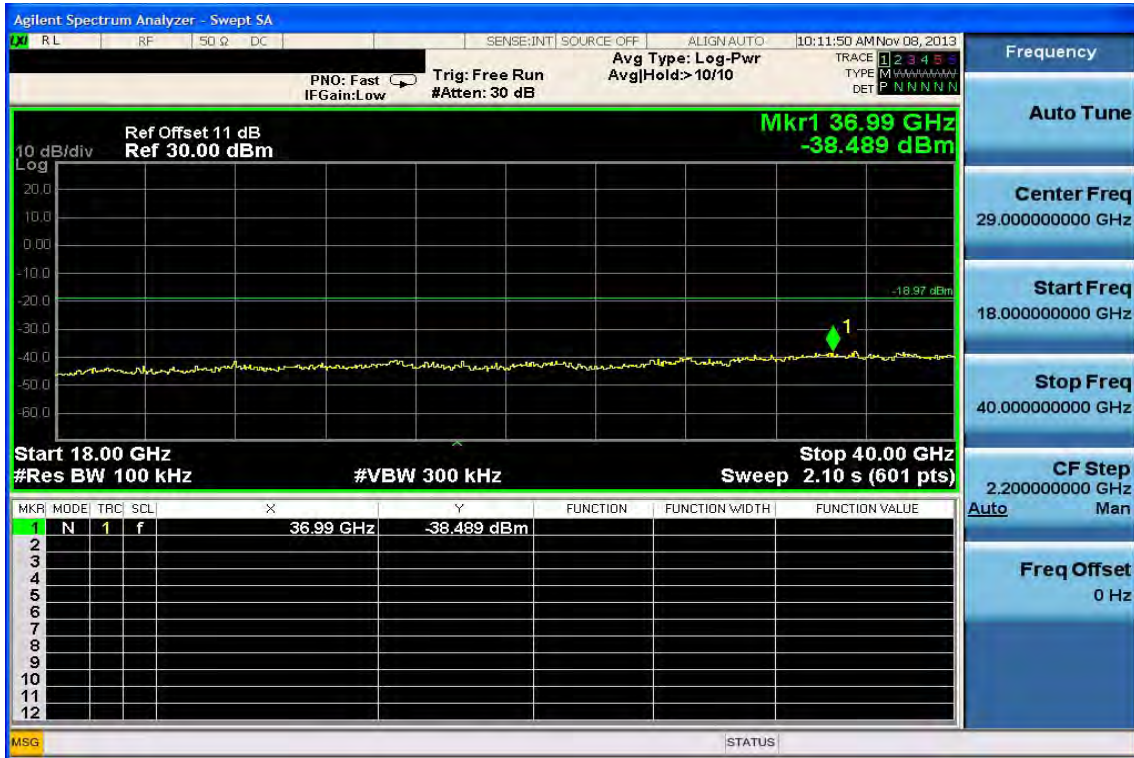

Unless otherwise stated the results shown in this test report refer only to the sample(s) tested and such sample(s) are retained for 90 days only.

除非另有說明，此報告結果僅對測試之樣品負責，同時此樣品僅保留90天。本報告未經本公司書面許可，不可部份複製。

This document is issued by the Company subject to its General Conditions of Service printed overleaf, available on request or accessible at www.sgs.com/terms_and_conditions.htm and, for electronic format documents, subject to Terms and Conditions for Electronic Documents at www.sgs.com/terms_e-document.htm. Attention is drawn to the limitation of liability, indemnification and jurisdiction issues defined therein. Any holder of this document is advised that information contained hereon reflects the Company's findings at the time of its intervention only and within the limits of Client's instructions, if any. The Company's sole responsibility is to its Client and this document does not exonerate parties to a transaction from exercising all their rights and obligations under the transaction documents. This document cannot be reproduced except in full, without prior written approval of the Company. Any unauthorized alteration, forgery or falsification of the content or appearance of this document is unlawful and offenders may be prosecuted to the fullest extent of the law.

Conducted Spurious Emission Measurement Result (802.11n (5GHz)_20M) Ch Low 30MHz – 6GHz

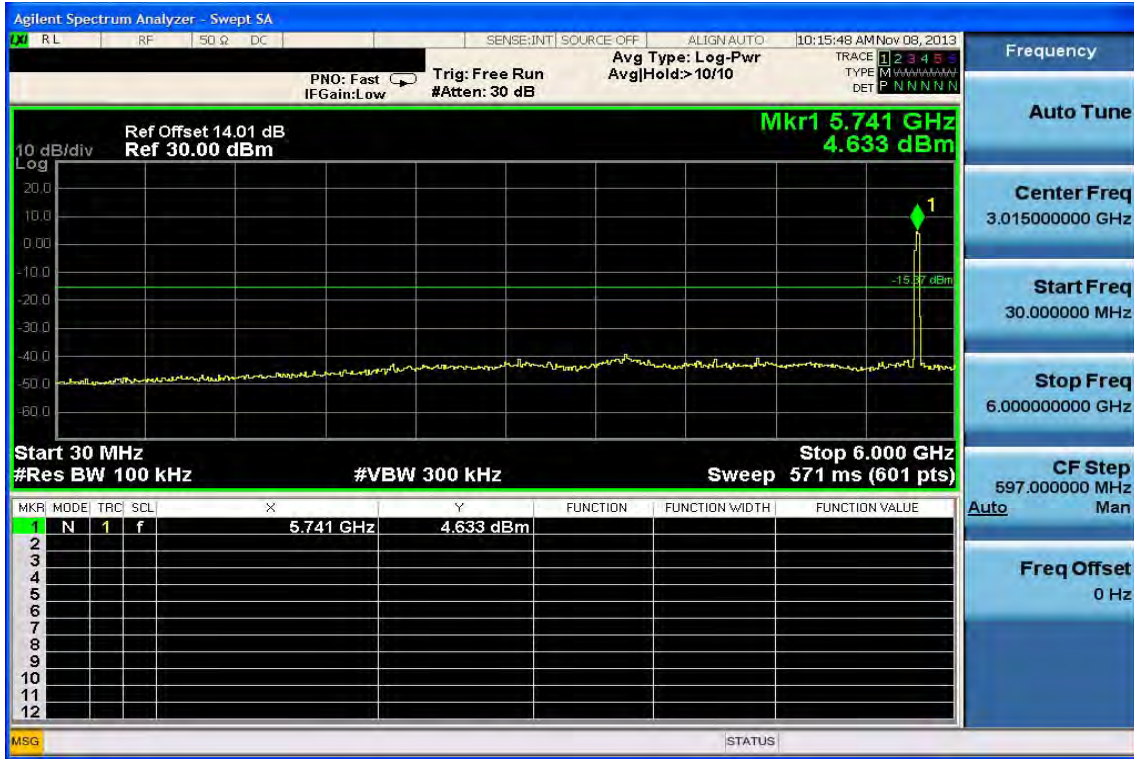

Ch Low 6GHz – 18GHz

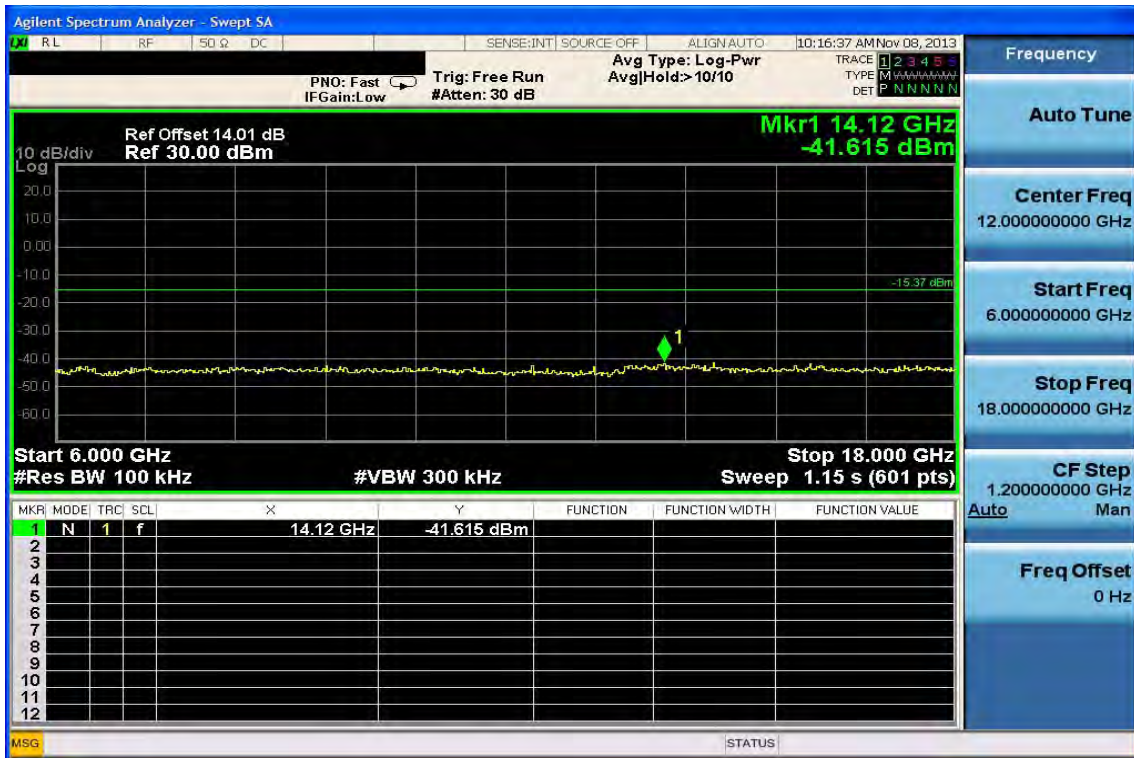

Unless otherwise stated the results shown in this test report refer only to the sample(s) tested and such sample(s) are retained for 90 days only.

除非另有說明，此報告結果僅對測試之樣品負責，同時此樣品僅保留90天。本報告未經本公司書面許可，不可部份複製。

This document is issued by the Company subject to its General Conditions of Service printed overleaf, available on request or accessible at www.sgs.com/terms_and_conditions.htm and, for electronic format documents, subject to Terms and Conditions for Electronic Documents at www.sgs.com/terms_e-document.htm. Attention is drawn to the limitation of liability, indemnification and jurisdiction issues defined therein. Any holder of this document is advised that information contained hereon reflects the Company's findings at the time of its intervention only and within the limits of Client's instructions, if any. The Company's sole responsibility is to its Client and this document does not exonerate parties to a transaction from exercising all their rights and obligations under the transaction documents. This document cannot be reproduced except in full, without prior written approval of the Company. Any unauthorized alteration, forgery or falsification of the content or appearance of this document is unlawful and offenders may be prosecuted to the fullest extent of the law.

Ch Low 18GHz – 40GHz

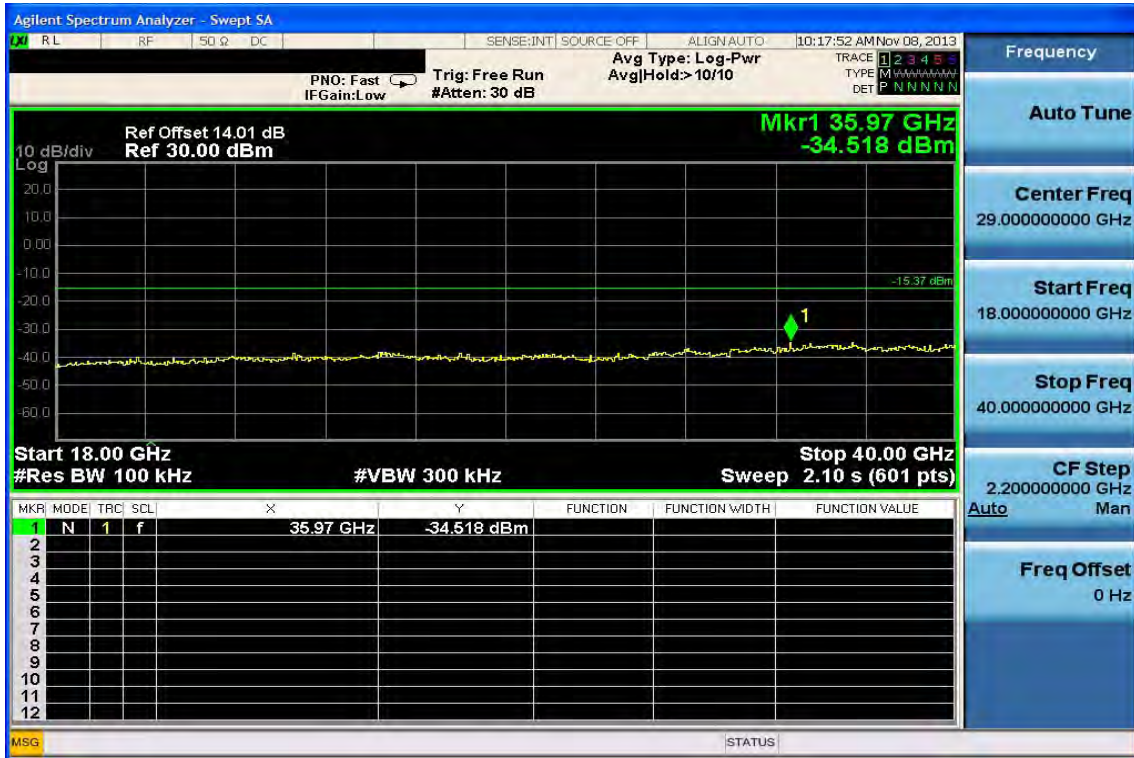

Ch Mid 30MHz – 6GHz

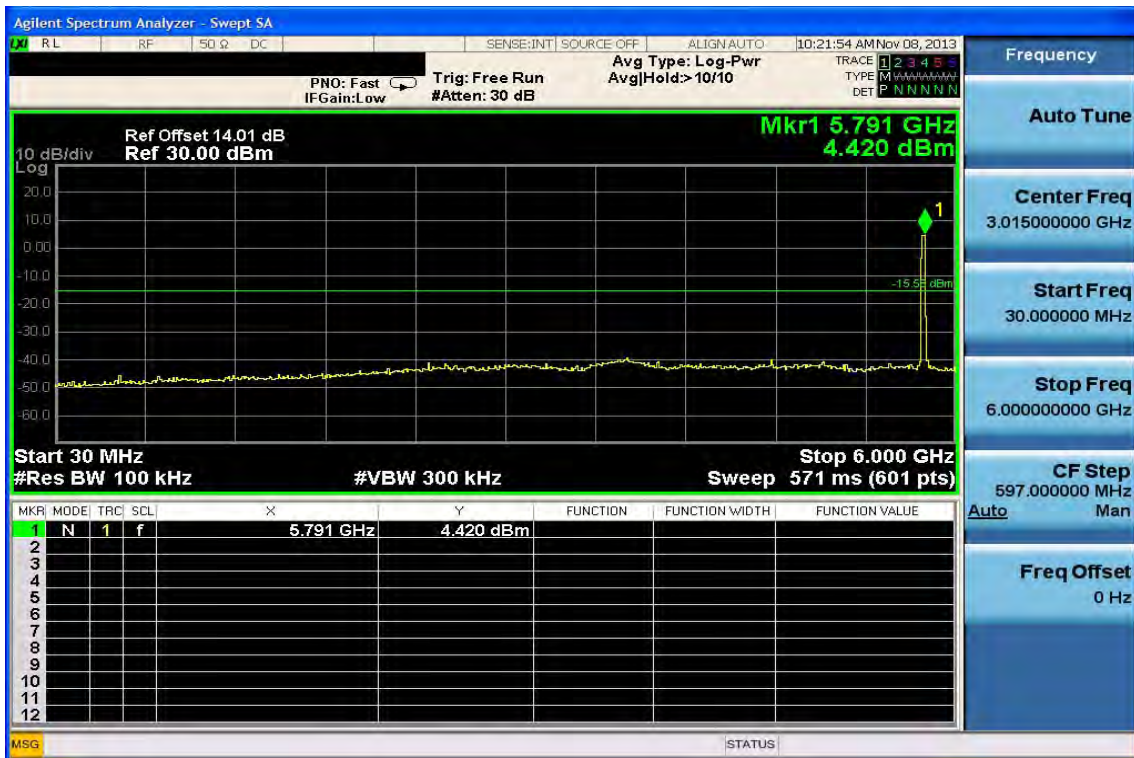

Unless otherwise stated the results shown in this test report refer only to the sample(s) tested and such sample(s) are retained for 90 days only.

除非另有說明，此報告結果僅對測試之樣品負責，同時此樣品僅保留90天。本報告未經本公司書面許可，不可部份複製。

This document is issued by the Company subject to its General Conditions of Service printed overleaf, available on request or accessible at www.sgs.com/terms_and_conditions.htm and, for electronic format documents, subject to Terms and Conditions for Electronic Documents at www.sgs.com/terms_e-document.htm. Attention is drawn to the limitation of liability, indemnification and jurisdiction issues defined therein. Any holder of this document is advised that information contained hereon reflects the Company's findings at the time of its intervention only and within the limits of Client's instructions, if any. The Company's sole responsibility is to its Client and this document does not exonerate parties to a transaction from exercising all their rights and obligations under the transaction documents. This document cannot be reproduced except in full, without prior written approval of the Company. Any unauthorized alteration, forgery or falsification of the content or appearance of this document is unlawful and offenders may be prosecuted to the fullest extent of the law.

Ch Mid 6GHz – 18GHz

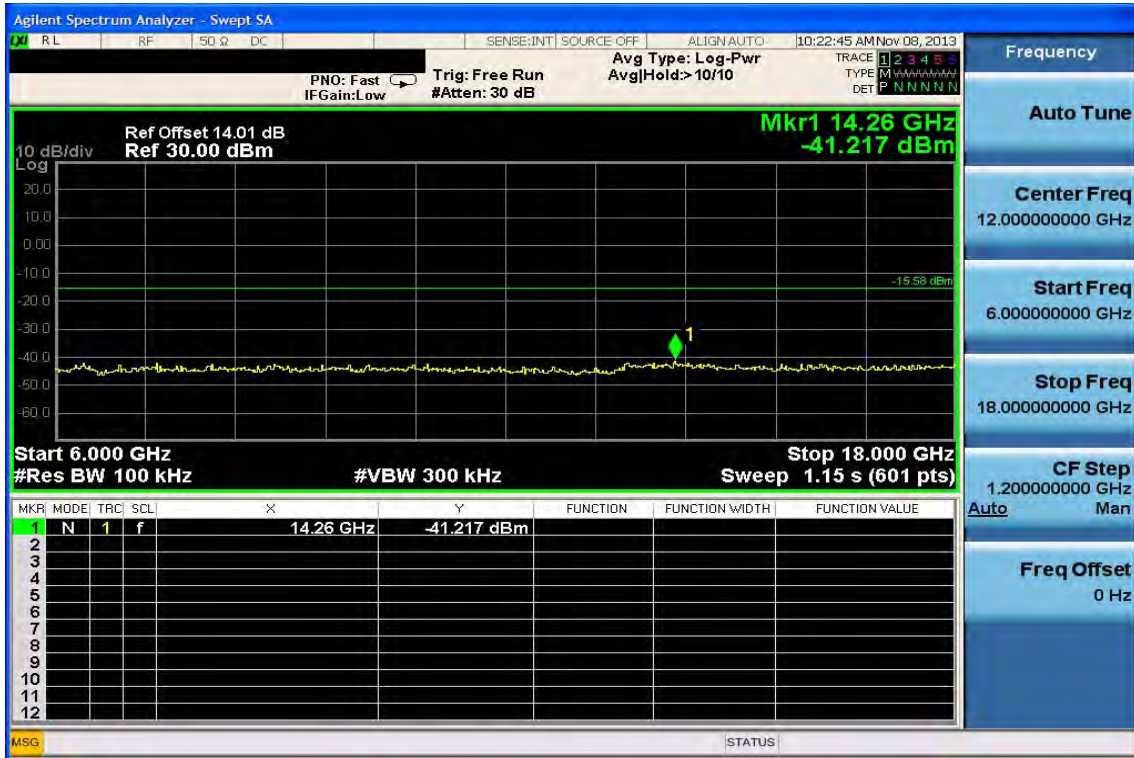

Ch Mid 18GHz – 40GHz

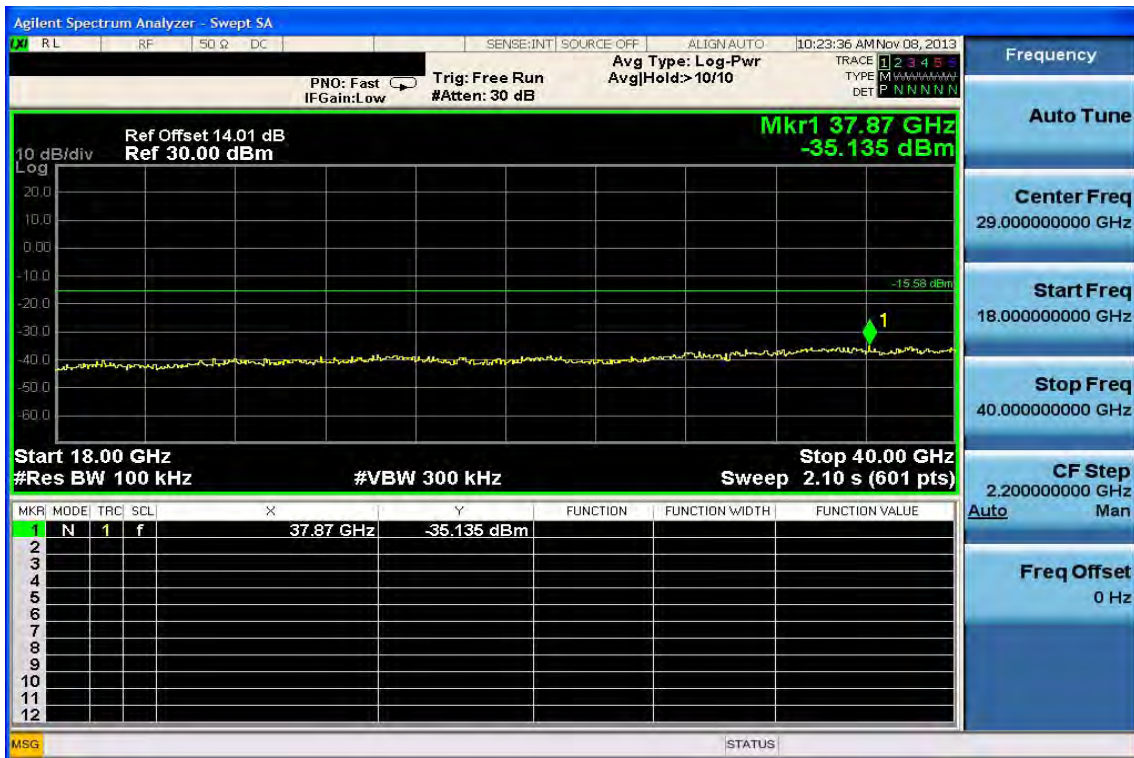

Unless otherwise stated the results shown in this test report refer only to the sample(s) tested and such sample(s) are retained for 90 days only.

除非另有說明，此報告結果僅對測試之樣品負責，同時此樣品僅保留90天。本報告未經本公司書面許可，不可部份複製。

This document is issued by the Company subject to its General Conditions of Service printed overleaf, available on request or accessible at www.sgs.com/terms_and_conditions.htm and, for electronic format documents, subject to Terms and Conditions for Electronic Documents at www.sgs.com/terms_e-document.htm. Attention is drawn to the limitation of liability, indemnification and jurisdiction issues defined therein. Any holder of this document is advised that information contained hereon reflects the Company's findings at the time of its intervention only and within the limits of Client's instructions, if any. The Company's sole responsibility is to its Client and this document does not exonerate parties to a transaction from exercising all their rights and obligations under the transaction documents. This document cannot be reproduced except in full, without prior written approval of the Company. Any unauthorized alteration, forgery or falsification of the content or appearance of this document is unlawful and offenders may be prosecuted to the fullest extent of the law.

Ch High 30MHz – 6GHz

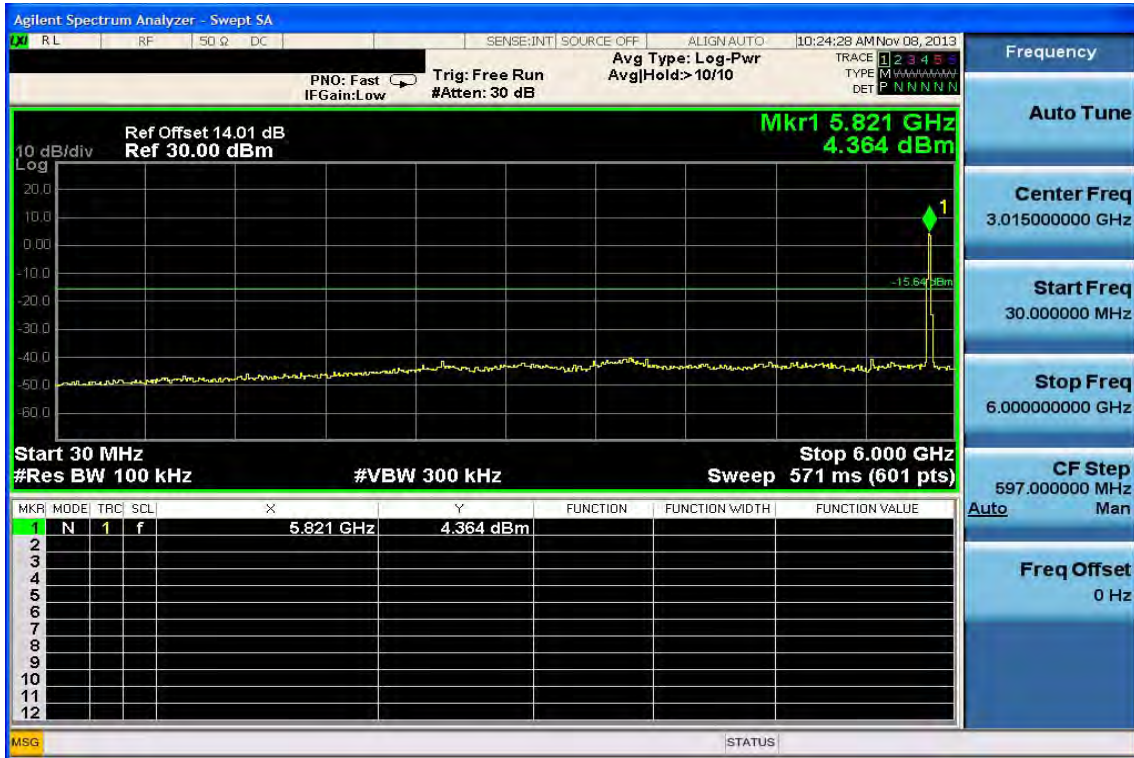

Ch High 6GHz – 18GHz

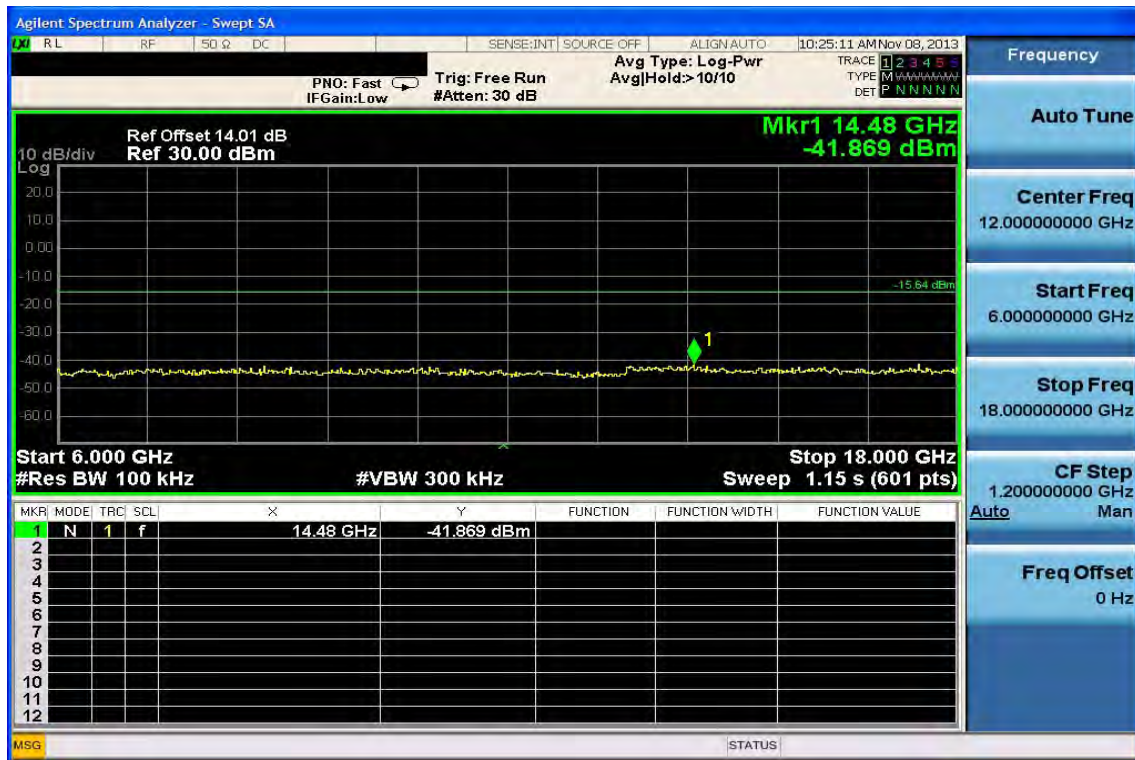

Unless otherwise stated the results shown in this test report refer only to the sample(s) tested and such sample(s) are retained for 90 days only.

除非另有說明，此報告結果僅對測試之樣品負責，同時此樣品僅保留90天。本報告未經本公司書面許可，不可部份複製。

This document is issued by the Company subject to its General Conditions of Service printed overleaf, available on request or accessible at www.sgs.com/terms_and_conditions.htm and, for electronic format documents, subject to Terms and Conditions for Electronic Documents at www.sgs.com/terms_e-document.htm. Attention is drawn to the limitation of liability, indemnification and jurisdiction issues defined therein. Any holder of this document is advised that information contained hereon reflects the Company's findings at the time of its intervention only and within the limits of Client's instructions, if any. The Company's sole responsibility is to its Client and this document does not exonerate parties to a transaction from exercising all their rights and obligations under the transaction documents. This document cannot be reproduced except in full, without prior written approval of the Company. Any unauthorized alteration, forgery or falsification of the content or appearance of this document is unlawful and offenders may be prosecuted to the fullest extent of the law.

SGS Taiwan Ltd.

No. 134, WuKungRoad, NewTaipeiIndustrialPark, WukuDistrict, NewTaipeiCity, Taiwan24803/新北市五股區新北產業園區五工路 134 號

台灣檢驗科技股份有限公司

t (886-2) 2299-3279

f (886-2) 2298-0488

www.tw.sgs.com

Member of SGS Group

Ch High 18GHz – 40GHz

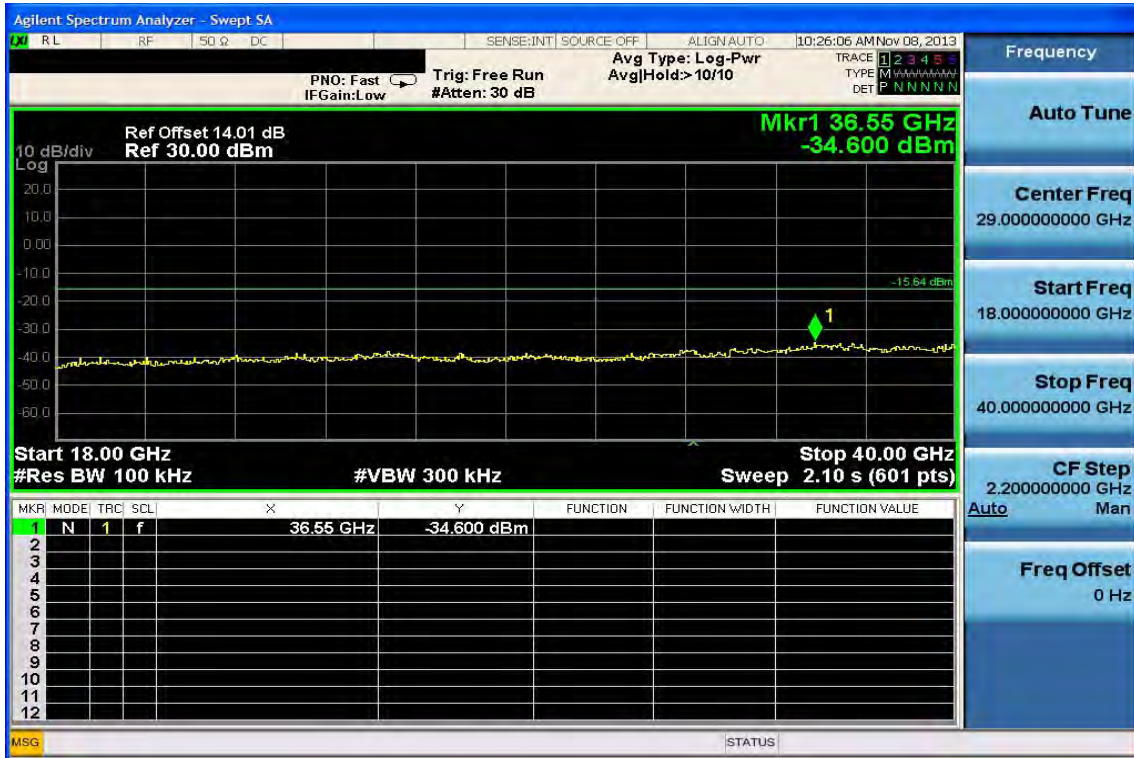

Unless otherwise stated the results shown in this test report refer only to the sample(s) tested and such sample(s) are retained for 90 days only.

除非另有說明，此報告結果僅對測試之樣品負責，同時此樣品僅保留90天。本報告未經本公司書面許可，不可部份複製。

This document is issued by the Company subject to its General Conditions of Service printed overleaf, available on request or accessible at www.sgs.com/terms_and_conditions.htm and, for electronic format documents, subject to Terms and Conditions for Electronic Documents at www.sgs.com/terms_e-document.htm. Attention is drawn to the limitation of liability, indemnification and jurisdiction issues defined therein. Any holder of this document is advised that information contained hereon reflects the Company's findings at the time of its intervention only and within the limits of Client's instructions, if any. The Company's sole responsibility is to its Client and this document does not exonerate parties to a transaction from exercising all their rights and obligations under the transaction documents. This document cannot be reproduced except in full, without prior written approval of the Company. Any unauthorized alteration, forgery or falsification of the content or appearance of this document is unlawful and offenders may be prosecuted to the fullest extent of the law.

SGS Taiwan Ltd.

No.134,WuKungRoad,NewTaipeiIndustrialPark,WukuDistrict,NewTaipeiCity,Taiwan24803/新北市五股區新北產業園區五工路 134 號

台灣檢驗科技股份有限公司

t (886-2) 2299-3279

f (886-2) 2298-0488

www.tw.sgs.com

Member of SGS Group

Conducted Spurious Emission Measurement Result (802.11n (5GHz)_40M) Ch Low 30MHz – 6GHz

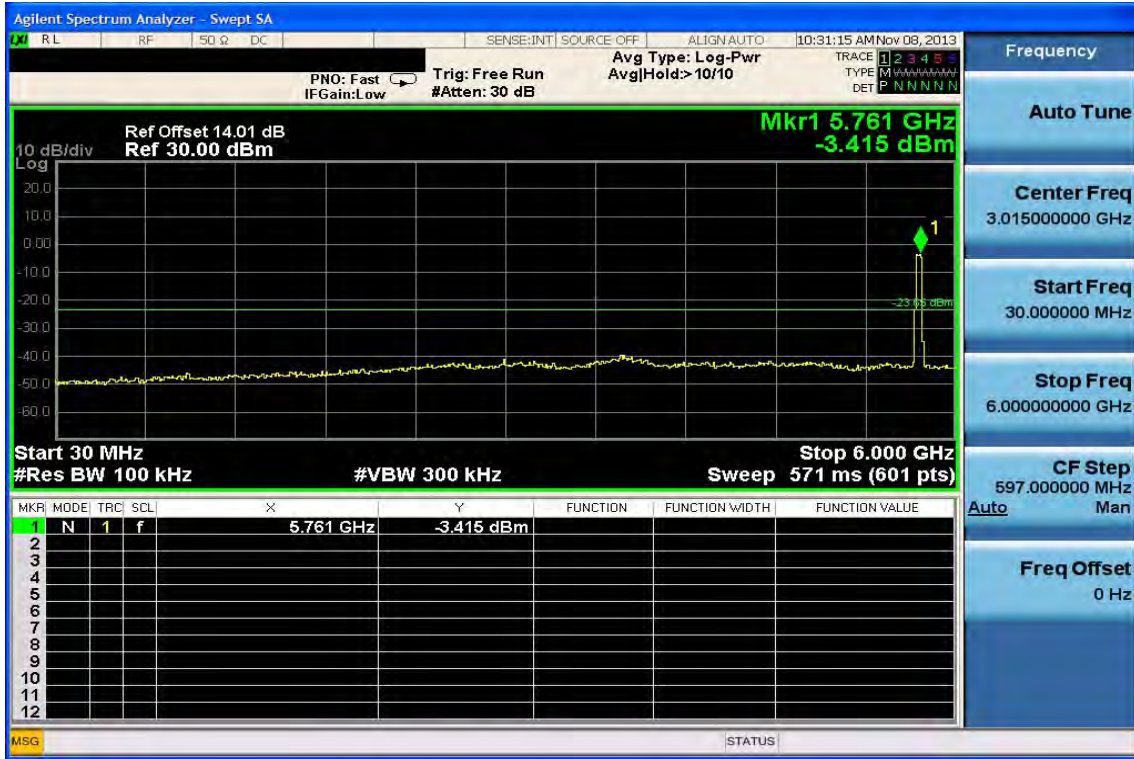

Ch Low 6GHz – 18GHz



Unless otherwise stated the results shown in this test report refer only to the sample(s) tested and such sample(s) are retained for 90 days only.
除非另有說明，此報告結果僅對測試之樣品負責，同時此樣品僅保留90天。本報告未經本公司書面許可，不可部份複製。

This document is issued by the Company subject to its General Conditions of Service printed overleaf, available on request or accessible at www.sgs.com/terms_and_conditions.htm and, for electronic format documents, subject to Terms and Conditions for Electronic Documents at www.sgs.com/terms_e-document.htm. Attention is drawn to the limitation of liability, indemnification and jurisdiction issues defined therein. Any holder of this document is advised that information contained hereon reflects the Company's findings at the time of its intervention only and within the limits of Client's instructions, if any. The Company's sole responsibility is to its Client and this document does not exonerate parties to a transaction from exercising all their rights and obligations under the transaction documents. This document cannot be reproduced except in full, without prior written approval of the Company. Any unauthorized alteration, forgery or falsification of the content or appearance of this document is unlawful and offenders may be prosecuted to the fullest extent of the law.

Ch Low 18GHz – 40GHz

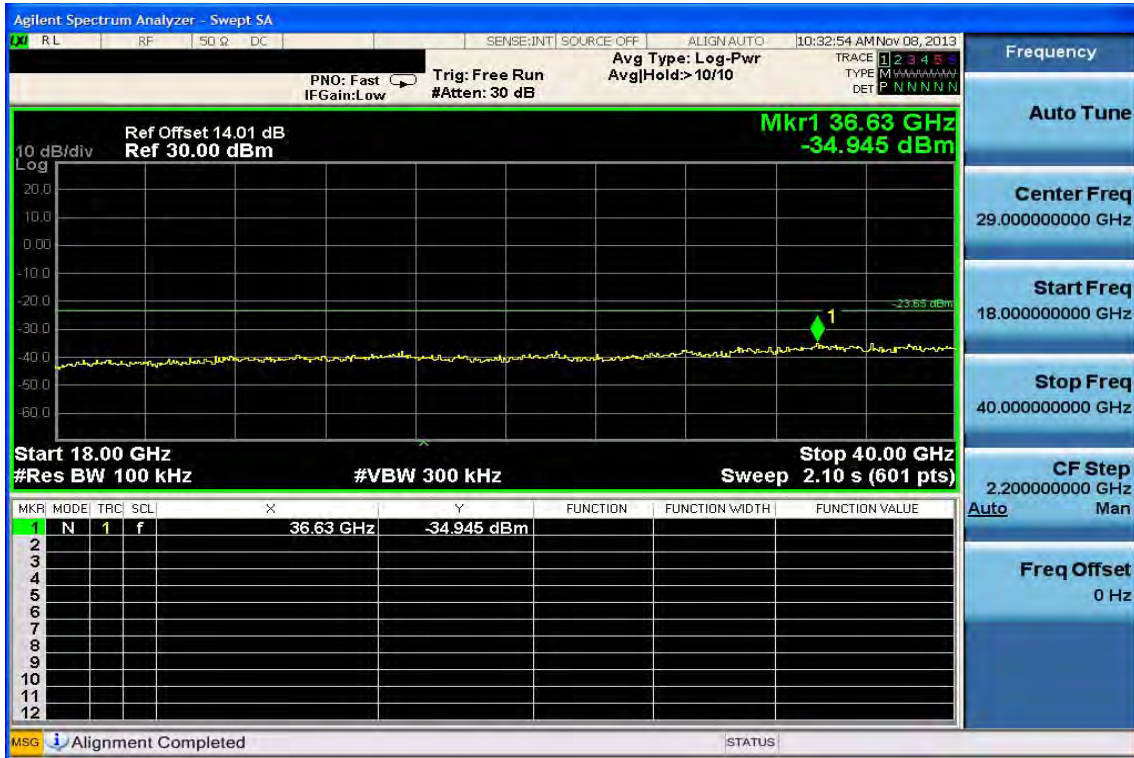

Ch High 30MHz – 6GHz

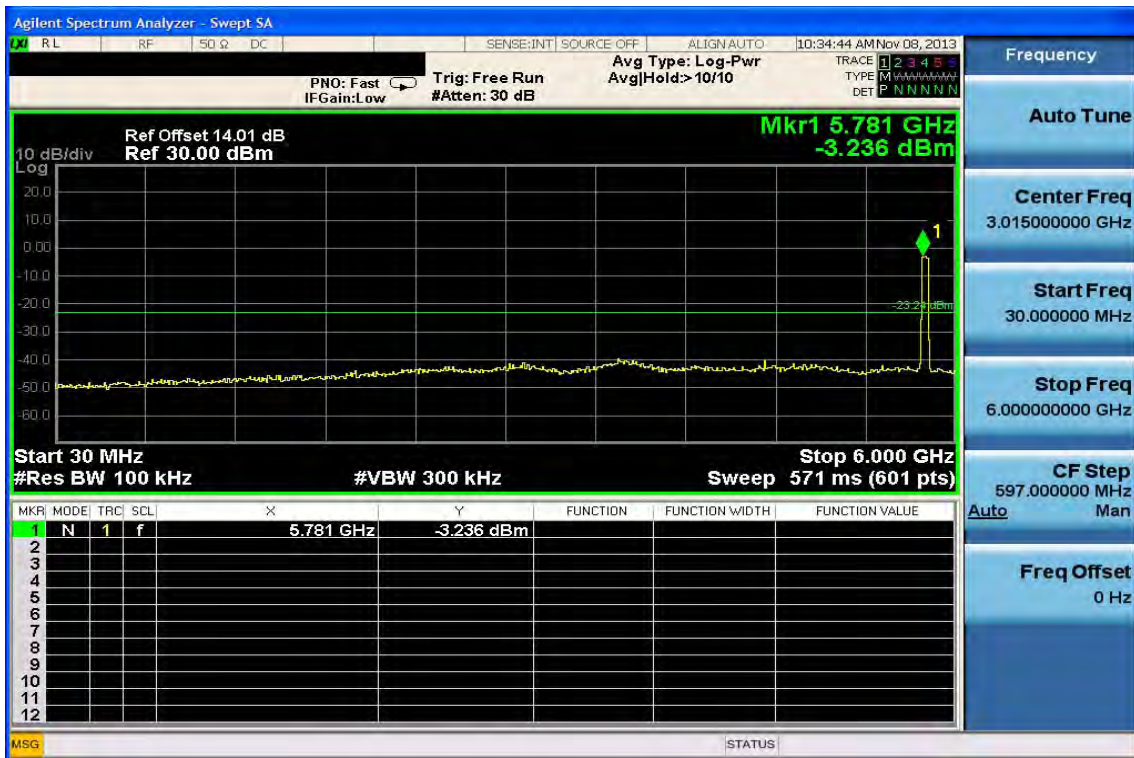

Unless otherwise stated the results shown in this test report refer only to the sample(s) tested and such sample(s) are retained for 90 days only.

除非另有說明，此報告結果僅對測試之樣品負責，同時此樣品僅保留90天。本報告未經本公司書面許可，不可部份複製。

This document is issued by the Company subject to its General Conditions of Service printed overleaf, available on request or accessible at www.sgs.com/terms_and_conditions.htm and, for electronic format documents, subject to Terms and Conditions for Electronic Documents at www.sgs.com/terms_e-document.htm. Attention is drawn to the limitation of liability, indemnification and jurisdiction issues defined therein. Any holder of this document is advised that information contained hereon reflects the Company's findings at the time of its intervention only and within the limits of Client's instructions, if any. The Company's sole responsibility is to its Client and this document does not exonerate parties to a transaction from exercising all their rights and obligations under the transaction documents. This document cannot be reproduced except in full, without prior written approval of the Company. Any unauthorized alteration, forgery or falsification of the content or appearance of this document is unlawful and offenders may be prosecuted to the fullest extent of the law.

Ch High 6GHz – 18GHz

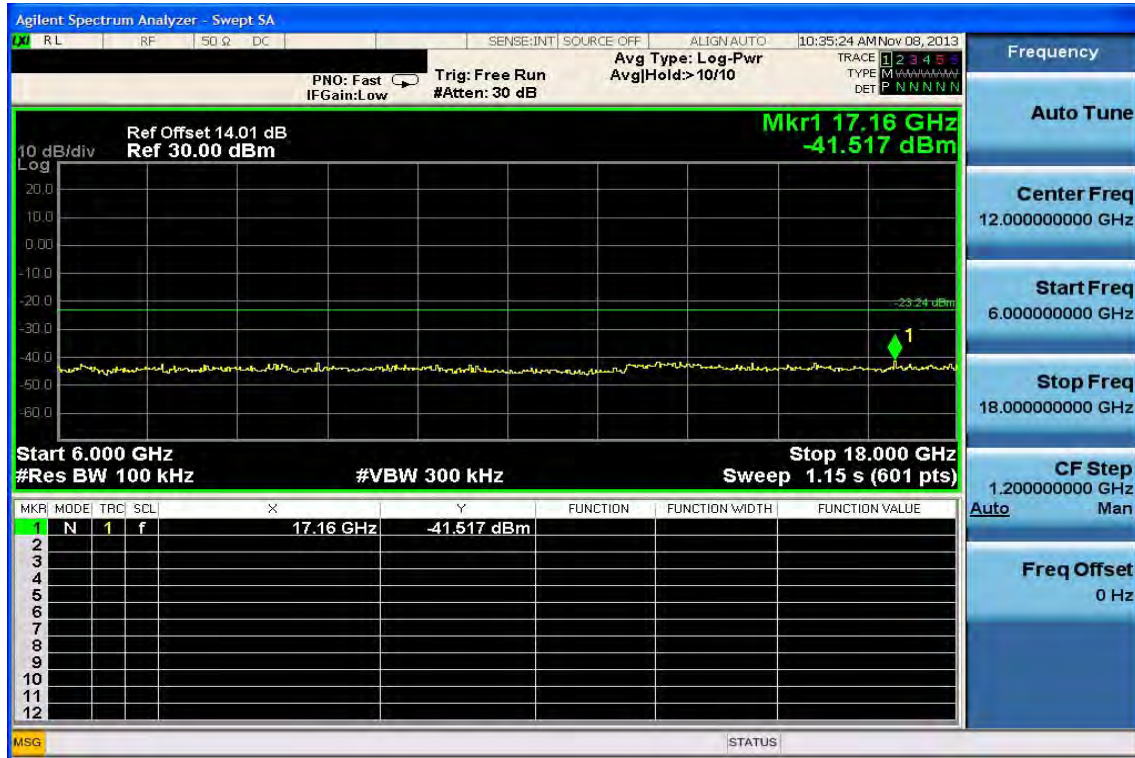

Ch High 18GHz – 40GHz



Unless otherwise stated the results shown in this test report refer only to the sample(s) tested and such sample(s) are retained for 90 days only.

除非另有說明，此報告結果僅對測試之樣品負責，同時此樣品僅保留90天。本報告未經本公司書面許可，不可部份複製。

This document is issued by the Company subject to its General Conditions of Service printed overleaf, available on request or accessible at www.sgs.com/terms_and_conditions.htm and, for electronic format documents, subject to Terms and Conditions for Electronic Documents at www.sgs.com/terms_e-document.htm. Attention is drawn to the limitation of liability, indemnification and jurisdiction issues defined therein. Any holder of this document is advised that information contained hereon reflects the Company's findings at the time of its intervention only and within the limits of Client's instructions, if any. The Company's sole responsibility is to its Client and this document does not exonerate parties to a transaction from exercising all their rights and obligations under the transaction documents. This document cannot be reproduced except in full, without prior written approval of the Company. Any unauthorized alteration, forgery or falsification of the content or appearance of this document is unlawful and offenders may be prosecuted to the fullest extent of the law.

SGS Taiwan Ltd.

No. 134, WuKungRoad, NewTaipeiIndustrialPark, WukuDistrict, NewTaipeiCity, Taiwan24803/新北市五股區新北產業園區五工路 134 號

台灣檢驗科技股份有限公司

t (886-2) 2299-3279

f (886-2) 2298-0488

www.tw.sgs.com

Member of SGS Group

Radiated Spurious Emission Measurement Result (802.11a)

| | | | |
|-----------------------|-----------|--------------------------|------------------|
| Operation Band | :802.11 a | Test Date | :2013-11-17 |
| Fundamental Frequency | :5745 MHz | Temp./Humi. | :25.3 deg_C/54RH |
| Operation Mode | :TX LOW | Engineer | :Vito |
| EUT Pol. | :E1 Plan | Measurement Antenna Pol. | :VERTICAL |

Actual FS(dBμV/m) = SPA. Reading level(dBμV) + Factor(dB)

Factor(dB) = Antenna Factor(dBμV/m) + Cable Loss(dB) – Pre_Amplifier Gain(dB)

Note : “F” : denotes Fundamental Frequency. ; “H” : denotes Harmonic Frequency.

“E” : denotes Band Edge Frequency. ; “S” : denotes Spurious Frequency.

“---“ : denotes Noise Floor.

| Freq. | Note | Detector Mode | Spectrum Reading Level | Factor | Actual FS | Limit @3m | Margin |
|----------|---------|---------------|------------------------|--------|-----------|-----------|--------|
| MHz | F/H/E/S | PK/QP/AV | dBμV | dB | dBμV/m | dBμV/m | dB |
| 38.73 | S | Peak | 57.19 | -20.40 | 36.79 | 40.00 | -3.21 |
| 93.05 | S | Peak | 60.51 | -24.20 | 36.30 | 43.50 | -7.20 |
| 101.78 | S | Peak | 58.74 | -22.93 | 35.81 | 43.50 | -7.69 |
| 155.13 | S | Peak | 63.01 | -23.07 | 39.94 | 43.50 | -3.56 |
| 274.44 | S | Peak | 51.51 | -19.69 | 31.82 | 46.00 | -14.18 |
| 400.54 | S | Peak | 55.85 | -15.56 | 40.28 | 46.00 | -5.72 |
| 1399.00 | S | Peak | 56.37 | -9.80 | 46.57 | 74.00 | -27.43 |
| 1399.00 | S | Average | 45.48 | -9.80 | 35.68 | 54.00 | -18.32 |
| 5494.00 | S | Peak | 68.14 | 1.44 | 69.58 | 74.00 | -4.42 |
| 5494.00 | S | Average | 51.97 | 1.44 | 53.41 | 54.00 | -0.59 |
| 11490.00 | H | Peak | 42.20 | 8.16 | 50.36 | 74.00 | -23.64 |
| 11490.00 | H | Average | 31.91 | 8.16 | 40.07 | 54.00 | -13.93 |
| 17235.00 | H | Peak | - | - | - | - | - |
| 22980.00 | H | Peak | - | - | - | - | - |
| 28725.00 | H | Peak | - | - | - | - | - |
| 34470.00 | H | Peak | - | - | - | - | - |

Unless otherwise stated the results shown in this test report refer only to the sample(s) tested and such sample(s) are retained for 90 days only.

除非另有說明，此報告結果僅對測試之樣品負責，同時此樣品僅保留90天。本報告未經本公司書面許可，不可部份複製。

This document is issued by the Company subject to its General Conditions of Service printed overleaf, available on request or accessible at www.sgs.com/terms_and_conditions.htm and, for electronic format documents, subject to Terms and Conditions for Electronic Documents at www.sgs.com/terms_e-document.htm. Attention is drawn to the limitation of liability, indemnification and jurisdiction issues defined therein. Any holder of this document is advised that information contained hereon reflects the Company's findings at the time of its intervention only and within the limits of Client's instructions, if any. The Company's sole responsibility is to its Client and this document does not exonerate parties to a transaction from exercising all their rights and obligations under the transaction documents. This document cannot be reproduced except in full, without prior written approval of the Company. Any unauthorized alteration, forgery or falsification of the content or appearance of this document is unlawful and offenders may be prosecuted to the fullest extent of the law.

SGS Taiwan Ltd.

No.134,WuKungRoad,NewTaipeiIndustrialPark,WukuDistrict,NewTaipeiCity,Taiwan24803/新北市五股區新北產業園區五工路 134 號

台灣檢驗科技股份有限公司

t (886-2) 2299-3279

f (886-2) 2298-0488

www.tw.sgs.com

Member of SGS Group

| | | | |
|-----------------------|-----------|--------------------------|------------------|
| Operation Band | :802.11 a | Test Date | :2013-11-17 |
| Fundamental Frequency | :5745 MHz | Temp./Humi. | :25.3 deg_C/54RH |
| Operation Mode | :TX LOW | Engineer | :Vito |
| EUT Pol. | :E1 Plan | Measurement Antenna Pol. | :HORIZONTAL |

Actual FS(dBμV/m) = SPA. Reading level(dBμV) + Factor(dB)

Factor(dB) = Antenna Factor(dBμV/m) + Cable Loss(dB) – Pre_Amplifier Gain(dB)

Note : “F” : denotes Fundamental Frequency. ; “H” : denotes Harmonic Frequency.

“E” : denotes Band Edge Frequency. ; “S” : denotes Spurious Frequency.

“--“ : denotes Noise Floor.

| Freq. | Note | Detector Mode | Spectrum Reading Level | Factor | Actual FS | Limit @3m | Margin |
|----------|---------|------------------|---------------------------|--------|--------------|--------------|--------|
| MHz | F/H/E/S | PK/QP/AV | dBμV | dB | dBμV/m | dBμV/m | dB |
| 37.76 | S | Peak | 52.45 | -19.82 | 32.64 | 40.00 | -7.36 |
| 93.05 | S | Peak | 58.59 | -24.20 | 34.39 | 43.50 | -9.11 |
| 101.78 | S | Peak | 59.00 | -22.93 | 36.07 | 43.50 | -7.43 |
| 155.13 | S | Peak | 58.23 | -23.07 | 35.17 | 43.50 | -8.33 |
| 199.75 | S | Peak | 59.80 | -23.79 | 36.01 | 43.50 | -7.49 |
| 400.54 | S | Peak | 59.05 | -15.56 | 43.49 | 46.00 | -2.51 |
| 11490.00 | H | Peak | 42.83 | 8.16 | 50.99 | 74.00 | -23.01 |
| 11490.00 | H | Average | 31.91 | 8.16 | 40.07 | 54.00 | -13.93 |
| 17235.00 | H | Peak | - | - | - | - | - |
| 22980.00 | H | Peak | - | - | - | - | - |
| 28725.00 | H | Peak | - | - | - | - | - |
| 34470.00 | H | Peak | - | - | - | - | - |

Unless otherwise stated the results shown in this test report refer only to the sample(s) tested and such sample(s) are retained for 90 days only.

除非另有說明，此報告結果僅對測試之樣品負責，同時此樣品僅保留90天。本報告未經本公司書面許可，不可部份複製。

This document is issued by the Company subject to its General Conditions of Service printed overleaf, available on request or accessible at www.sgs.com/terms_and_conditions.htm and, for electronic format documents, subject to Terms and Conditions for Electronic Documents at www.sgs.com/terms_e-document.htm. Attention is drawn to the limitation of liability, indemnification and jurisdiction issues defined therein. Any holder of this document is advised that information contained hereon reflects the Company's findings at the time of its intervention only and within the limits of Client's instructions, if any. The Company's sole responsibility is to its Client and this document does not exonerate parties to a transaction from exercising all their rights and obligations under the transaction documents. This document cannot be reproduced except in full, without prior written approval of the Company. Any unauthorized alteration, forgery or falsification of the content or appearance of this document is unlawful and offenders may be prosecuted to the fullest extent of the law.

SGS Taiwan Ltd.

No.134,WuKungRoad,NewTaipeiIndustrialPark,WukuDistrict,NewTaipeiCity,Taiwan24803/新北市五股區新北產業園區五工路 134 號

台灣檢驗科技股份有限公司

t (886-2) 2299-3279

f (886-2) 2298-0488

www.tw.sgs.com

Member of SGS Group

| | | | |
|-----------------------|-----------|--------------------------|------------------|
| Operation Band | :802.11 a | Test Date | :2013-11-17 |
| Fundamental Frequency | :5785 MHz | Temp./Humi. | :25.3 deg_C/54RH |
| Operation Mode | :TX MID | Engineer | :Vito |
| EUT Pol. | :E1 Plan | Measurement Antenna Pol. | :VERTICAL |

Actual FS(dBμV/m) = SPA. Reading level(dBμV) + Factor(dB)

Factor(dB) = Antenna Factor(dBμV/m) + Cable Loss(dB) – Pre_Amplifier Gain(dB)

Note : “F” : denotes Fundamental Frequency. ; “H” : denotes Harmonic Frequency.

“E” : denotes Band Edge Frequency. ; “S” : denotes Spurious Frequency.

“--” : denotes Noise Floor.

| Freq. | Note | Detector Mode | Spectrum Reading Level | Factor | Actual FS | Limit @3m | Margin |
|----------|---------|------------------|---------------------------|--------|--------------|--------------|--------|
| MHz | F/H/E/S | PK/QP/AV | dBμV | dB | dBμV/m | dBμV/m | dB |
| 38.73 | S | Peak | 57.43 | -20.40 | 37.03 | 40.00 | -2.97 |
| 91.11 | S | Peak | 58.57 | -24.53 | 34.04 | 43.50 | -9.46 |
| 154.16 | S | Peak | 63.33 | -23.09 | 40.24 | 43.50 | -3.26 |
| 199.75 | S | Peak | 57.02 | -23.79 | 33.23 | 43.50 | -10.27 |
| 274.44 | S | Peak | 52.19 | -19.69 | 32.51 | 46.00 | -13.49 |
| 400.54 | S | Peak | 54.30 | -15.56 | 38.74 | 46.00 | -7.26 |
| 1399.00 | S | Peak | 55.20 | -9.80 | 45.40 | 74.00 | -28.60 |
| 1399.00 | S | Average | 45.41 | -9.80 | 35.61 | 54.00 | -18.39 |
| 5508.00 | S | Peak | 64.80 | 1.47 | 66.27 | 74.00 | -7.73 |
| 5508.00 | S | Average | 52.29 | 1.47 | 53.76 | 54.00 | -0.24 |
| 11570.00 | H | Peak | 48.09 | 10.29 | 58.38 | 74.00 | -15.62 |
| 11570.00 | H | Average | 34.67 | 10.29 | 44.96 | 54.00 | -9.04 |
| 17355.00 | H | Peak | - | - | - | - | - |
| 23140.00 | H | Peak | - | - | - | - | - |
| 28925.00 | H | Peak | - | - | - | - | - |
| 34710.00 | H | Peak | - | - | - | - | - |

Unless otherwise stated the results shown in this test report refer only to the sample(s) tested and such sample(s) are retained for 90 days only.

除非另有說明，此報告結果僅對測試之樣品負責，同時此樣品僅保留90天。本報告未經本公司書面許可，不可部份複製。

This document is issued by the Company subject to its General Conditions of Service printed overleaf, available on request or accessible at www.sgs.com/terms_and_conditions.htm and, for electronic format documents, subject to Terms and Conditions for Electronic Documents at www.sgs.com/terms_e-document.htm. Attention is drawn to the limitation of liability, indemnification and jurisdiction issues defined therein. Any holder of this document is advised that information contained hereon reflects the Company's findings at the time of its intervention only and within the limits of Client's instructions, if any. The Company's sole responsibility is to its Client and this document does not exonerate parties to a transaction from exercising all their rights and obligations under the transaction documents. This document cannot be reproduced except in full, without prior written approval of the Company. Any unauthorized alteration, forgery or falsification of the content or appearance of this document is unlawful and offenders may be prosecuted to the fullest extent of the law.

SGS Taiwan Ltd.

No.134,WuKungRoad,NewTaipeiIndustrialPark,WukuDistrict,NewTaipeiCity,Taiwan24803/新北市五股區新北產業園區五工路 134 號

台灣檢驗科技股份有限公司

t (886-2) 2299-3279

f (886-2) 2298-0488

www.tw.sgs.com

Member of SGS Group

| | | | |
|-----------------------|-----------|--------------------------|------------------|
| Operation Band | :802.11 a | Test Date | :2013-11-17 |
| Fundamental Frequency | :5785 MHz | Temp./Humi. | :25.3 deg_C/54RH |
| Operation Mode | :TX MID | Engineer | :Vito |
| EUT Pol. | :E1 Plan | Measurement Antenna Pol. | :HORIZONTAL |

Actual FS(dBμV/m) = SPA. Reading level(dBμV) + Factor(dB)

Factor(dB) = Antenna Factor(dBμV/m) + Cable Loss(dB) – Pre_Amplifier Gain(dB)

Note : “F” : denotes Fundamental Frequency. ; “H” : denotes Harmonic Frequency.

“E” : denotes Band Edge Frequency. ; “S” : denotes Spurious Frequency.

“--” : denotes Noise Floor.

| Freq. | Note | Detector Mode | Spectrum Reading Level | Factor | Actual FS | Limit @3m | Margin |
|----------|---------|---------------|------------------------|--------|-----------|-----------|--------|
| MHz | F/H/E/S | PK/QP/AV | dBμV | dB | dBμV/m | dBμV/m | dB |
| 93.05 | S | Peak | 60.86 | -24.20 | 36.66 | 43.50 | -6.84 |
| 101.78 | S | Peak | 58.02 | -22.93 | 35.09 | 43.50 | -8.41 |
| 149.31 | S | Peak | 59.46 | -22.75 | 36.71 | 43.50 | -6.79 |
| 299.66 | S | Peak | 57.35 | -19.05 | 38.31 | 46.00 | -7.69 |
| 350.10 | S | Peak | 55.04 | -17.38 | 37.66 | 46.00 | -8.34 |
| 400.54 | S | Peak | 58.74 | -15.56 | 43.18 | 46.00 | -2.82 |
| 1399.00 | S | Peak | 56.94 | -6.80 | 50.14 | 74.00 | -23.86 |
| 1399.00 | S | Average | 47.13 | -6.80 | 40.33 | 54.00 | -13.67 |
| 5501.00 | S | Peak | 52.35 | 1.44 | 53.80 | 74.00 | -20.20 |
| 5501.00 | S | Average | 40.48 | 1.44 | 41.92 | 54.00 | -12.08 |
| 11570.00 | H | Peak | 44.83 | 10.29 | 55.12 | 74.00 | -18.88 |
| 11570.00 | H | Average | 33.35 | 10.29 | 43.64 | 54.00 | -10.36 |
| 17355.00 | H | Peak | - | - | - | - | - |
| 23140.00 | H | Peak | - | - | - | - | - |
| 28925.00 | H | Peak | - | - | - | - | - |
| 34710.00 | H | Peak | - | - | - | - | - |

Unless otherwise stated the results shown in this test report refer only to the sample(s) tested and such sample(s) are retained for 90 days only.

除非另有說明，此報告結果僅對測試之樣品負責，同時此樣品僅保留90天。本報告未經本公司書面許可，不可部份複製。

This document is issued by the Company subject to its General Conditions of Service printed overleaf, available on request or accessible at www.sgs.com/terms_and_conditions.htm and, for electronic format documents, subject to Terms and Conditions for Electronic Documents at www.sgs.com/terms_e-document.htm. Attention is drawn to the limitation of liability, indemnification and jurisdiction issues defined therein. Any holder of this document is advised that information contained hereon reflects the Company's findings at the time of its intervention only and within the limits of Client's instructions, if any. The Company's sole responsibility is to its Client and this document does not exonerate parties to a transaction from exercising all their rights and obligations under the transaction documents. This document cannot be reproduced except in full, without prior written approval of the Company. Any unauthorized alteration, forgery or falsification of the content or appearance of this document is unlawful and offenders may be prosecuted to the fullest extent of the law.

SGS Taiwan Ltd.

No.134,WuKungRoad,NewTaipeiIndustrialPark,WukuDistrict,NewTaipeiCity,Taiwan24803/新北市五股區新北產業園區五工路 134 號

台灣檢驗科技股份有限公司

t (886-2) 2299-3279

f (886-2) 2298-0488

www.tw.sgs.com

Member of SGS Group

| | | | |
|-----------------------|-----------|--------------------------|------------------|
| Operation Band | :802.11 a | Test Date | :2013-11-17 |
| Fundamental Frequency | :5825 MHz | Temp./Humi. | :25.3 deg_C/54RH |
| Operation Mode | :TX HIGH | Engineer | :Vito |
| EUT Pol. | :E1 Plan | Measurement Antenna Pol. | :VERTICAL |

Actual FS(dBμV/m) = SPA. Reading level(dBμV) + Factor(dB)

Factor(dB) = Antenna Factor(dBμV/m) + Cable Loss(dB) – Pre_Amplifier Gain(dB)

Note : “F” : denotes Fundamental Frequency. ; “H” : denotes Harmonic Frequency.

“E” : denotes Band Edge Frequency. ; “S” : denotes Spurious Frequency.

“--“ : denotes Noise Floor.

| Freq. | Note | Detector Mode | Spectrum Reading Level | Factor | Actual FS | Limit @3m | Margin |
|----------|---------|------------------|---------------------------|--------|--------------|--------------|--------|
| MHz | F/H/E/S | PK/QP/AV | dBμV | dB | dBμV/m | dBμV/m | dB |
| 38.73 | S | Peak | 56.75 | -20.40 | 36.35 | 40.00 | -3.65 |
| 93.05 | S | Peak | 61.45 | -24.20 | 37.24 | 43.50 | -6.26 |
| 101.78 | S | Peak | 58.57 | -22.93 | 35.64 | 43.50 | -7.86 |
| 155.13 | S | Peak | 63.15 | -23.07 | 40.08 | 43.50 | -3.42 |
| 350.10 | S | Peak | 54.14 | -17.38 | 36.76 | 46.00 | -9.24 |
| 400.54 | S | Peak | 58.00 | -15.56 | 42.43 | 46.00 | -3.57 |
| 1399.00 | S | Peak | 56.54 | -9.80 | 46.74 | 74.00 | -27.26 |
| 1399.00 | S | Average | 45.36 | -9.80 | 35.56 | 54.00 | -18.44 |
| 5480.00 | S | Peak | 65.28 | 1.43 | 66.71 | 74.00 | -7.29 |
| 5480.00 | S | Average | 51.62 | 1.43 | 53.05 | 54.00 | -0.95 |
| 11650.00 | H | Peak | 45.41 | 10.43 | 55.83 | 74.00 | -18.17 |
| 11650.00 | H | Average | 33.95 | 10.43 | 44.38 | 54.00 | -9.63 |
| 17475.00 | H | Peak | - | - | - | - | - |
| 23300.00 | H | Peak | - | - | - | - | - |
| 29125.00 | H | Peak | - | - | - | - | - |
| 34950.00 | H | Peak | - | - | - | - | - |

Unless otherwise stated the results shown in this test report refer only to the sample(s) tested and such sample(s) are retained for 90 days only.

除非另有說明，此報告結果僅對測試之樣品負責，同時此樣品僅保留90天。本報告未經本公司書面許可，不可部份複製。

This document is issued by the Company subject to its General Conditions of Service printed overleaf, available on request or accessible at www.sgs.com/terms_and_conditions.htm and, for electronic format documents, subject to Terms and Conditions for Electronic Documents at www.sgs.com/terms_e-document.htm. Attention is drawn to the limitation of liability, indemnification and jurisdiction issues defined therein. Any holder of this document is advised that information contained hereon reflects the Company's findings at the time of its intervention only and within the limits of Client's instructions, if any. The Company's sole responsibility is to its Client and this document does not exonerate parties to a transaction from exercising all their rights and obligations under the transaction documents. This document cannot be reproduced except in full, without prior written approval of the Company. Any unauthorized alteration, forgery or falsification of the content or appearance of this document is unlawful and offenders may be prosecuted to the fullest extent of the law.

SGS Taiwan Ltd.

No.134,WuKungRoad,NewTaipeiIndustrialPark,WukuDistrict,NewTaipeiCity,Taiwan24803/新北市五股區新北產業園區五工路 134 號

台灣檢驗科技股份有限公司

t (886-2) 2299-3279

f (886-2) 2298-0488

www.tw.sgs.com

Member of SGS Group

| | | | |
|-----------------------|-----------|--------------------------|------------------|
| Operation Band | :802.11 a | Test Date | :2013-11-17 |
| Fundamental Frequency | :5825 MHz | Temp./Humi. | :25.3 deg_C/54RH |
| Operation Mode | :TX HIGH | Engineer | :Vito |
| EUT Pol. | :E1 Plan | Measurement Antenna Pol. | :HORIZONTAL |

Actual FS(dBμV/m) = SPA. Reading level(dBμV) + Factor(dB)

Factor(dB) = Antenna Factor(dBμV/m) + Cable Loss(dB) – Pre_Amplifier Gain(dB)

Note : “F” : denotes Fundamental Frequency. ; “H” : denotes Harmonic Frequency.

“E” : denotes Band Edge Frequency. ; “S” : denotes Spurious Frequency.

“--“ : denotes Noise Floor.

| Freq. | Note | Detector Mode | Spectrum Reading Level | Factor | Actual FS | Limit @3m | Margin |
|----------|---------|---------------|------------------------|--------|-----------|-----------|--------|
| MHz | F/H/E/S | PK/QP/AV | dBμV | dB | dBμV/m | dBμV/m | dB |
| 93.05 | S | Peak | 62.54 | -24.20 | 38.34 | 43.50 | -5.16 |
| 100.81 | S | Peak | 58.31 | -23.05 | 35.26 | 43.50 | -8.24 |
| 148.34 | S | Peak | 59.74 | -22.61 | 37.13 | 43.50 | -6.37 |
| 299.66 | S | Peak | 56.85 | -19.05 | 37.80 | 46.00 | -8.20 |
| 350.10 | S | Peak | 53.74 | -17.38 | 36.36 | 46.00 | -9.64 |
| 400.54 | S | Peak | 58.81 | -15.56 | 43.25 | 46.00 | -2.75 |
| 1399.00 | S | Peak | 57.00 | -6.80 | 50.20 | 74.00 | -23.80 |
| 1399.00 | S | Average | 47.19 | -6.80 | 40.39 | 54.00 | -13.61 |
| 5494.00 | S | Peak | 53.00 | 1.44 | 54.44 | 74.00 | -19.56 |
| 5494.00 | S | Average | 38.78 | 1.44 | 40.22 | 54.00 | -13.78 |
| 11650.00 | H | Peak | 42.99 | 10.43 | 53.42 | 74.00 | -20.58 |
| 11650.00 | H | Average | 32.63 | 10.43 | 43.06 | 54.00 | -10.95 |
| 17475.00 | H | Peak | - | - | - | - | - |
| 23300.00 | H | Peak | - | - | - | - | - |
| 29125.00 | H | Peak | - | - | - | - | - |
| 34950.00 | H | Peak | - | - | - | - | - |

Unless otherwise stated the results shown in this test report refer only to the sample(s) tested and such sample(s) are retained for 90 days only.

除非另有說明，此報告結果僅對測試之樣品負責，同時此樣品僅保留90天。本報告未經本公司書面許可，不可部份複製。

This document is issued by the Company subject to its General Conditions of Service printed overleaf, available on request or accessible at www.sgs.com/terms_and_conditions.htm and, for electronic format documents, subject to Terms and Conditions for Electronic Documents at www.sgs.com/terms_e-document.htm. Attention is drawn to the limitation of liability, indemnification and jurisdiction issues defined therein. Any holder of this document is advised that information contained hereon reflects the Company's findings at the time of its intervention only and within the limits of Client's instructions, if any. The Company's sole responsibility is to its Client and this document does not exonerate parties to a transaction from exercising all their rights and obligations under the transaction documents. This document cannot be reproduced except in full, without prior written approval of the Company. Any unauthorized alteration, forgery or falsification of the content or appearance of this document is unlawful and offenders may be prosecuted to the fullest extent of the law.

SGS Taiwan Ltd.

No.134,WuKungRoad,NewTaipeiIndustrialPark,WukuDistrict,NewTaipeiCity,Taiwan24803/新北市五股區新北產業園區五工路 134 號

台灣檢驗科技股份有限公司

t (886-2) 2299-3279

f (886-2) 2298-0488

www.tw.sgs.com

Member of SGS Group

Radiated Spurious Emission Measurement Result (802.11n (5GHz)_20M)

| | | | |
|-----------------------|--------------|--------------------------|------------------|
| Operation Band | :802.11 n20M | Test Date | :2013-11-17 |
| Fundamental Frequency | :5745 MHz | Temp./Humi. | :25.3 deg_C/54RH |
| Operation Mode | :TX LOW | Engineer | :Vito |
| EUT Pol. | :E1 Plan | Measurement Antenna Pol. | :VERTICAL |

Actual FS(dBμV/m) = SPA. Reading level(dBμV) + Factor(dB)

Factor(dB) = Antenna Factor(dBμV/m) + Cable Loss(dB) – Pre_Amplifier Gain(dB)

Note : “F” : denotes Fundamental Frequency. ; “H” : denotes Harmonic Frequency.

“E” : denotes Band Edge Frequency. ; “S” : denotes Spurious Frequency.

“---“ : denotes Noise Floor.

| Freq. | Note | Detector Mode | Spectrum Reading Level | Factor | Actual FS | Limit @3m | Margin |
|----------|---------|------------------|---------------------------|--------|--------------|--------------|--------|
| MHz | F/H/E/S | PK/QP/AV | dBμV | dB | dBμV/m | dBμV/m | dB |
| 38.73 | S | Peak | 56.41 | -20.40 | 36.01 | 40.00 | -3.99 |
| 93.05 | S | Peak | 58.52 | -24.20 | 34.31 | 43.50 | -9.19 |
| 156.10 | S | Peak | 64.80 | -23.01 | 41.79 | 43.50 | -1.71 |
| 350.10 | S | Peak | 55.99 | -17.38 | 38.62 | 46.00 | -7.38 |
| 399.57 | S | Peak | 58.36 | -15.64 | 42.72 | 46.00 | -3.28 |
| 424.79 | S | Peak | 49.14 | -15.22 | 33.92 | 46.00 | -12.08 |
| 1399.00 | S | Peak | 56.96 | -9.80 | 47.16 | 74.00 | -26.84 |
| 1399.00 | S | Average | 45.33 | -9.80 | 35.53 | 54.00 | -18.47 |
| 5529.00 | S | Peak | 64.35 | 1.56 | 65.91 | 74.00 | -8.09 |
| 5529.00 | S | Average | 51.14 | 1.56 | 52.70 | 54.00 | -1.30 |
| 11490.00 | H | Peak | 49.50 | 10.13 | 59.63 | 74.00 | -14.37 |
| 11490.00 | H | Average | 35.90 | 10.13 | 46.03 | 54.00 | -7.97 |
| 17235.00 | H | Peak | - | - | - | - | - |
| 22980.00 | H | Peak | - | - | - | - | - |
| 28725.00 | H | Peak | - | - | - | - | - |
| 34470.00 | H | Peak | - | - | - | - | - |

Unless otherwise stated the results shown in this test report refer only to the sample(s) tested and such sample(s) are retained for 90 days only.

除非另有說明，此報告結果僅對測試之樣品負責，同時此樣品僅保留90天。本報告未經本公司書面許可，不可部份複製。

This document is issued by the Company subject to its General Conditions of Service printed overleaf, available on request or accessible at www.sgs.com/terms_and_conditions.htm and, for electronic format documents, subject to Terms and Conditions for Electronic Documents at www.sgs.com/terms_e-document.htm. Attention is drawn to the limitation of liability, indemnification and jurisdiction issues defined therein. Any holder of this document is advised that information contained hereon reflects the Company's findings at the time of its intervention only and within the limits of Client's instructions, if any. The Company's sole responsibility is to its Client and this document does not exonerate parties to a transaction from exercising all their rights and obligations under the transaction documents. This document cannot be reproduced except in full, without prior written approval of the Company. Any unauthorized alteration, forgery or falsification of the content or appearance of this document is unlawful and offenders may be prosecuted to the fullest extent of the law.

| | | | |
|-----------------------|--------------|--------------------------|------------------|
| Operation Band | :802.11 n20M | Test Date | :2013-11-17 |
| Fundamental Frequency | :5745 MHz | Temp./Humi. | :25.3 deg_C/54RH |
| Operation Mode | :TX LOW | Engineer | :Vito |
| EUT Pol. | :E1 Plan | Measurement Antenna Pol. | :HORIZONTAL |

Actual FS(dBμV/m) = SPA. Reading level(dBμV) + Factor(dB)

Factor(dB) = Antenna Factor(dBμV/m) + Cable Loss(dB) – Pre_Amplifier Gain(dB)

Note : “F” : denotes Fundamental Frequency. ; “H” : denotes Harmonic Frequency.

“E” : denotes Band Edge Frequency. ; “S” : denotes Spurious Frequency.

“--“ : denotes Noise Floor.

| Freq. | Note | Detector Mode | Spectrum Reading Level | Factor | Actual FS | Limit @3m | Margin |
|----------|---------|---------------|------------------------|--------|-----------|-----------|--------|
| MHz | F/H/E/S | PK/QP/AV | dBμV | dB | dBμV/m | dBμV/m | dB |
| 93.05 | S | Peak | 59.10 | -24.20 | 34.89 | 43.50 | -8.61 |
| 100.81 | S | Peak | 57.18 | -23.05 | 34.13 | 43.50 | -9.37 |
| 149.31 | S | Peak | 63.51 | -22.75 | 40.76 | 43.50 | -2.74 |
| 350.10 | S | Peak | 59.38 | -17.38 | 42.00 | 46.00 | -4.00 |
| 375.32 | S | Peak | 56.89 | -16.66 | 40.23 | 46.00 | -5.77 |
| 400.54 | S | Peak | 58.22 | -15.56 | 42.66 | 46.00 | -3.34 |
| 1399.00 | S | Peak | 55.61 | -6.80 | 48.81 | 74.00 | -25.19 |
| 1399.00 | S | Average | 47.25 | -6.80 | 40.45 | 54.00 | -13.55 |
| 5284.00 | S | Peak | 66.11 | 1.22 | 67.33 | 74.00 | -6.67 |
| 5284.00 | S | Average | 50.64 | 1.22 | 51.86 | 54.00 | -0.34 |
| 11490.00 | H | Peak | 45.62 | 10.13 | 55.75 | 74.00 | -18.25 |
| 11490.00 | H | Average | 34.58 | 10.13 | 44.71 | 54.00 | -9.29 |
| 17235.00 | H | Peak | - | - | - | - | - |
| 22980.00 | H | Peak | - | - | - | - | - |
| 28725.00 | H | Peak | - | - | - | - | - |
| 34470.00 | H | Peak | - | - | - | - | - |

Unless otherwise stated the results shown in this test report refer only to the sample(s) tested and such sample(s) are retained for 90 days only.

除非另有說明，此報告結果僅對測試之樣品負責，同時此樣品僅保留90天。本報告未經本公司書面許可，不可部份複製。

This document is issued by the Company subject to its General Conditions of Service printed overleaf, available on request or accessible at www.sgs.com/terms_and_conditions.htm and, for electronic format documents, subject to Terms and Conditions for Electronic Documents at www.sgs.com/terms_e-document.htm. Attention is drawn to the limitation of liability, indemnification and jurisdiction issues defined therein. Any holder of this document is advised that information contained hereon reflects the Company's findings at the time of its intervention only and within the limits of Client's instructions, if any. The Company's sole responsibility is to its Client and this document does not exonerate parties to a transaction from exercising all their rights and obligations under the transaction documents. This document cannot be reproduced except in full, without prior written approval of the Company. Any unauthorized alteration, forgery or falsification of the content or appearance of this document is unlawful and offenders may be prosecuted to the fullest extent of the law.

SGS Taiwan Ltd.

No.134,WuKungRoad,NewTaipeiIndustrialPark,WukuDistrict,NewTaipeiCity,Taiwan24803/新北市五股區新北產業園區五工路 134 號

台灣檢驗科技股份有限公司

t (886-2) 2299-3279

f (886-2) 2298-0488

www.tw.sgs.com

Member of SGS Group

| | | | |
|-----------------------|--------------|--------------------------|------------------|
| Operation Band | :802.11 n20M | Test Date | :2013-11-17 |
| Fundamental Frequency | :5785 MHz | Temp./Humi. | :25.3 deg_C/54RH |
| Operation Mode | :TX MID | Engineer | :Vito |
| EUT Pol. | :E1 Plan | Measurement Antenna Pol. | :VERTICAL |

Actual FS(dBμV/m) = SPA. Reading level(dBμV) + Factor(dB)

Factor(dB) = Antenna Factor(dBμV/m) + Cable Loss(dB) – Pre_Amplifier Gain(dB)

Note : “F” : denotes Fundamental Frequency. ; “H” : denotes Harmonic Frequency.

“E” : denotes Band Edge Frequency. ; “S” : denotes Spurious Frequency.

“--“ : denotes Noise Floor.

| Freq. | Note | Detector Mode | Spectrum Reading Level | Factor | Actual FS | Limit @3m | Margin |
|----------|---------|---------------|------------------------|--------|-----------|-----------|--------|
| MHz | F/H/E/S | PK/QP/AV | dBμV | dB | dBμV/m | dBμV/m | dB |
| 38.73 | S | Peak | 57.08 | -20.40 | 36.68 | 40.00 | -3.32 |
| 100.81 | S | Peak | 61.00 | -23.05 | 37.94 | 43.50 | -5.56 |
| 149.31 | S | Peak | 64.14 | -22.75 | 41.39 | 43.50 | -2.11 |
| 350.10 | S | Peak | 54.41 | -17.38 | 37.03 | 46.00 | -8.97 |
| 375.32 | S | Peak | 51.21 | -16.66 | 34.55 | 46.00 | -11.45 |
| 400.54 | S | Peak | 58.95 | -15.56 | 43.38 | 46.00 | -2.62 |
| 1399.00 | S | Peak | 55.51 | -9.80 | 45.71 | 74.00 | -28.29 |
| 1399.00 | S | Average | 45.28 | -9.80 | 35.48 | 54.00 | -18.52 |
| 5522.00 | S | Peak | 66.48 | 1.53 | 68.01 | 74.00 | -5.99 |
| 5522.00 | S | Average | 52.12 | 1.53 | 53.65 | 54.00 | -0.35 |
| 11570.00 | H | Peak | 47.55 | 10.29 | 57.84 | 74.00 | -16.16 |
| 11570.00 | H | Average | 35.38 | 10.29 | 45.67 | 54.00 | -8.33 |
| 17355.00 | H | Peak | - | - | - | - | - |
| 23140.00 | H | Peak | - | - | - | - | - |
| 28925.00 | H | Peak | - | - | - | - | - |
| 34710.00 | H | Peak | - | - | - | - | - |

Unless otherwise stated the results shown in this test report refer only to the sample(s) tested and such sample(s) are retained for 90 days only.

除非另有說明，此報告結果僅對測試之樣品負責，同時此樣品僅保留90天。本報告未經本公司書面許可，不可部份複製。

This document is issued by the Company subject to its General Conditions of Service printed overleaf, available on request or accessible at www.sgs.com/terms_and_conditions.htm and, for electronic format documents, subject to Terms and Conditions for Electronic Documents at www.sgs.com/terms_e-document.htm. Attention is drawn to the limitation of liability, indemnification and jurisdiction issues defined therein. Any holder of this document is advised that information contained hereon reflects the Company's findings at the time of its intervention only and within the limits of Client's instructions, if any. The Company's sole responsibility is to its Client and this document does not exonerate parties to a transaction from exercising all their rights and obligations under the transaction documents. This document cannot be reproduced except in full, without prior written approval of the Company. Any unauthorized alteration, forgery or falsification of the content or appearance of this document is unlawful and offenders may be prosecuted to the fullest extent of the law.

SGS Taiwan Ltd.

No.134,WuKungRoad,NewTaipeiIndustrialPark,WukuDistrict,NewTaipeiCity,Taiwan24803/新北市五股區新北產業園區五工路 134 號

台灣檢驗科技股份有限公司

t (886-2) 2299-3279

f (886-2) 2298-0488

www.tw.sgs.com

Member of SGS Group

| | | | |
|-----------------------|--------------|--------------------------|------------------|
| Operation Band | :802.11 n20M | Test Date | :2013-11-17 |
| Fundamental Frequency | :5785 MHz | Temp./Humi. | :25.3 deg_C/54RH |
| Operation Mode | :TX MID | Engineer | :Vito |
| EUT Pol. | :E1 Plan | Measurement Antenna Pol. | :HORIZONTAL |

Actual FS(dBμV/m) = SPA. Reading level(dBμV) + Factor(dB)

Factor(dB) = Antenna Factor(dBμV/m) + Cable Loss(dB) – Pre_Amplifier Gain(dB)

Note : “F” : denotes Fundamental Frequency. ; “H” : denotes Harmonic Frequency.

“E” : denotes Band Edge Frequency. ; “S” : denotes Spurious Frequency.

“--“ : denotes Noise Floor.

| Freq. | Note | Detector Mode | Spectrum Reading Level | Factor | Actual FS | Limit @3m | Margin |
|----------|---------|---------------|------------------------|--------|-----------|-----------|--------|
| MHz | F/H/E/S | PK/QP/AV | dBμV | dB | dBμV/m | dBμV/m | dB |
| 101.78 | S | Peak | 59.25 | -22.93 | 36.32 | 43.50 | -7.18 |
| 149.31 | S | Peak | 63.99 | -22.75 | 41.24 | 43.50 | -2.26 |
| 350.10 | S | Peak | 58.48 | -17.38 | 41.10 | 46.00 | -4.90 |
| 375.32 | S | Peak | 57.28 | -16.66 | 40.62 | 46.00 | -5.38 |
| 399.57 | S | Peak | 58.98 | -15.64 | 43.34 | 46.00 | -2.66 |
| 424.79 | S | Peak | 49.88 | -15.22 | 34.66 | 46.00 | -11.34 |
| 1399.00 | S | Peak | 54.81 | -6.80 | 48.01 | 74.00 | -25.99 |
| 1399.00 | S | Average | 47.46 | -6.80 | 40.66 | 54.00 | -13.34 |
| 5284.00 | S | Peak | 65.32 | 1.22 | 66.54 | 74.00 | -7.46 |
| 5284.00 | S | Average | 52.16 | 1.22 | 53.38 | 54.00 | -0.62 |
| 11570.00 | H | Peak | 44.84 | 10.29 | 55.13 | 74.00 | -18.87 |
| 11570.00 | H | Average | 33.26 | 10.29 | 43.55 | 54.00 | -10.45 |
| 17355.00 | H | Peak | - | - | - | - | - |
| 23140.00 | H | Peak | - | - | - | - | - |
| 28925.00 | H | Peak | - | - | - | - | - |
| 34710.00 | H | Peak | - | - | - | - | - |

Unless otherwise stated the results shown in this test report refer only to the sample(s) tested and such sample(s) are retained for 90 days only.

除非另有說明，此報告結果僅對測試之樣品負責，同時此樣品僅保留90天。本報告未經本公司書面許可，不可部份複製。

This document is issued by the Company subject to its General Conditions of Service printed overleaf, available on request or accessible at www.sgs.com/terms_and_conditions.htm and, for electronic format documents, subject to Terms and Conditions for Electronic Documents at www.sgs.com/terms_e-document.htm. Attention is drawn to the limitation of liability, indemnification and jurisdiction issues defined therein. Any holder of this document is advised that information contained hereon reflects the Company's findings at the time of its intervention only and within the limits of Client's instructions, if any. The Company's sole responsibility is to its Client and this document does not exonerate parties to a transaction from exercising all their rights and obligations under the transaction documents. This document cannot be reproduced except in full, without prior written approval of the Company. Any unauthorized alteration, forgery or falsification of the content or appearance of this document is unlawful and offenders may be prosecuted to the fullest extent of the law.

SGS Taiwan Ltd.

No.134,WuKungRoad,NewTaipeiIndustrialPark,WukuDistrict,NewTaipeiCity,Taiwan24803/新北市五股區新北產業園區五工路 134 號

台灣檢驗科技股份有限公司

t (886-2) 2299-3279

f (886-2) 2298-0488

www.tw.sgs.com

Member of SGS Group

| | | | |
|-----------------------|--------------|--------------------------|------------------|
| Operation Band | :802.11 n20M | Test Date | :2013-11-17 |
| Fundamental Frequency | :5825 MHz | Temp./Humi. | :25.3 deg_C/54RH |
| Operation Mode | :TX HIGH | Engineer | :Vito |
| EUT Pol. | :E1 Plan | Measurement Antenna Pol. | :VERTICAL |

Actual FS(dBμV/m) = SPA. Reading level(dBμV) + Factor(dB)

Factor(dB) = Antenna Factor(dBμV/m) + Cable Loss(dB) – Pre_Amplifier Gain(dB)

Note : “F” : denotes Fundamental Frequency. ; “H” : denotes Harmonic Frequency.

“E” : denotes Band Edge Frequency. ; “S” : denotes Spurious Frequency.

“--” : denotes Noise Floor.

| Freq. | Note | Detector Mode | Spectrum Reading Level | Factor | Actual FS | Limit @3m | Margin |
|----------|---------|---------------|------------------------|--------|-----------|-----------|--------|
| MHz | F/H/E/S | PK/QP/AV | dBμV | dB | dBμV/m | dBμV/m | dB |
| 38.73 | S | Peak | 56.14 | -20.40 | 35.74 | 40.00 | -4.26 |
| 101.78 | S | Peak | 59.59 | -22.93 | 36.66 | 43.50 | -6.84 |
| 148.34 | S | Peak | 63.75 | -22.61 | 41.14 | 43.50 | -2.36 |
| 350.10 | S | Peak | 56.03 | -17.38 | 38.66 | 46.00 | -7.34 |
| 375.32 | S | Peak | 52.64 | -16.66 | 35.98 | 46.00 | -10.02 |
| 399.57 | S | Peak | 59.40 | -15.64 | 43.76 | 46.00 | -2.24 |
| 1399.00 | S | Peak | 56.05 | -9.80 | 46.25 | 74.00 | -27.75 |
| 1399.00 | S | Average | 43.87 | -9.80 | 34.07 | 54.00 | -19.93 |
| 5487.00 | S | Peak | 66.05 | 1.44 | 67.48 | 74.00 | -6.52 |
| 5487.00 | S | Average | 51.93 | 1.44 | 53.37 | 54.00 | -0.63 |
| 11650.00 | H | Peak | 45.71 | 10.44 | 56.16 | 74.00 | -17.84 |
| 11650.00 | H | Average | 33.08 | 10.44 | 43.52 | 54.00 | -10.48 |
| 17475.00 | H | Peak | - | - | - | - | - |
| 23300.00 | H | Peak | - | - | - | - | - |
| 29125.00 | H | Peak | - | - | - | - | - |
| 34950.00 | H | Peak | - | - | - | - | - |

Unless otherwise stated the results shown in this test report refer only to the sample(s) tested and such sample(s) are retained for 90 days only.

除非另有說明，此報告結果僅對測試之樣品負責，同時此樣品僅保留90天。本報告未經本公司書面許可，不可部份複製。

This document is issued by the Company subject to its General Conditions of Service printed overleaf, available on request or accessible at www.sgs.com/terms_and_conditions.htm and, for electronic format documents, subject to Terms and Conditions for Electronic Documents at www.sgs.com/terms_e-document.htm. Attention is drawn to the limitation of liability, indemnification and jurisdiction issues defined therein. Any holder of this document is advised that information contained hereon reflects the Company's findings at the time of its intervention only and within the limits of Client's instructions, if any. The Company's sole responsibility is to its Client and this document does not exonerate parties to a transaction from exercising all their rights and obligations under the transaction documents. This document cannot be reproduced except in full, without prior written approval of the Company. Any unauthorized alteration, forgery or falsification of the content or appearance of this document is unlawful and offenders may be prosecuted to the fullest extent of the law.

SGS Taiwan Ltd.

No.134,WuKungRoad,NewTaipeiIndustrialPark,WukuDistrict,NewTaipeiCity,Taiwan24803/新北市五股區新北產業園區五工路 134 號

台灣檢驗科技股份有限公司

t (886-2) 2299-3279

f (886-2) 2298-0488

www.tw.sgs.com

Member of SGS Group

| | | | |
|-----------------------|--------------|--------------------------|------------------|
| Operation Band | :802.11 n20M | Test Date | :2013-11-17 |
| Fundamental Frequency | :5825 MHz | Temp./Humi. | :25.3 deg_C/54RH |
| Operation Mode | :TX HIGH | Engineer | :Vito |
| EUT Pol. | :E1 Plan | Measurement Antenna Pol. | :HORIZONTAL |

Actual FS(dBμV/m) = SPA. Reading level(dBμV) + Factor(dB)

Factor(dB) = Antenna Factor(dBμV/m) + Cable Loss(dB) – Pre_Amplifier Gain(dB)

Note : “F” : denotes Fundamental Frequency. ; “H” : denotes Harmonic Frequency.

“E” : denotes Band Edge Frequency. ; “S” : denotes Spurious Frequency.

“--” : denotes Noise Floor.

| Freq. | Note | Detector Mode | Spectrum Reading Level | Factor | Actual FS | Limit @3m | Margin |
|----------|---------|---------------|------------------------|--------|-----------|-----------|--------|
| MHz | F/H/E/S | PK/QP/AV | dBμV | dB | dBμV/m | dBμV/m | dB |
| 93.05 | S | Peak | 58.22 | -24.20 | 34.02 | 43.50 | -9.48 |
| 100.81 | S | Peak | 60.26 | -23.05 | 37.21 | 43.50 | -6.29 |
| 155.13 | S | Peak | 64.21 | -23.07 | 41.15 | 43.50 | -2.35 |
| 350.10 | S | Peak | 58.81 | -17.38 | 41.43 | 46.00 | -4.57 |
| 375.32 | S | Peak | 57.04 | -16.66 | 40.38 | 46.00 | -5.62 |
| 400.54 | S | Peak | 56.38 | -15.56 | 40.82 | 46.00 | -5.18 |
| 1399.00 | S | Peak | 52.18 | -6.80 | 45.38 | 74.00 | -28.62 |
| 1399.00 | S | Average | 47.11 | -6.80 | 40.31 | 54.00 | -13.69 |
| 5501.00 | S | Peak | 61.24 | 1.44 | 62.69 | 74.00 | -11.31 |
| 5501.00 | S | Average | 48.89 | 1.44 | 50.33 | 54.00 | -3.67 |
| 11650.00 | H | Peak | 43.35 | 10.43 | 53.77 | 74.00 | -20.23 |
| 11650.00 | H | Average | 32.94 | 10.43 | 43.37 | 54.00 | -10.64 |
| 17475.00 | H | Peak | - | - | - | - | - |
| 23300.00 | H | Peak | - | - | - | - | - |
| 29125.00 | H | Peak | - | - | - | - | - |
| 34950.00 | H | Peak | - | - | - | - | - |

Unless otherwise stated the results shown in this test report refer only to the sample(s) tested and such sample(s) are retained for 90 days only.

除非另有說明，此報告結果僅對測試之樣品負責，同時此樣品僅保留90天。本報告未經本公司書面許可，不可部份複製。

This document is issued by the Company subject to its General Conditions of Service printed overleaf, available on request or accessible at www.sgs.com/terms_and_conditions.htm and, for electronic format documents, subject to Terms and Conditions for Electronic Documents at www.sgs.com/terms_e-document.htm. Attention is drawn to the limitation of liability, indemnification and jurisdiction issues defined therein. Any holder of this document is advised that information contained hereon reflects the Company's findings at the time of its intervention only and within the limits of Client's instructions, if any. The Company's sole responsibility is to its Client and this document does not exonerate parties to a transaction from exercising all their rights and obligations under the transaction documents. This document cannot be reproduced except in full, without prior written approval of the Company. Any unauthorized alteration, forgery or falsification of the content or appearance of this document is unlawful and offenders may be prosecuted to the fullest extent of the law.

Radiated Spurious Emission Measurement Result (802.11n (5GHz)_40M)

| | | | |
|-----------------------|--------------|--------------------------|------------------|
| Operation Band | :802.11 n40M | Test Date | :2013-11-17 |
| Fundamental Frequency | :5755 MHz | Temp./Humi. | :25.3 deg_C/54RH |
| Operation Mode | :TX LOW | Engineer | :Vito |
| EUT Pol. | :E1 Plan | Measurement Antenna Pol. | :VERTICAL |

Actual FS(dBμV/m) = SPA. Reading level(dBμV) + Factor(dB)

Factor(dB) = Antenna Factor(dBμV/m) + Cable Loss(dB) – Pre_Amplifier Gain(dB)

Note : “F” : denotes Fundamental Frequency. ; “H” : denotes Harmonic Frequency.

“E” : denotes Band Edge Frequency. ; “S” : denotes Spurious Frequency.

“---“ : denotes Noise Floor.

| Freq. | Note | Detector Mode | Spectrum Reading Level | Factor | Actual FS | Limit @3m | Margin |
|----------|---------|---------------|------------------------|--------|-----------|-----------|--------|
| MHz | F/H/E/S | PK/QP/AV | dBμV | dB | dBμV/m | dBμV/m | dB |
| 44.55 | S | Peak | 59.34 | -23.95 | 35.39 | 40.00 | -4.61 |
| 100.81 | S | Peak | 61.57 | -23.05 | 38.52 | 43.50 | -4.98 |
| 153.19 | S | Peak | 63.74 | -23.00 | 40.74 | 43.50 | -2.76 |
| 350.10 | S | Peak | 55.64 | -17.38 | 38.26 | 46.00 | -7.74 |
| 399.57 | S | Peak | 58.76 | -15.64 | 43.12 | 46.00 | -2.88 |
| 424.79 | S | Peak | 48.70 | -15.22 | 33.48 | 46.00 | -12.52 |
| 1399.00 | S | Peak | 54.67 | -9.80 | 44.87 | 74.00 | -29.13 |
| 1399.00 | S | Average | 44.98 | -9.80 | 35.18 | 54.00 | -18.82 |
| 5487.00 | S | Peak | 61.59 | 1.44 | 63.03 | 74.00 | -10.97 |
| 5487.00 | S | Average | 47.57 | 1.44 | 49.01 | 54.00 | -4.99 |
| 11510.00 | H | Peak | 43.13 | 10.20 | 53.34 | 74.00 | -20.66 |
| 11510.00 | H | Average | 32.36 | 10.20 | 42.56 | 54.00 | -11.44 |
| 17265.00 | H | Peak | - | - | - | - | - |
| 23020.00 | H | Peak | - | - | - | - | - |
| 28775.00 | H | Peak | - | - | - | - | - |
| 34530.00 | H | Peak | - | - | - | - | - |

Unless otherwise stated the results shown in this test report refer only to the sample(s) tested and such sample(s) are retained for 90 days only.

除非另有說明，此報告結果僅對測試之樣品負責，同時此樣品僅保留90天。本報告未經本公司書面許可，不可部份複製。

This document is issued by the Company subject to its General Conditions of Service printed overleaf, available on request or accessible at www.sgs.com/terms_and_conditions.htm and, for electronic format documents, subject to Terms and Conditions for Electronic Documents at www.sgs.com/terms_e-document.htm. Attention is drawn to the limitation of liability, indemnification and jurisdiction issues defined therein. Any holder of this document is advised that information contained hereon reflects the Company's findings at the time of its intervention only and within the limits of Client's instructions, if any. The Company's sole responsibility is to its Client and this document does not exonerate parties to a transaction from exercising all their rights and obligations under the transaction documents. This document cannot be reproduced except in full, without prior written approval of the Company. Any unauthorized alteration, forgery or falsification of the content or appearance of this document is unlawful and offenders may be prosecuted to the fullest extent of the law.

SGS Taiwan Ltd.

No.134,WuKungRoad,NewTaipeiIndustrialPark,WukuDistrict,NewTaipeiCity,Taiwan24803/新北市五股區新北產業園區五工路 134 號

台灣檢驗科技股份有限公司

t (886-2) 2299-3279

f (886-2) 2298-0488

www.tw.sgs.com

Member of SGS Group

| | | | |
|-----------------------|--------------|--------------------------|------------------|
| Operation Band | :802.11 n40M | Test Date | :2013-11-17 |
| Fundamental Frequency | :5755 MHz | Temp./Humi. | :25.3 deg_C/54RH |
| Operation Mode | :TX LOW | Engineer | :Vito |
| EUT Pol. | :E1 Plan | Measurement Antenna Pol. | :HORIZONTAL |

Actual FS(dBμV/m) = SPA. Reading level(dBμV) + Factor(dB)

Factor(dB) = Antenna Factor(dBμV/m) + Cable Loss(dB) – Pre_Amplifier Gain(dB)

Note : “F” : denotes Fundamental Frequency. ; “H” : denotes Harmonic Frequency.

“E” : denotes Band Edge Frequency. ; “S” : denotes Spurious Frequency.

“--” : denotes Noise Floor.

| Freq. | Note | Detector Mode | Spectrum Reading Level | Factor | Actual FS | Limit @3m | Margin |
|----------|---------|---------------|------------------------|--------|-----------|-----------|--------|
| MHz | F/H/E/S | PK/QP/AV | dBμV | dB | dBμV/m | dBμV/m | dB |
| 93.05 | S | Peak | 58.83 | -24.20 | 34.63 | 43.50 | -8.88 |
| 101.78 | S | Peak | 59.95 | -22.93 | 37.02 | 43.50 | -6.48 |
| 149.31 | S | Peak | 63.21 | -22.75 | 40.46 | 43.50 | -3.04 |
| 350.10 | S | Peak | 59.12 | -17.38 | 41.74 | 46.00 | -4.26 |
| 375.32 | S | Peak | 56.92 | -16.66 | 40.26 | 46.00 | -5.74 |
| 399.57 | S | Peak | 59.35 | -15.64 | 43.71 | 46.00 | -2.29 |
| 1399.00 | S | Peak | 57.48 | -6.80 | 50.68 | 74.00 | -23.32 |
| 1399.00 | S | Average | 47.28 | -6.80 | 40.48 | 54.00 | -13.52 |
| 5284.00 | S | Peak | 59.96 | 1.22 | 61.18 | 74.00 | -12.82 |
| 5284.00 | S | Average | 50.68 | 1.22 | 51.90 | 54.00 | -2.10 |
| 11510.00 | H | Peak | 43.47 | 10.20 | 53.67 | 74.00 | -20.33 |
| 11510.00 | H | Average | 32.09 | 10.20 | 42.29 | 54.00 | -11.71 |
| 17265.00 | H | Peak | - | - | - | - | - |
| 23020.00 | H | Peak | - | - | - | - | - |
| 28775.00 | H | Peak | - | - | - | - | - |
| 34530.00 | H | Peak | - | - | - | - | - |

Unless otherwise stated the results shown in this test report refer only to the sample(s) tested and such sample(s) are retained for 90 days only.

除非另有說明，此報告結果僅對測試之樣品負責，同時此樣品僅保留90天。本報告未經本公司書面許可，不可部份複製。

This document is issued by the Company subject to its General Conditions of Service printed overleaf, available on request or accessible at www.sgs.com/terms_and_conditions.htm and, for electronic format documents, subject to Terms and Conditions for Electronic Documents at www.sgs.com/terms_e-document.htm. Attention is drawn to the limitation of liability, indemnification and jurisdiction issues defined therein. Any holder of this document is advised that information contained hereon reflects the Company's findings at the time of its intervention only and within the limits of Client's instructions, if any. The Company's sole responsibility is to its Client and this document does not exonerate parties to a transaction from exercising all their rights and obligations under the transaction documents. This document cannot be reproduced except in full, without prior written approval of the Company. Any unauthorized alteration, forgery or falsification of the content or appearance of this document is unlawful and offenders may be prosecuted to the fullest extent of the law.

SGS Taiwan Ltd.

No.134,WuKungRoad,NewTaipeiIndustrialPark,WukuDistrict,NewTaipeiCity,Taiwan24803/新北市五股區新北產業園區五工路 134 號

台灣檢驗科技股份有限公司

t (886-2) 2299-3279

f (886-2) 2298-0488

www.tw.sgs.com

Member of SGS Group

| | | | |
|-----------------------|--------------|--------------------------|------------------|
| Operation Band | :802.11 n40M | Test Date | :2013-11-17 |
| Fundamental Frequency | :5795 MHz | Temp./Humi. | :25.3 deg_C/54RH |
| Operation Mode | :TX HIGH | Engineer | :Vito |
| EUT Pol. | :E1 Plan | Measurement Antenna Pol. | :VERTICAL |

Actual FS(dBμV/m) = SPA. Reading level(dBμV) + Factor(dB)

Factor(dB) = Antenna Factor(dBμV/m) + Cable Loss(dB) – Pre_Amplifier Gain(dB)

Note : “F” : denotes Fundamental Frequency. ; “H” : denotes Harmonic Frequency.

“E” : denotes Band Edge Frequency. ; “S” : denotes Spurious Frequency.

“--“ : denotes Noise Floor.

| Freq. | Note | Detector Mode | Spectrum Reading Level | Factor | Actual FS | Limit @3m | Margin |
|----------|---------|---------------|------------------------|--------|-----------|-----------|--------|
| MHz | F/H/E/S | PK/QP/AV | dBμV | dB | dBμV/m | dBμV/m | dB |
| 38.73 | S | Peak | 56.45 | -20.40 | 36.05 | 40.00 | -3.95 |
| 101.78 | S | Peak | 60.48 | -22.93 | 37.55 | 43.50 | -5.95 |
| 159.01 | S | Peak | 64.46 | -23.14 | 41.32 | 43.50 | -2.18 |
| 350.10 | S | Peak | 55.72 | -17.38 | 38.34 | 46.00 | -7.66 |
| 375.32 | S | Peak | 52.99 | -16.66 | 36.33 | 46.00 | -9.67 |
| 400.54 | S | Peak | 59.22 | -15.56 | 43.66 | 46.00 | -2.34 |
| 1399.00 | S | Peak | 53.85 | -9.80 | 44.05 | 74.00 | -29.95 |
| 1399.00 | S | Average | 45.27 | -9.80 | 35.47 | 54.00 | -18.53 |
| 5494.00 | S | Peak | 60.58 | 1.44 | 62.01 | 74.00 | -11.99 |
| 5494.00 | S | Average | 47.03 | 1.44 | 48.47 | 54.00 | -5.53 |
| 11590.00 | H | Peak | 42.57 | 10.32 | 52.88 | 74.00 | -21.12 |
| 11590.00 | H | Average | 32.20 | 10.32 | 42.52 | 54.00 | -11.48 |
| 17385.00 | H | Peak | - | - | - | - | - |
| 23180.00 | H | Peak | - | - | - | - | - |
| 28975.00 | H | Peak | - | - | - | - | - |
| 34770.00 | H | Peak | - | - | - | - | - |

Unless otherwise stated the results shown in this test report refer only to the sample(s) tested and such sample(s) are retained for 90 days only.

除非另有說明，此報告結果僅對測試之樣品負責，同時此樣品僅保留90天。本報告未經本公司書面許可，不可部份複製。

This document is issued by the Company subject to its General Conditions of Service printed overleaf, available on request or accessible at www.sgs.com/terms_and_conditions.htm and, for electronic format documents, subject to Terms and Conditions for Electronic Documents at www.sgs.com/terms_e-document.htm. Attention is drawn to the limitation of liability, indemnification and jurisdiction issues defined therein. Any holder of this document is advised that information contained hereon reflects the Company's findings at the time of its intervention only and within the limits of Client's instructions, if any. The Company's sole responsibility is to its Client and this document does not exonerate parties to a transaction from exercising all their rights and obligations under the transaction documents. This document cannot be reproduced except in full, without prior written approval of the Company. Any unauthorized alteration, forgery or falsification of the content or appearance of this document is unlawful and offenders may be prosecuted to the fullest extent of the law.

SGS Taiwan Ltd.

No.134,WuKungRoad,NewTaipeiIndustrialPark,WukuDistrict,NewTaipeiCity,Taiwan24803/新北市五股區新北產業園區五工路 134 號

台灣檢驗科技股份有限公司

t (886-2) 2299-3279

f (886-2) 2298-0488

www.tw.sgs.com

Member of SGS Group

| | | | |
|-----------------------|--------------|--------------------------|------------------|
| Operation Band | :802.11 n40M | Test Date | :2013-11-17 |
| Fundamental Frequency | :5795 MHz | Temp./Humi. | :25.3 deg_C/54RH |
| Operation Mode | :TX HIGH | Engineer | :Vito |
| EUT Pol. | :E1 Plan | Measurement Antenna Pol. | :HORIZONTAL |

Actual FS(dBμV/m) = SPA. Reading level(dBμV) + Factor(dB)

Factor(dB) = Antenna Factor(dBμV/m) + Cable Loss(dB) – Pre_Amplifier Gain(dB)

Note : “F” : denotes Fundamental Frequency. ; “H” : denotes Harmonic Frequency.

“E” : denotes Band Edge Frequency. ; “S” : denotes Spurious Frequency.

“--” : denotes Noise Floor.

| Freq. | Note | Detector Mode | Spectrum Reading Level | Factor | Actual FS | Limit @3m | Margin |
|----------|---------|---------------|------------------------|--------|-----------|-----------|--------|
| MHz | F/H/E/S | PK/QP/AV | dBμV | dB | dBμV/m | dBμV/m | dB |
| 93.05 | S | Peak | 58.35 | -24.20 | 34.15 | 43.50 | -9.35 |
| 100.81 | S | Peak | 60.29 | -23.05 | 37.24 | 43.50 | -6.26 |
| 152.22 | S | Peak | 62.42 | -22.90 | 39.52 | 43.50 | -3.98 |
| 350.10 | S | Peak | 58.41 | -17.38 | 41.03 | 46.00 | -4.97 |
| 375.32 | S | Peak | 57.11 | -16.66 | 40.45 | 46.00 | -5.55 |
| 399.57 | S | Peak | 58.00 | -15.64 | 42.36 | 46.00 | -3.64 |
| 1399.00 | S | Peak | 56.43 | -6.80 | 49.63 | 74.00 | -24.37 |
| 1399.00 | S | Average | 47.18 | -6.80 | 40.38 | 54.00 | -13.62 |
| 5564.00 | S | Peak | 60.98 | 1.70 | 62.68 | 74.00 | -11.32 |
| 5564.00 | S | Average | 51.22 | 1.70 | 52.92 | 54.00 | -1.08 |
| 11590.00 | H | Peak | 43.25 | 10.32 | 53.56 | 74.00 | -20.44 |
| 11590.00 | H | Average | 32.04 | 10.32 | 42.36 | 54.00 | -11.64 |
| 17385.00 | H | Peak | - | - | - | - | - |
| 23180.00 | H | Peak | - | - | - | - | - |
| 28975.00 | H | Peak | - | - | - | - | - |
| 34770.00 | H | Peak | - | - | - | - | - |

Unless otherwise stated the results shown in this test report refer only to the sample(s) tested and such sample(s) are retained for 90 days only.

除非另有說明，此報告結果僅對測試之樣品負責，同時此樣品僅保留90天。本報告未經本公司書面許可，不可部份複製。

This document is issued by the Company subject to its General Conditions of Service printed overleaf, available on request or accessible at www.sgs.com/terms_and_conditions.htm and, for electronic format documents, subject to Terms and Conditions for Electronic Documents at www.sgs.com/terms_e-document.htm. Attention is drawn to the limitation of liability, indemnification and jurisdiction issues defined therein. Any holder of this document is advised that information contained hereon reflects the Company's findings at the time of its intervention only and within the limits of Client's instructions, if any. The Company's sole responsibility is to its Client and this document does not exonerate parties to a transaction from exercising all their rights and obligations under the transaction documents. This document cannot be reproduced except in full, without prior written approval of the Company. Any unauthorized alteration, forgery or falsification of the content or appearance of this document is unlawful and offenders may be prosecuted to the fullest extent of the law.

SGS Taiwan Ltd.

No.134,WuKungRoad,NewTaipeiIndustrialPark,WukuDistrict,NewTaipeiCity,Taiwan24803/新北市五股區新北產業園區五工路 134 號

台灣檢驗科技股份有限公司

t (886-2) 2299-3279

f (886-2) 2298-0488

www.tw.sgs.com

Member of SGS Group

11 PEAK POWER SPECTRAL DENSITY

11.1 Standard Applicable:

According to §15.247(e) For digitally modulated systems, the power spectral density conducted from the intentional radiator to the antenna shall not be greater than 8dBm in any 3 kHz band during any time interval of continuous transmission. This power spectral density shall be determined in accordance with the provisions of paragraph (b) of this section. The same method of determining the conducted output power shall be used to determine the power spectral density.

According to RSS-210 issue 8, §A8.2(b) The transmitter power spectral density (into the antenna) shall not be greater than 8 dBm in any 3 kHz band during any time interval of continuous transmission.

11.2 Measurement Equipment Used:

Refer to section 7.2 for details.

11.3 Test Set-up:

Refer to section 7.3 for details. (Spectrum Option)

Unless otherwise stated the results shown in this test report refer only to the sample(s) tested and such sample(s) are retained for 90 days only.

除非另有說明，此報告結果僅對測試之樣品負責，同時此樣品僅保留90天。本報告未經本公司書面許可，不可部份複製。

This document is issued by the Company subject to its General Conditions of Service printed overleaf, available on request or accessible at www.sgs.com/terms_and_conditions.htm and, for electronic format documents, subject to Terms and Conditions for Electronic Documents at www.sgs.com/terms_e-document.htm. Attention is drawn to the limitation of liability, indemnification and jurisdiction issues defined therein. Any holder of this document is advised that information contained hereon reflects the Company's findings at the time of its intervention only and within the limits of Client's instructions, if any. The Company's sole responsibility is to its Client and this document does not exonerate parties to a transaction from exercising all their rights and obligations under the transaction documents. This document cannot be reproduced except in full, without prior written approval of the Company. Any unauthorized alteration, forgery or falsification of the content or appearance of this document is unlawful and offenders may be prosecuted to the fullest extent of the law.

SGS Taiwan Ltd.

No.134,WuKungRoad,NewTaipeiIndustrialPark,WukuDistrict,NewTaipeiCity,Taiwan24803/新北市五股區新北產業園區五工路 134 號

台灣檢驗科技股份有限公司

t (886-2) 2299-3279

f (886-2) 2298-0488

www.tw.sgs.com

Member of SGS Group

11.4 Measurement Procedure (following the measurement procedure 10.2 of KDB558074):

1. Set analyzer center frequency to DTS channel center frequency.
2. Set the span to 1.5 times the DTS channel bandwidth.
3. Set the RBW ≥ 3 kHz.
4. Set the VBW $\geq 3 \times$ RBW.
5. Detector = peak.
6. Sweep time = auto couple.
7. Trace mode = max hold.
8. Allow trace to fully stabilize.
9. Use the peak marker function to determine the maximum amplitude level.
10. If measured value exceeds limit, reduce RBW (no less than 3 kHz) and repeat.
11. The resulting peak PSD level must be ≤ 8 dBm.
12. 802.11n MIMO mode: offset is set following “measure and add 10 Log (N)” on spectrum to measure the PSD for MIMO mode. Offset = cable loss + 10 log (N), where N is number of transmitting antenna. N=2 for this given application.

Note: For the test of PSD at MIMO mode, the highest emission of worst case employing Measure and add 10 log (N) technical is reported on this report after the comparison between Main Antenna at single transmitting mode and Aux that yields the higher value. . The single transmitting mode is only reported measurement that produces higher value of outcome.

Unless otherwise stated the results shown in this test report refer only to the sample(s) tested and such sample(s) are retained for 90 days only.

除非另有說明，此報告結果僅對測試之樣品負責，同時此樣品僅保留90天。本報告未經本公司書面許可，不可部份複製。

This document is issued by the Company subject to its General Conditions of Service printed overleaf, available on request or accessible at www.sgs.com/terms_and_conditions.htm and, for electronic format documents, subject to Terms and Conditions for Electronic Documents at www.sgs.com/terms_e-document.htm. Attention is drawn to the limitation of liability, indemnification and jurisdiction issues defined therein. Any holder of this document is advised that information contained hereon reflects the Company's findings at the time of its intervention only and within the limits of Client's instructions, if any. The Company's sole responsibility is to its Client and this document does not exonerate parties to a transaction from exercising all their rights and obligations under the transaction documents. This document cannot be reproduced except in full, without prior written approval of the Company. Any unauthorized alteration, forgery or falsification of the content or appearance of this document is unlawful and offenders may be prosecuted to the fullest extent of the law.

SGS Taiwan Ltd.

台灣檢驗科技股份有限公司

No.134,WuKungRoad,NewTaipeiIndustrialPark,WukuDistrict,NewTaipeiCity,Taiwan24803/新北市五股區新北產業園區五工路 134 號

t (886-2) 2299-3279

f (886-2) 2298-0488

www.tw.sgs.com

Member of SGS Group

11.5 Measurement Result:

802.11a

| Frequency MHz | RF Power Density Reading (dBm) | Maximum Limit (dBm) |
|------------------|-----------------------------------|------------------------|
| 5745 | -11.38 | 8 |
| 5785 | -12.01 | 8 |
| 5825 | -12.08 | 8 |

802.11n (5GHz)_20M_MIMO

| Frequency MHz | RF Power Density Reading (dBm) | Maximum Limit (dBm) |
|------------------|-----------------------------------|------------------------|
| 5745 | -8.05 | 8 |
| 5785 | -8.97 | 8 |
| 5825 | -7.66 | 8 |

802.11n (5GHz)_40M_MIMO

| Frequency MHz | RF Power Density Reading (dBm) | Maximum Limit (dBm) |
|------------------|-----------------------------------|------------------------|
| 5755 | -17.64 | 8 |
| 5795 | -16.82 | 8 |

* Note: Offset 11dB for 5G 802.11a; Offset 14.01dB for 5G 802.11/n_20/n_40.

*Refer to next page for plots

Unless otherwise stated the results shown in this test report refer only to the sample(s) tested and such sample(s) are retained for 90 days only.

除非另有說明，此報告結果僅對測試之樣品負責，同時此樣品僅保留90天。本報告未經本公司書面許可，不可部份複製。

This document is issued by the Company subject to its General Conditions of Service printed overleaf, available on request or accessible at www.sgs.com/terms_and_conditions.htm and, for electronic format documents, subject to Terms and Conditions for Electronic Documents at www.sgs.com/terms_e-document.htm. Attention is drawn to the limitation of liability, indemnification and jurisdiction issues defined therein. Any holder of this document is advised that information contained hereon reflects the Company's findings at the time of its intervention only and within the limits of Client's instructions, if any. The Company's sole responsibility is to its Client and this document does not exonerate parties to a transaction from exercising all their rights and obligations under the transaction documents. This document cannot be reproduced except in full, without prior written approval of the Company. Any unauthorized alteration, forgery or falsification of the content or appearance of this document is unlawful and offenders may be prosecuted to the fullest extent of the law.

SGS Taiwan Ltd.

No.134,WuKungRoad,NewTaipeiIndustrialPark,WukuDistrict,NewTaipeiCity,Taiwan24803/新北市五股區新北產業園區五工路 134 號

台灣檢驗科技股份有限公司

t (886-2) 2299-3279

f (886-2) 2298-0488

www.tw.sgs.com

Member of SGS Group

802.11a

Power Spectral Density Test Plot (CH-Low)



Power Spectral Density Test Plot (CH-Mid)

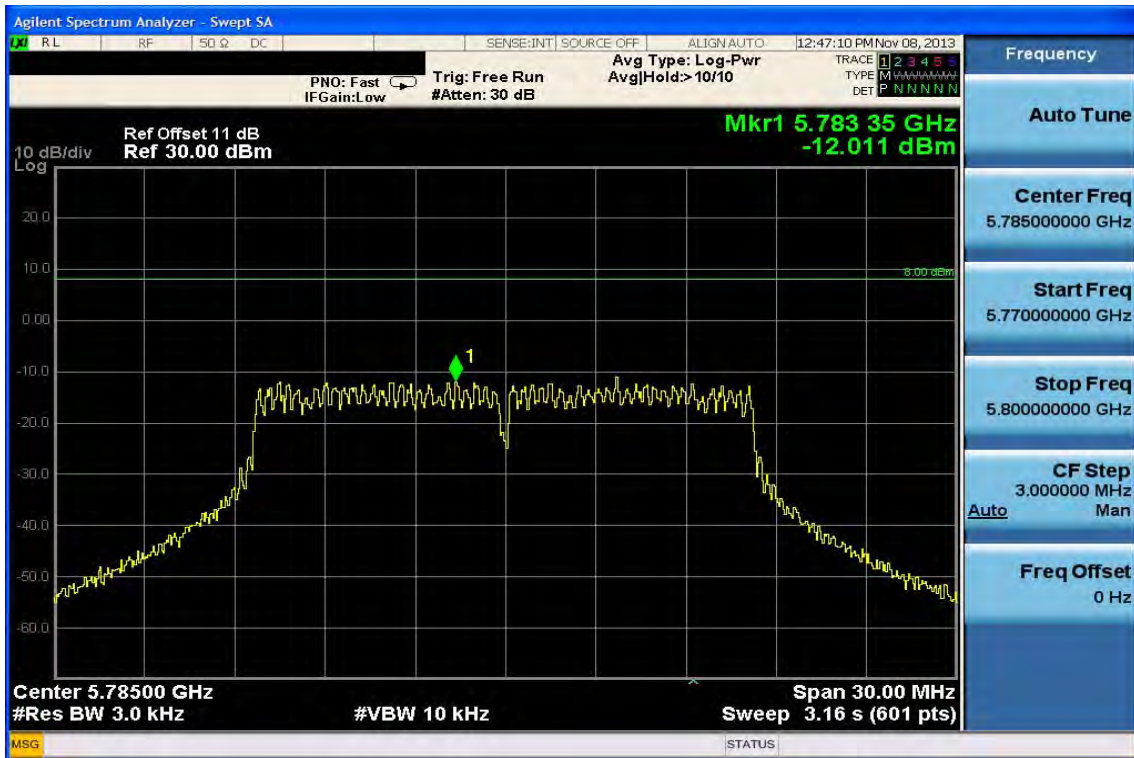

Unless otherwise stated the results shown in this test report refer only to the sample(s) tested and such sample(s) are retained for 90 days only.

除非另有說明，此報告結果僅對測試之樣品負責，同時此樣品僅保留90天。本報告未經本公司書面許可，不可部份複製。

This document is issued by the Company subject to its General Conditions of Service printed overleaf, available on request or accessible at www.sgs.com/terms_and_conditions.htm and, for electronic format documents, subject to Terms and Conditions for Electronic Documents at www.sgs.com/terms_e-document.htm. Attention is drawn to the limitation of liability, indemnification and jurisdiction issues defined therein. Any holder of this document is advised that information contained hereon reflects the Company's findings at the time of its intervention only and within the limits of Client's instructions, if any. The Company's sole responsibility is to its Client and this document does not exonerate parties to a transaction from exercising all their rights and obligations under the transaction documents. This document cannot be reproduced except in full, without prior written approval of the Company. Any unauthorized alteration, forgery or falsification of the content or appearance of this document is unlawful and offenders may be prosecuted to the fullest extent of the law.

SGS Taiwan Ltd.

No. 134, WuKungRoad, NewTaipeiIndustrialPark, WukuDistrict, NewTaipeiCity, Taiwan24803/新北市五股區新北產業園區五工路 134 號

台灣檢驗科技股份有限公司

t (886-2) 2299-3279

f (886-2) 2298-0488

www.tw.sgs.com

Member of SGS Group

Power Spectral Density Test Plot (CH-High)

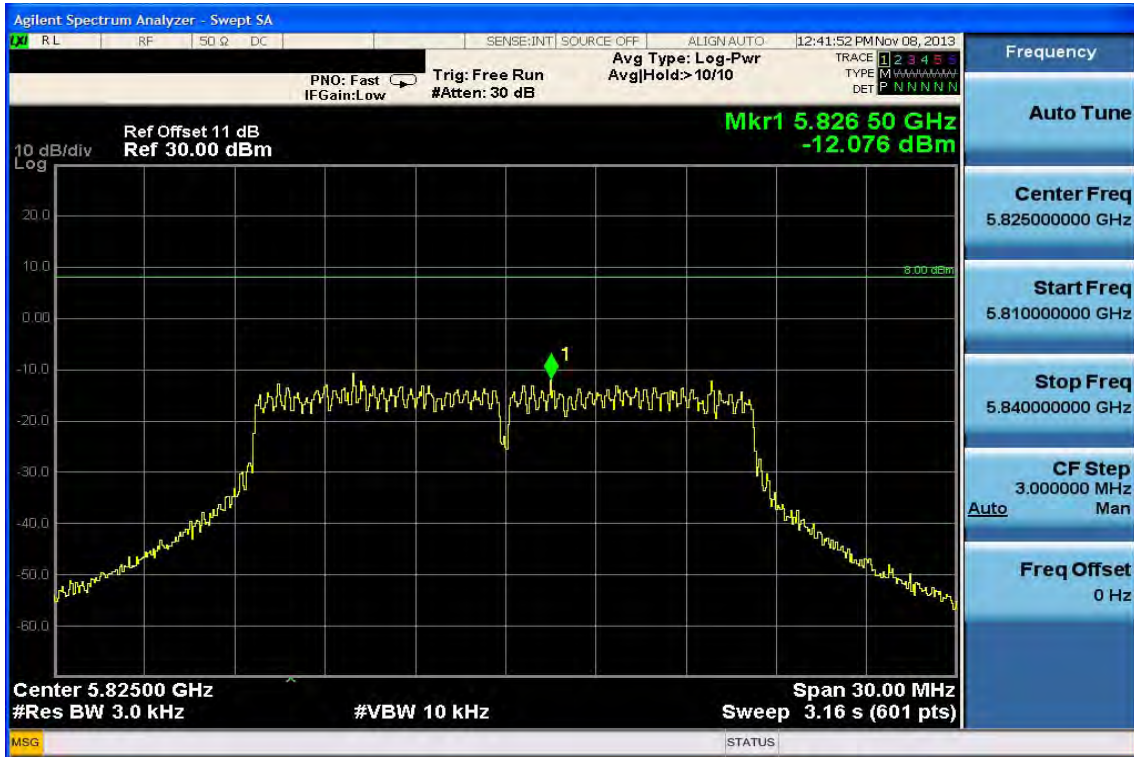

802.11n (5GHz)_20M

Power Spectral Density Test Plot (CH-Low)

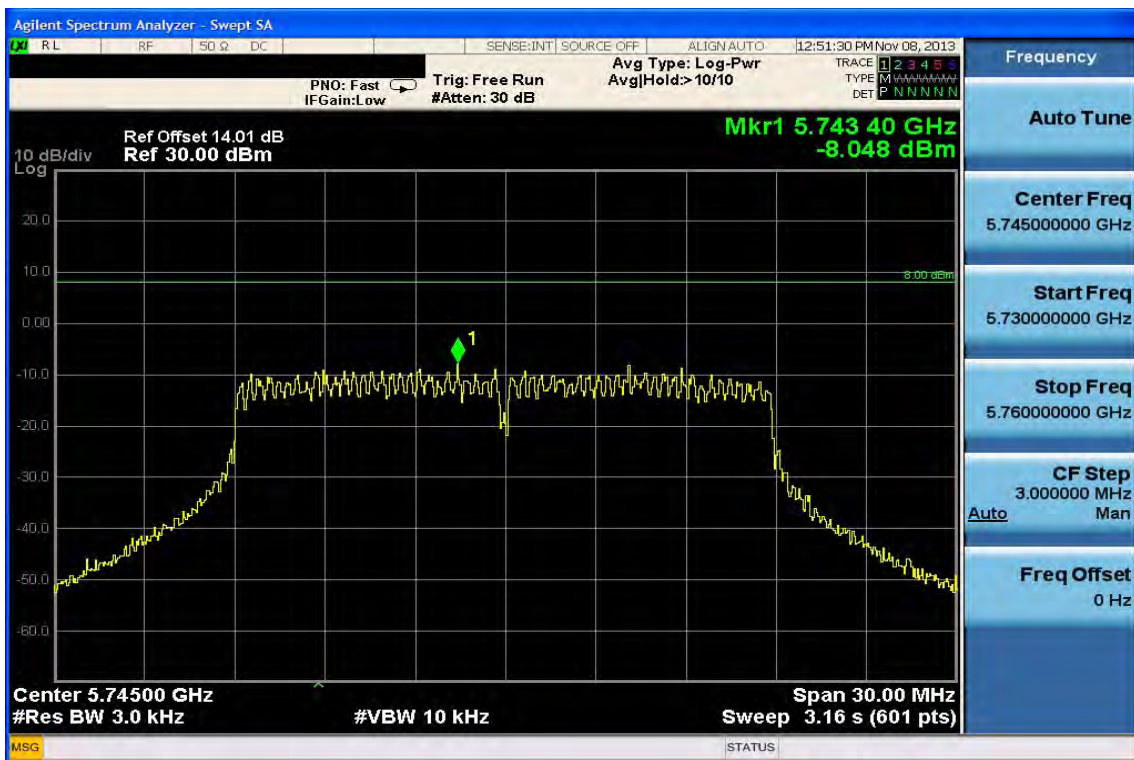

Unless otherwise stated the results shown in this test report refer only to the sample(s) tested and such sample(s) are retained for 90 days only.

除非另有說明，此報告結果僅對測試之樣品負責，同時此樣品僅保留90天。本報告未經本公司書面許可，不可部份複製。

This document is issued by the Company subject to its General Conditions of Service printed overleaf, available on request or accessible at www.sgs.com/terms_and_conditions.htm and, for electronic format documents, subject to Terms and Conditions for Electronic Documents at www.sgs.com/terms_e-document.htm. Attention is drawn to the limitation of liability, indemnification and jurisdiction issues defined therein. Any holder of this document is advised that information contained hereon reflects the Company's findings at the time of its intervention only and within the limits of Client's instructions, if any. The Company's sole responsibility is to its Client and this document does not exonerate parties to a transaction from exercising all their rights and obligations under the transaction documents. This document cannot be reproduced except in full, without prior written approval of the Company. Any unauthorized alteration, forgery or falsification of the content or appearance of this document is unlawful and offenders may be prosecuted to the fullest extent of the law.

Power Spectral Density Test Plot (CH-Mid)

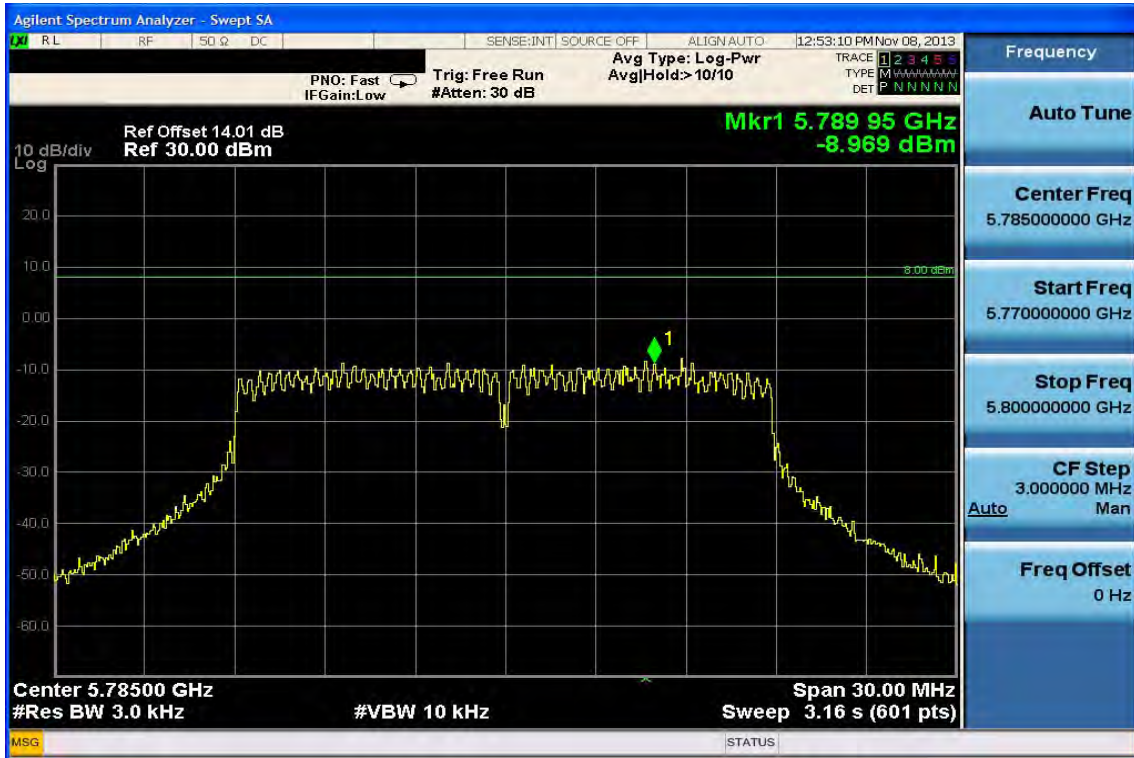

Power Spectral Density Test Plot (CH-High)

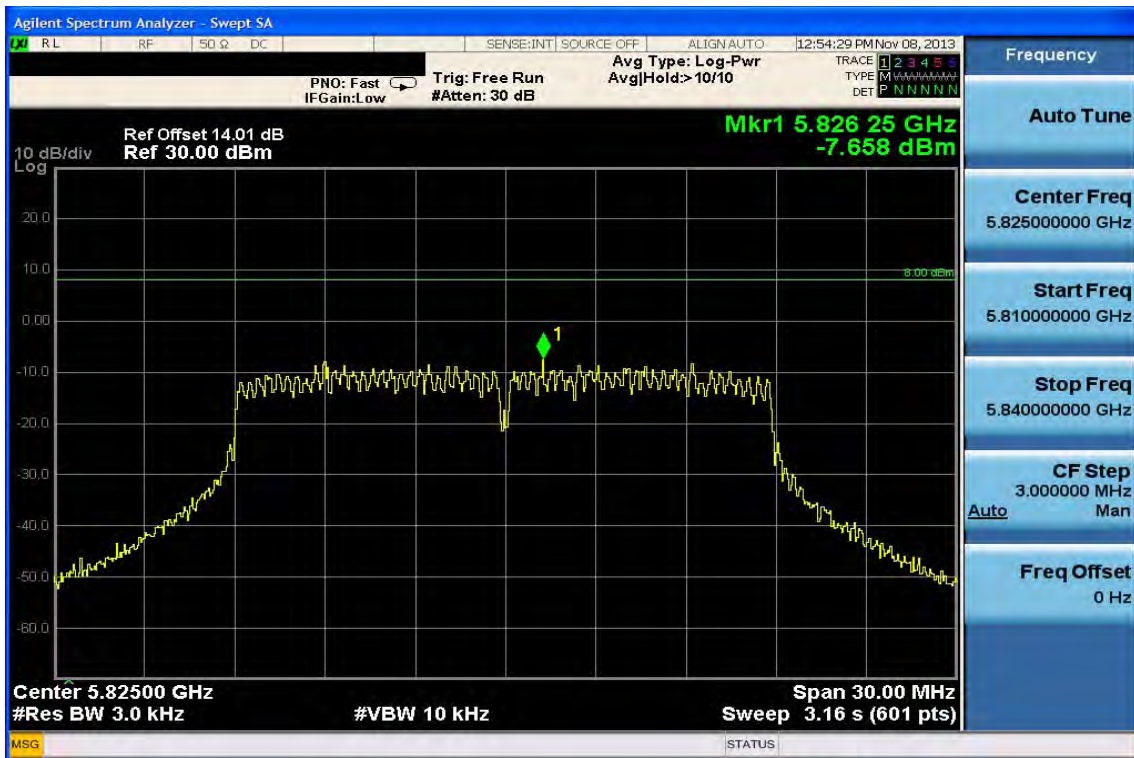

Unless otherwise stated the results shown in this test report refer only to the sample(s) tested and such sample(s) are retained for 90 days only.

除非另有說明，此報告結果僅對測試之樣品負責，同時此樣品僅保留90天。本報告未經本公司書面許可，不可部份複製。

This document is issued by the Company subject to its General Conditions of Service printed overleaf, available on request or accessible at www.sgs.com/terms_and_conditions.htm and, for electronic format documents, subject to Terms and Conditions for Electronic Documents at www.sgs.com/terms_e-document.htm. Attention is drawn to the limitation of liability, indemnification and jurisdiction issues defined therein. Any holder of this document is advised that information contained hereon reflects the Company's findings at the time of its intervention only and within the limits of Client's instructions, if any. The Company's sole responsibility is to its Client and this document does not exonerate parties to a transaction from exercising all their rights and obligations under the transaction documents. This document cannot be reproduced except in full, without prior written approval of the Company. Any unauthorized alteration, forgery or falsification of the content or appearance of this document is unlawful and offenders may be prosecuted to the fullest extent of the law.

SGS Taiwan Ltd.

No. 134, WuKungRoad, NewTaipeiIndustrialPark, WukuDistrict, NewTaipeiCity, Taiwan24803/新北市五股區新北產業園區五工路 134 號

台灣檢驗科技股份有限公司

t (886-2) 2299-3279

f (886-2) 2298-0488

www.tw.sgs.com

Member of SGS Group

802.11n (5GHz)_40M

Power Spectral Density Test Plot (CH-Low)

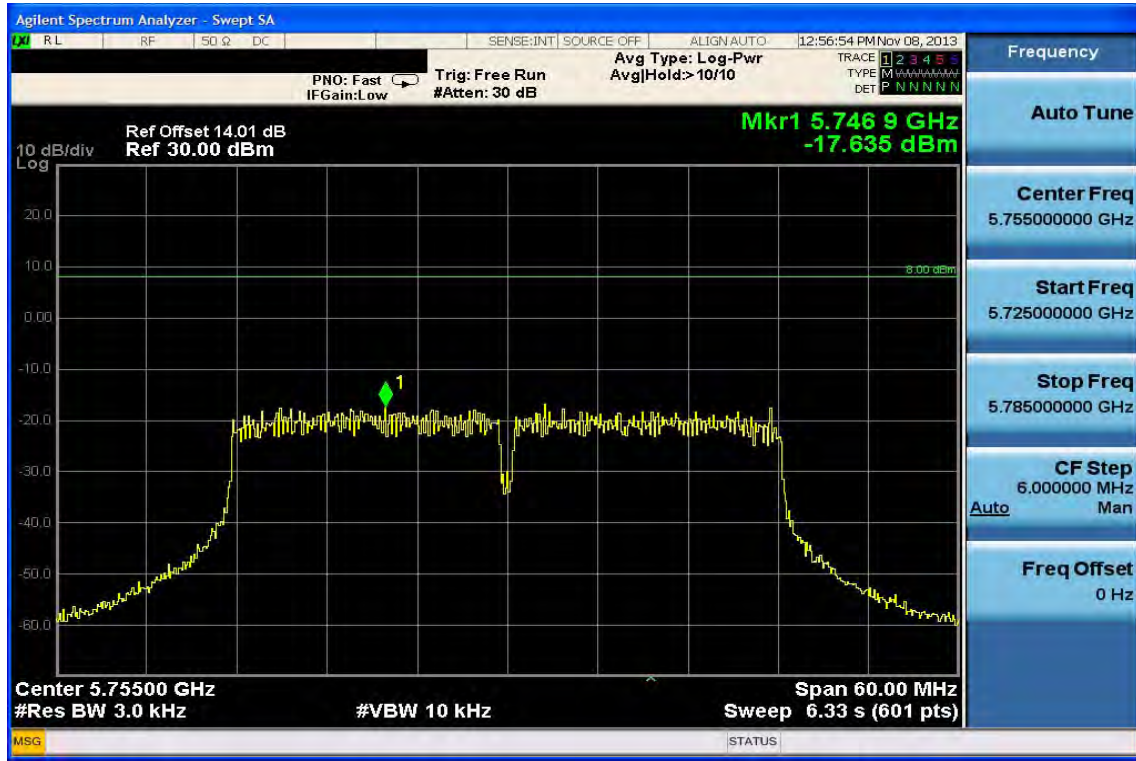

Power Spectral Density Test Plot (CH-High)

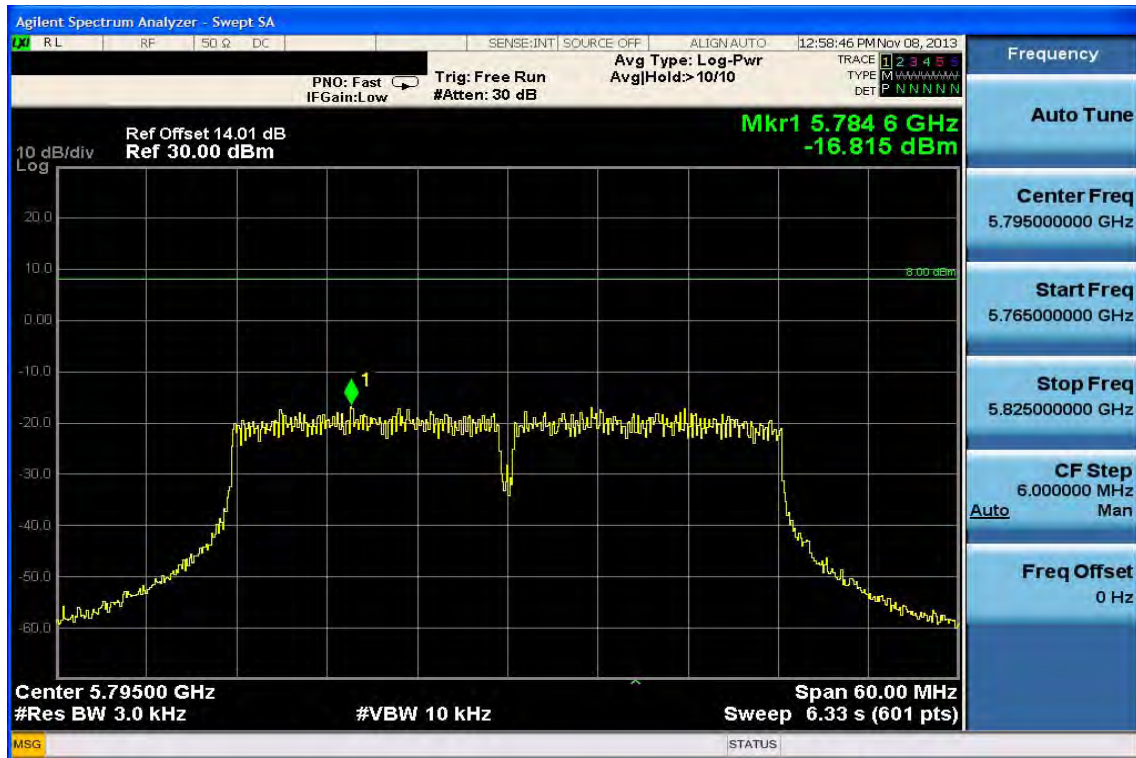

Unless otherwise stated the results shown in this test report refer only to the sample(s) tested and such sample(s) are retained for 90 days only.

除非另有說明，此報告結果僅對測試之樣品負責，同時此樣品僅保留90天。本報告未經本公司書面許可，不可部份複製。

This document is issued by the Company subject to its General Conditions of Service printed overleaf, available on request or accessible at www.sgs.com/terms_and_conditions.htm and, for electronic format documents, subject to Terms and Conditions for Electronic Documents at www.sgs.com/terms_e-document.htm. Attention is drawn to the limitation of liability, indemnification and jurisdiction issues defined therein. Any holder of this document is advised that information contained hereon reflects the Company's findings at the time of its intervention only and within the limits of Client's instructions, if any. The Company's sole responsibility is to its Client and this document does not exonerate parties to a transaction from exercising all their rights and obligations under the transaction documents. This document cannot be reproduced except in full, without prior written approval of the Company. Any unauthorized alteration, forgery or falsification of the content or appearance of this document is unlawful and offenders may be prosecuted to the fullest extent of the law.

12 ANTENNA REQUIREMENT

12.1 Standard Applicable:

For intentional device, according to §15.203, an intentional radiator shall be designed to ensure that no antenna other than furnished by the responsible party shall be used with the device.

According to RSS-GEN 7.1.2, a transmitter can only be sold or operated with antennas with which it was certified. A transmitter may be certified with multiple antenna types. An antenna type comprises antennas having similar in-band and out-of-band radiation patterns. Testing shall be performed using the highest-gain antenna of each combination of transmitter and antenna type for which certification is being sought, with the transmitter output power set at the maximum level. Any antenna of the same type and having equal or lesser gain as an antenna that had been successfully tested for certification with the transmitter, will also be considered certified with the transmitter, and may be used and marketed with the transmitter. The manufacturer shall include with the application for certification a list of acceptable antenna types to be used with the transmitter.

When a measurement at the antenna connector is used to determine RF output power, the effective gain of the device's antenna shall be stated, based on measurement or on data from the antenna manufacturer. Any antenna gain in excess of 6 dBi (6 dB above isotropic gain) shall be added to the measured RF output power before using the power limits specified in RSS-210 or RSS-310 for devices of RF output powers of 10 milliwatts or less. For devices of output powers greater than 10 milliwatts, except devices subject to RSS-210 Annex 8 (Frequency Hopping and Digital Modulation Systems Operating in the 902-928 MHz, 2400-2483.5 MHz, and 5725-5850 MHz Bands) or RSS-210 Annex 9 (Local Area Network Devices), the total antenna gain shall be added to the measured RF output power before using the specified power limits. For devices subject to RSS-210 Annex 8 or Annex 9, the antenna gain shall not be added.

12.2 Antenna Connected Construction:

The directional gains of antenna used for transmitting is 10.92dBi (Main), 8.22dBi (Aux) for 5725-5850 MHz, and 9.96dBi for 5.8G MIMO In addition, the antenna connector is designed with unique type RF connector and no consideration of replacement. Please see EUT photo and antenna spec. for details.

Unless otherwise stated the results shown in this test report refer only to the sample(s) tested and such sample(s) are retained for 90 days only.

除非另有說明，此報告結果僅對測試之樣品負責，同時此樣品僅保留90天。本報告未經本公司書面許可，不可部份複製。

This document is issued by the Company subject to its General Conditions of Service printed overleaf, available on request or accessible at www.sgs.com/terms_and_conditions.htm and, for electronic format documents, subject to Terms and Conditions for Electronic Documents at www.sgs.com/terms_e-document.htm. Attention is drawn to the limitation of liability, indemnification and jurisdiction issues defined therein. Any holder of this document is advised that information contained hereon reflects the Company's findings at the time of its intervention only and within the limits of Client's instructions, if any. The Company's sole responsibility is to its Client and this document does not exonerate parties to a transaction from exercising all their rights and obligations under the transaction documents. This document cannot be reproduced except in full, without prior written approval of the Company. Any unauthorized alteration, forgery or falsification of the content or appearance of this document is unlawful and offenders may be prosecuted to the fullest extent of the law.

SGS Taiwan Ltd.

台灣檢驗科技股份有限公司

No.134,WuKungRoad,NewTaipeiIndustrialPark,WukuDistrict,NewTaipeiCity,Taiwan24803/新北市五股區新北產業園區五工路 134 號

t (886-2) 2299-3279

f (886-2) 2298-0488

www.tw.sgs.com

Member of SGS Group

13 99% BANDWIDTH MEASUREMENT

13.1 Standard Applicable:

RSS-Gen §4.6.1, the transmitter shall be operated at its maximum carrier power measured under normal test conditions. The span of the analyzer shall be set to capture all products of the modulation process, including the emission skirts. The resolution bandwidth shall be set to as close to 1% of the selected span as is possible without being below 1%. The video bandwidth shall be set to 3 times the resolution bandwidth. Video averaging is not permitted. Where practical, a sampling detector shall be used since a peak or, peak hold, may produce a wider bandwidth than actual.

The trace data points are recovered and are directly summed in linear terms. The recovered amplitude data points, beginning at the lowest frequency, are placed in a running sum until 0.5% of the total is reached and that frequency recorded. The process is repeated for the highest frequency data points. This frequency is recorded.

The span between the two recorded frequencies is the occupied bandwidth.

13.2 Measurement Equipment Used:

Refer to section 7.2 for details.

13.3 Test Set-up:

Refer to section 7.3 for details. (Spectrum analyzer)

13.4 Measurement Procedure:

1. Place the EUT on the table and set it in transmitting mode.
2. Remove the antenna from the EUT and then connect a low loss RF cable from the antenna port to the spectrum analyzer.
3. Set the spectrum analyzer as RBW=1% of the Span, VBW = 3 times RBW, Span= 30 MHz /50MHz.
4. Turn on the 99% bandwidth function, max reading..
5. Repeat above procedures until all frequency measured were complete.

Unless otherwise stated the results shown in this test report refer only to the sample(s) tested and such sample(s) are retained for 90 days only.

除非另有說明，此報告結果僅對測試之樣品負責，同時此樣品僅保留90天。本報告未經本公司書面許可，不可部份複製。

This document is issued by the Company subject to its General Conditions of Service printed overleaf, available on request or accessible at www.sgs.com/terms_and_conditions.htm and, for electronic format documents, subject to Terms and Conditions for Electronic Documents at www.sgs.com/terms_e-document.htm. Attention is drawn to the limitation of liability, indemnification and jurisdiction issues defined therein. Any holder of this document is advised that information contained hereon reflects the Company's findings at the time of its intervention only and within the limits of Client's instructions, if any. The Company's sole responsibility is to its Client and this document does not exonerate parties to a transaction from exercising all their rights and obligations under the transaction documents. This document cannot be reproduced except in full, without prior written approval of the Company. Any unauthorized alteration, forgery or falsification of the content or appearance of this document is unlawful and offenders may be prosecuted to the fullest extent of the law.

13.5 Measurement Result:

802.11a

| Frequency MHz | 99%Bandwidth (MHz) |
|------------------|-----------------------|
| 5745 | 16.521 |
| 5785 | 16.536 |
| 5825 | 16.484 |

802.11n (5GHz)_20M MIMO-Main

| Frequency MHz | 99%Bandwidth (MHz) |
|------------------|-----------------------|
| 5745 | 17.773 |
| 5785 | 17.719 |
| 5825 | 17.827 |

802.11n (5GHz)_20M MIMO-Aux

| Frequency MHz | 99%Bandwidth (MHz) |
|------------------|-----------------------|
| 5745 | 17.409 |
| 5785 | 17.333 |
| 5825 | 17.671 |

Unless otherwise stated the results shown in this test report refer only to the sample(s) tested and such sample(s) are retained for 90 days only.

除非另有說明，此報告結果僅對測試之樣品負責，同時此樣品僅保留90天。本報告未經本公司書面許可，不可部份複製。

This document is issued by the Company subject to its General Conditions of Service printed overleaf, available on request or accessible at www.sgs.com/terms_and_conditions.htm and, for electronic format documents, subject to Terms and Conditions for Electronic Documents at www.sgs.com/terms_e-document.htm. Attention is drawn to the limitation of liability, indemnification and jurisdiction issues defined therein. Any holder of this document is advised that information contained hereon reflects the Company's findings at the time of its intervention only and within the limits of Client's instructions, if any. The Company's sole responsibility is to its Client and this document does not exonerate parties to a transaction from exercising all their rights and obligations under the transaction documents. This document cannot be reproduced except in full, without prior written approval of the Company. Any unauthorized alteration, forgery or falsification of the content or appearance of this document is unlawful and offenders may be prosecuted to the fullest extent of the law.

802.11n (5GHz)_40M MIMO-Main

| Frequency MHz | 99%Bandwidth (MHz) |
|------------------|-----------------------|
| 5755 | 36.177 |
| 5795 | 36.197 |

802.11n (5GHz)_40M MIMO-Aux

| Frequency MHz | 99%Bandwidth (MHz) |
|------------------|-----------------------|
| 5755 | 36.270 |
| 5795 | 36.377 |

Note: Refer to next page for plots.

Note: “->” reveals the bandwidth measurement in 99%.

Unless otherwise stated the results shown in this test report refer only to the sample(s) tested and such sample(s) are retained for 90 days only.

除非另有說明，此報告結果僅對測試之樣品負責，同時此樣品僅保留90天。本報告未經本公司書面許可，不可部份複製。

This document is issued by the Company subject to its General Conditions of Service printed overleaf, available on request or accessible at www.sgs.com/terms_and_conditions.htm and, for electronic format documents, subject to Terms and Conditions for Electronic Documents at www.sgs.com/terms_e-document.htm. Attention is drawn to the limitation of liability, indemnification and jurisdiction issues defined therein. Any holder of this document is advised that information contained hereon reflects the Company's findings at the time of its intervention only and within the limits of Client's instructions, if any. The Company's sole responsibility is to its Client and this document does not exonerate parties to a transaction from exercising all their rights and obligations under the transaction documents. This document cannot be reproduced except in full, without prior written approval of the Company. Any unauthorized alteration, forgery or falsification of the content or appearance of this document is unlawful and offenders may be prosecuted to the fullest extent of the law.

SGS Taiwan Ltd.

No.134,WuKungRoad,NewTaipeiIndustrialPark,WukuDistrict,NewTaipeiCity,Taiwan24803/新北市五股區新北產業園區五工路 134 號

台灣檢驗科技股份有限公司

t (886-2) 2299-3279

f (886-2) 2298-0488

www.tw.sgs.com

Member of SGS Group

802.11a
99% Band Width Test Data CH-Low

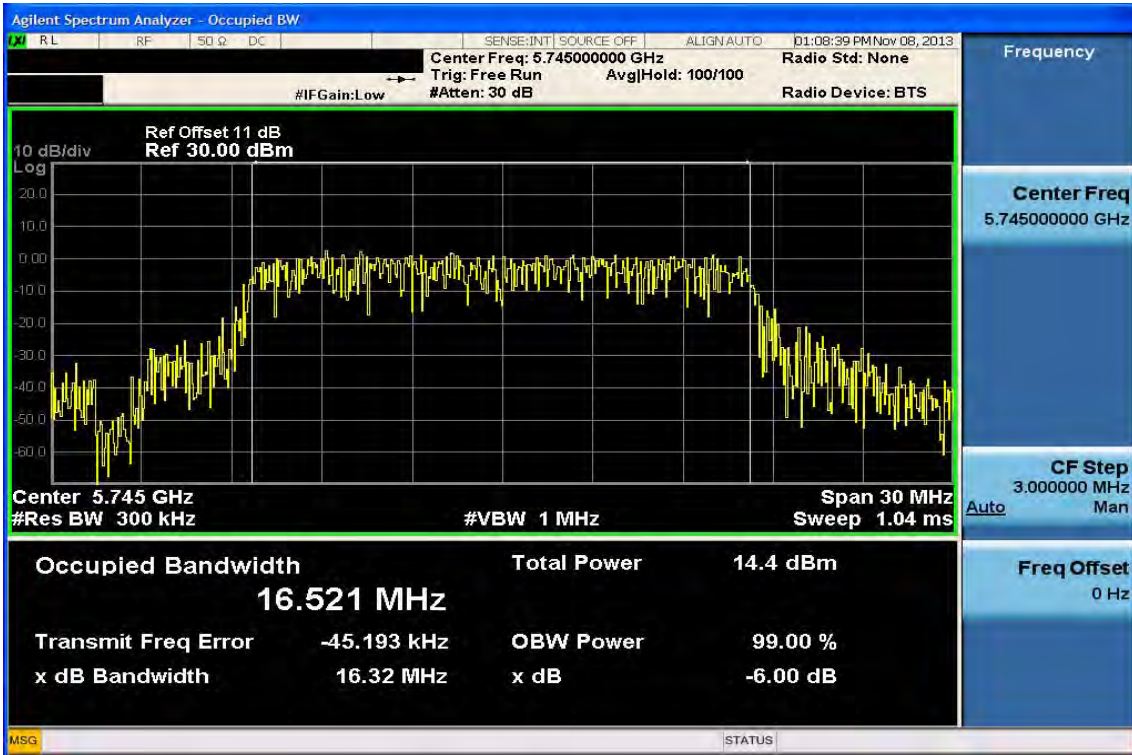

99% Band Width Test Data CH-Mid

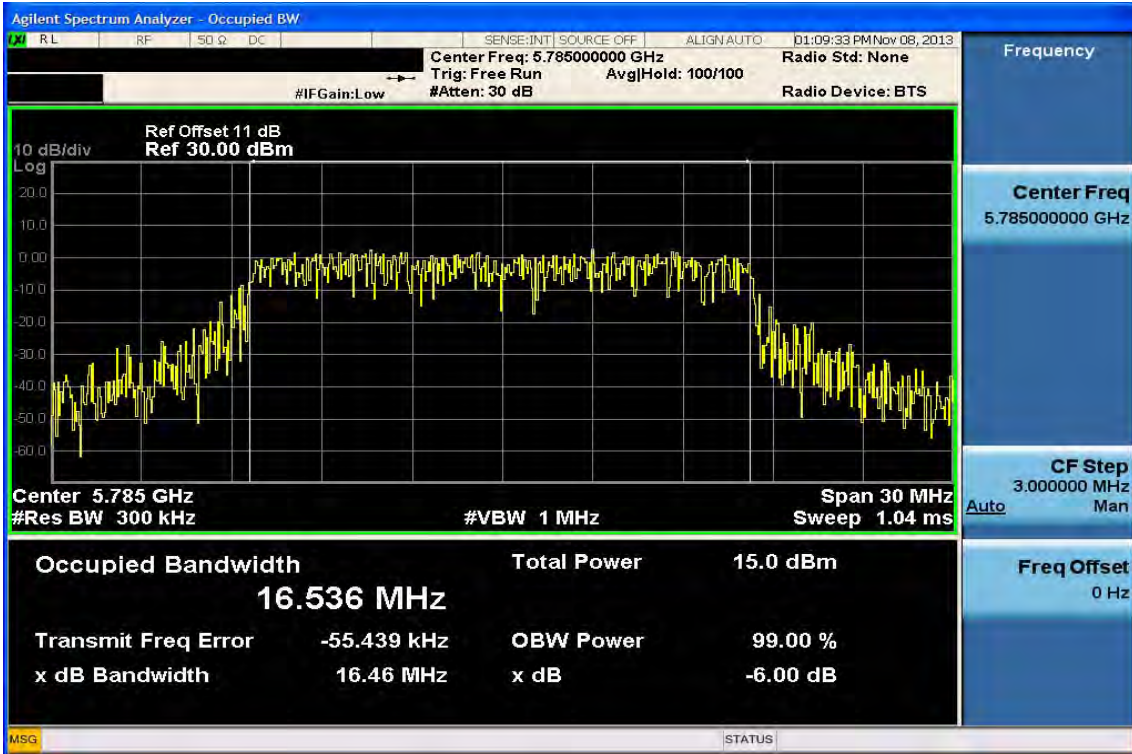

Unless otherwise stated the results shown in this test report refer only to the sample(s) tested and such sample(s) are retained for 90 days only.

除非另有說明，此報告結果僅對測試之樣品負責，同時此樣品僅保留90天。本報告未經本公司書面許可，不可部份複製。

This document is issued by the Company subject to its General Conditions of Service printed overleaf, available on request or accessible at www.sgs.com/terms_and_conditions.htm and, for electronic format documents, subject to Terms and Conditions for Electronic Documents at www.sgs.com/terms_e-document.htm. Attention is drawn to the limitation of liability, indemnification and jurisdiction issues defined therein. Any holder of this document is advised that information contained hereon reflects the Company's findings at the time of its intervention only and within the limits of Client's instructions, if any. The Company's sole responsibility is to its Client and this document does not exonerate parties to a transaction from exercising all their rights and obligations under the transaction documents. This document cannot be reproduced except in full, without prior written approval of the Company. Any unauthorized alteration, forgery or falsification of the content or appearance of this document is unlawful and offenders may be prosecuted to the fullest extent of the law.

SGS Taiwan Ltd.

No. 134, WuKungRoad, NewTaipeiIndustrialPark, WukuDistrict, NewTaipeiCity, Taiwan24803/新北市五股區新北產業園區五工路 134 號

台灣檢驗科技股份有限公司

t (886-2) 2299-3279

f (886-2) 2298-0488

www.tw.sgs.com

Member of SGS Group

99% Band Width Test Data CH-High

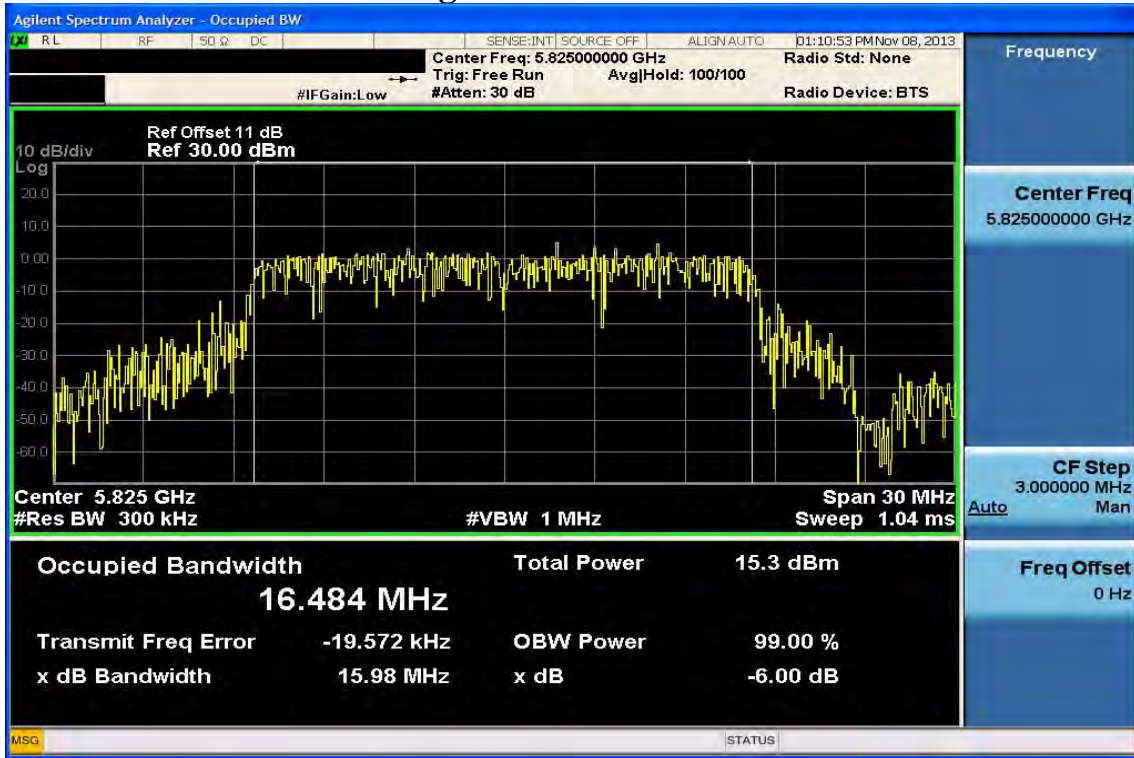

802.11n (5GHz)_20M MIMO-Main 99% Band Width Test Data CH-Low

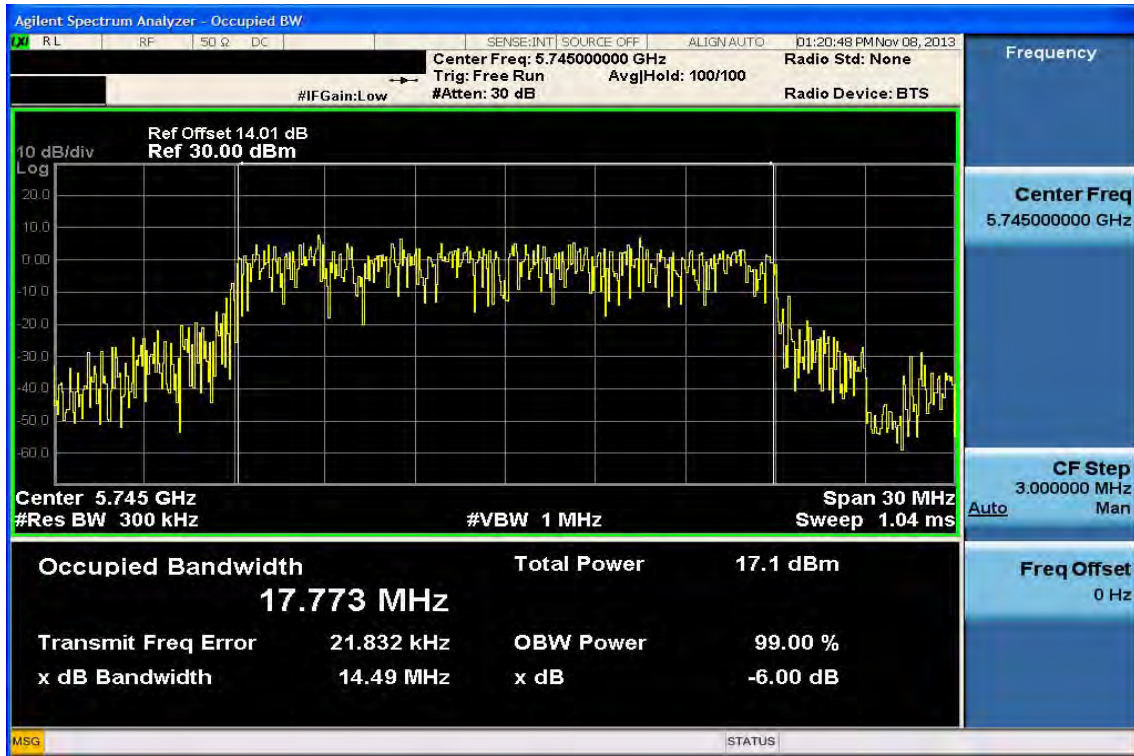

Unless otherwise stated the results shown in this test report refer only to the sample(s) tested and such sample(s) are retained for 90 days only.

除非另有說明，此報告結果僅對測試之樣品負責，同時此樣品僅保留90天。本報告未經本公司書面許可，不可部份複製。

This document is issued by the Company subject to its General Conditions of Service printed overleaf, available on request or accessible at www.sgs.com/terms_and_conditions.htm and, for electronic format documents, subject to Terms and Conditions for Electronic Documents at www.sgs.com/terms_e-document.htm. Attention is drawn to the limitation of liability, indemnification and jurisdiction issues defined therein. Any holder of this document is advised that information contained hereon reflects the Company's findings at the time of its intervention only and within the limits of Client's instructions, if any. The Company's sole responsibility is to its Client and this document does not exonerate parties to a transaction from exercising all their rights and obligations under the transaction documents. This document cannot be reproduced except in full, without prior written approval of the Company. Any unauthorized alteration, forgery or falsification of the content or appearance of this document is unlawful and offenders may be prosecuted to the fullest extent of the law.

SGS Taiwan Ltd.

No. 134, WuKungRoad, NewTaipeiIndustrialPark, WukuDistrict, NewTaipeiCity, Taiwan24803/新北市五股區新北產業園區五工路 134 號

台灣檢驗科技股份有限公司

t (886-2) 2299-3279

f (886-2) 2298-0488

www.tw.sgs.com

Member of SGS Group

99% Band Width Test Data CH-Mid

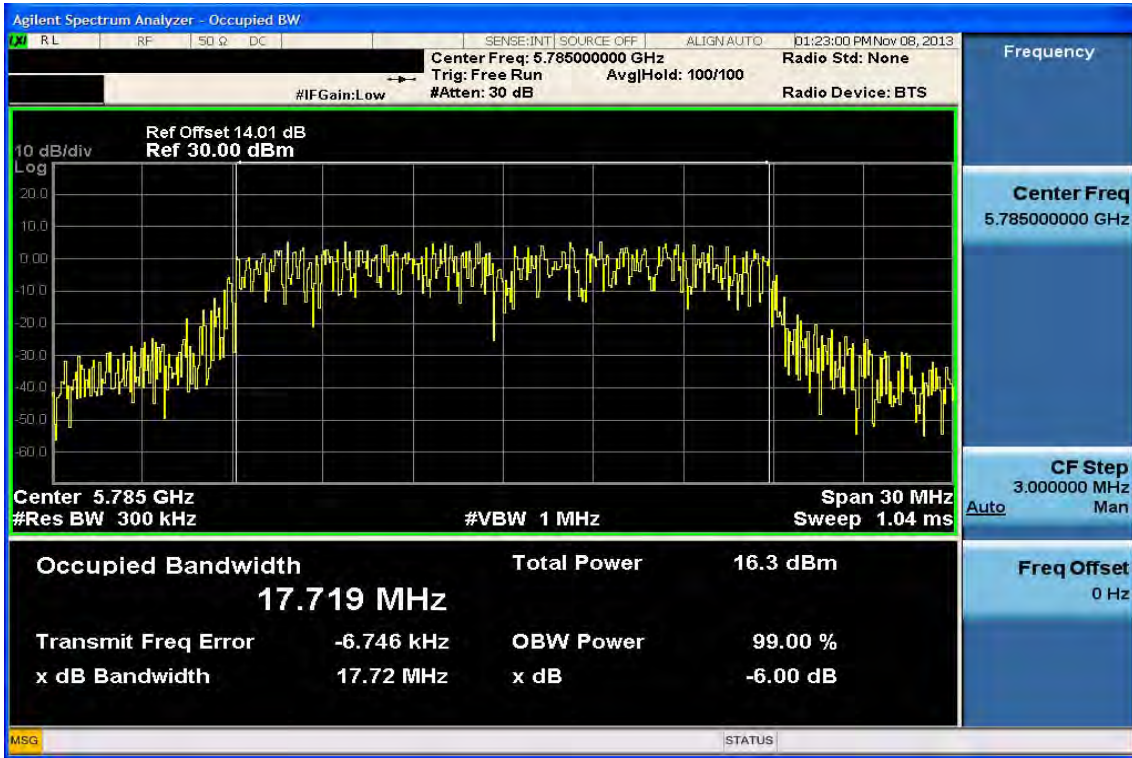

99% Band Width Test Data CH-High

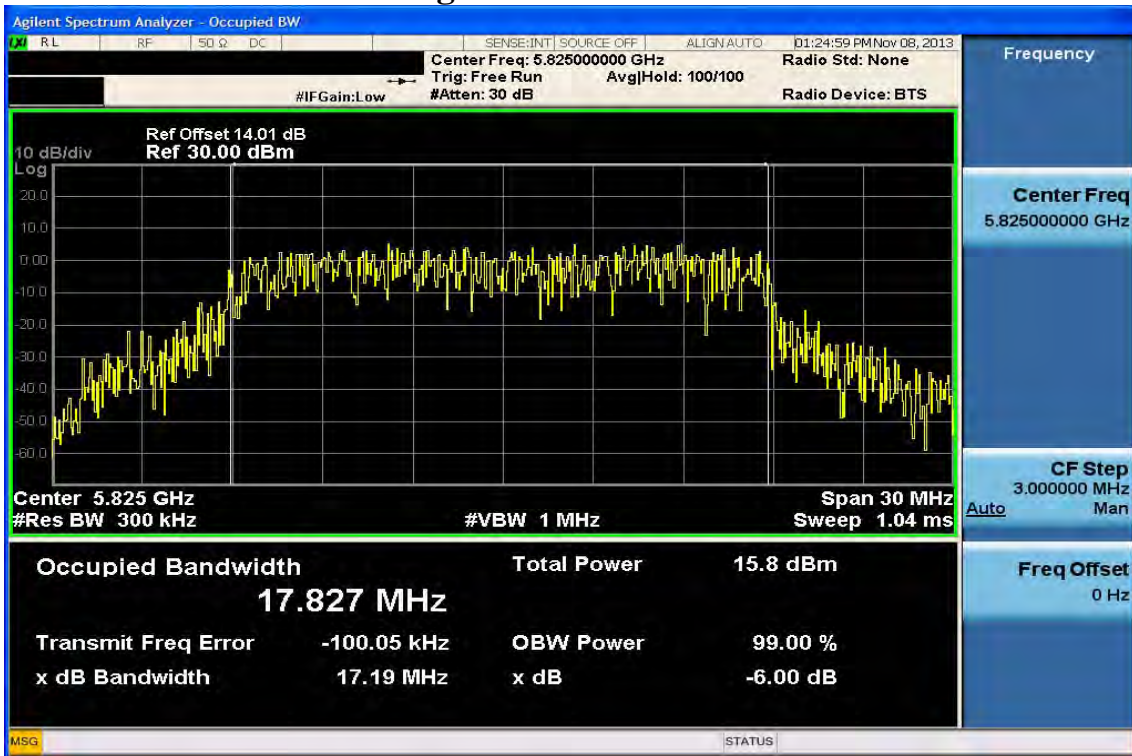

Unless otherwise stated the results shown in this test report refer only to the sample(s) tested and such sample(s) are retained for 90 days only.

除非另有說明，此報告結果僅對測試之樣品負責，同時此樣品僅保留90天。本報告未經本公司書面許可，不可部份複製。

This document is issued by the Company subject to its General Conditions of Service printed overleaf, available on request or accessible at www.sgs.com/terms_and_conditions.htm and, for electronic format documents, subject to Terms and Conditions for Electronic Documents at www.sgs.com/terms_e-document.htm. Attention is drawn to the limitation of liability, indemnification and jurisdiction issues defined therein. Any holder of this document is advised that information contained hereon reflects the Company's findings at the time of its intervention only and within the limits of Client's instructions, if any. The Company's sole responsibility is to its Client and this document does not exonerate parties to a transaction from exercising all their rights and obligations under the transaction documents. This document cannot be reproduced except in full, without prior written approval of the Company. Any unauthorized alteration, forgery or falsification of the content or appearance of this document is unlawful and offenders may be prosecuted to the fullest extent of the law.

SGS Taiwan Ltd.

No. 134, WuKungRoad, NewTaipeiIndustrialPark, WukuDistrict, NewTaipeiCity, Taiwan24803/新北市五股區新北產業園區五工路 134 號

台灣檢驗科技股份有限公司

t (886-2) 2299-3279

f (886-2) 2298-0488

www.tw.sgs.com

Member of SGS Group

802.11n (5GHz) 20M MIMO-Aux 99% Band Width Test Data CH-Low

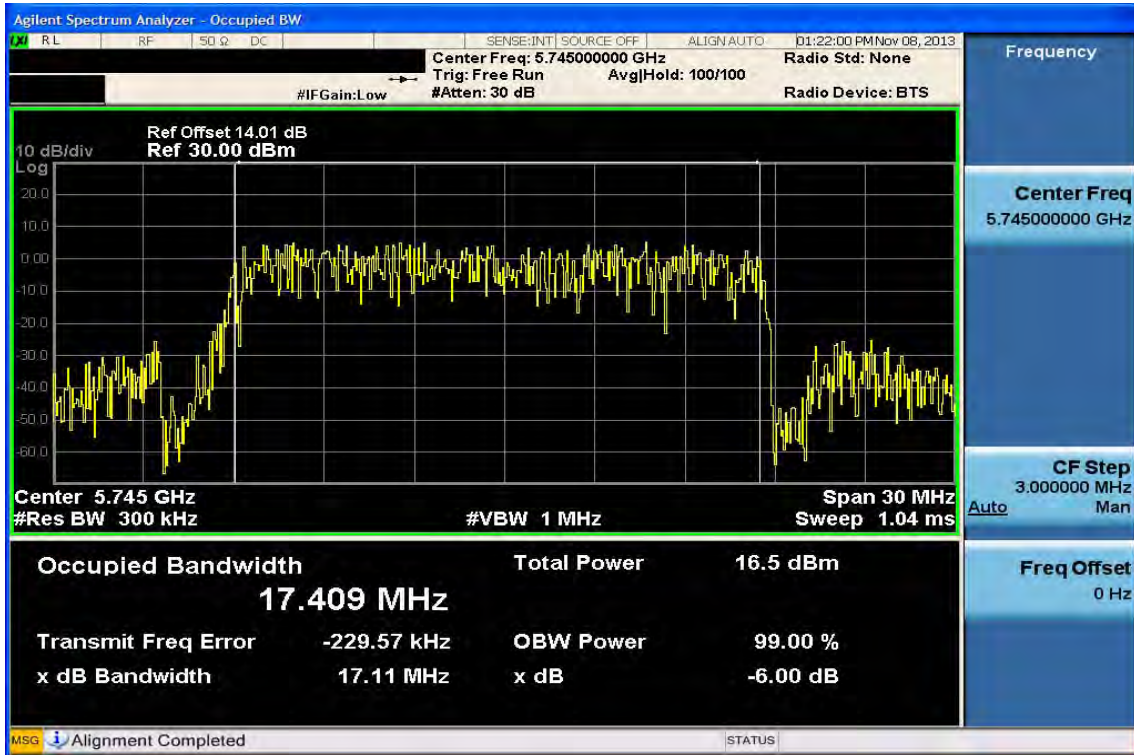

99% Band Width Test Data CH-Mid

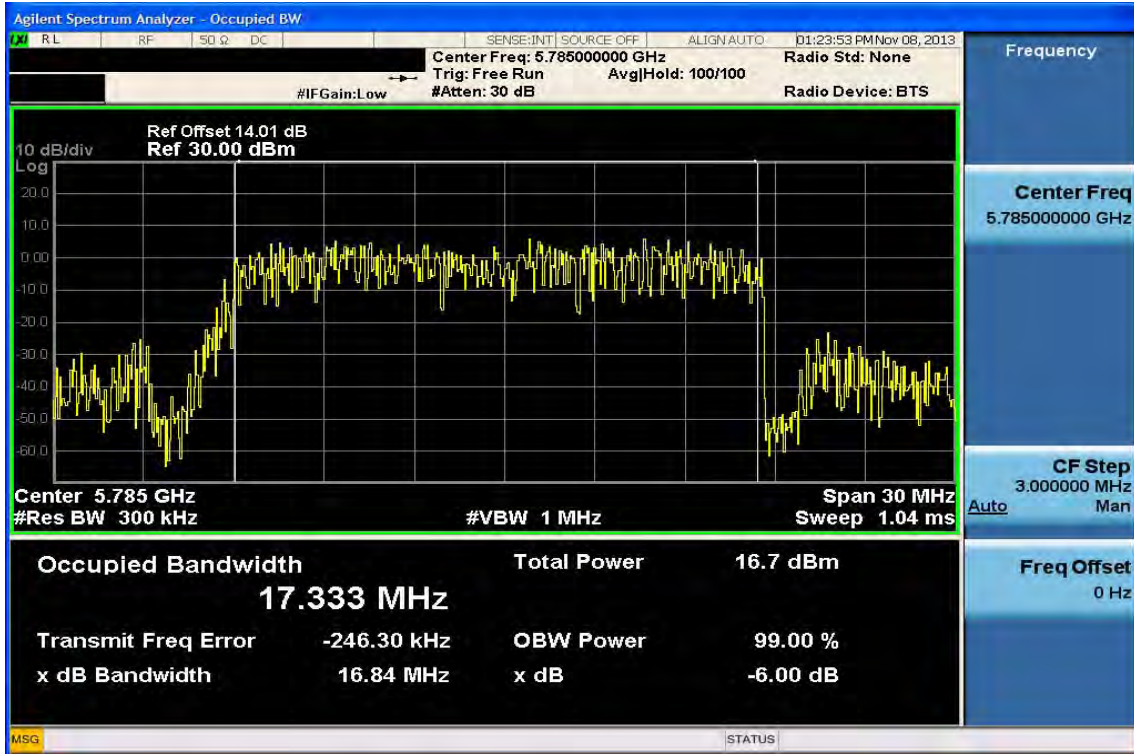

Unless otherwise stated the results shown in this test report refer only to the sample(s) tested and such sample(s) are retained for 90 days only.

除非另有說明，此報告結果僅對測試之樣品負責，同時此樣品僅保留90天。本報告未經本公司書面許可，不可部份複製。

This document is issued by the Company subject to its General Conditions of Service printed overleaf, available on request or accessible at www.sgs.com/terms_and_conditions.htm and, for electronic format documents, subject to Terms and Conditions for Electronic Documents at www.sgs.com/terms_e-document.htm. Attention is drawn to the limitation of liability, indemnification and jurisdiction issues defined therein. Any holder of this document is advised that information contained hereon reflects the Company's findings at the time of its intervention only and within the limits of Client's instructions, if any. The Company's sole responsibility is to its Client and this document does not exonerate parties to a transaction from exercising all their rights and obligations under the transaction documents. This document cannot be reproduced except in full, without prior written approval of the Company. Any unauthorized alteration, forgery or falsification of the content or appearance of this document is unlawful and offenders may be prosecuted to the fullest extent of the law.

SGS Taiwan Ltd.

No. 134, WuKungRoad, NewTaipeiIndustrialPark, WukuDistrict, NewTaipeiCity, Taiwan24803/新北市五股區新北產業園區五工路 134 號

台灣檢驗科技股份有限公司

t (886-2) 2299-3279

f (886-2) 2298-0488

www.tw.sgs.com

Member of SGS Group

99% Band Width Test Data CH-High

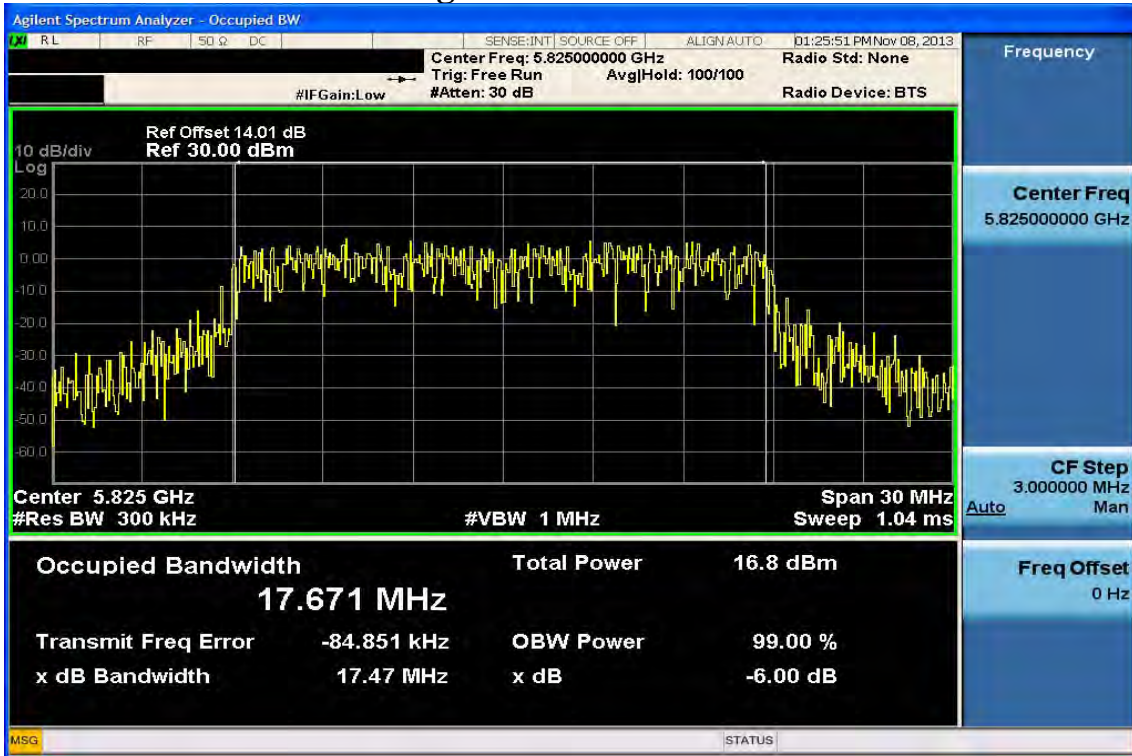

802.11n (5GHz)_40M MIMO-Main 99% Band Width Test Data CH-Low

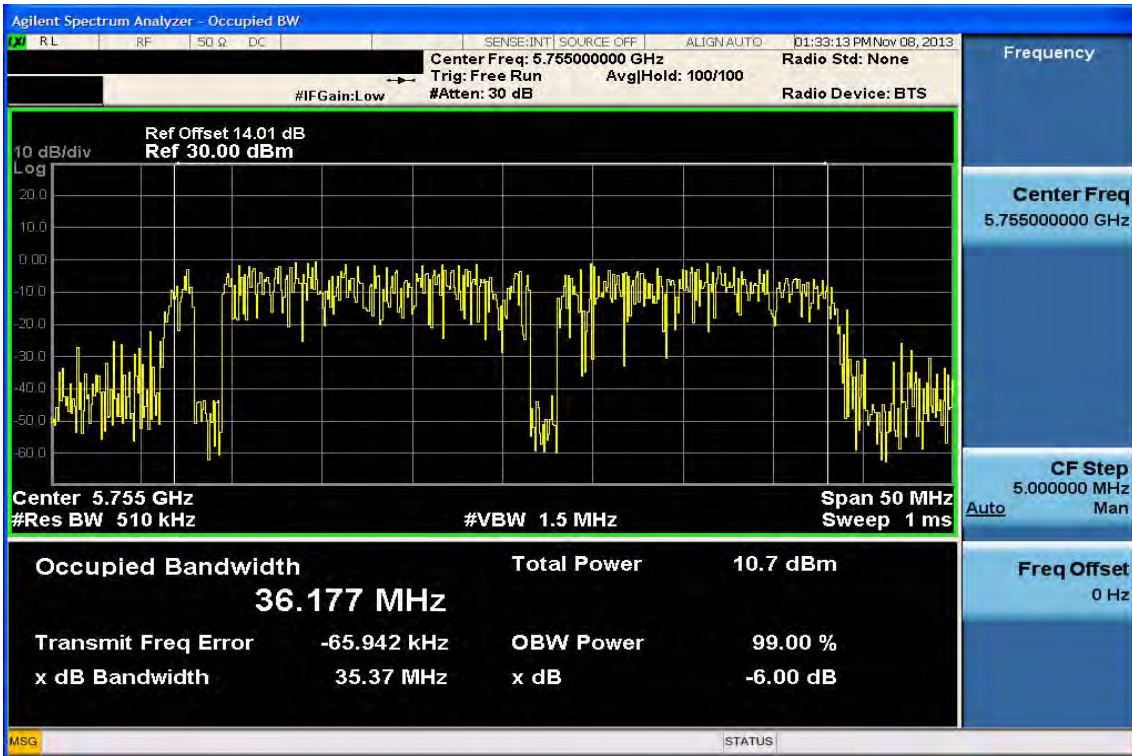

Unless otherwise stated the results shown in this test report refer only to the sample(s) tested and such sample(s) are retained for 90 days only.

除非另有說明，此報告結果僅對測試之樣品負責，同時此樣品僅保留90天。本報告未經本公司書面許可，不可部份複製。

This document is issued by the Company subject to its General Conditions of Service printed overleaf, available on request or accessible at www.sgs.com/terms_and_conditions.htm and, for electronic format documents, subject to Terms and Conditions for Electronic Documents at www.sgs.com/terms_e-document.htm. Attention is drawn to the limitation of liability, indemnification and jurisdiction issues defined therein. Any holder of this document is advised that information contained hereon reflects the Company's findings at the time of its intervention only and within the limits of Client's instructions, if any. The Company's sole responsibility is to its Client and this document does not exonerate parties to a transaction from exercising all their rights and obligations under the transaction documents. This document cannot be reproduced except in full, without prior written approval of the Company. Any unauthorized alteration, forgery or falsification of the content or appearance of this document is unlawful and offenders may be prosecuted to the fullest extent of the law.

SGS Taiwan Ltd.

No. 134, WuKungRoad, NewTaipeiIndustrialPark, WukuDistrict, NewTaipeiCity, Taiwan24803/新北市五股區新北產業園區五工路 134 號

台灣檢驗科技股份有限公司

t (886-2) 2299-3279

f (886-2) 2298-0488

www.tw.sgs.com

Member of SGS Group

99% Band Width Test Data CH-High

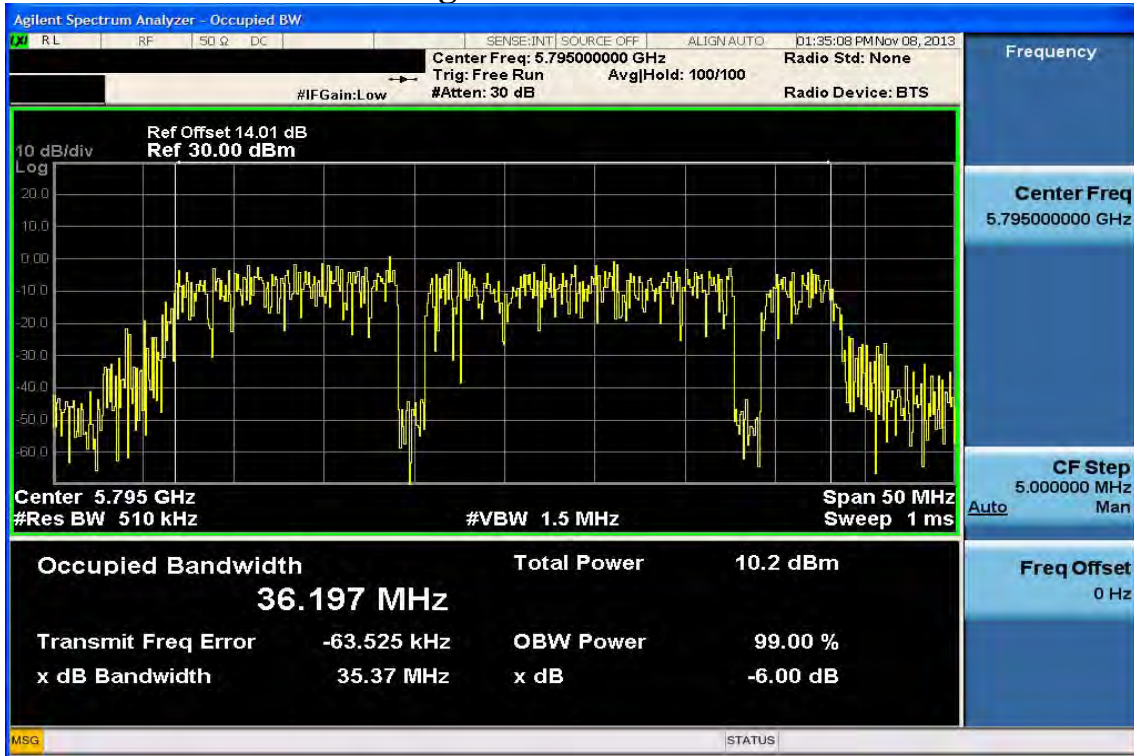

802.11n (5GHz)_40M MIMO-Aux 99% Band Width Test Data CH-Low

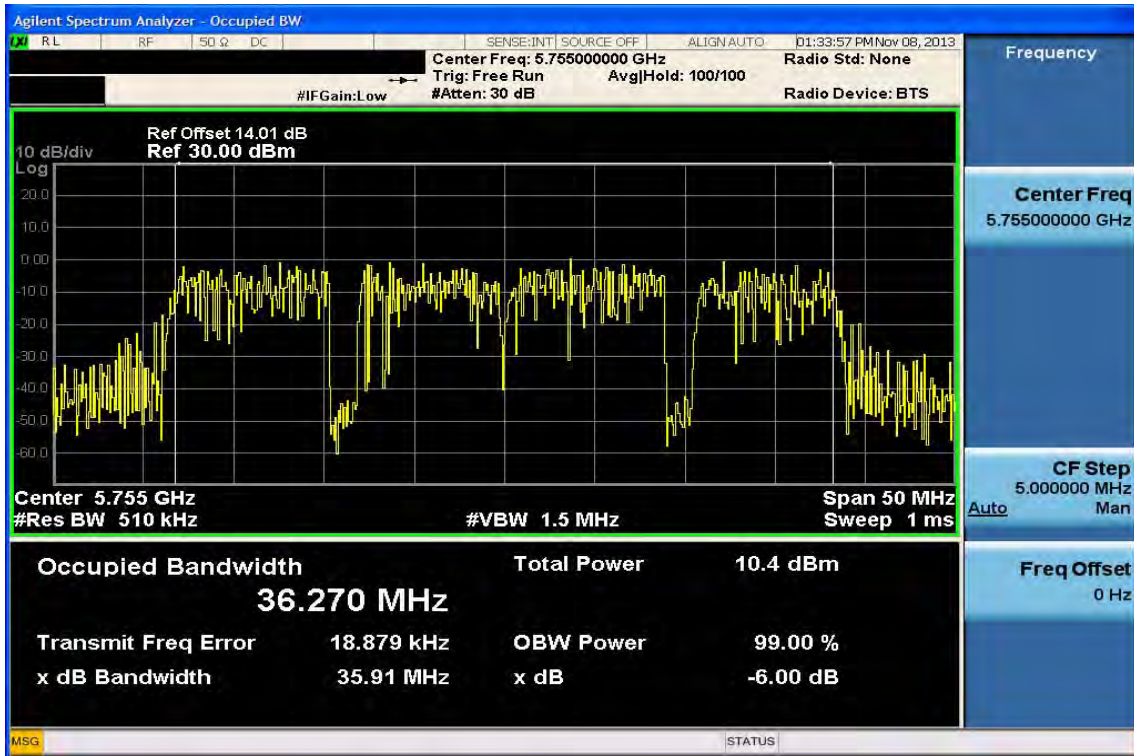

Unless otherwise stated the results shown in this test report refer only to the sample(s) tested and such sample(s) are retained for 90 days only.

除非另有說明，此報告結果僅對測試之樣品負責，同時此樣品僅保留90天。本報告未經本公司書面許可，不可部份複製。

This document is issued by the Company subject to its General Conditions of Service printed overleaf, available on request or accessible at www.sgs.com/terms_and_conditions.htm and, for electronic format documents, subject to Terms and Conditions for Electronic Documents at www.sgs.com/terms_e-document.htm. Attention is drawn to the limitation of liability, indemnification and jurisdiction issues defined therein. Any holder of this document is advised that information contained hereon reflects the Company's findings at the time of its intervention only and within the limits of Client's instructions, if any. The Company's sole responsibility is to its Client and this document does not exonerate parties to a transaction from exercising all their rights and obligations under the transaction documents. This document cannot be reproduced except in full, without prior written approval of the Company. Any unauthorized alteration, forgery or falsification of the content or appearance of this document is unlawful and offenders may be prosecuted to the fullest extent of the law.

SGS Taiwan Ltd.

No. 134, WuKungRoad, NewTaipeiIndustrialPark, WukuDistrict, NewTaipeiCity, Taiwan24803/新北市五股區新北產業園區五工路 134 號

台灣檢驗科技股份有限公司

t (886-2) 2299-3279

f (886-2) 2298-0488

www.tw.sgs.com

Member of SGS Group

99% Band Width Test Data CH-High

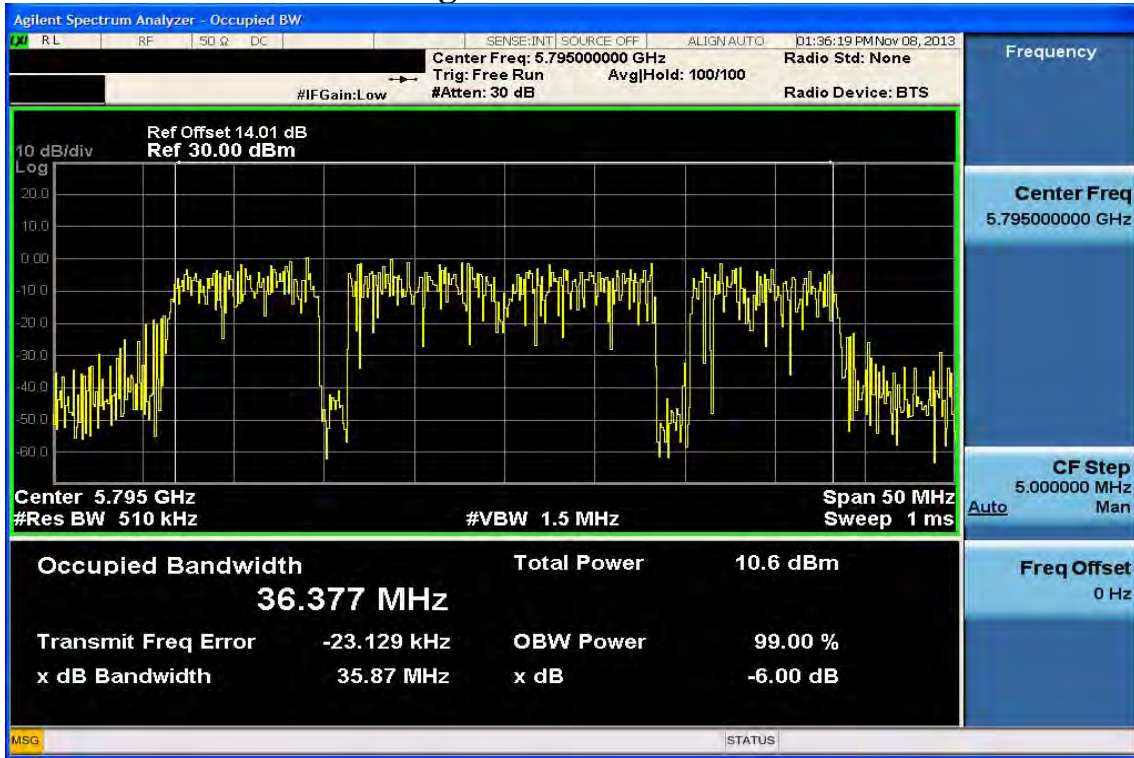

Unless otherwise stated the results shown in this test report refer only to the sample(s) tested and such sample(s) are retained for 90 days only.

除非另有說明，此報告結果僅對測試之樣品負責，同時此樣品僅保留90天。本報告未經本公司書面許可，不可部份複製。

This document is issued by the Company subject to its General Conditions of Service printed overleaf, available on request or accessible at www.sgs.com/terms_and_conditions.htm and, for electronic format documents, subject to Terms and Conditions for Electronic Documents at www.sgs.com/terms_e-document.htm. Attention is drawn to the limitation of liability, indemnification and jurisdiction issues defined therein. Any holder of this document is advised that information contained hereon reflects the Company's findings at the time of its intervention only and within the limits of Client's instructions, if any. The Company's sole responsibility is to its Client and this document does not exonerate parties to a transaction from exercising all their rights and obligations under the transaction documents. This document cannot be reproduced except in full, without prior written approval of the Company. Any unauthorized alteration, forgery or falsification of the content or appearance of this document is unlawful and offenders may be prosecuted to the fullest extent of the law.