



FCC RF Test Report

APPLICANT : Ubiquiti Network, Inc
EQUIPMENT : Access Point
BRAND NAME : UBIQUITI
MODEL NAME : NBE-M2-13
FCC ID : SWX-NBE2M13
STANDARD : FCC Part 15 Subpart C §15.247
CLASSIFICATION : (DTS) Digital Transmission System

The product was received on Apr. 29, 2015 and testing was completed on Jul. 26, 2015. We, SPORTON INTERNATIONAL INC., would like to declare that the tested sample has been evaluated in accordance with the test procedures and has been in compliance with the applicable technical standards.

The test results in this report apply exclusively to the tested model / sample. Without written approval of SPORTON INTERNATIONAL INC., the test report shall not be reproduced except in full.

Reviewed by: Joseph Lin / Supervisor

Approved by: Jones Tsai / Manager



SPORTON INTERNATIONAL INC.

No. 52, Hwa Ya 1st Rd., Hwa Ya Technology Park, Kwei-Shan District, Tao Yuan City, Taiwan, R.O.C.



TABLE OF CONTENTS

REVISION HISTORY..... 3

SUMMARY OF TEST RESULT 4

1 GENERAL DESCRIPTION 5

 1.1 Applicant 5

 1.2 Manufacturer..... 5

 1.3 Product Feature of Equipment Under Test..... 5

 1.4 Product Specification subjective to this standard 6

 1.5 Modification of EUT 6

 1.6 Testing Location 7

 1.7 Applicable Standards..... 7

2 TEST CONFIGURATION OF EQUIPMENT UNDER TEST 8

 2.1 Carrier Frequency and Channel 8

 2.2 Pre-Scanned RF Power..... 9

 2.3 Test Mode..... 11

 2.4 Connection Diagram of Test System..... 12

 2.5 Support Unit used in test configuration and system 13

 2.6 EUT Operation Test Setup 13

 2.7 Measurement Results Explanation Example..... 13

3 TEST RESULT..... 14

 3.1 6dB and 99% Bandwidth Measurement 14

 3.2 Peak Output Power Measurement 16

 3.3 Power Spectral Density Measurement 17

 3.4 Conducted Band Edges and Spurious Emission Measurement 19

 3.5 Radiated Band Edges and Spurious Emission Measurement 86

 3.6 AC Conducted Emission Measurement..... 91

 3.7 Antenna Requirements..... 95

4 LIST OF MEASURING EQUIPMENT 96

5 UNCERTAINTY OF EVALUATION 97

APPENDIX A. CONDUCTED TEST RESULTS

APPENDIX B. RADIATED TEST RESULTS

APPENDIX C. SETUP PHOTOGRAPHS



REVISION HISTORY

REPORT NO.	VERSION	DESCRIPTION	ISSUED DATE
FR542937-01	Rev. 01	Initial issue of report	Aug. 04, 2015



SUMMARY OF TEST RESULT

Report Section	FCC Rule	IC Rule	Description	Limit	Result	Remark
3.1	15.247(a)(2)	RSS-247 5.2(1)	6dB Bandwidth	$\geq 0.5\text{MHz}$	Pass	-
3.1	-	RSS-Gen 6.6	99% Bandwidth	-	Pass	-
3.2	15.247(b)	RSS-247 A5.4(4)	Power Output Measurement	$\leq 30\text{dBm}$	Pass	-
3.3	15.247(e)	RSS-247 5.2(2)	Power Spectral Density	$\leq 8\text{dBm}/3\text{kHz}$	Pass	-
3.4	15.247(d)	RSS-247 5.5	Conducted Band Edges	$\leq 20\text{dBc}$	Pass	-
			Conducted Spurious Emission		Pass	-
3.5	15.247(d)	RSS-247 5.5	Radiated Band Edges and Radiated Spurious Emission	15.209(a) & 15.247(d)	Pass	Under limit 0.07 dB at 2325.520 MHz
3.6	15.207	RSS-GEN 8.8	AC Conducted Emission	15.207(a)	Pass	Under limit 7.50 dB at 0.422 MHz
3.7	15.203 & 15.247(b)	N/A	Antenna Requirement	N/A	Pass	-



1 General Description

1.1 Applicant

Ubiquiti Network, Inc

12F, No. 105, Song Ren Rd., SinYi District, Taipei 110, Taiwan

1.2 Manufacturer

Ubiquiti Network, Inc

12F, No. 105, Song Ren Rd., SinYi District, Taipei 110, Taiwan

1.3 Product Feature of Equipment Under Test

Product Feature	
Equipment	Access Point
Brand Name	UBIQUITI
Model Name	NBE-M2-13
FCC ID	SWX-NBE2M13
EUT supports Radios application	802.11g (5MHz/8MHz/10MHz/20MHz/30MHz) 802 11n HT20 (5MHz/8MHz/10MHz/20MHz/30MHz) 802 11n HT40
EUT Stage	Production Unit

Remark: The above EUT's information was declared by manufacturer. Please refer to the specifications or user's manual for more detailed description.



1.4 Product Specification subjective to this standard

Product Specification subjective to this standard										
Tx/Rx Channel Frequency Range	802.11g/n : 2412 MHz ~ 2462 MHz									
Maximum (Peak) Output Power to antenna	802.11g (5MHz) : 26.61 dBm (0.4581 W) 802.11g (8MHz): 24.25 dBm (0.2661 W) 802.11g (10MHz) : 26.72 dBm (0.4699 W) 802.11g (20MHz): 26.41 dBm (0.4375 W) 802.11g (30MHz) : 15.56 dBm (0.0360 W) 802.11n HT20 (5M) : 26.86 dBm (0.4853 W) 802.11n HT20 (8M) : 24.42 dBm (0.2767 W) 802.11n HT20 (10MHz) : 26.74 dBm (0.4721 W) 802.11n HT20 (20MHz) : 26.35 dBm (0.4315 W) 802.11n HT20 (30MHz): 13.92 dBm (0.0247 W) 802.11n HT40 : 26.97 dBm (0.4977 W)									
99% Occupied Bandwidth	802.11g (5MHz) : 5.61MHz 802.11g (8Mhz) : 7.72MHz 802.11g (10MHz) : 9.24MHz 802.11g (20MHz) : 18.40MHz 802.11g (30MHz) : 27.45MHz 802.11n HT20 (5MHz) : 5.87MHz 802.11n HT20 (8MHz) : 8.16MHz 802.11n HT20 (10MHz) : 9.81MHz 802.11n HT20 (20MHz) : 19.25MHz 802.11n HT20 (30MHz) : 28.62MHz 802.11n HT40: 38.50MHz									
Antenna Type	Ant. 1 : Disc Antenna type with gain 13.00 dBi Ant. 2 : Disc Antenna type with gain 13.00 dBi									
Type of Modulation	802.11g/n : OFDM (BPSK / QPSK / 16QAM / 64QAM)									
Antenna Function for Transmitter	<table border="1"> <thead> <tr> <th></th> <th>Ant. 1</th> <th>Ant. 2</th> </tr> </thead> <tbody> <tr> <td>802.11 g MIMO</td> <td>V</td> <td>V</td> </tr> <tr> <td>802.11 n MIMO</td> <td>V</td> <td>V</td> </tr> </tbody> </table>		Ant. 1	Ant. 2	802.11 g MIMO	V	V	802.11 n MIMO	V	V
	Ant. 1	Ant. 2								
802.11 g MIMO	V	V								
802.11 n MIMO	V	V								

1.5 Modification of EUT

No modifications are made to the EUT during all test items.



1.6 Testing Location

Sporton Lab is accredited to ISO 17025 by Taiwan Accreditation Foundation (TAF code : 1190) and the FCC designation No. TW1022 under the FCC 2.948(e) by Mutual Recognition Agreement (MRA) in FCC Test.

Test Site	SPORTON INTERNATIONAL INC.		
Test Site Location	No. 52, Hwa Ya 1 st Rd., Hwa Ya Technology Park, Kwei-Shan District, Tao Yuan City, Taiwan, R.O.C. TEL: +886-3-327-3456 FAX: +886-3-328-4978		
Test Site No.	Sporton Site No.		
	TH05-HY	CO05-HY	03CH07-HY

Note: The test site complies with ANSI C63.4 2009 requirement.

1.7 Applicable Standards

According to the specifications of the manufacturer, the EUT must comply with the requirements of the following standards:

- ♦ FCC Part 15 Subpart C §15.247
- ♦ FCC KDB Publication No. 558074 D01 DTS Meas. Guidance v03r03
- ♦ FCC KDB 662911 D01 Multiple Transmitter Output v02r01.
- ♦ ANSI C63.10-2009

Remark:

1. All test items were verified and recorded according to the standards and without any deviation during the test.
2. FCC permits the use of the 1.5 meter table for frequency above 1GHz as an alternative in C63.10-2013 through inquiry tracking number 961829.
3. This EUT has also been tested and complied with the requirements of FCC Part 15, Subpart B, recorded in a separate test report.



2 Test Configuration of Equipment Under Test

The EUT has been associated with peripherals and configuration operated in a manner tended to maximize its emission characteristics in a typical application. Frequency range investigated: conducted emission (150 kHz to 30 MHz) and radiated emission (9 kHz to the 10th harmonic of the highest fundamental frequency or to 40 GHz, whichever is lower). For radiated measurement, pre-scanned in three orthogonal panels, X, Y, Z. The worst cases (Y plane) were recorded in this report.

The final configuration from all the combinations and the worst-case data rates were investigated by measuring the maximum power across all the data rates and modulation modes under section 2.2.

Based on the worst configuration found above, the RF power setting is set individually to meet FCC compliance limit for the final conducted and radiated tests shown in section 2.3.

2.1 Carrier Frequency and Channel

Frequency Band	Channel	Freq. (MHz)	Channel	Freq. (MHz)
2400-2483.5 MHz	1	2412	7	2442
	2	2417	8	2447
	3	2422	9	2452
	4	2427	10	2457
	5	2432	11	2462
	6	2437		



2.2 Pre-Scanned RF Power

Preliminary tests were performed in different data rate and data rate associated with the highest power were chosen for full test shown in the following tables.

MIMO <Ant. 1+2>

802.11g (5MHz)								
Data Rate (MHz)	6M bps	9M bps	12M bps	18M bps	24M bps	36M bps	48M bps	54M bps
Peak Power (dBm)	26.61	26.57	26.58	26.56	26.56	26.59	26.59	26.59

802.11g (8MHz)								
Data Rate (MHz)	6M bps	9M bps	12M bps	18M bps	24M bps	36M bps	48M bps	54M bps
Peak Power (dBm)	24.25	24.21	24.23	24.24	24.23	24.24	24.24	24.23

802.11g (10MHz)								
Data Rate (MHz)	6M bps	9M bps	12M bps	18M bps	24M bps	36M bps	48M bps	54M bps
Peak Power (dBm)	26.72	26.71	26.56	26.69	26.68	26.64	26.64	26.68

802.11g (20MHz)								
Data Rate (MHz)	6M bps	9M bps	12M bps	18M bps	24M bps	36M bps	48M bps	54M bps
Peak Power (dBm)	26.41	26.39	26.38	26.38	26.35	26.38	26.38	26.39

802.11g (30MHz)								
Data Rate (MHz)	6M bps	9M bps	12M bps	18M bps	24M bps	36M bps	48M bps	54M bps
Peak Power (dBm)	15.56	15.46	15.51	15.52	15.51	15.38	15.19	15.24



2.4GHz 802.11n HT20 (5MHz)								
Data Rate (MHz)	MCS0	MCS1	MCS2	MCS3	MCS4	MCS5	MCS6	MCS7
Peak Power (dBm)	26.86	26.80	26.82	26.83	26.82	26.84	26.84	26.81

2.4GHz 802.11n HT20 (8MHz)								
Data Rate (MHz)	MCS0	MCS1	MCS2	MCS3	MCS4	MCS5	MCS6	MCS7
Peak Power (dBm)	24.42	24.40	24.38	24.39	24.40	24.40	24.39	24.38

2.4GHz 802.11n HT20 (10MHz)								
Data Rate (MHz)	MCS0	MCS1	MCS2	MCS3	MCS4	MCS5	MCS6	MCS7
Peak Power (dBm)	26.74	26.69	26.69	26.71	26.71	26.69	26.71	26.69

2.4GHz 802.11n HT20 (20MHz)								
Data Rate (MHz)	MCS0	MCS1	MCS2	MCS3	MCS4	MCS5	MCS6	MCS7
Peak Power (dBm)	26.35	26.27	26.21	26.23	26.18	26.29	26.29	26.32

2.4GHz 802.11n HT20 (30MHz)								
Data Rate (MHz)	MCS0	MCS1	MCS2	MCS3	MCS4	MCS5	MCS6	MCS7
Peak Power (dBm)	13.92	13.69	13.83	13.72	13.78	13.86	13.90	13.89

2.4GHz 802.11n HT40								
Data Rate (MHz)	MCS0	MCS1	MCS2	MCS3	MCS4	MCS5	MCS6	MCS7
Peak Power (dBm)	26.97	26.01	25.45	24.88	24.63	25.02	25.59	25.30

Note: MIMO Ant. 1+2 is a calculated result from sum of the power MIMO Ant. 1 and MIMO Ant. 2.



2.3 Test Mode

Final test mode of conducted test items and radiated spurious emissions are considering the modulation and worse data rates from the power table described in section 2.2.

MIMO Antenna

Modulation	Data Rate
802.11g 5MHz	6 Mbps
802.11g 8MHz	6 Mbps
802.11g 10MHz	6 Mbps
802.11g 20MHz	6 Mbps
802.11g 30MHz	6 Mbps
802.11n HT20 (5MHz)	MCS0
802.11n HT20 (8MHz)	MCS0
802.11n HT20 (10MHz)	MCS0
802.11n HT20 (20MHz)	MCS0
802.11n HT20 (30MHz)	MCS0
802.11n HT40	MCS0

Test Cases	
AC Conducted Emission	Mode 1 :WLAN Link + RJ-45 Link + PoE

2.4 Connection Diagram of Test System

<WLAN Tx Mode>

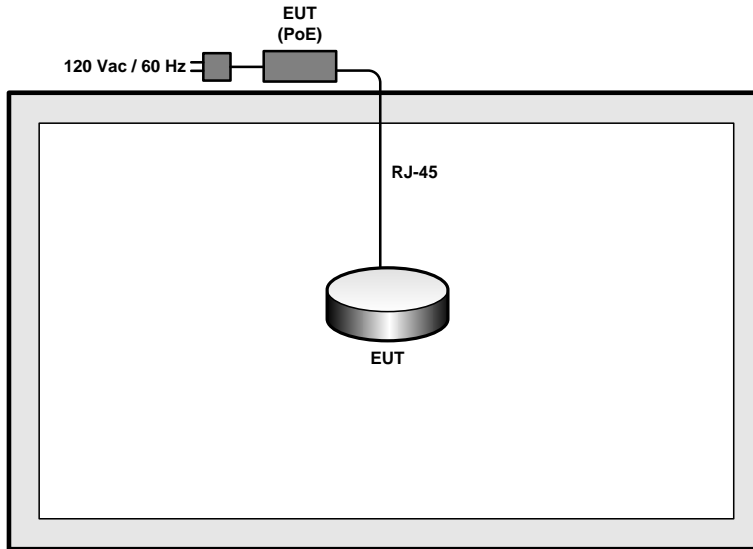

<AC Conducted Emission Mode>

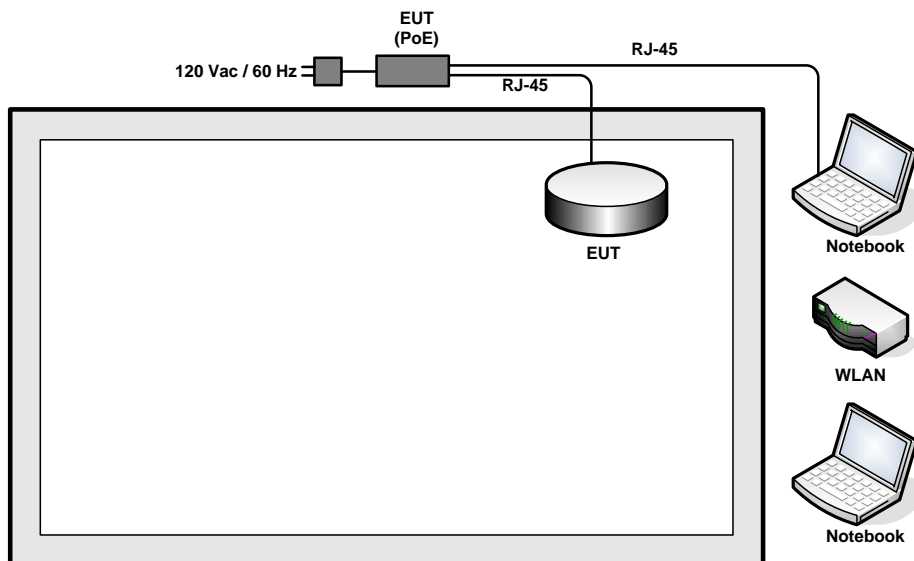



2.5 Support Unit used in test configuration and system

Item	Equipment	Trade Name	Model Name	FCC ID	Data Cable	Power Cord
1.	Outdoor AP	Ubiquiti	NBE-M2-13	SWX-NBE2M13	N/A	N/A
2.	Notebook	DELL	Latitude E6320	FCC DoC/ Contains FCC ID: QDS-BRCM1054	N/A	AC I/P: Unshielded, 1.2 m DC O/P: Shielded, 1.8 m
3.	Notebook	DELL	P20G	FCC DoC/ Contains FCC ID:QDS-BRCM1051	N/A	AC I/P: Unshielded, 1.2 m DC O/P: Shielded, 1.8 m

2.6 EUT Operation Test Setup

For WLAN function, programmed RF utility, "Wifi Tx" installed in the notebook make the EUT provide functions like channel selection and power level for continuous transmitting and receiving signals.

2.7 Measurement Results Explanation Example

For all conducted test items:

The offset level is set in the spectrum analyzer to compensate the RF cable loss and attenuator factor between EUT conducted output port and spectrum analyzer. With the offset compensation, the spectrum analyzer reading level is exactly the EUT RF output level.

Example:

The spectrum analyzer offset is derived from RF cable loss and attenuator factor.

$$\text{Offset} = \text{RF cable loss} + \text{attenuator factor}.$$

Following shows an offset computation example with cable loss 4.2 dB and 10dB attenuator.

$$\begin{aligned} \text{Offset(dB)} &= \text{RF cable loss(dB)} + \text{attenuator factor(dB)}. \\ &= 4.2 + 10 = 14.2 \text{ (dB)} \end{aligned}$$

3 Test Result

3.1 6dB and 99% Bandwidth Measurement

3.1.1 Limit of 6dB and 99% Bandwidth

The minimum 6 dB bandwidth shall be at least 500 kHz.

3.1.2 Measuring Instruments

The measuring equipment is listed in the section 4 of this test report.

3.1.3 Test Procedures

1. The testing follows FCC KDB Publication No. 558074 DTS D01 Meas. Guidance v03r03.
2. The RF output of EUT was connected to the spectrum analyzer by RF cable and attenuator. The path loss was compensated to the results for each measurement.
3. Set to the maximum power setting and enable the EUT transmit continuously.
4. Make the measurement with the spectrum analyzer's resolution bandwidth (RBW) = 100 kHz. Set the Video bandwidth (VBW) = 300 kHz. In order to make an accurate measurement. The 6 dB bandwidth must be greater than 500 kHz.
5. For 99% Bandwidth Measurement, the spectrum analyzer's resolution bandwidth (RBW) = 1MHz and set the Video bandwidth (VBW) = 3MHz.
6. Measure and record the results in the test report.

3.1.4 Test Setup





3.1.5 Test Result of 6dB and 99% Occupied Bandwidth

Please refer to Appendix A of this test report.

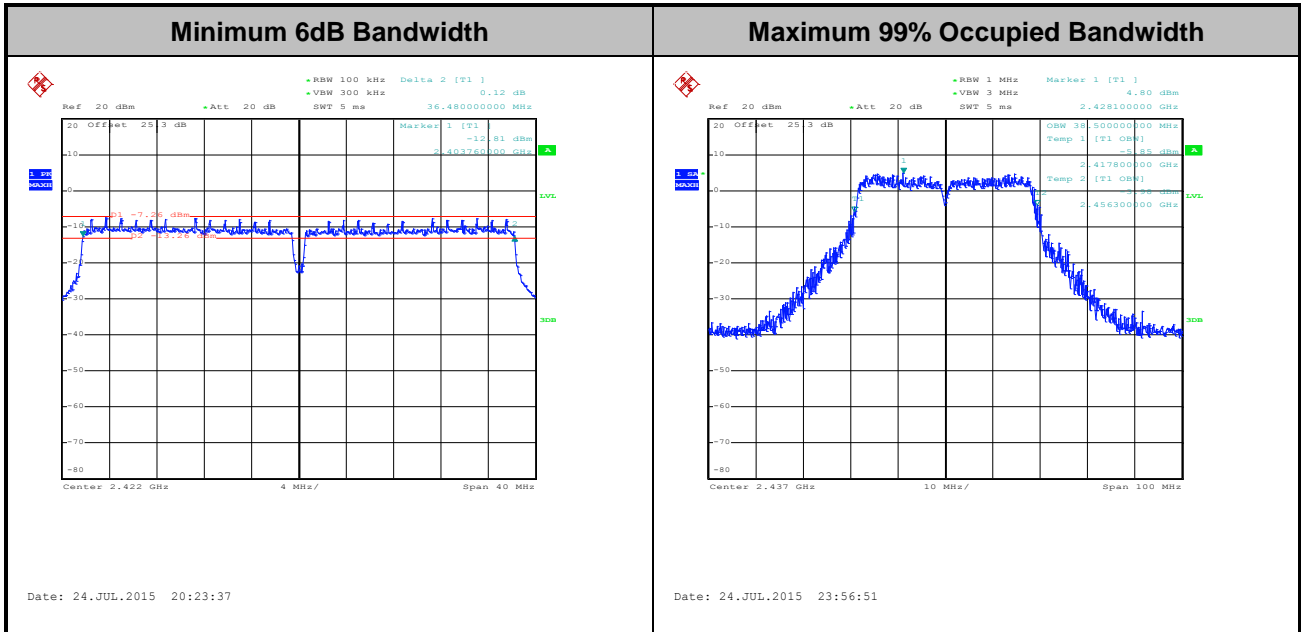

Note: The occupied channel bandwidth is maintained within the band of operation for all of the modulations.

3.2 Peak Output Power Measurement

3.2.1 Limit of Peak Output Power

For systems using digital modulation in the 2400-2483.5MHz, the limit for peak output power is 30dBm. If transmitting antenna with directional gain greater than 6dBi is used, the peak output power from the intentional radiator shall be reduced below the above stated value by the amount in dB that the directional gain of the antenna exceeds 6 dBi. In case of point-to-point operation, the limit has to be reduced by 1dB for every 3dB that the directional gain of the antenna exceeds 6dBi.

3.2.2 Measuring Instruments

The measuring equipment is listed in the section 4 of this test report.

3.2.3 Test Procedures

1. The testing follows the Measurement Procedure of FCC KDB No. 558074 DTS D01 Meas. Guidance v03r03.
2. The RF output of EUT was connected to the power meter by RF cable and attenuator. The path loss was compensated to the results for each measurement.
3. Set to the maximum power setting and enable the EUT transmit continuously.
4. Measure the conducted output power and record the results in the test report.
5. For MIMO mode, calculation method follows FCC KDB 662911 D01 Multiple Transmitter Output v02r01.

3.2.4 Test Setup

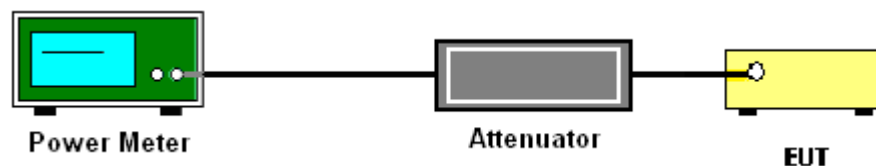

3.2.5 Test Result of Peak Output Power

Please refer to Appendix A of this test report.

3.2.6 Test Result of Average output Power (Reporting Only)

Please refer to Appendix A of this test report.



3.3 Power Spectral Density Measurement

3.3.1 Limit of Power Spectral Density

The peak power spectral density shall not be greater than 8dBm in any 3kHz band at any time interval of continuous transmission.

3.3.2 Measuring Instruments

The measuring equipment is listed in the section 4 of this test report.

3.3.3 Test Procedures

1. The testing follows Measurement Procedure 10.2 Method PKPSD of FCC KDB Publication No. 558074 D01 DTS Meas. Guidance v03r03
2. The RF output of EUT was connected to the spectrum analyzer by RF cable and attenuator. The path loss was compensated to the results for each measurement.
3. Set to the maximum power setting and enable the EUT transmit continuously.
4. Make the measurement with the spectrum analyzer's resolution bandwidth (RBW) = 3 kHz. Video bandwidth VBW = 10 kHz In order to make an accurate measurement, set the span to 1.5 times DTS Channel Bandwidth. (6dB BW)
5. Detector = peak, Sweep time = auto couple, Trace mode = max hold, Allow trace to fully stabilize. Use the peak marker function to determine the maximum power level.
6. Measure and record the results in the test report.
7. For MIMO mode, calculation method follows FCC KDB 662911 D01 Multiple Transmitter Output v02r01.

If measurements performed using method (2) plus $10 \log(N)$ exceeds the emission limit, the test should choose method (1) before declaring that the device fails the emission limit.

Method (1): Measure and sum the spectra across the outputs.

The total final Power Spectral Density is from a device with 2 transmitter outputs. The spectrum measurements of the individual outputs are all performed with the same span and number of points, the spectrum value in the first spectral bin of output 1 is summed with that in the first spectral bin of output 2 to obtain the value for the first frequency bin of the summed spectrum.

Method (2): Measure and add $10 \log(N)$ dB, where N is the number of outputs. (N=2)

3.3.4 Test Setup

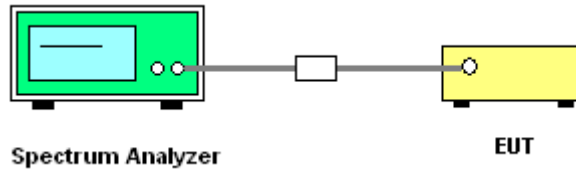

3.3.5 Test Result of Power Spectral Density

Please refer to Appendix A of this test report.

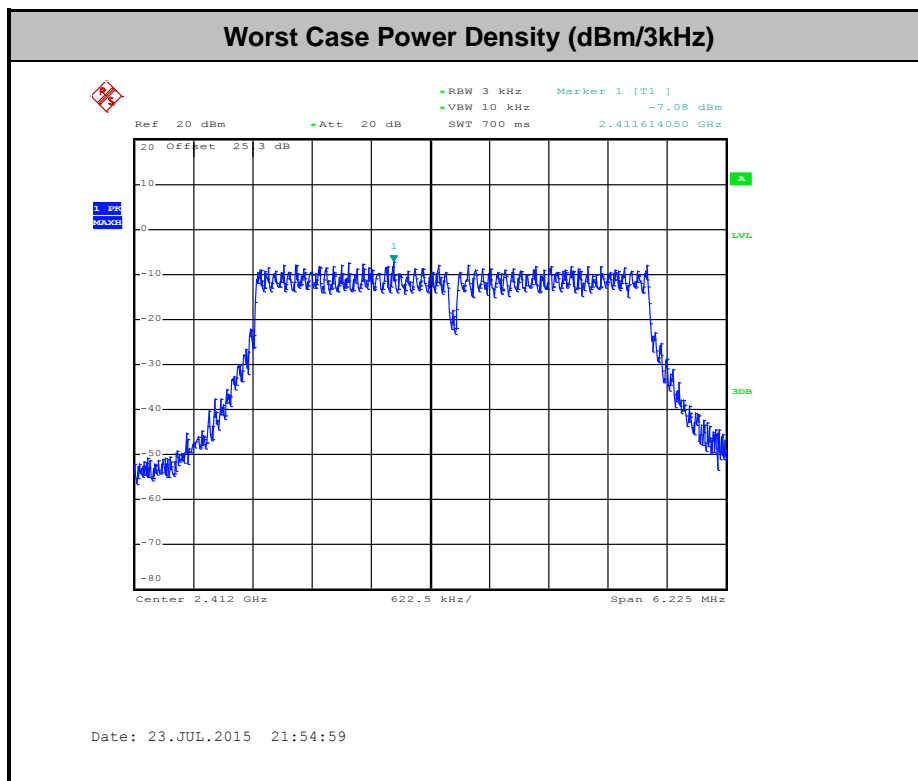

3.4 Conducted Band Edges and Spurious Emission Measurement

3.4.1 Limit of Conducted Band Edges and Spurious Emission Measurement

In any 100 kHz bandwidth outside of the authorized frequency band, the emissions which fall in the non-restricted bands shall be attenuated at least 20 dB / 30dB relative to the maximum PSD level in 100 kHz by RF conducted measurement and radiated emissions which fall in the restricted bands, as defined in Section 15.205(a), must also comply with the radiated emission limits specified in Section 15.209(a).

3.4.2 Measuring Instruments

The measuring equipment is listed in the section 4 of this test report.

3.4.3 Test Procedures

1. The testing follows FCC KDB Publication No. 558074 D01 DTS Meas. Guidance v03r03.
2. The RF output of EUT was connected to the spectrum analyzer by RF cable and attenuator. The path loss was compensated to the results for each measurement.
3. Set to the maximum power setting and enable the EUT transmit continuously.
4. Set RBW = 100 kHz, VBW=300 kHz, Peak Detector. Unwanted Emissions measured in any 100 kHz bandwidth outside of the authorized frequency band shall be attenuated by at least 20 dB relative to the maximum in-band peak PSD level in 100 kHz when maximum peak conducted output power procedure is used. If the transmitter complies with the conducted power limits based on the use of RMS averaging over a time interval, the attenuation required under this paragraph shall be 30 dB instead of 20 dB per 15.247(d).
5. Measure and record the results in the test report.
6. The RF fundamental frequency should be excluded against the limit line in the operating frequency band.

3.4.4 Test Setup

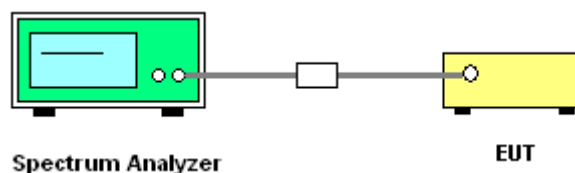



3.4.5 Test Result of Conducted Band Edges and Spurious Emission

Number of TX = 2, Ant. 1 (Measured)

Number of TX :	2	Ant. :	1
Test Mode :	802.11g (5MHz)	Temperature :	24~26°C
Test Band :	2.4GHz Low	Relative Humidity :	45~49%
Test Channel :	01	Test Engineer :	Bill Kuo

WLAN 802.11g (5MHz) Channel 01

100kHz PSD reference Level

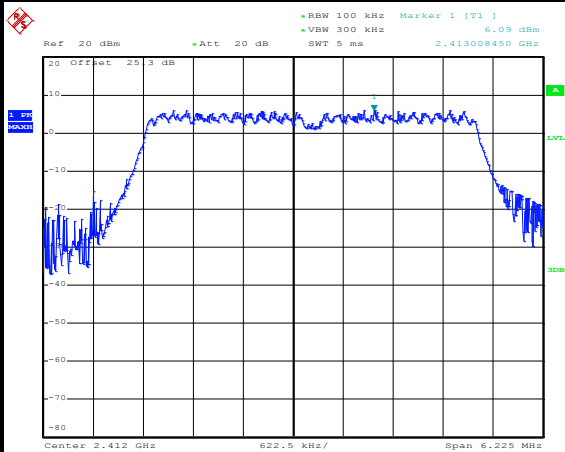

Date: 23.JUL.2015 21:55:34

Low Channel Plot

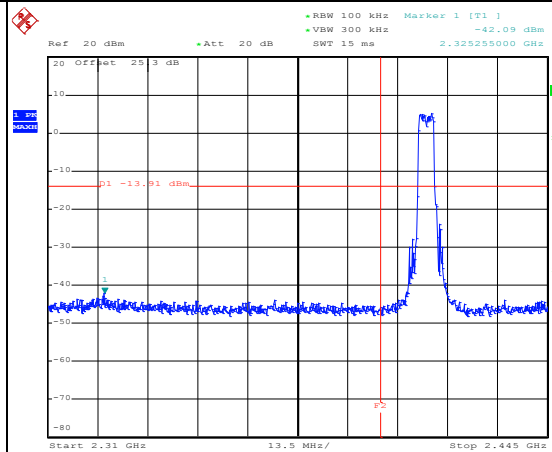

Date: 23.JUL.2015 21:55:50

Spurious Emission 30MHz~3GHz

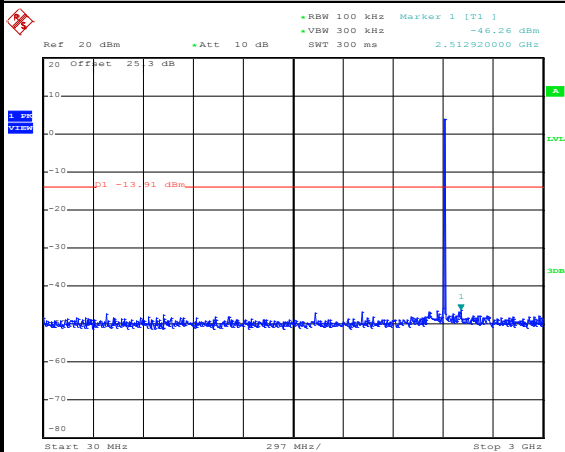

Date: 23.JUL.2015 21:56:58

Spurious Emission 2GHz~25GHz

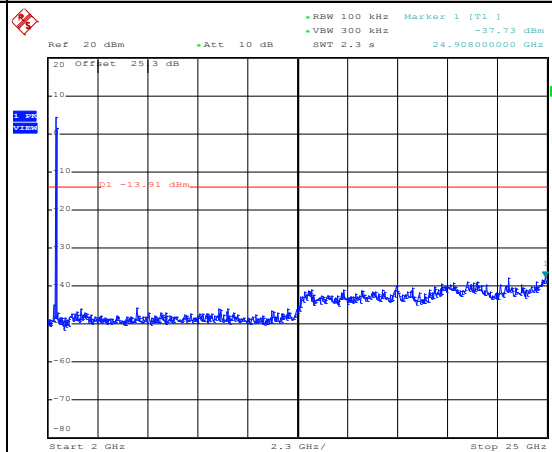

Date: 23.JUL.2015 21:57:16



Number of TX :	2	Ant. :	1
Test Mode :	802.11g (5MHz)	Temperature :	24~26°C
Test Band :	2.4GHz Mid	Relative Humidity :	45~49%
Test Channel :	06	Test Engineer :	Bill Kuo

WLAN 802.11g (5MHz) Channel 06

100kHz PSD reference Level

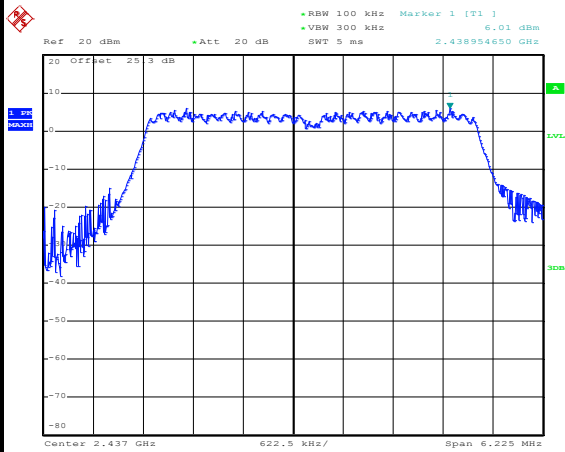

Date: 23.JUL.2015 22:04:25

Spurious Emission 30MHz~3GHz

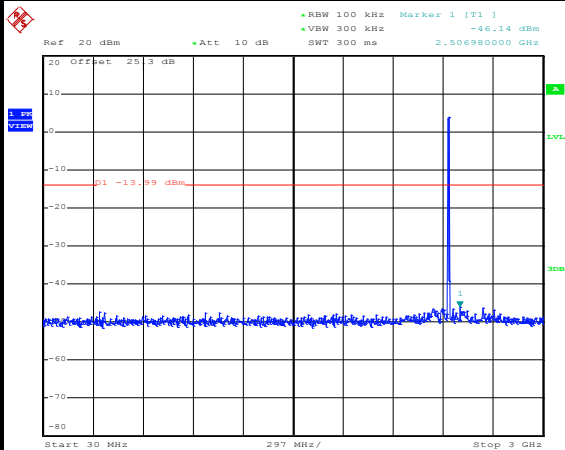

Date: 23.JUL.2015 22:05:03

Spurious Emission 2GHz~25GHz

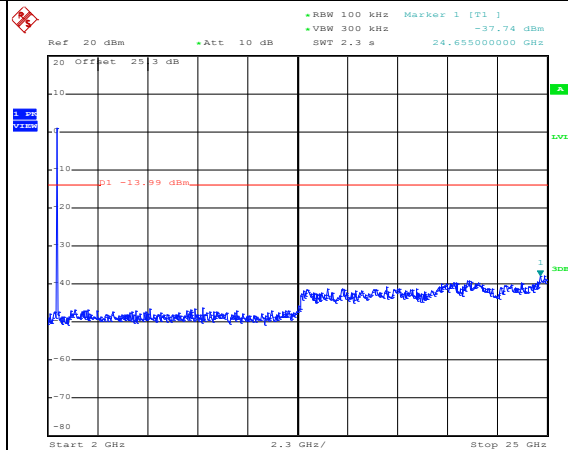

Date: 23.JUL.2015 22:05:20



Number of TX :	2	Ant. :	1
Test Mode :	802.11g (5MHz)	Temperature :	24~26°C
Test Band :	2.4GHz High	Relative Humidity :	45~49%
Test Channel :	11	Test Engineer :	Bill Kuo

WLAN 802.11g (5MHz) Channel 11

100kHz PSD reference Level

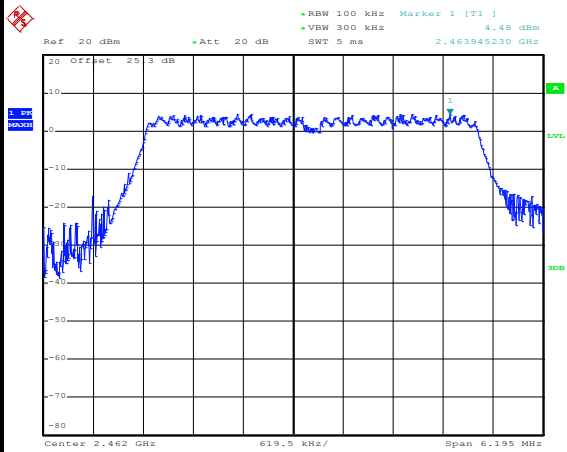

Date: 23.JUL.2015 22:30:50

High Channel Plot

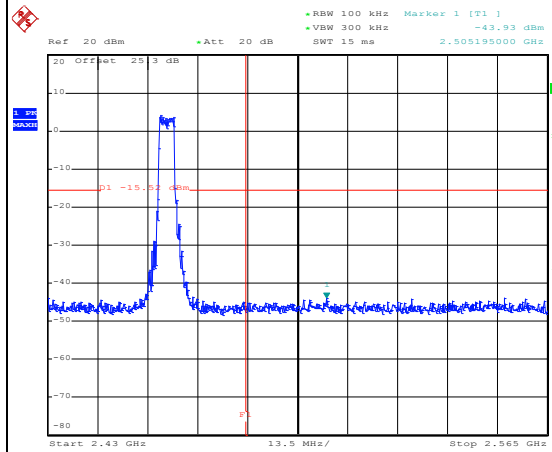

Date: 23.JUL.2015 22:31:07

Spurious Emission 30MHz~3GHz

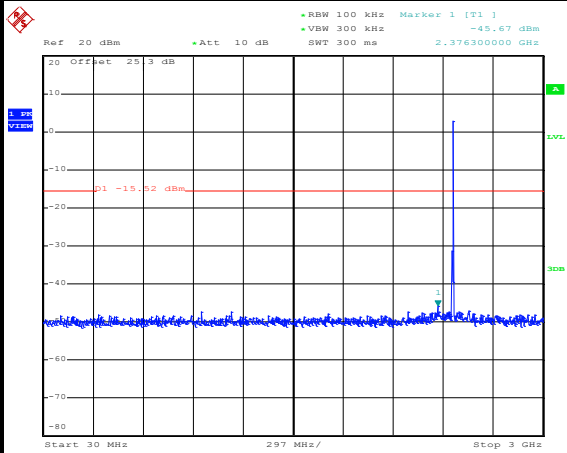

Date: 23.JUL.2015 22:31:29

Spurious Emission 2GHz~25GHz

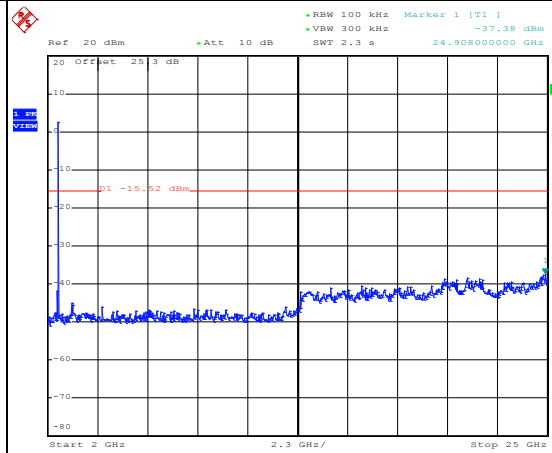

Date: 23.JUL.2015 22:31:47



Number of TX :	2	Ant. :	1
Test Mode :	802.11g (8MHz)	Temperature :	24~26°C
Test Band :	2.4GHz Low	Relative Humidity :	45~49%
Test Channel :	01	Test Engineer :	Bill Kuo

WLAN 802.11g (8MHz) Channel 01

100kHz PSD reference Level

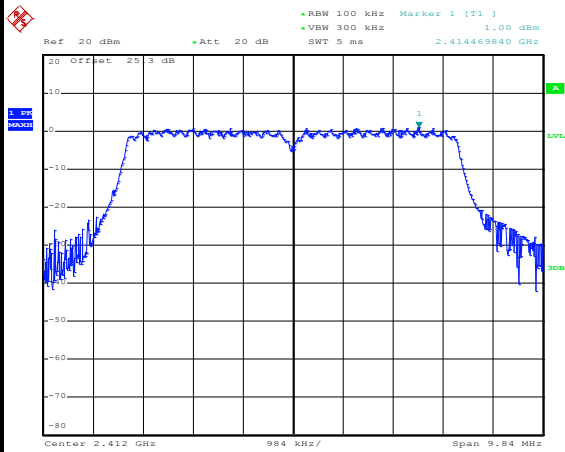

Date: 23.JUL.2015 22:46:18

Low Channel Plot

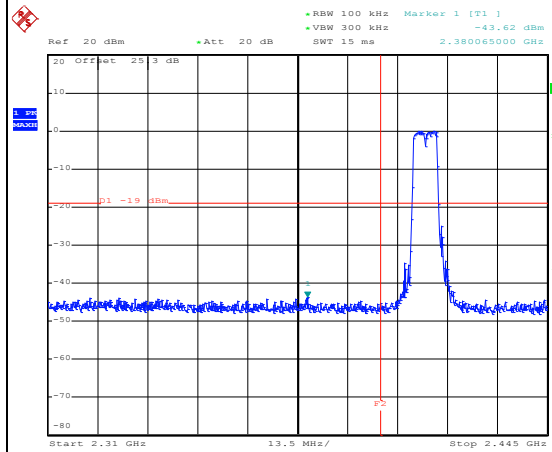

Date: 23.JUL.2015 22:46:40

Spurious Emission 30MHz~3GHz

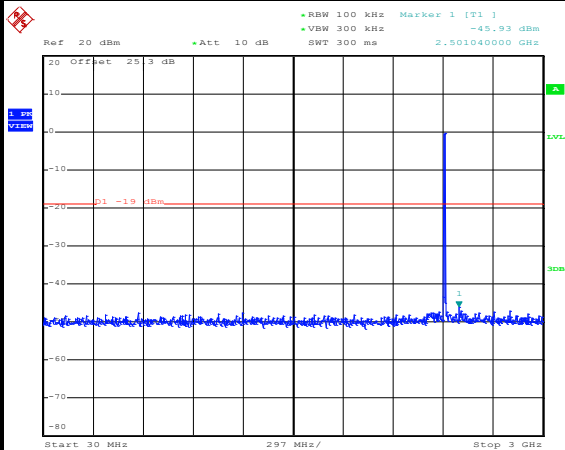

Date: 23.JUL.2015 22:47:01

Spurious Emission 2GHz~25GHz

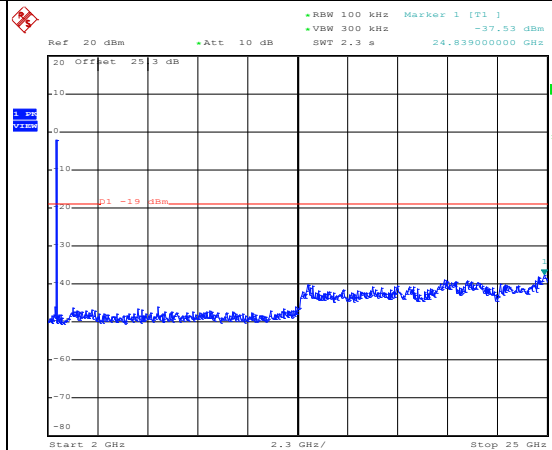

Date: 23.JUL.2015 22:47:19



Number of TX :	2	Ant. :	1
Test Mode :	802.11g (8MHz)	Temperature :	24~26°C
Test Band :	2.4GHz Mid	Relative Humidity :	45~49%
Test Channel :	06	Test Engineer :	Bill Kuo

WLAN 802.11g (8MHz) Channel 06

100kHz PSD reference Level

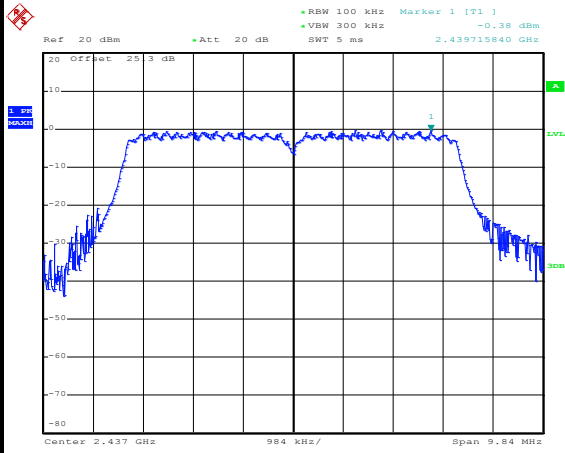

Date: 23.JUL.2015 22:50:44

Spurious Emission 30MHz~3GHz

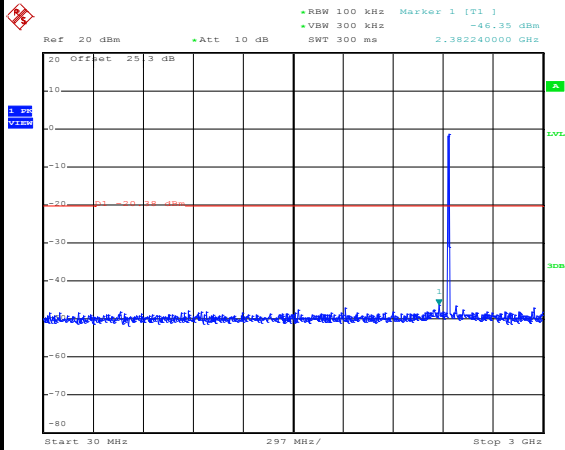

Date: 23.JUL.2015 22:51:06

Spurious Emission 2GHz~25GHz

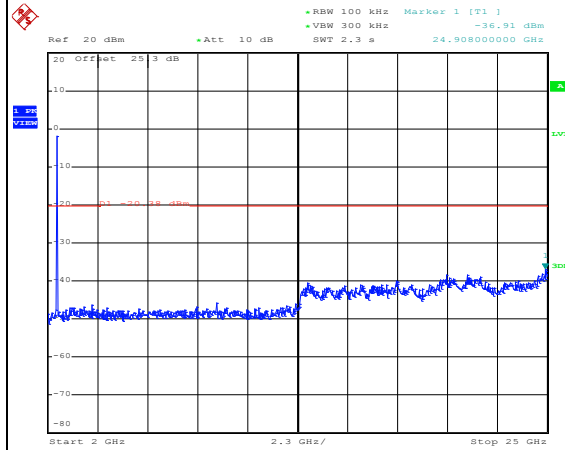

Date: 23.JUL.2015 22:51:24



Number of TX :	2	Ant. :	1
Test Mode :	802.11g (8MHz)	Temperature :	24~26°C
Test Band :	2.4GHz High	Relative Humidity :	45~49%
Test Channel :	11	Test Engineer :	Bill Kuo

WLAN 802.11g (8MHz) Channel 11

100kHz PSD reference Level

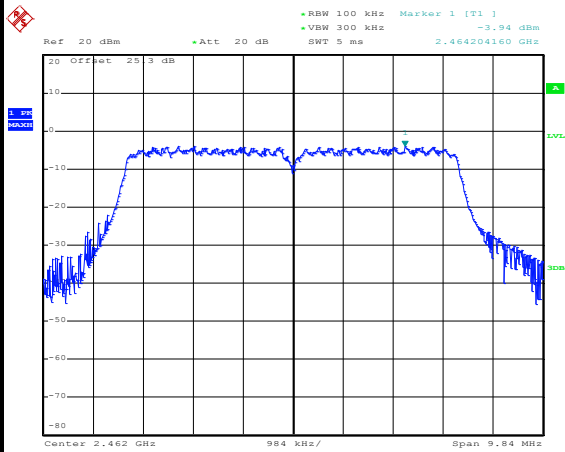

Date: 23.JUL.2015 23:05:10

High Channel Plot

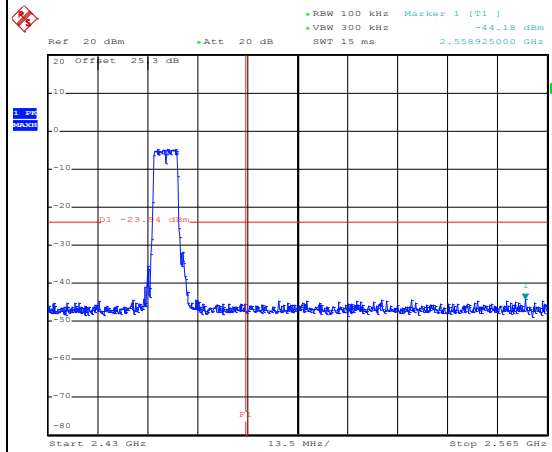

Date: 23.JUL.2015 23:05:26

Spurious Emission 30MHz~3GHz

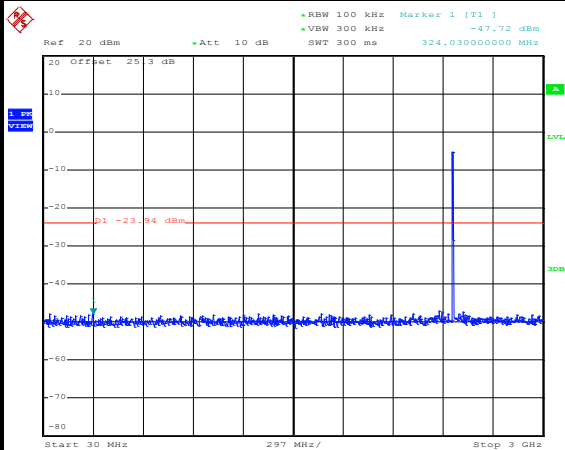

Date: 23.JUL.2015 23:05:47

Spurious Emission 2GHz~25GHz

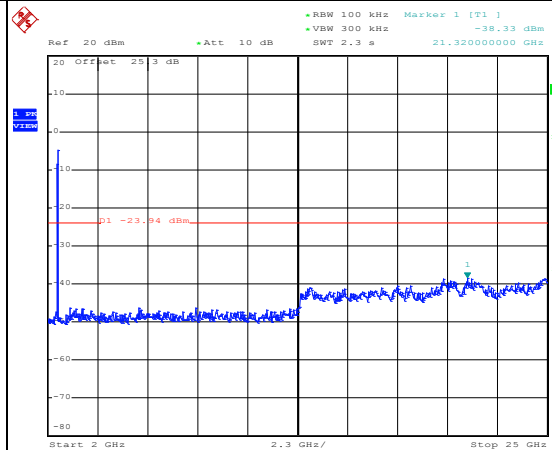

Date: 23.JUL.2015 23:06:05



Number of TX :	2	Ant. :	1
Test Mode :	802.11g (10MHz)	Temperature :	24~26°C
Test Band :	2.4GHz Low	Relative Humidity :	45~49%
Test Channel :	01	Test Engineer :	Bill Kuo

WLAN 802.11g (10MHz) Channel 01

100kHz PSD reference Level

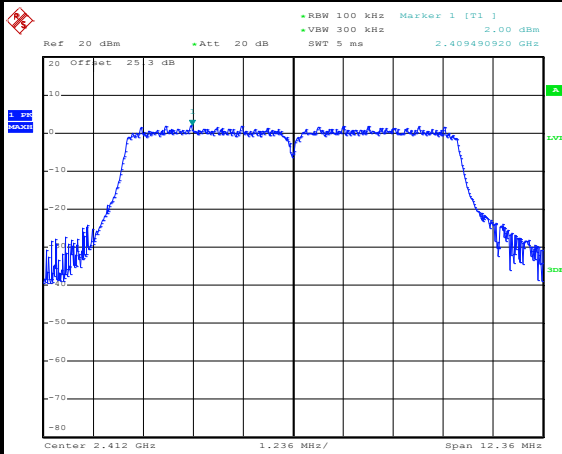

Date: 23.JUL.2015 23:17:00

Low Channel Plot

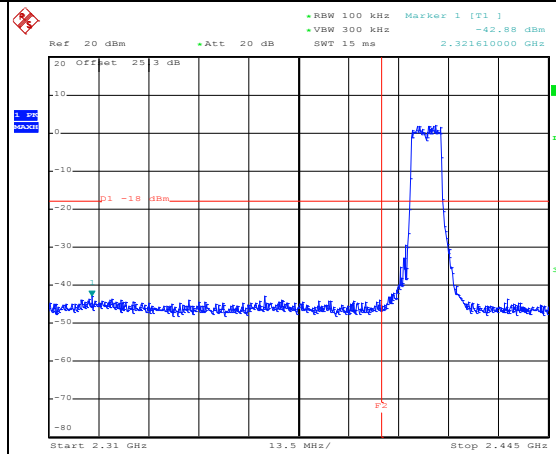

Date: 23.JUL.2015 23:17:16

Spurious Emission 30MHz~3GHz

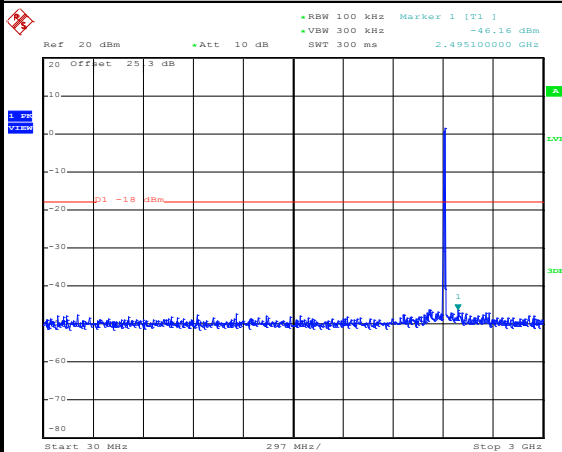

Date: 23.JUL.2015 23:18:16

Spurious Emission 2GHz~25GHz

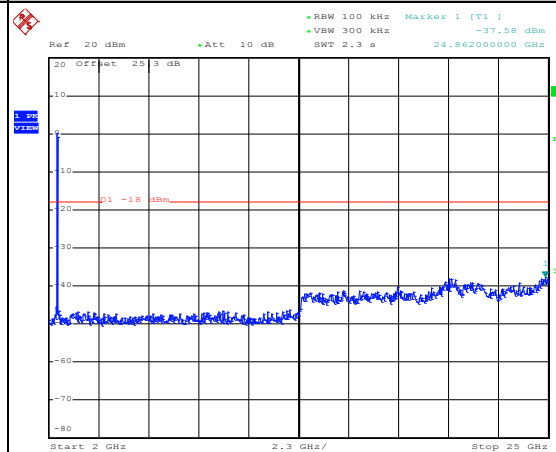

Date: 23.JUL.2015 23:18:34



Number of TX :	2	Ant. :	1
Test Mode :	802.11g (10MHz)	Temperature :	24~26°C
Test Band :	2.4GHz Mid	Relative Humidity :	45~49%
Test Channel :	06	Test Engineer :	Bill Kuo

WLAN 802.11g (10MHz) Channel 06

100kHz PSD reference Level

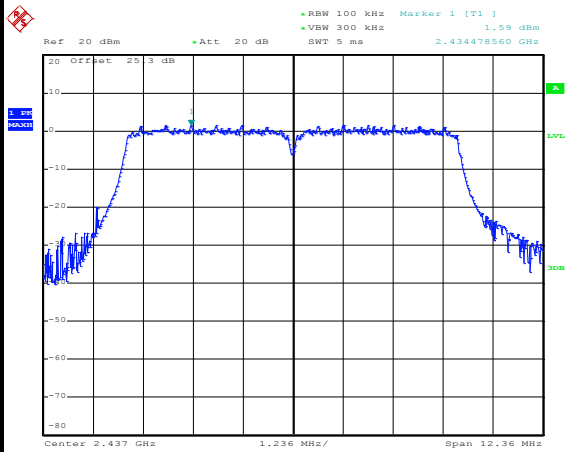

Date: 23.JUL.2015 23:31:46

Spurious Emission 30MHz~3GHz

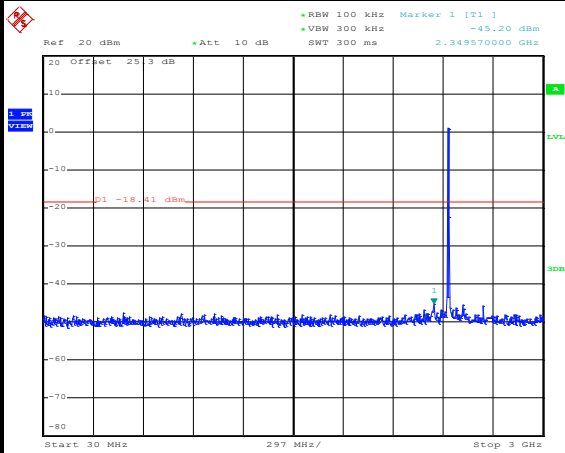

Date: 23.JUL.2015 23:32:13

Spurious Emission 2GHz~25GHz

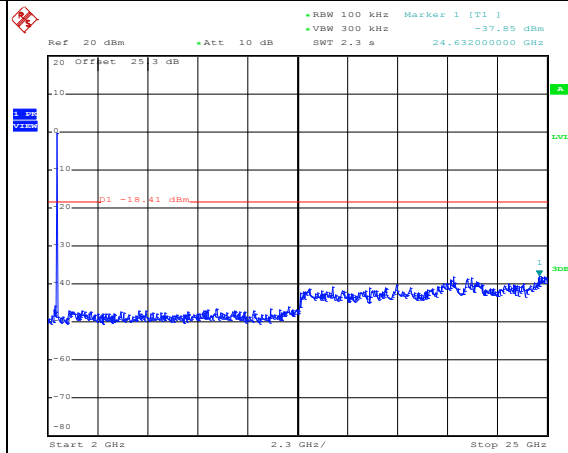

Date: 23.JUL.2015 23:32:31



Number of TX :	2	Ant. :	1
Test Mode :	802.11g (10MHz)	Temperature :	24~26°C
Test Band :	2.4GHz High	Relative Humidity :	45~49%
Test Channel :	11	Test Engineer :	Bill Kuo

WLAN 802.11g (10MHz) Channel 11

100kHz PSD reference Level

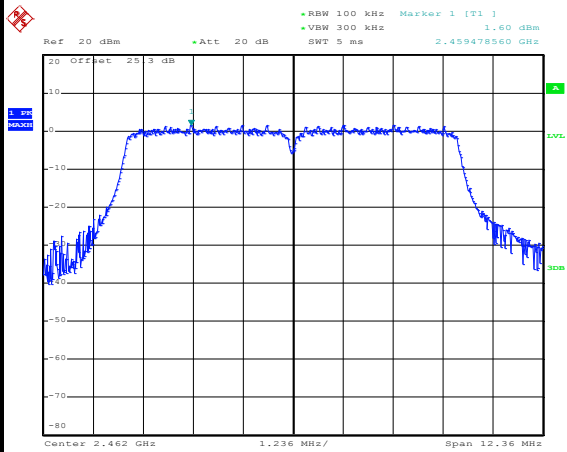

Date: 23.JUL.2015 23:44:26

High Channel Plot

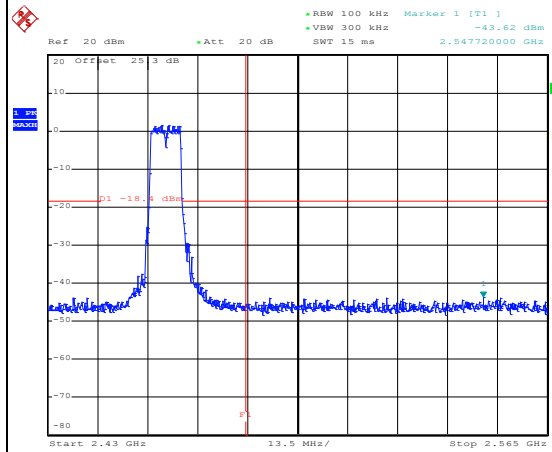

Date: 23.JUL.2015 23:44:53

Spurious Emission 30MHz~3GHz

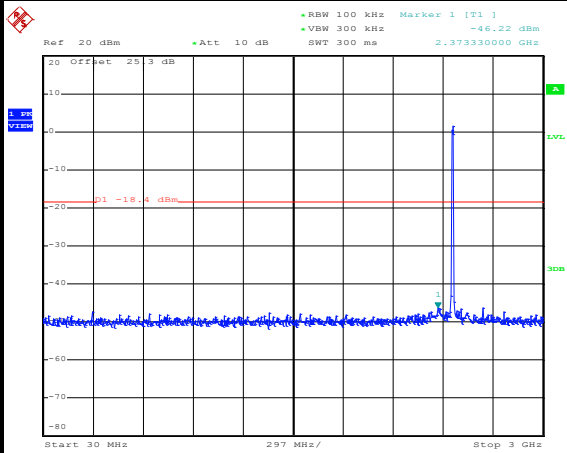

Date: 23.JUL.2015 23:45:14

Spurious Emission 2GHz~25GHz

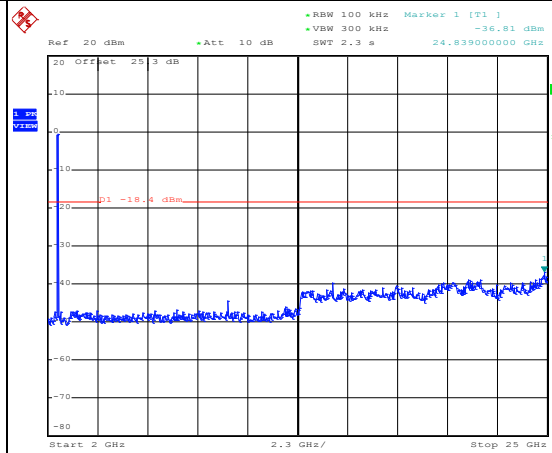

Date: 23.JUL.2015 23:45:32



Number of TX :	2	Ant. :	1
Test Mode :	802.11g (20MHz)	Temperature :	24~26°C
Test Band :	2.4GHz Low	Relative Humidity :	45~49%
Test Channel :	01	Test Engineer :	Bill Kuo

WLAN 802.11g (20MHz) Channel 01

100kHz PSD reference Level

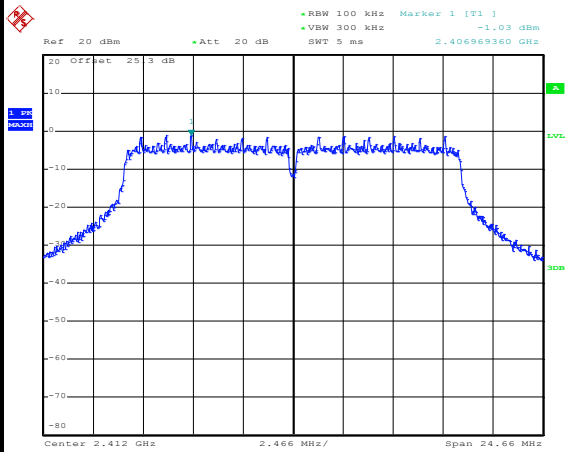

Date: 23.JUL.2015 23:58:00

Low Channel Plot

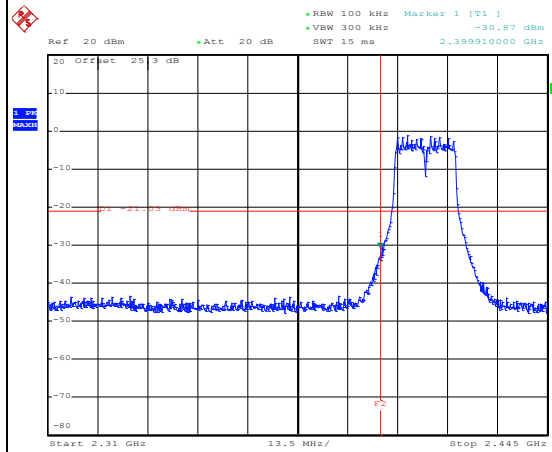

Date: 23.JUL.2015 23:58:16

Spurious Emission 30MHz~3GHz

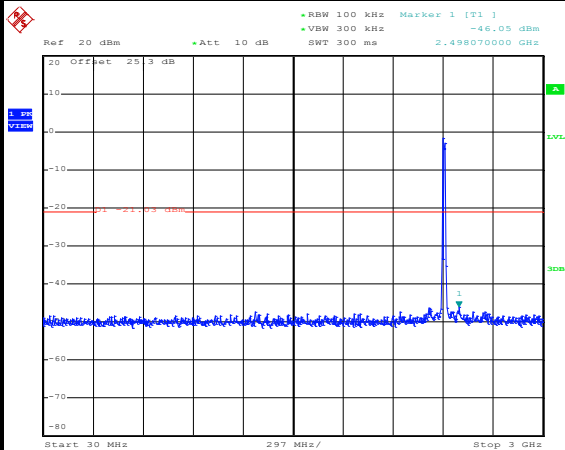

Date: 23.JUL.2015 23:58:38

Spurious Emission 2GHz~25GHz

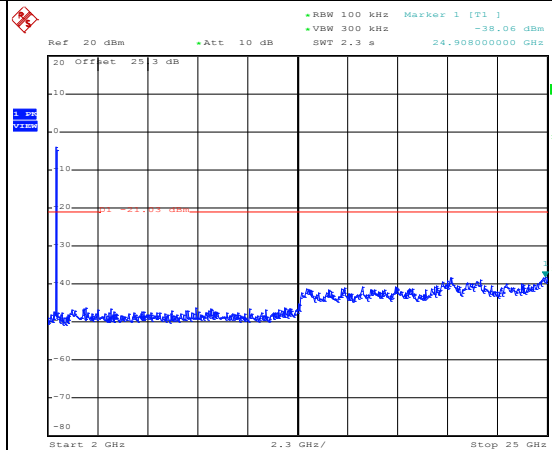

Date: 23.JUL.2015 23:58:56



Number of TX :	2	Ant. :	1
Test Mode :	802.11g (20MHz)	Temperature :	24~26°C
Test Band :	2.4GHz Mid	Relative Humidity :	45~49%
Test Channel :	06	Test Engineer :	Bill Kuo

WLAN 802.11g (20MHz) Channel 06

100kHz PSD reference Level

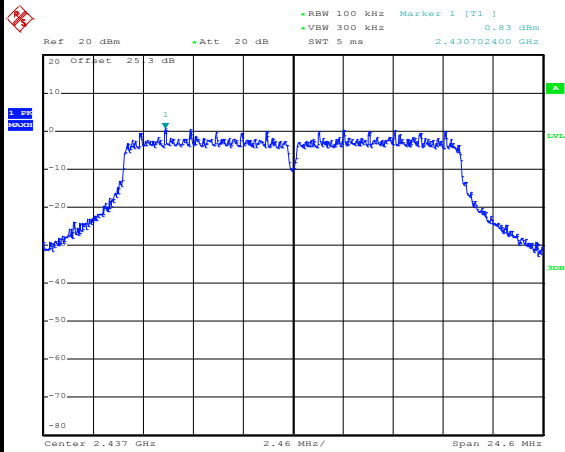

Date: 24.JUL.2015 00:10:44

Spurious Emission 30MHz~3GHz

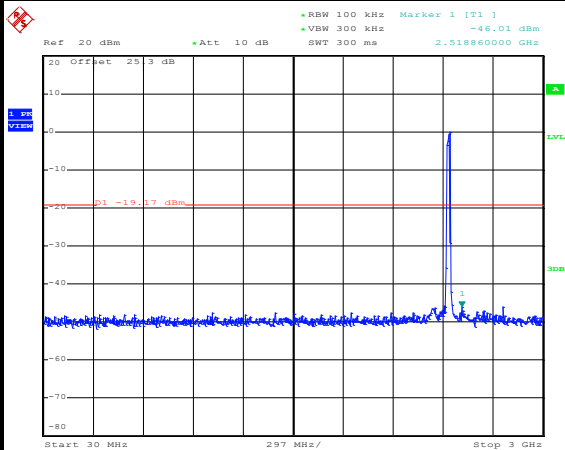

Date: 24.JUL.2015 00:11:05

Spurious Emission 2GHz~25GHz

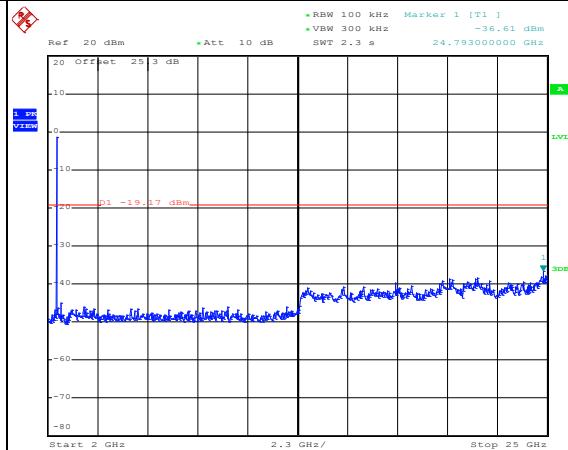

Date: 24.JUL.2015 00:11:23



Number of TX :	2	Ant. :	1
Test Mode :	802.11g (20MHz)	Temperature :	24~26°C
Test Band :	2.4GHz High	Relative Humidity :	45~49%
Test Channel :	11	Test Engineer :	Bill Kuo

WLAN 802.11g (20MHz) Channel 11

100kHz PSD reference Level

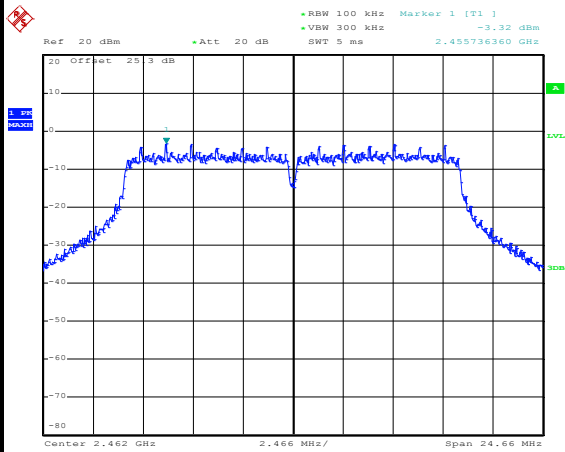

Date: 24.JUL.2015 00:13:57

High Channel Plot

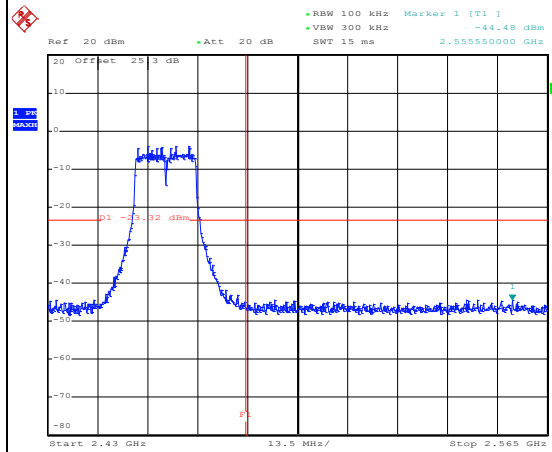

Date: 24.JUL.2015 00:15:17

Spurious Emission 30MHz~3GHz

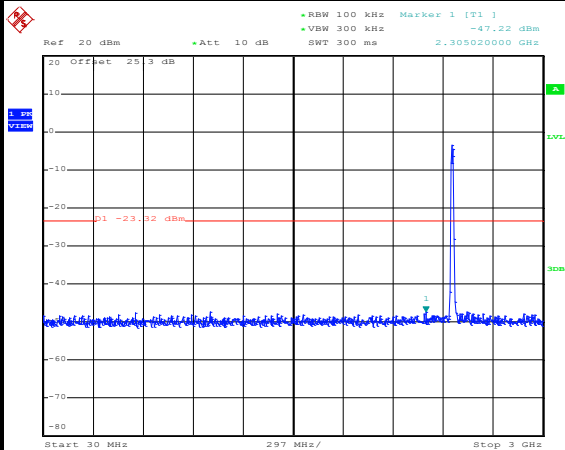

Date: 24.JUL.2015 00:14:22

Spurious Emission 2GHz~25GHz

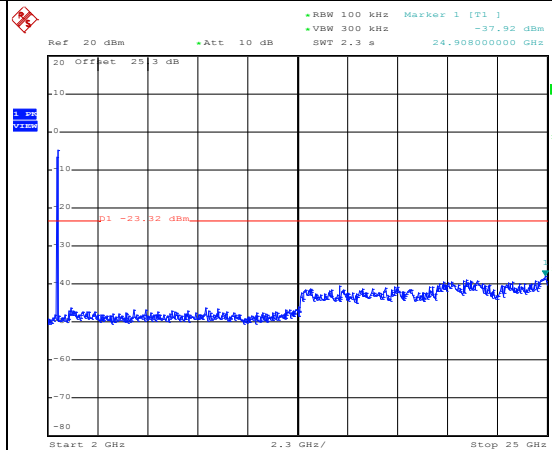

Date: 24.JUL.2015 00:14:40



Number of TX :	2	Ant. :	1
Test Mode :	802.11g (30MHz)	Temperature :	24~26°C
Test Band :	2.4GHz Low	Relative Humidity :	45~49%
Test Channel :	02	Test Engineer :	Bill Kuo

WLAN 802.11g (30MHz) Channel 02

100kHz PSD reference Level

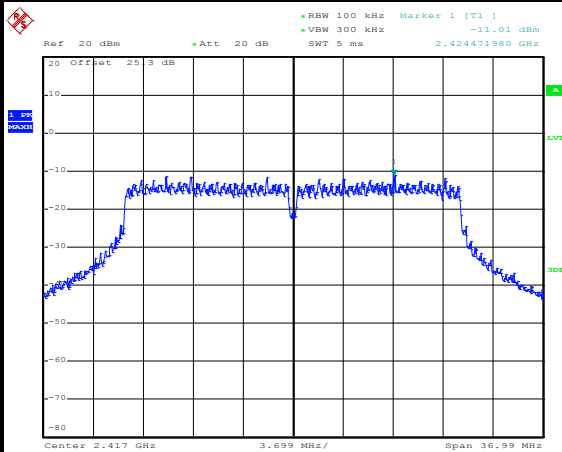

Date: 24.JUL.2015 21:14:00

Low Channel Plot

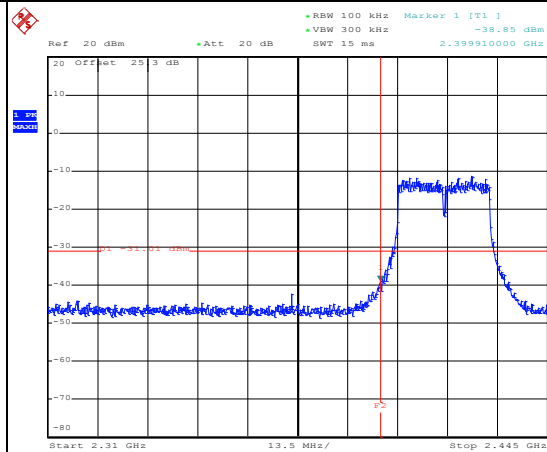

Date: 24.JUL.2015 21:14:37

Spurious Emission 30MHz~3GHz

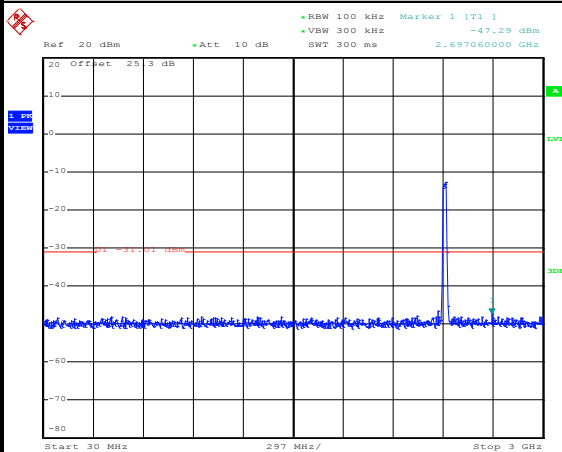

Date: 24.JUL.2015 21:14:58

Spurious Emission 2GHz~25GHz

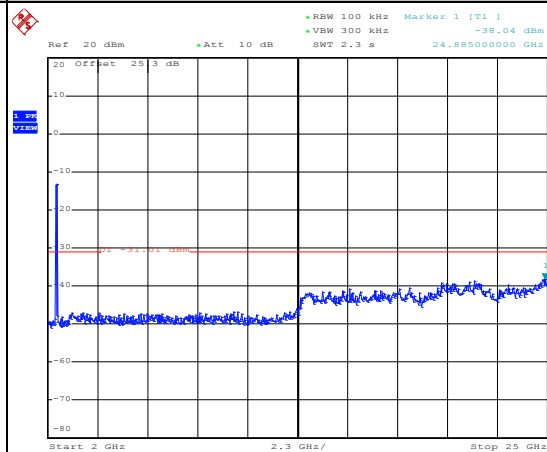

Date: 24.JUL.2015 21:15:16



Number of TX :	2	Ant. :	1
Test Mode :	802.11g (30MHz)	Temperature :	24~26°C
Test Band :	2.4GHz Mid	Relative Humidity :	45~49%
Test Channel :	06	Test Engineer :	Bill Kuo

WLAN 802.11g (30MHz) Channel 06

100kHz PSD reference Level

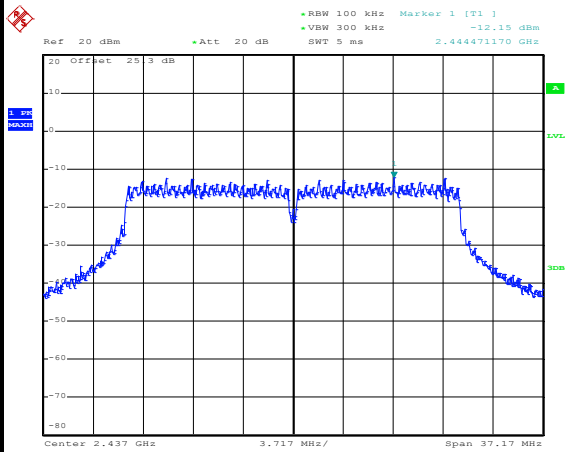

Date: 24.JUL.2015 00:21:19

Spurious Emission 30MHz~3GHz

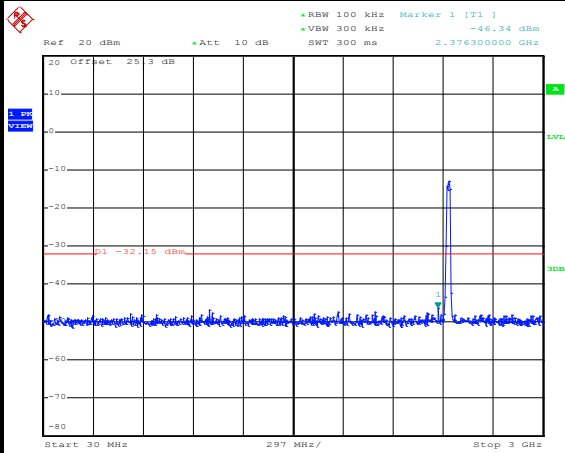

Date: 24.JUL.2015 00:21:40

Spurious Emission 2GHz~25GHz

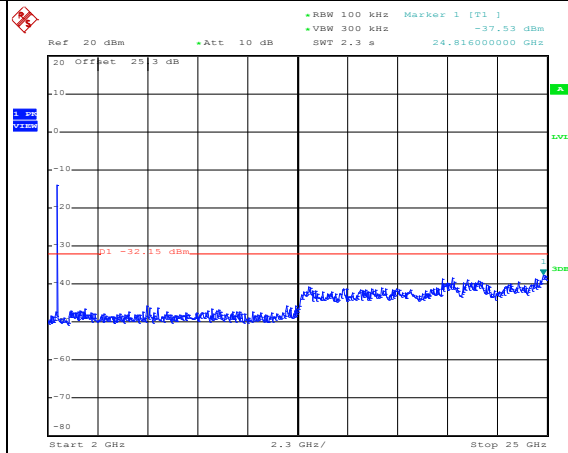

Date: 24.JUL.2015 00:21:58



Number of TX :	2	Ant. :	1
Test Mode :	802.11g (30MHz)	Temperature :	24~26°C
Test Band :	2.4GHz High	Relative Humidity :	45~49%
Test Channel :	10	Test Engineer :	Bill Kuo

WLAN 802.11g (30MHz) Channel 10

100kHz PSD reference Level

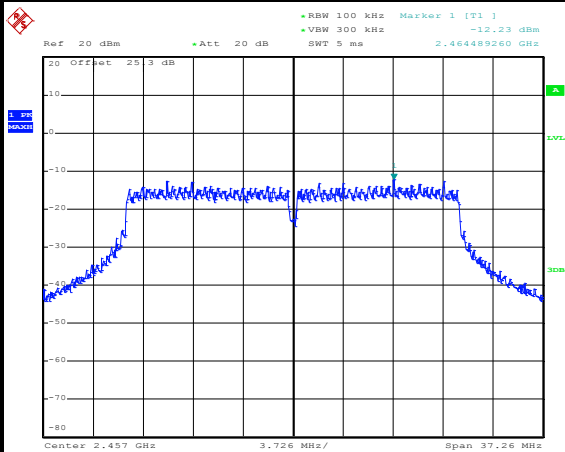

Date: 24.JUL.2015 21:20:18

High Channel Plot

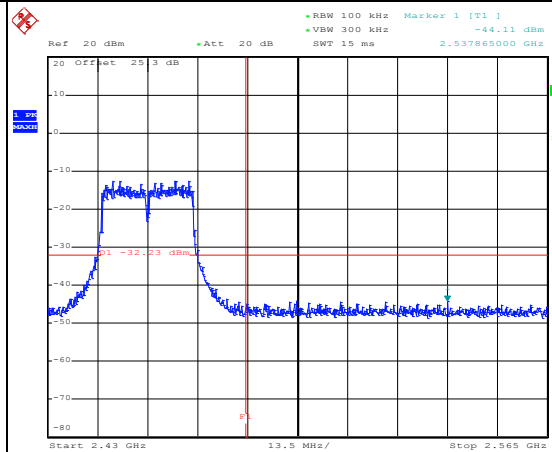

Date: 24.JUL.2015 21:20:37

Spurious Emission 30MHz~3GHz

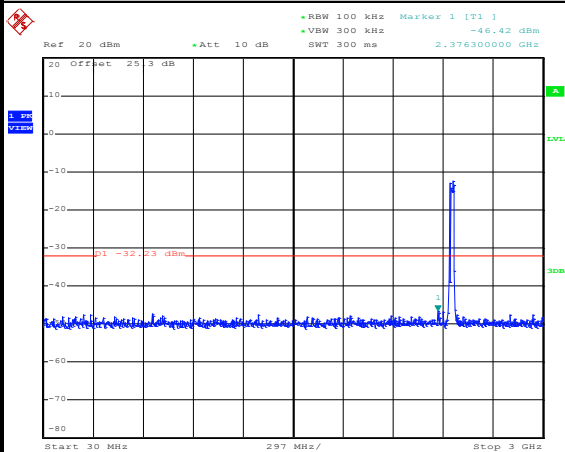

Date: 24.JUL.2015 21:21:55

Spurious Emission 2GHz~25GHz

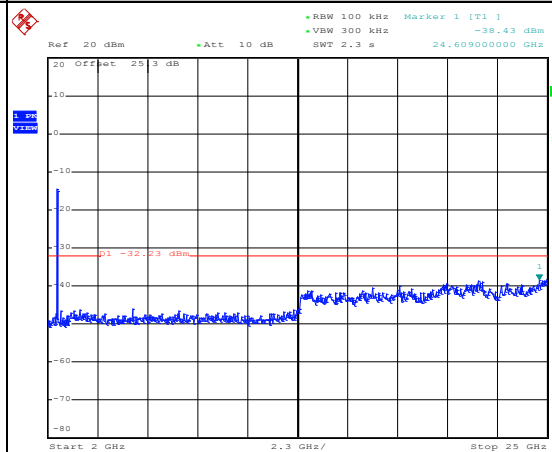

Date: 24.JUL.2015 21:22:13



Number of TX :	2	Ant. :	1
Test Mode :	802.11n HT20 (5MHz)	Temperature :	24~26°C
Test Band :	2.4GHz Low	Relative Humidity :	45~49%
Test Channel :	01	Test Engineer :	Bill Kuo

WLAN 802.11n HT20 (5MHz) Channel 01

100kHz PSD reference Level

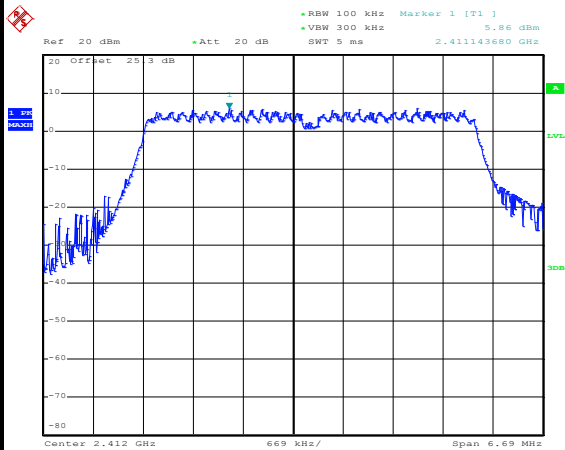

Date: 24.JUL.2015 00:32:35

Low Channel Plot

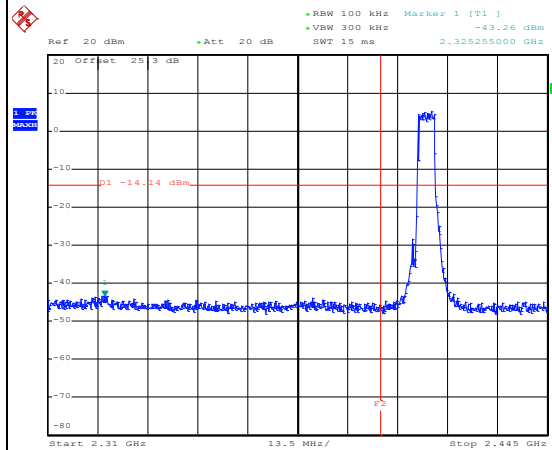

Date: 24.JUL.2015 00:32:53

Spurious Emission 30MHz~3GHz

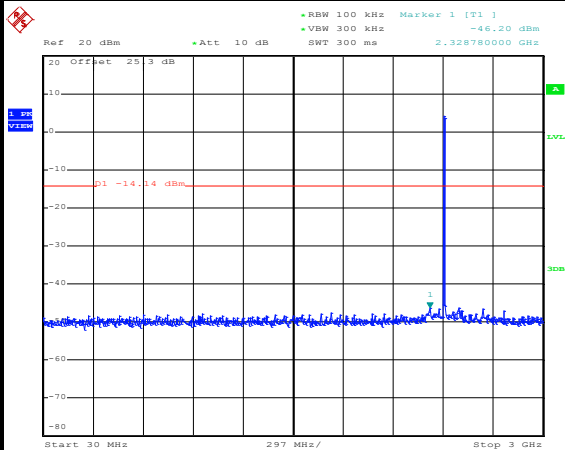

Date: 24.JUL.2015 00:33:44

Spurious Emission 2GHz~25GHz

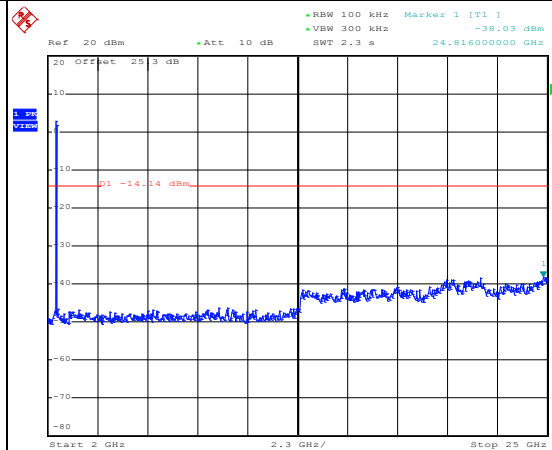

Date: 24.JUL.2015 00:34:02



Number of TX :	2	Ant. :	1
Test Mode :	802.11n HT20 (5MHz)	Temperature :	24~26°C
Test Band :	2.4GHz Mid	Relative Humidity :	45~49%
Test Channel :	06	Test Engineer :	Bill Kuo

WLAN 802.11n HT20 (5MHz) Channel 06

100kHz PSD reference Level

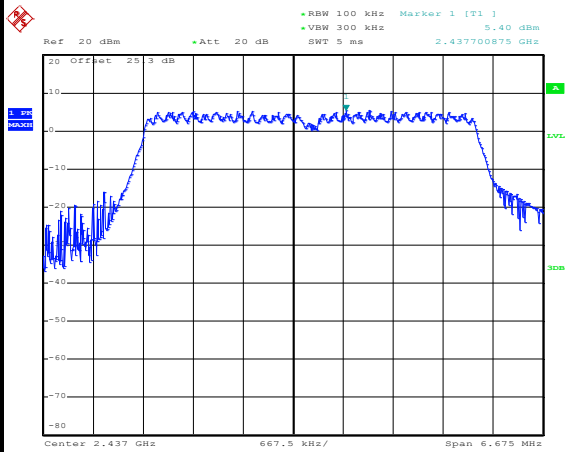

Date: 24.JUL.2015 00:43:28

Spurious Emission 30MHz~3GHz

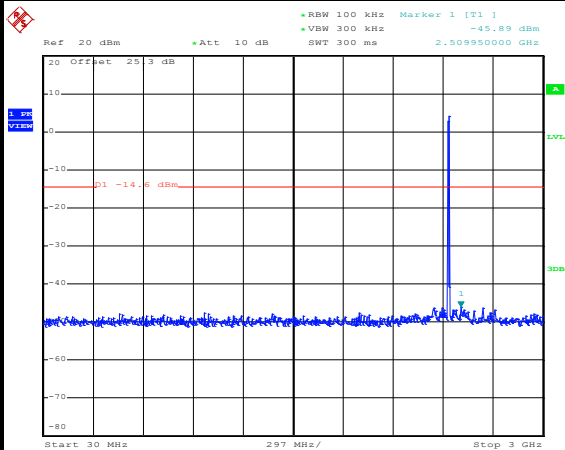

Date: 24.JUL.2015 00:43:50

Spurious Emission 2GHz~25GHz

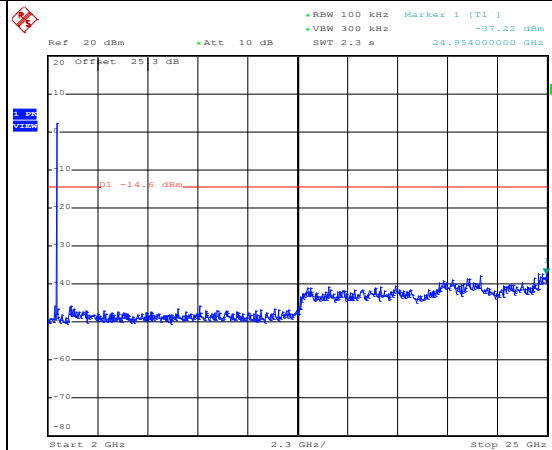

Date: 24.JUL.2015 00:44:07



Number of TX :	2	Ant. :	1
Test Mode :	802.11n HT20 (5MHz)	Temperature :	24~26°C
Test Band :	2.4GHz High	Relative Humidity :	45~49%
Test Channel :	11	Test Engineer :	Bill Kuo

WLAN 802.11n HT20 (5MHz) Channel 11

100kHz PSD reference Level

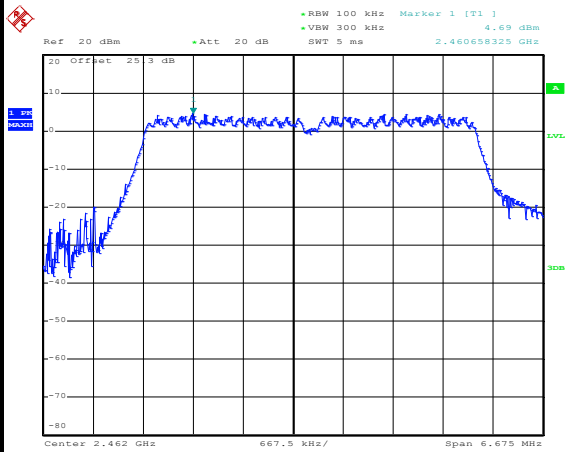

Date: 24.JUL.2015 00:47:14

High Channel Plot

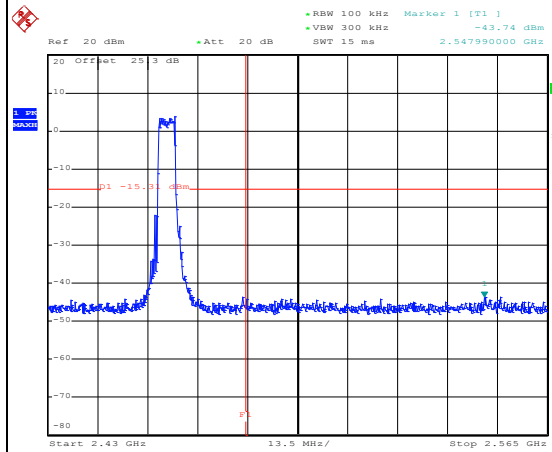

Date: 24.JUL.2015 00:47:32

Spurious Emission 30MHz~3GHz

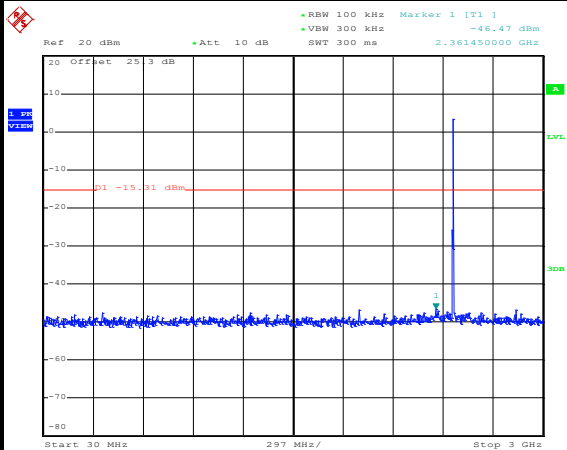

Date: 24.JUL.2015 00:47:53

Spurious Emission 2GHz~25GHz

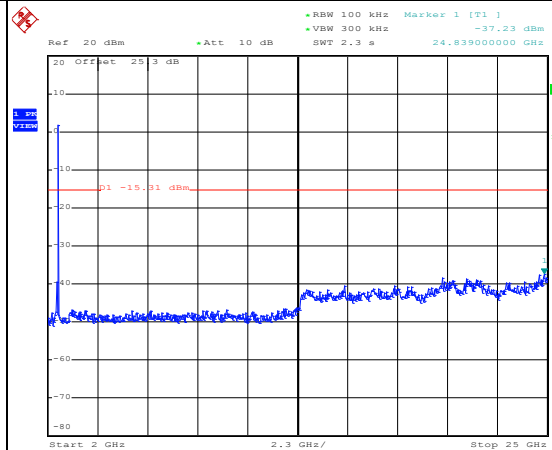

Date: 24.JUL.2015 00:48:10



Number of TX :	2	Ant. :	1
Test Mode :	802.11n HT20 (8MHz)	Temperature :	24~26°C
Test Band :	2.4GHz Low	Relative Humidity :	45~49%
Test Channel :	01	Test Engineer :	Bill Kuo

WLAN 802.11n HT20 (8MHz) Channel 01

100kHz PSD reference Level

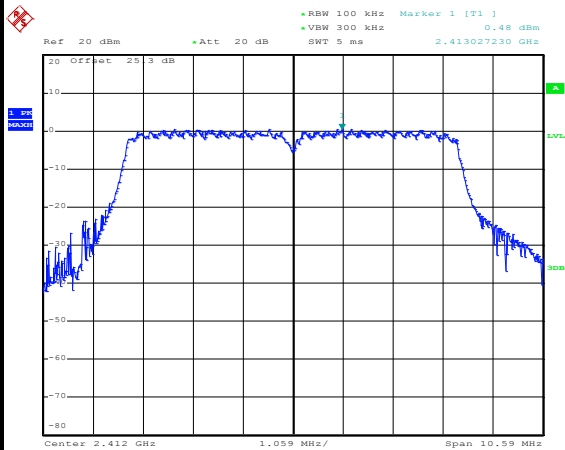

Date: 24.JUL.2015 01:01:37

Low Channel Plot

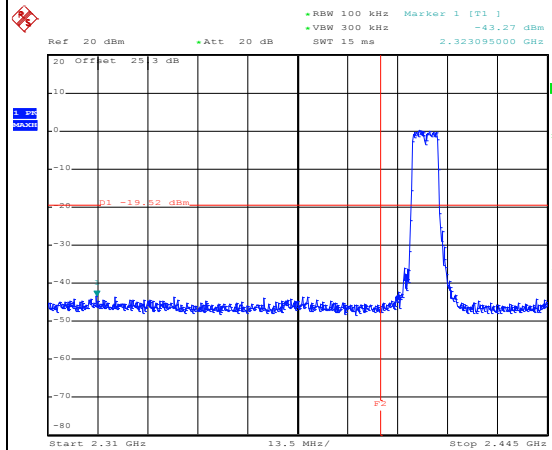

Date: 24.JUL.2015 01:01:54

Spurious Emission 30MHz~3GHz

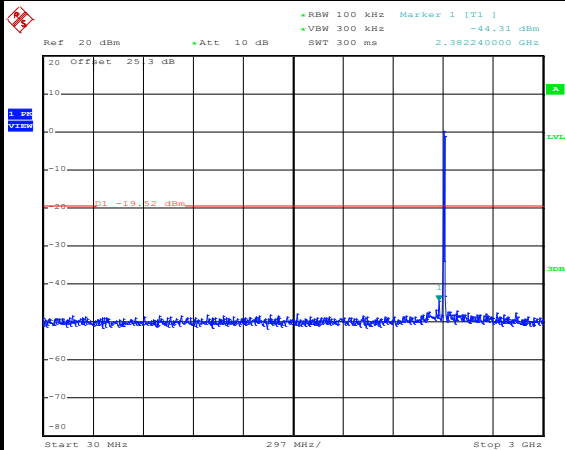

Date: 24.JUL.2015 01:02:15

Spurious Emission 2GHz~25GHz

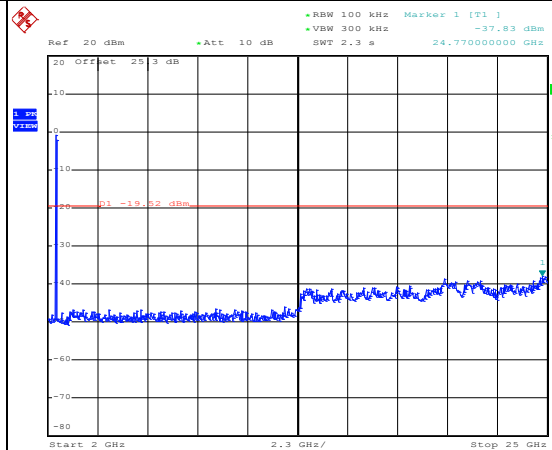

Date: 24.JUL.2015 01:02:33



Number of TX :	2	Ant. :	1
Test Mode :	802.11n HT20 (8MHz)	Temperature :	24~26°C
Test Band :	2.4GHz Mid	Relative Humidity :	45~49%
Test Channel :	06	Test Engineer :	Bill Kuo

WLAN 802.11n HT20 (8MHz) Channel 06

100kHz PSD reference Level

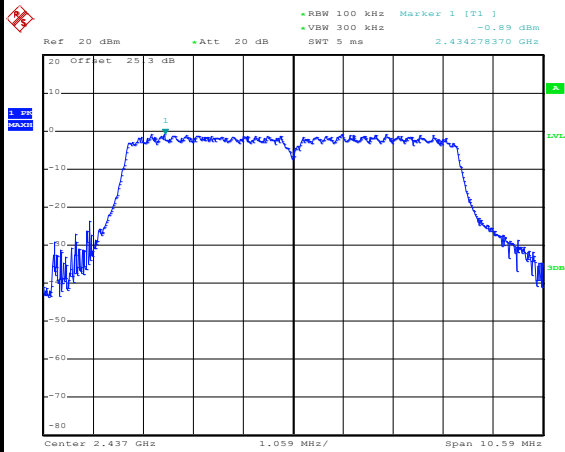

Date: 24.JUL.2015 01:05:23

Spurious Emission 30MHz~3GHz

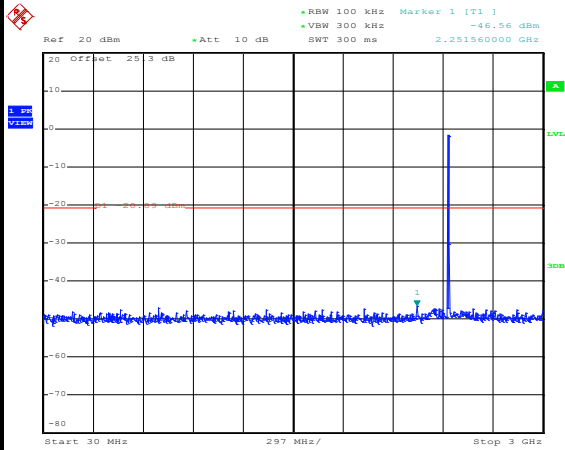

Date: 24.JUL.2015 01:05:43

Spurious Emission 2GHz~25GHz

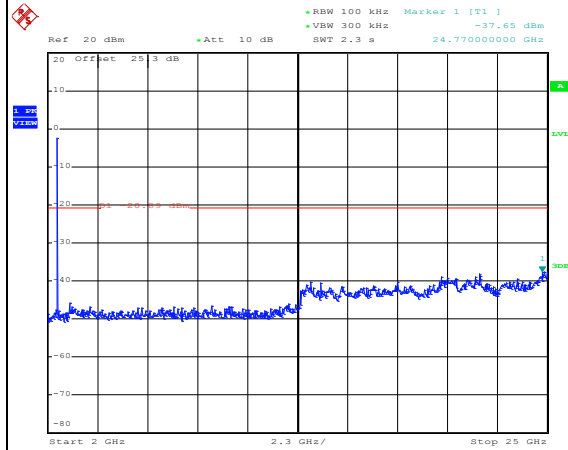

Date: 24.JUL.2015 01:06:01



Number of TX :	2	Ant. :	1
Test Mode :	802.11n HT20 (8MHz)	Temperature :	24~26°C
Test Band :	2.4GHz High	Relative Humidity :	45~49%
Test Channel :	11	Test Engineer :	Bill Kuo

WLAN 802.11n HT20 (8MHz) Channel 11

100kHz PSD reference Level

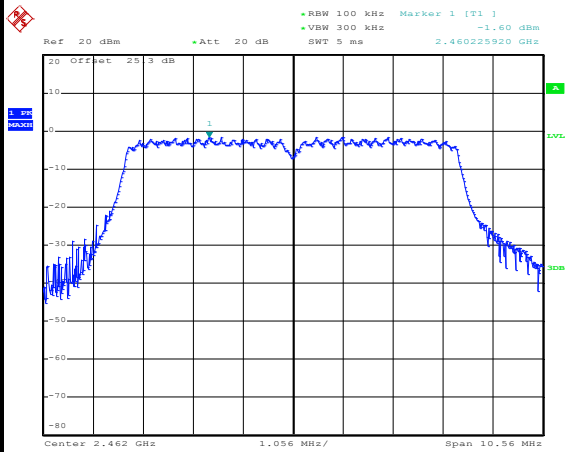

Date: 24.JUL.2015 01:15:14

High Channel Plot

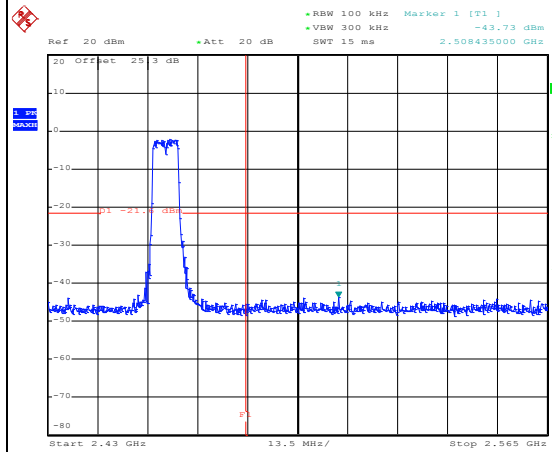

Date: 24.JUL.2015 01:15:30

Spurious Emission 30MHz~3GHz

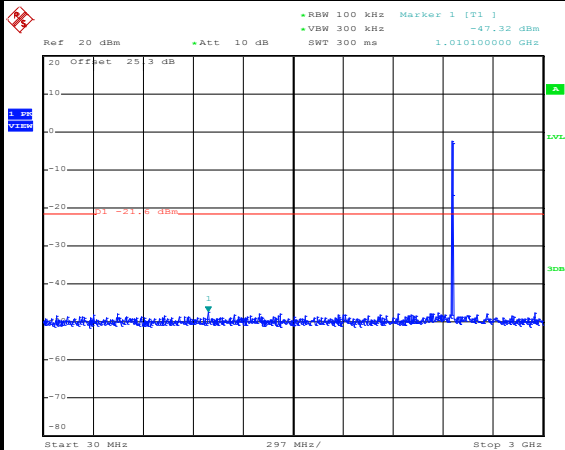

Date: 24.JUL.2015 01:15:50

Spurious Emission 2GHz~25GHz

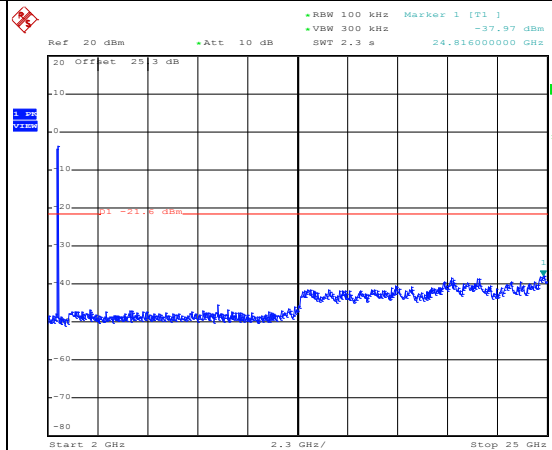

Date: 24.JUL.2015 01:16:08



Number of TX :	2	Ant. :	1
Test Mode :	802.11n HT20 (10MHz)	Temperature :	24~26°C
Test Band :	2.4GHz Low	Relative Humidity :	45~49%
Test Channel :	01	Test Engineer :	Bill Kuo

WLAN 802.11n HT20 (10MHz) Channel 01

100kHz PSD reference Level

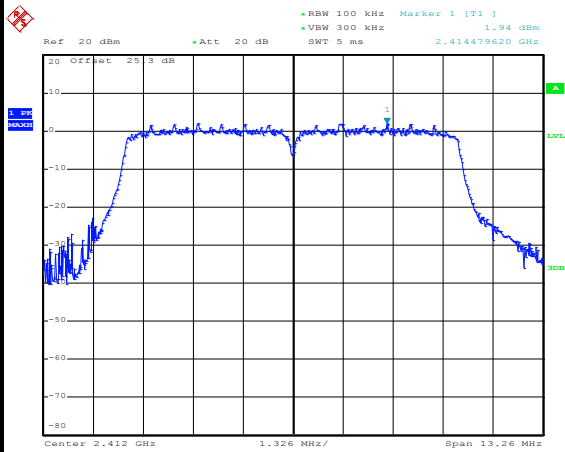

Date: 24.JUL.2015 01:19:42

Low Channel Plot

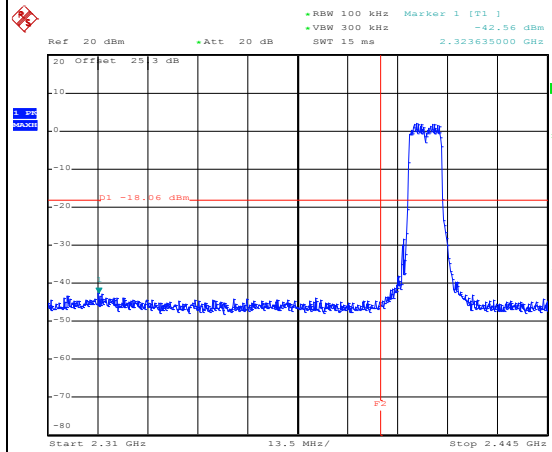

Date: 24.JUL.2015 01:19:58

Spurious Emission 30MHz~3GHz

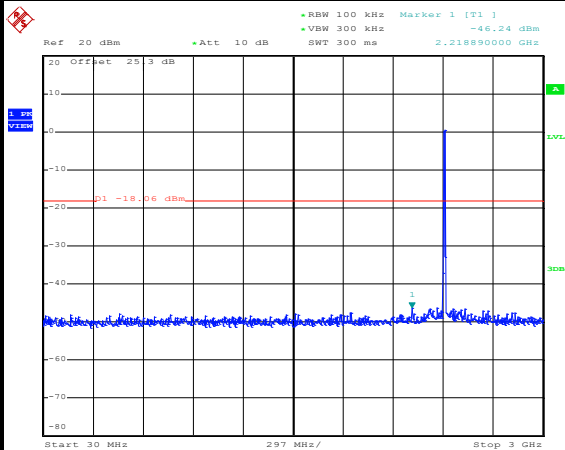

Date: 24.JUL.2015 01:20:19

Spurious Emission 2GHz~25GHz

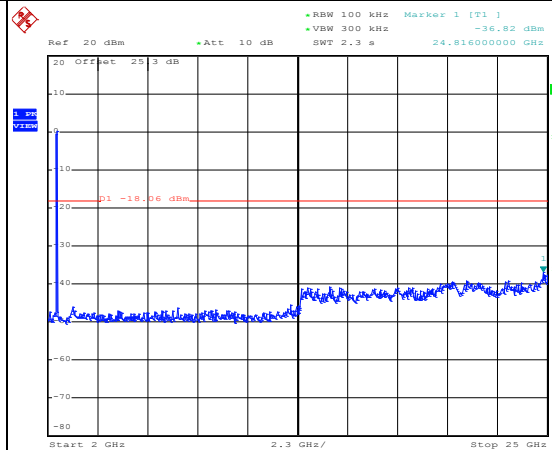

Date: 24.JUL.2015 01:20:37



Number of TX :	2	Ant. :	1
Test Mode :	802.11n HT20 (10MHz)	Temperature :	24~26°C
Test Band :	2.4GHz Mid	Relative Humidity :	45~49%
Test Channel :	06	Test Engineer :	Bill Kuo

WLAN 802.11n HT20 (10MHz) Channel 06

100kHz PSD reference Level

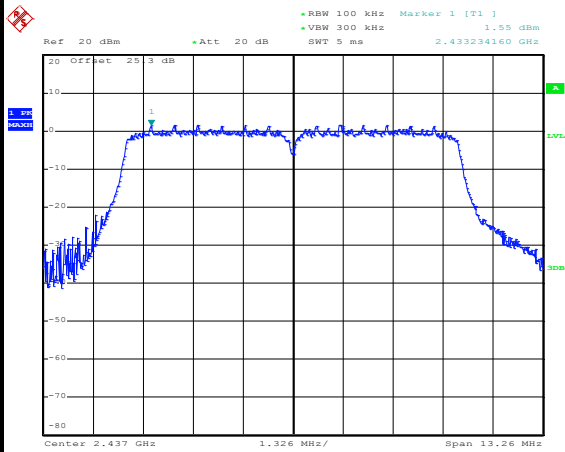

Date: 24.JUL.2015 01:35:00

Spurious Emission 30MHz~3GHz

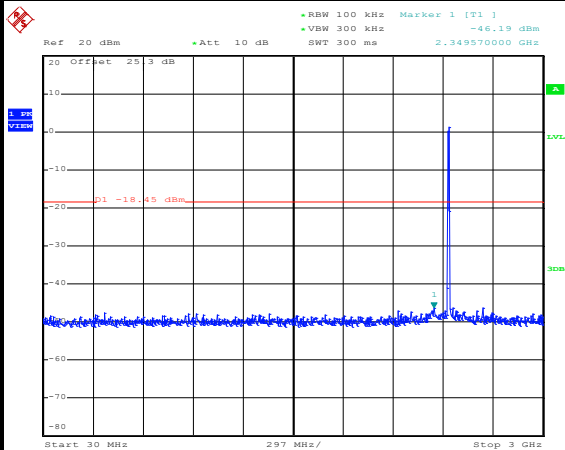

Date: 24.JUL.2015 01:35:22

Spurious Emission 2GHz~25GHz

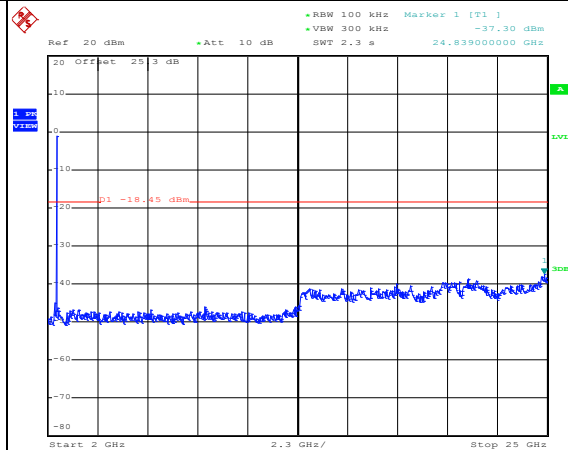

Date: 24.JUL.2015 01:35:40



Number of TX :	2	Ant. :	1
Test Mode :	802.11n HT20 (10MHz)	Temperature :	24~26°C
Test Band :	2.4GHz High	Relative Humidity :	45~49%
Test Channel :	11	Test Engineer :	Bill Kuo

WLAN 802.11n HT20 (10MHz) Channel 11

100kHz PSD reference Level

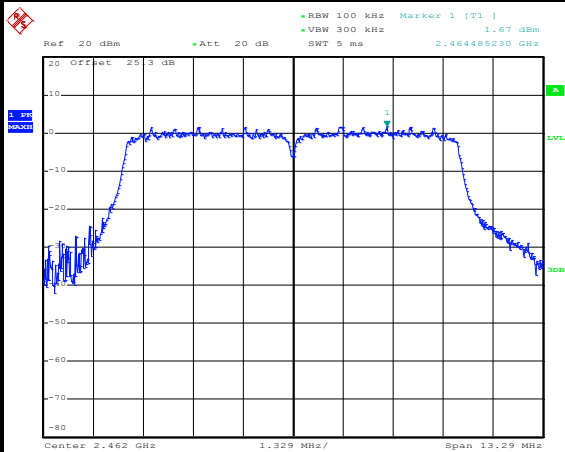

Date: 24.JUL.2015 01:38:31

High Channel Plot

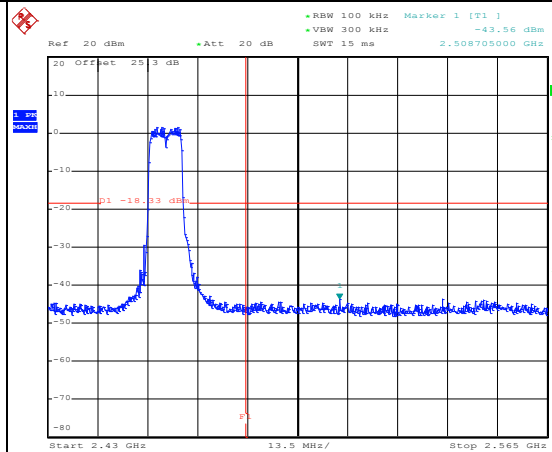

Date: 24.JUL.2015 01:38:48

Spurious Emission 30MHz~3GHz

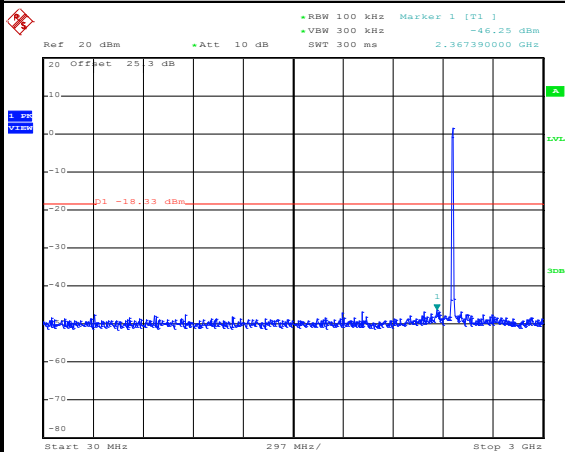

Date: 24.JUL.2015 01:39:11

Spurious Emission 2GHz~25GHz

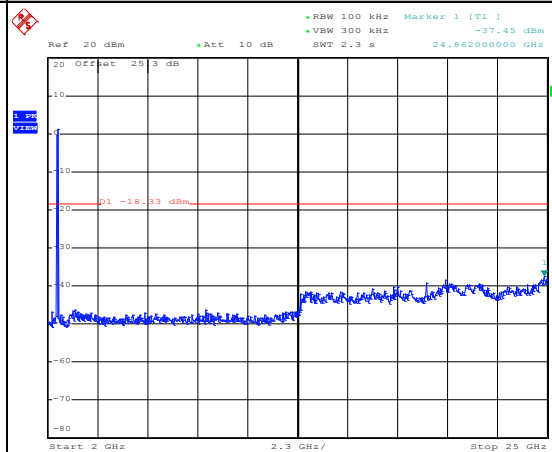

Date: 24.JUL.2015 01:39:29



Number of TX :	2	Ant. :	1
Test Mode :	802.11n HT20 (20MHz)	Temperature :	24~26°C
Test Band :	2.4GHz Low	Relative Humidity :	45~49%
Test Channel :	01	Test Engineer :	Bill Kuo

WLAN 802.11n HT20 (20MHz) Channel 01

100kHz PSD reference Level

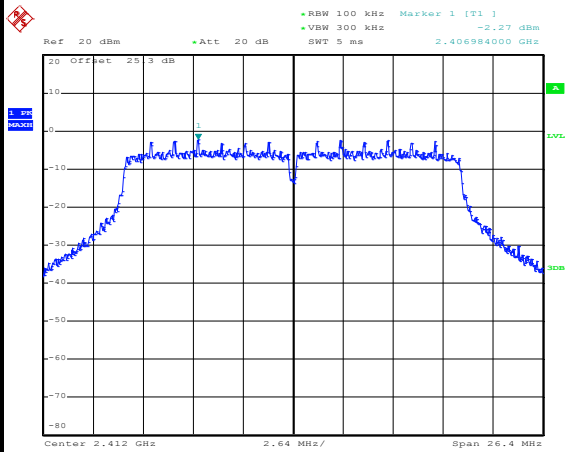

Date: 24.JUL.2015 19:46:46

Low Channel Plot

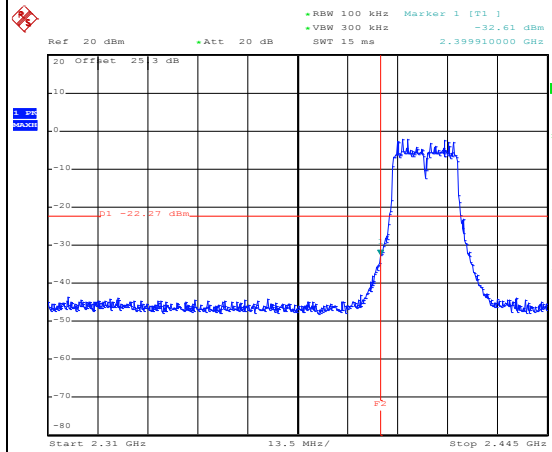

Date: 24.JUL.2015 19:47:02

Spurious Emission 30MHz~3GHz

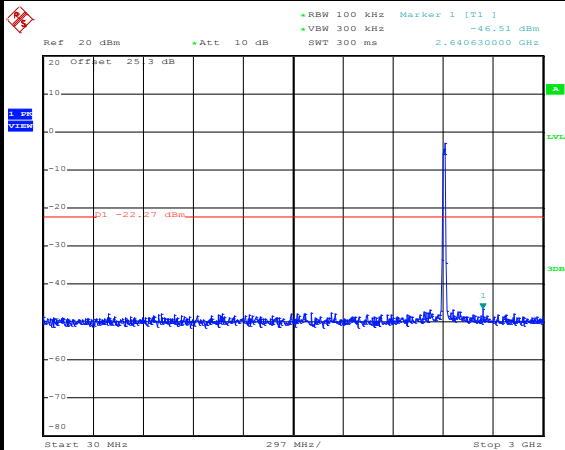

Date: 24.JUL.2015 19:48:08

Spurious Emission 2GHz~25GHz

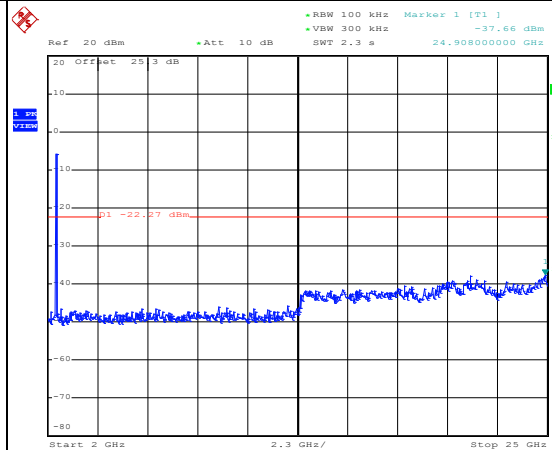

Date: 24.JUL.2015 19:48:25



Number of TX :	2	Ant. :	1
Test Mode :	802.11n HT20 (20MHz)	Temperature :	24~26°C
Test Band :	2.4GHz Mid	Relative Humidity :	45~49%
Test Channel :	06	Test Engineer :	Bill Kuo

WLAN 802.11n HT20 (20MHz) Channel 06

100kHz PSD reference Level

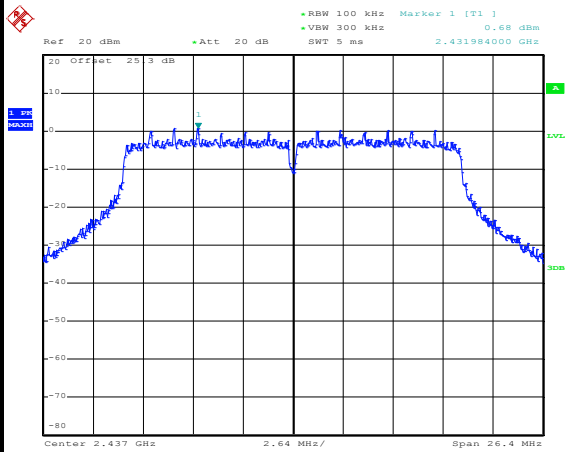

Date: 24.JUL.2015 01:52:46

Spurious Emission 30MHz~3GHz

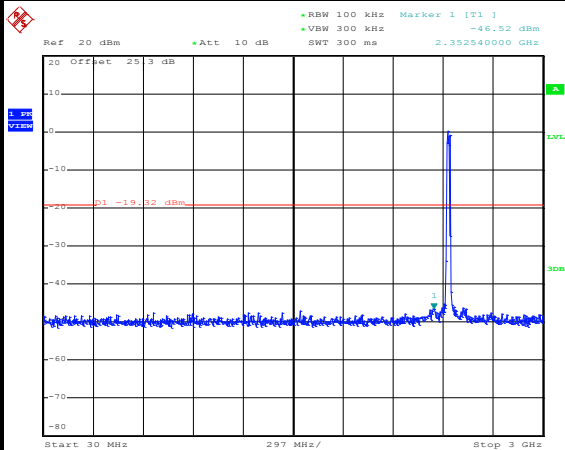

Date: 24.JUL.2015 01:53:16

Spurious Emission 2GHz~25GHz

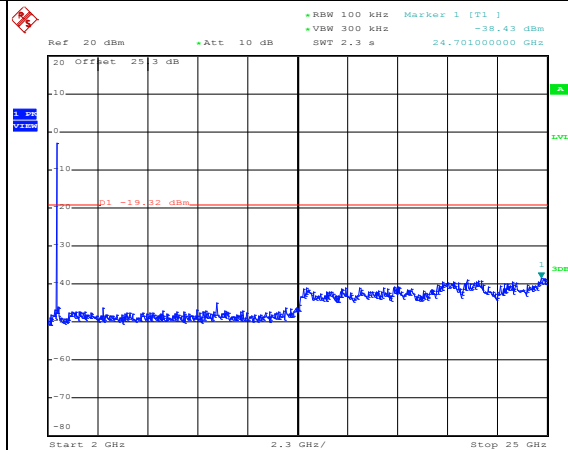

Date: 24.JUL.2015 01:53:34



Number of TX :	2	Ant. :	1
Test Mode :	802.11n HT20 (20MHz)	Temperature :	24~26°C
Test Band :	2.4GHz High	Relative Humidity :	45~49%
Test Channel :	11	Test Engineer :	Bill Kuo

WLAN 802.11n HT20 (20MHz) Channel 11

100kHz PSD reference Level

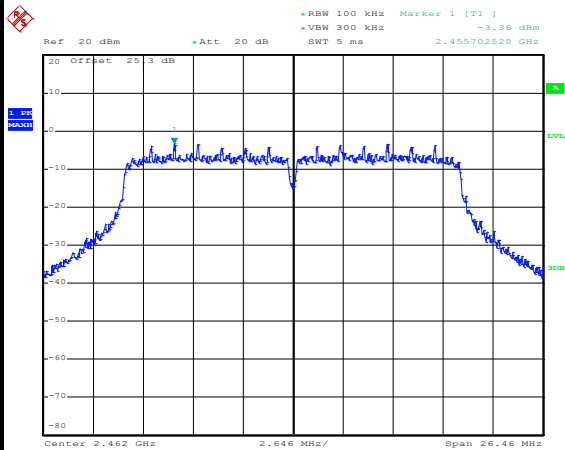

Date: 24.JUL.2015 01:49:13

High Channel Plot

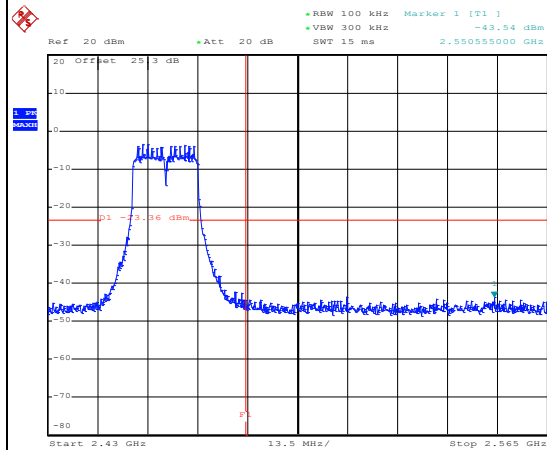

Date: 24.JUL.2015 01:49:29

Spurious Emission 30MHz~3GHz

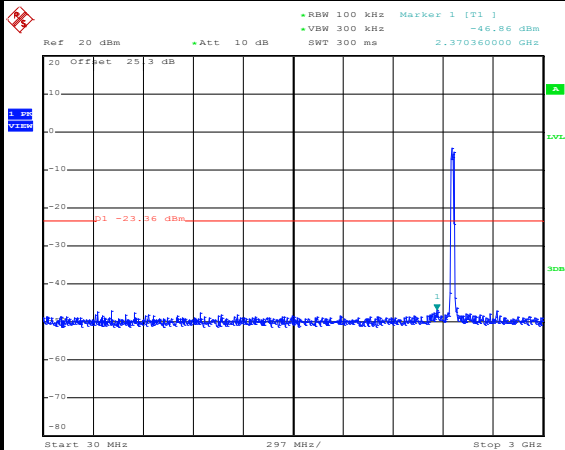

Date: 24.JUL.2015 01:49:50

Spurious Emission 2GHz~25GHz

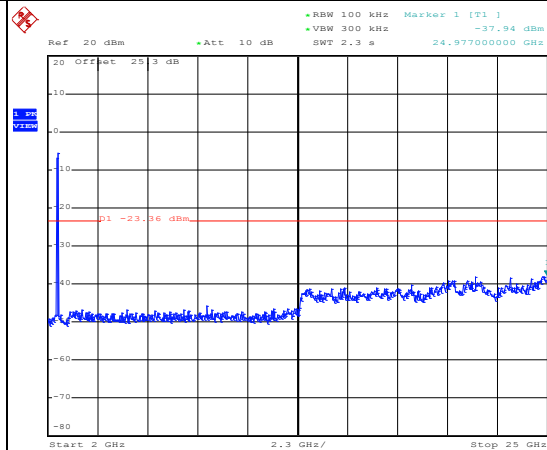

Date: 24.JUL.2015 01:50:08



Number of TX :	2	Ant. :	1
Test Mode :	802.11n HT20 (30MHz)	Temperature :	24~26°C
Test Band :	2.4GHz Low	Relative Humidity :	45~49%
Test Channel :	02	Test Engineer :	Bill Kuo

WLAN 802.11n HT20 (30MHz) Channel 02

100kHz PSD reference Level

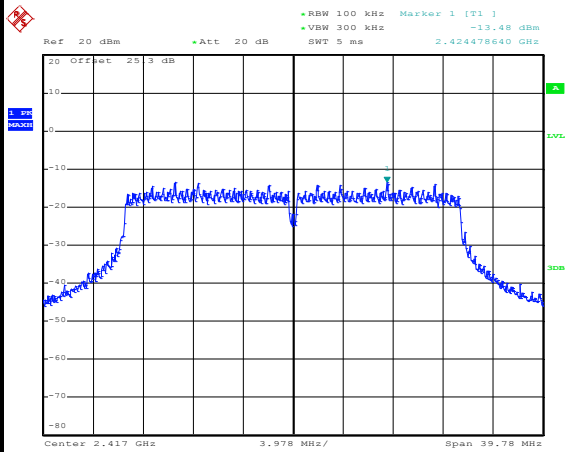

Date: 24.JUL.2015 20:03:00

Low Channel Plot

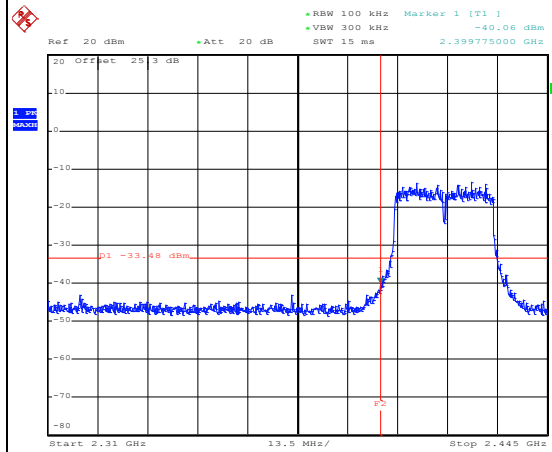

Date: 24.JUL.2015 20:03:20

Spurious Emission 30MHz~3GHz

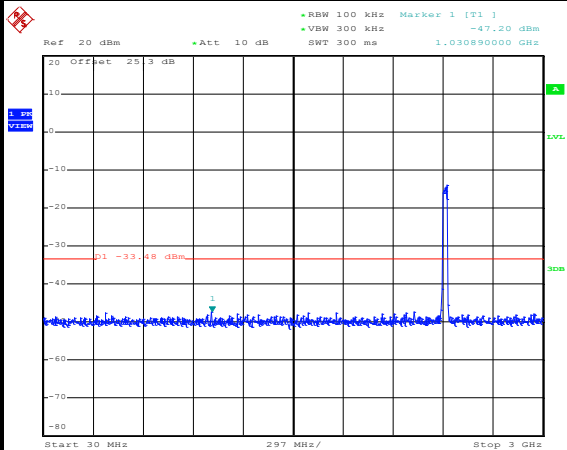

Date: 24.JUL.2015 20:03:44

Spurious Emission 2GHz~25GHz

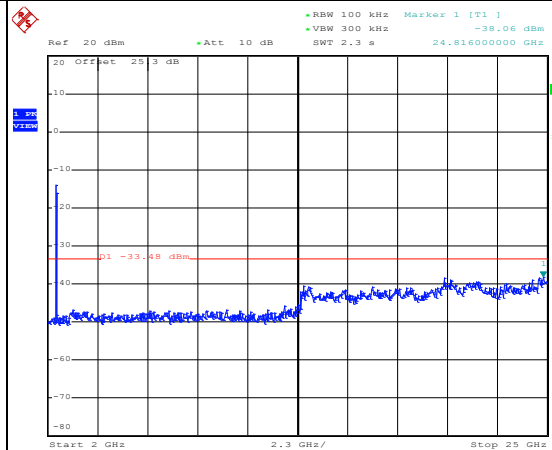

Date: 24.JUL.2015 20:04:02



Number of TX :	2	Ant. :	1
Test Mode :	802.11n HT20 (30MHz)	Temperature :	24~26°C
Test Band :	2.4GHz Mid	Relative Humidity :	45~49%
Test Channel :	06	Test Engineer :	Bill Kuo

WLAN 802.11n HT20 (30MHz) Channel 06

100kHz PSD reference Level

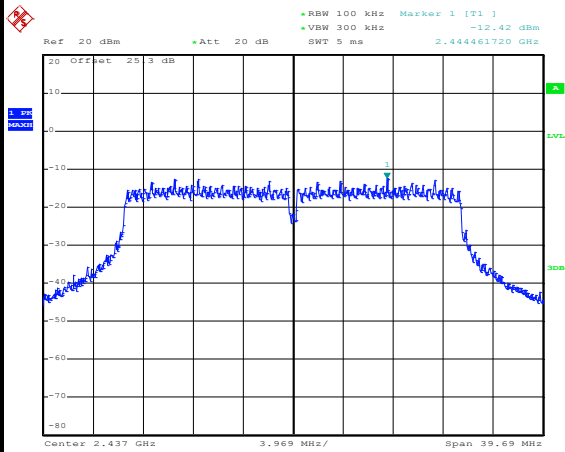

Date: 24.JUL.2015 20:07:18

Spurious Emission 30MHz~3GHz

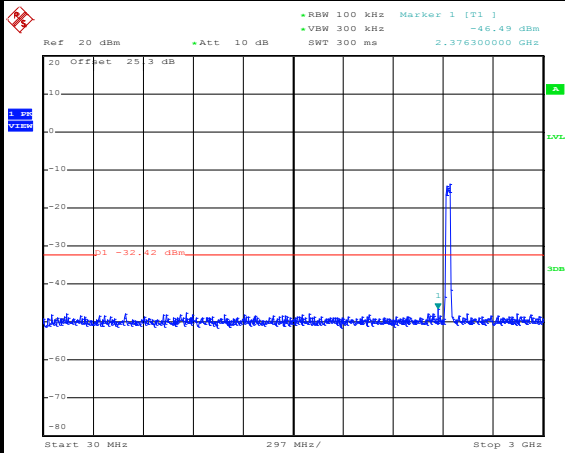

Date: 24.JUL.2015 20:07:41

Spurious Emission 2GHz~25GHz

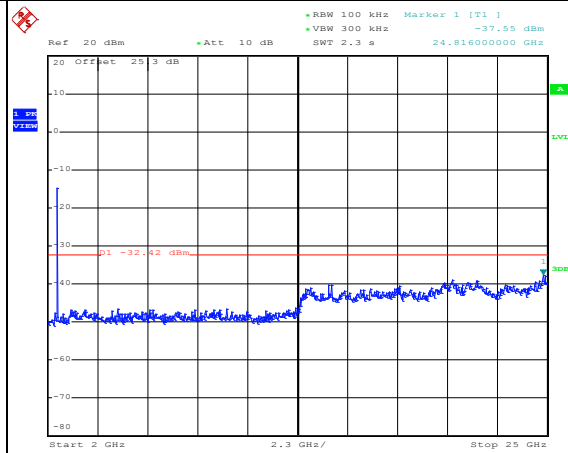

Date: 24.JUL.2015 20:07:58



Number of TX :	2	Ant. :	1
Test Mode :	802.11n HT20 (30MHz)	Temperature :	24~26°C
Test Band :	2.4GHz High	Relative Humidity :	45~49%
Test Channel :	10	Test Engineer :	Bill Kuo

WLAN 802.11n HT20 (30MHz) Channel 10

100kHz PSD reference Level

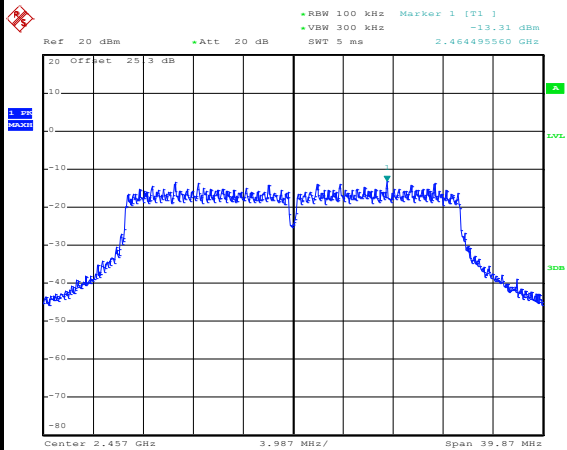

Date: 24.JUL.2015 22:51:27

High Channel Plot

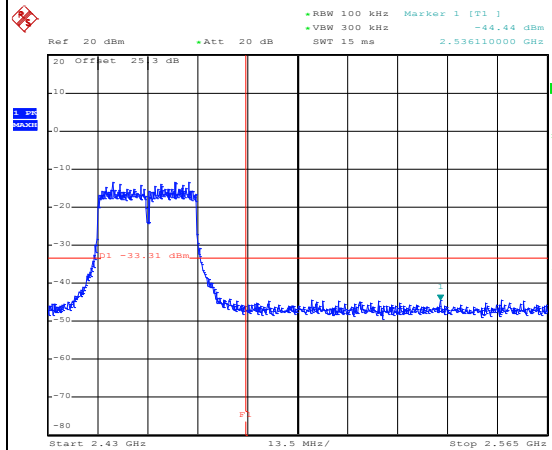

Date: 24.JUL.2015 22:51:49

Spurious Emission 30MHz~3GHz

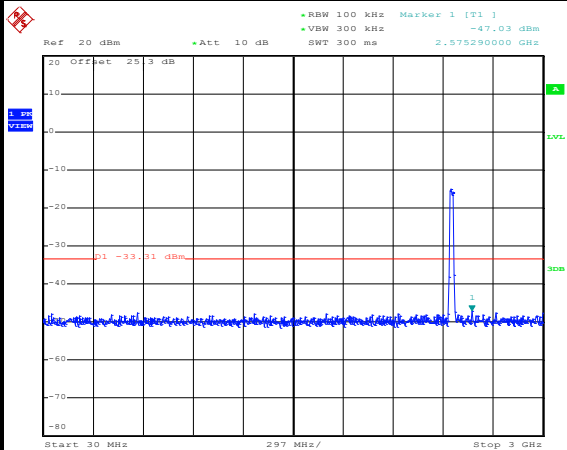

Date: 24.JUL.2015 22:52:13

Spurious Emission 2GHz~25GHz

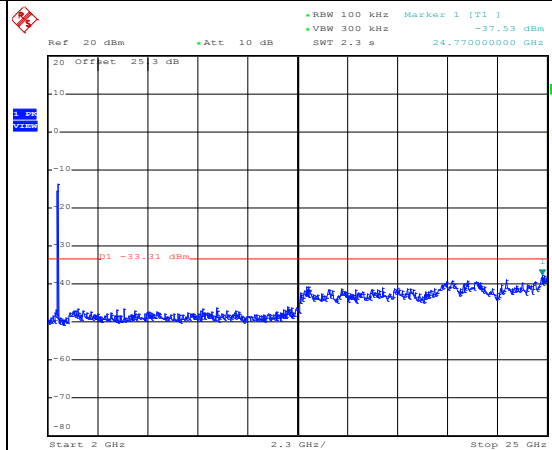

Date: 24.JUL.2015 22:52:31



Number of TX :	2	Ant. :	1
Test Mode :	802.11n HT40	Temperature :	24~26°C
Test Band :	2.4GHz Low	Relative Humidity :	45~49%
Test Channel :	03	Test Engineer :	Bill Kuo

WLAN 802.11n HT40 Channel 03

100kHz PSD reference Level

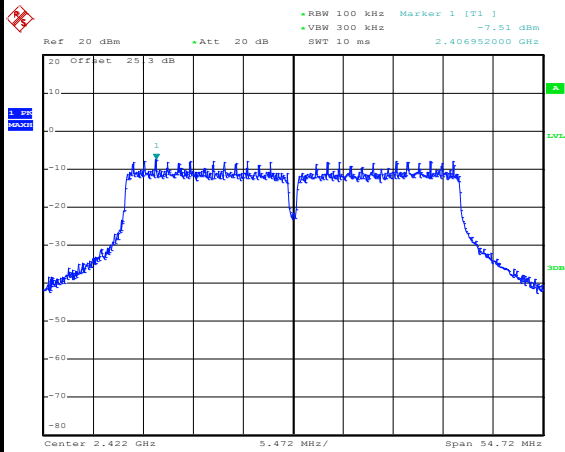

Date: 24.JUL.2015 20:24:56

Low Channel Plot

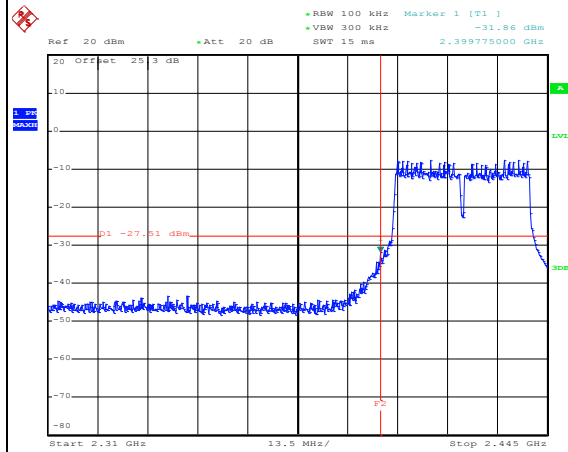

Date: 24.JUL.2015 20:25:14

Spurious Emission 30MHz~3GHz

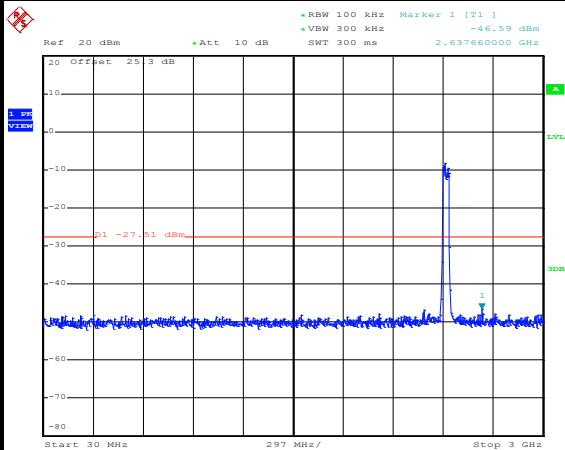

Date: 24.JUL.2015 20:26:30

Spurious Emission 2GHz~25GHz

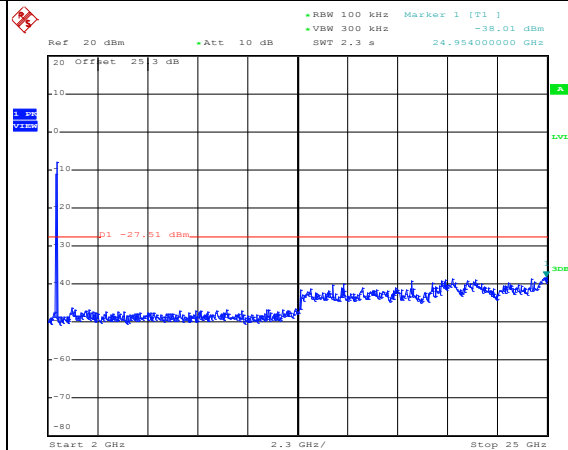

Date: 24.JUL.2015 20:25:54



Number of TX :	2	Ant. :	1
Test Mode :	802.11n HT40	Temperature :	24~26°C
Test Band :	2.4GHz Mid	Relative Humidity :	45~49%
Test Channel :	06	Test Engineer :	Bill Kuo

WLAN 802.11n HT40 Channel 06

100kHz PSD reference Level

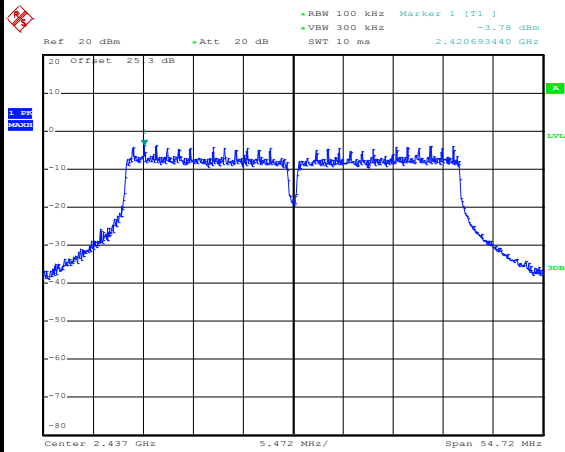

Date: 24.JUL.2015 23:55:54

Spurious Emission 30MHz~3GHz

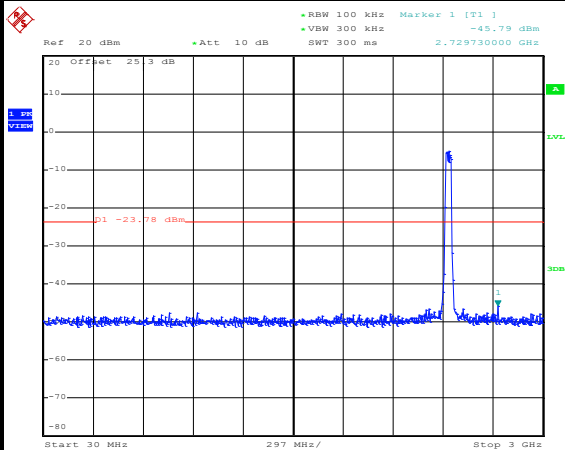

Date: 24.JUL.2015 23:56:16

Spurious Emission 2GHz~25GHz

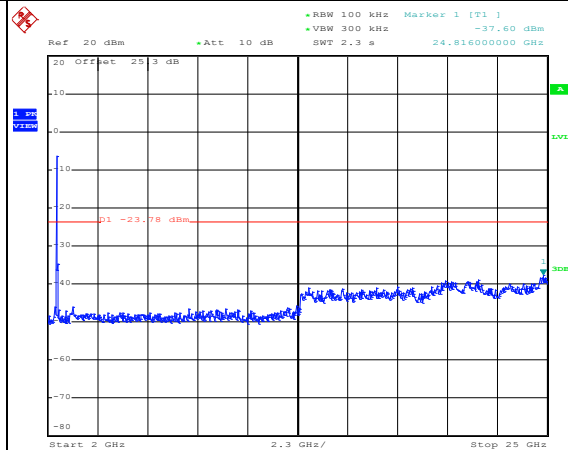

Date: 24.JUL.2015 23:56:34



Number of TX :	2	Ant. :	1
Test Mode :	802.11n HT40	Temperature :	24~26°C
Test Band :	2.4GHz High	Relative Humidity :	45~49%
Test Channel :	09	Test Engineer :	Bill Kuo

WLAN 802.11n HT40 Channel 09

100kHz PSD reference Level

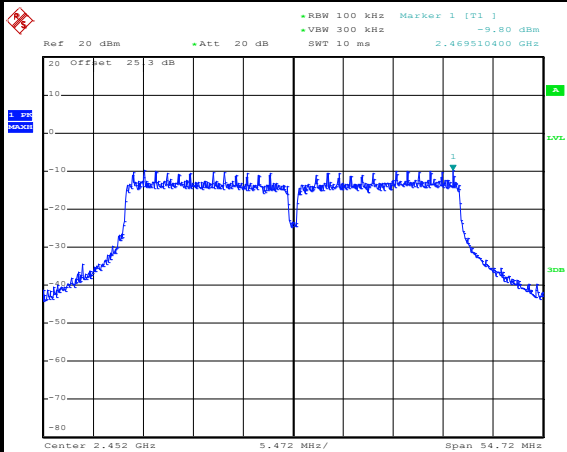

Date: 24.JUL.2015 20:55:33

High Channel Plot

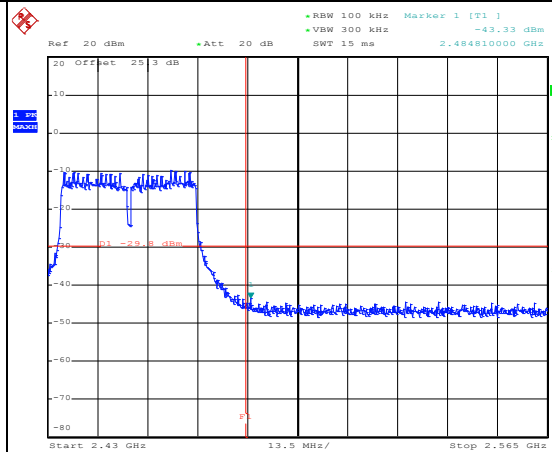

Date: 24.JUL.2015 20:55:49

Spurious Emission 30MHz~3GHz

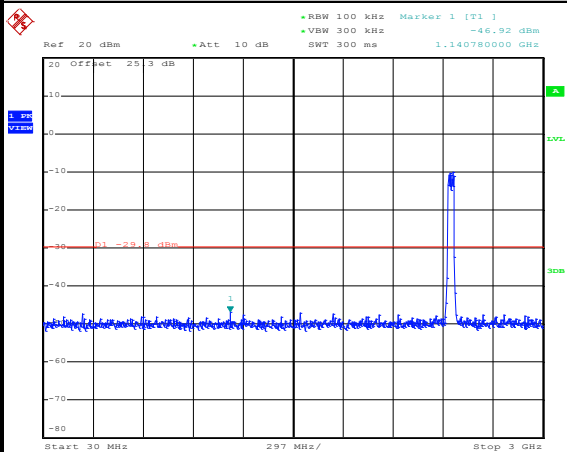

Date: 24.JUL.2015 20:57:08

Spurious Emission 2GHz~25GHz

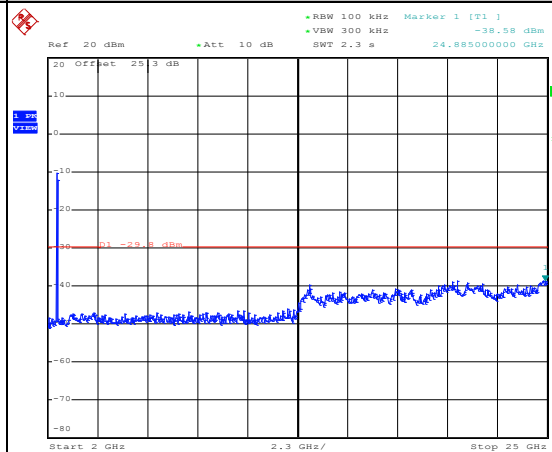

Date: 24.JUL.2015 20:56:28



Number of TX = 2, Ant. 2 (Measured)

Number of TX :	2	Ant. :	2
Test Mode :	802.11g (5MHz)	Temperature :	24~26°C
Test Band :	2.4GHz Low	Relative Humidity :	45~49%
Test Channel :	01	Test Engineer :	Bill Kuo

WLAN 802.11g (5MHz) Channel 01

100kHz PSD reference Level

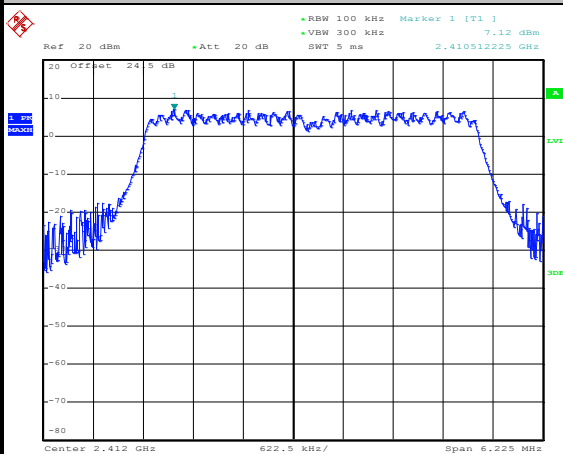

Date: 23.JUL.2015 22:17:35

Low Channel Plot

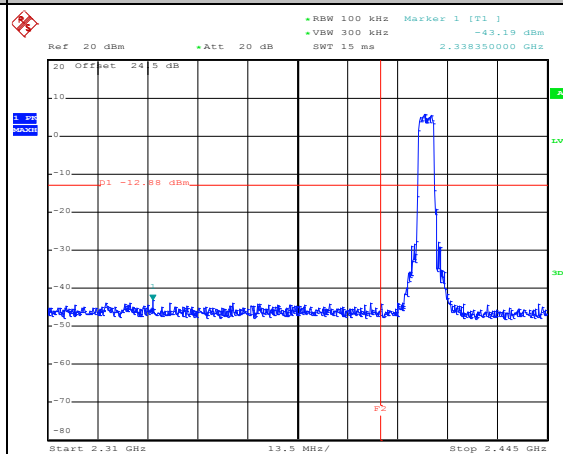

Date: 23.JUL.2015 22:18:26

Spurious Emission 30MHz~3GHz

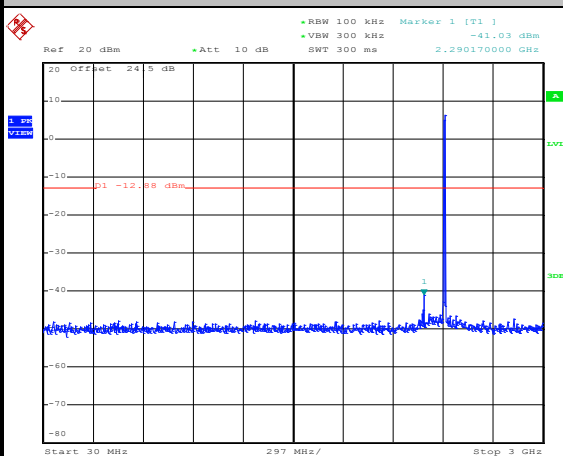

Date: 23.JUL.2015 22:19:22

Spurious Emission 2GHz~25GHz

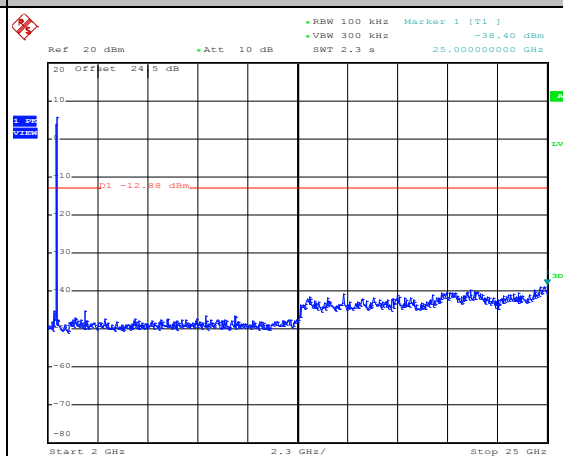

Date: 23.JUL.2015 22:19:40



Number of TX :	2	Ant. :	1
Test Mode :	802.11g (5MHz)	Temperature :	24~26°C
Test Band :	2.4GHz Mid	Relative Humidity :	45~49%
Test Channel :	06	Test Engineer :	Bill Kuo

WLAN 802.11g (5MHz) Channel 01

100kHz PSD reference Level

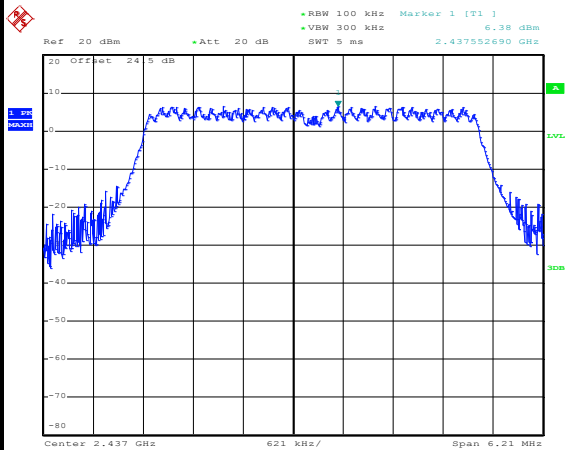

Date: 23.JUL.2015 22:10:18

Spurious Emission 30MHz~3GHz

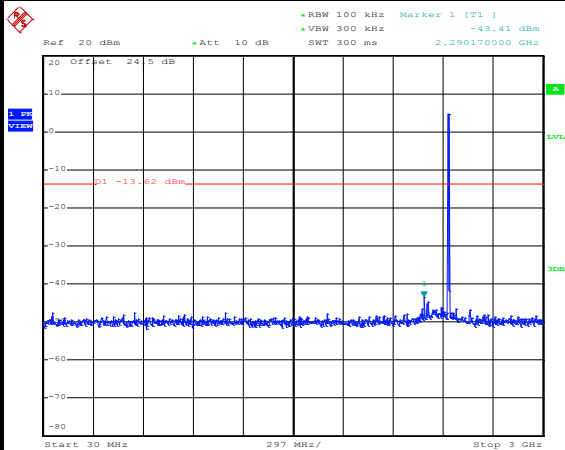

Date: 23.JUL.2015 22:10:43

Spurious Emission 2GHz~25GHz

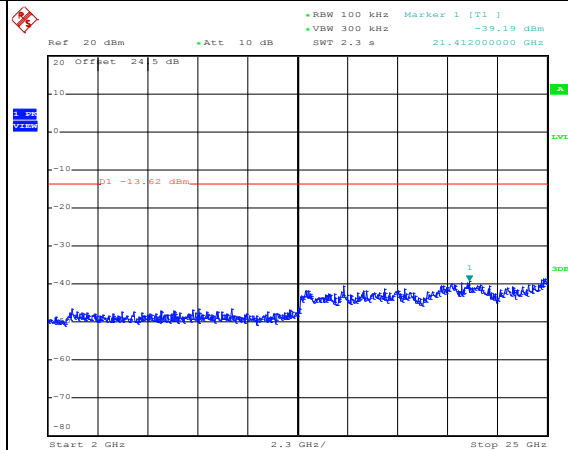

Date: 23.JUL.2015 22:11:01



Number of TX :	2	Ant. :	1
Test Mode :	802.11g (5MHz)	Temperature :	24~26°C
Test Band :	2.4GHz High	Relative Humidity :	45~49%
Test Channel :	11	Test Engineer :	Bill Kuo

WLAN 802.11g (5MHz) Channel 11

100kHz PSD reference Level

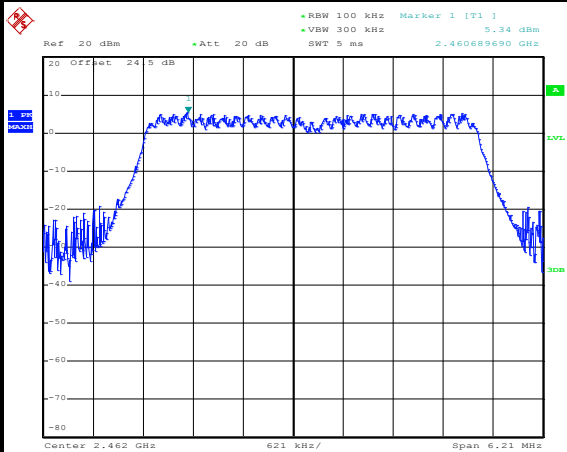

Date: 23.JUL.2015 22:24:34

High Channel Plot

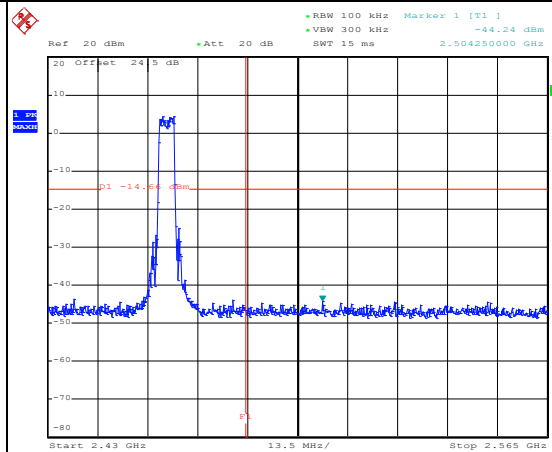

Date: 23.JUL.2015 22:25:23

Spurious Emission 30MHz~3GHz

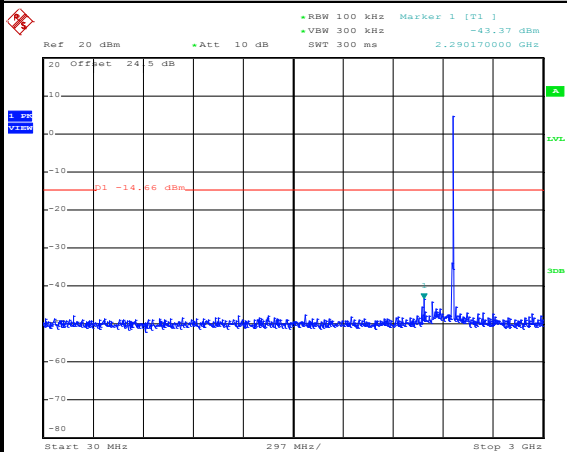

Date: 23.JUL.2015 22:26:06

Spurious Emission 2GHz~25GHz

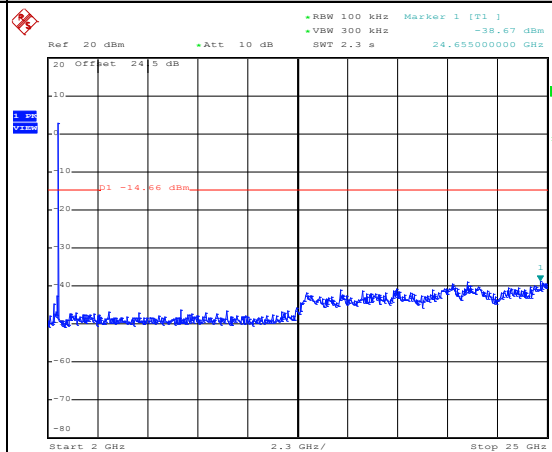

Date: 23.JUL.2015 22:26:24



Number of TX :	2	Ant. :	1
Test Mode :	802.11g (8MHz)	Temperature :	24~26°C
Test Band :	2.4GHz Low	Relative Humidity :	45~49%
Test Channel :	01	Test Engineer :	Bill Kuo

WLAN 802.11g (8MHz) Channel 01

100kHz PSD reference Level

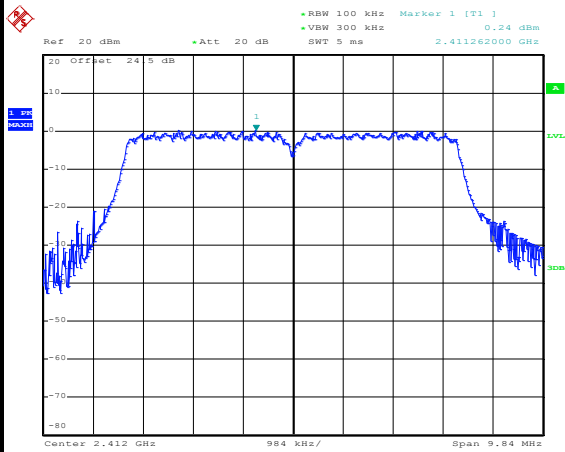

Date: 23.JUL.2015 22:42:08

Low Channel Plot

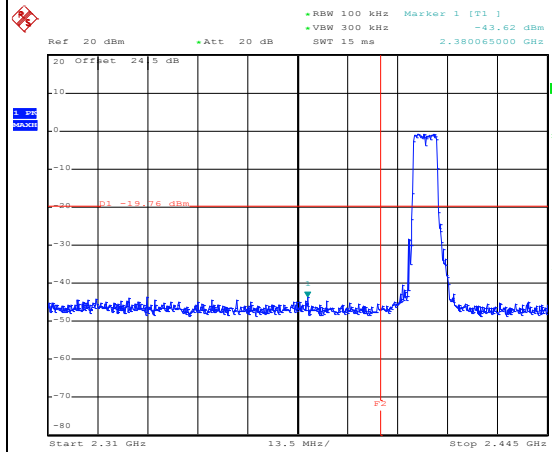

Date: 23.JUL.2015 22:42:24

Spurious Emission 30MHz~3GHz

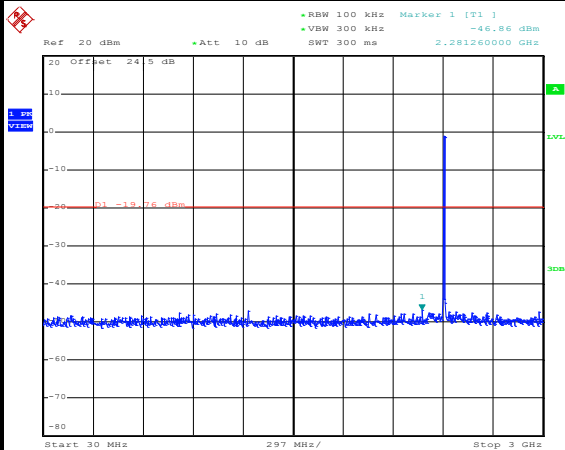

Date: 23.JUL.2015 22:42:46

Spurious Emission 2GHz~25GHz

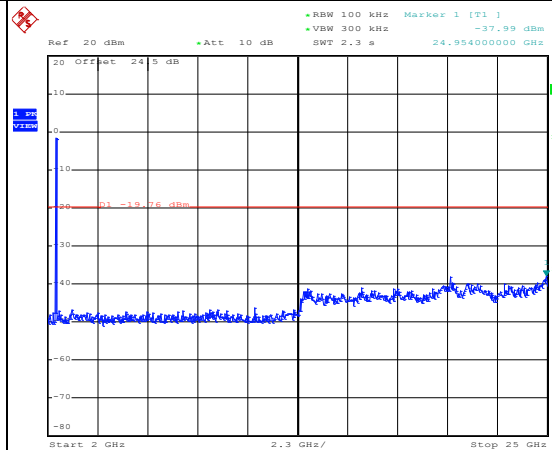

Date: 23.JUL.2015 22:43:04



Number of TX :	2	Ant. :	1
Test Mode :	802.11g (8MHz)	Temperature :	24~26°C
Test Band :	2.4GHz Mid	Relative Humidity :	45~49%
Test Channel :	06	Test Engineer :	Bill Kuo

WLAN 802.11g (8MHz) Channel 06

100kHz PSD reference Level

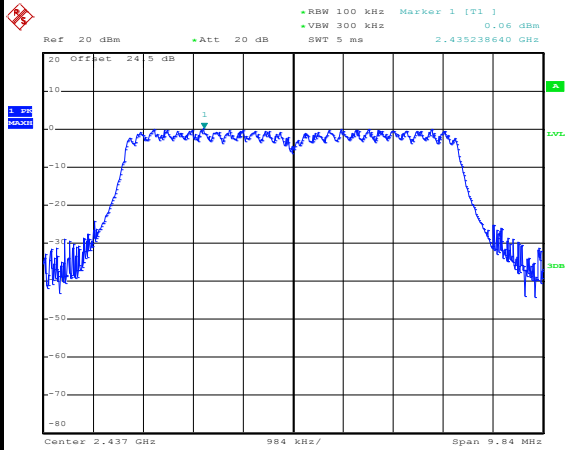

Date: 23.JUL.2015 22:54:43

Spurious Emission 30MHz~3GHz

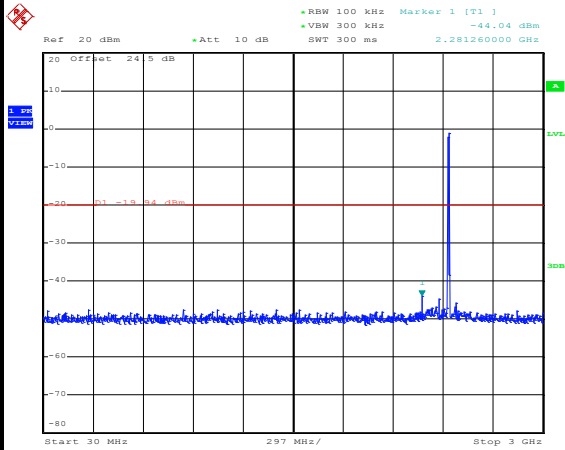

Date: 23.JUL.2015 22:55:30

Spurious Emission 2GHz~25GHz

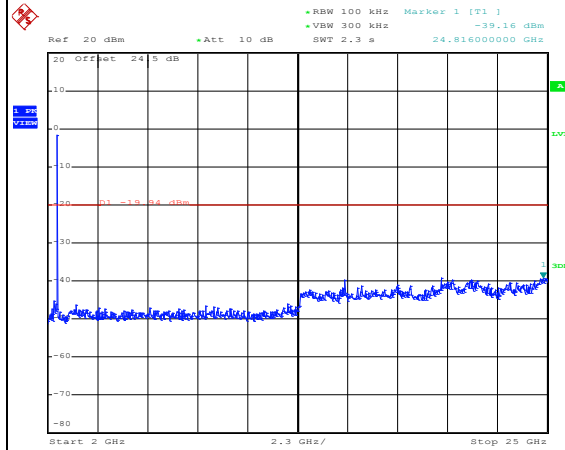

Date: 23.JUL.2015 22:55:48



Number of TX :	2	Ant. :	1
Test Mode :	802.11g (8MHz)	Temperature :	24~26°C
Test Band :	2.4GHz High	Relative Humidity :	45~49%
Test Channel :	11	Test Engineer :	Bill Kuo

WLAN 802.11g (8MHz) Channel 11

100kHz PSD reference Level

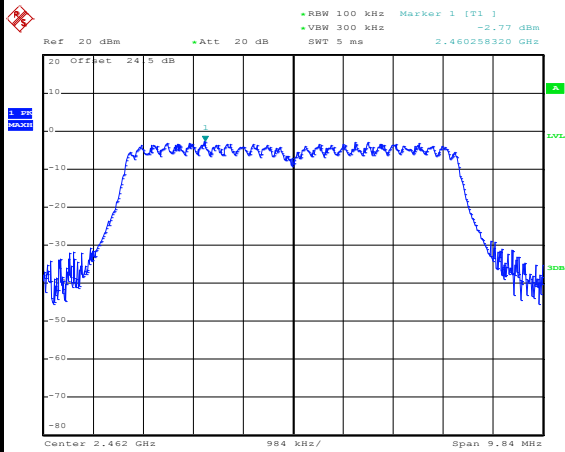

Date: 23.JUL.2015 23:00:43

High Channel Plot

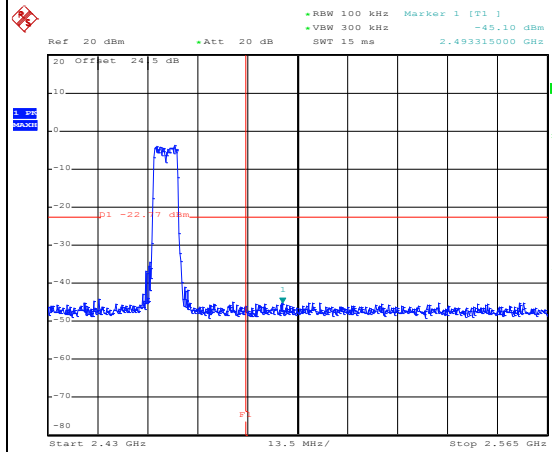

Date: 23.JUL.2015 23:00:59

Spurious Emission 30MHz~3GHz

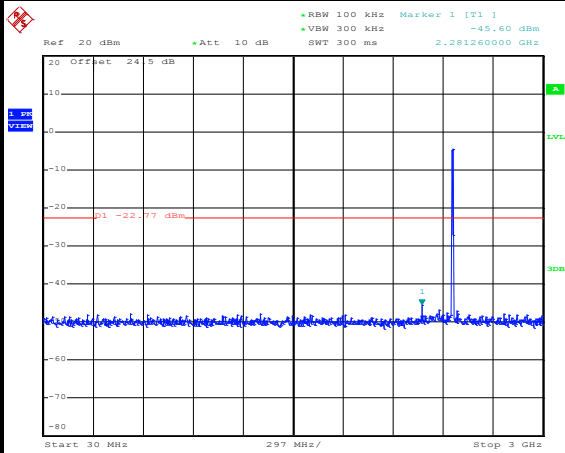

Date: 23.JUL.2015 23:01:23

Spurious Emission 2GHz~25GHz

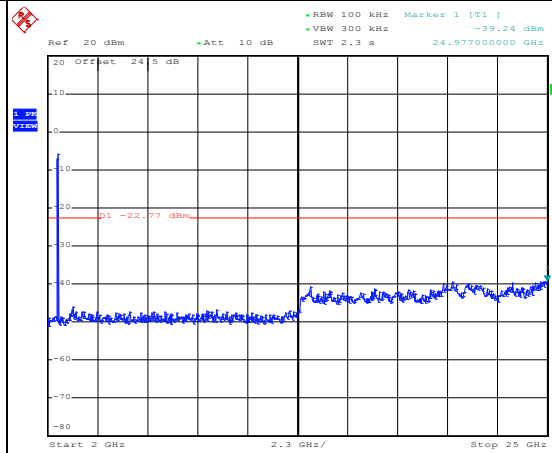

Date: 23.JUL.2015 23:01:41



Number of TX :	2	Ant. :	1
Test Mode :	802.11g (10MHz)	Temperature :	24~26°C
Test Band :	2.4GHz Low	Relative Humidity :	45~49%
Test Channel :	01	Test Engineer :	Bill Kuo

WLAN 802.11g (10MHz) Channel 01

100kHz PSD reference Level

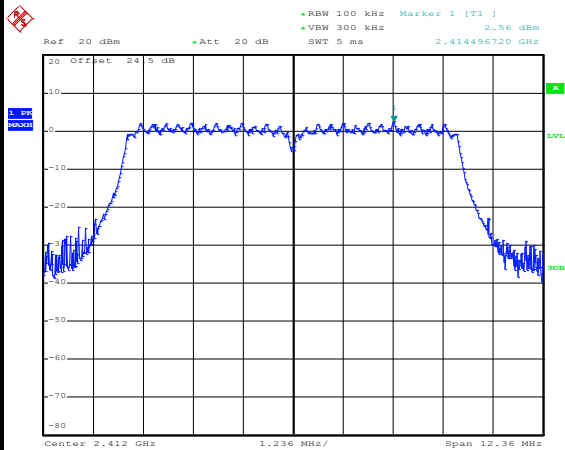

Date: 23.JUL.2015 23:21:38

Low Channel Plot

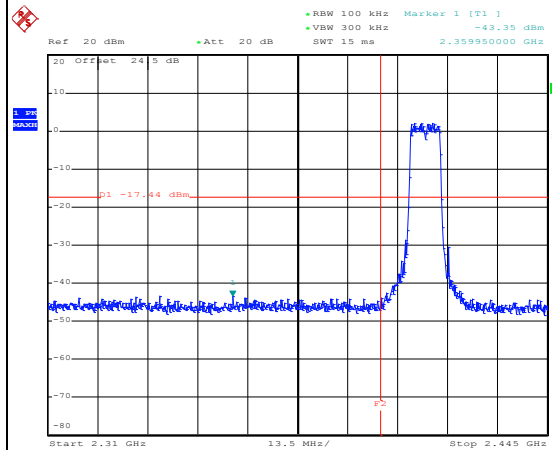

Date: 23.JUL.2015 23:22:01

Spurious Emission 30MHz~3GHz

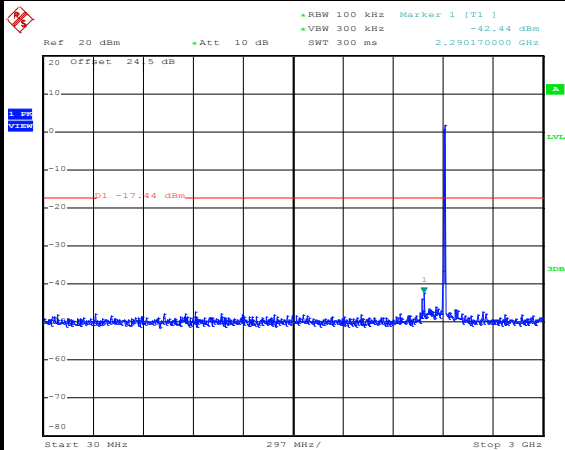

Date: 23.JUL.2015 23:22:23

Spurious Emission 2GHz~25GHz

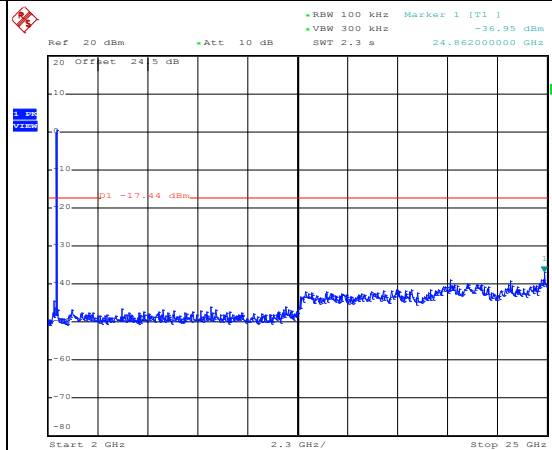

Date: 23.JUL.2015 23:22:41



Number of TX :	2	Ant. :	1
Test Mode :	802.11g (10MHz)	Temperature :	24~26°C
Test Band :	2.4GHz Mid	Relative Humidity :	45~49%
Test Channel :	06	Test Engineer :	Bill Kuo

WLAN 802.11g (10MHz) Channel 06

100kHz PSD reference Level

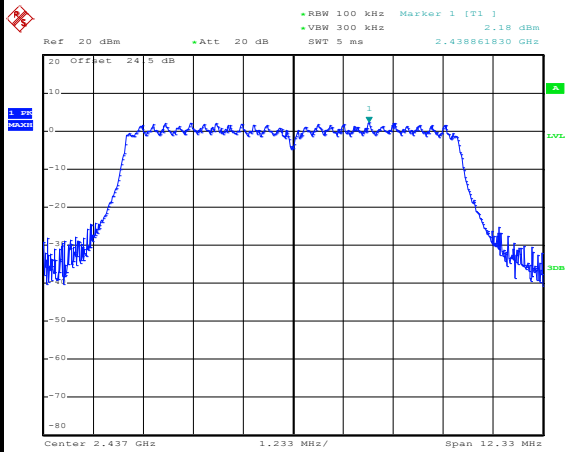

Date: 23.JUL.2015 23:35:05

Spurious Emission 30MHz~3GHz

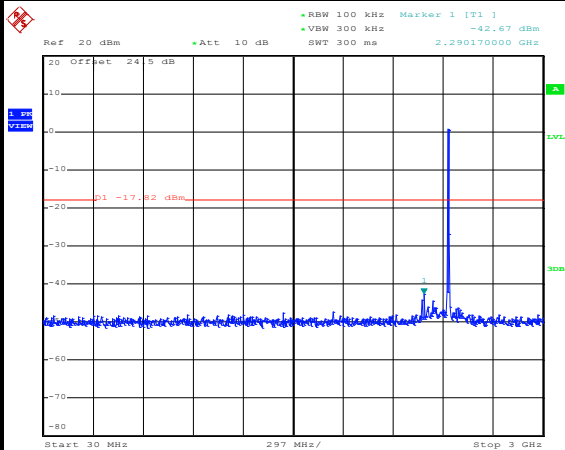

Date: 23.JUL.2015 23:35:26

Spurious Emission 2GHz~25GHz

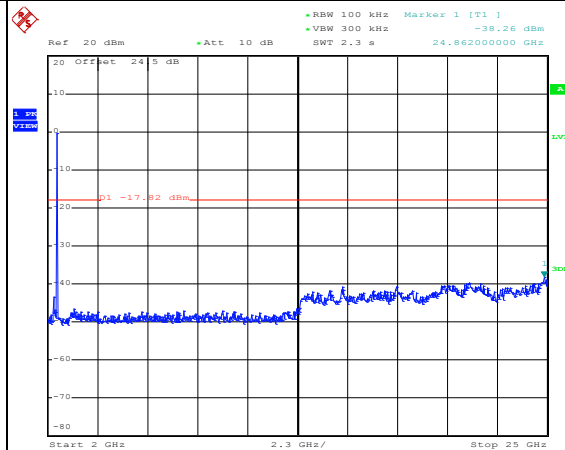

Date: 23.JUL.2015 23:35:44



Number of TX :	2	Ant. :	1
Test Mode :	802.11g (10MHz)	Temperature :	24~26°C
Test Band :	2.4GHz High	Relative Humidity :	45~49%
Test Channel :	11	Test Engineer :	Bill Kuo

WLAN 802.11g (10MHz) Channel 11

100kHz PSD reference Level

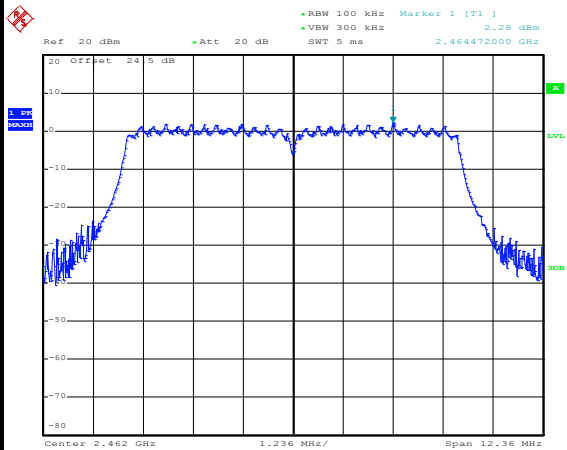

Date: 23.JUL.2015 23:39:32

High Channel Plot

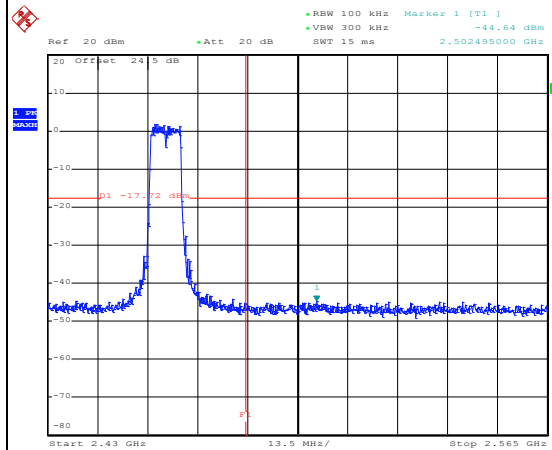

Date: 23.JUL.2015 23:39:53

Spurious Emission 30MHz~3GHz

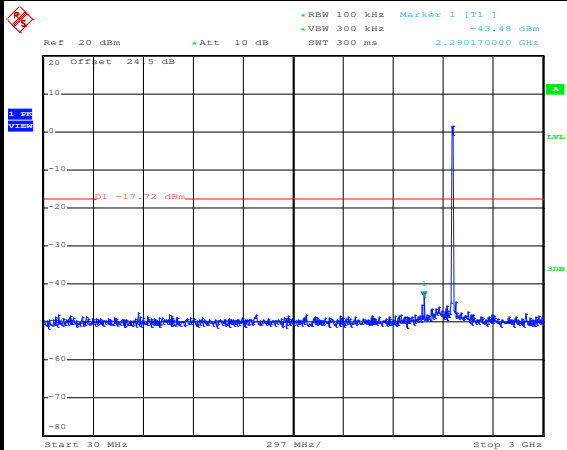

Date: 23.JUL.2015 23:40:14

Spurious Emission 2GHz~25GHz

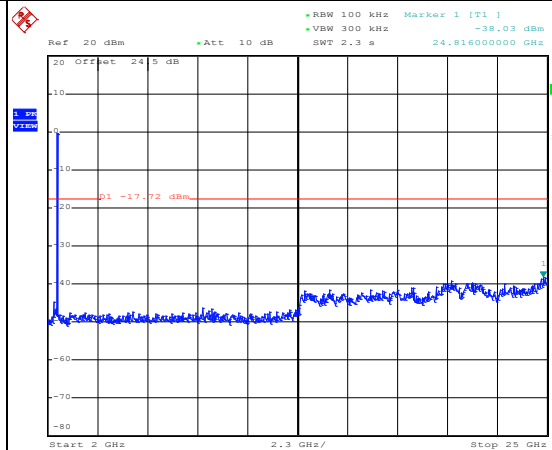

Date: 23.JUL.2015 23:40:32



Number of TX :	2	Ant. :	1
Test Mode :	802.11g (20MHz)	Temperature :	24~26°C
Test Band :	2.4GHz Low	Relative Humidity :	45~49%
Test Channel :	01	Test Engineer :	Bill Kuo

WLAN 802.11g (20MHz) Channel 01

100kHz PSD reference Level

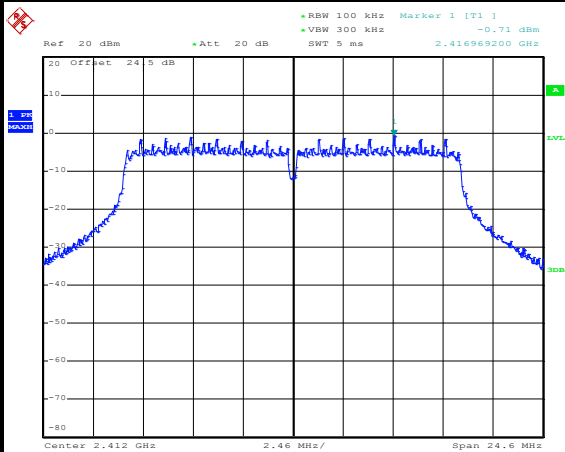

Date: 24.JUL.2015 00:01:03

Low Channel Plot

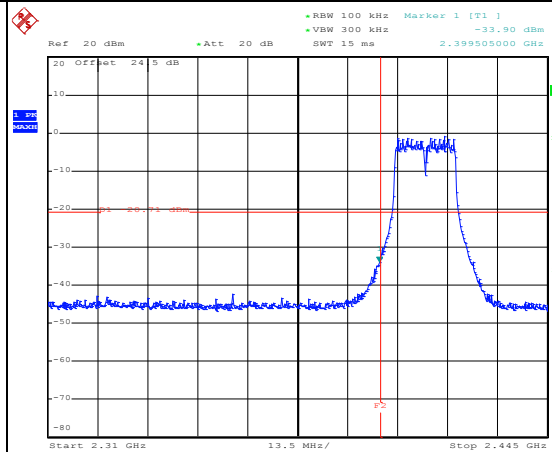

Date: 24.JUL.2015 00:03:47

Spurious Emission 30MHz~3GHz

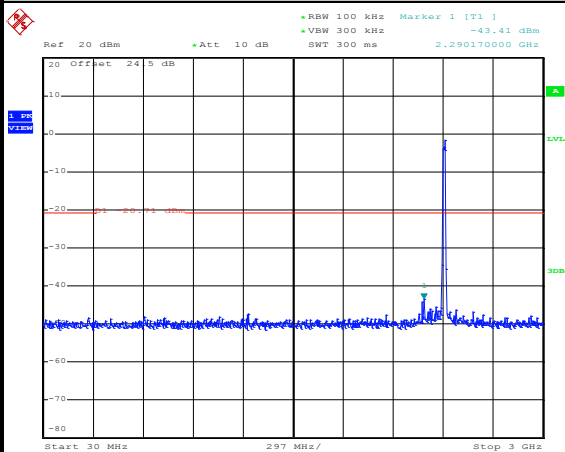

Date: 24.JUL.2015 00:04:16

Spurious Emission 2GHz~25GHz

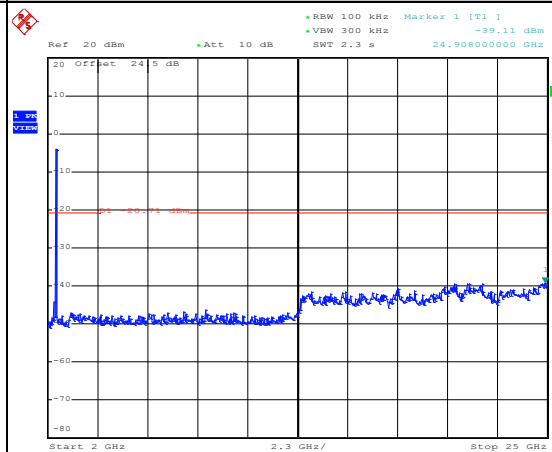

Date: 24.JUL.2015 00:04:33



Number of TX :	2	Ant. :	1
Test Mode :	802.11g (20MHz)	Temperature :	24~26°C
Test Band :	2.4GHz Mid	Relative Humidity :	45~49%
Test Channel :	06	Test Engineer :	Bill Kuo

WLAN 802.11g (20MHz) Channel 06

100kHz PSD reference Level

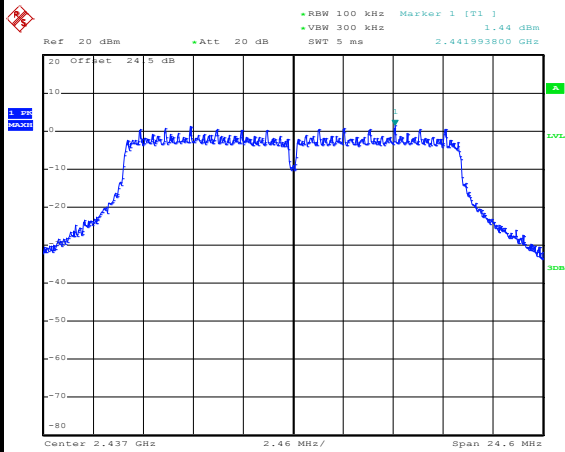

Date: 24.JUL.2015 00:07:26

Spurious Emission 30MHz~3GHz

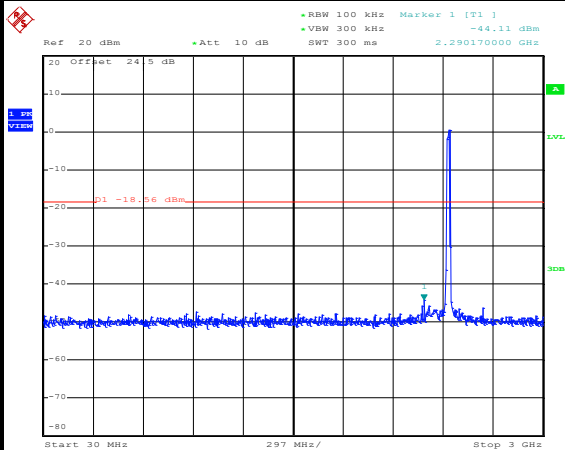

Date: 24.JUL.2015 00:08:18

Spurious Emission 2GHz~25GHz

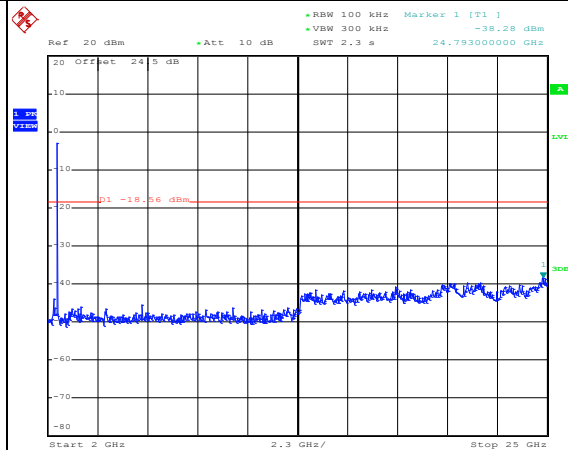

Date: 24.JUL.2015 00:08:36



Number of TX :	2	Ant. :	1
Test Mode :	802.11g (20MHz)	Temperature :	24~26°C
Test Band :	2.4GHz High	Relative Humidity :	45~49%
Test Channel :	11	Test Engineer :	Bill Kuo

WLAN 802.11g (20MHz) Channel 11

100kHz PSD reference Level

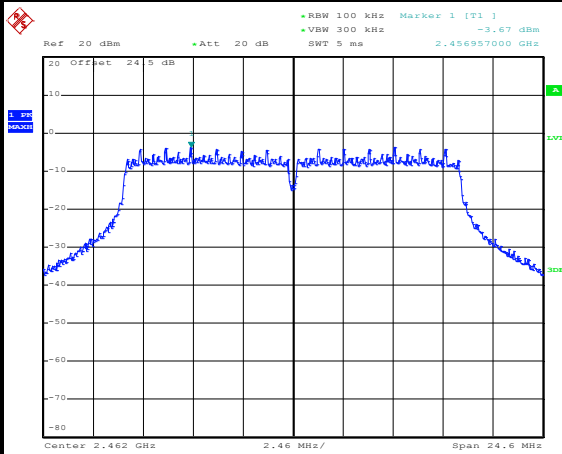

Date: 24.JUL.2015 00:17:04

High Channel Plot

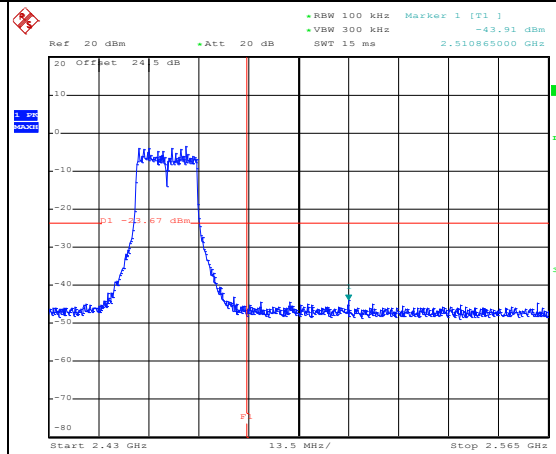

Date: 24.JUL.2015 00:18:17

Spurious Emission 30MHz~3GHz

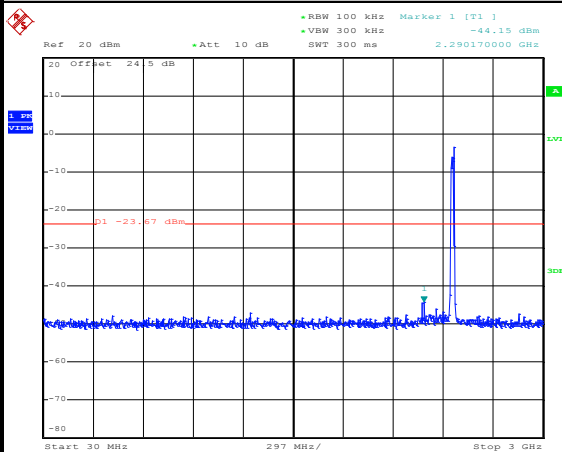

Date: 24.JUL.2015 00:17:26

Spurious Emission 2GHz~25GHz

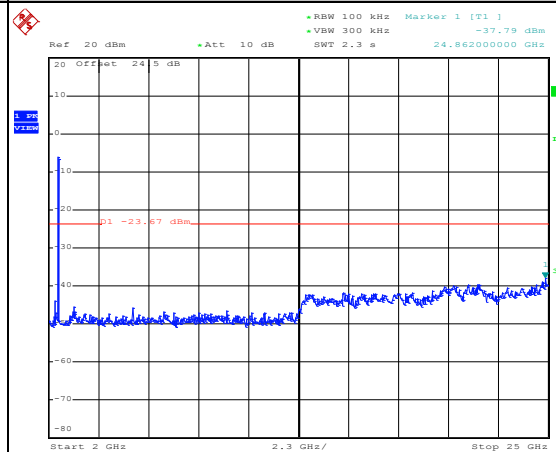

Date: 24.JUL.2015 00:17:46



Number of TX :	2	Ant. :	1
Test Mode :	802.11g (30MHz)	Temperature :	24~26°C
Test Band :	2.4GHz Low	Relative Humidity :	45~49%
Test Channel :	02	Test Engineer :	Bill Kuo

WLAN 802.11g (30MHz) Channel 02

100kHz PSD reference Level

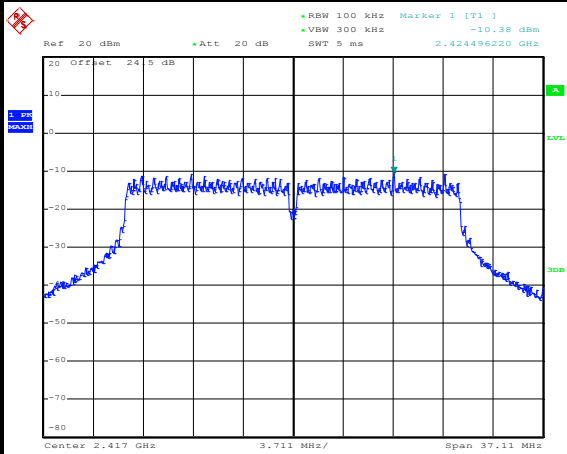

Date: 24.JUL.2015 21:04:48

Low Channel Plot

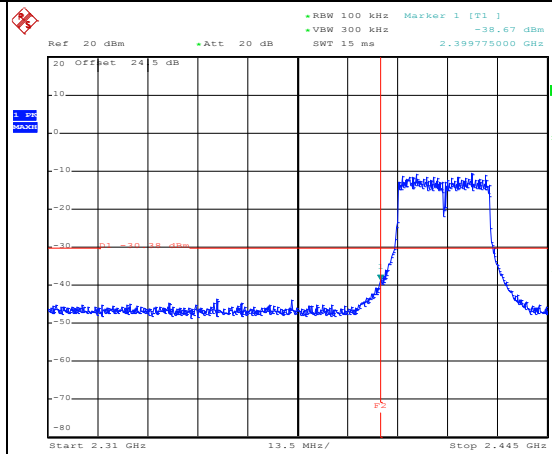

Date: 24.JUL.2015 21:06:10

Spurious Emission 30MHz~3GHz

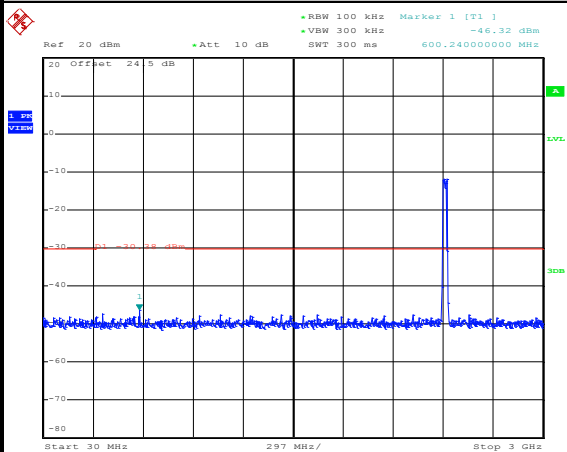

Date: 24.JUL.2015 21:06:42

Spurious Emission 2GHz~25GHz

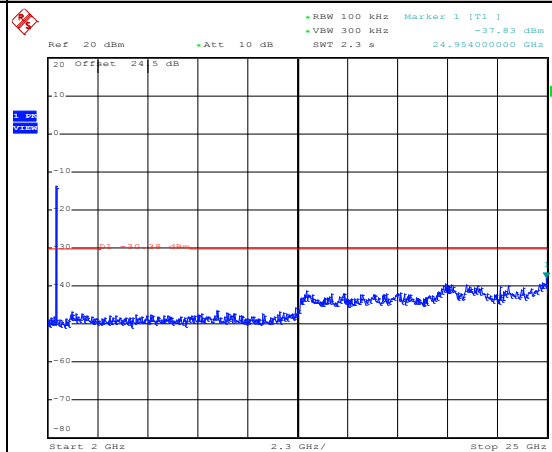

Date: 24.JUL.2015 21:07:00



Number of TX :	2	Ant. :	1
Test Mode :	802.11g (30MHz)	Temperature :	24~26°C
Test Band :	2.4GHz Mid	Relative Humidity :	45~49%
Test Channel :	06	Test Engineer :	Bill Kuo

WLAN 802.11g (30MHz) Channel 06

100kHz PSD reference Level

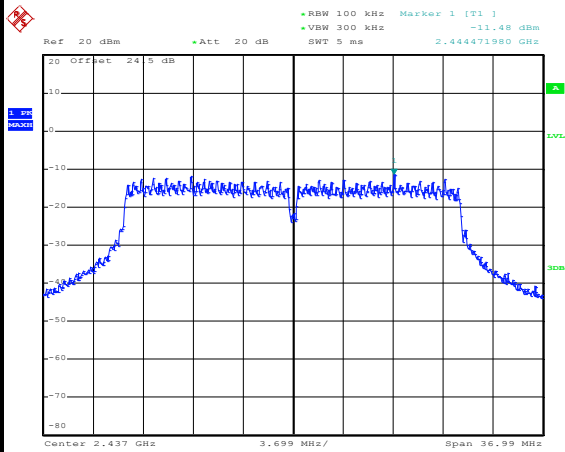

Date: 24.JUL.2015 00:24:45

Spurious Emission 30MHz~3GHz

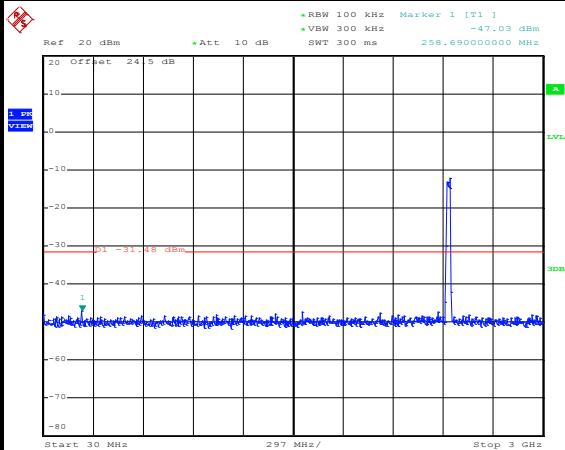

Date: 24.JUL.2015 00:25:06

Spurious Emission 2GHz~25GHz

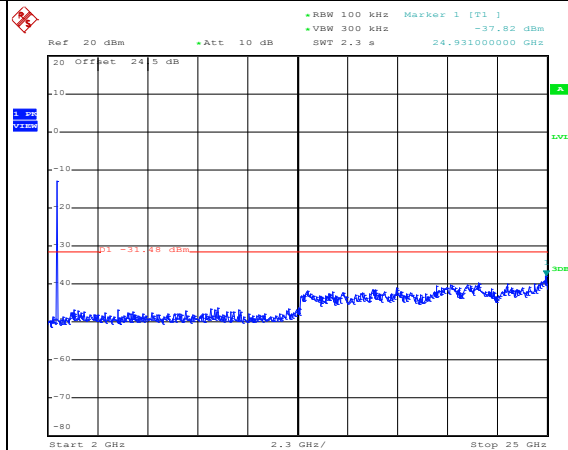

Date: 24.JUL.2015 00:25:24



Number of TX :	2	Ant. :	1
Test Mode :	802.11g (30MHz)	Temperature :	24~26°C
Test Band :	2.4GHz High	Relative Humidity :	45~49%
Test Channel :	10	Test Engineer :	Bill Kuo

WLAN 802.11g (30MHz) Channel 10

100kHz PSD reference Level

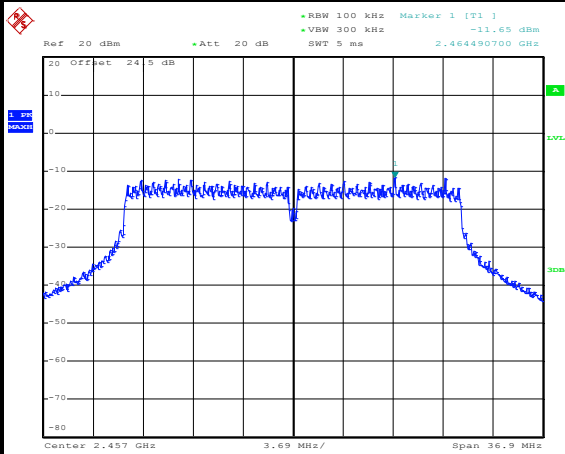

Date: 24.JUL.2015 21:25:57

High Channel Plot

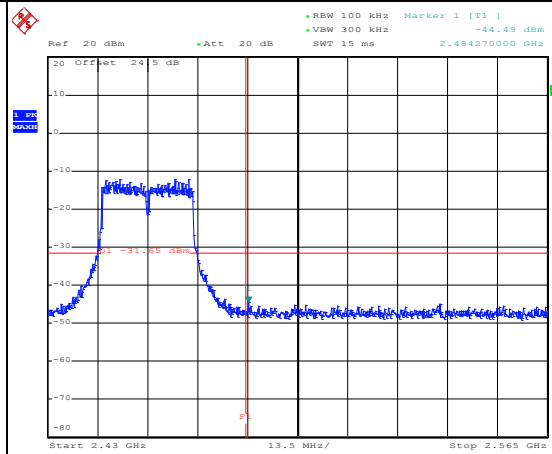

Date: 24.JUL.2015 21:26:17

Spurious Emission 30MHz~3GHz

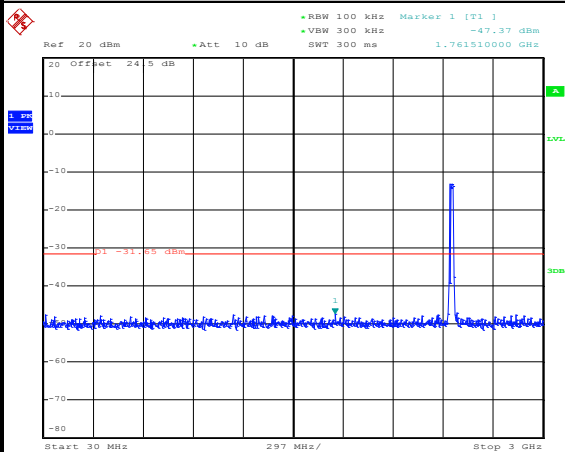

Date: 24.JUL.2015 21:26:39

Spurious Emission 2GHz~25GHz

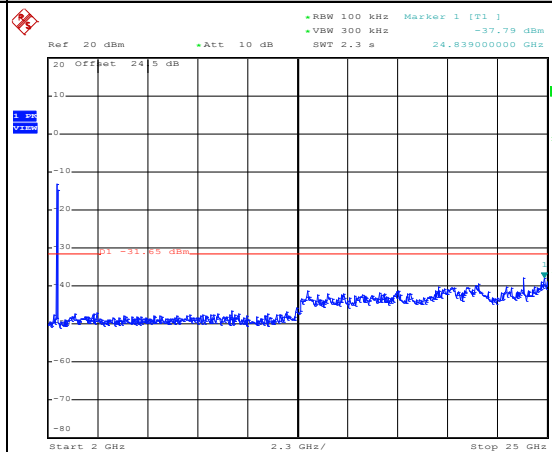

Date: 24.JUL.2015 21:26:57



Number of TX :	2	Ant. :	1
Test Mode :	802.11n HT20 (5MHz)	Temperature :	24~26°C
Test Band :	2.4GHz Low	Relative Humidity :	45~49%
Test Channel :	01	Test Engineer :	Bill Kuo

WLAN 802.11n HT20 (5MHz) Channel 01

100kHz PSD reference Level

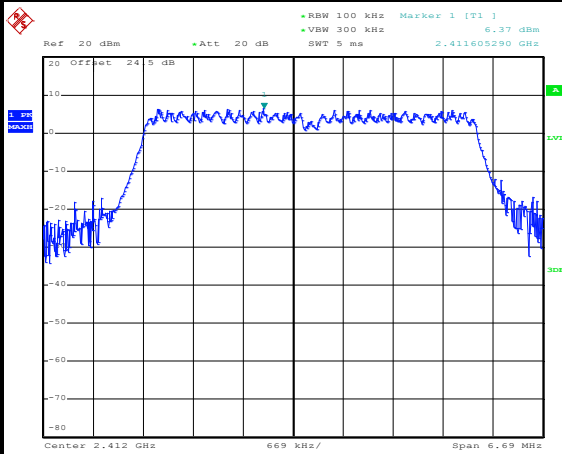

Date: 24.JUL.2015 00:36:23

Low Channel Plot

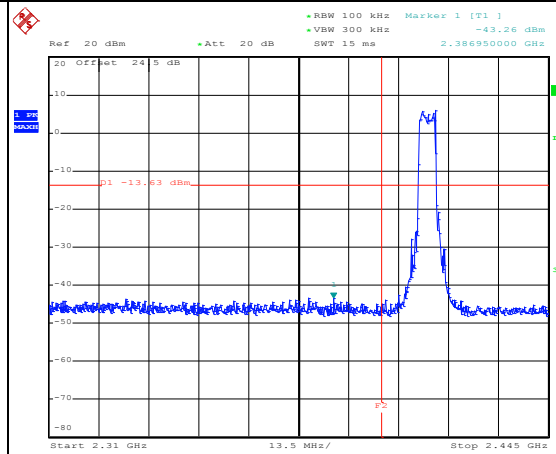

Date: 24.JUL.2015 00:37:06

Spurious Emission 30MHz~3GHz

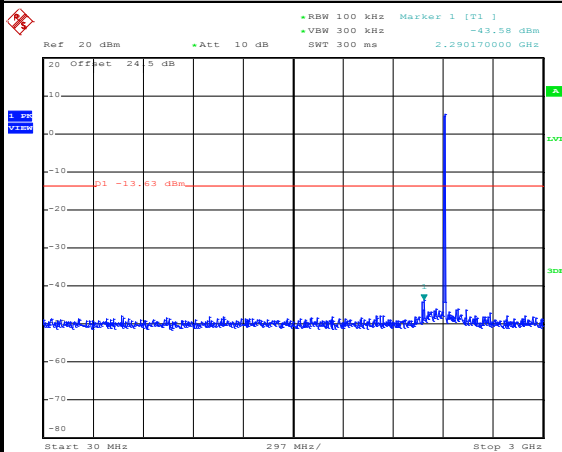

Date: 24.JUL.2015 00:37:30

Spurious Emission 2GHz~25GHz

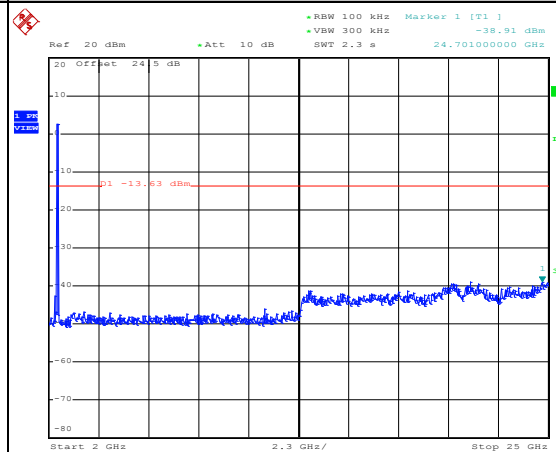

Date: 24.JUL.2015 00:37:48



Number of TX :	2	Ant. :	1
Test Mode :	802.11n HT20 (5MHz)	Temperature :	24~26°C
Test Band :	2.4GHz Mid	Relative Humidity :	45~49%
Test Channel :	06	Test Engineer :	Bill Kuo

WLAN 802.11n HT20 (5MHz) Channel 06

100kHz PSD reference Level

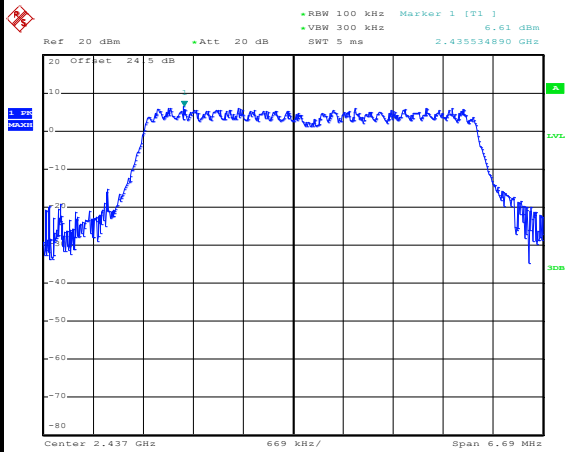

Date: 24.JUL.2015 00:40:33

Spurious Emission 30MHz~3GHz

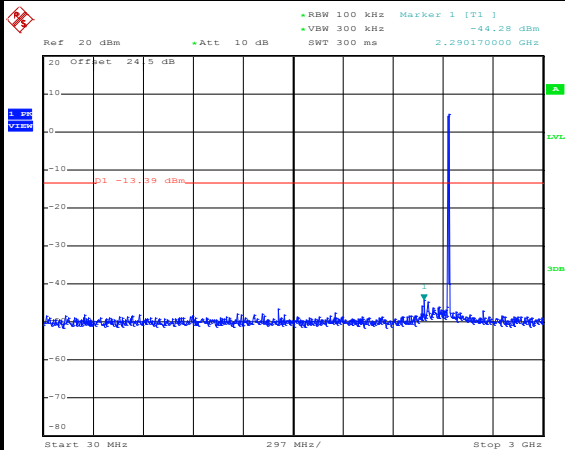

Date: 24.JUL.2015 00:40:54

Spurious Emission 2GHz~25GHz

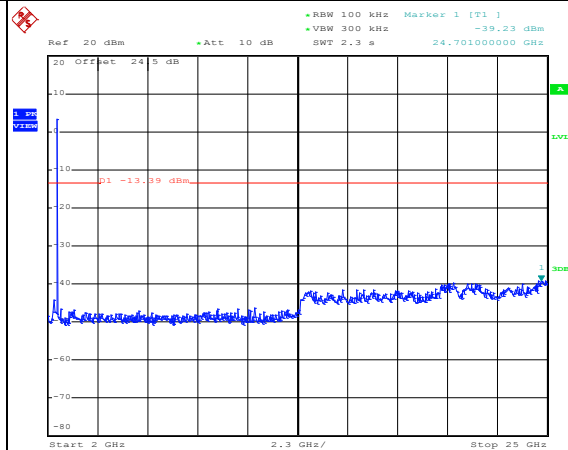

Date: 24.JUL.2015 00:41:12



Number of TX :	2	Ant. :	1
Test Mode :	802.11n HT20 (5MHz)	Temperature :	24~26°C
Test Band :	2.4GHz High	Relative Humidity :	45~49%
Test Channel :	11	Test Engineer :	Bill Kuo

WLAN 802.11n HT20 (5MHz) Channel 11

100kHz PSD reference Level

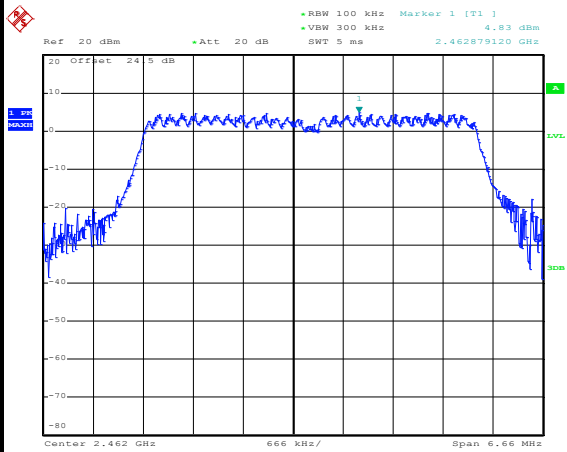

Date: 24.JUL.2015 00:50:41

High Channel Plot

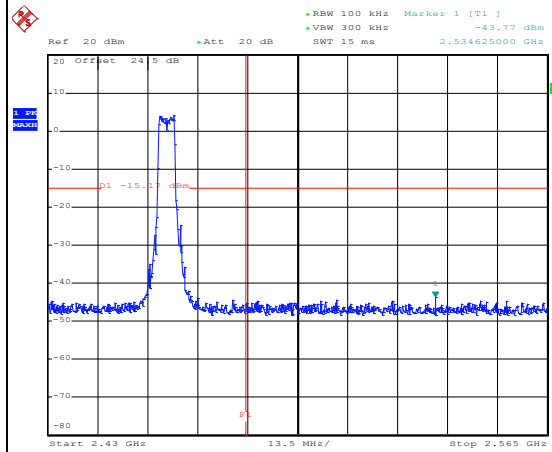

Date: 24.JUL.2015 00:50:58

Spurious Emission 30MHz~3GHz

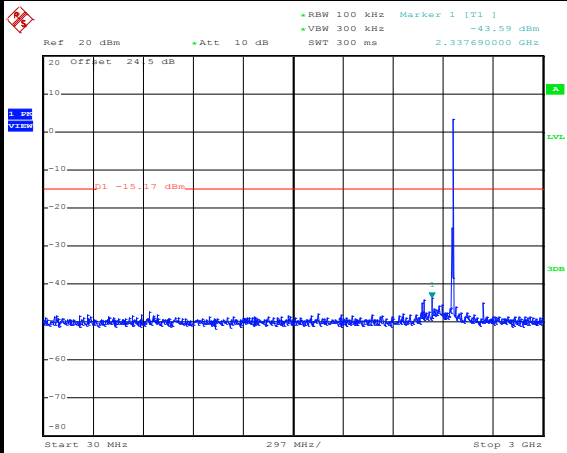

Date: 24.JUL.2015 00:51:19

Spurious Emission 2GHz~25GHz

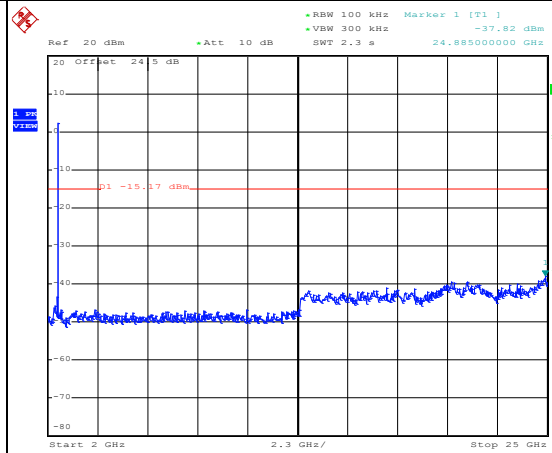

Date: 24.JUL.2015 00:51:37



Number of TX :	2	Ant. :	1
Test Mode :	802.11n HT20 (8MHz)	Temperature :	24~26°C
Test Band :	2.4GHz Low	Relative Humidity :	45~49%
Test Channel :	01	Test Engineer :	Bill Kuo

WLAN 802.11n HT20 (8MHz) Channel 01

100kHz PSD reference Level

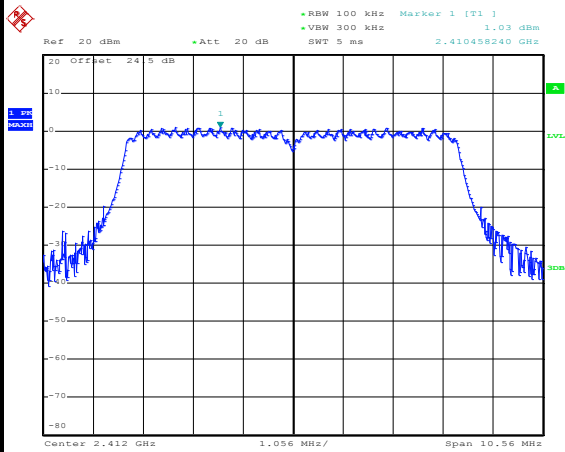

Date: 24.JUL.2015 00:54:39

Low Channel Plot

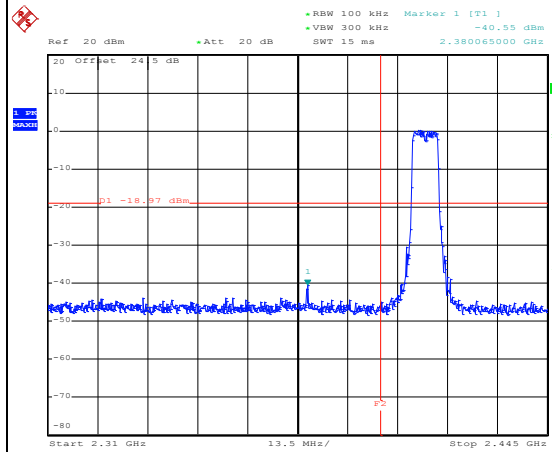

Date: 24.JUL.2015 00:54:56

Spurious Emission 30MHz~3GHz

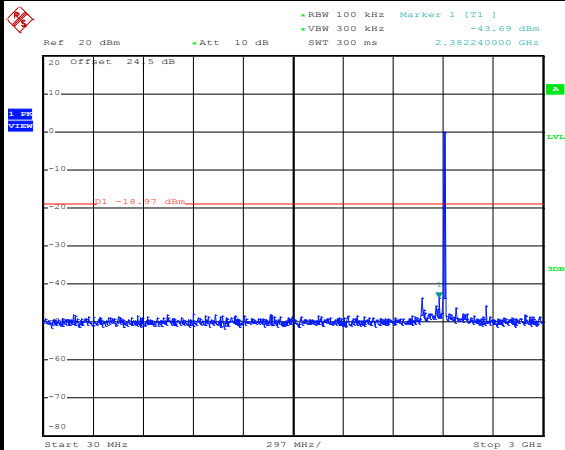

Date: 24.JUL.2015 00:55:17

Spurious Emission 2GHz~25GHz

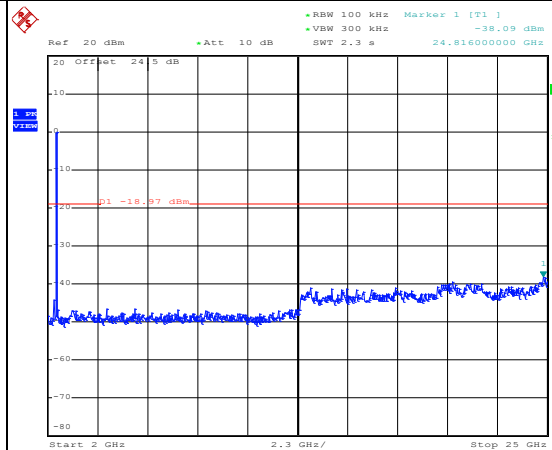

Date: 24.JUL.2015 00:55:34



Number of TX :	2	Ant. :	1
Test Mode :	802.11n HT20 (8MHz)	Temperature :	24~26°C
Test Band :	2.4GHz Mid	Relative Humidity :	45~49%
Test Channel :	06	Test Engineer :	Bill Kuo

WLAN 802.11n HT20 (8MHz) Channel 06

100kHz PSD reference Level

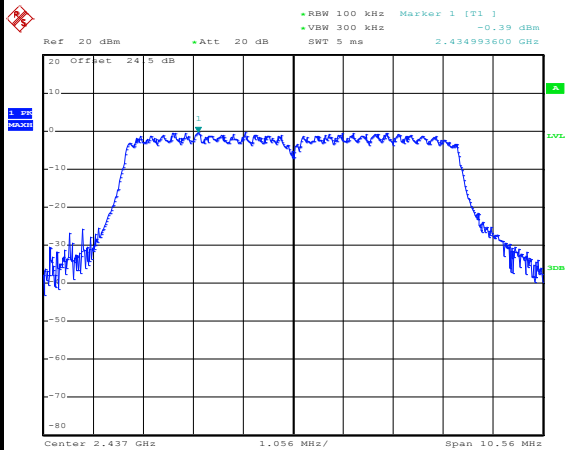

Date: 24.JUL.2015 01:08:18

Spurious Emission 30MHz~3GHz

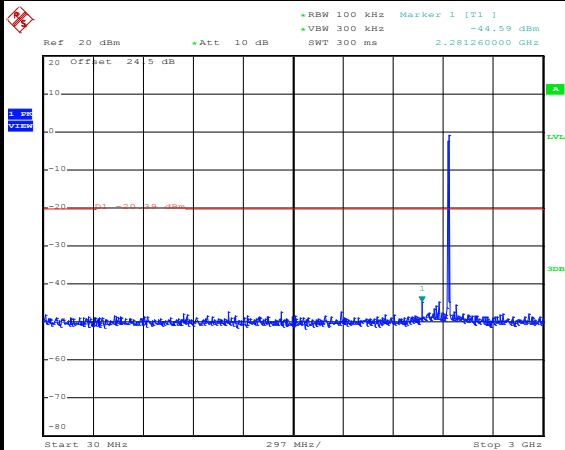

Date: 24.JUL.2015 01:09:24

Spurious Emission 2GHz~25GHz

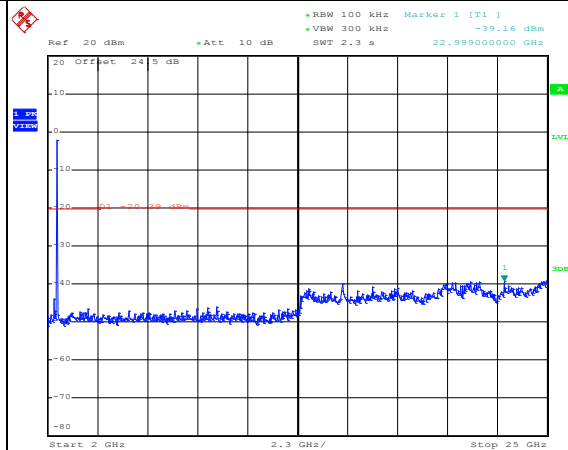

Date: 24.JUL.2015 01:09:42



Number of TX :	2	Ant. :	1
Test Mode :	802.11n HT20 (8MHz)	Temperature :	24~26°C
Test Band :	2.4GHz High	Relative Humidity :	45~49%
Test Channel :	11	Test Engineer :	Bill Kuo

WLAN 802.11n HT20 (8MHz) Channel 11

100kHz PSD reference Level

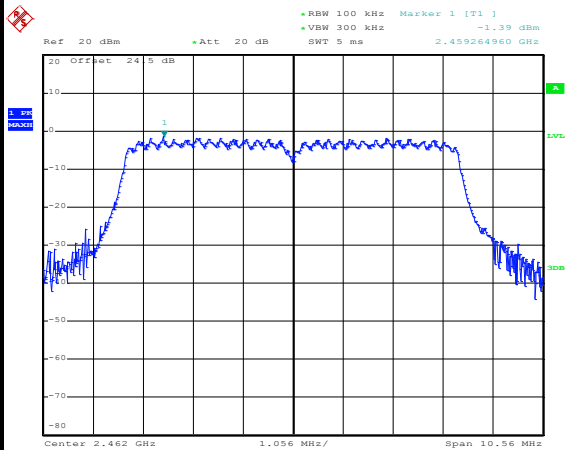

Date: 24.JUL.2015 01:12:15

High Channel Plot

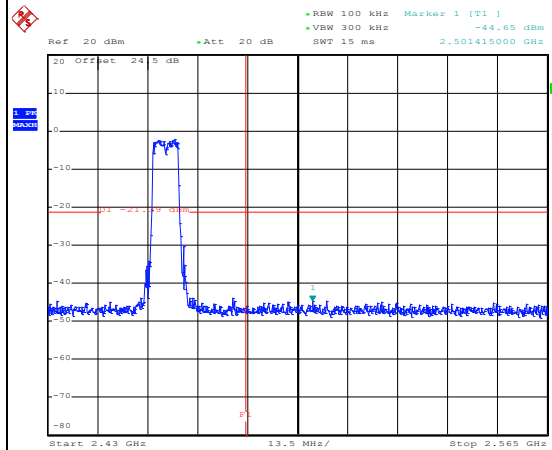

Date: 24.JUL.2015 01:12:33

Spurious Emission 30MHz~3GHz

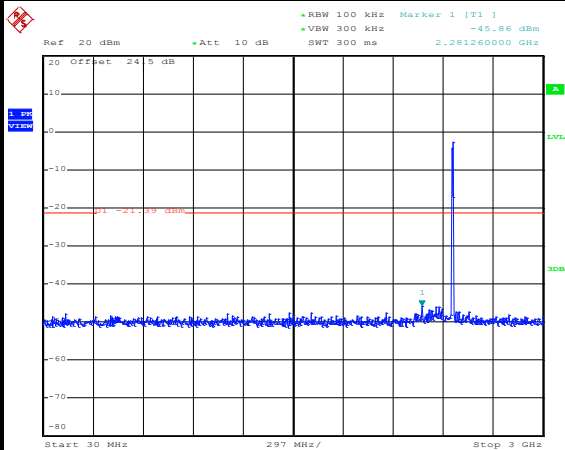

Date: 24.JUL.2015 01:12:57

Spurious Emission 2GHz~25GHz

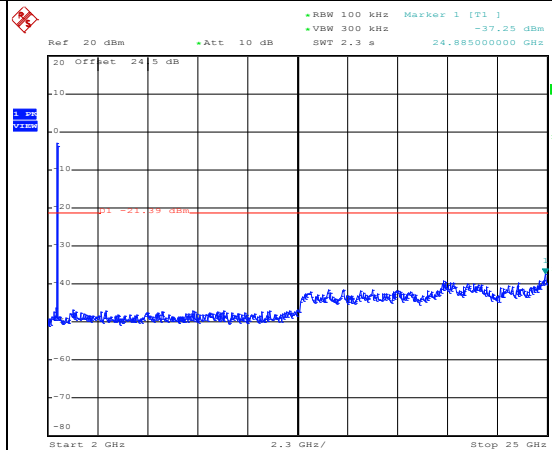

Date: 24.JUL.2015 01:13:14



Number of TX :	2	Ant. :	1
Test Mode :	802.11n HT20 (10MHz)	Temperature :	24~26°C
Test Band :	2.4GHz Low	Relative Humidity :	45~49%
Test Channel :	01	Test Engineer :	Bill Kuo

WLAN 802.11n HT20 (10MHz) Channel 01

100kHz PSD reference Level

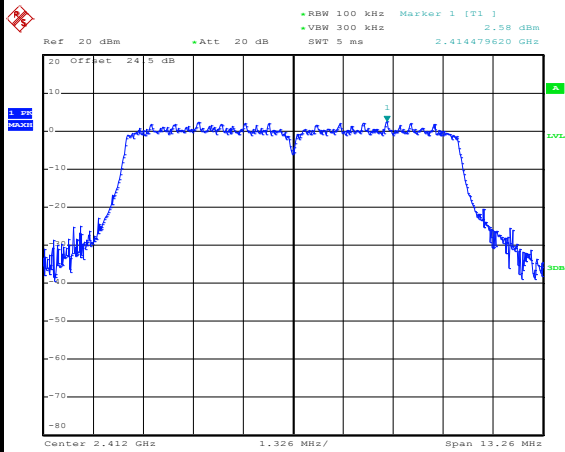

Date: 24.JUL.2015 01:24:18

Low Channel Plot

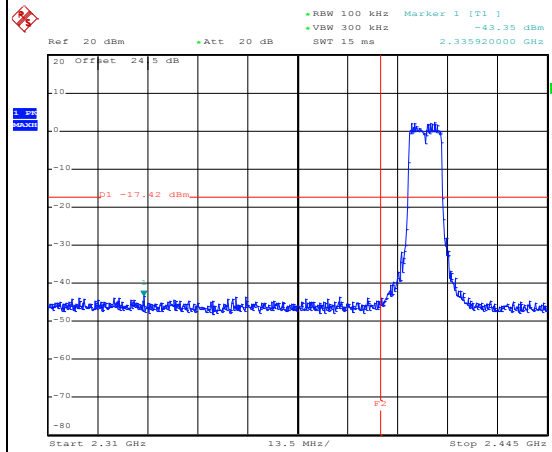

Date: 24.JUL.2015 01:24:34

Spurious Emission 30MHz~3GHz

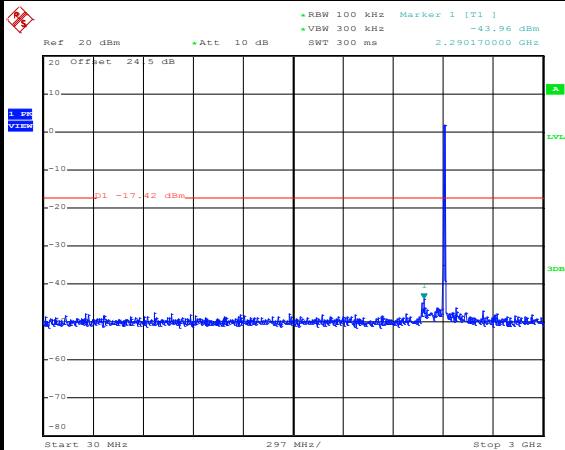

Date: 24.JUL.2015 01:25:14

Spurious Emission 2GHz~25GHz

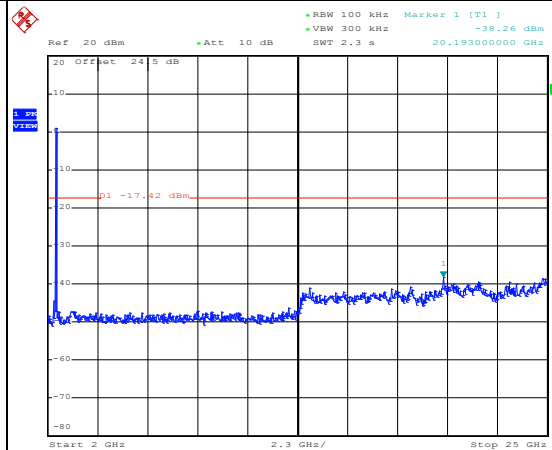

Date: 24.JUL.2015 01:25:31



Number of TX :	2	Ant. :	1
Test Mode :	802.11n HT20 (10MHz)	Temperature :	24~26°C
Test Band :	2.4GHz Mid	Relative Humidity :	45~49%
Test Channel :	06	Test Engineer :	Bill Kuo

WLAN 802.11n HT20 (10MHz) Channel 06

100kHz PSD reference Level

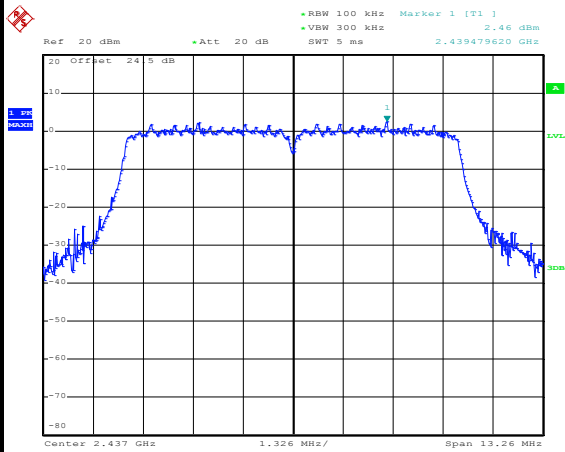

Date: 24.JUL.2015 01:28:22

Spurious Emission 30MHz~3GHz

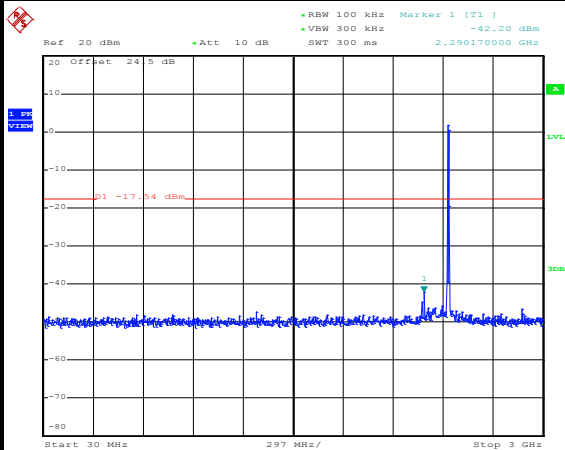

Date: 24.JUL.2015 01:28:46

Spurious Emission 2GHz~25GHz

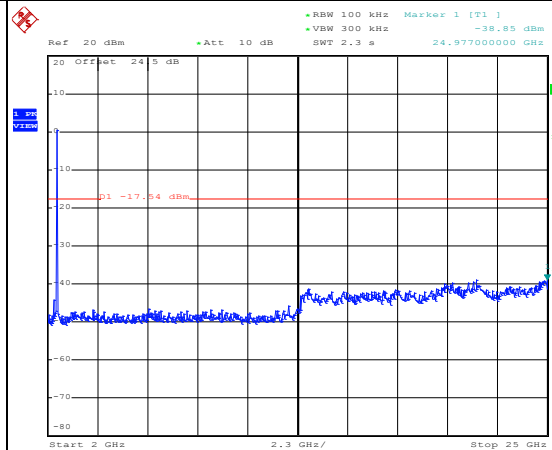

Date: 24.JUL.2015 01:29:04



Number of TX :	2	Ant. :	1
Test Mode :	802.11n HT20 (10MHz)	Temperature :	24~26°C
Test Band :	2.4GHz High	Relative Humidity :	45~49%
Test Channel :	11	Test Engineer :	Bill Kuo

WLAN 802.11n HT20 (10MHz) Channel 11

100kHz PSD reference Level

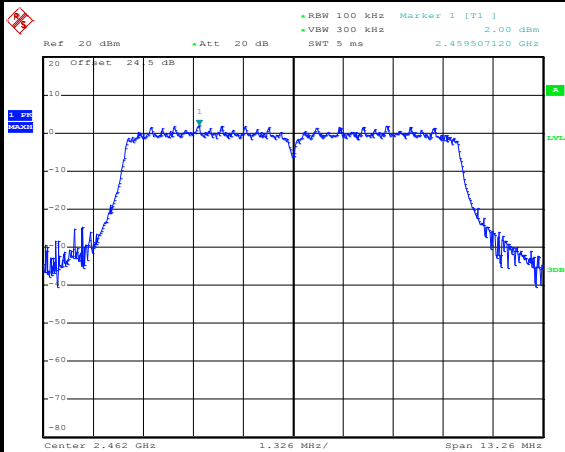

Date: 24.JUL.2015 01:41:58

High Channel Plot

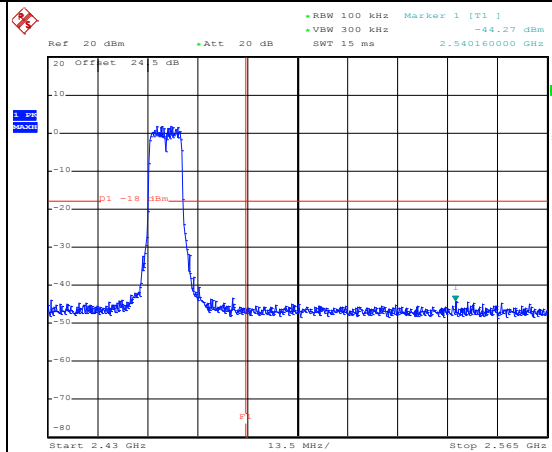

Date: 24.JUL.2015 01:42:15

Spurious Emission 30MHz~3GHz

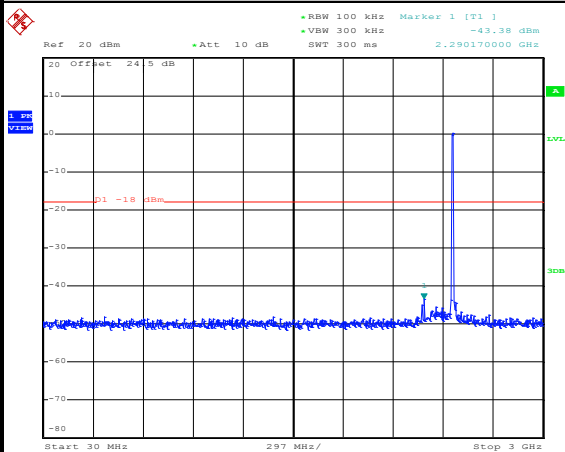

Date: 24.JUL.2015 01:42:36

Spurious Emission 2GHz~25GHz

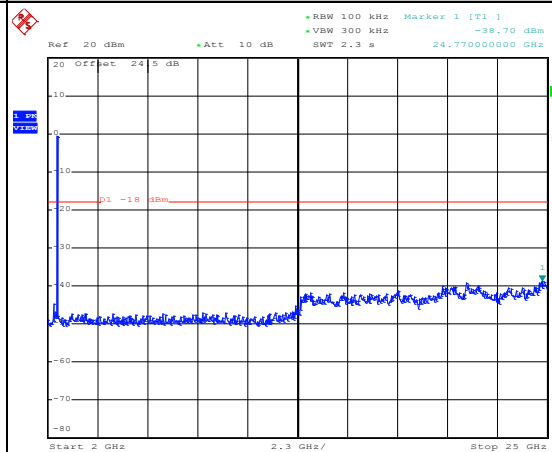

Date: 24.JUL.2015 01:42:54



Number of TX :	2	Ant. :	1
Test Mode :	802.11n HT20 (20MHz)	Temperature :	24~26°C
Test Band :	2.4GHz Low	Relative Humidity :	45~49%
Test Channel :	01	Test Engineer :	Bill Kuo

WLAN 802.11n HT20 (20MHz) Channel 01

100kHz PSD reference Level

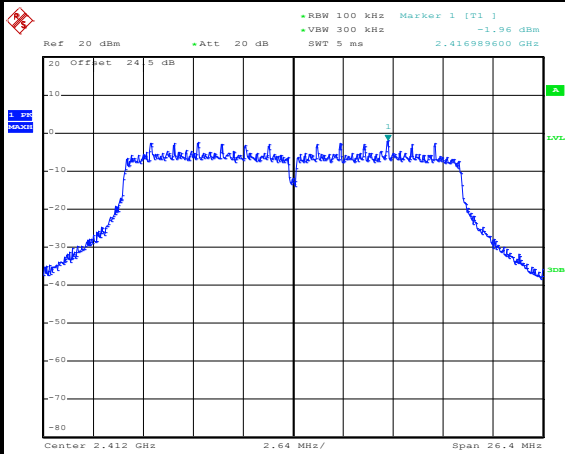

Date: 24.JUL.2015 19:51:37

Low Channel Plot

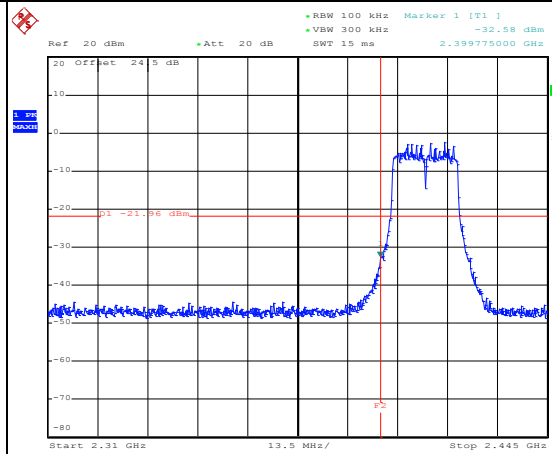

Date: 24.JUL.2015 19:51:53

Spurious Emission 30MHz~3GHz

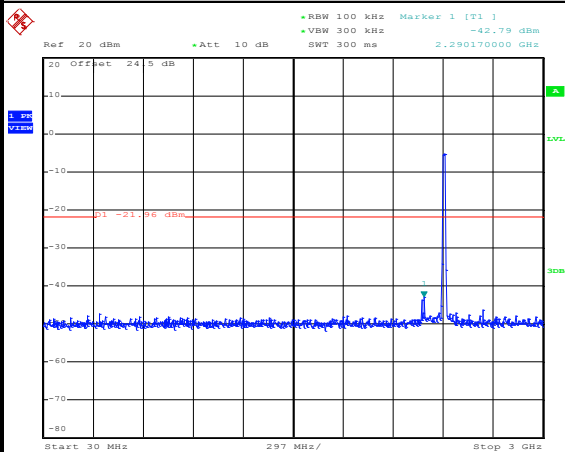

Date: 24.JUL.2015 19:52:57

Spurious Emission 2GHz~25GHz

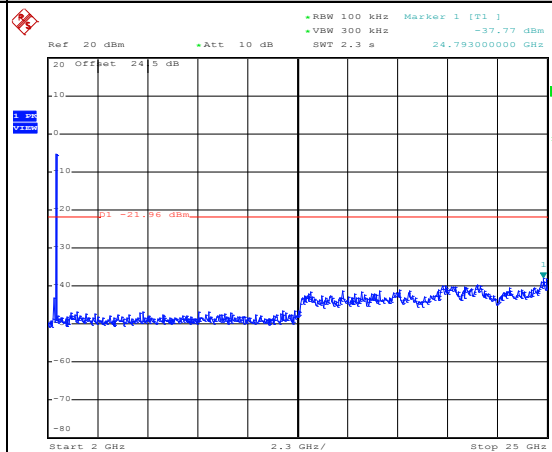

Date: 24.JUL.2015 19:53:15



Number of TX :	2	Ant. :	1
Test Mode :	802.11n HT20 (20MHz)	Temperature :	24~26°C
Test Band :	2.4GHz Mid	Relative Humidity :	45~49%
Test Channel :	06	Test Engineer :	Bill Kuo

WLAN 802.11n HT20 (20MHz) Channel 06

100kHz PSD reference Level

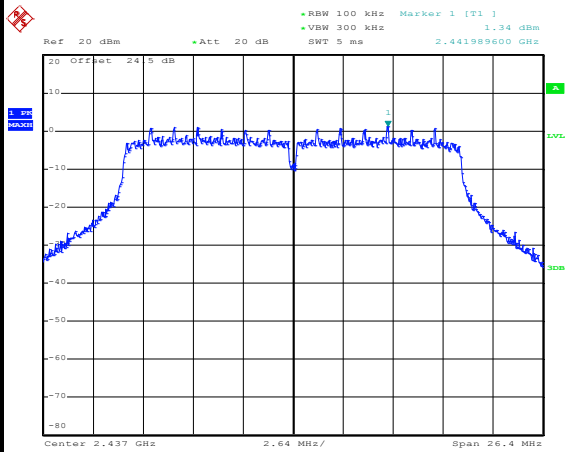

Date: 24.JUL.2015 01:55:49

Spurious Emission 30MHz~3GHz

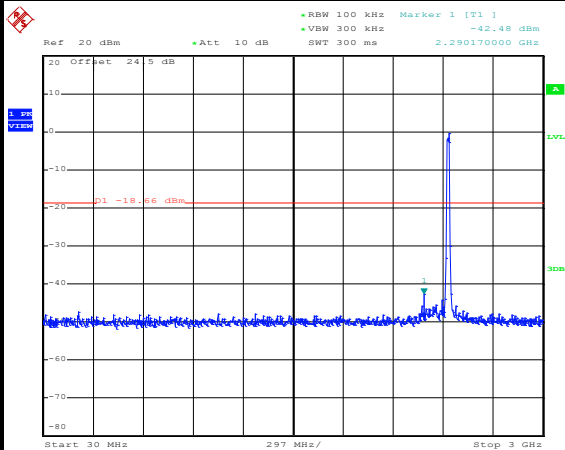

Date: 24.JUL.2015 01:56:09

Spurious Emission 2GHz~25GHz

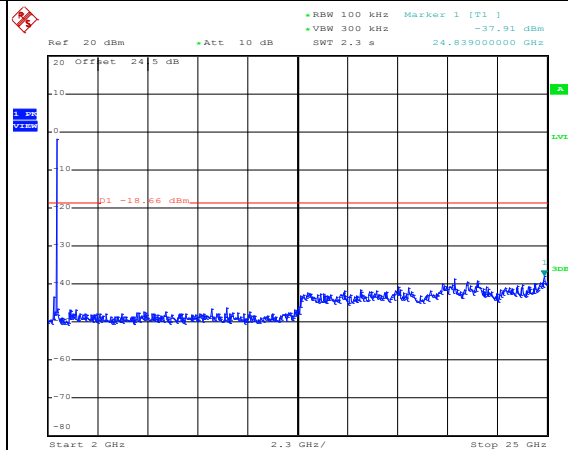

Date: 24.JUL.2015 01:56:27



Number of TX :	2	Ant. :	1
Test Mode :	802.11n HT20 (20MHz)	Temperature :	24~26°C
Test Band :	2.4GHz High	Relative Humidity :	45~49%
Test Channel :	11	Test Engineer :	Bill Kuo

WLAN 802.11n HT20 (20MHz) Channel 11

100kHz PSD reference Level

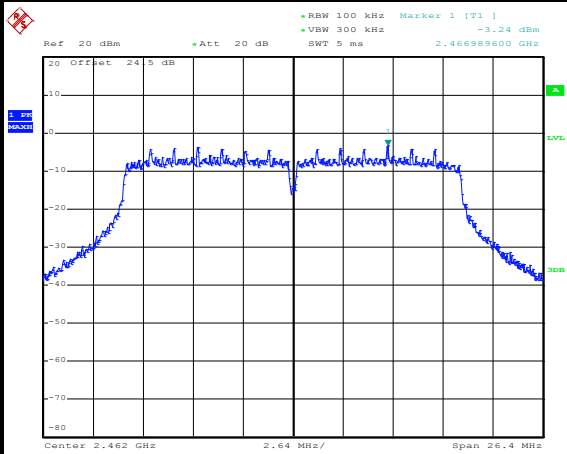

Date: 24.JUL.2015 01:45:33

High Channel Plot

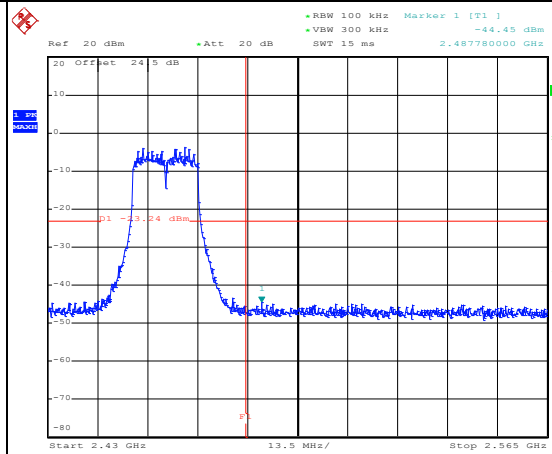

Date: 24.JUL.2015 01:45:50

Spurious Emission 30MHz~3GHz

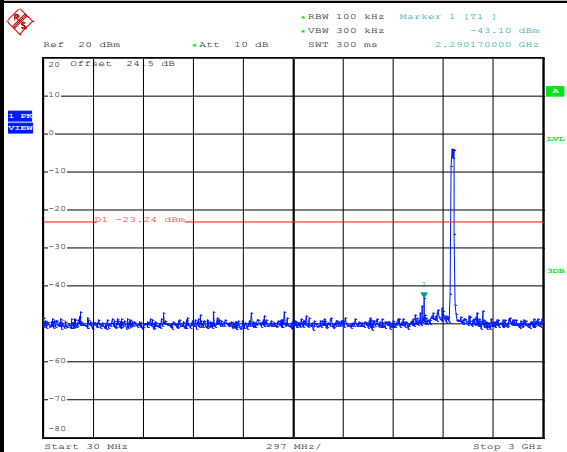

Date: 24.JUL.2015 01:46:11

Spurious Emission 2GHz~25GHz

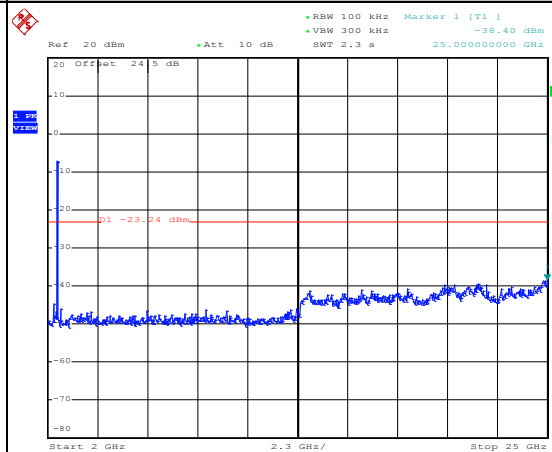

Date: 24.JUL.2015 01:46:29



Number of TX :	2	Ant. :	1
Test Mode :	802.11n HT20 (30MHz)	Temperature :	24~26°C
Test Band :	2.4GHz Low	Relative Humidity :	45~49%
Test Channel :	02	Test Engineer :	Bill Kuo

WLAN 802.11n HT20 (30MHz) Channel 02

100kHz PSD reference Level

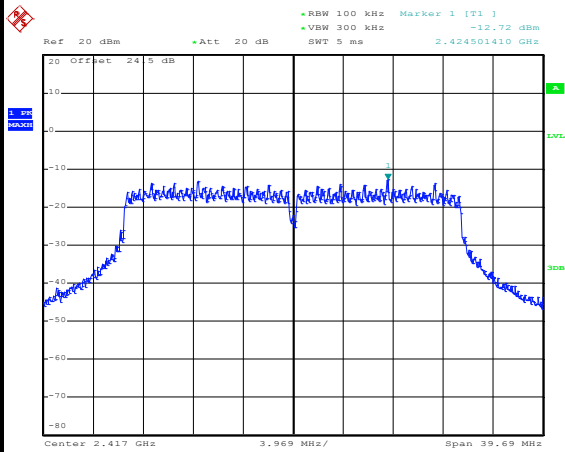

Date: 24.JUL.2015 19:57:46

Low Channel Plot

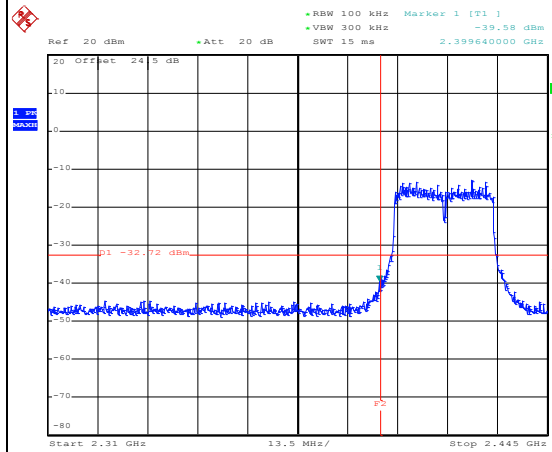

Date: 24.JUL.2015 19:58:27

Spurious Emission 30MHz~3GHz

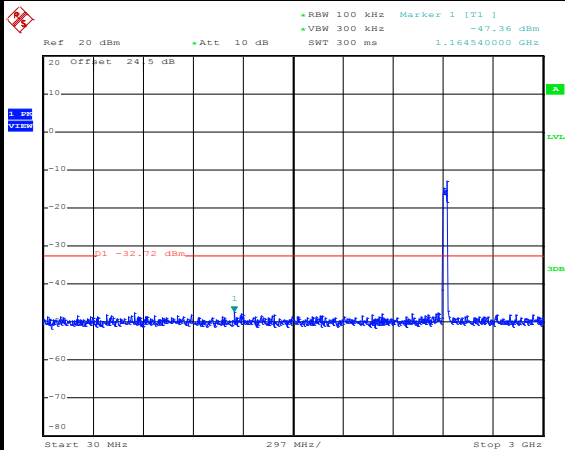

Date: 24.JUL.2015 19:58:48

Spurious Emission 2GHz~25GHz

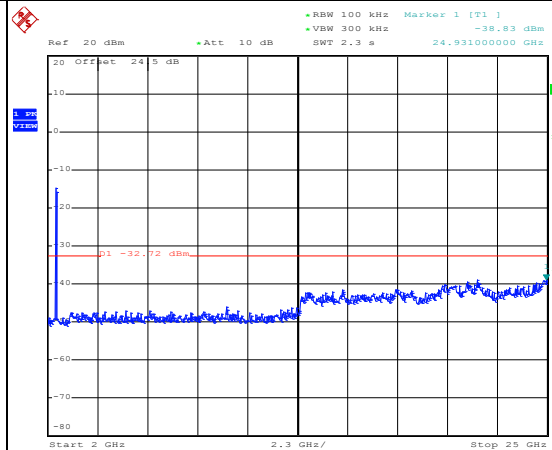

Date: 24.JUL.2015 19:59:06



Number of TX :	2	Ant. :	1
Test Mode :	802.11n HT20 (30MHz)	Temperature :	24~26°C
Test Band :	2.4GHz Mid	Relative Humidity :	45~49%
Test Channel :	06	Test Engineer :	Bill Kuo

WLAN 802.11n HT20 (30MHz) Channel 06

100kHz PSD reference Level

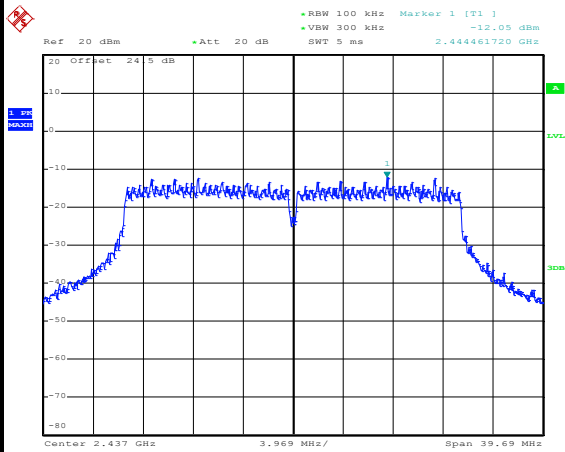

Date: 24.JUL.2015 20:10:26

Spurious Emission 30MHz~3GHz

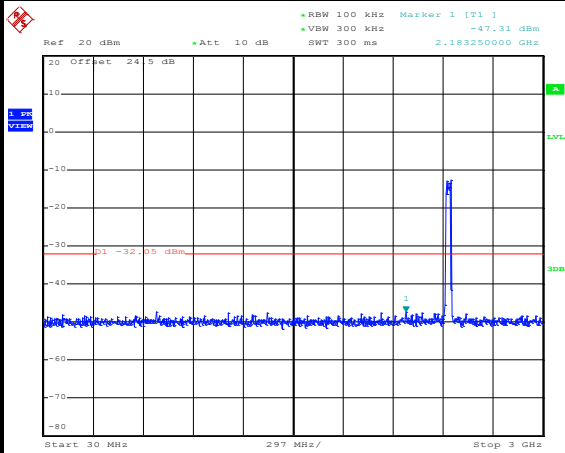

Date: 24.JUL.2015 20:10:50

Spurious Emission 2GHz~25GHz

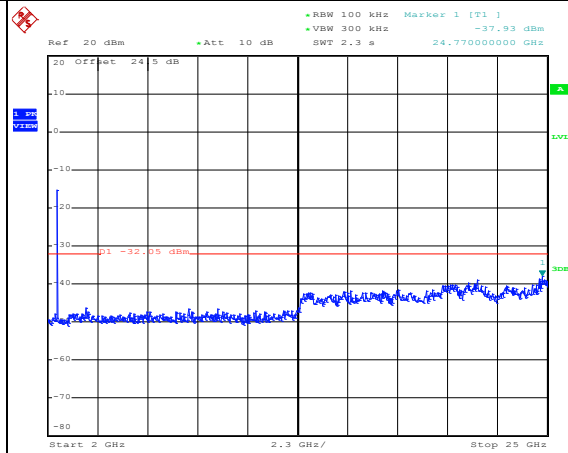

Date: 24.JUL.2015 20:11:08



Number of TX :	2	Ant. :	1
Test Mode :	802.11n HT20 (30MHz)	Temperature :	24~26°C
Test Band :	2.4GHz High	Relative Humidity :	45~49%
Test Channel :	10	Test Engineer :	Bill Kuo

WLAN 802.11n HT20 (30MHz) Channel 10

100kHz PSD reference Level

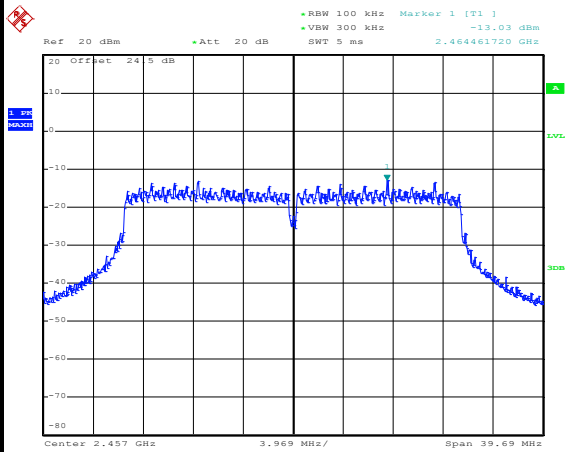

Date: 24.JUL.2015 20:13:47

High Channel Plot

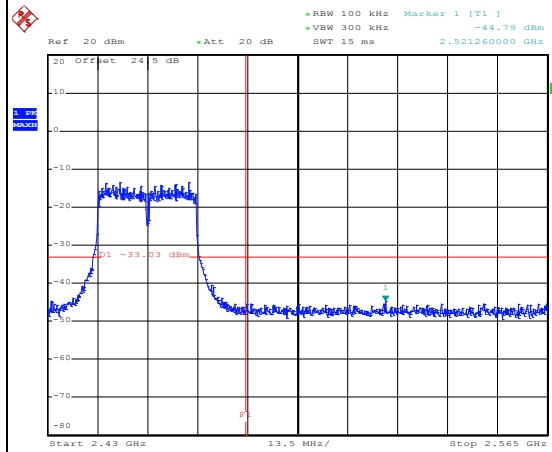

Date: 24.JUL.2015 20:14:05

Spurious Emission 30MHz~3GHz

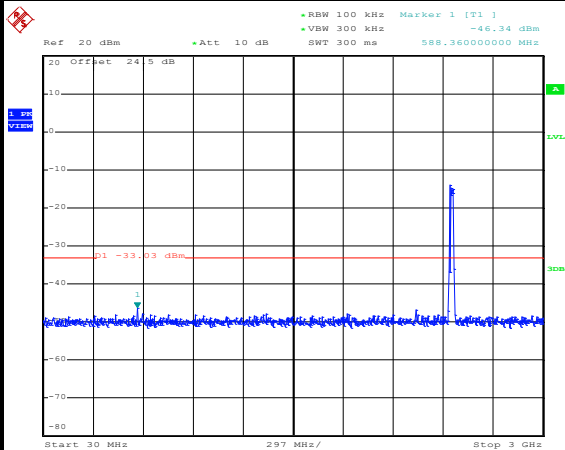

Date: 24.JUL.2015 20:14:26

Spurious Emission 2GHz~25GHz

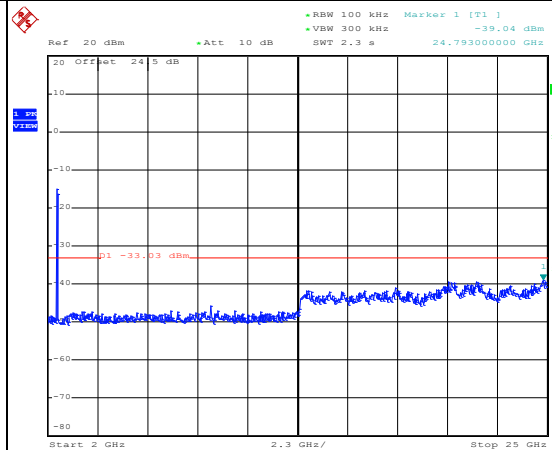

Date: 24.JUL.2015 20:14:44



Number of TX :	2	Ant. :	1
Test Mode :	802.11n HT40	Temperature :	24~26°C
Test Band :	2.4GHz Low	Relative Humidity :	45~49%
Test Channel :	03	Test Engineer :	Bill Kuo

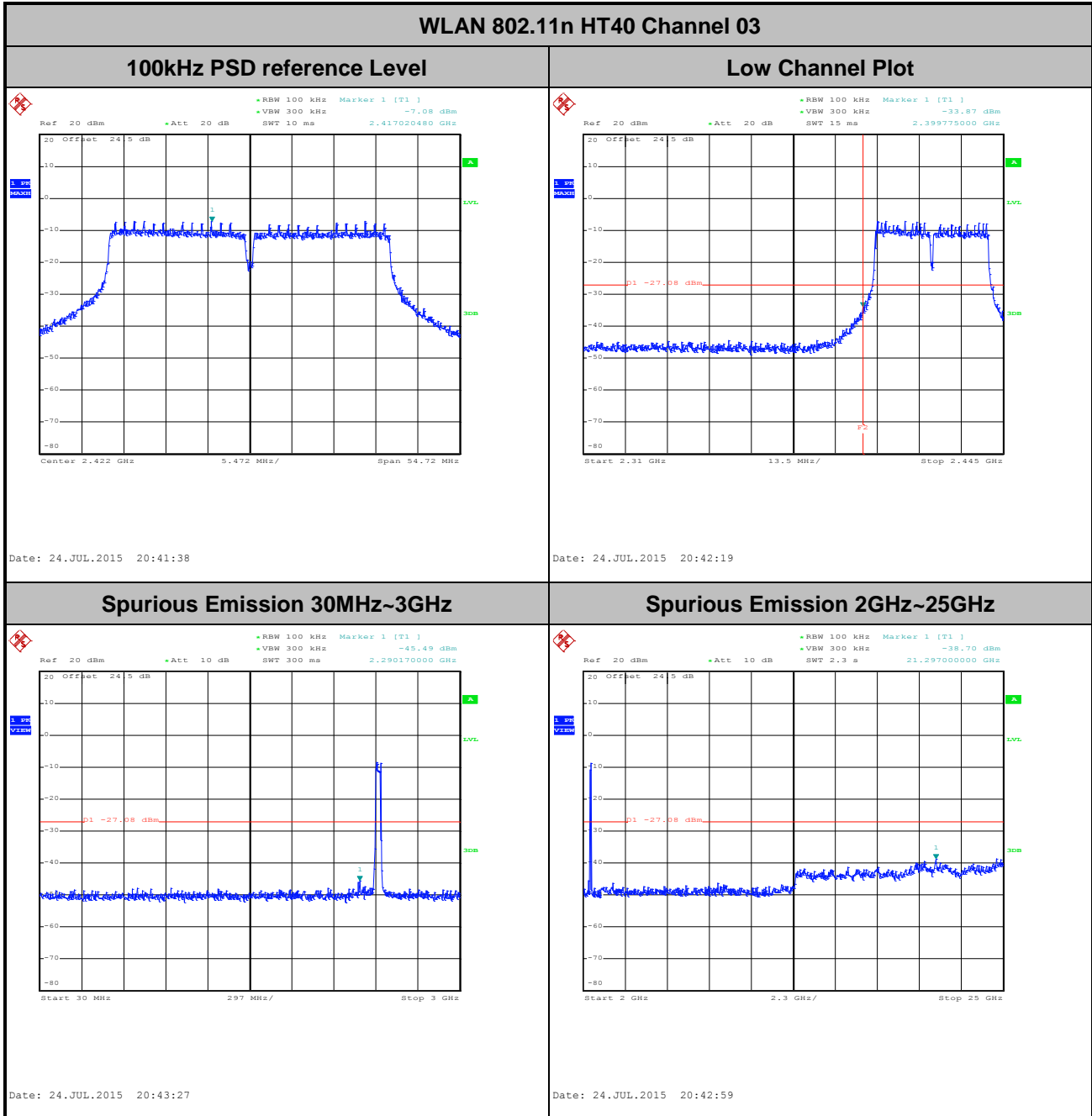



Number of TX :	2	Ant. :	1
Test Mode :	802.11n HT40	Temperature :	24~26°C
Test Band :	2.4GHz Mid	Relative Humidity :	45~49%
Test Channel :	06	Test Engineer :	Bill Kuo

WLAN 802.11n HT40 Channel 06

100kHz PSD reference Level

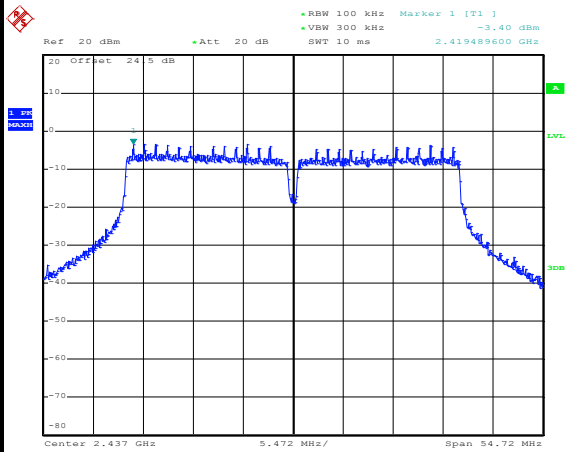

Date: 24.JUL.2015 23:59:32

Spurious Emission 30MHz~3GHz

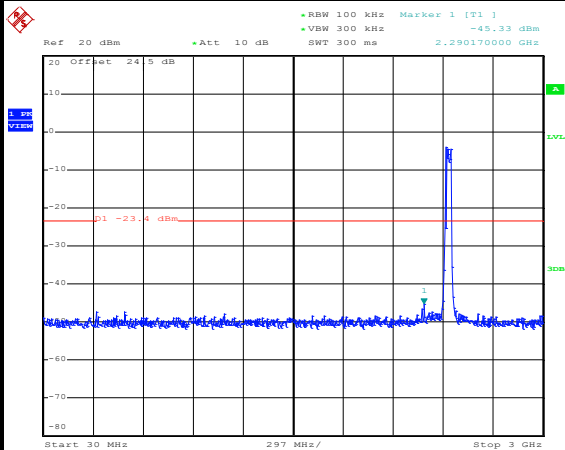

Date: 25.JUL.2015 00:01:09

Spurious Emission 2GHz~25GHz

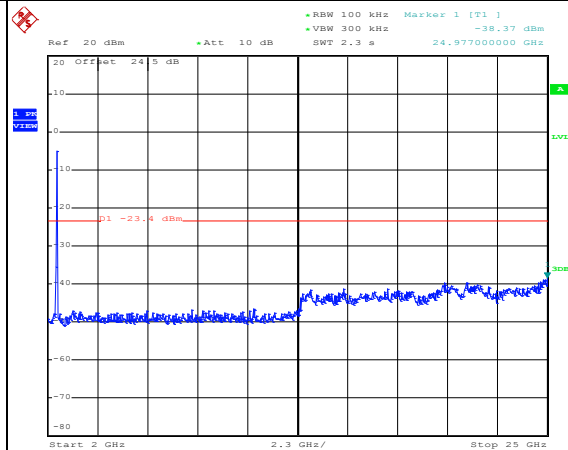

Date: 25.JUL.2015 00:00:31



Number of TX :	2	Ant. :	1
Test Mode :	802.11n HT40	Temperature :	24~26°C
Test Band :	2.4GHz High	Relative Humidity :	45~49%
Test Channel :	09	Test Engineer :	Bill Kuo

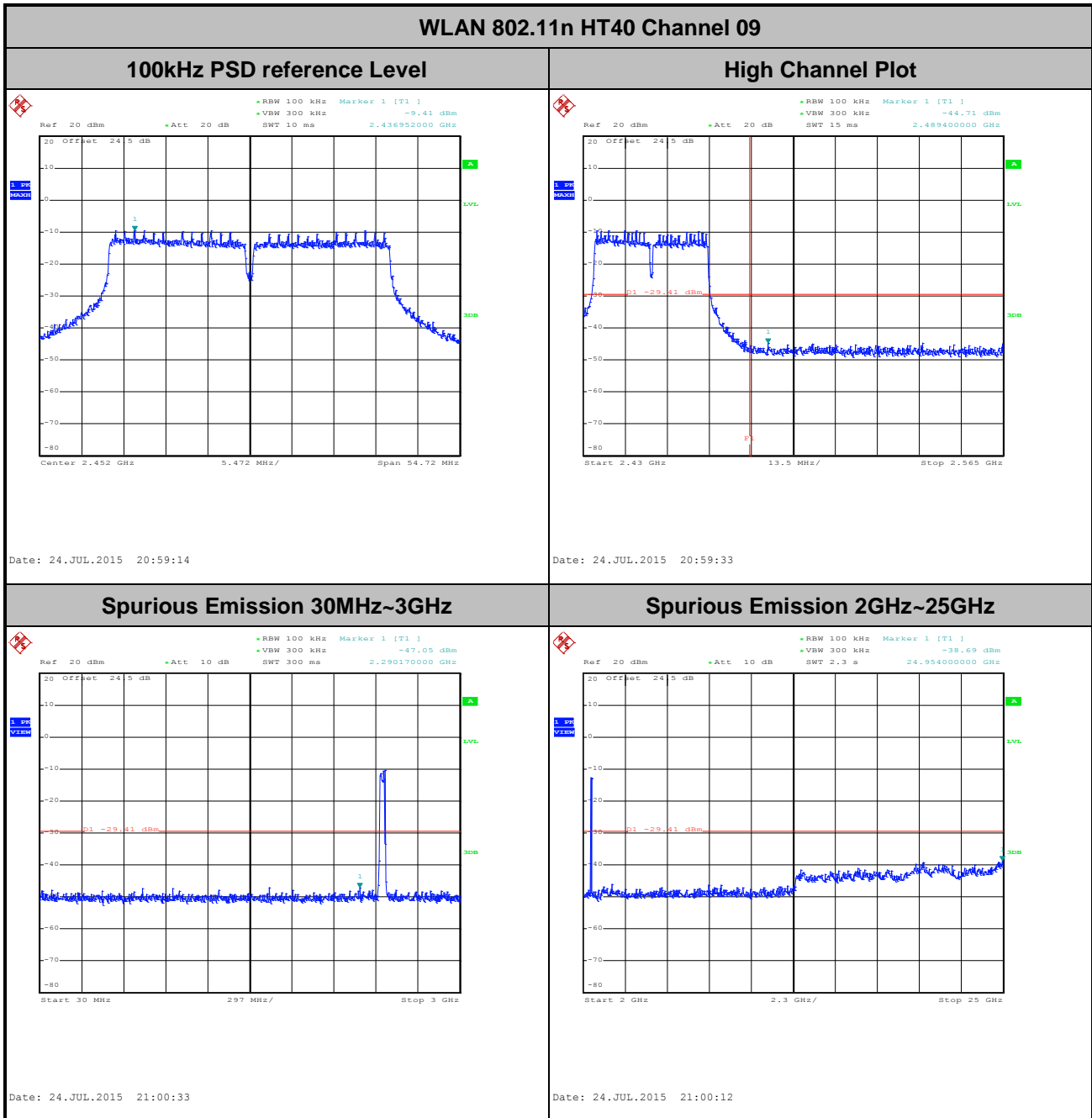



3.5 Radiated Band Edges and Spurious Emission Measurement

3.5.1 Limit of Radiated band edge and Spurious Emission Measurement

In any 100 kHz bandwidth outside the intentional radiator frequency band, all harmonics/spurious must be at least 20 dB below the highest emission level within the authorized band. If the output power of this device was measured by spectrum analyzer, the attenuation under this paragraph shall be 30 dB instead of 20 dB. In addition, radiated emissions which fall in the restricted bands must also comply with the FCC section 15.209 limits as below.

Frequency (MHz)	Field Strength (microvolts/meter)	Measurement Distance (meters)
0.009 – 0.490	2400/F(kHz)	300
0.490 – 1.705	24000/F(kHz)	30
1.705 – 30.0	30	30
30 – 88	100	3
88 – 216	150	3
216 - 960	200	3
Above 960	500	3

3.5.2 Measuring Instruments

The measuring equipment is listed in the section 4 of this test report.



3.5.3 Test Procedure

1. The testing follows FCC KDB Publication No. 558074 D01 DTS Meas. Guidance v03r03.
2. The EUT was arranged to its worst case and then tune the antenna tower (from 1 m to 4 m) and turntable (from 0 degree to 360 degrees) to find the maximum reading. A pre-amp and a high pass filter are used for the test in order to get better signal level.
3. The EUT was placed on a turntable with 0.8 meter for frequency below 1GHz and 1.5 meter for frequency above 1GHz respectively above ground.
4. The EUT was set 3 meters from the interference receiving antenna, which was mounted on the top of a variable height antenna tower.
5. Corrected Reading: $\text{Antenna Factor} + \text{Cable Loss} + \text{Read Level} - \text{Preamp Factor} = \text{Level}$
6. For measurement below 1GHz, If the emission level of the EUT measured by the peak detector is 3 dB lower than the applicable limit, the peak emission level will be reported. Otherwise, the emission measurement will be repeated using the quasi-peak detector and reported.
7. Use the following spectrum analyzer settings:
 - (1) Span shall wide enough to fully capture the emission being measured;
 - (2) Set $\text{RBW}=100 \text{ kHz}$ for $f < 1 \text{ GHz}$; $\text{VBW} \geq \text{RBW}$; Sweep = auto; Detector function = peak; Trace = max hold;
 - (3) Set $\text{RBW} = 1 \text{ MHz}$, $\text{VBW}= 3\text{MHz}$ for $f \geq 1 \text{ GHz}$ for peak measurement.
For average measurement:
 - $\text{VBW} = 10 \text{ Hz}$, when duty cycle is no less than 98 percent.
 - $\text{VBW} \geq 1/T$, when duty cycle is less than 98 percent where T is the minimum transmission duration over which the transmitter is on and is transmitting at its maximum power control level for the tested mode of operation.



Antenna	Band	Duty Cycle(%)	T(us)	1/T(kHz)	VBW Setting
1+2	2.4GHz 802.11g (5MHz) for Ant 1	97.33	5460	0.18	300Hz
1+2	2.4GHz 802.11g (5MHz) for Ant 2	97.33	5460	0.18	300Hz
1+2	2.4GHz 802.11g (8MHz) for Ant 1	97.18	3440	0.29	300Hz
1+2	2.4GHz 802.11g (8MHz) for Ant 2	97.16	3420	0.29	300Hz
1+2	2.4GHz 802.11g (10MHz) for Ant 1	97.16	2740	0.36	1kHz
1+2	2.4GHz 802.11g (10MHz) for Ant 2	96.45	2720	0.37	1kHz
1+2	2.4GHz 802.11g (20MHz) for Ant 1	96.45	1360	0.74	1kHz
1+2	2.4GHz 802.11g (20MHz) for Ant 2	96.45	1360	0.74	1kHz
1+2	2.4GHz 802.11g (30MHz) for Ant 1	95.79	910	1.10	3kHz
1+2	2.4GHz 802.11g (30MHz) for Ant 2	95.79	910	1.10	3kHz
1+2	2.4GHz 802.11n HT20 (5MHz) for Ant 1	97.14	5100	0.20	300Hz
1+2	2.4GHz 802.11n HT20 (5MHz) for Ant 2	97.13	5070	0.20	300Hz
1+2	2.4GHz 802.11n HT20 (8MHz) for Ant 1	96.97	3200	0.31	1kHz
1+2	2.4GHz 802.11n HT20 (8MHz) for Ant 2	96.97	3200	0.31	1kHz
1+2	2.4GHz 802.11n HT20 (10MHz) for Ant 1	96.21	2540	0.39	1kHz
1+2	2.4GHz 802.11n HT20 (10MHz) for Ant 2	96.95	2540	0.39	1kHz
1+2	2.4GHz 802.11n HT20 (20MHz) for Ant 1	96.21	1270	0.79	1kHz
1+2	2.4GHz 802.11n HT20 (20MHz) for Ant 2	96.24	1280	0.78	1kHz
1+2	2.4GHz 802.11n HT20 (30MHz) for Ant 1	95.51	850	1.18	3kHz
1+2	2.4GHz 802.11n HT20 (30MHz) for Ant 2	95.51	850	1.18	3kHz
1+2	2.4GHz 802.11n HT40 for Ant 1	94.08	636	1.57	3kHz
1+2	2.4GHz 802.11n HT40 for Ant 2	94.08	636	1.57	3kHz

3.5.4 Test Setup

For radiated emissions below 30MHz

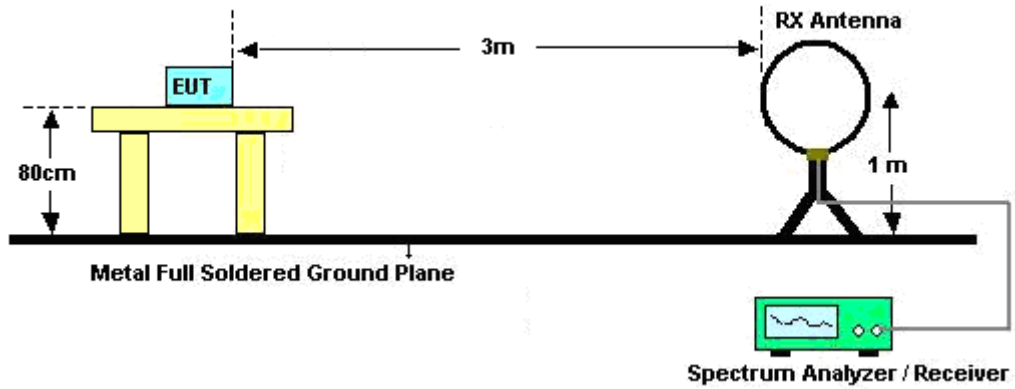

For radiated emissions from 30MHz to 1GHz

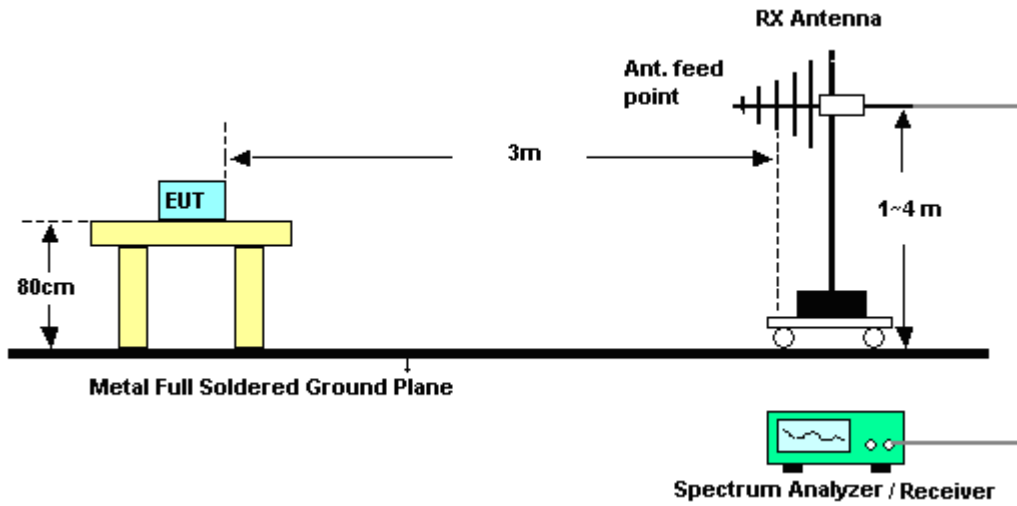

For radiated emissions above 1GHz

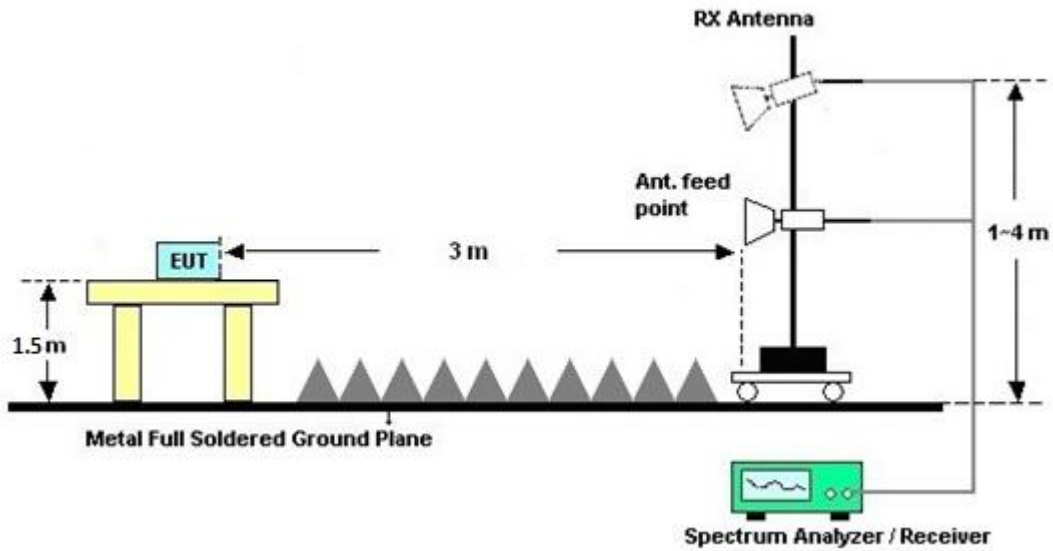

3.5.5 Test Results of Radiated Emissions (9kHz ~ 30MHz)

The low frequency, which started from 9 kHz to 30MHz, was pre-scanned and the result which was 20dB lower than the limit line per 15.31(o) was not reported.

3.5.6 Test Result of Radiated Spurious at Band Edges

Please refer to Appendix B of this test report.

3.5.7 Test Result of Radiated Spurious Emission (30MHz ~ 10th Harmonic)

Please refer to Appendix B of this test report.



3.6 AC Conducted Emission Measurement

3.6.1 Limit of AC Conducted Emission

For equipment that is designed to be connected to the public utility (AC) power line, the radio frequency voltage that is conducted back onto the AC power line on any frequency or frequencies within the band 150 kHz to 30 MHz shall not exceed the limits in the following table.

Frequency of Emission (MHz)	Conducted Limit (dBµV)	
	Quasi-Peak	Average
0.15-0.5	66 to 56*	56 to 46*
0.5-5	56	46
5-30	60	50

*Decreases with the logarithm of the frequency.

3.6.2 Measuring Instruments

The measuring equipment is listed in the section 4 of this test report.

3.6.3 Test Procedures

1. The EUT was placed 0.4 meter from the conducting wall of the shielding room, and it was kept at least 80 centimeters from any other grounded conducting surface.
2. Connect EUT to the power mains through a line impedance stabilization network (LISN).
3. All the support units are connecting to the other LISN.
4. The LISN provides 50 ohm coupling impedance for the measuring instrument.
5. The FCC states that a 50 ohm, 50 microhenry LISN should be used.
6. Both sides of AC line were checked for maximum conducted interference.
7. The frequency range from 150 kHz to 30 MHz was searched.
8. Set the test-receiver system to Peak Detect Function and specified bandwidth (IF bandwidth = 9kHz) with Maximum Hold Mode.

3.6.4 Test Setup

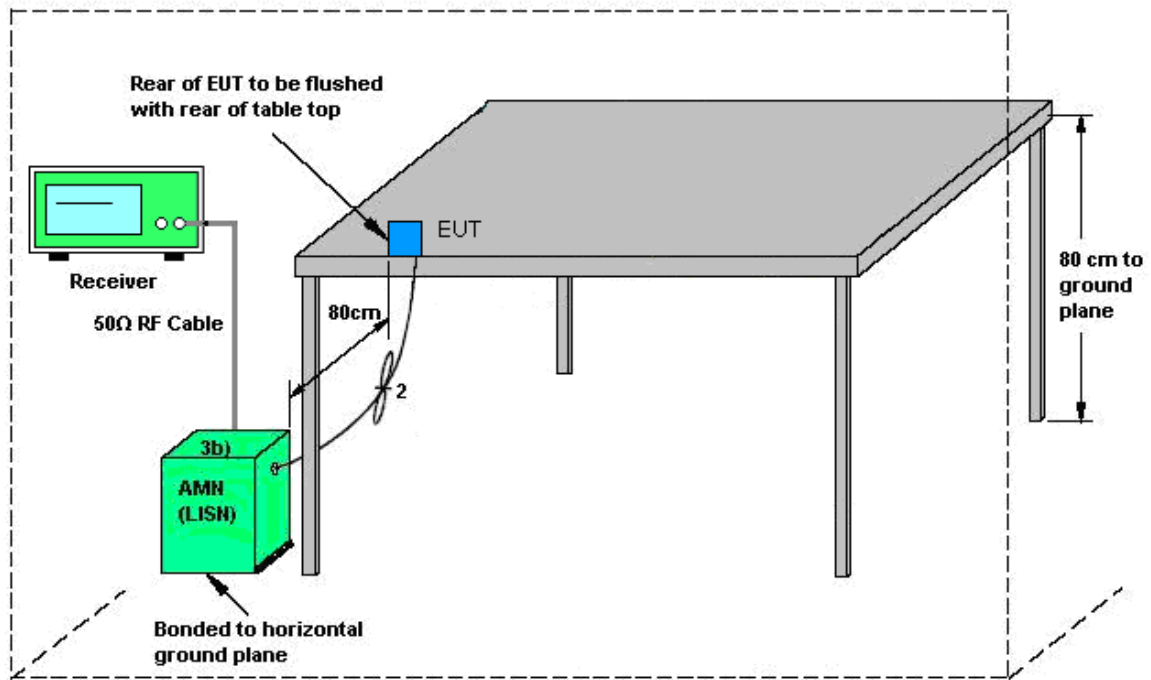

AMN = Artificial mains network (LISN)
 AE = Associated equipment
 EUT = Equipment under test
 ISN = Impedance stabilization network

3.6.5 Test Result of AC Conducted Emission

Test Mode :	Mode 1	Temperature :	22~24°C
Test Engineer :	Eric Jeng	Relative Humidity :	65~68%
Test Voltage :	120Vac / 60Hz	Phase :	Line
Function Type :	WLAN Link + RJ-45 Link + PoE		

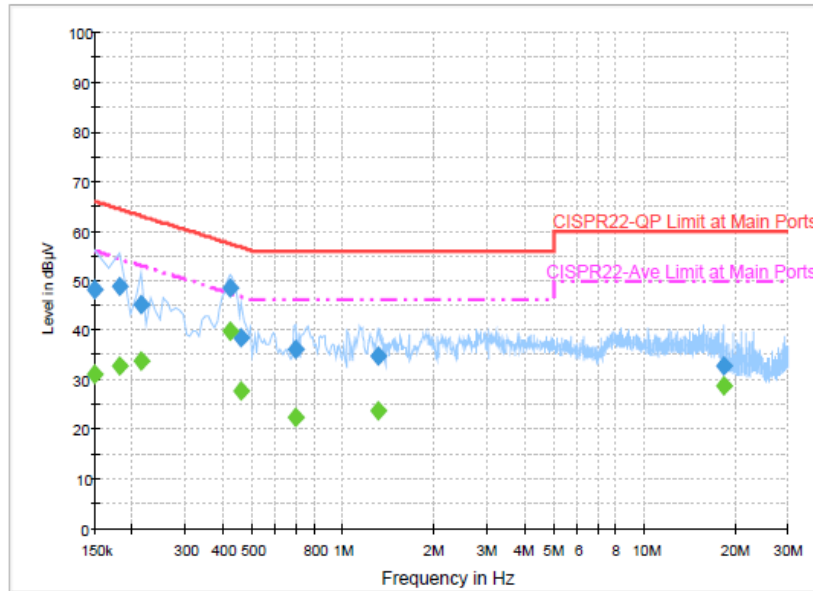

Final Result : QuasiPeak

Frequency (MHz)	QuasiPeak (dBµV)	Filter	Line	Corr. (dB)	Margin (dB)	Limit (dBµV)
0.150000	48.1	Off	L1	19.5	17.9	66.0
0.182000	48.9	Off	L1	19.5	15.5	64.4
0.214000	45.2	Off	L1	19.4	17.8	63.0
0.422000	48.5	Off	L1	19.5	8.9	57.4
0.462000	38.3	Off	L1	19.4	18.4	56.7
0.694000	36.2	Off	L1	19.6	19.8	56.0
1.302000	34.6	Off	L1	19.6	21.4	56.0
18.366000	32.8	Off	L1	20.0	27.2	60.0

Final Result : Average

Frequency (MHz)	Average (dBµV)	Filter	Line	Corr. (dB)	Margin (dB)	Limit (dBµV)
0.150000	31.2	Off	L1	19.5	24.8	56.0
0.182000	32.9	Off	L1	19.5	21.5	54.4
0.214000	33.7	Off	L1	19.4	19.3	53.0
0.422000	39.9	Off	L1	19.5	7.5	47.4
0.462000	27.6	Off	L1	19.4	19.1	46.7
0.694000	22.6	Off	L1	19.6	23.4	46.0
1.302000	23.8	Off	L1	19.6	22.2	46.0
18.366000	28.7	Off	L1	20.0	21.3	50.0



Test Mode :	Mode 1	Temperature :	22~24°C
Test Engineer :	Eric Jeng	Relative Humidity :	65~68%
Test Voltage :	120Vac / 60Hz	Phase :	Neutral
Function Type :	WLAN Link + RJ-45 Link + PoE		

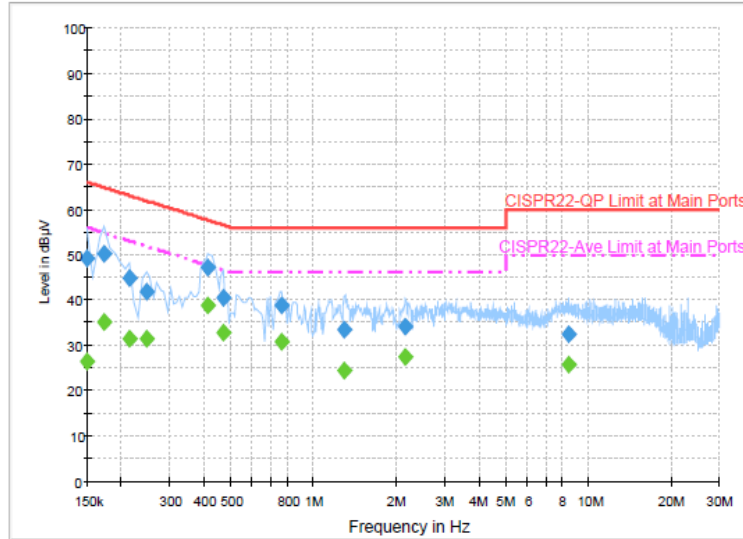

Final Result : QuasiPeak

Frequency (MHz)	QuasiPeak (dBµV)	Filter	Line	Corr. (dB)	Margin (dB)	Limit (dBµV)
0.150000	49.0	Off	N	19.5	17.0	66.0
0.174000	50.1	Off	N	19.5	14.7	64.8
0.214000	44.7	Off	N	19.4	18.3	63.0
0.246000	41.8	Off	N	19.5	20.1	61.9
0.414000	47.2	Off	N	19.5	10.4	57.6
0.470000	40.3	Off	N	19.5	16.2	56.5
0.766000	38.9	Off	N	19.5	17.1	56.0
1.294000	33.5	Off	N	19.5	22.5	56.0
2.166000	34.3	Off	N	19.7	21.7	56.0
8.470000	32.5	Off	N	19.8	27.5	60.0

Final Result : Average

Frequency (MHz)	Average (dBµV)	Filter	Line	Corr. (dB)	Margin (dB)	Limit (dBµV)
0.150000	26.5	Off	N	19.5	29.5	56.0
0.174000	35.2	Off	N	19.5	19.6	54.8
0.214000	31.4	Off	N	19.4	21.6	53.0
0.246000	31.4	Off	N	19.5	20.5	51.9
0.414000	38.7	Off	N	19.5	8.9	47.6
0.470000	32.6	Off	N	19.5	13.9	46.5
0.766000	30.7	Off	N	19.5	15.3	46.0
1.294000	24.5	Off	N	19.5	21.5	46.0
2.166000	27.5	Off	N	19.7	18.5	46.0
8.470000	25.6	Off	N	19.8	24.4	50.0



3.7 Antenna Requirements

3.7.1 Standard Applicable

If directional gain of transmitting Antennas is greater than 6dBi, the power shall be reduced by the same level in dB comparing to gain minus 6dBi. For the fixed point-to-point operation, the power shall be reduced by one dB for every 3 dB that the directional gain of the Antenna exceeds 6 dBi. The use of a permanently attached Antenna or of an Antenna that uses a unique coupling to the intentional radiator shall be considered sufficient to comply with the FCC rule.

3.7.2 Antenna Anti-Replacement Construction

An embedded-in antenna design is used.

3.7.3 Antenna Gain

FCC KDB 662911 D01 Multiple Transmitter Output v02r01.

For CDD transmissions, directional gain is calculated as

Directional gain = $G_{ANT} + \text{Array Gain}$, where Array Gain is as follows.

For power spectral density (PSD) measurements on all devices,

Array Gain = $10 \log(N_{ANT}/N_{SS}=1)$ dB.

For power measurements on IEEE 802.11 devices,

Array Gain = 0 dB (i.e., no array gain) for $N_{ANT} \leq 4$.

The EUT supports CDD mode.

The power and PSD limit should be modified if the directional gain of EUT is over 6 dBi,

The directional gain "DG" is calculated as following table.

	Ant. 1	Ant. 2	DG for Power (dBi)	DG for PSD (dBi)	Power Limit Reduction (dB)	PSD Limit Reduction (dB)
2.4 GHz	13.00	13.00	13.00	16.01	7.00	10.01

Power Limit Reduction = $DG(\text{Power}) - 6\text{dBi}$, (min = 0)

PSD Limit Reduction = $DG(\text{PSD}) - 6\text{dBi}$, (min = 0)



4 List of Measuring Equipment

Instrument	Manufacturer	Model No.	Serial No.	Characteristics	Calibration Date	Test Date	Due Date	Remark
Power Meter	Anritsu	ML2495A	1218006	300MHz~40GHz	Oct. 18, 2014	Jul. 21, 2015~ Jul. 26, 2015	Oct. 17, 2015	Conducted (TH05-HY)
Power Sensor	Anritsu	MA2411B	1126017	300MHz~40GHz	Oct. 18, 2014	Jul. 21, 2015~ Jul. 26, 2015	Oct. 17, 2015	Conducted (TH05-HY)
Spectrum Analyzer	Rohde & Schwarz	FSP40	100055	9kHz-40GHz	Jun. 18, 2015	Jul. 21, 2015~ Jul. 26, 2015	Jun. 17, 2016	Conducted (TH05-HY)
EMI Test Receiver	Rohde & Schwarz	ESCS 30	100356	9kHz – 2.75GHz	Dec. 01, 2014	Jun. 03, 2015	Nov. 30, 2015	Conduction (CO05-HY)
LISN	Rohde & Schwarz	ENV216	100080	9kHz~30MHz	Dec. 02, 2014	Jun. 03, 2015	Dec. 01, 2015	Conduction (CO05-HY)
AC Power Source	ChainTek	APC-1000W	N/A	N/A	N/A	Jun. 03, 2015	N/A	Conduction (CO05-HY)
LISN (for auxiliary equipment)	Rohde & Schwarz	ENV216	100081	9kHz~30MHz	Dec. 08, 2014	Jun. 03, 2015	Dec. 07, 2015	Conduction (CO05-HY)
Impedance Stabilization Network	SCHAFFNER	ST08	22589	150kHz ~ 230MHz	Feb. 06, 2015	Jun. 03, 2015	Feb. 05, 2016	Conduction (CO05-HY)
Bilog Antenna	Schaffner	CBL6111C	2726	30MHz ~ 1GHz	Sep. 27, 2014	Jul. 17, 2015 ~ Jul. 20, 2015	Sep. 26, 2015	Radiation (03CH07-HY)
Double Ridge Horn Antenna	ESCO	3117	00075962	1GHz ~ 18GHz	Aug. 19, 2014	Jul. 17, 2015 ~ Jul. 20, 2015	Aug. 18, 2015	Radiation (03CH07-HY)
EMI Test Receiver	Rohde & Schwarz	ESCI 7	100724	9kHz~7GHz	Aug. 30, 2014	Jul. 17, 2015 ~ Jul. 20, 2015	Aug. 29, 2015	Radiation (03CH07-HY)
Horn Antenna	SCHWARZBECK	BBHA 9170	BBHA9170584	18GHz- 40GHz	Nov. 03, 2014	Jul. 17, 2015 ~ Jul. 20, 2015	Nov. 02, 2015	Radiation (03CH07-HY)
Loop Antenna	Rohde & Schwarz	HFH2-Z2	100315	9 kHz~30 MHz	Jul. 28, 2014	Jul. 17, 2015 ~ Jul. 20, 2015	Jul. 27, 2015	Radiation (03CH07-HY)
Preamplifier	MITEQ	AMF-7D-0010 1800-30-10P	1590075	1GHz ~ 18GHz	Apr. 20, 2015	Jul. 17, 2015 ~ Jul. 20, 2015	Apr. 19, 2016	Radiation (03CH07-HY)
Preamplifier	COM-POWER	PA-103A	161241	10MHz-1000MHz	Mar. 12, 2015	Jul. 17, 2015 ~ Jul. 20, 2015	Mar. 11, 2016	Radiation (03CH07-HY)
Preamplifier	Agilent	8449B	3008A02362	1GHz~ 26.5GHz	Oct. 21, 2014	Jul. 17, 2015 ~ Jul. 20, 2015	Oct. 20, 2015	Radiation (03CH07-HY)
Signal Analyzer	Rohde & Schwarz	FSV 30	101749	10Hz~30GHz	Mar. 10, 2015	Jul. 17, 2015 ~ Jul. 20, 2015	Mar. 09, 2016	Radiation (03CH07-HY)
Antenna Mast	Max-Full	MFA520BS	N/A	1m~4m	N/A	Jul. 17, 2015 ~ Jul. 20, 2015	N/A	Radiation (03CH07-HY)
Turn Table	ChainTek	Chaintek 3000	N/A	0~360 degree	N/A	Jul. 17, 2015 ~ Jul. 20, 2015	N/A	Radiation (03CH07-HY)
Preamplifier	MITEQ	JS44-180040 00-33-8P	1840917	18GHz ~ 40GHz	Jun. 02, 2015	Jul. 17, 2015 ~ Jul. 20, 2015	Jun. 01, 2016	Radiation (03CH07-HY)
Signal Analyzer	Rohde & Schwarz	FSV40	101397	10Hz~40GHz	Sep. 17, 2014	Jul. 17, 2015 ~ Jul. 20, 2015	Sep. 16, 2015	Radiation (03CH07-HY)



5 Uncertainty of Evaluation

Uncertainty of Conducted Emission Measurement (150kHz ~ 30MHz)

Measuring Uncertainty for a Level of Confidence of 95% ($U = 2Uc(y)$)	2.26
---	------

Uncertainty of Radiated Emission Measurement (30 MHz ~ 1000 MHz)

Measuring Uncertainty for a Level of Confidence of 95% ($U = 2Uc(y)$)	5.2
---	-----



Appendix A. Conducted Test Results