



**MET Laboratories, Inc.** *Safety Certification - EMI - Telecom Environmental Simulation*

914 WEST PATAPSCO AVENUE • BALTIMORE, MARYLAND 21230-3432 • PHONE (410) 354-3300 • FAX (410) 354-3313

33439 WESTERN AVENUE • UNION CITY, CALIFORNIA 94587 • PHONE (510) 489-6300 • FAX (510) 489-6372

3162 BELICK STREET • SANTA CLARA, CALIFORNIA 95054 • PHONE (408) 748-3585 • FAX (510) 489-6372

October 10, 2011

Ubiquiti Networks, Inc.  
91 E. Tasman  
San Jose, CA 95134

Dear Jennifer Sanchez,

Enclosed is the EMC Wireless test report for compliance testing of the Ubiquiti Networks, Inc., PowerBridgeM5X3 as tested to the requirements of Title 47 of the CFR, Ch. 1 (10-1-06 ed.), Part 15, Subpart B, ICES-003, Issue 4 February 2004 for a Class A Digital Device and FCC Part 15 Subpart C, RSS-210, Issue 8, Dec. 2010 for Intentional Radiators.

Thank you for using the services of MET Laboratories, Inc. If you have any questions regarding these results or if MET can be of further service to you, please feel free to contact me.

Sincerely yours,  
MET LABORATORIES, INC.

Jennifer Warnell  
Documentation Department

Reference: (\Ubiquiti Networks, Inc.\EMCS32744-FCC247 Rev. 1)

Certificates and reports shall not be reproduced except in full, without the written permission of MET Laboratories, Inc.

## **Electromagnetic Compatibility Criteria Test Report**

for the

**Ubiquiti Networks, Inc.  
PowerBridgeM5X3**

**Tested under**  
the FCC Certification Rules  
contained in  
Title 47 of the CFR, Parts 15 Subpart B & ICES-003  
for Class A Digital Devices  
&  
15.247 Subpart C & RSS-210, Issue 8, Dec. 2010  
for Intentional Radiators

**MET Report: EMCS32744-FCC247 Rev. 1**

October 10, 2011

**Prepared For:**

**Ubiquiti Networks, Inc.  
91 E. Tasman  
San Jose, CA 95134**

**Prepared By:**  
**MET Laboratories, Inc.**  
3162 Belick St.  
Santa Clara, CA 95054

## Electromagnetic Compatibility Criteria Test Report

for the

**Ubiquiti Networks, Inc.**  
**PowerBridgeM5X3**

**Tested under**  
the FCC Certification Rules  
contained in  
Title 47 of the CFR, Parts 15 Subpart B & ICES-003  
for Class A Digital Devices  
&  
15.247 Subpart C & RSS-210, Issue 8, Dec. 2010  
for Intentional Radiators



Anderson Soungpanya, Project Engineer  
Electromagnetic Compatibility Lab



Jennifer Warnell  
Documentation Department

**Engineering Statement:** The measurements shown in this report were made in accordance with the procedures indicated, and the emissions from this equipment were found to be within the limits applicable. I assume full responsibility for the accuracy and completeness of these measurements, and for the qualifications of all persons taking them. It is further stated that upon the basis of the measurements made, the equipment tested is capable of operation in accordance with the requirements of the FCC Rules Parts 15B, 15.247 and Industry Canada standards ICES-003, Issue 4 February 2004, RSS-210, Issue 8, Dec. 2010 under normal use and maintenance.



Shawn McMillen,  
Wireless Manager, Electromagnetic Compatibility Lab

## Report Status Sheet

| Revision | Report Date      | Reason for Revision                      |
|----------|------------------|--|
| ∅        | October 10, 2011 | Initial Issue.                           |
| 1        | October 20, 2011 | Revised to reflect editorial correction. |

## Table of Contents

|             |   |            |
|-------------|---|------------|
| <b>I.</b>   | <b>Executive Summary .....</b>  | <b>1</b>   |
|             | A. Purpose of Test .....  | 2          |
|             | B. Executive Summary .....  | 2          |
| <b>II.</b>  | <b>Equipment Configuration .....</b>  | <b>3</b>   |
|             | A. Overview.....  | 4          |
|             | B. References.....  | 5          |
|             | C. Test Site .....  | 5          |
|             | D. Description of Test Sample.....  | 6          |
|             | E. Equipment Configuration.....   | 7          |
|             | F. Support Equipment .....  | 7          |
|             | G. Ports and Cabling Information.....   | 7          |
|             | H. Method of Monitoring EUT Operation .....                                     | 8          |
|             | I. Modifications .....  | 8          |
|             | a) Modifications to EUT.....  | 8          |
|             | b) Modifications to Test Standard.....  | 8          |
|             | J. Disposition of EUT .....   | 8          |
| <b>III.</b> | <b>Electromagnetic Compatibility Criteria for Unintentional Radiators .....</b> | <b>9</b>   |
|             | § 15.107(a) Conducted Emissions Limits.....                                     | 10         |
|             | § 15.109(a) Radiated Emissions Limits.....                                      | 13         |
| <b>IV.</b>  | <b>Electromagnetic Compatibility Criteria for Intentional Radiators .....</b>   | <b>17</b>  |
|             | § 15.203 Antenna Requirement .....  | 18         |
|             | § 15.207(a) Conducted Emissions Limits.....                                     | 19         |
|             | § 15.247(a)(a) 6 dB and 99% Bandwidth .....                                     | 22         |
|             | § 15.247(b) Peak Power Output .....   | 39         |
|             | § 15.247(d) Radiated Spurious Emissions Requirements and Band Edge.....         | 48         |
|             | § 15.247(d) RF Conducted Spurious Emissions Requirements and Band Edge.....     | 64         |
|             | § 15.247(e) Peak Power Spectral Density .....                                   | 88         |
|             | § 15.247(i) Maximum Permissible Exposure .....                                  | 93         |
|             | RSS-GEN Receiver Spurious Emissions.....  | 94         |
| <b>V.</b>   | <b>Test Equipment .....</b>   | <b>97</b>  |
| <b>VI.</b>  | <b>Certification &amp; User's Manual Information .....</b>                      | <b>99</b>  |
|             | A. Certification Information .....  | 100        |
|             | B. Label and User's Manual Information .....                                    | 104        |
| <b>VII.</b> | <b>ICES-003 Procedural &amp; Labeling Requirements.....</b>                     | <b>106</b> |

## List of Tables

|   |    |
|---|----|
| Table 1. Executive Summary of EMC Part 15.247 Compliance Testing .....  | 2  |
| Table 2. EUT Summary Table.....   | 4  |
| Table 3. References .....   | 5  |
| Table 4. Equipment Configuration .....  | 7  |
| Table 5. Support Equipment.....   | 7  |
| Table 6. Ports and Cabling Information .....  | 7  |
| Table 7. Conducted Limits for Radio Frequency Devices calculated from FCC Part 15 Subsections 15.107(a) (b) and 15.207(a) ..... | 10 |
| Table 8. Conducted Emissions - Voltage, AC Power, Phase Line (120 VAC, 60 Hz).....  | 11 |
| Table 9. Conducted Emissions - Voltage, AC Power, Neutral Line (120 VAC, 60 Hz) .....   | 12 |
| Table 10. Radiated Emissions Limits calculated from FCC Part 15, §15.109 (a) (b) .....  | 13 |
| Table 11. Radiated Emissions Limits, Test Results, 30 MHz – 1 GHz, FCC Limits .....   | 14 |
| Table 12. Radiated Emissions Limits, Test Results, Above 1 GHz, FCC Limits.....   | 15 |
| Table 13. Radiated Emissions Limits, Test Results, ICES-003 Limits .....  | 16 |
| Table 14. Conducted Limits for Intentional Radiators from FCC Part 15 § 15.207(a) .....   | 19 |
| Table 15. Conducted Emissions, 15.207(a), Phase Line, Test Results .....  | 20 |
| Table 16. Conducted Emissions, 15.207(a), Neutral Line, Test Results .....  | 21 |
| Table 17. 6 dB Occupied Bandwidth, Test Results .....   | 23 |
| Table 18. 99% Occupied Bandwidth, Test Results .....  | 24 |
| Table 19. Output Power Requirements from §15.247(b) .....   | 39 |
| Table 20. Peak Power Output, Test Results .....   | 40 |
| Table 21. Summed Peak Conducted Output Power, Test Results .....  | 40 |
| Table 22. Restricted Bands of Operation.....  | 48 |
| Table 23. Radiated Emissions Limits Calculated from FCC Part 15, § 15.209 (a) .....   | 49 |
| Table 24. Peak Power Spectral Density, Test Results .....   | 89 |
| Table 25. Spurious Emission Limits for Receivers .....  | 94 |
| Table 26. Test Equipment List .....   | 98 |

## List of Plots

|  |    |
|--|----|
| Plot 1. Conducted Emission, Phase Line Plot .....                            | 11 |
| Plot 2. Conducted Emission, Neutral Line Plot.....                           | 12 |
| Plot 3. Radiated Emissions, 30 MHz - 1 GHz, FCC Limits .....                 | 14 |
| Plot 4. Radiated Emissions, Above 1 GHz, FCC Limits .....                    | 15 |
| Plot 5. Radiated Emissions, ICES-003 Limits.....                             | 16 |
| Plot 6. Conducted Emissions, 15.207(a), Phase Line .....                     | 20 |
| Plot 7. Conducted Emissions, 15.207(a), Neutral Line .....                   | 21 |
| Plot 8. 6 dB Occupied Bandwidth, Low Channel, 802.11a .....                  | 25 |
| Plot 9. 6 dB Occupied Bandwidth, Mid Channel, 802.11a.....                   | 25 |
| Plot 10. 6 dB Occupied Bandwidth, High Channel, 802.11a .....                | 25 |
| Plot 11. 6 dB Occupied Bandwidth, Low Channel, 802.11n 20 MHz, Port 0 .....  | 26 |
| Plot 12. 6 dB Occupied Bandwidth, Mid Channel, 802.11n 20 MHz, Port 0.....   | 26 |
| Plot 13. 6 dB Occupied Bandwidth, High Channel, 802.11n 20 MHz, Port 0 ..... | 26 |
| Plot 14. 6 dB Occupied Bandwidth, Low Channel, 802.11n 20 MHz, Port 1 .....  | 27 |
| Plot 15. 6 dB Occupied Bandwidth, Mid Channel, 802.11n 20 MHz, Port 1.....   | 27 |
| Plot 16. 6 dB Occupied Bandwidth, High Channel, 802.11n 20 MHz, Port 1 ..... | 27 |
| Plot 17. 6 dB Occupied Bandwidth, Low Channel, 802.11n 20 MHz, Port 2 .....  | 28 |
| Plot 18. 6 dB Occupied Bandwidth, Mid Channel, 802.11n 20 MHz, Port 2.....   | 28 |
| Plot 19. 6 dB Occupied Bandwidth, High Channel, 802.11n 20 MHz, Port 2 ..... | 28 |
| Plot 20. 6 dB Occupied Bandwidth, Low Channel, 802.11n 40 MHz, Port 0 .....  | 29 |

|   |    |
|---|----|
| Plot 21. 6 dB Occupied Bandwidth, High Channel, 802.11n 40 MHz, Port 0 .....              | 29 |
| Plot 22. 6 dB Occupied Bandwidth, Low Channel, 802.11n 40 MHz, Port 1 .....               | 30 |
| Plot 23. 6 dB Occupied Bandwidth, High Channel, 802.11n 40 MHz, Port 1 .....              | 30 |
| Plot 24. 6 dB Occupied Bandwidth, Low Channel, 802.11n 40 MHz, Port 2 .....               | 31 |
| Plot 25. 6 dB Occupied Bandwidth, High Channel, 802.11n 40 MHz, Port 2 .....              | 31 |
| Plot 26. 99% Occupied Bandwidth, Low Channel, 802.11a .....                               | 32 |
| Plot 27. 99% Occupied Bandwidth, Mid Channel, 802.11a .....                               | 32 |
| Plot 28. 99% Occupied Bandwidth, High Channel, 802.11a .....                              | 32 |
| Plot 29. 99% Occupied Bandwidth, Low Channel, 802.11n 20 MHz, Port 0 .....                | 33 |
| Plot 30. 99% Occupied Bandwidth, Mid Channel, 802.11n 20 MHz, Port 0 .....                | 33 |
| Plot 31. 99% Occupied Bandwidth, High Channel, 802.11n 20 MHz, Port 0 .....               | 33 |
| Plot 32. 99% Occupied Bandwidth, Low Channel, 802.11n 20 MHz, Port 1 .....                | 34 |
| Plot 33. 99% Occupied Bandwidth, Mid Channel, 802.11n 20 MHz, Port 1 .....                | 34 |
| Plot 34. 99% Occupied Bandwidth, High Channel, 802.11n 20 MHz, Port 1 .....               | 34 |
| Plot 35. 99% Occupied Bandwidth, Low Channel, 802.11n 20 MHz, Port 2 .....                | 35 |
| Plot 36. 99% Occupied Bandwidth, Mid Channel, 802.11n 20 MHz, Port 2 .....                | 35 |
| Plot 37. 99% Occupied Bandwidth, High Channel, 802.11n 20 MHz, Port 2 .....               | 35 |
| Plot 38. 99% Occupied Bandwidth, Low Channel, 802.11n 40 MHz, Port 0 .....                | 36 |
| Plot 39. 99% Occupied Bandwidth, High Channel, 802.11n 40 MHz, Port 0 .....               | 36 |
| Plot 40. 99% Occupied Bandwidth, Low Channel, 802.11n 40 MHz, Port 1 .....                | 37 |
| Plot 41. 99% Occupied Bandwidth, High Channel, 802.11n 40 MHz, Port 1 .....               | 37 |
| Plot 42. 99% Occupied Bandwidth, Low Channel, 802.11n 40 MHz, Port 2 .....                | 38 |
| Plot 43. 99% Occupied Bandwidth, High Channel, 802.11n 40 MHz, Port 2 .....               | 38 |
| Plot 44. Peak Power Output, Low Channel, 802.11a .....                                    | 41 |
| Plot 45. Peak Power Output, Mid Channel, 802.11a .....                                    | 41 |
| Plot 46. Peak Power Output, High Channel, 802.11a .....                                   | 41 |
| Plot 47. Peak Power Output, Low Channel, 802.11n 20 MHz, Port 0 .....                     | 42 |
| Plot 48. Peak Power Output, Mid Channel, 802.11n 20 MHz, Port 0 .....                     | 42 |
| Plot 49. Peak Power Output, High Channel, 802.11n 20 MHz, Port 0 .....                    | 42 |
| Plot 50. Peak Power Output, Low Channel, 802.11n 20 MHz, Port 1 .....                     | 43 |
| Plot 51. Peak Power Output, Mid Channel, 802.11n 20 MHz, Port 1 .....                     | 43 |
| Plot 52. Peak Power Output, High Channel, 802.11n 20 MHz, Port 1 .....                    | 43 |
| Plot 53. Peak Power Output, Low Channel, 802.11n 20 MHz, Port 2 .....                     | 44 |
| Plot 54. Peak Power Output, Mid Channel, 802.11n 20 MHz, Port 2 .....                     | 44 |
| Plot 55. Peak Power Output, High Channel, 802.11n 20 MHz, Port 2 .....                    | 44 |
| Plot 56. Peak Power Output, Low Channel, 802.11n 40 MHz, Port 0 .....                     | 45 |
| Plot 57. Peak Power Output, High Channel, 802.11n 40 MHz, Port 0 .....                    | 45 |
| Plot 58. Peak Power Output, Low Channel, 802.11n 40 MHz, Port 1 .....                     | 46 |
| Plot 59. Peak Power Output, High Channel, 802.11n 40 MHz, Port 1 .....                    | 46 |
| Plot 60. Peak Power Output, Low Channel, 802.11n 40 MHz, Port 2 .....                     | 47 |
| Plot 61. Peak Power Output, High Channel, 802.11n 40 MHz, Port 2 .....                    | 47 |
| Plot 62. Radiated Spurious Emissions, Radio OFF .....                                     | 49 |
| Plot 63. Radiated Spurious Emissions, Low Channel, 802.11a, 30 MHz – 1 GHz .....          | 50 |
| Plot 64. Radiated Spurious Emissions, Low Channel, 802.11a, 1 GHz – 7 GHz, Average .....  | 50 |
| Plot 65. Radiated Spurious Emissions, Low Channel, 802.11a, 1 GHz – 7 GHz, Peak .....     | 50 |
| Plot 66. Radiated Spurious Emissions, Low Channel, 802.11a, 7 GHz – 18 GHz, Average ..... | 51 |
| Plot 67. Radiated Spurious Emissions, Low Channel, 802.11a, 7 GHz – 18 GHz, Peak .....    | 51 |
| Plot 68. Radiated Spurious Emissions, Mid Channel, 802.11a, 30 MHz – 1 GHz .....          | 51 |
| Plot 69. Radiated Spurious Emissions, Mid Channel, 802.11a, 1 GHz – 7 GHz, Average .....  | 52 |
| Plot 70. Radiated Spurious Emissions, Mid Channel, 802.11a, 1 GHz – 7 GHz, Peak .....     | 52 |
| Plot 71. Radiated Spurious Emissions, Mid Channel, 802.11a, 7 GHz – 18 GHz, Average ..... | 52 |
| Plot 72. Radiated Spurious Emissions, Mid Channel, 802.11a, 7 GHz – 18 GHz, Peak .....    | 53 |
| Plot 73. Radiated Spurious Emissions, High Channel, 802.11a, 30 MHz – 1 GHz .....         | 53 |

|   |    |
|---|----|
| Plot 74. Radiated Spurious Emissions, High Channel, 802.11a, 1 GHz – 7 GHz, Average.....              | 53 |
| Plot 75. Radiated Spurious Emissions, High Channel, 802.11a, 1 GHz – 7 GHz, Peak .....                | 54 |
| Plot 76. Radiated Spurious Emissions, High Channel, 802.11a, 7 GHz – 18 GHz, Average.....             | 54 |
| Plot 77. Radiated Spurious Emissions, High Channel, 802.11a, 7 GHz – 18 GHz, Peak .....               | 54 |
| Plot 78. Radiated Spurious Emissions, Low Channel, 802.11n 20 MHz, 30 MHz – 1 GHz.....                | 55 |
| Plot 79. Radiated Spurious Emissions, Low Channel, 802.11n 20 MHz, 1 GHz – 7 GHz, Average .....       | 55 |
| Plot 80. Radiated Spurious Emissions, Low Channel, 802.11n 20 MHz, 1 GHz – 7 GHz, Peak .....          | 55 |
| Plot 81. Radiated Spurious Emissions, Low Channel, 802.11n 20 MHz, 7 GHz – 18 GHz, Average .....      | 56 |
| Plot 82. Radiated Spurious Emissions, Low Channel, 802.11n 20 MHz, 7 GHz – 18 GHz, Peak .....         | 56 |
| Plot 83. Radiated Spurious Emissions, Mid Channel, 802.11n 20 MHz, 30 MHz – 1 GHz .....               | 56 |
| Plot 84. Radiated Spurious Emissions, Mid Channel, 802.11n 20 MHz, 1 GHz – 7 GHz, Average.....        | 57 |
| Plot 85. Radiated Spurious Emissions, Mid Channel, 802.11n 20 MHz, 1 GHz – 7 GHz, Peak .....          | 57 |
| Plot 86. Radiated Spurious Emissions, Mid Channel, 802.11n 20 MHz, 7 GHz – 18 GHz, Average.....       | 57 |
| Plot 87. Radiated Spurious Emissions, Mid Channel, 802.11n 20 MHz, 7 GHz – 18 GHz, Peak .....         | 58 |
| Plot 88. Radiated Spurious Emissions, High Channel, 802.11n 20 MHz, 30 MHz – 1 GHz .....              | 58 |
| Plot 89. Radiated Spurious Emissions, High Channel, 802.11n 20 MHz, 1 GHz – 7 GHz, Average .....      | 58 |
| Plot 90. Radiated Spurious Emissions, High Channel, 802.11n 20 MHz, 1 GHz – 7 GHz, Peak .....         | 59 |
| Plot 91. Radiated Spurious Emissions, High Channel, 802.11n 20 MHz, 7 GHz – 18 GHz, Average .....     | 59 |
| Plot 92. Radiated Spurious Emissions, High Channel, 802.11n 20 MHz, 7 GHz – 18 GHz, Peak .....        | 59 |
| Plot 93. Radiated Spurious Emissions, Low Channel, 802.11n 40 MHz, 30 MHz – 1 GHz.....                | 60 |
| Plot 94. Radiated Spurious Emissions, Low Channel, 802.11n 40 MHz, 1 GHz – 7 GHz, Average .....       | 60 |
| Plot 95. Radiated Spurious Emissions, Low Channel, 802.11n 40 MHz, 1 GHz – 7 GHz, Peak .....          | 60 |
| Plot 96. Radiated Spurious Emissions, Low Channel, 802.11n 40 MHz, 7 GHz – 18 GHz, Average .....      | 61 |
| Plot 97. Radiated Spurious Emissions, Low Channel, 802.11n 40 MHz, 7 GHz – 18 GHz, Peak.....          | 61 |
| Plot 98. Radiated Spurious Emissions, High Channel, 802.11n 40 MHz, 30 MHz – 1 GHz .....              | 61 |
| Plot 99. Radiated Spurious Emissions, High Channel, 802.11n 40 MHz, 1 GHz – 7 GHz, Average .....      | 62 |
| Plot 100. Radiated Spurious Emissions, High Channel, 802.11n 40 MHz, 1 GHz – 7 GHz, Peak .....        | 62 |
| Plot 101. Radiated Spurious Emissions, High Channel, 802.11n 40 MHz, 7 GHz – 18 GHz, Average .....    | 62 |
| Plot 102. Radiated Spurious Emissions, High Channel, 802.11n 40 MHz, 7 GHz – 18 GHz, Peak .....       | 63 |
| Plot 103. Conducted Spurious Emissions, Low Channel, 802.11a, 30 MHz – 1 GHz .....                    | 65 |
| Plot 104. Conducted Spurious Emissions, Low Channel, 802.11a, 1 GHz – 26.5 GHz.....                   | 65 |
| Plot 105. Conducted Spurious Emissions, Low Channel, 802.11a, 26.5 GHz – 40 GHz.....                  | 65 |
| Plot 106. Conducted Spurious Emissions, Mid Channel, 802.11a, 30 MHz – 1 GHz.....                     | 66 |
| Plot 107. Conducted Spurious Emissions, Mid Channel, 802.11a, 1 GHz – 26.5 GHz .....                  | 66 |
| Plot 108. Conducted Spurious Emissions, Mid Channel, 802.11a, 26.5 GHz – 40 GHz .....                 | 66 |
| Plot 109. Conducted Spurious Emissions, High Channel, 802.11a, 30 MHz – 1 GHz .....                   | 67 |
| Plot 110. Conducted Spurious Emissions, High Channel, 802.11a, 1 GHz – 26.5 GHz .....                 | 67 |
| Plot 111. Conducted Spurious Emissions, High Channel, 802.11a, 26.5 GHz – 40 GHz .....                | 67 |
| Plot 112. Conducted Spurious Emissions, Low Channel, 802.11n 20 MHz, Port 0, 30 MHz – 1 GHz .....     | 68 |
| Plot 113. Conducted Spurious Emissions, Low Channel, 802.11n 20 MHz, Port 0, 1 GHz – 26.5 GHz.....    | 68 |
| Plot 114. Conducted Spurious Emissions, Low Channel, 802.11n 20 MHz, Port 0, 26.5 GHz – 40 GHz.....   | 68 |
| Plot 115. Conducted Spurious Emissions, Mid Channel, 802.11n 20 MHz, Port 0, 30 MHz – 1 GHz.....      | 69 |
| Plot 116. Conducted Spurious Emissions, Mid Channel, 802.11n 20 MHz, Port 0, 1 GHz – 26.5 GHz.....    | 69 |
| Plot 117. Conducted Spurious Emissions, Mid Channel, 802.11n 20 MHz, Port 0, 26.5 GHz – 40 GHz.....   | 69 |
| Plot 118. Conducted Spurious Emissions, High Channel, 802.11n 20 MHz, Port 0, 30 MHz – 1 GHz.....     | 70 |
| Plot 119. Conducted Spurious Emissions, High Channel, 802.11n 20 MHz, Port 0, 1 GHz – 26.5 GHz .....  | 70 |
| Plot 120. Conducted Spurious Emissions, High Channel, 802.11n 20 MHz, Port 0, 26.5 GHz – 40 GHz ..... | 70 |
| Plot 121. Conducted Spurious Emissions, Low Channel, 802.11n 20 MHz, Port 1, 30 MHz – 1 GHz .....     | 71 |
| Plot 122. Conducted Spurious Emissions, Low Channel, 802.11n 20 MHz, Port 1, 1 GHz – 26.5 GHz.....    | 71 |
| Plot 123. Conducted Spurious Emissions, Low Channel, 802.11n 20 MHz, Port 1, 26.5 GHz – 40 GHz.....   | 71 |
| Plot 124. Conducted Spurious Emissions, Mid Channel, 802.11n 20 MHz, Port 1, 30 MHz – 1 GHz.....      | 72 |
| Plot 125. Conducted Spurious Emissions, Mid Channel, 802.11n 20 MHz, Port 1, 1 GHz – 26.5 GHz.....    | 72 |
| Plot 126. Conducted Spurious Emissions, Mid Channel, 802.11n 20 MHz, Port 1, 26.5 GHz – 40 GHz.....   | 72 |



|   |    |
|---|----|
| Plot 127. Conducted Spurious Emissions, High Channel, 802.11n 20 MHz, Port 1, 30 MHz – 1 GHz.....     | 73 |
| Plot 128. Conducted Spurious Emissions, High Channel, 802.11n 20 MHz, Port 1, 1 GHz – 26.5 GHz .....  | 73 |
| Plot 129. Conducted Spurious Emissions, High Channel, 802.11n 20 MHz, Port 1, 26.5 GHz – 40 GHz ..... | 73 |
| Plot 130. Conducted Spurious Emissions, Low Channel, 802.11n 20 MHz, Port 2, 30 MHz – 1 GHz.....      | 74 |
| Plot 131. Conducted Spurious Emissions, Low Channel, 802.11n 20 MHz, Port 2, 1 GHz – 26.5 GHz.....    | 74 |
| Plot 132. Conducted Spurious Emissions, Low Channel, 802.11n 20 MHz, Port 2, 26.5 GHz – 40 GHz.....   | 74 |
| Plot 133. Conducted Spurious Emissions, Mid Channel, 802.11n 20 MHz, Port 2, 30 MHz – 1 GHz.....      | 75 |
| Plot 134. Conducted Spurious Emissions, Mid Channel, 802.11n 20 MHz, Port 2, 1 GHz – 26.5 GHz.....    | 75 |
| Plot 135. Conducted Spurious Emissions, Mid Channel, 802.11n 20 MHz, Port 2, 26.5 GHz – 40 GHz.....   | 75 |
| Plot 136. Conducted Spurious Emissions, High Channel, 802.11n 20 MHz, Port 2, 30 MHz – 1 GHz.....     | 76 |
| Plot 137. Conducted Spurious Emissions, High Channel, 802.11n 20 MHz, Port 2, 1 GHz – 26.5 GHz .....  | 76 |
| Plot 138. Conducted Spurious Emissions, High Channel, 802.11n 20 MHz, Port 2, 26.5 GHz – 40 GHz ..... | 76 |
| Plot 139. Conducted Spurious Emissions, Low Channel, 802.11n 40 MHz, Port 0, 30 MHz – 1 GHz .....     | 77 |
| Plot 140. Conducted Spurious Emissions, Low Channel, 802.11n 40 MHz, Port 0, 1 GHz – 26.5 GHz.....    | 77 |
| Plot 141. Conducted Spurious Emissions, Low Channel, 802.11n 40 MHz, Port 0, 26.5 GHz – 40 GHz.....   | 77 |
| Plot 142. Conducted Spurious Emissions, High Channel, 802.11n 40 MHz, Port 0, 30 MHz – 1 GHz.....     | 78 |
| Plot 143. Conducted Spurious Emissions, High Channel, 802.11n 40 MHz, Port 0, 1 GHz – 26.5 GHz .....  | 78 |
| Plot 144. Conducted Spurious Emissions, High Channel, 802.11n 40 MHz, Port 0, 26.5 GHz – 40 GHz ..... | 78 |
| Plot 145. Conducted Spurious Emissions, Low Channel, 802.11n 40 MHz, Port 1, 30 MHz – 1 GHz .....     | 79 |
| Plot 146. Conducted Spurious Emissions, Low Channel, 802.11n 40 MHz, Port 1, 1 GHz – 26.5 GHz.....    | 79 |
| Plot 147. Conducted Spurious Emissions, Low Channel, 802.11n 40 MHz, Port 1, 26.5 GHz – 40 GHz.....   | 79 |
| Plot 148. Conducted Spurious Emissions, High Channel, 802.11n 40 MHz, Port 1, 30 MHz – 1 GHz.....     | 80 |
| Plot 149. Conducted Spurious Emissions, High Channel, 802.11n 40 MHz, Port 1, 1 GHz – 26.5 GHz .....  | 80 |
| Plot 150. Conducted Spurious Emissions, High Channel, 802.11n 40 MHz, Port 1, 26.5 GHz – 40 GHz ..... | 80 |
| Plot 151. Conducted Spurious Emissions, Low Channel, 802.11n 40 MHz, Port 2, 30 MHz – 1 GHz .....     | 81 |
| Plot 152. Conducted Spurious Emissions, Low Channel, 802.11n 40 MHz, Port 2, 1 GHz – 26.5 GHz.....    | 81 |
| Plot 153. Conducted Spurious Emissions, Low Channel, 802.11n 40 MHz, Port 2, 26.5 GHz – 40 GHz.....   | 81 |
| Plot 154. Conducted Spurious Emissions, High Channel, 802.11n 40 MHz, Port 2, 30 MHz – 1 GHz.....     | 82 |
| Plot 155. Conducted Spurious Emissions, High Channel, 802.11n 40 MHz, Port 2, 1 GHz – 26.5 GHz .....  | 82 |
| Plot 156. Conducted Spurious Emissions, High Channel, 802.11n 40 MHz, Port 2, 26.5 GHz – 40 GHz ..... | 82 |
| Plot 157. Conducted Band Edge, Low Channel, 802.11a .....   | 83 |
| Plot 158. Conducted Band Edge, High Channel, 802.11a.....   | 83 |
| Plot 159. Conducted Band Edge, Low Channel, 802.11n 20 MHz, Port 0.....                               | 83 |
| Plot 160. Conducted Band Edge, High Channel, 802.11n 20 MHz, Port 0.....                              | 84 |
| Plot 161. Conducted Band Edge, Low Channel, 802.11n 20 MHz, Port 1.....                               | 84 |
| Plot 162. Conducted Band Edge, High Channel, 802.11n 20 MHz, Port 1.....                              | 84 |
| Plot 163. Conducted Band Edge, Low Channel, 802.11n 20 MHz, Port 2.....                               | 85 |
| Plot 164. Conducted Band Edge, High Channel, 802.11n 20 MHz, Port 2.....                              | 85 |
| Plot 165. Conducted Band Edge, Low Channel, 802.11n 40 MHz, Port 0.....                               | 85 |
| Plot 166. Conducted Band Edge, High Channel, 802.11n 40 MHz, Port 0.....                              | 86 |
| Plot 167. Conducted Band Edge, Low Channel, 802.11n 40 MHz, Port 1.....                               | 86 |
| Plot 168. Conducted Band Edge, High Channel, 802.11n 40 MHz, Port 1.....                              | 86 |
| Plot 169. Conducted Band Edge, Low Channel, 802.11n 40 MHz, Port 2.....                               | 87 |
| Plot 170. Conducted Band Edge, High Channel, 802.11n 40 MHz, Port 2.....                              | 87 |
| Plot 171. Peak Power Spectral Density, Low Channel, 802.11a.....                                      | 90 |
| Plot 172. Peak Power Spectral Density, Mid Channel, 802.11a.....                                      | 90 |
| Plot 173. Peak Power Spectral Density, High Channel, 802.11a.....                                     | 90 |
| Plot 174. Peak Power Spectral Density, Low Channel, 802.11n 20 MHz.....                               | 91 |
| Plot 175. Peak Power Spectral Density, Mid Channel, 802.11n 20 MHz.....                               | 91 |
| Plot 176. Peak Power Spectral Density, High Channel, 802.11n 20 MHz.....                              | 91 |
| Plot 177. Peak Power Spectral Density, Low Channel, 802.11n 40 MHz.....                               | 92 |
| Plot 178. Peak Power Spectral Density, High Channel, 802.11n 40 MHz.....                              | 92 |
| Plot 179. Receiver Spurious Emission, 30 MHz – 1 GHz, Port 0.....                                     | 95 |

|  |    |
|--|----|
| Plot 180. Receiver Spurious Emission, 1 GHz – 18 GHz, Port 0 ..... | 95 |
| Plot 181. Receiver Spurious Emission, 30 MHz – 1 GHz, Port 1 ..... | 95 |
| Plot 182. Receiver Spurious Emission, 1 GHz – 18 GHz, Port 1 ..... | 96 |
| Plot 183. Receiver Spurious Emission, 30 MHz – 1 GHz, Port 2 ..... | 96 |
| Plot 184. Receiver Spurious Emission, 1 GHz – 18 GHz, Port 2 ..... | 96 |

## List of Figures

|   |    |
|---|----|
| Figure 1. Block Diagram of Test Configuration.....                              | 6  |
| Figure 2. Block Diagram, Occupied Bandwidth Test Setup.....                     | 22 |
| Figure 3. Peak Power Output Test Setup.....                                     | 39 |
| Figure 4. Block Diagram, Conducted Spurious Emissions Test Setup.....           | 64 |
| Figure 5. Block Diagram, Peak Power Spectral Density Test Setup .....           | 88 |
| Figure 6. Block Diagram, Conducted Receiver Spurious Emissions Test Setup ..... | 94 |

## List of Terms and Abbreviations

|              |   |
|--------------|---|
| AC           | Alternating Current                           |
| ACF          | Antenna Correction Factor                     |
| Cal          | Calibration                                   |
| <i>d</i>     | Measurement Distance                          |
| dB           | Decibels                                      |
| dB $\mu$ A   | Decibels above one <b>microamp</b>            |
| dB $\mu$ V   | Decibels above one <b>microvolt</b>           |
| dB $\mu$ A/m | Decibels above one <b>microamp per meter</b>  |
| dB $\mu$ V/m | Decibels above one <b>microvolt per meter</b> |
| DC           | Direct Current                                |
| E            | Electric Field                                |
| DSL          | Digital Subscriber Line                       |
| ESD          | Electrostatic Discharge                       |
| EUT          | Equipment Under Test                          |
| <i>f</i>     | Frequency                                     |
| FCC          | Federal Communications Commission             |
| GRP          | Ground Reference Plane                        |
| H            | Magnetic Field                                |
| HCP          | Horizontal Coupling Plane                     |
| Hz           | Hertz   |
| IEC          | International Electrotechnical Commission     |
| kHz          | kilohertz                                     |
| kPa          | kilopascal                                    |
| kV           | kilovolt                                      |
| LISN         | Line Impedance Stabilization Network          |
| MHz          | Megahertz                                     |
| $\mu$ H      | microhenry                                    |
| $\mu$        | microfarad                                    |
| $\mu$ s      | microseconds                                  |
| NEBS         | Network Equipment-Building System             |
| PRF          | Pulse Repetition Frequency                    |
| RF           | Radio Frequency                               |
| RMS          | Root-Mean-Square                              |
| TWT          | Traveling Wave Tube                           |
| V/m          | Volts per meter                               |
| VCP          | Vertical Coupling Plane                       |

# I. Executive Summary

## A. Purpose of Test

An EMC evaluation was performed to determine compliance of the Ubiquiti Networks, Inc. PowerBridgeM5X3, with the requirements of Part 15, §15.247. All references are to the most current version of Title 47 of the Code of Federal Regulations in effect. In accordance with §2.1033, the following data is presented in support of the Certification of the PowerBridgeM5X3. Ubiquiti Networks, Inc. should retain a copy of this document which should be kept on file for at least two years after the manufacturing of the PowerBridgeM5X3, has been **permanently** discontinued.

## B. Executive Summary

The following tests were conducted on a sample of the equipment for the purpose of demonstrating compliance with Part 15, §15.247, in accordance with Ubiquiti Networks, Inc., purchase order number US100208. All tests were conducted using measurement procedure ANSI C63.4-2003.

| FCC Reference<br>47 CFR Part 15.247:2005                     | IC Reference<br>RSS-210 Issue 8: 2010;<br>RSS-GEN Issue 3: 2010 | Description   | Compliance |
|--|---|---|------------|
| 47 CFR Part 15.107 (a)                                       | ICES-003 Issue 4<br>February 2004                               | Conducted Emission Limits for a<br>Class A Digital Device | Compliant  |
| 47 CFR Part 15.109 (a)                                       | ICES-003 Issue 4<br>February 2004                               | Radiated Emission Limits for a Class<br>A Digital Device  | Compliant  |
| Title 47 of the CFR, Part 15<br>§15.203                      | N/A   | Antenna Requirement                                       | Compliant  |
| Title 47 of the CFR, Part 15<br>§15.207(a)                   | RSS-GEN (7.2.4)   | Conducted Emission Limits                                 | Compliant  |
| Title 47 of the CFR, Part 15<br>§15.247(a)(2)                | RSS-Gen(4.6)  | 6dB Occupied Bandwidth                                    | Compliant  |
|  |   | 99% Occupied Bandwidth                                    | Compliant  |
| Title 47 of the CFR, Part 15<br>§15.247(b)                   | RSS-210(A8.4)   | Peak Power Output   | Compliant  |
| Title 47 of the CFR, Part 15<br>§15.247(d); §15.209; §15.205 | RSS-210(A8.5)   | Radiated Spurious Emissions<br>Requirements               | Compliant  |
| Title 47 of the CFR, Part 15<br>§15.247(d)                   | RSS-210(A8.5)   | RF Conducted Spurious Emissions<br>Requirements           | Compliant  |
| Title 47 of the CFR, Part 15<br>§15.247(d)                   | RSS-210(A8.5)   | RF Conducted Band Edge                                    | Compliant  |
| Title 47 of the CFR, Part 15;<br>§15.247(e)                  | RSS-210(A8.2)   | Peak Power Spectral Density                               | Compliant  |
| Title 47 of the CFR, Part 15<br>§15.247(i)                   | RSS-Gen(5.6)  | Maximum Permissible Exposure<br>(MPE)                     | Compliant  |
| N/A  | RSS-Gen(4.10)   | Receiver Spurious Emissions                               | Compliant  |

**Table 1. Executive Summary of EMC Part 15.247 Compliance Testing**

## II. Equipment Configuration

## A. Overview

MET Laboratories, Inc. was contracted by Ubiquiti Networks, Inc. to perform testing on the PowerBridgeM5X3, under Ubiquiti Networks, Inc.'s purchase order number US100208.

This document describes the test setups, test methods, required test equipment, and the test limit criteria used to perform compliance testing of the Ubiquiti Networks, Inc., PowerBridgeM5X3.

The results obtained relate only to the item(s) tested.

|                                       |   |  |
|---------------------------------------|---|--|
| <b>Model(s) Tested:</b>               | PowerBridgeM5X3   |  |
| <b>Model(s) Covered:</b>              | PowerBridgeM5X3   |  |
| <b>EUT Specifications:</b>            | Primary Power: 120 VAC, 60 Hz                           |  |
|                                       | FCC ID: SWX-M5PX3<br>IC: 6545A-M5PX3                    |  |
|                                       | Type of Modulations:                                    | OFDM   |
|                                       | Equipment Code:   | DTS  |
|                                       | Peak RF Output Power:                                   | a Mode – 16.08 dBm<br>HT20 – 18.50 dBm<br>HT40 – 18.58 dBm       |
|                                       | EUT Frequency Ranges:                                   | 5745 – 5825 MHz<br>5755 – 5795 MHz                               |
|                                       | 99% Occupied Bandwidth:                                 | a Mode – 16.8685 MHz<br>HT20 – 17.8257 MHz<br>HT40 – 36.8987 MHz |
|                                       | Antenna:  | Integral 25 dBi Panel  |
| <b>Analysis:</b>                      | The results obtained relate only to the item(s) tested. |  |
| <b>Environmental Test Conditions:</b> | Temperature: 15-35° C                                   |  |
|                                       | Relative Humidity: 30-60%                               |  |
|                                       | Barometric Pressure: 860-1060 mbar                      |  |
| <b>Evaluated by:</b>                  | Anderson Soungpanya                                     |  |
| <b>Report Date(s):</b>                | October 10, 2011  |  |

**Table 2. EUT Summary Table**



## B. References

|  |   |
|--|---|
| <b>CFR 47, Part 15, Subpart C</b>      | Federal Communication Commission, Code of Federal Regulations, Title 47, Part 15: General Rules and Regulations, Allocation, Assignment, and Use of Radio Frequencies |
| <b>CFR 47, Part 15, Subpart B</b>      | Electromagnetic Compatibility: Criteria for Radio Frequency Devices   |
| <b>RSS-210, Issue 8, Dec. 2010</b>     | Low-power Licence-exempt Radiocommunications Devices (All Frequency Bands): Category I Equipment  |
| <b>RSS-GEN, Issue 3, Dec. 2010</b>     | General Requirements and Information for the Certification of Radio Apparatus   |
| <b>ICES-003, Issue 4 February 2004</b> | Electromagnetic Compatibility: Criteria for Radio Frequency Devices   |
| <b>ANSI C63.4:2003</b>                 | Methods and Measurements of Radio-Noise Emissions from Low-Voltage Electrical And Electronic Equipment in the Range of 9 kHz to 40 GHz                                |
| <b>ANSI/NCSL Z540-1-1994</b>           | Calibration Laboratories and Measuring and Test Equipment - General Requirements  |
| <b>ANSI/ISO/IEC 17025:2000</b>         | General Requirements for the Competence of Testing and Calibration Laboratories   |
| <b>ANSI C63.10-2009</b>                | American National Standard for Testing Unlicensed Wireless Devices  |

**Table 3. References**

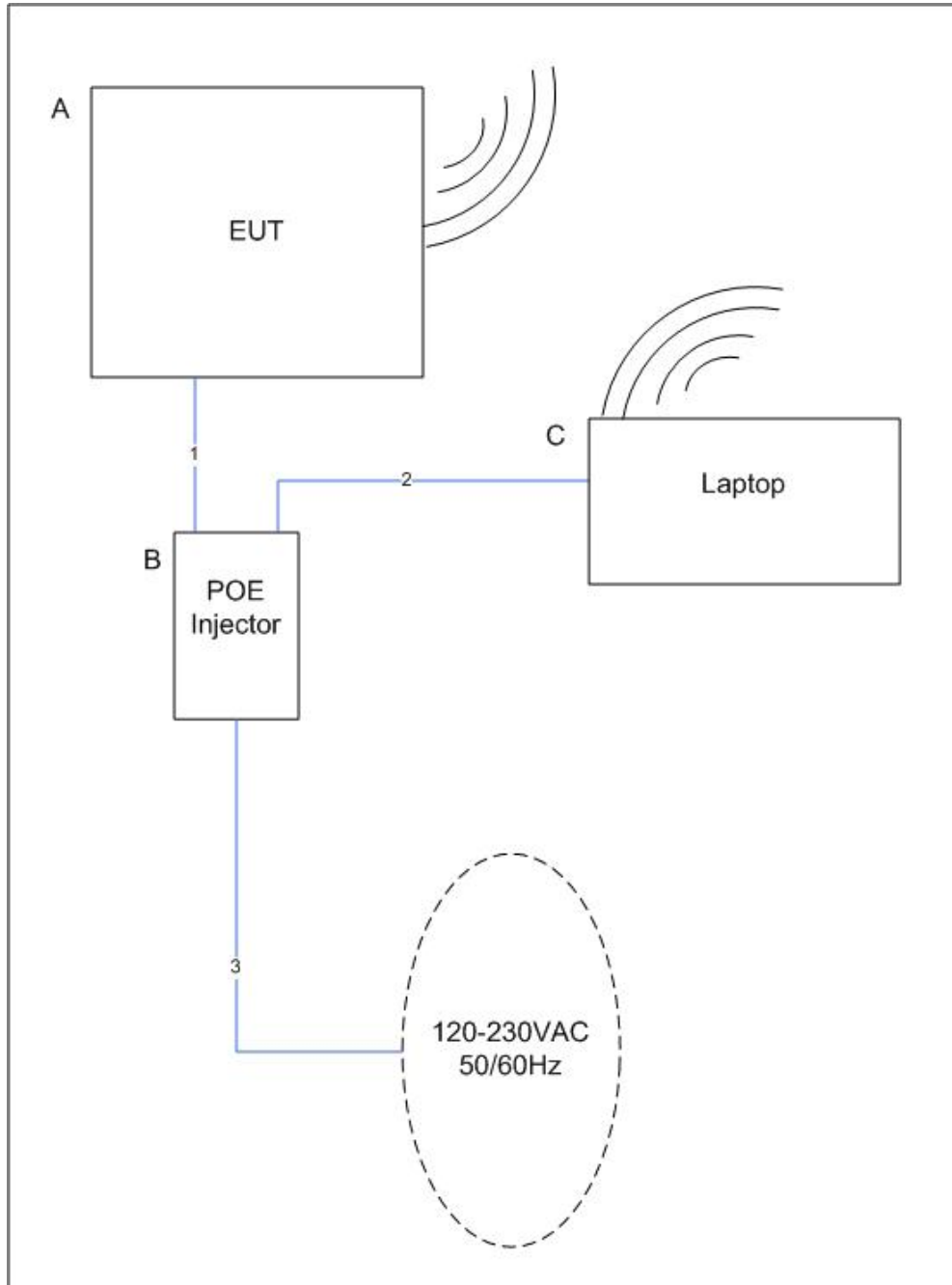
## C. Test Site

All testing was performed at MET Laboratories, Inc., 3162 Belick St., Santa Clara, CA 95054. All equipment used in making physical determinations is accurate and bears recent traceability to the National Institute of Standards and Technology.

Radiated Emissions measurements were performed in a 5 meter semi-anechoic chamber (equivalent to an Open Area Test Site). In accordance with §2.948(a)(3), a complete site description is contained at MET Laboratories.

### D. Description of Test Sample

The Ubiquiti Networks, Inc. PowerBridgeM5X3, Equipment Under Test (EUT), is an 802.11 a/n, 3x3 MIMO AirMax BaseStation.



**Figure 1. Block Diagram of Test Configuration**

## E. Equipment Configuration

The EUT was set up as outlined in Figure 1, Block Diagram of Test Setup. All cards, racks, etc., incorporated as part of the EUT is included in the following list.

| Ref. ID | Name / Description | Model Number | Part Number | Serial Number | Revision |
|---------|--------------------|--------------|-------------|---------------|----------|
| A       | Fixed a/n radio    | PBM5X3       | 11-00204-07 | EE09          | NA       |
| B       | PSU                | UBI-POE-48-5 | NA          | 1007-0002511  | NA       |

Table 4. Equipment Configuration

## F. Support Equipment

Support equipment necessary for the operation and testing of the EUT is included in the following list.

| Ref. ID | Name / Description | Manufacturer | Model Number | Serial Number |
|---------|--------------------|--------------|--------------|---------------|
| C       | Laptop             | Dell         | Vostro 1510  | 4953929473    |

Table 5. Support Equipment

## G. Ports and Cabling Information

| Ref. ID | Port Name on EUT       | Cable Description | Qty. | Length (m) | Shielded (Y/N) | Termination Point |
|---------|------------------------|-------------------|------|------------|----------------|-------------------|
| 1       | PowerBridgeM5x3 - Main | Ethernet          | 1    | 10         | Y              | PSU – POE port    |
| 1       | PSU - POE              | Ethernet          | 1    | 10         | Y              | Pbm5x3 - Main     |
| 2       | PSU - LAN              | Ethernet          | 1    | 10         | Y              | Laptop            |
| 3       | AC port                | AC Cable          | 1    | 0.5        | N              | 100-240VAC Source |

Table 6. Ports and Cabling Information

## **H. Method of Monitoring EUT Operation**

IP connectivity is maintained with the EUT. If IP connectivity is lost, EUT connectivity shall be re-established upon power up or re-boot.

## **I. Modifications**

### **a) Modifications to EUT**

No modifications were made to the EUT.

### **b) Modifications to Test Standard**

No modifications were made to the test standard.

## **J. Disposition of EUT**

The test sample including all support equipment submitted to the Electro-Magnetic Compatibility Lab for testing was returned to Ubiquiti Networks, Inc. upon completion of testing.

# **III. Electromagnetic Compatibility Criteria for Unintentional Radiators**

## Electromagnetic Compatibility Criteria

### § 15.107 Conducted Emissions Limits

**Test Requirement(s):** **15.107 (a)** Except for Class A digital devices, for equipment that is designed to be connected to the public utility (AC) power line, the radio frequency voltage that is conducted back onto the AC power line on any frequency or frequencies within the band 150 kHz to 30 MHz shall not exceed the limits in Table 7. Compliance with this provision shall be based on the measurement of the radio frequency voltage between each power line and ground at the power terminals.

**15.107 (b)** For a Class A digital device that is designed to be connected to the public utility (AC) power line, the radio frequency voltage that is conducted back onto the AC power line on any frequency or frequencies within the band 150 kHz to 30 MHz shall not exceed the limits in Table 7. Compliance with this provision shall be based on the measurement of the radio frequency voltage between each power line and ground at the power terminals. The lower limit applies at the band edges.

**15.207(a)**, Except as shown in paragraphs (b) and (c) of this section\*, charging, AC adapters or battery eliminators the radio frequency voltage that is conducted back onto the AC power line on any frequency or frequencies, within the band 150 kHz to 30 MHz, shall not exceed the limits in the Table 7, as measured using a 50  $\mu$ H/50 ohms line impedance stabilization network (LISN). Compliance with the provisions of this paragraph shall be based on the measurement of the radio frequency voltage between each power line and ground at the power terminal. The lower limit applies at the boundary between the frequencies ranges.

| Frequency range<br>(MHz) | Class A Conducted Limits<br>(dB $\mu$ V) |         | *Class B Conducted<br>Limits (dB $\mu$ V) |         |
|--------------------------|--|---------|---|---------|
|                          | Quasi-Peak                               | Average | Quasi-Peak                                | Average |
| * 0.15- 0.45             | 79                                       | 66      | 66 - 56                                   | 56 - 46 |
| 0.45 - 0.5               | 79                                       | 66      | 56  | 46      |
| 0.5 - 30                 | 73                                       | 60      | 60  | 50      |

Note 1 — The lower limit shall apply at the transition frequencies.  
 Note 2 — The limit decreases linearly with the logarithm if the frequency in the range 0.15 MHz to 0.5 MHz.  
 \* -- Limits per Subsection 15.207(a).

**Table 7. Conducted Limits for Radio Frequency Devices calculated from FCC Part 15 Subsections 15.107(a) (b) and 15.207(a)**

**Test Results:** The EUT was compliant with the Class A requirement(s) of this section. Measured emissions were below applicable limits.

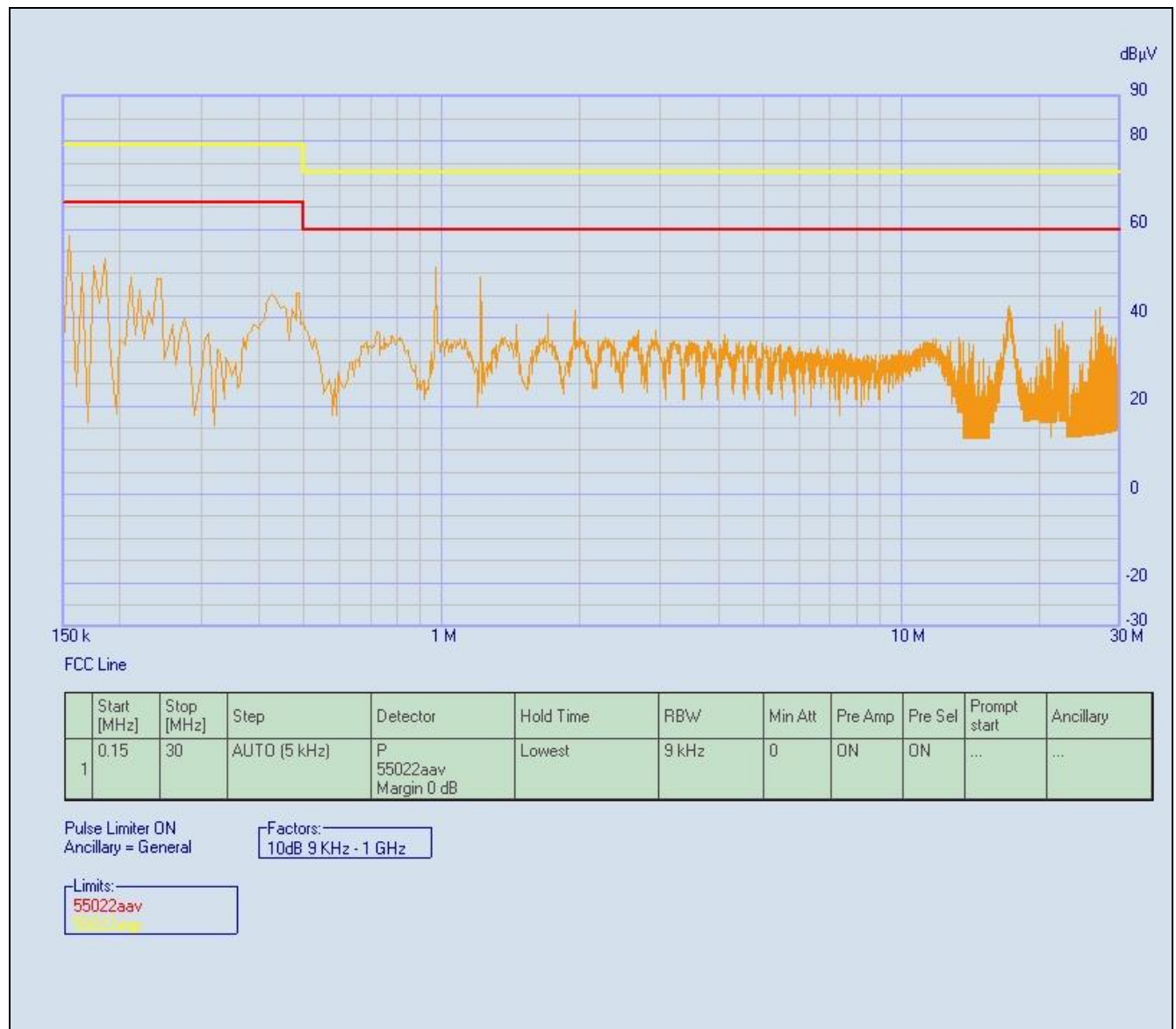
**Test Engineer(s):** Anderson Soungpanya

**Test Date(s):** 08/30/11

**Conducted Emissions - Voltage, AC Power, Phase Line (120 VAC, 60 Hz)**

| Line | Freq. (MHz) | QP Amplitude | QP Limit | Delta  | Pass | Average Amplitude | Average Limit | Delta  | Pass |
|------|-------------|--------------|----------|--------|------|-------------------|---------------|--------|------|
| Line | .155        | 55.1         | 79       | -23.9  | Pass | 35.84             | 66            | -30.16 | Pass |
| Line | .185        | 40.42        | 79       | -38.58 | Pass | 22.53             | 66            | -43.47 | Pass |
| Line | .975        | 50.75        | 73       | -22.25 | Pass | 49.73             | 60            | -10.27 | Pass |

**Table 8. Conducted Emissions - Voltage, AC Power, Phase Line (120 VAC, 60 Hz)**

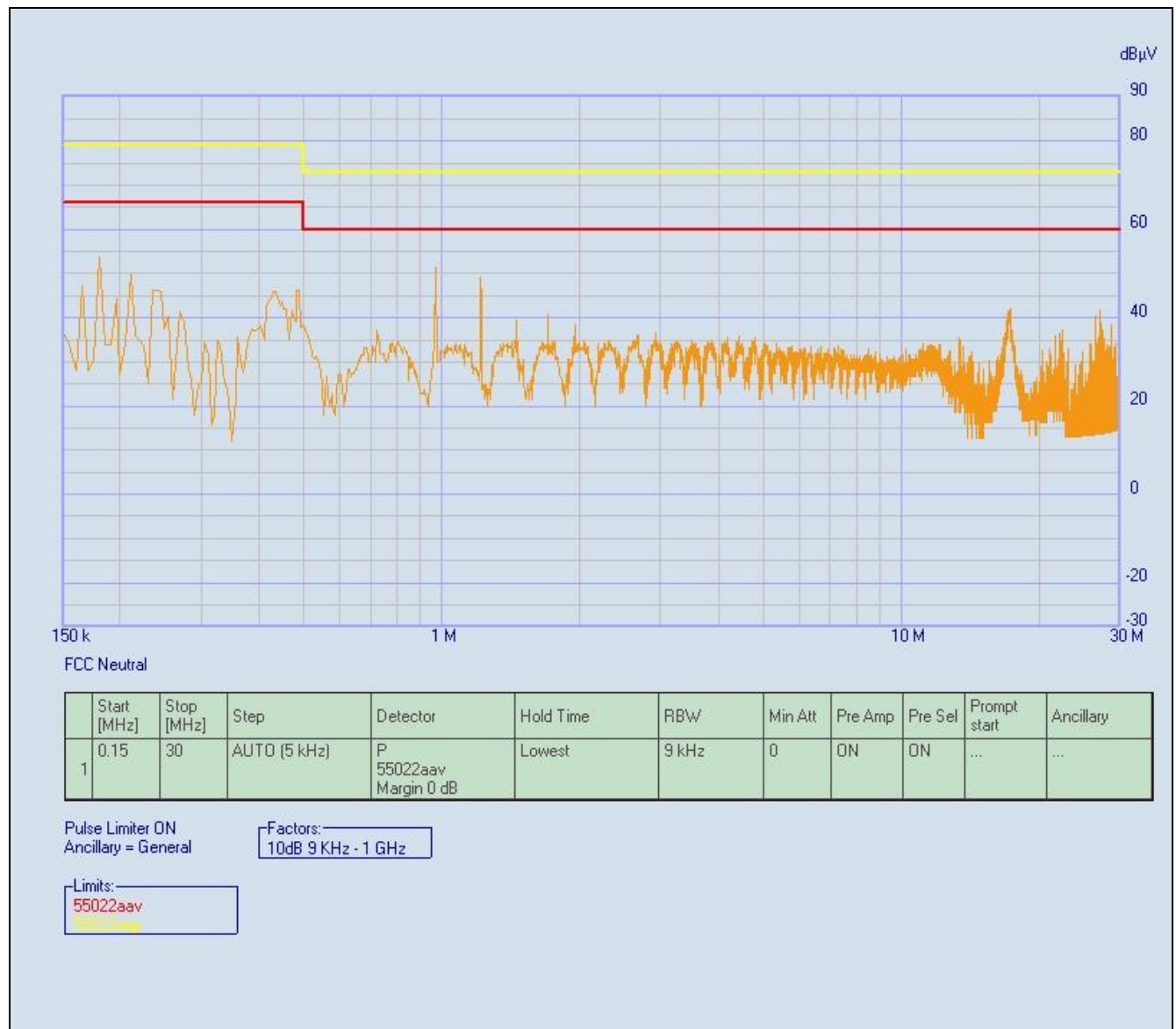


**Plot 1. Conducted Emission, Phase Line Plot**

**Conducted Emissions - Voltage, AC Power, Neutral Line (120 VAC, 60 Hz)**

| Line    | Freq. (MHz) | QP Amplitude | QP Limit | Delta  | Pass | Average Amplitude | Average Limit | Delta  | Pass |
|---------|-------------|--------------|----------|--------|------|-------------------|---------------|--------|------|
| Neutral | .18         | 50.2         | 79       | -28.8  | Pass | 33.29             | 66            | -32.71 | Pass |
| Neutral | .975        | 51.1         | 73       | -21.9  | Pass | 49.87             | 60            | -10.13 | Pass |
| Neutral | 1.215       | 48.65        | 73       | -24.35 | Pass | 47.66             | 60            | -12.34 | Pass |

**Table 9. Conducted Emissions - Voltage, AC Power, Neutral Line (120 VAC, 60 Hz)**



**Plot 2. Conducted Emission, Neutral Line Plot**



## Radiated Emission Limits

### § 15.109 Radiated Emissions Limits

**Test Requirement(s):** **15.109 (a)** Except for Class A digital devices, the field strength of radiated emissions from unintentional radiators at a distance of 3 meters shall not exceed the Class B limits expressed in Table 10.

**15.109 (b)** The field strength of radiated emissions from a Class A digital device, as determined at a distance of 10 meters, shall not exceed the Class A limits expressed in Table 10.

| Frequency (MHz) | Field Strength (dB $\mu$ V/m)                    |   |
|-----------------|--|---|
|                 | §15.109 (b), Class A Limit<br>(dB $\mu$ V) @ 10m | §15.109 (a), Class B Limit<br>(dB $\mu$ V) @ 3m |
| 30 - 88         | 39.00  | 40.00   |
| 88 - 216        | 43.50  | 43.50   |
| 216 - 960       | 46.40  | 46.00   |
| Above 960       | 49.50  | 54.00   |

**Table 10. Radiated Emissions Limits calculated from FCC Part 15, §15.109 (a) (b)**

**Test Procedures:** The EUT was placed on a non-metallic table, 80 cm above the ground plane inside a semi-anechoic chamber. The method of testing and test conditions of ANSI C63.4 were used. An antenna was located 3m from the EUT on an adjustable mast. A pre-scan was first performed in order to find prominent radiated emissions. For final emissions measurements at each frequency of interest, the EUT was rotated and the antenna height was varied between 1 m and 4 m in order to maximize the emission. Measurements in both horizontal and vertical polarities were made and the data was recorded. Unless otherwise specified, measurements were made using a quasi-peak detector with a 120 kHz bandwidth.

**Test Results:** The EUT was compliant with the Class A requirement(s) of this section. Measured emissions were below applicable limits.

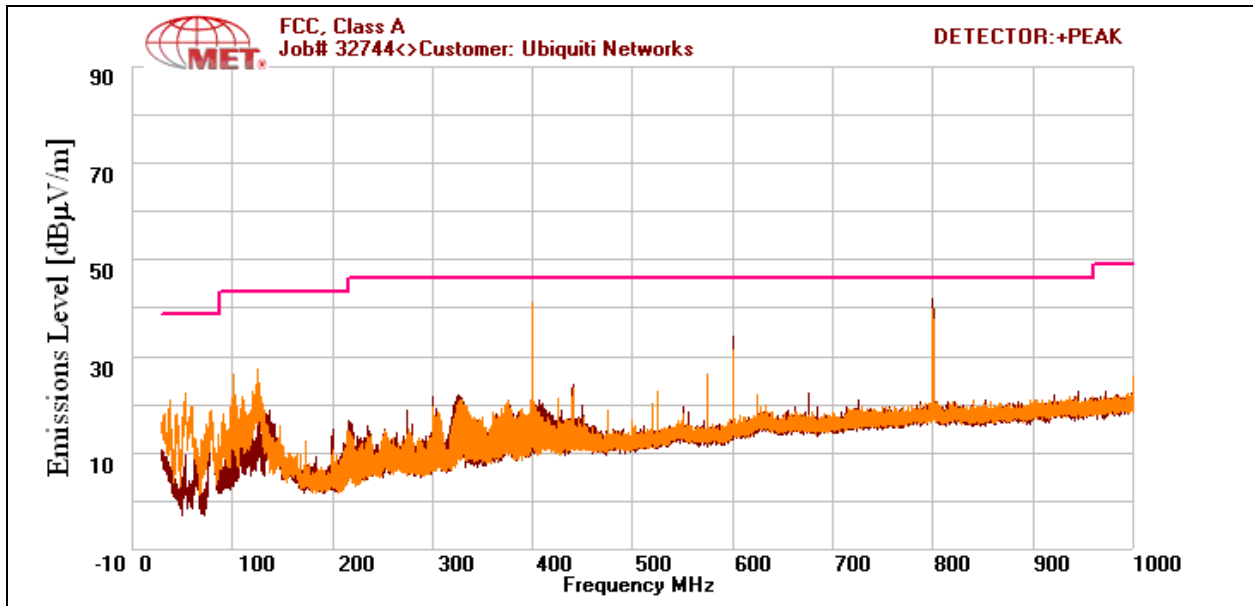
**Test Engineer(s):** Anderson Soungpanya

**Test Date(s):** 08/31/11

### Radiated Emissions Limits Test Results, Class A

| Frequency (MHz) | Antenna Polarity | EUT Azimuth (Degrees) | Antenna Height (cm) | Uncorrected Amplitude (dBuV) | ACF (dB/m) | Pre Amp Gain (dB) | CBL (dB) | DCF (dB) | Corrected Amplitude (dBuV) | Limit (dBuV) | Margin (dB) |
|-----------------|------------------|-----------------------|---------------------|------------------------------|------------|-------------------|----------|----------|----------------------------|--------------|-------------|
| 399.99          | V                | 165                   | 127                 | 32.24                        | 15.599     | 0                 | 4.15     | -10.46   | 41.529                     | 46.4         | -4.871      |
| 399.99          | H                | 61                    | 100                 | 30.66                        | 15.599     | 0                 | 4.15     | -10.46   | 39.949                     | 46.4         | -6.451      |
| 799.99          | H                | 144                   | 100                 | 27.1                         | 20         | 0                 | 6.23     | -10.46   | 42.87                      | 46.4         | -3.53       |
| 799.99          | V                | 173                   | 100                 | 25.34                        | 20         | 0                 | 6.23     | -10.46   | 41.11                      | 46.4         | -5.29       |
| 600             | H                | 144                   | 117                 | 23.41                        | 18.4       | 0                 | 5.18     | -10.46   | 36.53                      | 46.4         | -9.87       |
| 124.97          | V                | 261                   | 100                 | 22.65                        | 12.203     | 0                 | 3.115    | -10.46   | 27.508                     | 43.5         | -15.992     |

Table 11. Radiated Emissions Limits, Test Results, 30 MHz – 1 GHz, FCC Limits

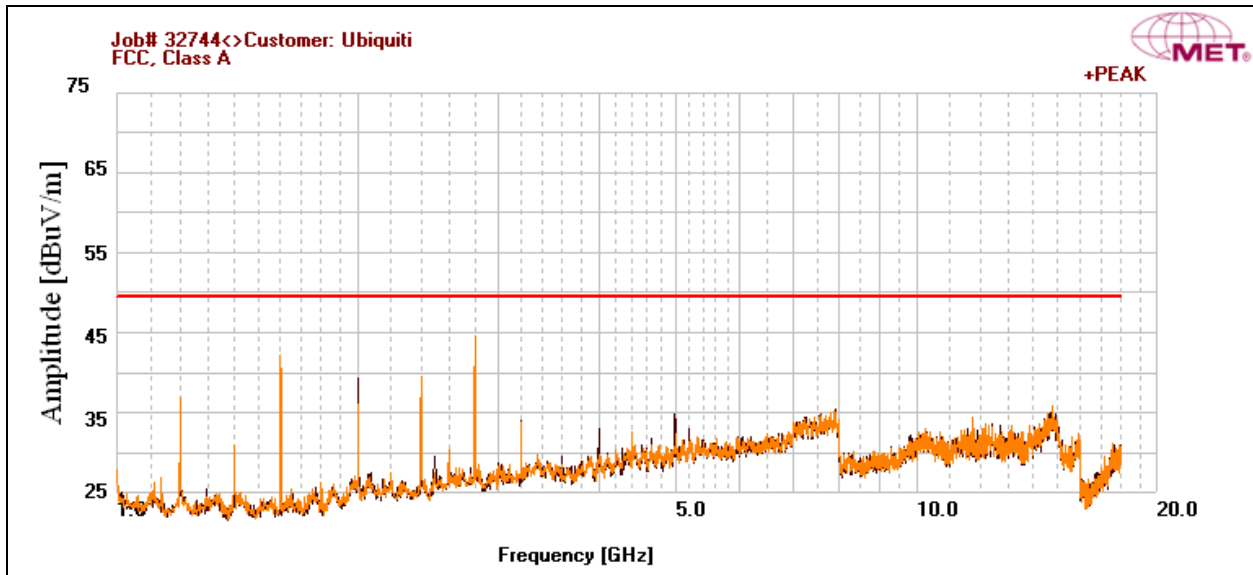


Plot 3. Radiated Emissions, 30 MHz - 1 GHz, FCC Limits

### Radiated Emissions Limits Test Results, Class A

| Frequency (MHz) | Antenna Polarity | EUT Azimuth (Degrees) | Antenna Height (cm) | Uncorrected Amplitude (dBuV) | ACF (dB/m) | Pre Amp Gain (dB) | CBL (dB) | DCF (dB) | Corrected Amplitude (dBuV) | Limit (dBuV) | Margin (dB) |
|-----------------|------------------|-----------------------|---------------------|------------------------------|------------|-------------------|----------|----------|----------------------------|--------------|-------------|
| 2800            | H                | 250.2                 | 143.3               | 81.3                         | 29.626     | 55.916            | 0        | -10.46   | 44.55                      | 49.5         | -4.95       |
| 2800            | V                | 255.3                 | 100.0               | 79.92                        | 29.626     | 55.916            | 0        | -10.46   | 43.17                      | 49.5         | -6.33       |

Table 12. Radiated Emissions Limits, Test Results, Above 1 GHz, FCC Limits

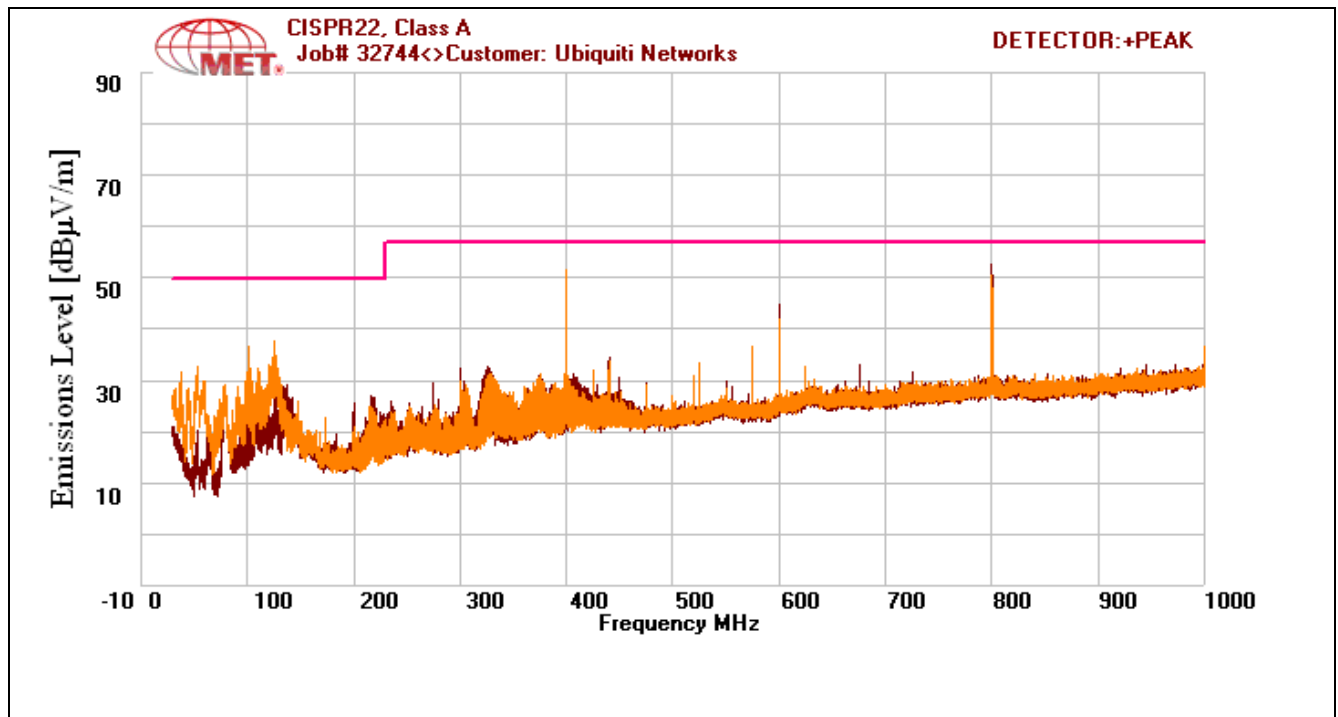


Plot 4. Radiated Emissions, Above 1 GHz, FCC Limits

### Radiated Emissions Limits Test Results, Class A

| Frequency (MHz) | Antenna Polarity | EUT Azimuth (Degrees) | Antenna Height (cm) | Uncorrected Amplitude (dBuV) | ACF (dB/m) | Pre Amp Gain (dB) | CBL (dB) | DCF (dB) | Corrected Amplitude (dBuV) | Limit (dBuV) | Margin (dB) |
|-----------------|------------------|-----------------------|---------------------|------------------------------|------------|-------------------|----------|----------|----------------------------|--------------|-------------|
| 399.99          | V                | 165                   | 127                 | 32.24                        | 15.599     | 0                 | 4.15     | -10.46   | 41.529                     | 47           | -5.471      |
| 399.99          | H                | 61                    | 100                 | 30.66                        | 15.599     | 0                 | 4.15     | -10.46   | 39.949                     | 47           | -7.051      |
| 799.99          | H                | 144                   | 100                 | 27.1                         | 20         | 0                 | 6.23     | -10.46   | 42.87                      | 47           | -4.13       |
| 799.99          | V                | 173                   | 100                 | 25.34                        | 20         | 0                 | 6.23     | -10.46   | 41.11                      | 47           | -5.89       |
| 600             | H                | 144                   | 117                 | 23.41                        | 18.4       | 0                 | 5.18     | -10.46   | 36.53                      | 47           | -10.47      |
| 124.97          | V                | 261                   | 100                 | 22.65                        | 12.203     | 0                 | 3.115    | -10.46   | 27.508                     | 40           | -12.492     |

Table 13. Radiated Emissions Limits, Test Results, ICES-003 Limits



Plot 5. Radiated Emissions, ICES-003 Limits

## **IV. Electromagnetic Compatibility Criteria for Intentional Radiators**

## Electromagnetic Compatibility Criteria for Intentional Radiators

### § 15.203 Antenna Requirement

**Test Requirement:** § 15.203: An intentional radiator shall be designed to ensure that no antenna other than that furnished by the responsible party shall be used with the device. The use of a permanently attached antenna or of an antenna that uses a unique coupling to the intentional radiator shall be considered sufficient to comply with the provisions of this section. The manufacturer may design the unit so that a broken antenna can be replaced by the user, but the use of a standard antenna jack or electrical connector is prohibited.

The structure and application of the EUT were analyzed to determine compliance with Section 15.203 of the Rules. Section 15.203 states that the subject device must meet at least one of the following criteria:

- a.) Antenna must be permanently attached to the unit.
- b.) Antenna must use a unique type of connector to attach to the EUT.
- c.) Unit must be professionally installed. Installer shall be responsible for verifying that the correct antenna is employed with the unit.

**Results:** The EUT as tested is compliant the criteria of §15.203. The EUT uses an integral 25dBi Panel antenna.

**Test Engineer(s):** Anderson Soungpanya

**Test Date(s):** 08/31/11

## Electromagnetic Compatibility Criteria for Intentional Radiators

### § 15.207(a) Conducted Emissions Limits

**Test Requirement(s):** § 15.207 (a): For an intentional radiator that is designed to be connected to the public utility (AC) power line, the radio frequency voltage that is conducted back onto the AC power line on any frequency or frequencies, within the band 150 kHz to 30MHz, shall not exceed the limits in the following table, as measured using a 50  $\mu$ H/50  $\Omega$  line impedance stabilization network (LISN). Compliance with the provisions of this paragraph shall be based on the measurement of the radio frequency voltage between each power line and ground at the power terminal. The lower limit applies at the boundary between the frequency ranges.

| Frequency range (MHz) | § 15.207(a), Conducted Limit (dB $\mu$ V) |         |
|-----------------------|---|---------|
|                       | Quasi-Peak                                | Average |
| * 0.15- 0.45          | 66 - 56                                   | 56 - 46 |
| 0.45 - 0.5            | 56  | 46      |
| 0.5 - 30              | 60  | 50      |

**Table 14. Conducted Limits for Intentional Radiators from FCC Part 15 § 15.207(a)**

**Test Procedure:** The EUT was placed on a 0.8 m-high wooden table inside a screen room. The EUT was situated such that the back of the EUT was 0.4 m from one wall of the vertical ground plane, and the remaining sides of the EUT were no closer than 0.8 m from any other conductive surface. The EUT was powered from a 50  $\Omega$ /50  $\mu$ H Line Impedance Stabilization Network (LISN). The EMC receiver scanned the frequency range from 150 kHz to 30 MHz. Conducted Emissions measurements were made in accordance with *ANSI C63.4-2003 "Methods and Measurements of Radio-Noise Emissions from Low-Voltage Electrical and Electronic Equipment in the Range of 9kHz to 40 GHz"*. The measurements were performed over the frequency range of 0.15 MHz to 30 MHz using a 50  $\Omega$ /50  $\mu$ H LISN as the input transducer to an EMC/field intensity meter. For the purpose of this testing, the transmitter was turned on. Scans were performed with the transmitter on.

**Test Results:** The EUT was compliant with this requirement.

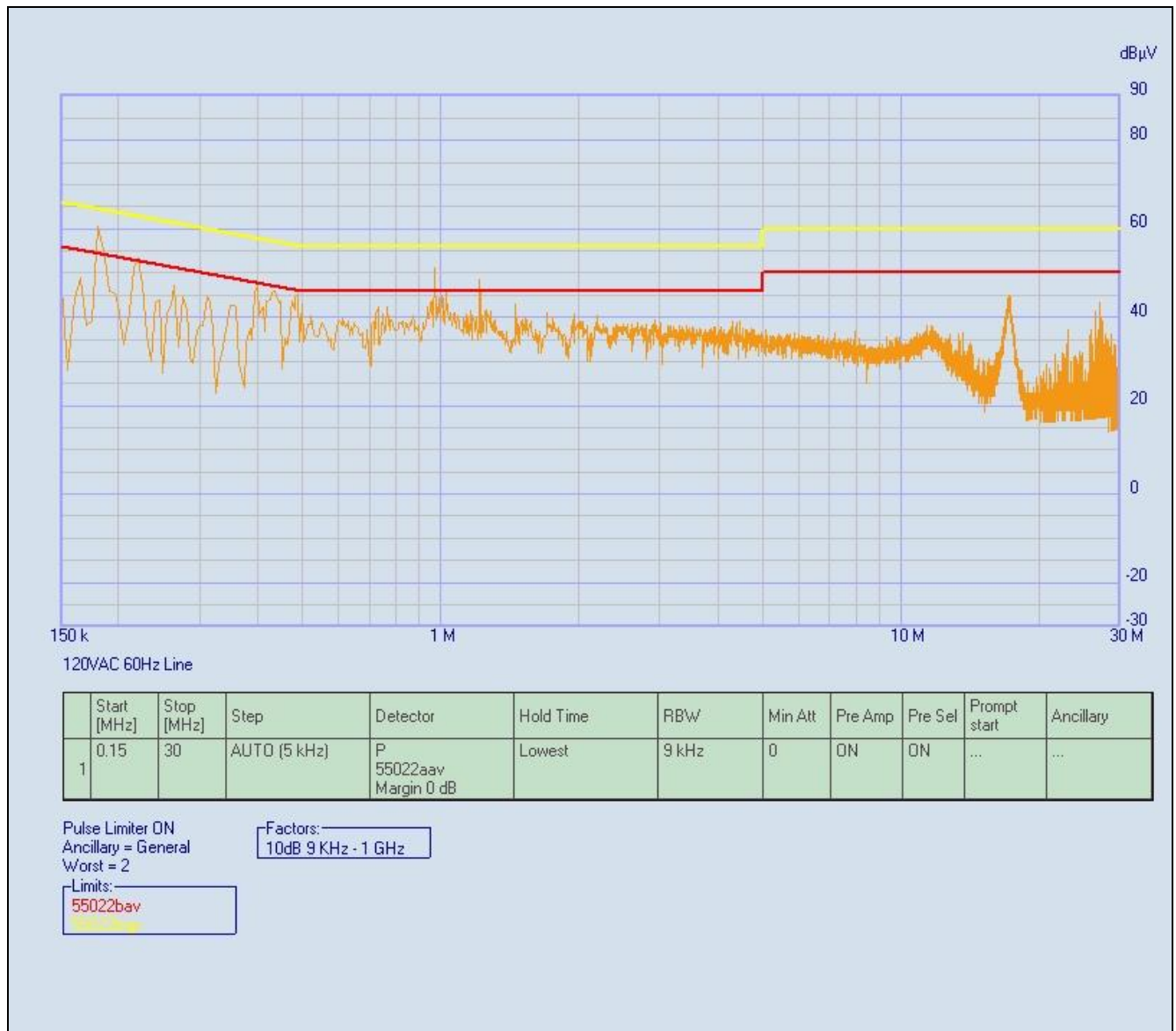
**Test Engineer(s):** Anderson Soungpanya

**Test Date(s):** 08/30/11

### 15.207(a) Conducted Emissions Test Results

| Line             | Freq. (MHz) | QP Amplitude | QP Limit | Delta   | Pass | Average Amplitude | Average Limit | Delta   | Pass |
|------------------|-------------|--------------|----------|---------|------|-------------------|---------------|---------|------|
| 120VAC 60Hz Line | .18         | 56.73        | 64.49    | -7.76   | Pass | 37.87             | 54.49         | -16.62  | Pass |
| 120VAC 60Hz Line | .22         | 49.12        | 62.828   | -13.708 | Pass | 31.81             | 52.828        | -21.018 | Pass |
| 120VAC 60Hz Line | .975        | 48.81        | 56       | -7.19   | Pass | 45.56             | 46            | -0.44   | Pass |
| 120VAC 60Hz Line | 1.215       | 44.74        | 56       | -11.26  | Pass | 41.72             | 46            | -4.28   | Pass |

**Table 15. Conducted Emissions, 15.207(a), Phase Line, Test Results**



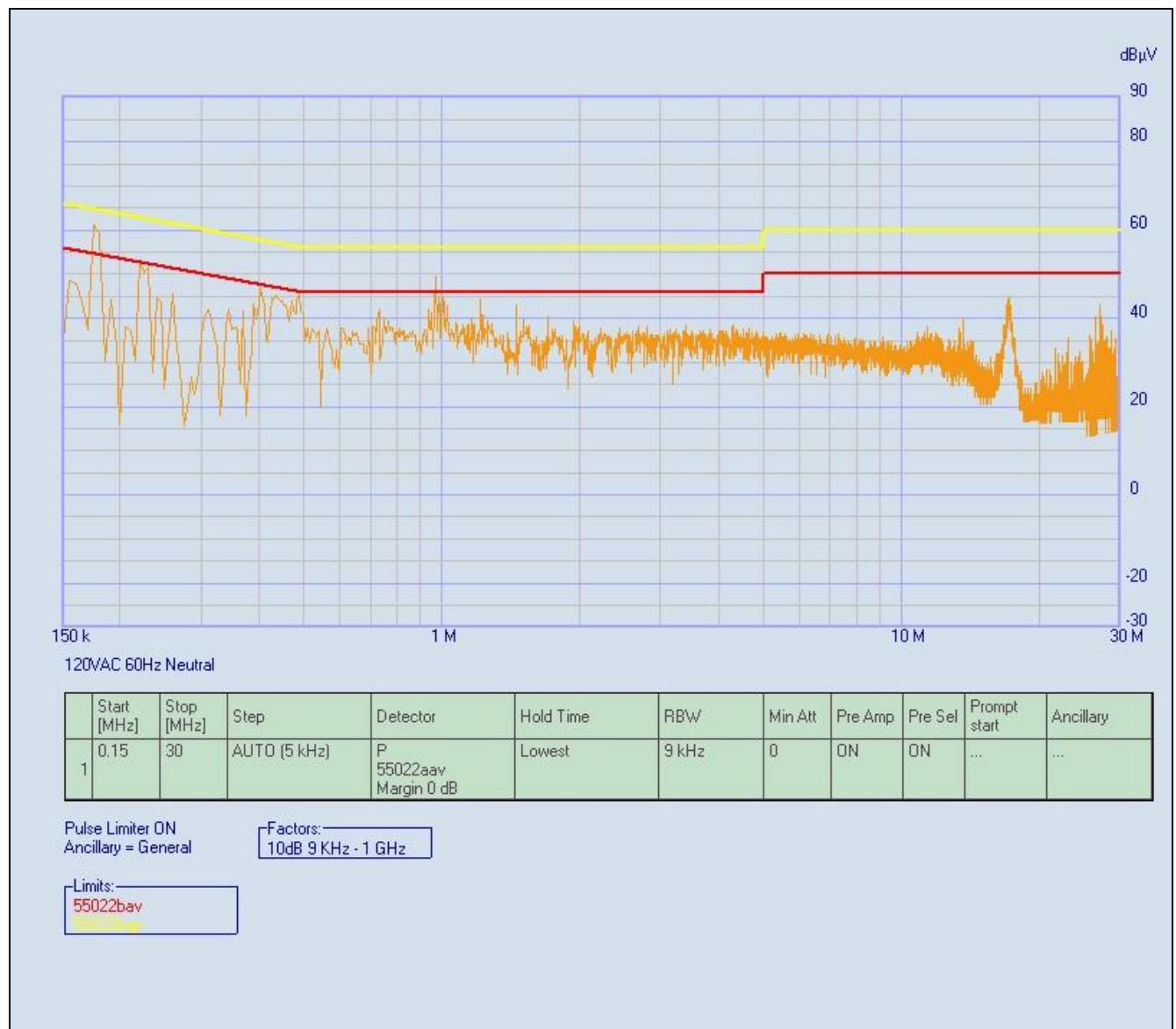
**Plot 6. Conducted Emissions, 15.207(a), Phase Line**



### 15.207(a) Conducted Emissions Test Results

| Line                   | Freq (MHz) | QP Amplitude | QP Limit | Delta   | Pass | Average Amplitude | Average Limit | Delta   | Pass |
|------------------------|------------|--------------|----------|---------|------|-------------------|---------------|---------|------|
| 120VAC<br>60Hz Neutral | .175       | 56.98        | 64.723   | -7.743  | Pass | 39.62             | 54.723        | -15.103 | Pass |
| 120VAC<br>60Hz Neutral | .22        | 48.58        | 62.828   | -14.248 | Pass | 30.72             | 52.828        | -22.108 | Pass |
| 120VAC<br>60Hz Neutral | .975       | 46.23        | 56       | -9.77   | Pass | 44.62             | 46            | -1.38   | Pass |
| 120VAC<br>60Hz Neutral | 1.215      | 43.41        | 56       | -12.59  | Pass | 38.32             | 46            | -7.68   | Pass |

Table 16. Conducted Emissions, 15.207(a), Neutral Line, Test Results



Plot 7. Conducted Emissions, 15.207(a), Neutral Line

## Electromagnetic Compatibility Criteria for Intentional Radiators

### § 15.247(a)(2) 6 dB and 99% Bandwidth

**Test Requirements:** § 15.247(a)(2): Operation under the provisions of this section is limited to frequency hopping and digitally modulated intentional radiators that comply with the following provisions:

For systems using digital modulation techniques, the EUT may operate in the 902-928 MHz, 2400-2483.5 MHz and 5725-5850 MHz bands. The minimum 6dB bandwidth shall be at least 500 kHz.

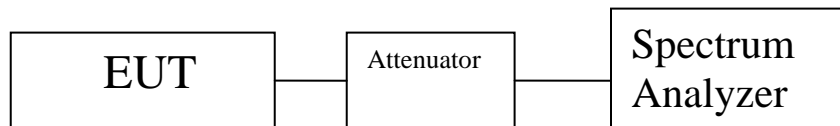
**Test Procedure:** The transmitter was on and transmitting at the highest output power. The bandwidth of the fundamental frequency was measured with the spectrum analyzer using a RBW approximately 1% of the total emission bandwidth, VBW > RBW. The 6 dB Bandwidth was measured and recorded. The measurements were performed on the low, mid and high channels.

**Test Results** The EUT was compliant with § 15.247 (a)(2).

The 6 dB and 99% Bandwidth was determined from the plots on the following pages.

**Test Engineer(s):** Anderson Soungpanya

**Test Date(s):** 08/30/11



**Figure 2. Block Diagram, Occupied Bandwidth Test Setup**

## Occupied Bandwidth Test Results

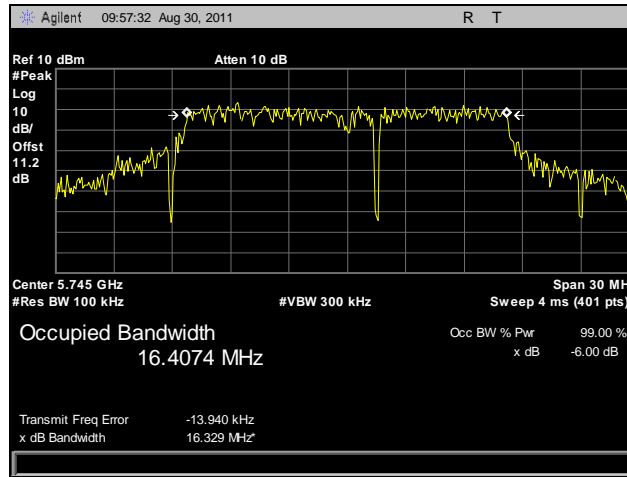
| Occupied Bandwidth     |                 |                 |                               |
|------------------------|-----------------|-----------------|-------------------------------|
| Mode                   | Carrier Channel | Frequency (MHz) | Measured 6 dB Bandwidth (MHz) |
| 802.11a                | Low             | 5745            | 16.329                        |
|                        | Mid             | 5785            | 16.506                        |
|                        | High            | 5825            | 16.338                        |
| 802.11n 20 MHz, Port 0 | Low             | 5745            | 16.456                        |
|                        | Mid             | 5785            | 16.358                        |
|                        | High            | 5825            | 17.700                        |
| 802.11n 20 MHz, Port 1 | Low             | 5745            | 17.293                        |
|                        | Mid             | 5785            | 17.661                        |
|                        | High            | 5825            | 17.678                        |
| 802.11n 20 MHz, Port 2 | Low             | 5745            | 17.617                        |
|                        | Mid             | 5785            | 17.995                        |
|                        | High            | 5825            | 17.605                        |
| 802.11n 40 MHz, Port 0 | Low             | 5755            | 36.682                        |
|                        | High            | 5795            | 35.582                        |
| 802.11n 40 MHz, Port 1 | Low             | 5755            | 36.214                        |
|                        | High            | 5795            | 36.536                        |
| 802.11n 40 MHz, Port 2 | Low             | 5755            | 35.831                        |
|                        | High            | 5795            | 35.907                        |

Table 17. 6 dB Occupied Bandwidth, Test Results

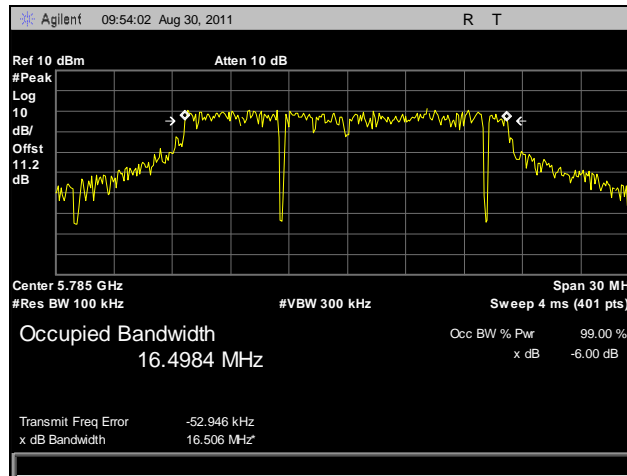
| Occupied Bandwidth     |                 |                 |                              |
|------------------------|-----------------|-----------------|------------------------------|
| Mode                   | Carrier Channel | Frequency (MHz) | Measured 99% Bandwidth (MHz) |
| 802.11a                | Low             | 5745            | 16.7143                      |
|                        | Mid             | 5785            | 16.8685                      |
|                        | High            | 5825            | 16.8668                      |
| 802.11n 20 MHz, Port 0 | Low             | 5745            | 17.8257                      |
|                        | Mid             | 5785            | 17.6655                      |
|                        | High            | 5825            | 17.7482                      |
| 802.11n 20 MHz, Port 1 | Low             | 5745            | 17.7007                      |
|                        | Mid             | 5785            | 17.6395                      |
|                        | High            | 5825            | 17.6963                      |
| 802.11n 20 MHz, Port 2 | Low             | 5745            | 17.7450                      |
|                        | Mid             | 5785            | 17.7016                      |
|                        | High            | 5825            | 17.6619                      |
| 802.11n 40 MHz, Port 0 | Low             | 5755            | 36.7333                      |
|                        | High            | 5795            | 36.4968                      |
| 802.11n 40 MHz, Port 1 | Low             | 5755            | 36.5071                      |
|                        | High            | 5795            | 36.8987                      |
| 802.11n 40 MHz, Port 2 | Low             | 5755            | 36.5170                      |
|                        | High            | 5795            | 36.8027                      |

Table 18. 99% Occupied Bandwidth, Test Results

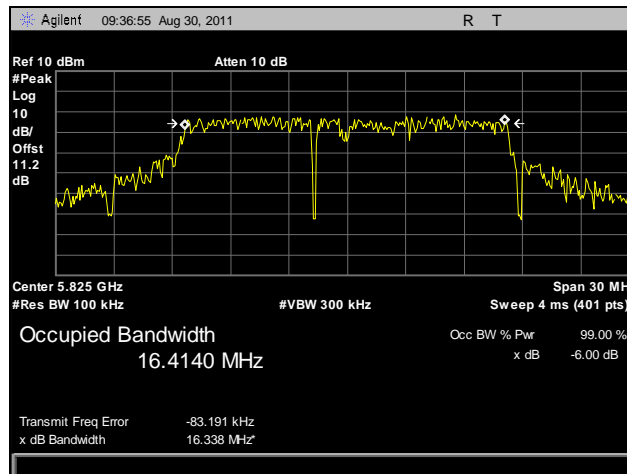
### 6 dB Occupied Bandwidth Test Results, 802.11a



Plot 8. 6 dB Occupied Bandwidth, Low Channel, 802.11a

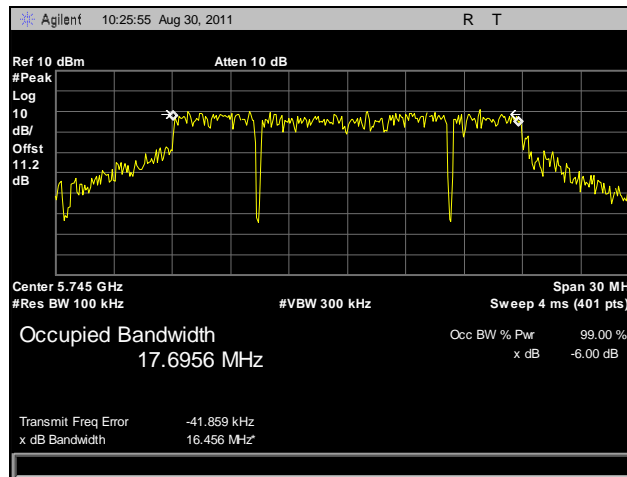


Plot 9. 6 dB Occupied Bandwidth, Mid Channel, 802.11a

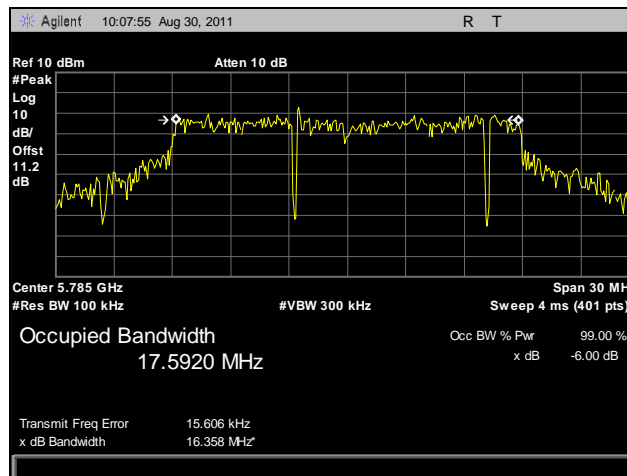


Plot 10. 6 dB Occupied Bandwidth, High Channel, 802.11a

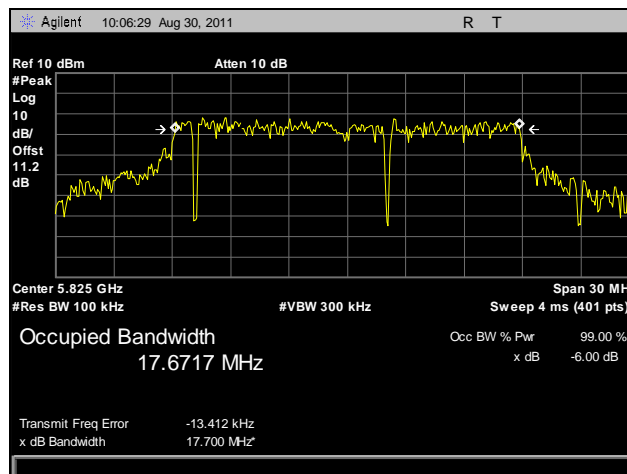
**6 dB Occupied Bandwidth Test Results, 802.11n 20 MHz, Port 0**



**Plot 11. 6 dB Occupied Bandwidth, Low Channel, 802.11n 20 MHz, Port 0**

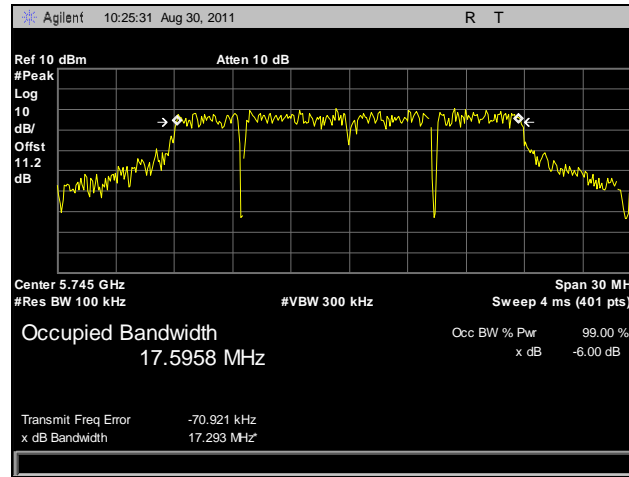


**Plot 12. 6 dB Occupied Bandwidth, Mid Channel, 802.11n 20 MHz, Port 0**

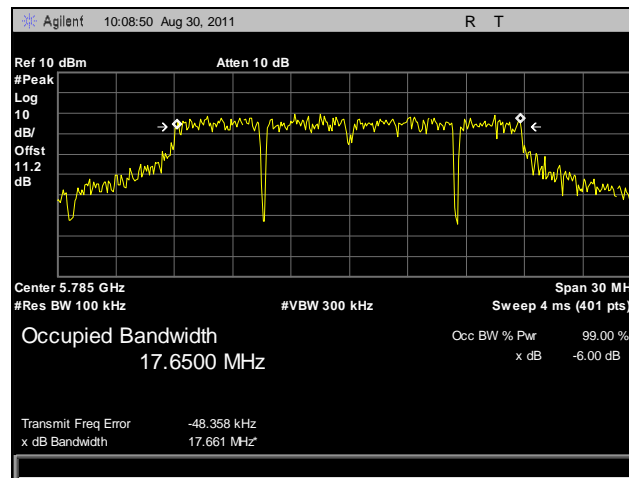


**Plot 13. 6 dB Occupied Bandwidth, High Channel, 802.11n 20 MHz, Port 0**

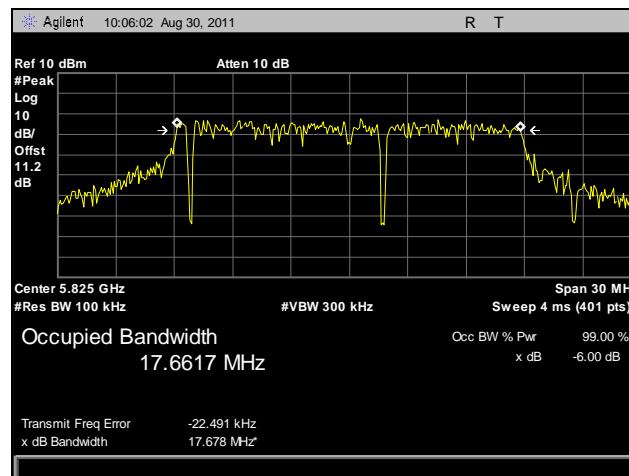
### 6 dB Occupied Bandwidth Test Results, 802.11n 20 MHz, Port 1



Plot 14. 6 dB Occupied Bandwidth, Low Channel, 802.11n 20 MHz, Port 1

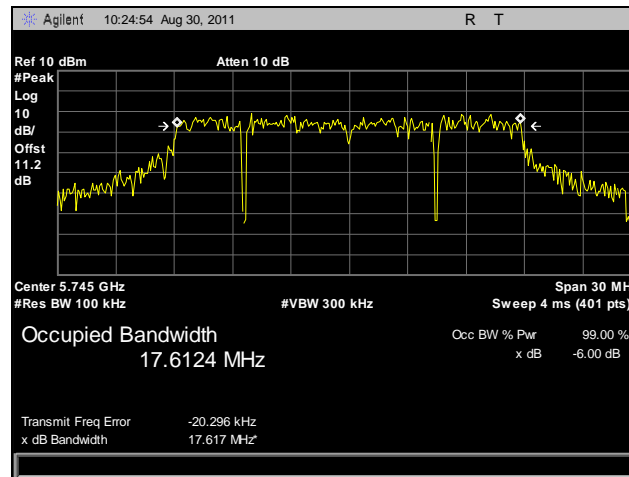


Plot 15. 6 dB Occupied Bandwidth, Mid Channel, 802.11n 20 MHz, Port 1

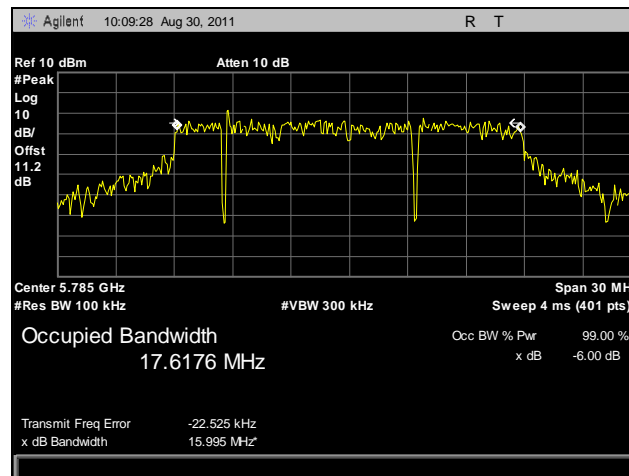


Plot 16. 6 dB Occupied Bandwidth, High Channel, 802.11n 20 MHz, Port 1

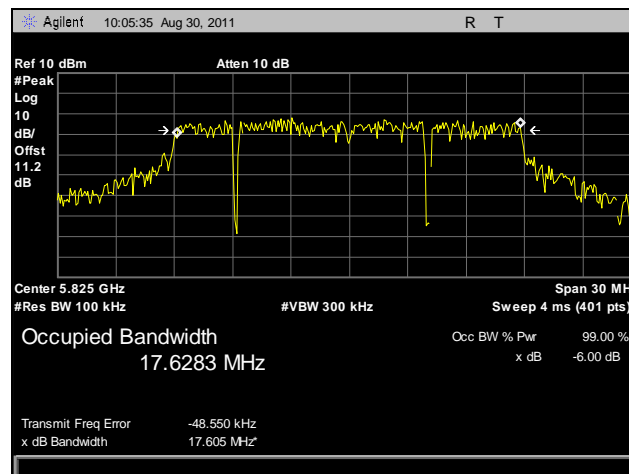
### 6 dB Occupied Bandwidth Test Results, 802.11n 20 MHz, Port 2



Plot 17. 6 dB Occupied Bandwidth, Low Channel, 802.11n 20 MHz, Port 2



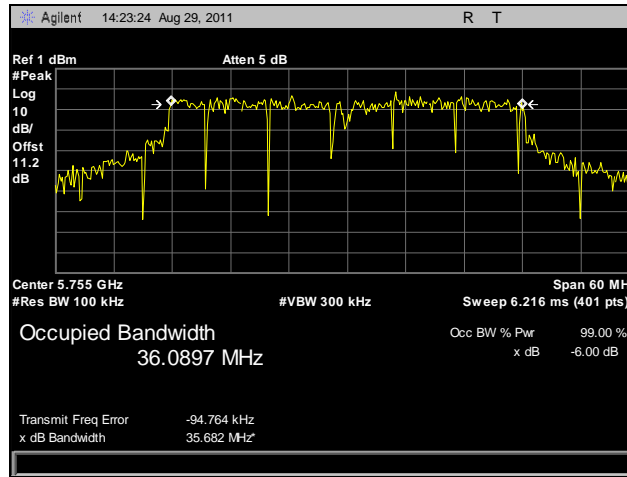
Plot 18. 6 dB Occupied Bandwidth, Mid Channel, 802.11n 20 MHz, Port 2



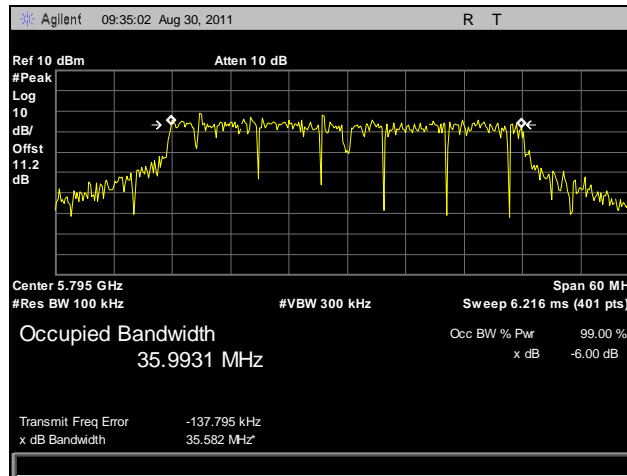
Plot 19. 6 dB Occupied Bandwidth, High Channel, 802.11n 20 MHz, Port 2



### 6 dB Occupied Bandwidth Test Results, 802.11n 40 MHz, Port 0

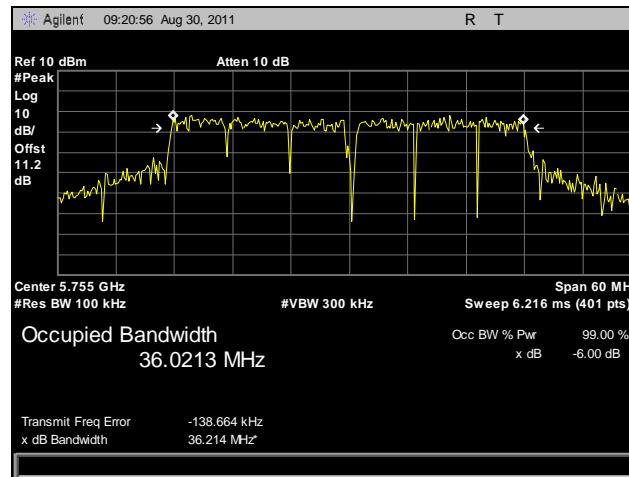


Plot 20. 6 dB Occupied Bandwidth, Low Channel, 802.11n 40 MHz, Port 0

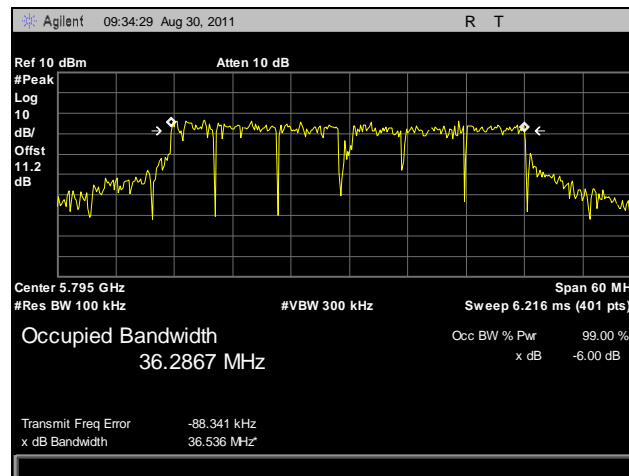


Plot 21. 6 dB Occupied Bandwidth, High Channel, 802.11n 40 MHz, Port 0

**6 dB Occupied Bandwidth Test Results, 802.11n 40 MHz, Port 1**

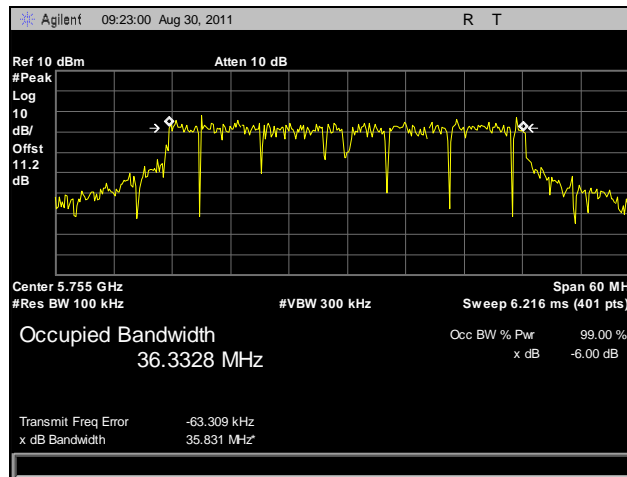


**Plot 22. 6 dB Occupied Bandwidth, Low Channel, 802.11n 40 MHz, Port 1**

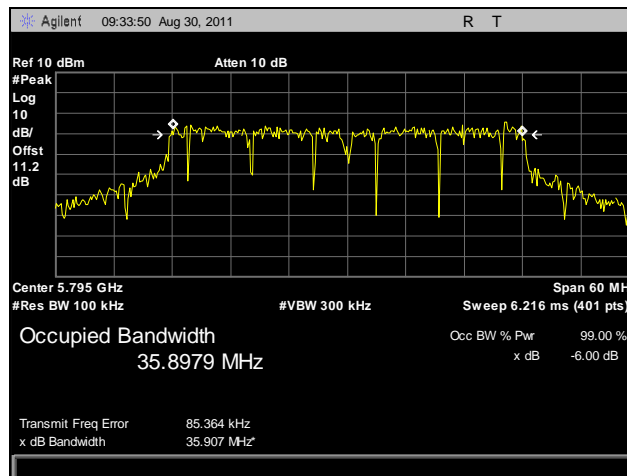


**Plot 23. 6 dB Occupied Bandwidth, High Channel, 802.11n 40 MHz, Port 1**

**6 dB Occupied Bandwidth Test Results, 802.11n 40 MHz, Port 2**

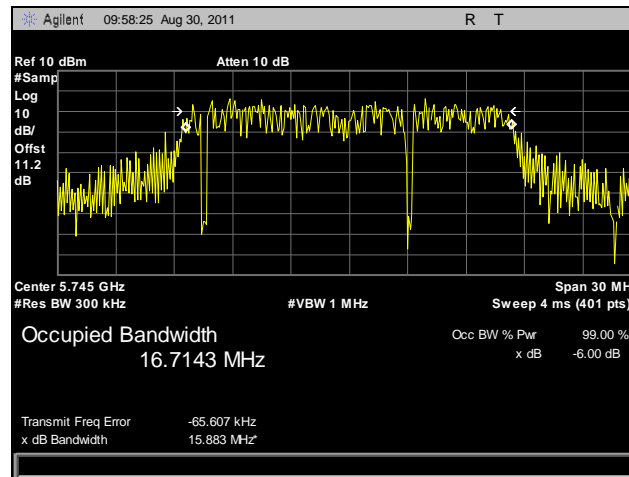


**Plot 24. 6 dB Occupied Bandwidth, Low Channel, 802.11n 40 MHz, Port 2**

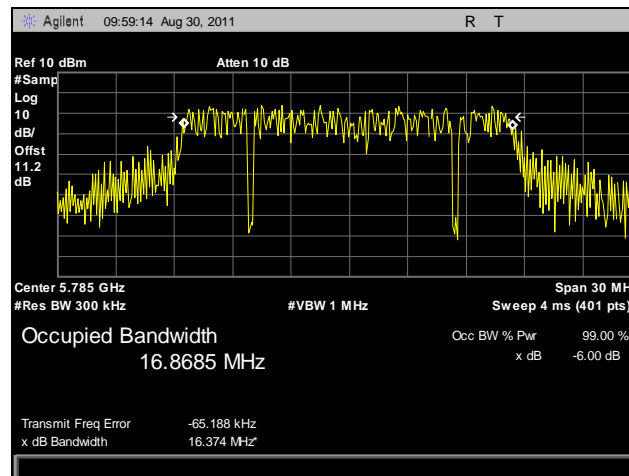


**Plot 25. 6 dB Occupied Bandwidth, High Channel, 802.11n 40 MHz, Port 2**

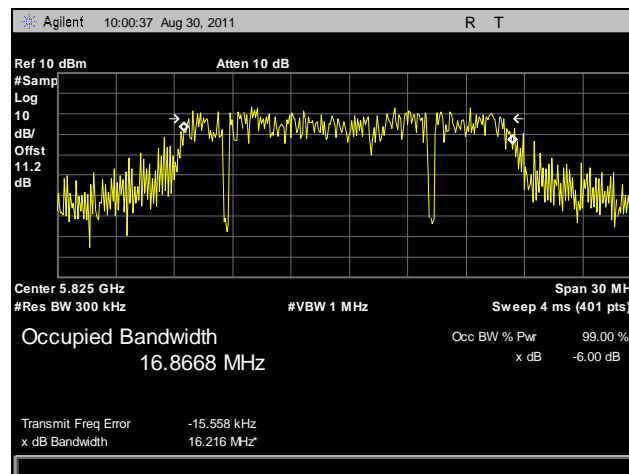
## 99% Occupied Bandwidth Test Results, 802.11a



Plot 26. 99% Occupied Bandwidth, Low Channel, 802.11a

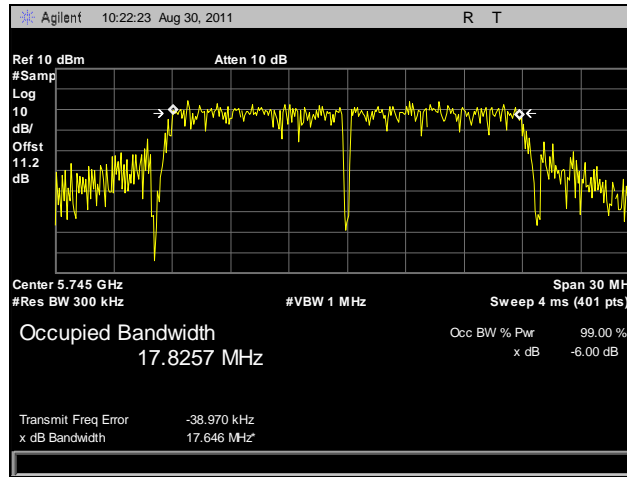


Plot 27. 99% Occupied Bandwidth, Mid Channel, 802.11a

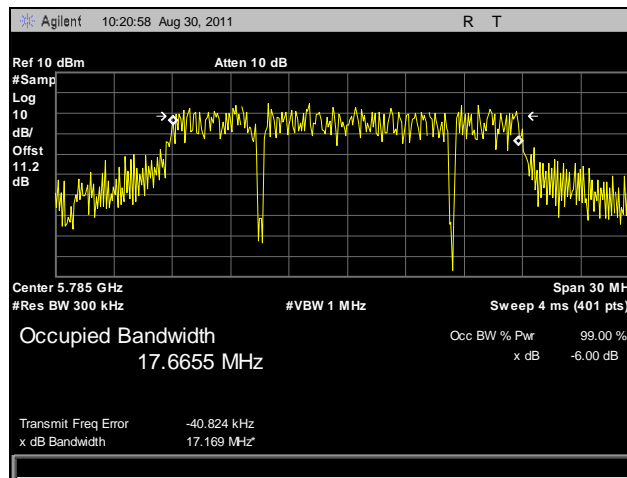


Plot 28. 99% Occupied Bandwidth, High Channel, 802.11a

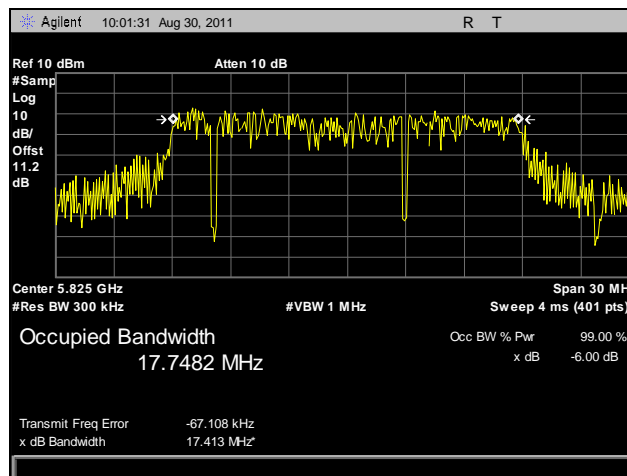
**99% Occupied Bandwidth Test Results, 802.11n 20 MHz, Port 0**



**Plot 29. 99% Occupied Bandwidth, Low Channel, 802.11n 20 MHz, Port 0**

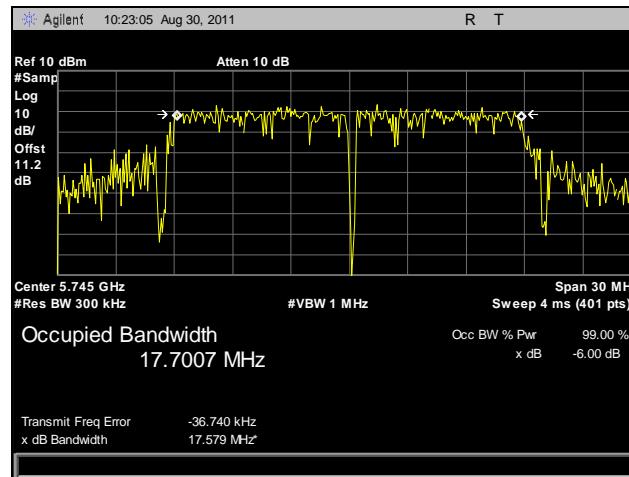


**Plot 30. 99% Occupied Bandwidth, Mid Channel, 802.11n 20 MHz, Port 0**

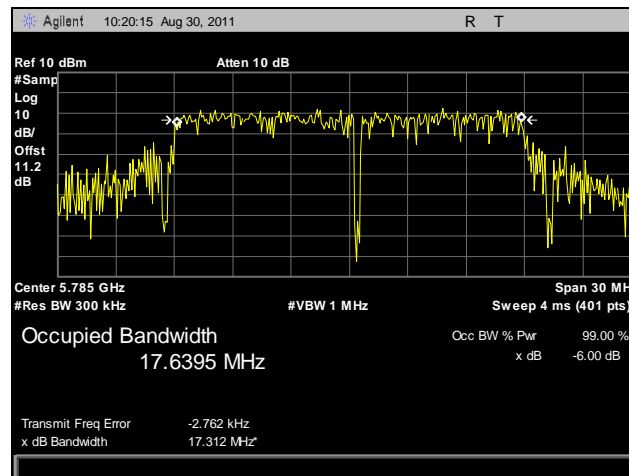


**Plot 31. 99% Occupied Bandwidth, High Channel, 802.11n 20 MHz, Port 0**

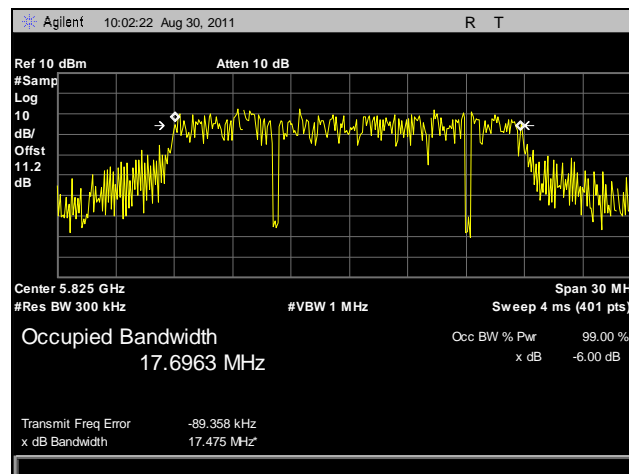
### 99% Occupied Bandwidth Test Results, 802.11n 20 MHz, Port 1



Plot 32. 99% Occupied Bandwidth, Low Channel, 802.11n 20 MHz, Port 1

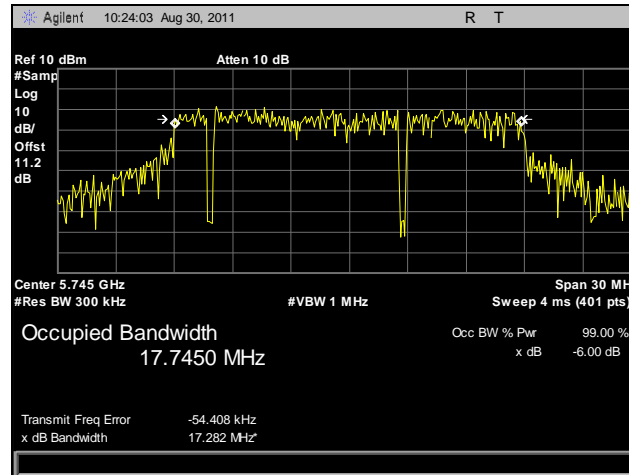


Plot 33. 99% Occupied Bandwidth, Mid Channel, 802.11n 20 MHz, Port 1

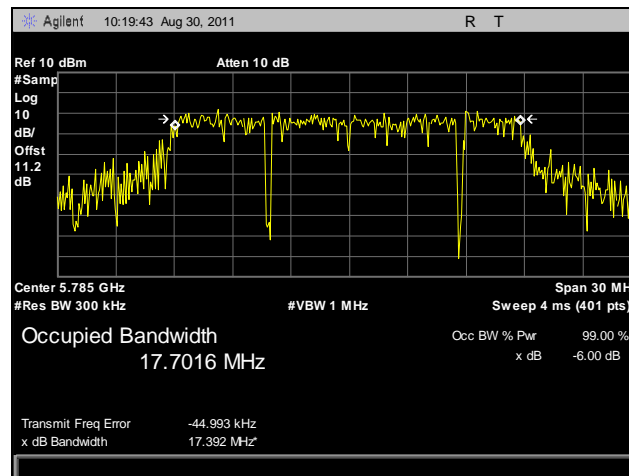


Plot 34. 99% Occupied Bandwidth, High Channel, 802.11n 20 MHz, Port 1

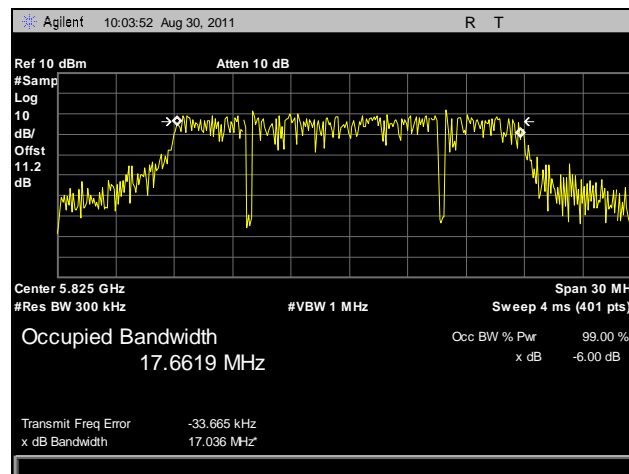
## 99% Occupied Bandwidth Test Results, 802.11n 20 MHz, Port 2



Plot 35. 99% Occupied Bandwidth, Low Channel, 802.11n 20 MHz, Port 2

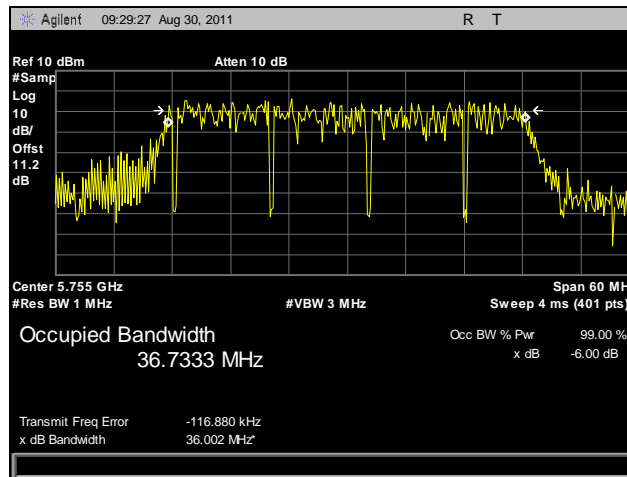


Plot 36. 99% Occupied Bandwidth, Mid Channel, 802.11n 20 MHz, Port 2

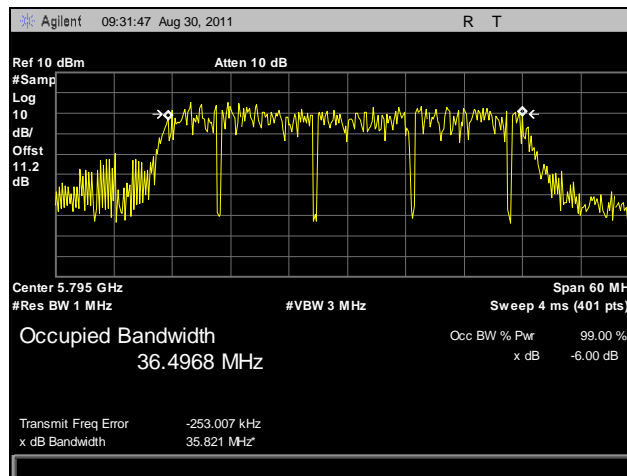


Plot 37. 99% Occupied Bandwidth, High Channel, 802.11n 20 MHz, Port 2

**99% Occupied Bandwidth Test Results, 802.11n 40 MHz, Port 0**



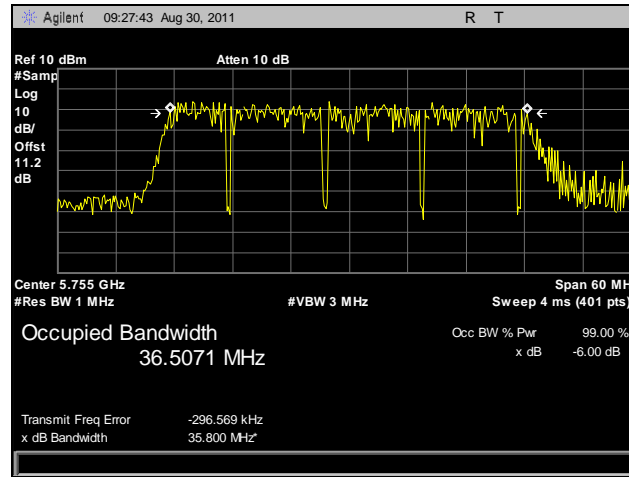
**Plot 38. 99% Occupied Bandwidth, Low Channel, 802.11n 40 MHz, Port 0**



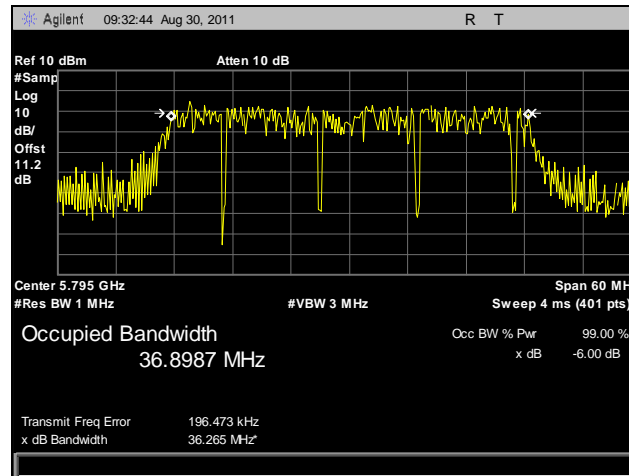
**Plot 39. 99% Occupied Bandwidth, High Channel, 802.11n 40 MHz, Port 0**



**99% Occupied Bandwidth Test Results, 802.11n 40 MHz, Port 1**

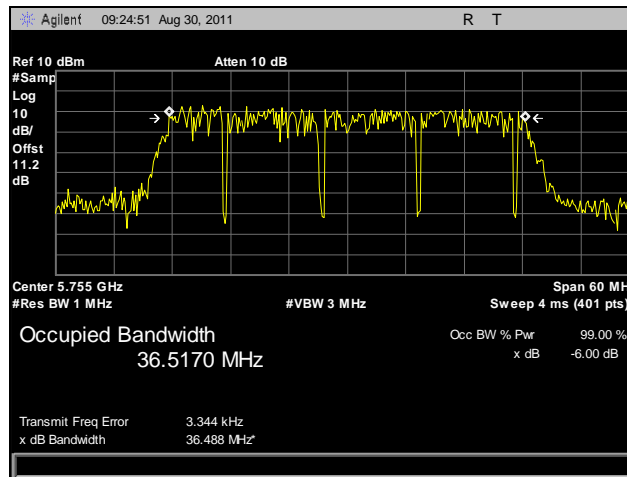


**Plot 40. 99% Occupied Bandwidth, Low Channel, 802.11n 40 MHz, Port 1**

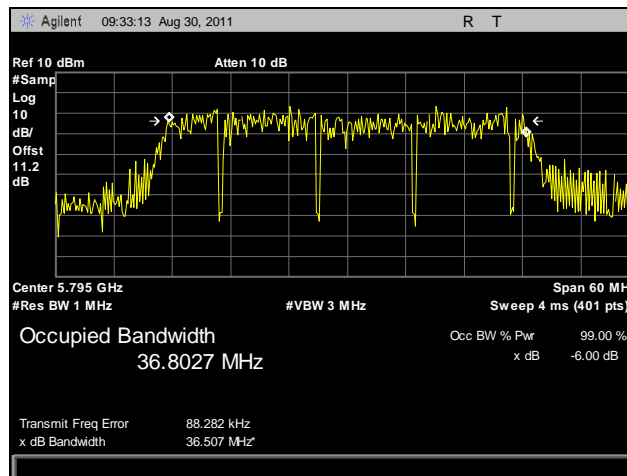


**Plot 41. 99% Occupied Bandwidth, High Channel, 802.11n 40 MHz, Port 1**

**99% Occupied Bandwidth Test Results, 802.11n 40 MHz, Port 2**



**Plot 42. 99% Occupied Bandwidth, Low Channel, 802.11n 40 MHz, Port 2**



**Plot 43. 99% Occupied Bandwidth, High Channel, 802.11n 40 MHz, Port 2**

## Electromagnetic Compatibility Criteria for Intentional Radiators

### § 15.247(b) Peak Power Output

**Test Requirements:** §15.247(b): The maximum peak output power of the intentional radiator shall not exceed the following:

| Digital Transmission Systems<br>(MHz) | Output Limit<br>(Watts) |
|---------------------------------------|-------------------------|
| 902-928                               | 1.000                   |
| 2400-2483.5                           | 1.000                   |
| 5725- 5850                            | 1.000                   |

**Table 19. Output Power Requirements from §15.247(b)**

§15.247(c): if transmitting antennas of directional gain greater than 6 dBi are used the peak output power from the intentional radiator shall be reduced below the stated values in the Table 19, as appropriate, by the amount in dB that the directional gain of the antenna exceeds 6 dBi.

Systems operating in the 2400 – 2483.5 MHz band and using a point to point application may employ transmitting antennas with directional gain greater than 6 dBi provided the maximum peak output power of the intentional radiator is reduced by 1 dB for every 3 dB that the directional gain of the antenna exceeds 6 dBi.

Systems operating in the 5725 – 5850 MHz band that are used exclusively for fixed, point-to-point operations may employ transmitting antennas with directional gain greater than 6 dBi without any corresponding reduction in transmitter peak output power.

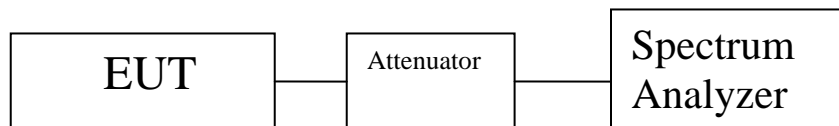
Fixed, point-to-point operation excludes the use of point-to-multipoint systems, Omni-directional applications, and multiple co-located intentional radiators transmitting the same information. The operator of the spread spectrum intentional radiator or, if the equipment is professionally installed, the installer is responsible for ensuring that the system is used exclusively for fixed, point-to-point operations. The instruction manual furnished with the intentional radiator shall contain language in the installation instructions informing the operator and the installer of this responsibility.

**Test Procedure:** The transmitter was connected to a calibrated spectrum analyzer. The EUT was measured at the low, mid and high channels of each band at the maximum power level.

**Test Results:** The EUT was compliant with the Peak Power Output limits of §15.247(b).

**Test Engineer(s):** Lionel Gabrillo

**Test Date(s):** 08/29/11



**Figure 3. Peak Power Output Test Setup**

### Peak Power Output Test Results

| Peak Conducted Output Power |                 |               |                                |
|-----------------------------|-----------------|---------------|--------------------------------|
| Mode                        | Carrier Channel | Frequency MHz | Measured Peak Output Power dBm |
| 802.11a                     | Low             | 5745          | 12.96                          |
|                             | Mid             | 5785          | 16.08                          |
|                             | High            | 5825          | 14.18                          |

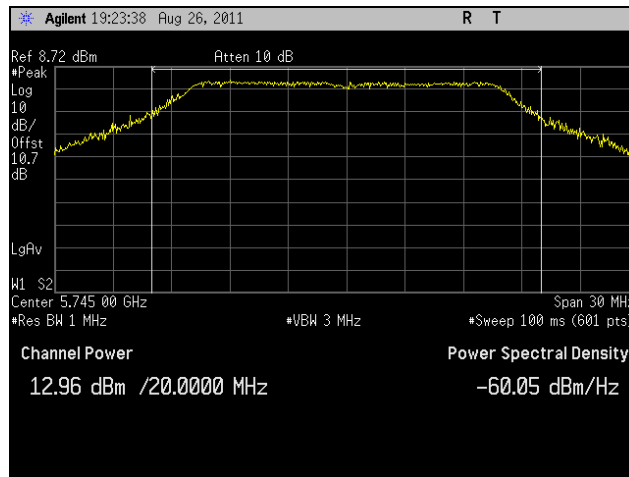
| Peak Conducted Output Power |                 |               |                                |
|-----------------------------|-----------------|---------------|--------------------------------|
| Mode                        | Carrier Channel | Frequency MHz | Measured Peak Output Power dBm |
| 802.11n 20 MHz, Port 0      | Low             | 5745          | 11.34                          |
|                             | Mid             | 5785          | 10.32                          |
|                             | High            | 5825          | 13.39                          |
| 802.11n 20 MHz, Port 1      | Low             | 5745          | 12.00                          |
|                             | Mid             | 5785          | 11.03                          |
|                             | High            | 5825          | 13.91                          |
| 802.11n 20 MHz, Port 2      | Low             | 5745          | 10.25                          |
|                             | Mid             | 5785          | 9.70                           |
|                             | High            | 5825          | 13.84                          |
| 802.11n 40 MHz, Port 0      | Low             | 5755          | 16.36                          |
|                             | High            | 5795          | 15.35                          |
| 802.11n 40 MHz, Port 1      | Low             | 5755          | 16.21                          |
|                             | High            | 5795          | 15.10                          |
| 802.11n 40 MHz, Port 2      | Low             | 5755          | 14.83                          |
|                             | High            | 5795          | 14.39                          |

Table 20. Peak Power Output, Test Results

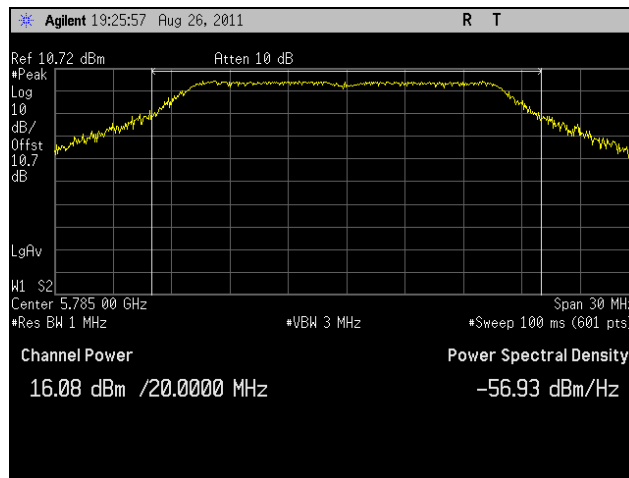
| Summed Peak Conducted Output Power |                 |               |                         |
|------------------------------------|-----------------|---------------|-------------------------|
| Mode                               | Carrier Channel | Frequency MHz | Summed Output Power dBm |
| 802.11n 20 MHz                     | Low             | 5745          | 16.03                   |
|                                    | Mid             | 5785          | 15.16                   |
|                                    | High            | 5825          | 18.50                   |
| 802.11n 40 MHz                     | Low             | 5755          | 18.58                   |
|                                    | High            | 5795          | 17.77                   |

Table 21. Summed Peak Conducted Output Power, Test Results

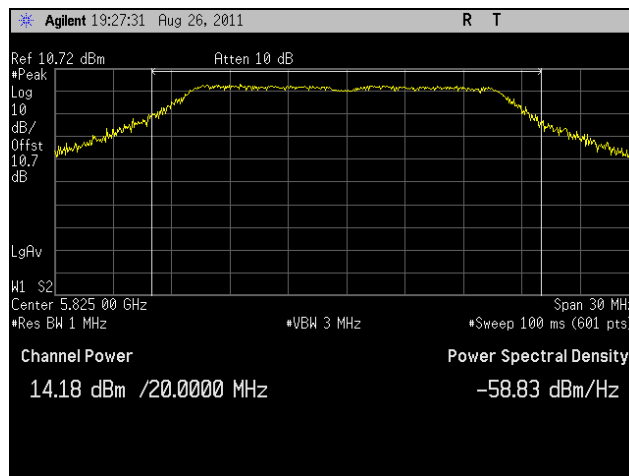
**Peak Power Output Test Results, 802.11a**



**Plot 44. Peak Power Output, Low Channel, 802.11a**

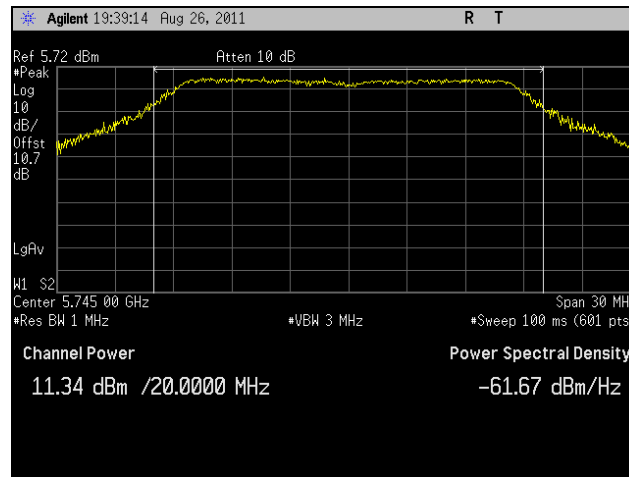


**Plot 45. Peak Power Output, Mid Channel, 802.11a**

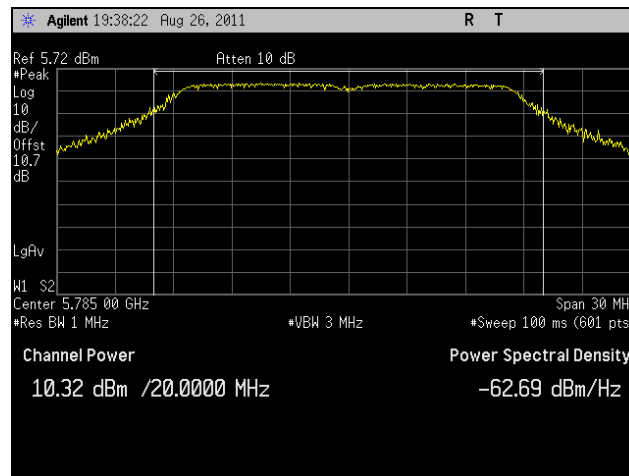


**Plot 46. Peak Power Output, High Channel, 802.11a**

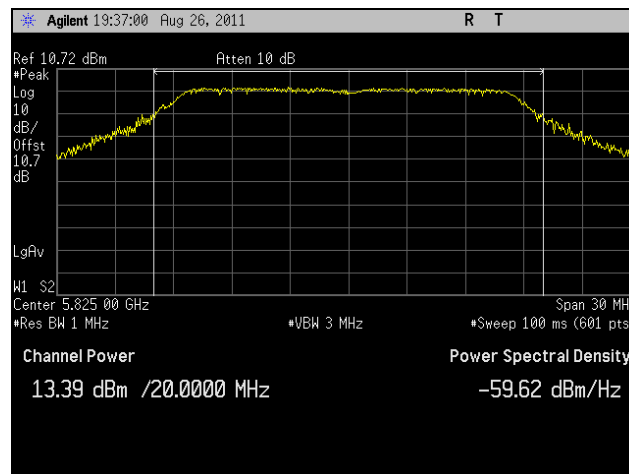
**Peak Power Output Test Results, 802.11n 20 MHz, Port 0**



**Plot 47. Peak Power Output, Low Channel, 802.11n 20 MHz, Port 0**

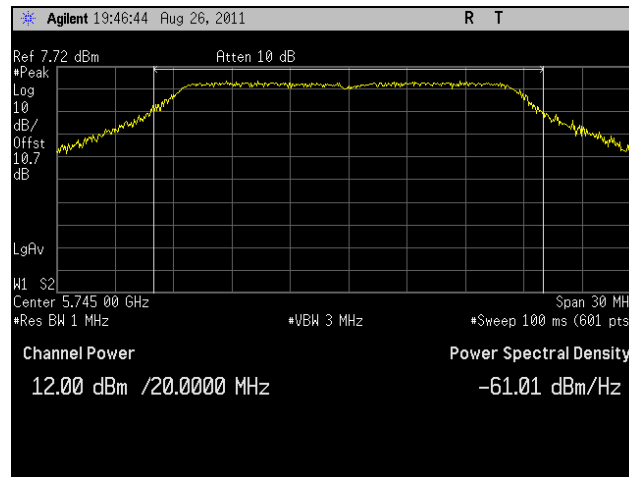


**Plot 48. Peak Power Output, Mid Channel, 802.11n 20 MHz, Port 0**

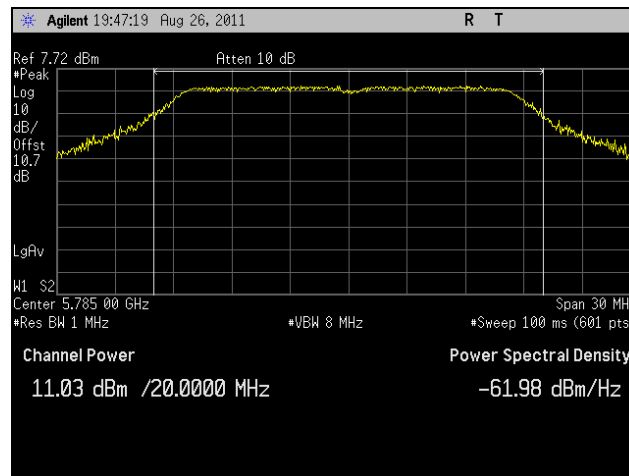


**Plot 49. Peak Power Output, High Channel, 802.11n 20 MHz, Port 0**

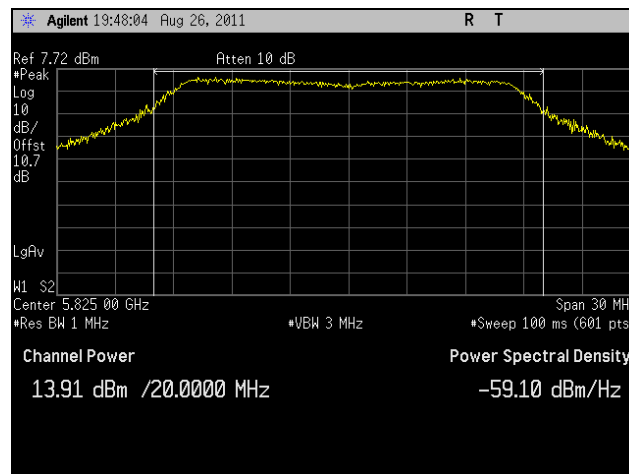
## Peak Power Output Test Results, 802.11n 20 MHz, Port 1



Plot 50. Peak Power Output, Low Channel, 802.11n 20 MHz, Port 1

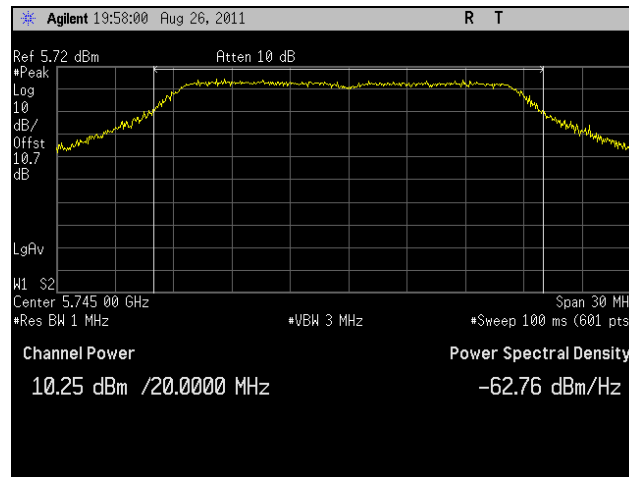


Plot 51. Peak Power Output, Mid Channel, 802.11n 20 MHz, Port 1

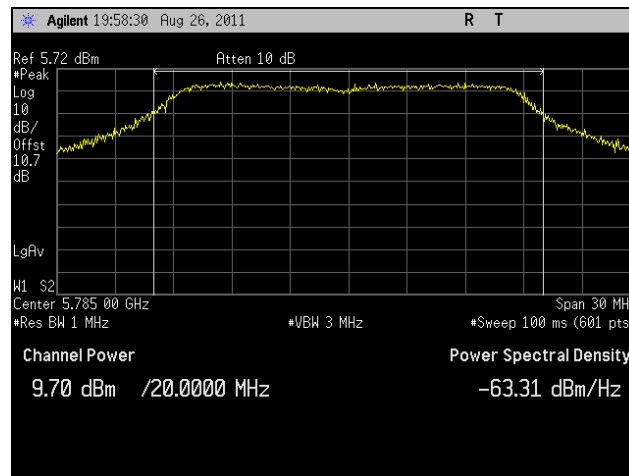


Plot 52. Peak Power Output, High Channel, 802.11n 20 MHz, Port 1

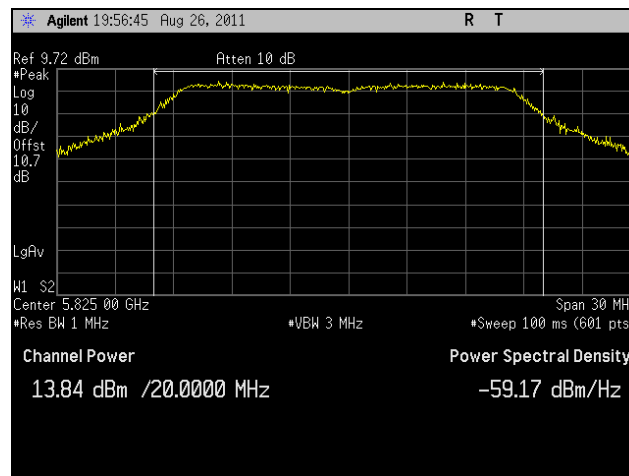
**Peak Power Output Test Results, 802.11n 20 MHz, Port 2**



**Plot 53. Peak Power Output, Low Channel, 802.11n 20 MHz, Port 2**



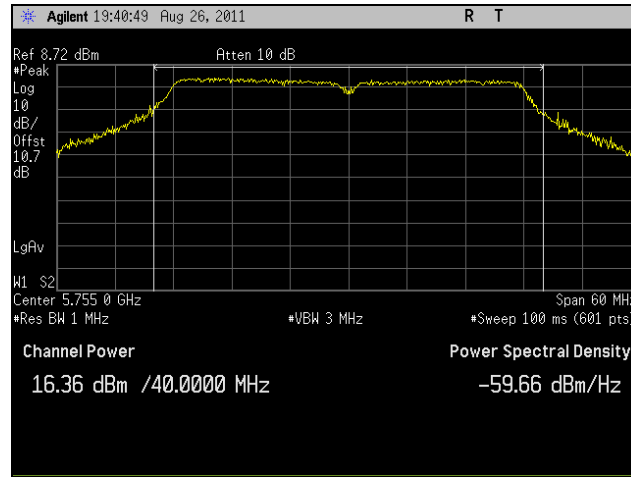
**Plot 54. Peak Power Output, Mid Channel, 802.11n 20 MHz, Port 2**



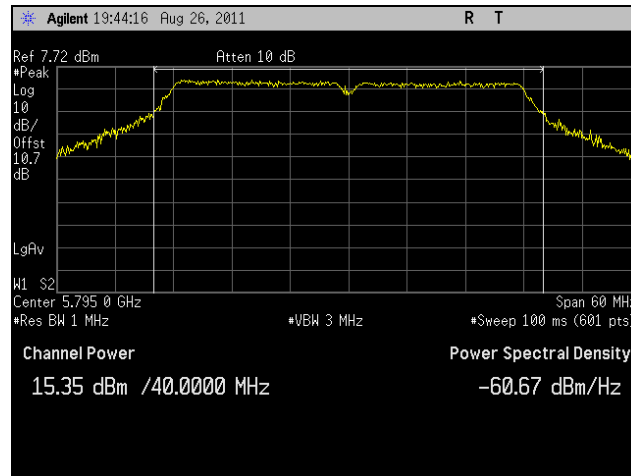
**Plot 55. Peak Power Output, High Channel, 802.11n 20 MHz, Port 2**



**Peak Power Output Test Results, 802.11n 40 MHz, Port 0**

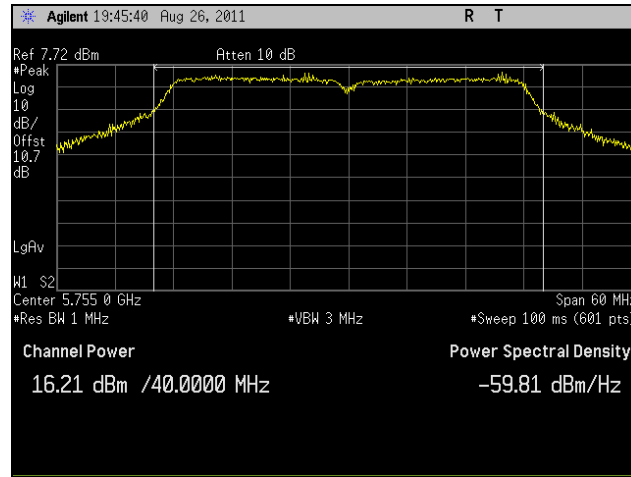


**Plot 56. Peak Power Output, Low Channel, 802.11n 40 MHz, Port 0**

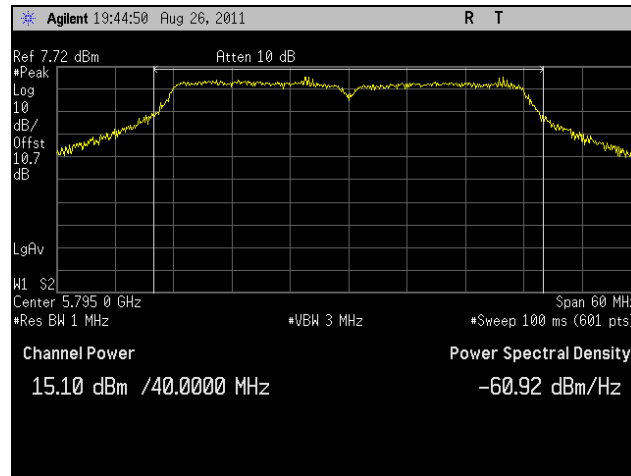


**Plot 57. Peak Power Output, High Channel, 802.11n 40 MHz, Port 0**

**Peak Power Output Test Results, 802.11n 40 MHz, Port 1**

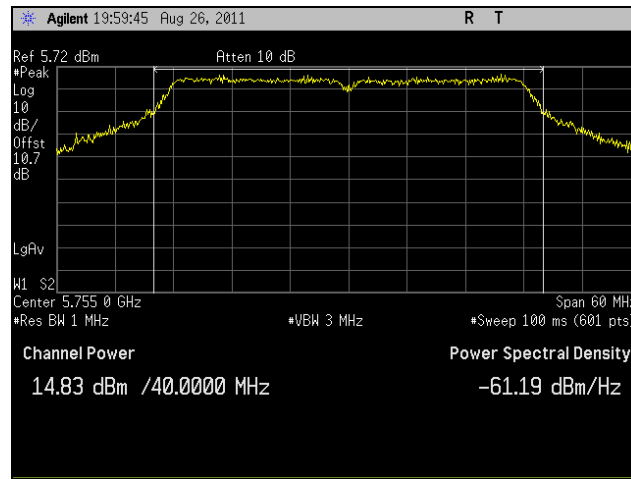


**Plot 58. Peak Power Output, Low Channel, 802.11n 40 MHz, Port 1**

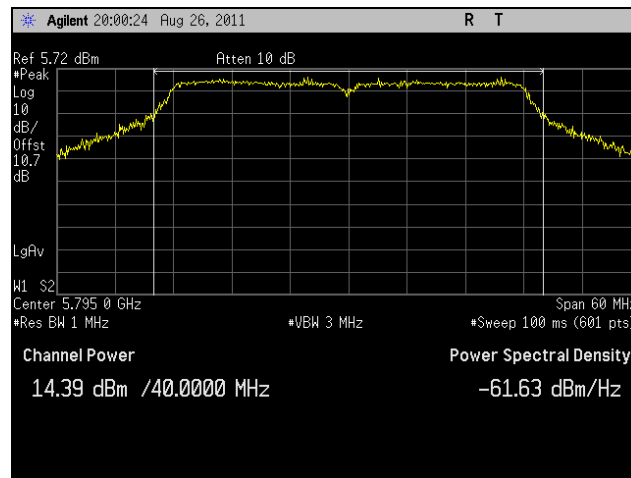


**Plot 59. Peak Power Output, High Channel, 802.11n 40 MHz, Port 1**

**Peak Power Output Test Results, 802.11n 40 MHz, Port 2**



**Plot 60. Peak Power Output, Low Channel, 802.11n 40 MHz, Port 2**



**Plot 61. Peak Power Output, High Channel, 802.11n 40 MHz, Port 2**

## Electromagnetic Compatibility Criteria for Intentional Radiators

### § 15.247(d) Radiated Spurious Emissions Requirements and Band Edge

**Test Requirements:** §15.247(d); §15.205: Emissions outside the frequency band.

**§15.247(d):** In any 100 kHz bandwidth outside the frequency band in which the spread spectrum or digitally modulated intentional radiator is operating, the radio frequency power that is produced by the intentional radiator shall be at least 20 dB below that in the 100 kHz bandwidth within the band that contains the highest level of the desired power, based on either an RF conducted or a radiated measurement. Attenuation below the general limits specified in § 15.209(a) is not required. In addition, radiated emissions which fall in the restricted bands, as defined in § 15.205(a), must also comply with the radiated emission limits specified in § 15.209(a).

**§15.205(a):** Except as shown in paragraph (d) of this section, only spurious emissions are permitted in any of the frequency bands listed below:

| MHz                           | MHz                 | MHz            | GHz              |
|-------------------------------|---------------------|----------------|------------------|
| 0.090–0.110-----              | 16.42–16.423        | 399.9–410      | 4.5–5.15         |
| <sup>1</sup> 0.495–0.505----- | 16.69475–16.69525   | 608–614        | 5.35–5.46        |
| 2.1735–2.1905-----            | 16.80425–16.80475   | 960–1240       | 7.25–7.75        |
| 4.125–4.128-----              | 25.5–25.67          | 1300–1427      | 8.025–8.5        |
| 4.17725–4.17775-----          | 37.5–38.25          | 1435–1626.5    | 9.0–9.2          |
| 4.20725–4.20775-----          | 73–74.6             | 1645.5–1646.5  | 9.3–9.5          |
| 6.215–6.218-----              | 74.8–75.2           | 1660–1710      | 10.6–12.7        |
| 6.26775–6.26825-----          | 108–121.94          | 1718.8–1722.2  | 13.25–13.4       |
| 6.31175–6.31225-----          | 123–138             | 2200–2300      | 14.47–14.5       |
| 8.291–8.294-----              | 149.9–150.05        | 2310–2390      | 15.35–16.2       |
| 8.362–8.366-----              | 156.52475–156.52525 | 2483.5–2500    | 17.7–21.4        |
| 8.37625–8.38675-----          | 156.7–156.9         | 2655–2900      | 22.01–23.12      |
| 8.41425–8.41475-----          | 162.0125–167.17     | 3260–3267      | 23.6–24.0        |
| 12.29–12.293-----             | 167.72–173.2        | 3332–3339      | 31.2–31.8        |
| 12.51975–12.52025-----        | 240–285             | 3345.8–3358.36 | 43–36.5          |
| 12.57675–12.57725-----        | 322–335.4           | 3600–4400      | ( <sup>2</sup> ) |

**Table 22. Restricted Bands of Operation**

<sup>1</sup> Until February 1, 1999, this restricted band shall be 0.490 – 0.510 MHz.

<sup>2</sup> Above 38.6

**Test Requirement(s):** § 15.209 (a): Except as provided elsewhere in this subpart, the emissions from an intentional radiator shall not exceed the field strength levels specified in Table 23.

| Frequency (MHz) | § 15.209(a), Radiated Emission Limits (dBµV) @ 3m |
|-----------------|---|
| 30 - 88         | 40.00   |
| 88 - 216        | 43.50   |
| 216 - 960       | 46.00   |
| Above 960       | 54.00   |

**Table 23. Radiated Emissions Limits Calculated from FCC Part 15, § 15.209 (a)**

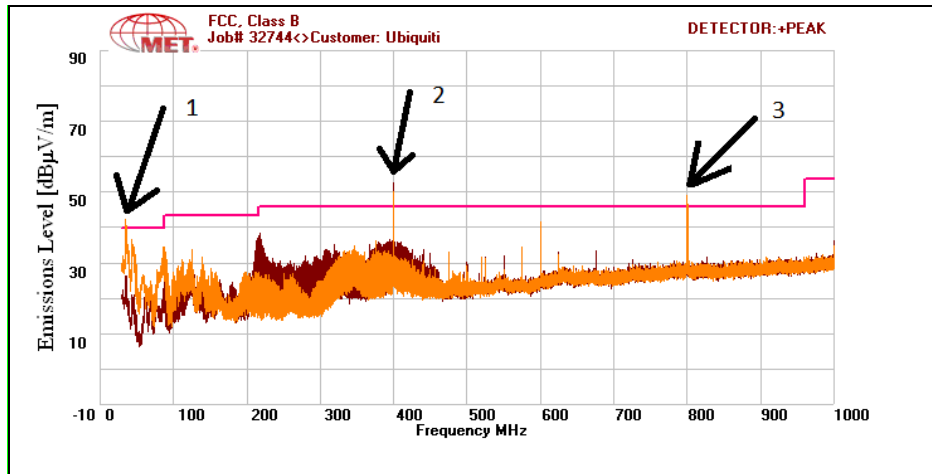
**Test Procedures:** The transmitter was turned on. Measurements were performed of the low, mid and high Channels. The EUT was rotated orthogonally through all three axes. Plots shown are corrected for both antenna correction factor and distance and compared to a 3 m limit line. Only noise floor was measured above 18 GHz.

A scan was done with the Radio powered off from 30MHz - 1GHz. There are 3 distinct peaks found when the Radio is off (See plot 62). Those peaks are digital emissions, and are not emissions of the Radio. To show compliance to 15.209 30MHz - 1GHz the Radio was powered on and compared to the digital emission scan. No Radio emissions were identified as failing.

**Test Results:** The EUT was compliant with the Radiated Spurious Emission limits of § 15.247(d).

**Test Engineer(s):** Lionel Gabrillo

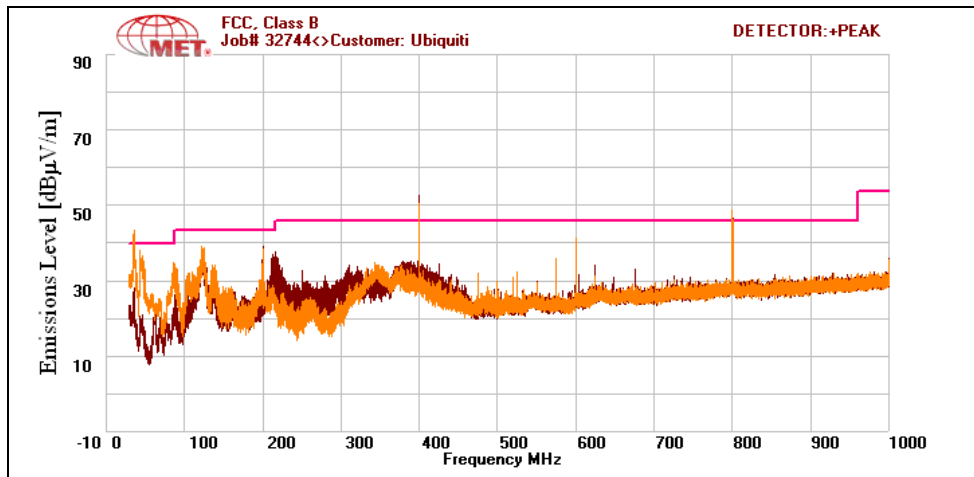
**Test Date(s):** 09/06/11



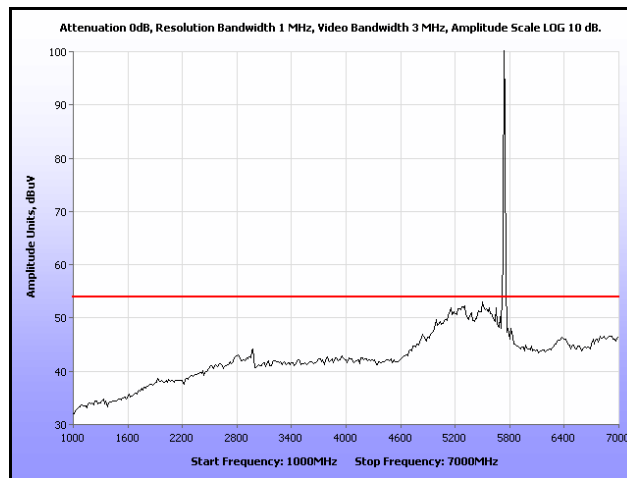
**Plot 62. Radiated Spurious Emissions, Radio OFF**

There are 3 distinct peaks found when the radio is OFF (See plot 62 above). Those 3 peaks are digital emissions of the EUT when the radio is powered off.

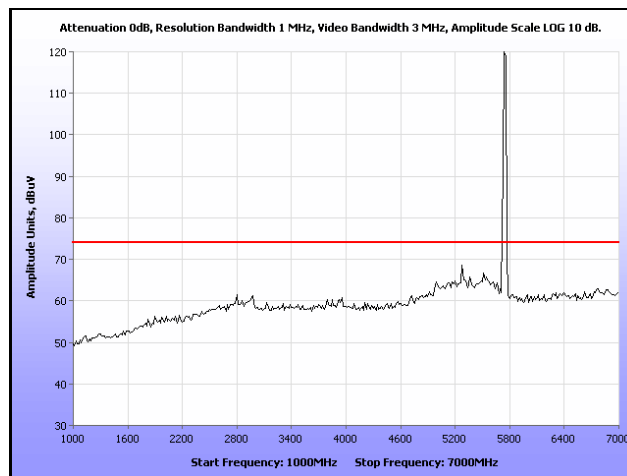
**Radiated Spurious Emissions Test Results, 802.11a**



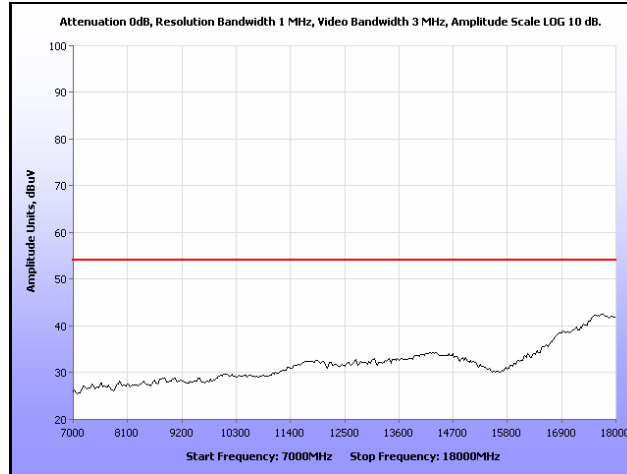
**Plot 63. Radiated Spurious Emissions, Low Channel, 802.11a, 30 MHz – 1 GHz**



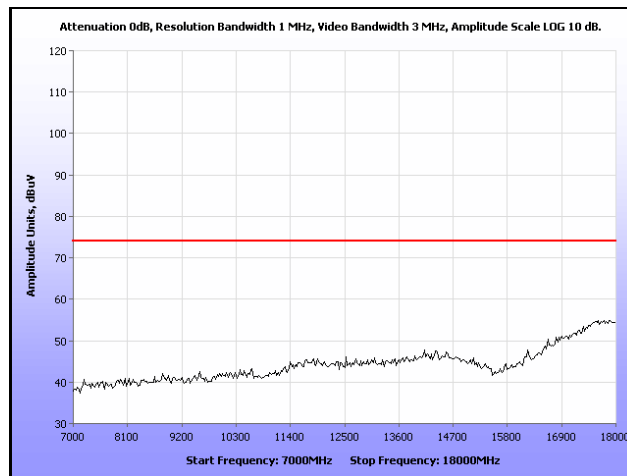
**Plot 64. Radiated Spurious Emissions, Low Channel, 802.11a, 1 GHz – 7 GHz, Average**



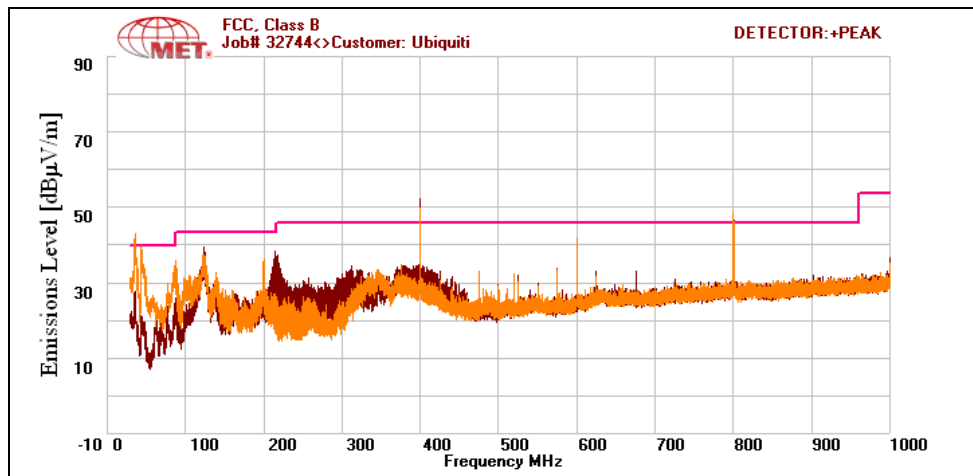
**Plot 65. Radiated Spurious Emissions, Low Channel, 802.11a, 1 GHz – 7 GHz, Peak**



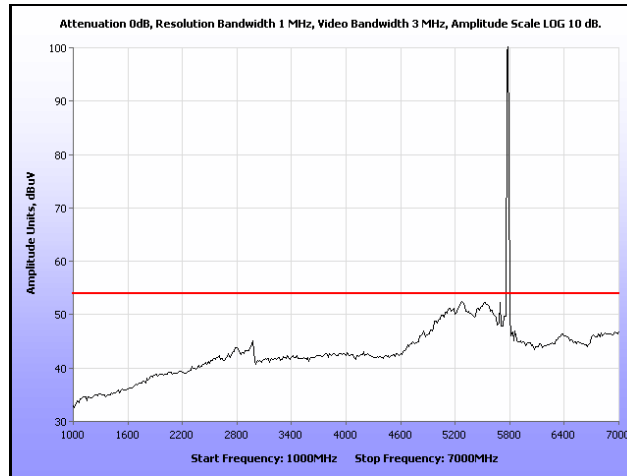
Plot 66. Radiated Spurious Emissions, Low Channel, 802.11a, 7 GHz – 18 GHz, Average



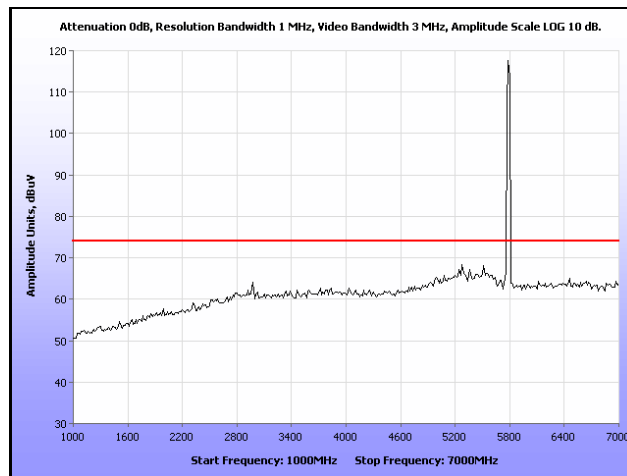
Plot 67. Radiated Spurious Emissions, Low Channel, 802.11a, 7 GHz – 18 GHz, Peak



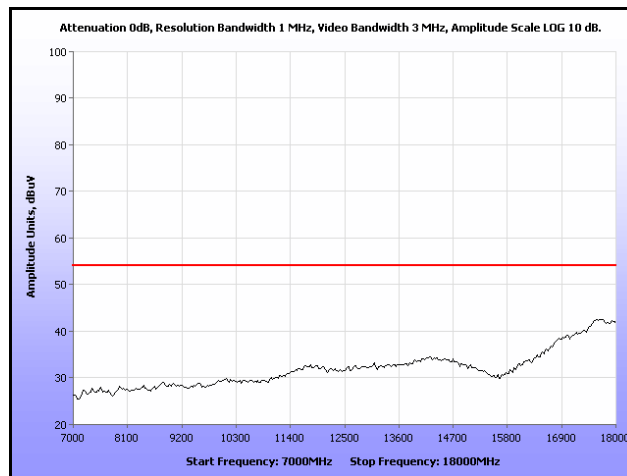
Plot 68. Radiated Spurious Emissions, Mid Channel, 802.11a, 30 MHz – 1 GHz



**Plot 69. Radiated Spurious Emissions, Mid Channel, 802.11a, 1 GHz – 7 GHz, Average**

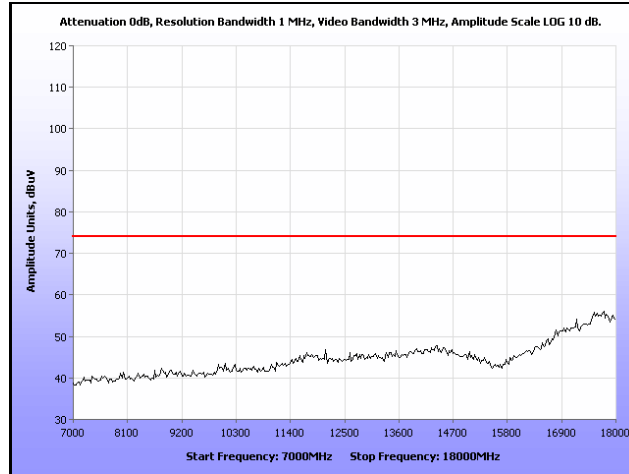


**Plot 70. Radiated Spurious Emissions, Mid Channel, 802.11a, 1 GHz – 7 GHz, Peak**

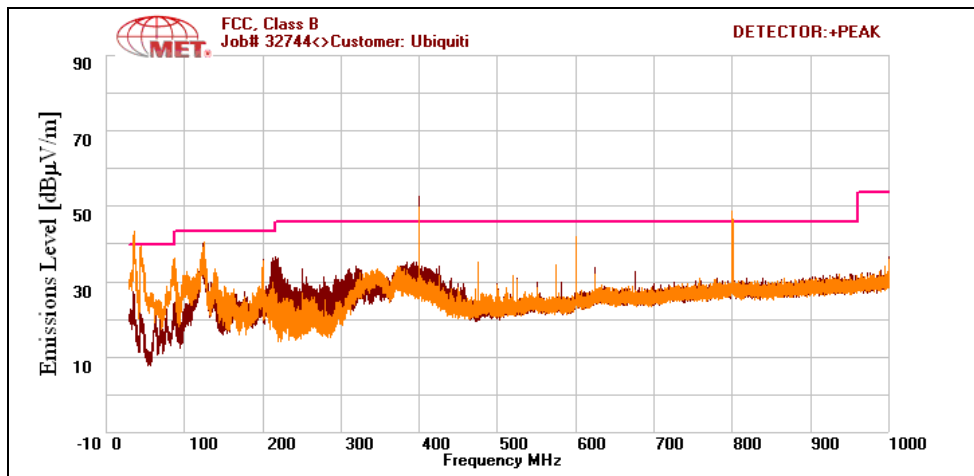


**Plot 71. Radiated Spurious Emissions, Mid Channel, 802.11a, 7 GHz – 18 GHz, Average**

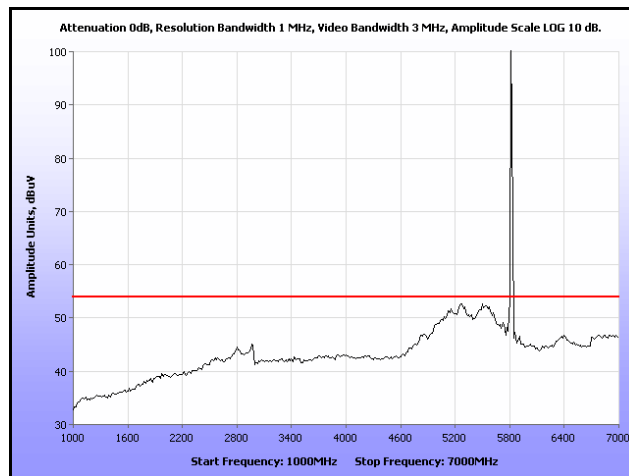




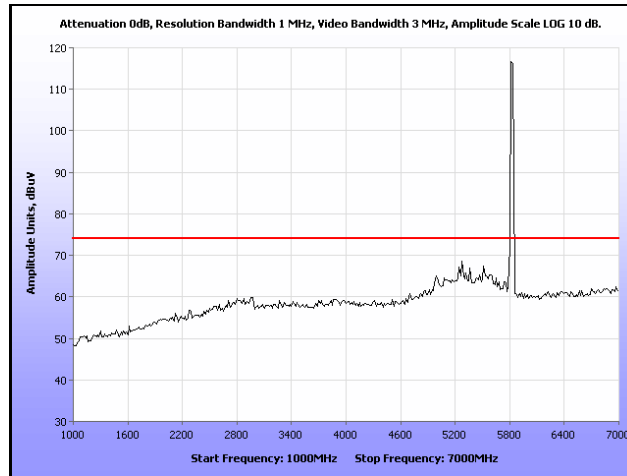
**Plot 72. Radiated Spurious Emissions, Mid Channel, 802.11a, 7 GHz – 18 GHz, Peak**



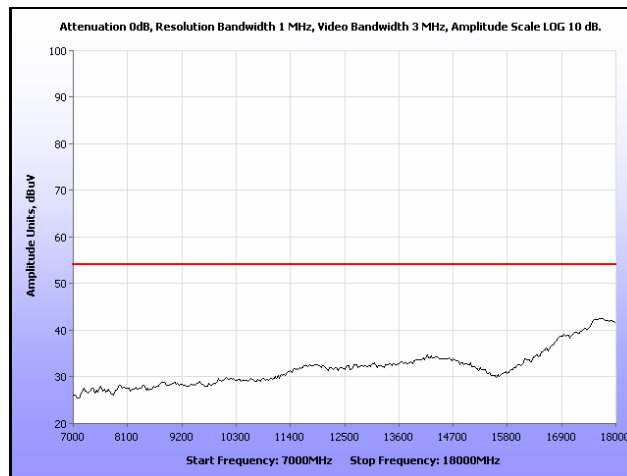
**Plot 73. Radiated Spurious Emissions, High Channel, 802.11a, 30 MHz – 1 GHz**



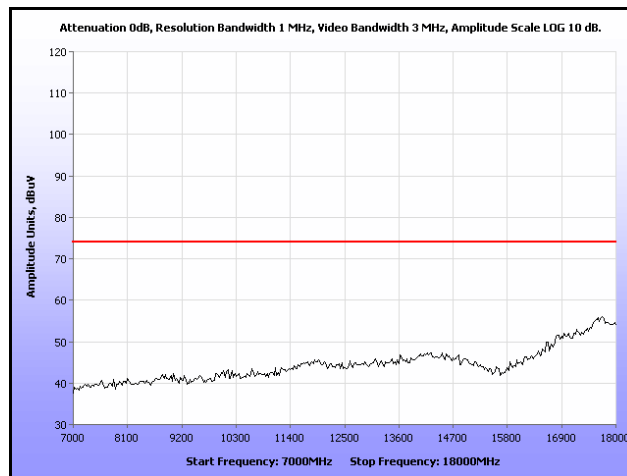
**Plot 74. Radiated Spurious Emissions, High Channel, 802.11a, 1 GHz – 7 GHz, Average**



**Plot 75. Radiated Spurious Emissions, High Channel, 802.11a, 1 GHz – 7 GHz, Peak**

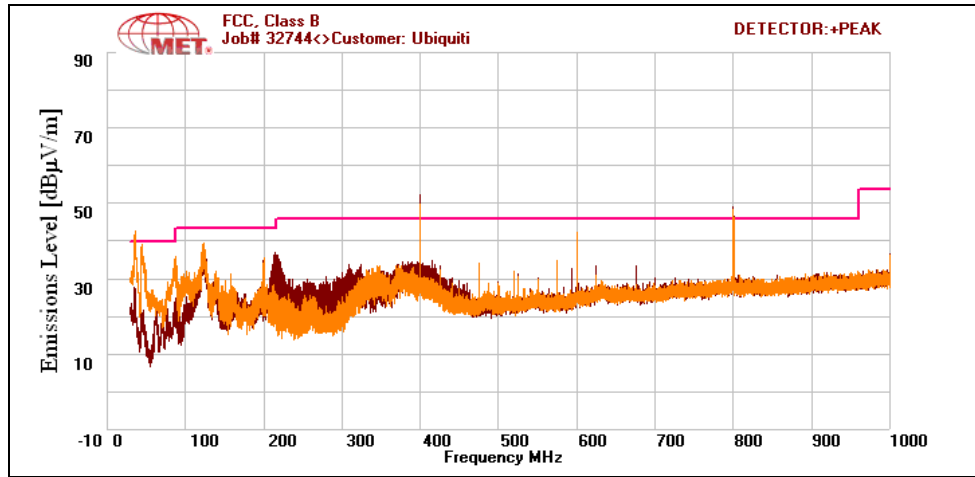


**Plot 76. Radiated Spurious Emissions, High Channel, 802.11a, 7 GHz – 18 GHz, Average**

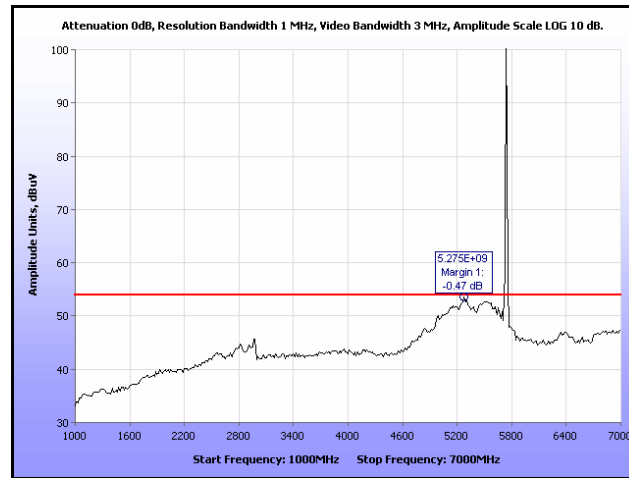


**Plot 77. Radiated Spurious Emissions, High Channel, 802.11a, 7 GHz – 18 GHz, Peak**

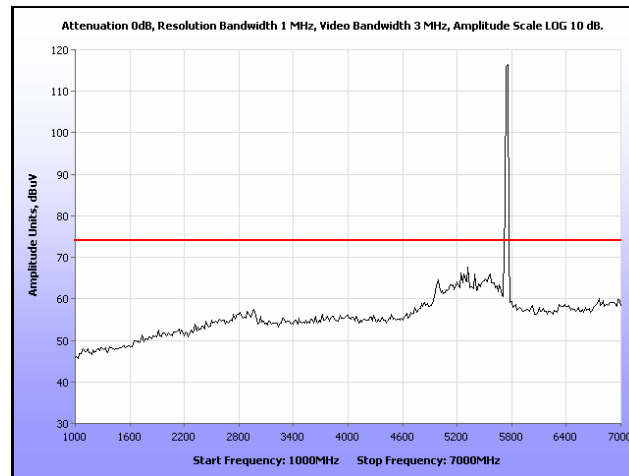
**Radiated Spurious Emissions Test Results, 802.11n 20 MHz**



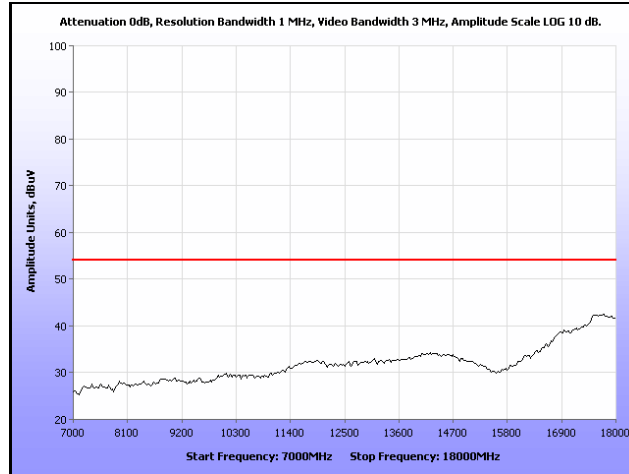
**Plot 78. Radiated Spurious Emissions, Low Channel, 802.11n 20 MHz, 30 MHz – 1 GHz**



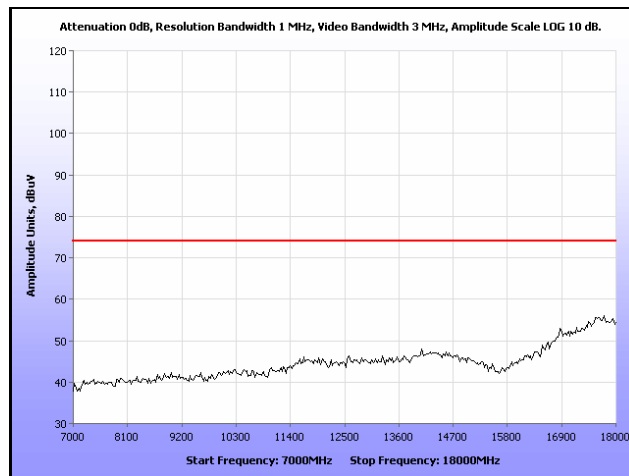
**Plot 79. Radiated Spurious Emissions, Low Channel, 802.11n 20 MHz, 1 GHz – 7 GHz, Average**



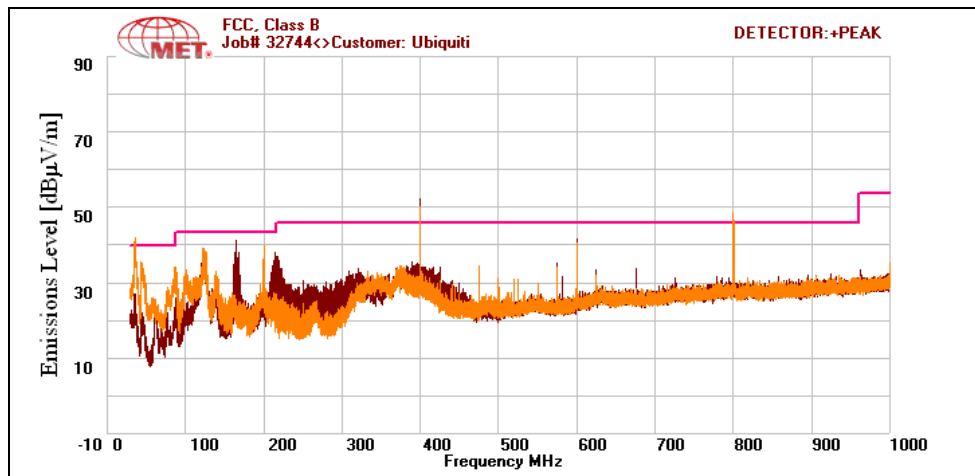
**Plot 80. Radiated Spurious Emissions, Low Channel, 802.11n 20 MHz, 1 GHz – 7 GHz, Peak**



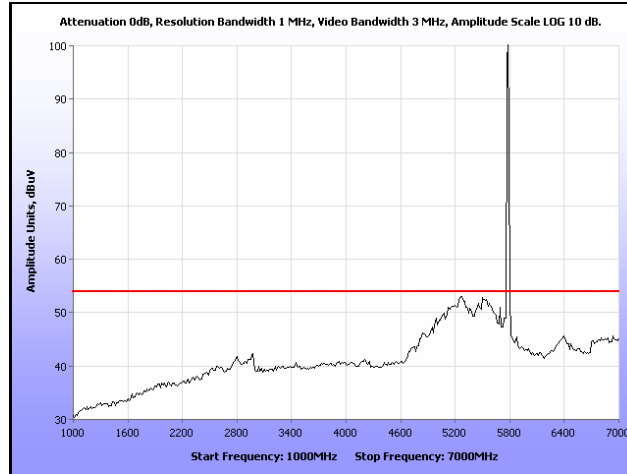
Plot 81. Radiated Spurious Emissions, Low Channel, 802.11n 20 MHz, 7 GHz – 18 GHz, Average



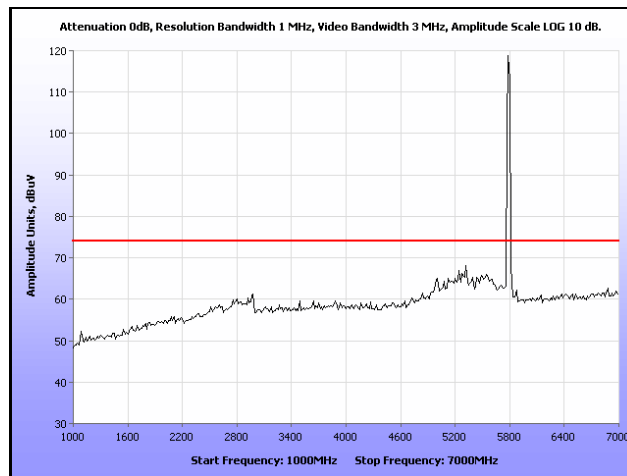
Plot 82. Radiated Spurious Emissions, Low Channel, 802.11n 20 MHz, 7 GHz – 18 GHz, Peak



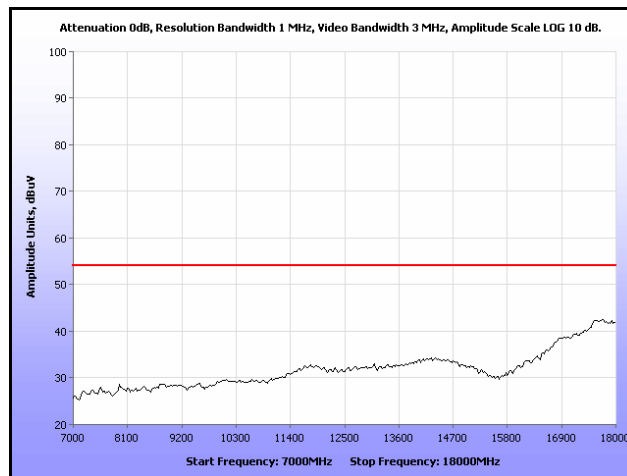
Plot 83. Radiated Spurious Emissions, Mid Channel, 802.11n 20 MHz, 30 MHz – 1 GHz



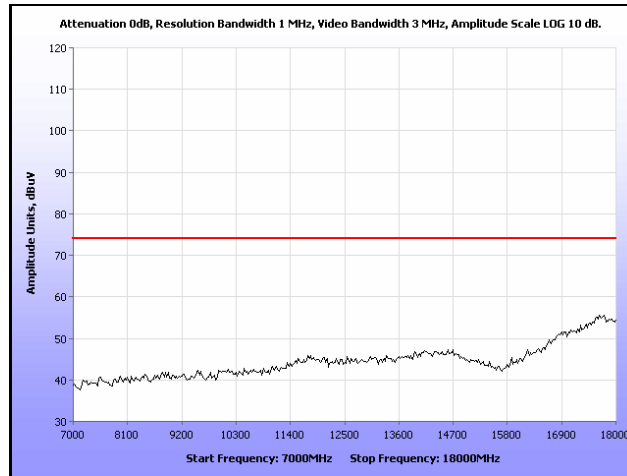
**Plot 84. Radiated Spurious Emissions, Mid Channel, 802.11n 20 MHz, 1 GHz – 7 GHz, Average**



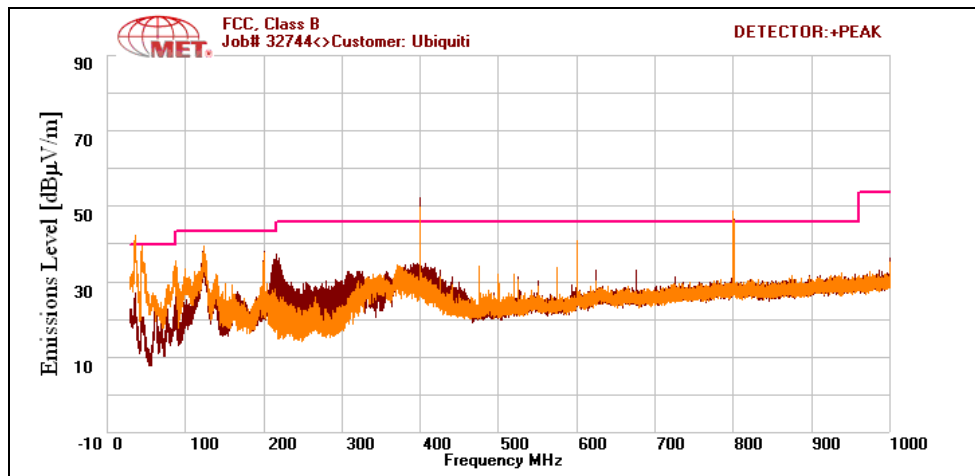
**Plot 85. Radiated Spurious Emissions, Mid Channel, 802.11n 20 MHz, 1 GHz – 7 GHz, Peak**



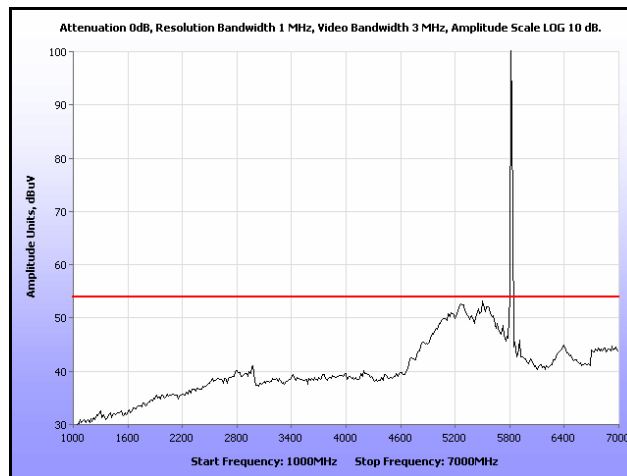
**Plot 86. Radiated Spurious Emissions, Mid Channel, 802.11n 20 MHz, 7 GHz – 18 GHz, Average**



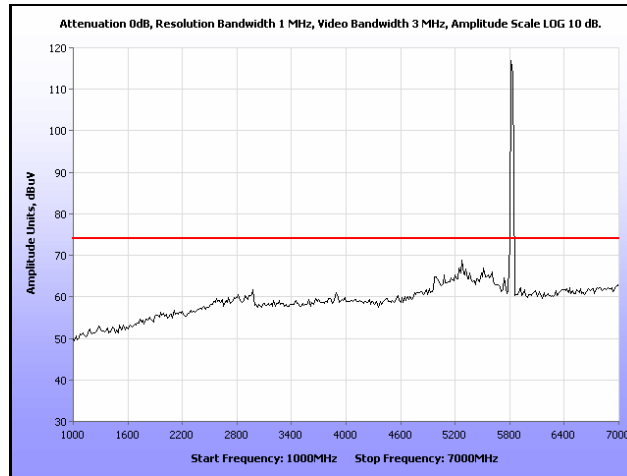
Plot 87. Radiated Spurious Emissions, Mid Channel, 802.11n 20 MHz, 7 GHz – 18 GHz, Peak



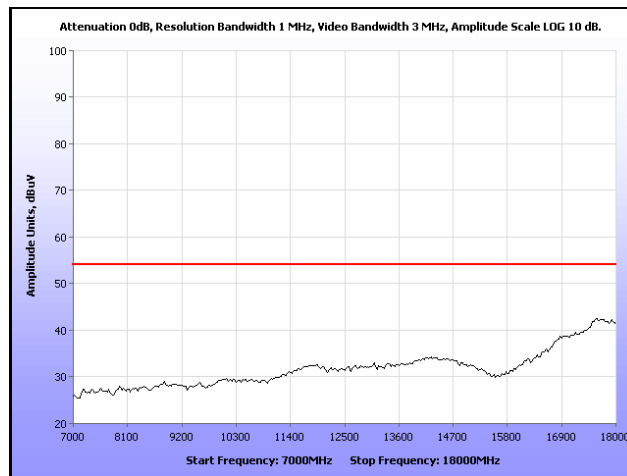
Plot 88. Radiated Spurious Emissions, High Channel, 802.11n 20 MHz, 30 MHz – 1 GHz



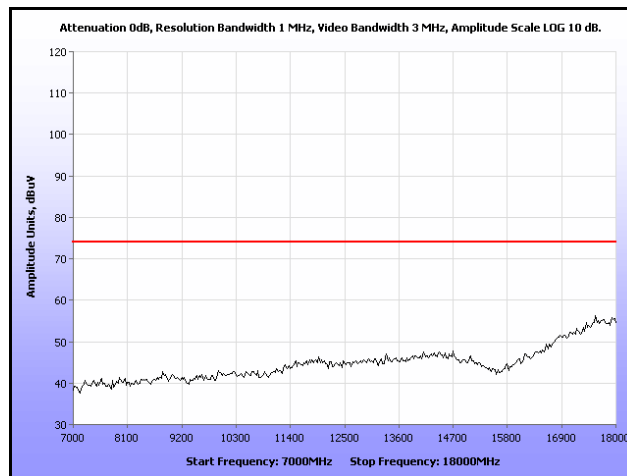
Plot 89. Radiated Spurious Emissions, High Channel, 802.11n 20 MHz, 1 GHz – 7 GHz, Average



**Plot 90. Radiated Spurious Emissions, High Channel, 802.11n 20 MHz, 1 GHz – 7 GHz, Peak**

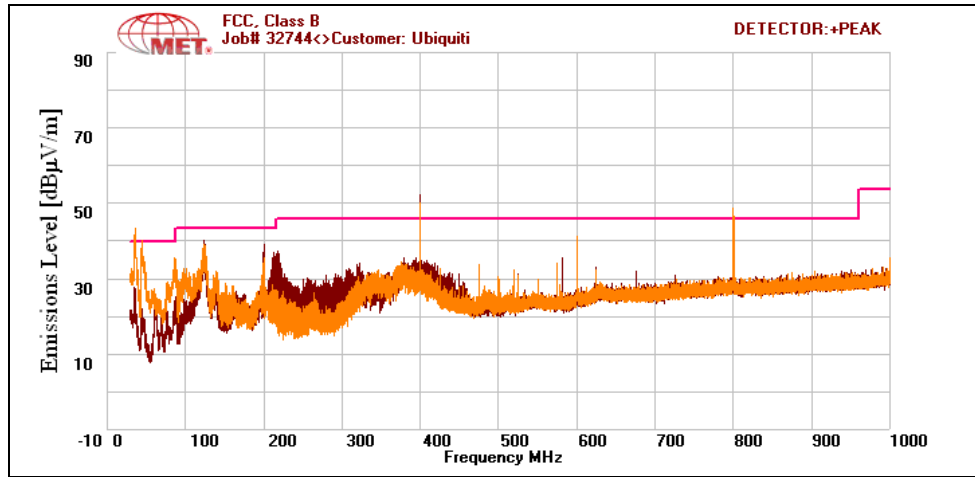


**Plot 91. Radiated Spurious Emissions, High Channel, 802.11n 20 MHz, 7 GHz – 18 GHz, Average**

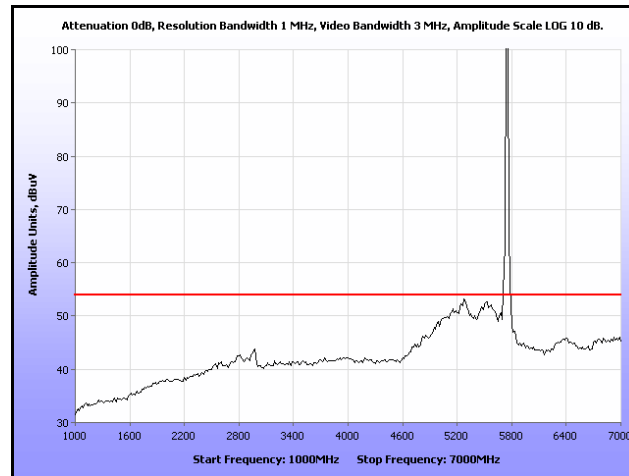


**Plot 92. Radiated Spurious Emissions, High Channel, 802.11n 20 MHz, 7 GHz – 18 GHz, Peak**

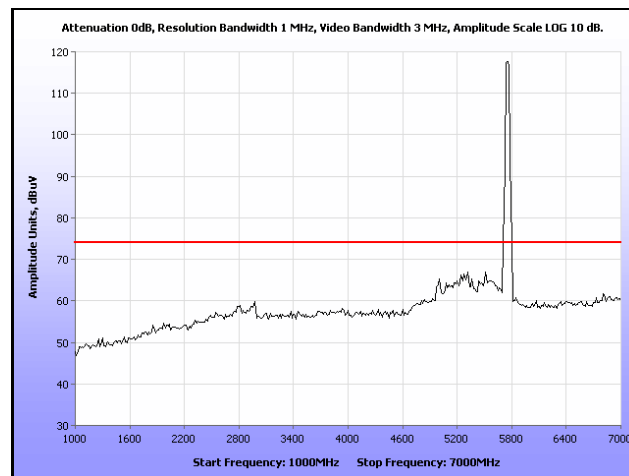
### Radiated Spurious Emissions Test Results, 802.11n 40 MHz



Plot 93. Radiated Spurious Emissions, Low Channel, 802.11n 40 MHz, 30 MHz – 1 GHz

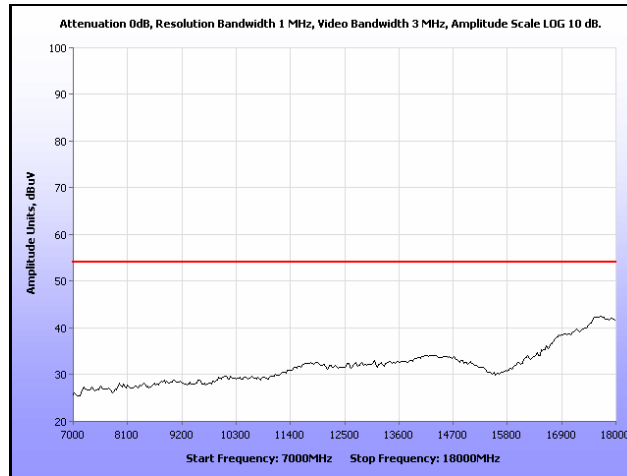


Plot 94. Radiated Spurious Emissions, Low Channel, 802.11n 40 MHz, 1 GHz – 7 GHz, Average

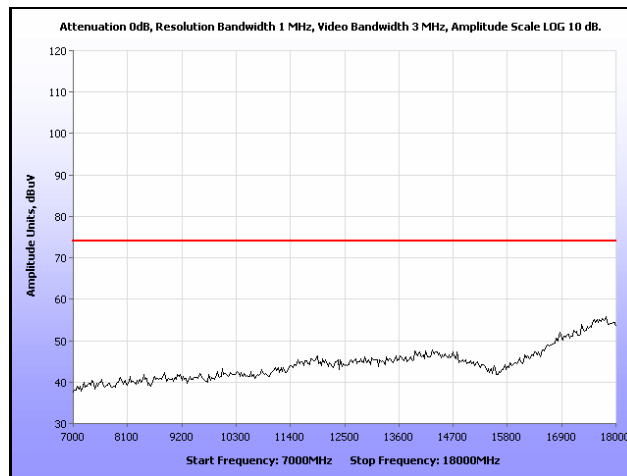


Plot 95. Radiated Spurious Emissions, Low Channel, 802.11n 40 MHz, 1 GHz – 7 GHz, Peak

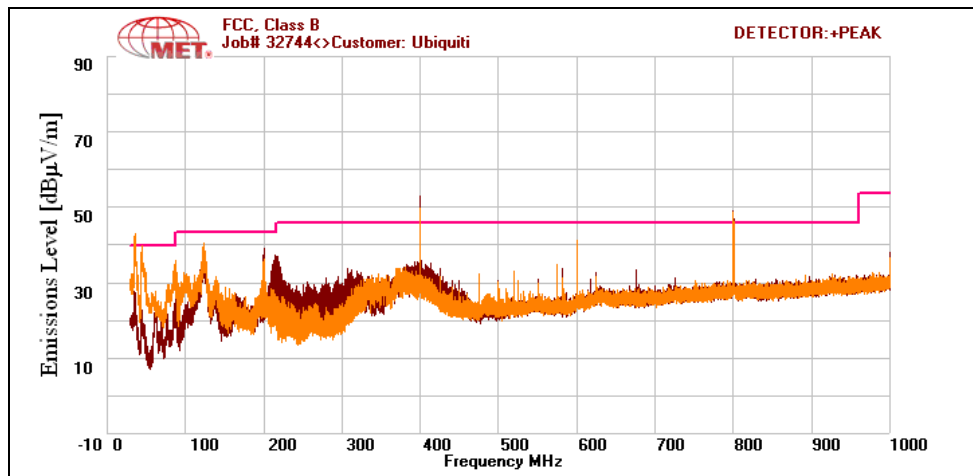




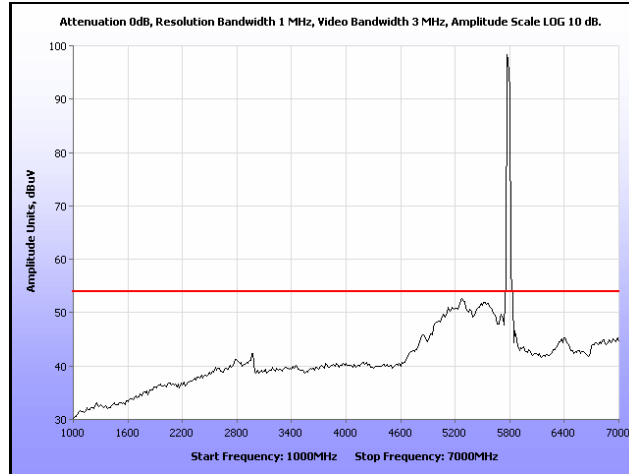
Plot 96. Radiated Spurious Emissions, Low Channel, 802.11n 40 MHz, 7 GHz – 18 GHz, Average



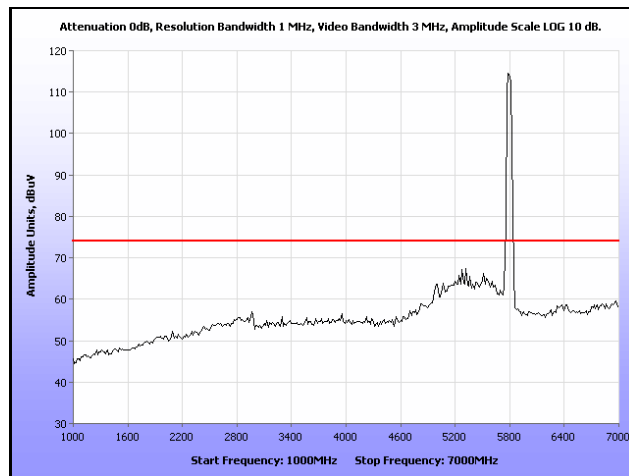
Plot 97. Radiated Spurious Emissions, Low Channel, 802.11n 40 MHz, 7 GHz – 18 GHz, Peak



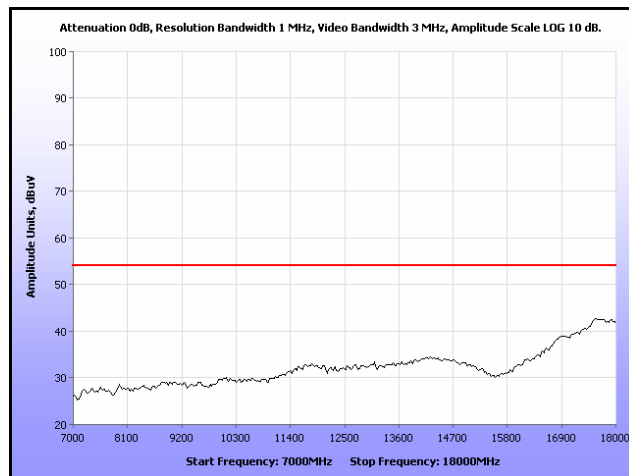
Plot 98. Radiated Spurious Emissions, High Channel, 802.11n 40 MHz, 30 MHz – 1 GHz



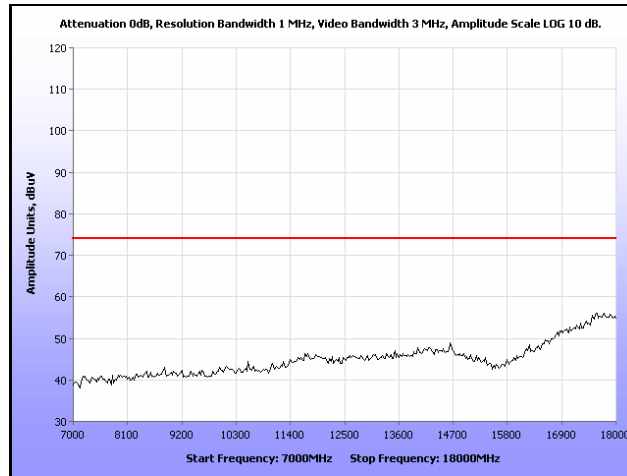
**Plot 99. Radiated Spurious Emissions, High Channel, 802.11n 40 MHz, 1 GHz – 7 GHz, Average**



**Plot 100. Radiated Spurious Emissions, High Channel, 802.11n 40 MHz, 1 GHz – 7 GHz, Peak**



**Plot 101. Radiated Spurious Emissions, High Channel, 802.11n 40 MHz, 7 GHz – 18 GHz, Average**



**Plot 102. Radiated Spurious Emissions, High Channel, 802.11n 40 MHz, 7 GHz – 18 GHz, Peak**

## Electromagnetic Compatibility Criteria for Intentional Radiators

### § 15.247(d) RF Conducted Spurious Emissions Requirements and Band Edge

**Test Requirement:** **15.247(d)** In any 100 kHz bandwidth outside the frequency band in which the spread spectrum or digitally modulated intentional radiator is operating, the radio frequency power that is produced by the intentional radiator shall be at least 20 dB below that in the 100 kHz bandwidth within the band that contains the highest level of the desired power, based on either an RF conducted or a radiated measurement, provided the transmitter demonstrates compliance with the peak conducted power limits. If the transmitter complies with the conducted power limits based on the use of RMS averaging over a time interval, as permitted under paragraph (b)(3) of this section, the attenuation required under this paragraph shall be 30 dB instead of 20 dB.

**Test Procedure:** For intentional radiators with a digital device portion which operates below 10 GHz, the spectrum was investigated as per §15.33(a)(1) and §15.33(a)(4); i.e., the lowest RF signal generated or used in the device up to the 10<sup>th</sup> harmonic of the highest fundamental frequency or to 40 GHz, whichever is lower.

A conducted sample was provided fitted with a SMA connector. The EUT was connected from the SMA connector to a spectrum analyzer using a 10 dB Attenuator. Testing was performed on Low, Mid and High Channels. A resolution bandwidth of 100kHz and video bandwidth of 300kHz were utilized.

For conducted band edge, a delta measurement was taken from the peak of the fundamental to the Band edge then compared to the limit.

See following pages for detailed test results with RF Conducted Spurious Emissions.

**Test Results:** The EUT was compliant with the Conducted Spurious Emission limits of §15.247(d).

**Test Engineer(s):** Anderson Soungpanya

**Test Date(s):** 08/30/11

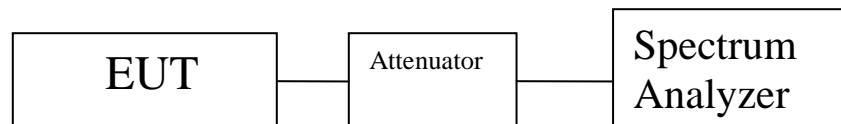
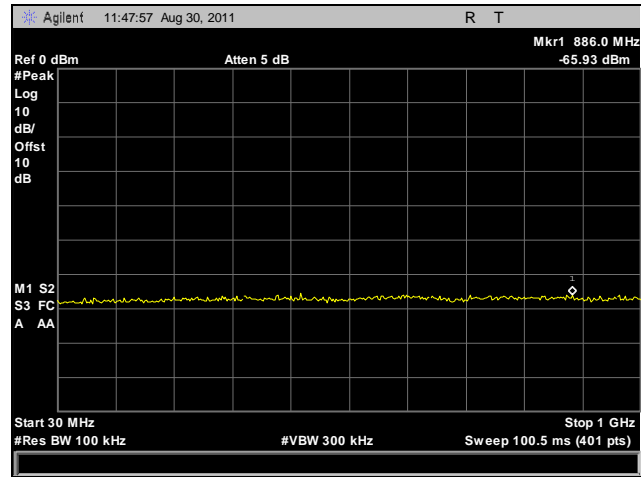
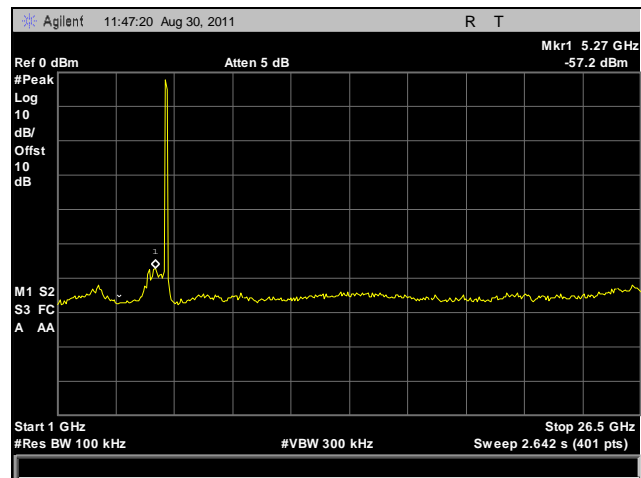


Figure 4. Block Diagram, Conducted Spurious Emissions Test Setup

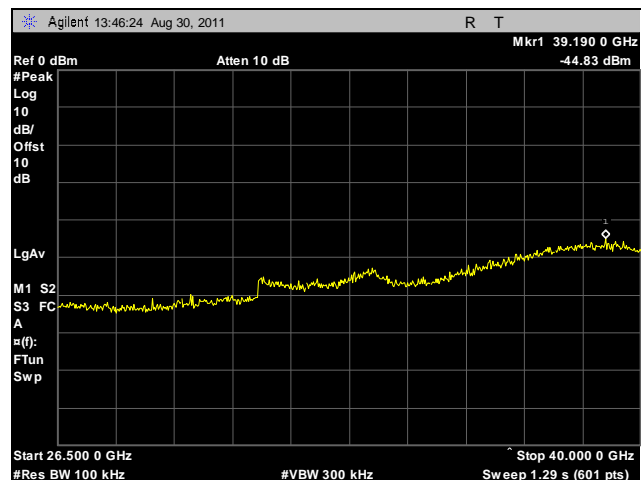
## Conducted Spurious Emissions Test Results, 802.11a



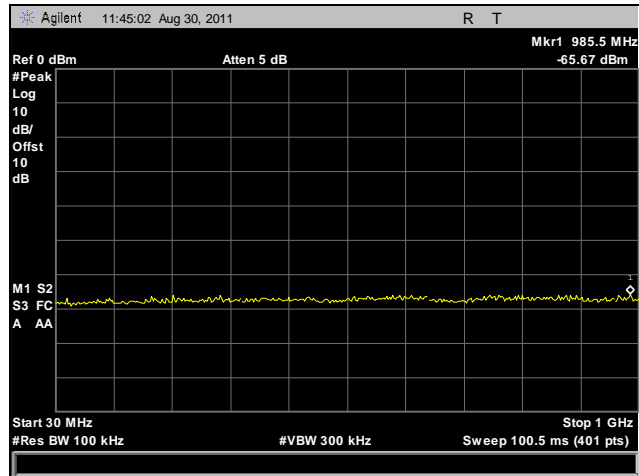
Plot 103. Conducted Spurious Emissions, Low Channel, 802.11a, 30 MHz – 1 GHz



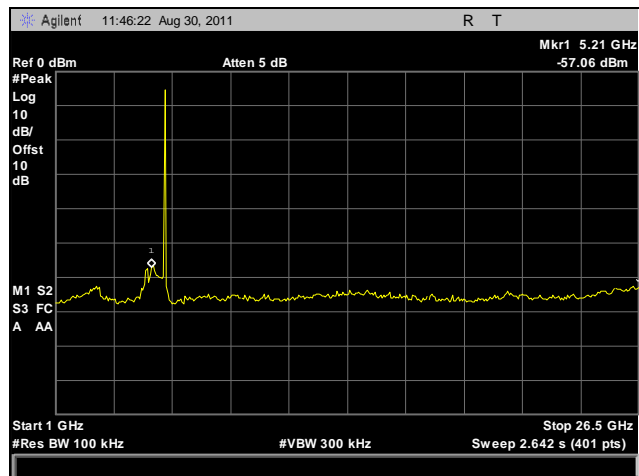
Plot 104. Conducted Spurious Emissions, Low Channel, 802.11a, 1 GHz – 26.5 GHz



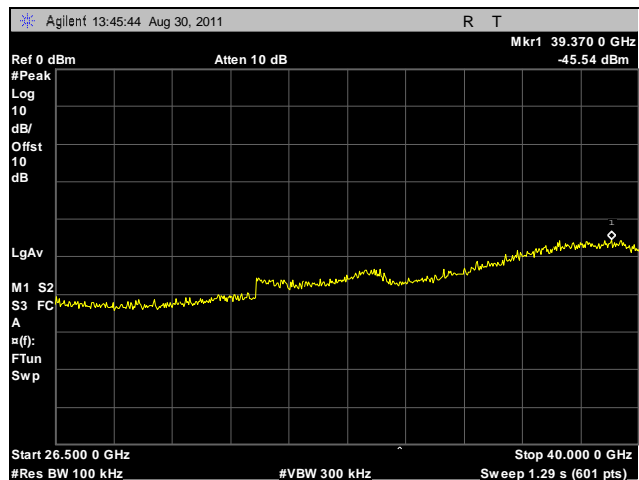
Plot 105. Conducted Spurious Emissions, Low Channel, 802.11a, 26.5 GHz – 40 GHz



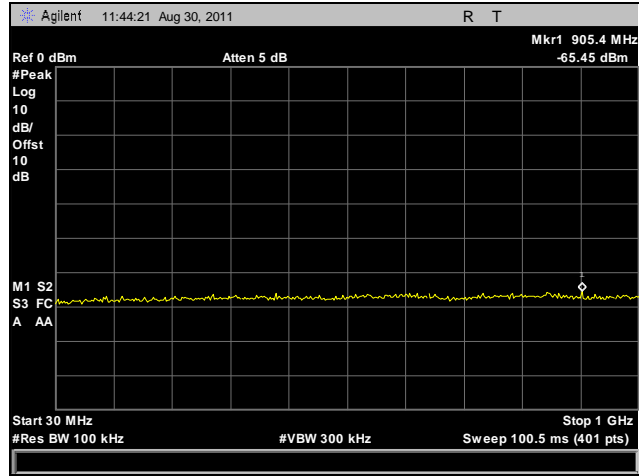
Plot 106. Conducted Spurious Emissions, Mid Channel, 802.11a, 30 MHz – 1 GHz



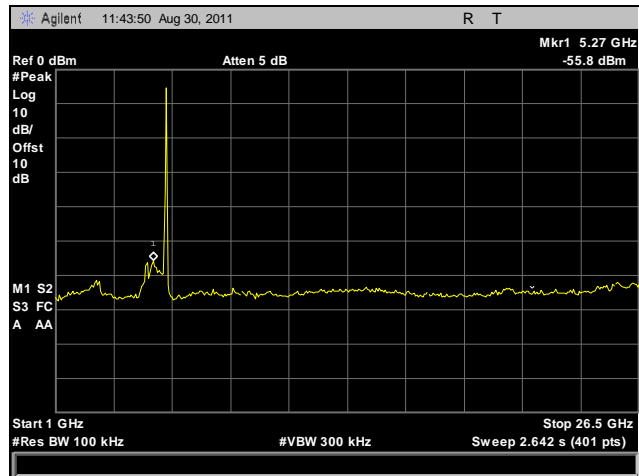
Plot 107. Conducted Spurious Emissions, Mid Channel, 802.11a, 1 GHz – 26.5 GHz



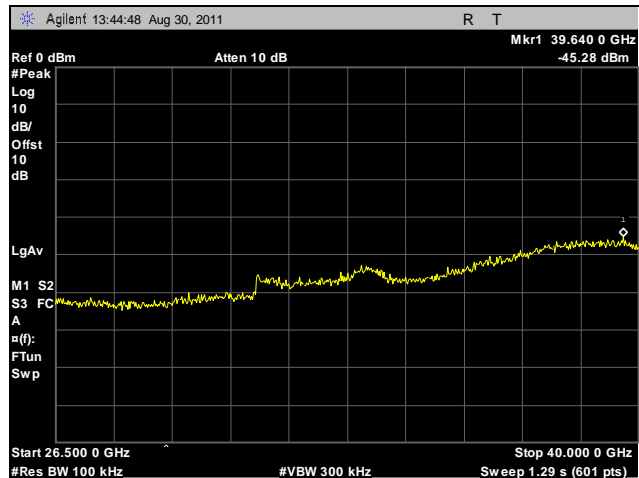
Plot 108. Conducted Spurious Emissions, Mid Channel, 802.11a, 26.5 GHz – 40 GHz



Plot 109. Conducted Spurious Emissions, High Channel, 802.11a, 30 MHz – 1 GHz

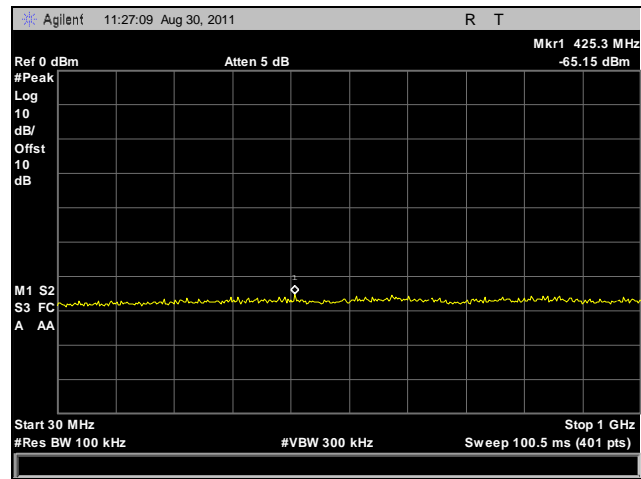


Plot 110. Conducted Spurious Emissions, High Channel, 802.11a, 1 GHz – 26.5 GHz

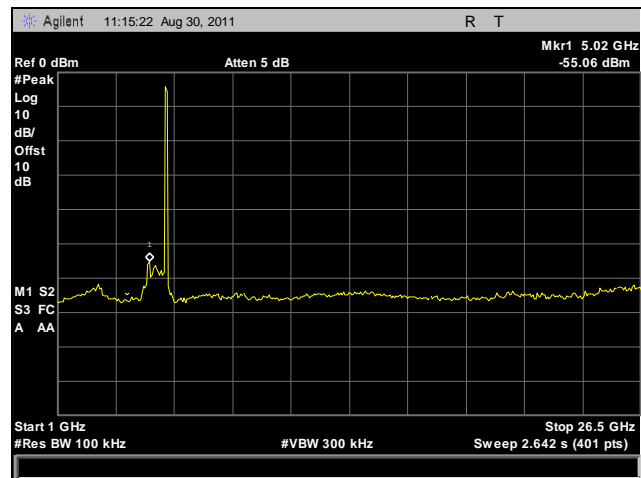


Plot 111. Conducted Spurious Emissions, High Channel, 802.11a, 26.5 GHz – 40 GHz

### Conducted Spurious Emissions Test Results, 802.11n 20 MHz, Port 0



Plot 112. Conducted Spurious Emissions, Low Channel, 802.11n 20 MHz, Port 0, 30 MHz – 1 GHz

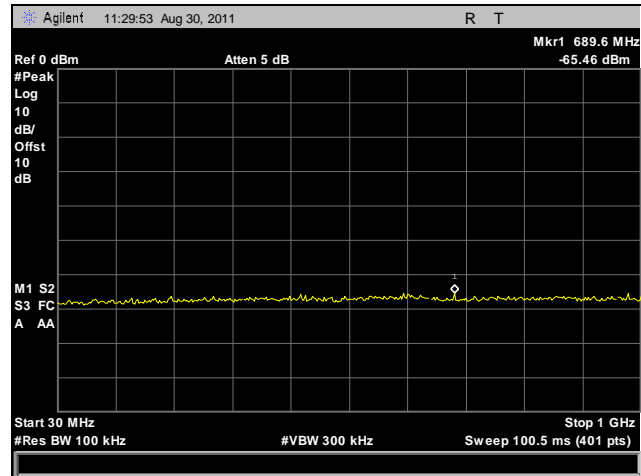


Plot 113. Conducted Spurious Emissions, Low Channel, 802.11n 20 MHz, Port 0, 1 GHz – 26.5 GHz

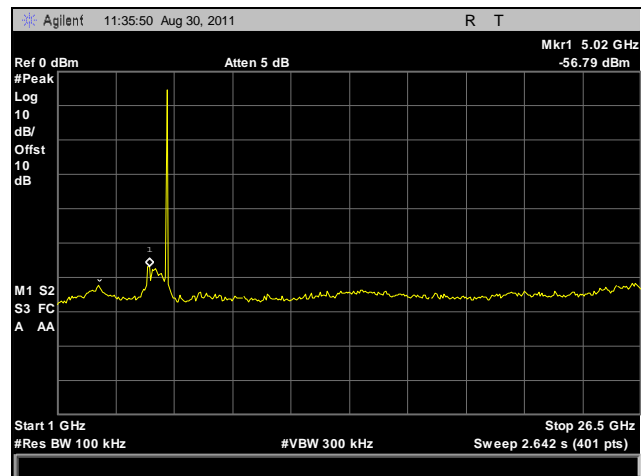


Plot 114. Conducted Spurious Emissions, Low Channel, 802.11n 20 MHz, Port 0, 26.5 GHz – 40 GHz

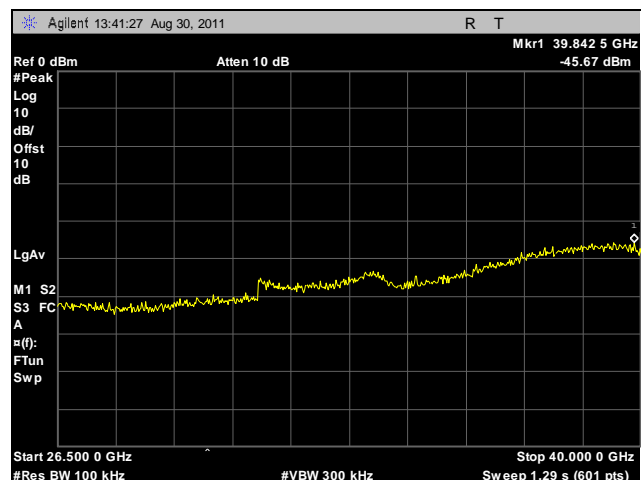




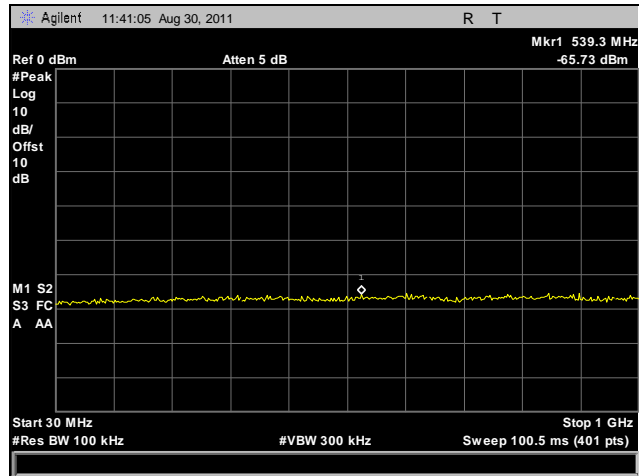
Plot 115. Conducted Spurious Emissions, Mid Channel, 802.11n 20 MHz, Port 0, 30 MHz – 1 GHz



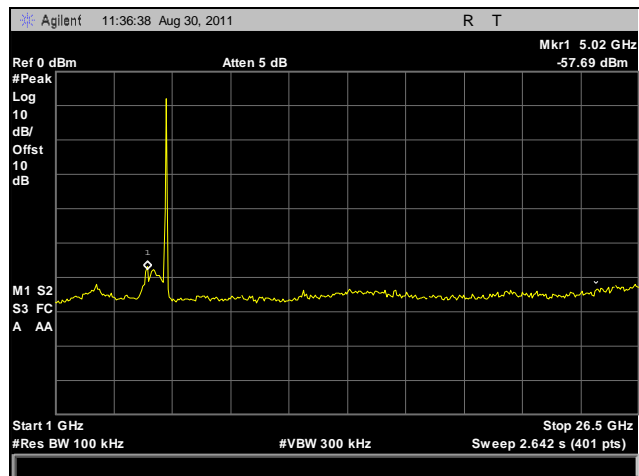
Plot 116. Conducted Spurious Emissions, Mid Channel, 802.11n 20 MHz, Port 0, 1 GHz – 26.5 GHz



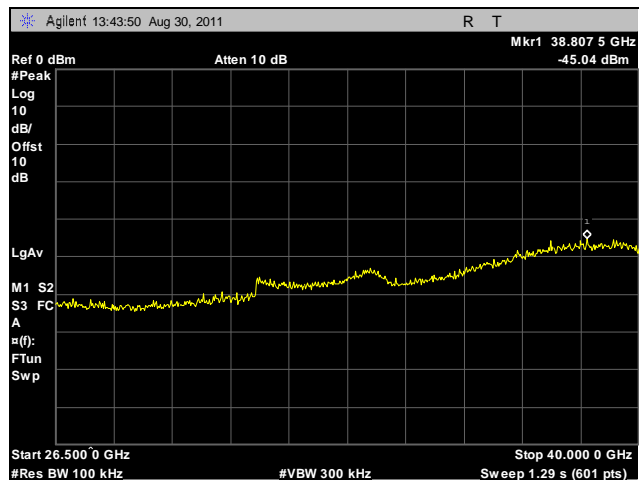
Plot 117. Conducted Spurious Emissions, Mid Channel, 802.11n 20 MHz, Port 0, 26.5 GHz – 40 GHz



Plot 118. Conducted Spurious Emissions, High Channel, 802.11n 20 MHz, Port 0, 30 MHz – 1 GHz

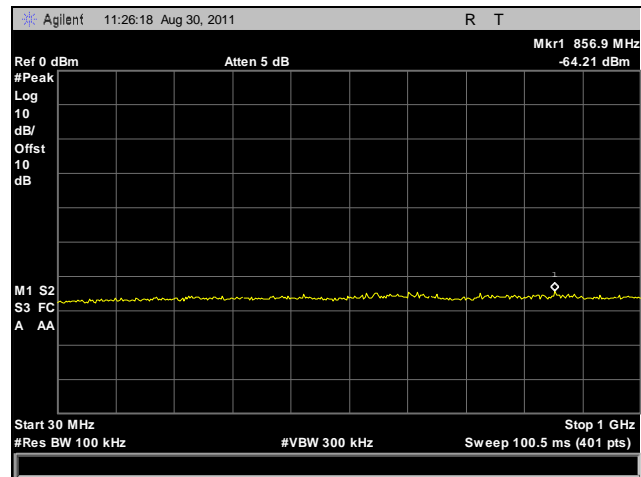


Plot 119. Conducted Spurious Emissions, High Channel, 802.11n 20 MHz, Port 0, 1 GHz – 26.5 GHz

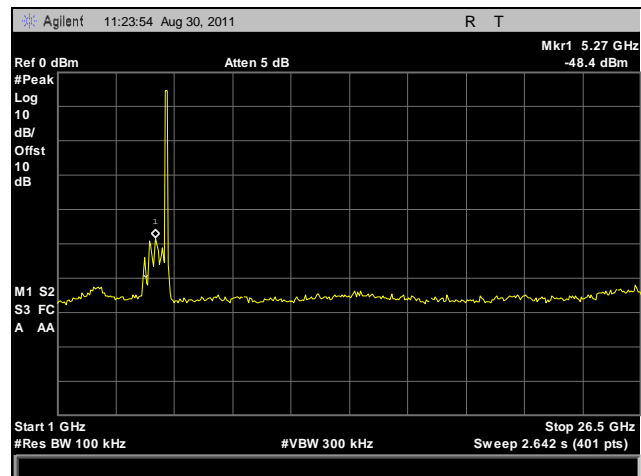


Plot 120. Conducted Spurious Emissions, High Channel, 802.11n 20 MHz, Port 0, 26.5 GHz – 40 GHz

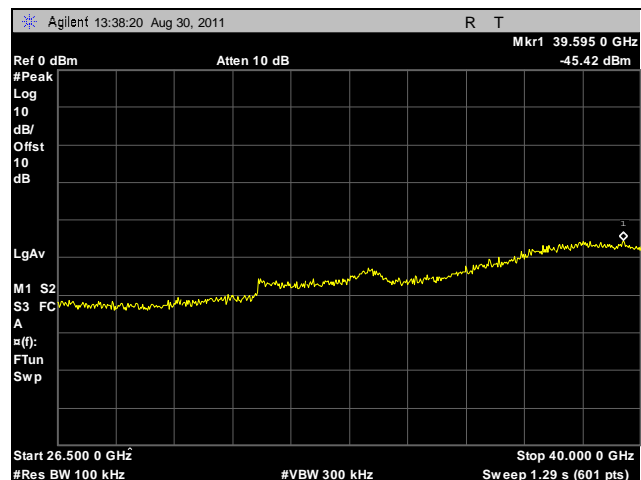
## Conducted Spurious Emissions Test Results, 802.11n 20 MHz, Port 1



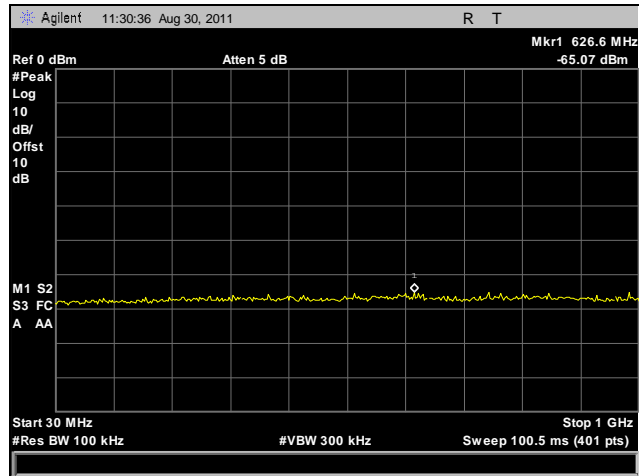
Plot 121. Conducted Spurious Emissions, Low Channel, 802.11n 20 MHz, Port 1, 30 MHz – 1 GHz



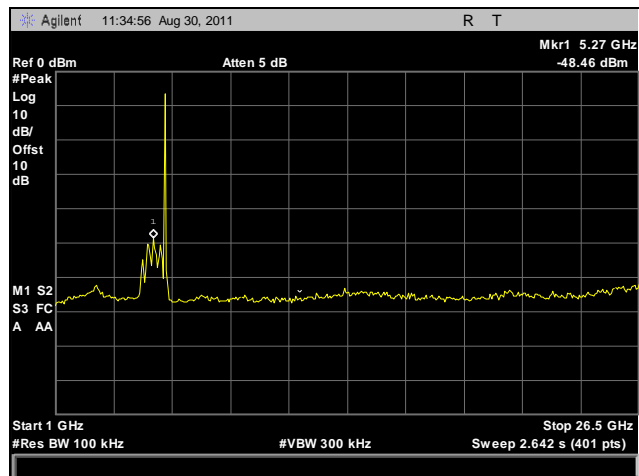
Plot 122. Conducted Spurious Emissions, Low Channel, 802.11n 20 MHz, Port 1, 1 GHz – 26.5 GHz



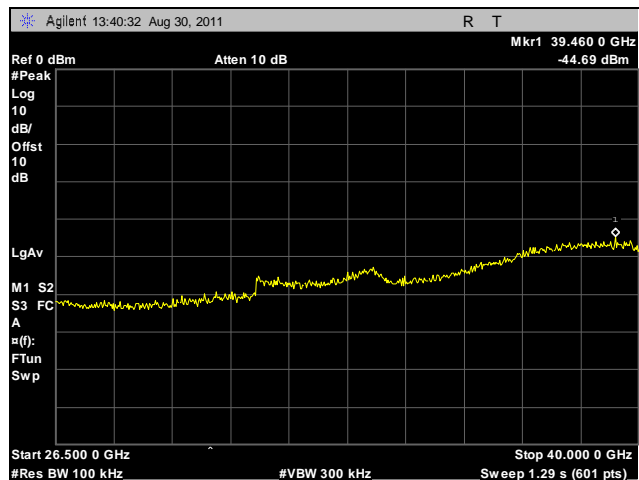
Plot 123. Conducted Spurious Emissions, Low Channel, 802.11n 20 MHz, Port 1, 26.5 GHz – 40 GHz



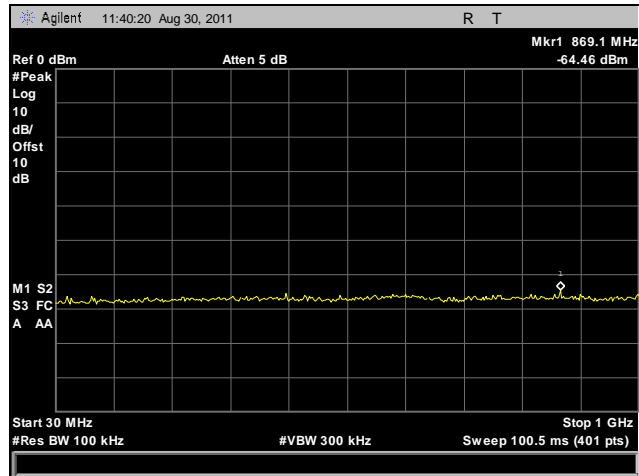
Plot 124. Conducted Spurious Emissions, Mid Channel, 802.11n 20 MHz, Port 1, 30 MHz – 1 GHz



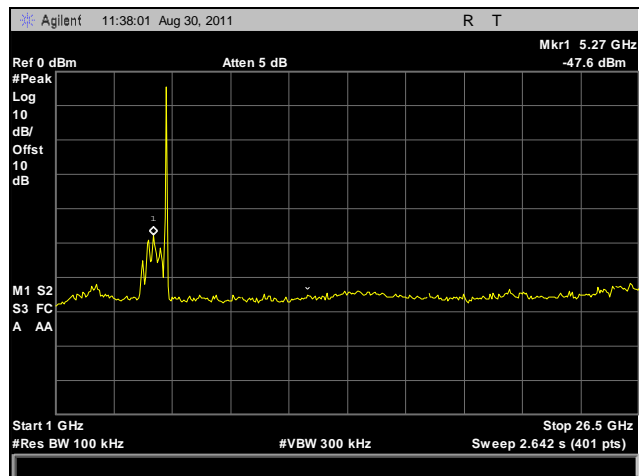
Plot 125. Conducted Spurious Emissions, Mid Channel, 802.11n 20 MHz, Port 1, 1 GHz – 26.5 GHz



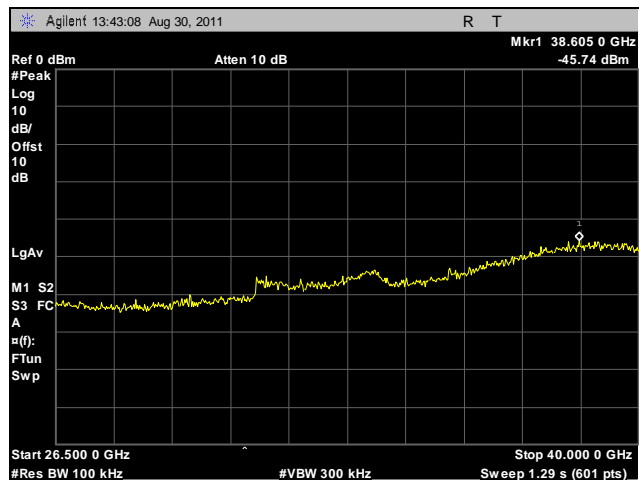
Plot 126. Conducted Spurious Emissions, Mid Channel, 802.11n 20 MHz, Port 1, 26.5 GHz – 40 GHz



Plot 127. Conducted Spurious Emissions, High Channel, 802.11n 20 MHz, Port 1, 30 MHz – 1 GHz

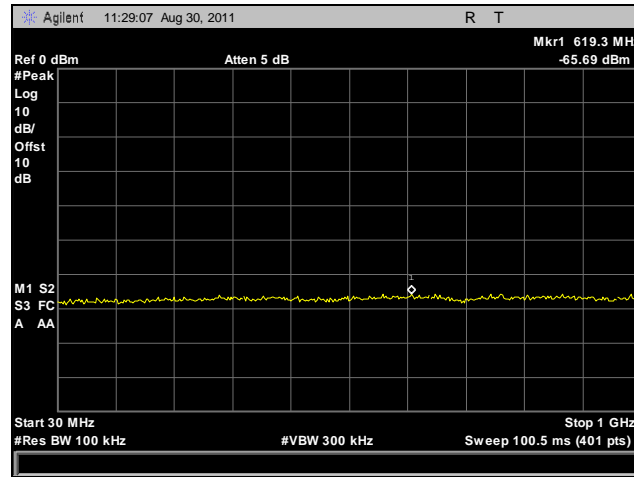


Plot 128. Conducted Spurious Emissions, High Channel, 802.11n 20 MHz, Port 1, 1 GHz – 26.5 GHz

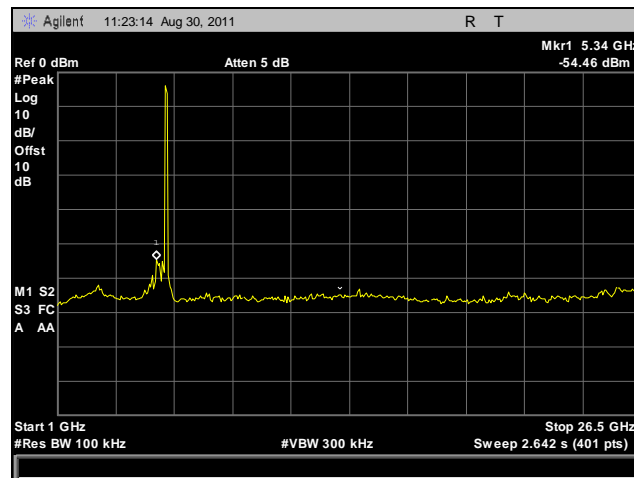


Plot 129. Conducted Spurious Emissions, High Channel, 802.11n 20 MHz, Port 1, 26.5 GHz – 40 GHz

### Conducted Spurious Emissions Test Results, 802.11n 20 MHz, Port 2



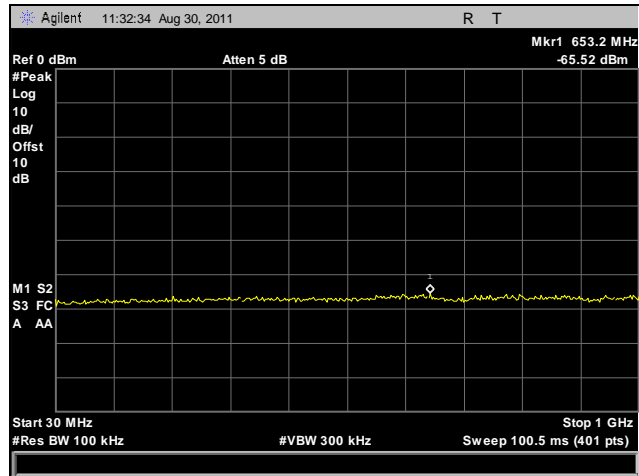
Plot 130. Conducted Spurious Emissions, Low Channel, 802.11n 20 MHz, Port 2, 30 MHz – 1 GHz



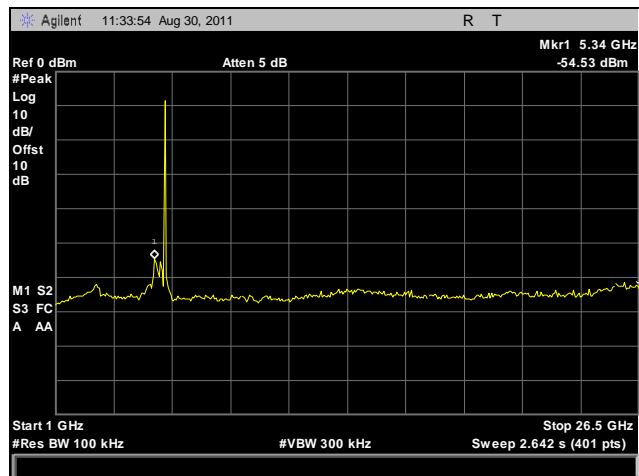
Plot 131. Conducted Spurious Emissions, Low Channel, 802.11n 20 MHz, Port 2, 1 GHz – 26.5 GHz



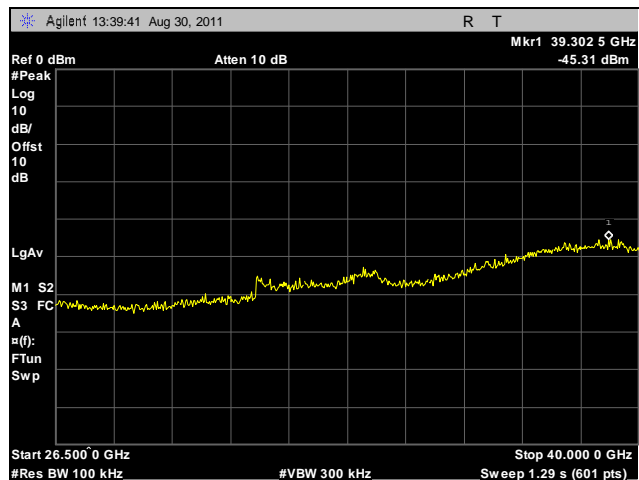
Plot 132. Conducted Spurious Emissions, Low Channel, 802.11n 20 MHz, Port 2, 26.5 GHz – 40 GHz



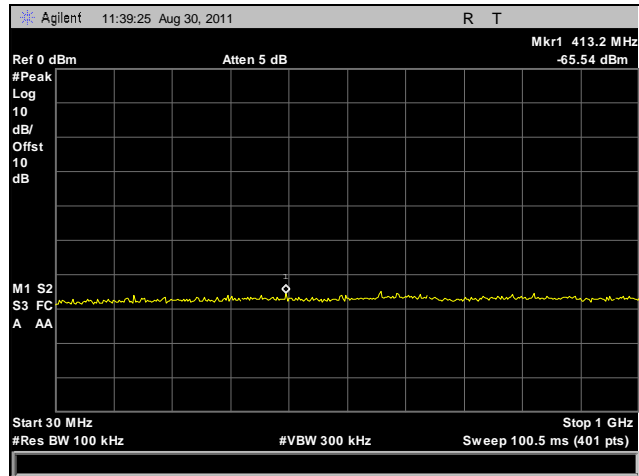
Plot 133. Conducted Spurious Emissions, Mid Channel, 802.11n 20 MHz, Port 2, 30 MHz – 1 GHz



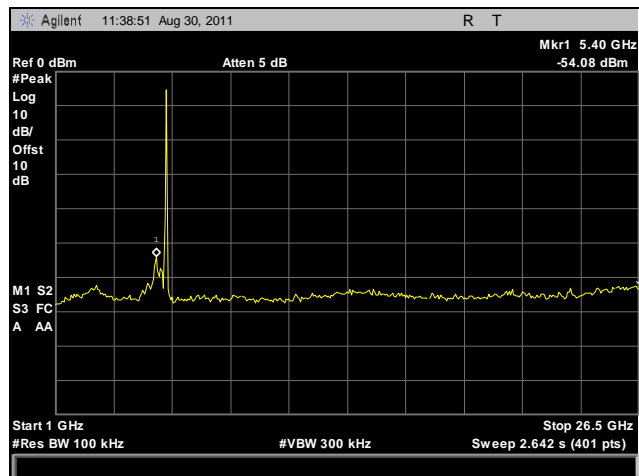
Plot 134. Conducted Spurious Emissions, Mid Channel, 802.11n 20 MHz, Port 2, 1 GHz – 26.5 GHz



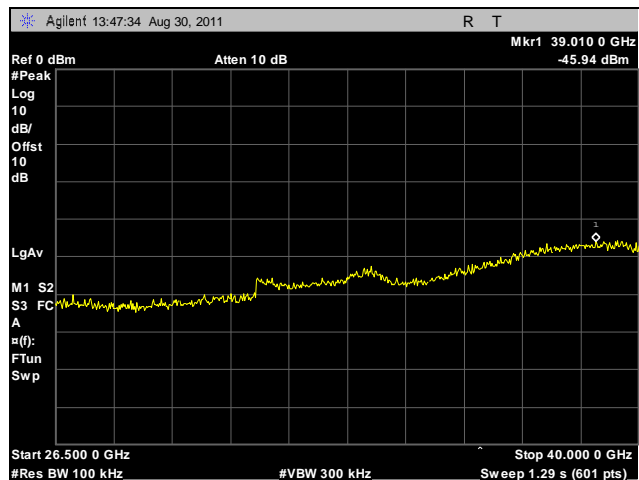
Plot 135. Conducted Spurious Emissions, Mid Channel, 802.11n 20 MHz, Port 2, 26.5 GHz – 40 GHz



Plot 136. Conducted Spurious Emissions, High Channel, 802.11n 20 MHz, Port 2, 30 MHz – 1 GHz



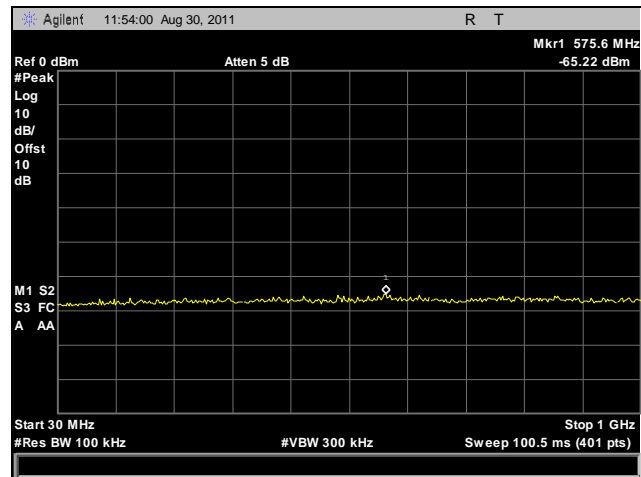
Plot 137. Conducted Spurious Emissions, High Channel, 802.11n 20 MHz, Port 2, 1 GHz – 26.5 GHz



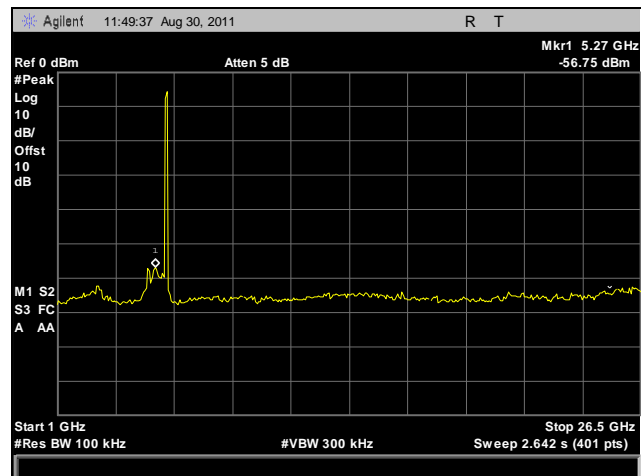
Plot 138. Conducted Spurious Emissions, High Channel, 802.11n 20 MHz, Port 2, 26.5 GHz – 40 GHz



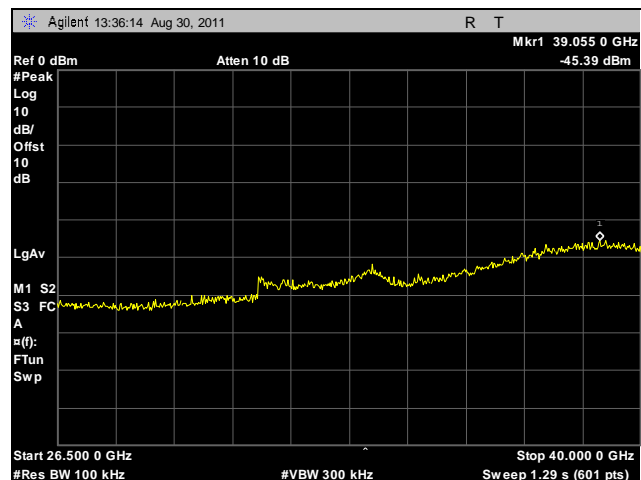
### Conducted Spurious Emissions Test Results, 802.11n 40 MHz, Port 0



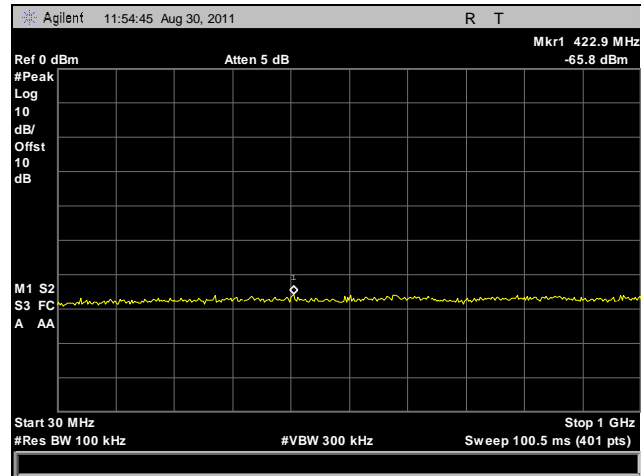
Plot 139. Conducted Spurious Emissions, Low Channel, 802.11n 40 MHz, Port 0, 30 MHz – 1 GHz



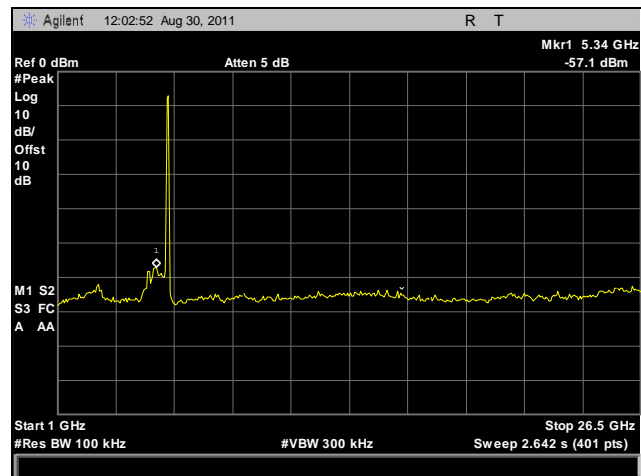
Plot 140. Conducted Spurious Emissions, Low Channel, 802.11n 40 MHz, Port 0, 1 GHz – 26.5 GHz



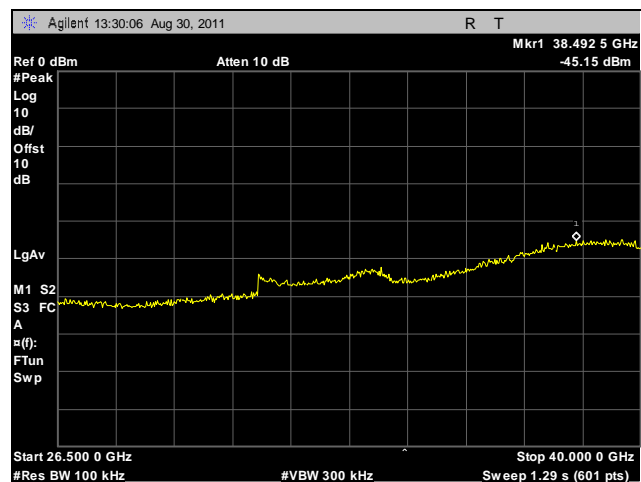
Plot 141. Conducted Spurious Emissions, Low Channel, 802.11n 40 MHz, Port 0, 26.5 GHz – 40 GHz



Plot 142. Conducted Spurious Emissions, High Channel, 802.11n 40 MHz, Port 0, 30 MHz – 1 GHz

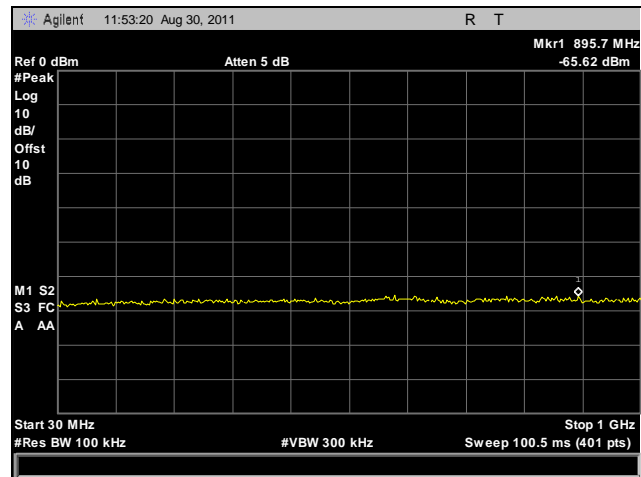


Plot 143. Conducted Spurious Emissions, High Channel, 802.11n 40 MHz, Port 0, 1 GHz – 26.5 GHz

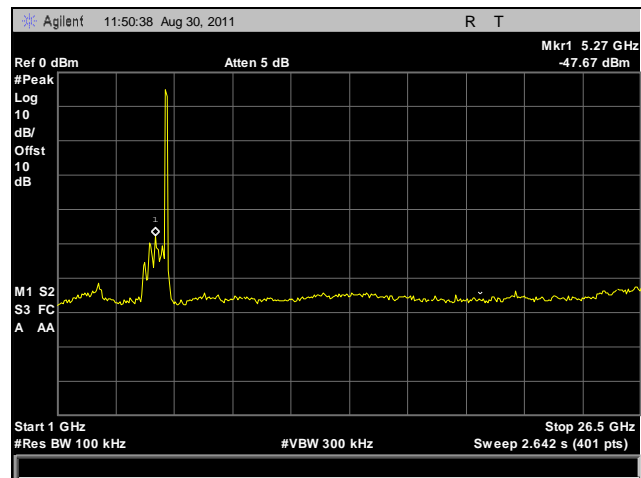


Plot 144. Conducted Spurious Emissions, High Channel, 802.11n 40 MHz, Port 0, 26.5 GHz – 40 GHz

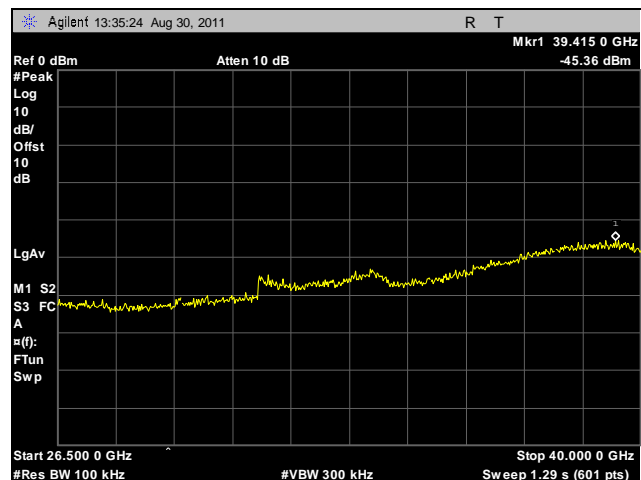
### Conducted Spurious Emissions Test Results, 802.11n 40 MHz, Port 1



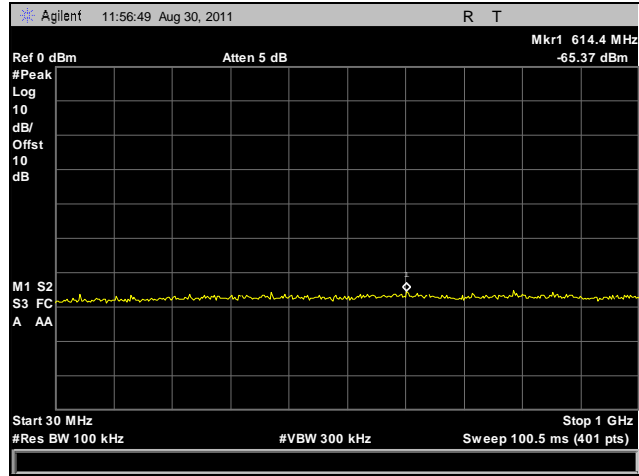
Plot 145. Conducted Spurious Emissions, Low Channel, 802.11n 40 MHz, Port 1, 30 MHz – 1 GHz



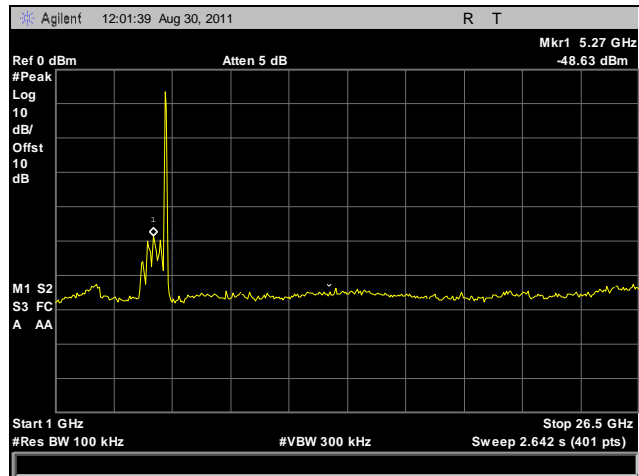
Plot 146. Conducted Spurious Emissions, Low Channel, 802.11n 40 MHz, Port 1, 1 GHz – 26.5 GHz



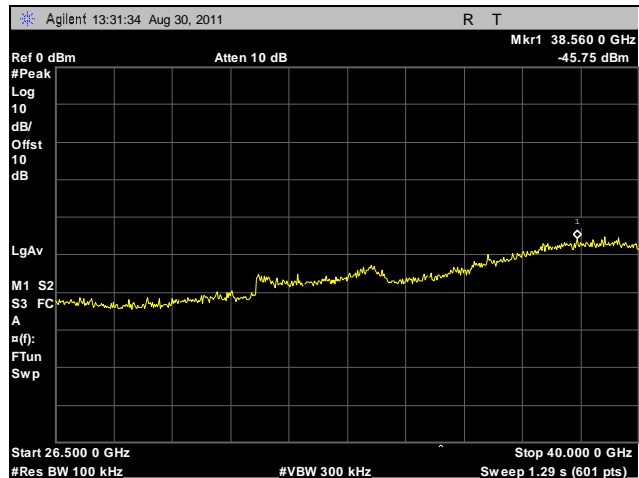
Plot 147. Conducted Spurious Emissions, Low Channel, 802.11n 40 MHz, Port 1, 26.5 GHz – 40 GHz



Plot 148. Conducted Spurious Emissions, High Channel, 802.11n 40 MHz, Port 1, 30 MHz – 1 GHz

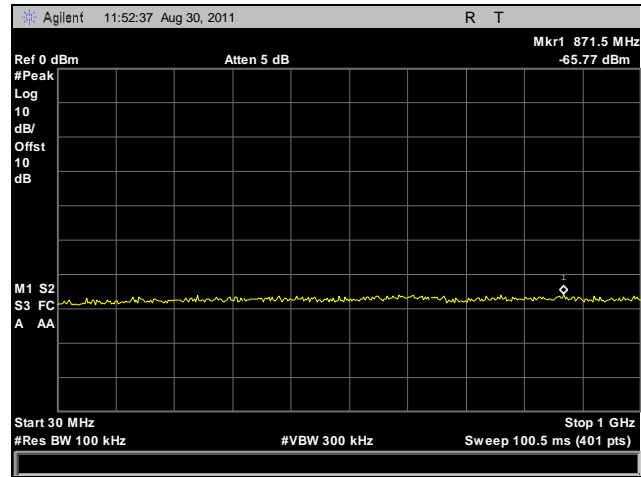


Plot 149. Conducted Spurious Emissions, High Channel, 802.11n 40 MHz, Port 1, 1 GHz – 26.5 GHz

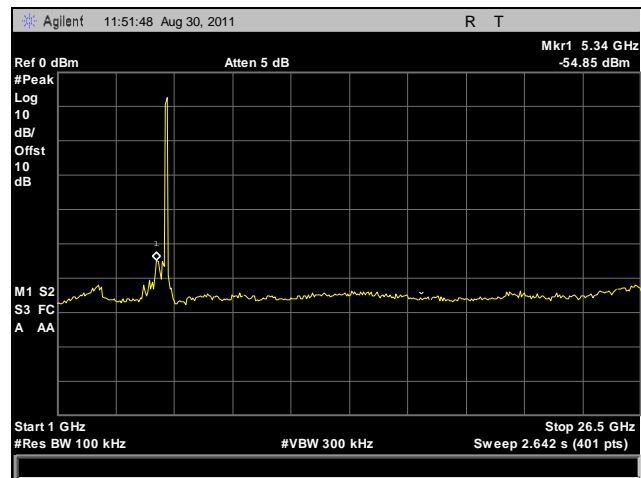


Plot 150. Conducted Spurious Emissions, High Channel, 802.11n 40 MHz, Port 1, 26.5 GHz – 40 GHz

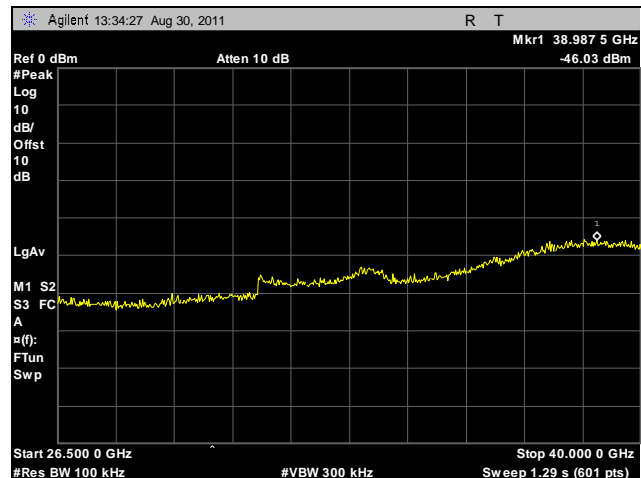
## Conducted Spurious Emissions Test Results, 802.11n 40 MHz, Port 2



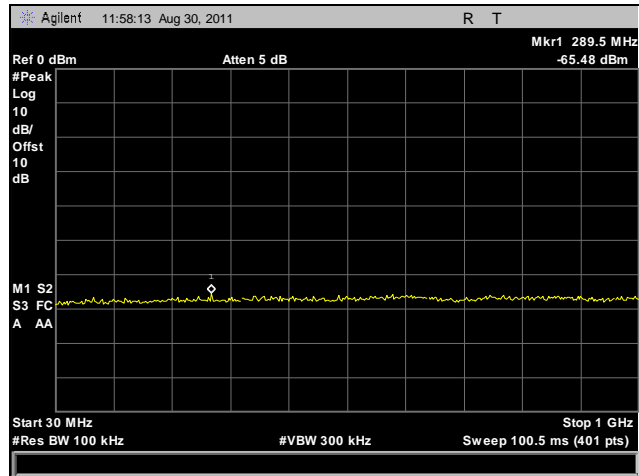
Plot 151. Conducted Spurious Emissions, Low Channel, 802.11n 40 MHz, Port 2, 30 MHz – 1 GHz



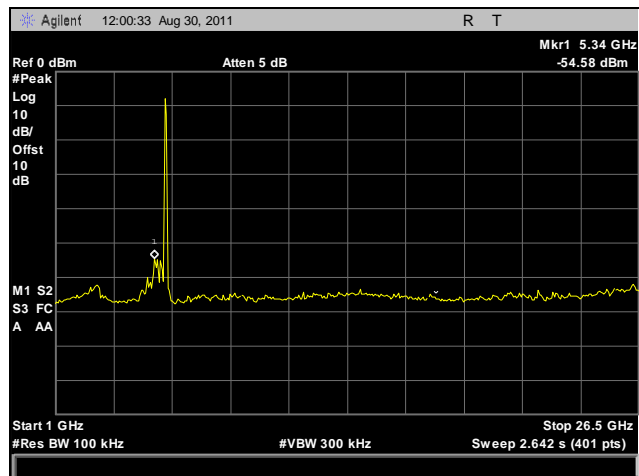
Plot 152. Conducted Spurious Emissions, Low Channel, 802.11n 40 MHz, Port 2, 1 GHz – 26.5 GHz



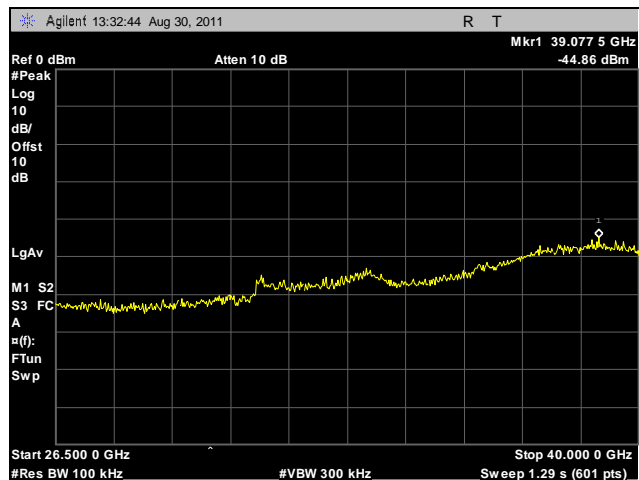
Plot 153. Conducted Spurious Emissions, Low Channel, 802.11n 40 MHz, Port 2, 26.5 GHz – 40 GHz



Plot 154. Conducted Spurious Emissions, High Channel, 802.11n 40 MHz, Port 2, 30 MHz – 1 GHz

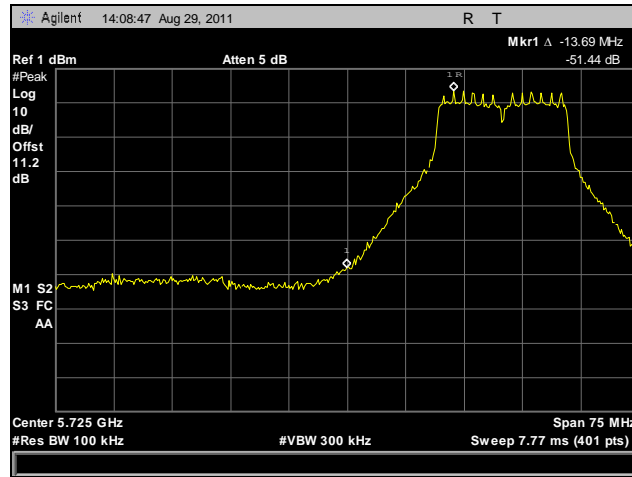


Plot 155. Conducted Spurious Emissions, High Channel, 802.11n 40 MHz, Port 2, 1 GHz – 26.5 GHz

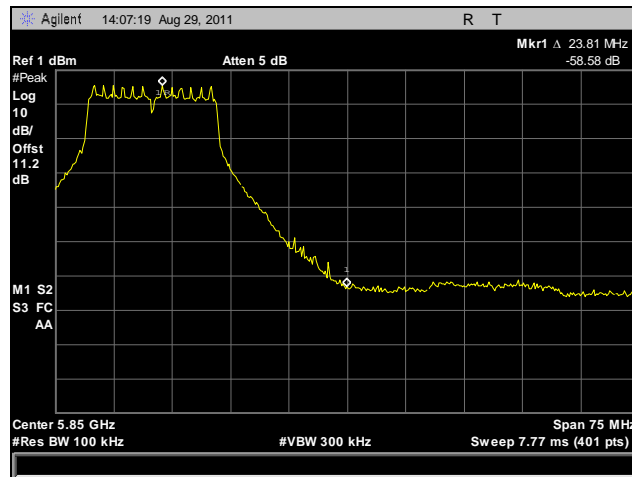


Plot 156. Conducted Spurious Emissions, High Channel, 802.11n 40 MHz, Port 2, 26.5 GHz – 40 GHz

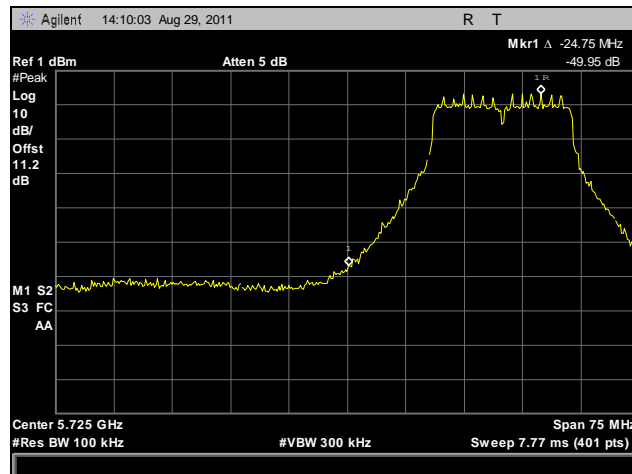
## Conducted Band Edge Test Results



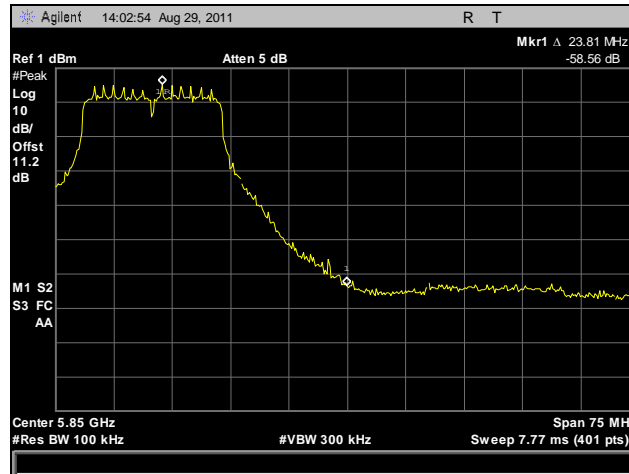
Plot 157. Conducted Band Edge, Low Channel, 802.11a



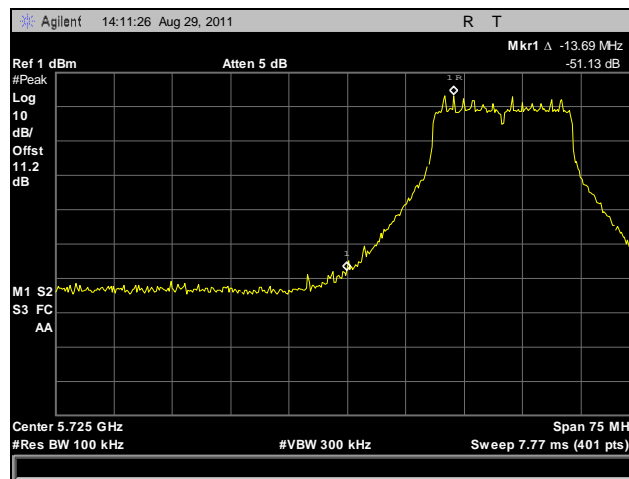
Plot 158. Conducted Band Edge, High Channel, 802.11a



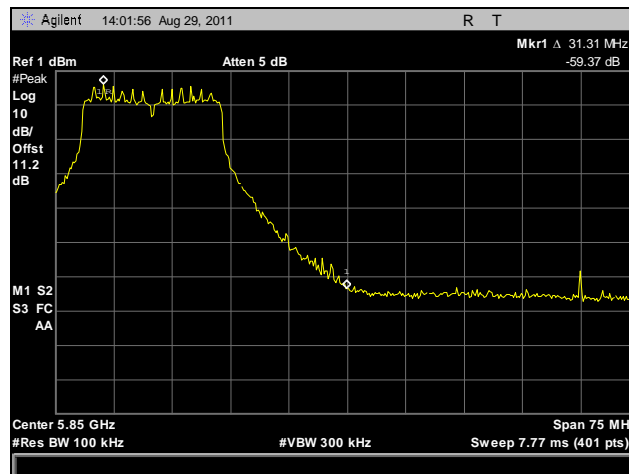
Plot 159. Conducted Band Edge, Low Channel, 802.11n 20 MHz, Port 0



Plot 160. Conducted Band Edge, High Channel, 802.11n 20 MHz, Port 0

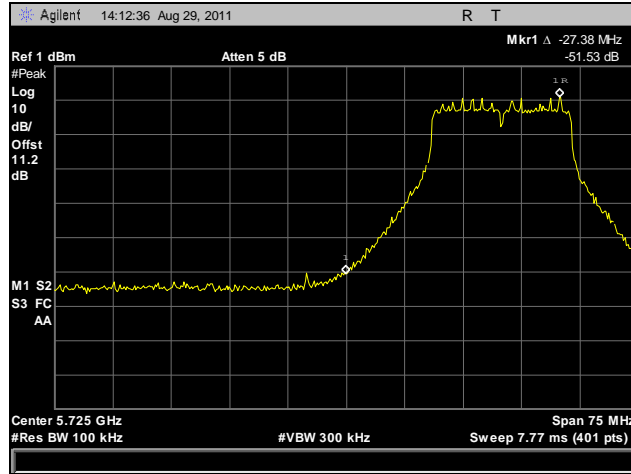


Plot 161. Conducted Band Edge, Low Channel, 802.11n 20 MHz, Port 1

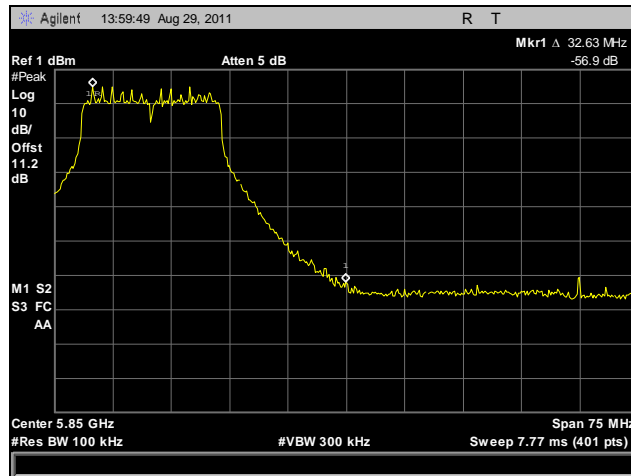


Plot 162. Conducted Band Edge, High Channel, 802.11n 20 MHz, Port 1

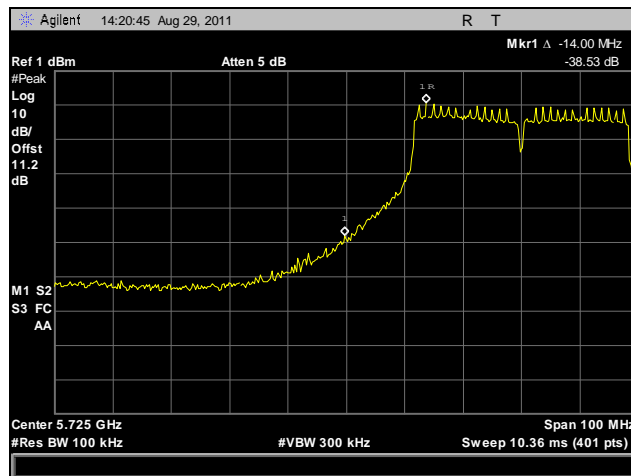




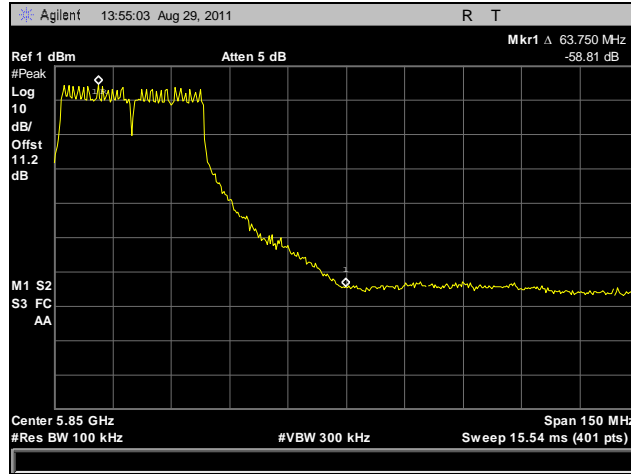
Plot 163. Conducted Band Edge, Low Channel, 802.11n 20 MHz, Port 2



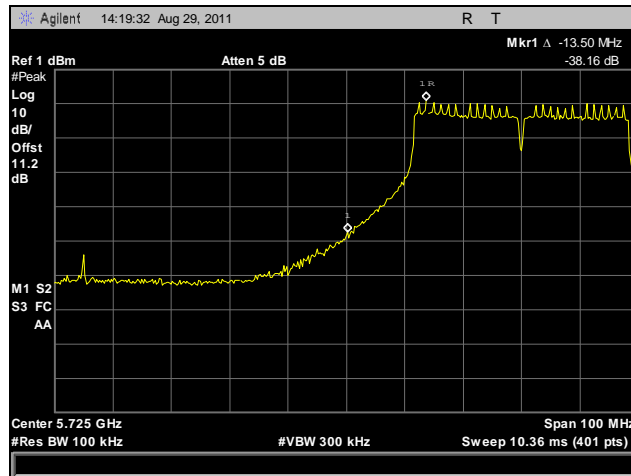
Plot 164. Conducted Band Edge, High Channel, 802.11n 20 MHz, Port 2



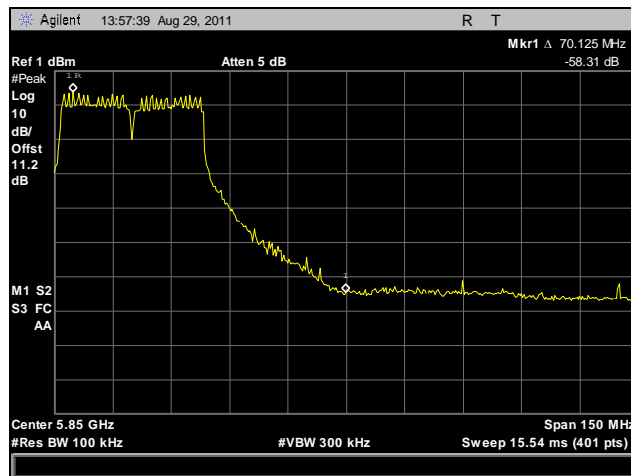
Plot 165. Conducted Band Edge, Low Channel, 802.11n 40 MHz, Port 0



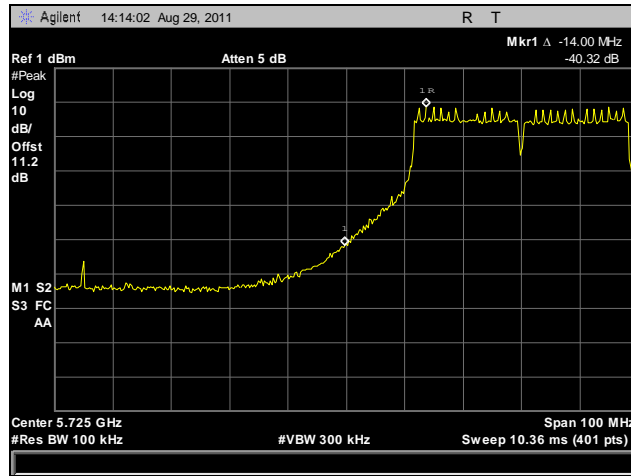
Plot 166. Conducted Band Edge, High Channel, 802.11n 40 MHz, Port 0



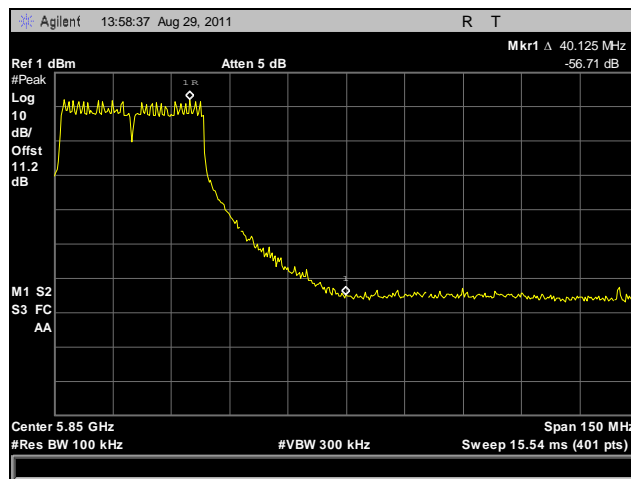
Plot 167. Conducted Band Edge, Low Channel, 802.11n 40 MHz, Port 1



Plot 168. Conducted Band Edge, High Channel, 802.11n 40 MHz, Port 1



Plot 169. Conducted Band Edge, Low Channel, 802.11n 40 MHz, Port 2



Plot 170. Conducted Band Edge, High Channel, 802.11n 40 MHz, Port 2

## Electromagnetic Compatibility Criteria for Intentional Radiators

### § 15.247(e) Peak Power Spectral Density

**Test Requirements:** §15.247(e): For digitally modulated systems, the peak power spectral density conducted from the intentional radiator to the antenna shall not be greater than 8dBm in any 3 kHz band during any time interval of continuous transmission.

**Test Procedure:** The transmitter was connected directly to a Spectrum Analyzer through an attenuator. The power level was set to the maximum level. A RBW of 1 MHz and VBW of 3 MHz were used to determine the peak emissions within the band. The Spectrum analyzer was then set to a RBW of 3 kHz and VBW was set to 10 kHz. The SPAN of the analyzer was set to 1 MHz with a 333.3 second sweep. Measurements were carried out at the low, mid and high channels. Measurements were done on Port 1 cause it yielded the highest output power. 4.77dB was then added to the number to account for a 3x3 MIMO. 4.77dB was derived from  $10 \log(N)$ . N is the number of ports the EUT has.

**Test Results:** The EUT was compliant with the peak power spectral density limits of § 15.247 (e).  
The peak power spectral density was determined from plots on the following page(s).

**Test Engineer:** Anderson Soungpanya

**Test Date:** 08/30/11

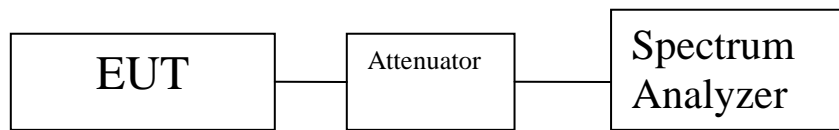


Figure 5. Block Diagram, Peak Power Spectral Density Test Setup

## Peak Power Spectral Density Test Results

| Peak Power Spectral Density |         |           |               |       |        |
|-----------------------------|---------|-----------|---------------|-------|--------|
| Mode                        | Carrier | Frequency | Measured PPSD | Limit | Margin |
|                             | Channel | (MHz)     | (dBm)         | (dBm) | (dB)   |
| 802.11a                     | Low     | 5745      | -19.86        | 8     | -27.86 |
|                             | Mid     | 5785      | -15.47        | 8     | -23.47 |
|                             | High    | 5825      | -18.38        | 8     | -26.38 |

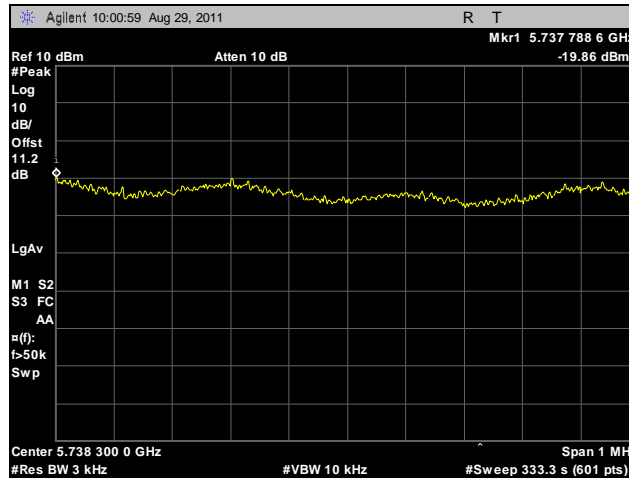
| Peak Power Spectral Density |         |           |                |              |            |       |        |
|-----------------------------|---------|-----------|----------------|--------------|------------|-------|--------|
| Mode                        | Carrier | Frequency | Measured PPSD* | 10 log (3)** | PSD Summed | Limit | Margin |
|                             | Channel | (MHz)     | (dBm)          | (dBm)        | (dBm)      | (dBm) | (dB)   |
| 802.11a                     | Low     | 5745      | -19.86         | 4.77         | -15.09     | 8     | -23.09 |
|                             | Mid     | 5785      | -15.47         | 4.77         | -10.70     | 8     | -18.70 |
|                             | High    | 5825      | -18.38         | 4.77         | -13.61     | 8     | -21.61 |
| 802.11n 20 MHz              | Low     | 5745      | -18.36         | 4.77         | -13.59     | 8     | -21.59 |
|                             | Mid     | 5785      | -15.27         | 4.77         | -10.50     | 8     | -18.50 |
|                             | High    | 5825      | -16.43         | 4.77         | -11.66     | 8     | -19.66 |
| 802.11n 40 MHz              | Low     | 5755      | -16.13         | 4.77         | -11.36     | 8     | -19.36 |
|                             | High    | 5805      | -17.96         | 4.77         | -13.19     | 8     | -21.19 |

**Table 24. Peak Power Spectral Density, Test Results**

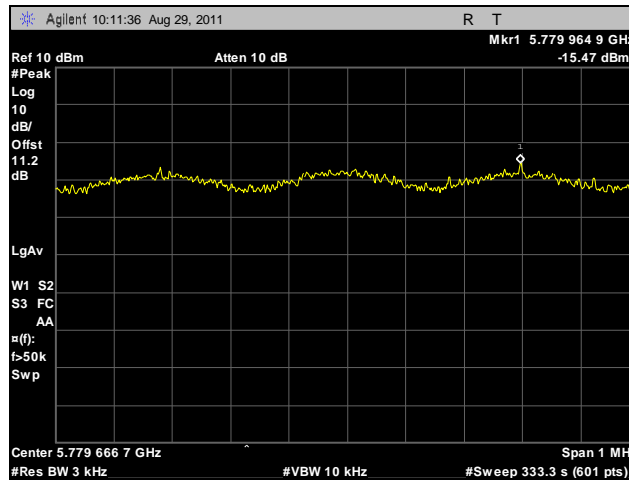
\*Measurements were done on Port 1 because it yielded the highest output power.

\*\*4.77dB was then added to the PSD measurement of Port 1 to account for a 3x3 MIMO. 4.77dB was derived from  $10 \log(N)$ . N is the number of ports the EUT has.

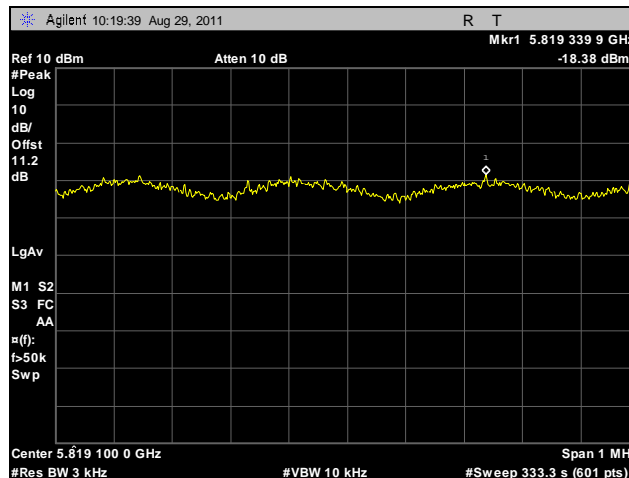
**Peak Power Spectral Density, 802.11a**



**Plot 171. Peak Power Spectral Density, Low Channel, 802.11a**

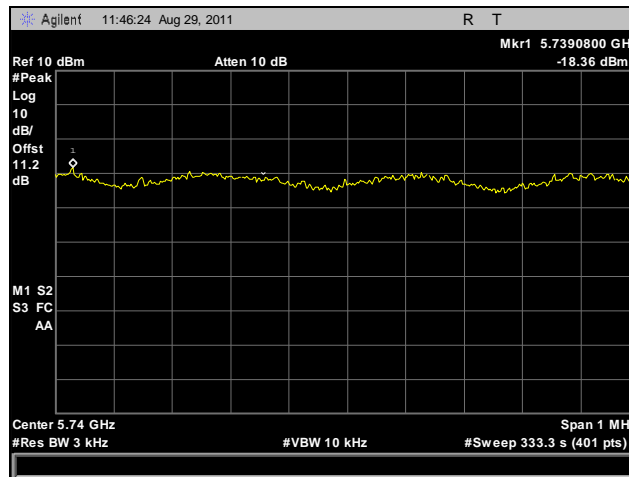


**Plot 172. Peak Power Spectral Density, Mid Channel, 802.11a**

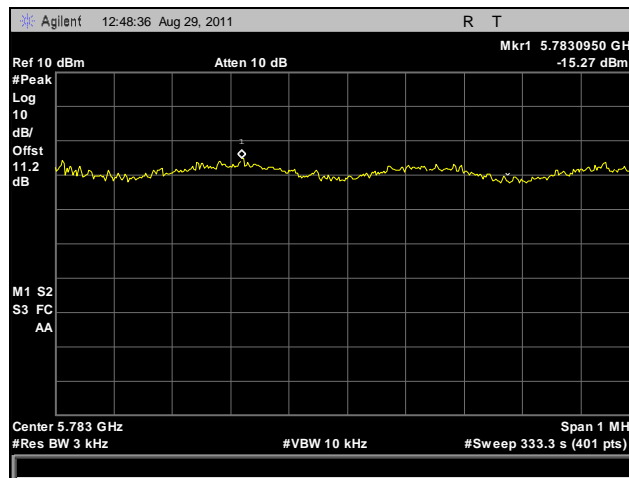


**Plot 173. Peak Power Spectral Density, High Channel, 802.11a**

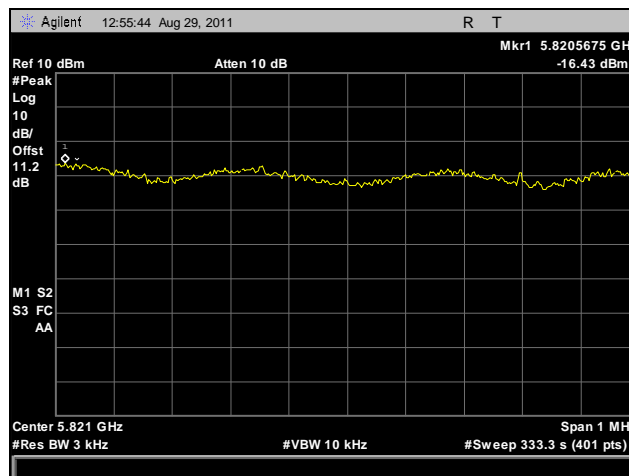
**Peak Power Spectral Density, 802.11n 20 MHz**



**Plot 174. Peak Power Spectral Density, Low Channel, 802.11n 20 MHz**

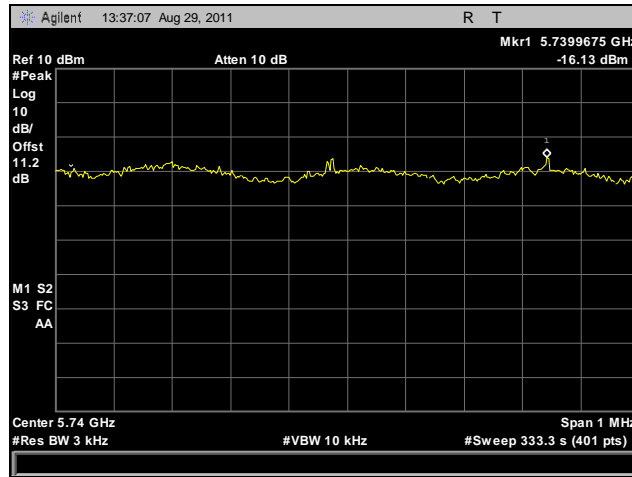


**Plot 175. Peak Power Spectral Density, Mid Channel, 802.11n 20 MHz**

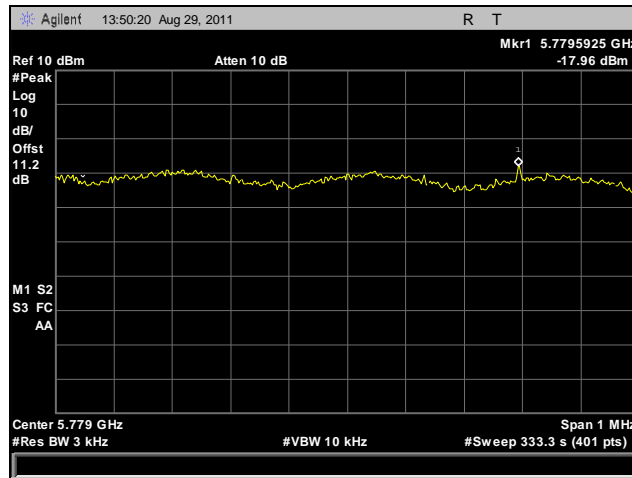


**Plot 176. Peak Power Spectral Density, High Channel, 802.11n 20 MHz**

**Peak Power Spectral Density, 802.11n 40 MHz**



**Plot 177. Peak Power Spectral Density, Low Channel, 802.11n 40 MHz**



**Plot 178. Peak Power Spectral Density, High Channel, 802.11n 40 MHz**



## Electromagnetic Compatibility Criteria for Intentional Radiators

### § 15.247(i) Maximum Permissible Exposure

**RF Exposure Requirements:** §1.1307(b)(1) and §1.1307(b)(2): Systems operating under the provisions of this section shall be operated in a manner that ensures that the public is not exposed to radio frequency energy levels in excess of the Commission's guidelines.

**RF Radiation Exposure Limit:** §1.1310: As specified in this section, the Maximum Permissible Exposure (MPE) Limit shall be used to evaluate the environmental impact of human exposure to radiofrequency (RF) radiation as specified in Sec. 1.1307(b), except in the case of portable devices which shall be evaluated according to the provisions of Sec. 2.1093 of this chapter.

MPE Limit Calculation: EUT's operating frequencies @ 5745 - 5825 MHz; highest conducted power = *18.58 dBm* (peak) therefore, **Limit for Uncontrolled exposure: 1 mW/cm<sup>2</sup> or 10 W/m<sup>2</sup>**

EUT maximum antenna gain = *25 dBi*.

Equation from page 18 of OET 65, Edition 97-01

$$S = PG / 4\pi R^2 \quad \text{or} \quad R = \sqrt{PG} / 4\pi S$$

where, S = Power Density (1 mW/cm<sup>2</sup>)  
P = Power Input to antenna (72.11mW)  
G = Antenna Gain (316.23 numeric)

$$R = (72.11 * 316.23 / 4 * 3.14 * 1.0)^{1/2} = (22803.42 / 12.56)^{1/2} = 42.61 \text{cm}$$

## Electromagnetic Compatibility Criteria for Intentional Radiators

### RSS-GEN Receiver Spurious Emissions Requirements

**Test Requirements:** The following receiver spurious emission limits shall be complied with:

- (a) If a radiated measurement is made, all spurious emissions shall comply with the limits of Table 25.

| Spurious Frequency (MHz) | Field Strength (microvolt/m at 3 metres) |
|--------------------------|--|
| 30 – 88                  | 100                                      |
| 88 – 216                 | 150                                      |
| 216 – 960                | 200                                      |
| Above 960                | 500                                      |

**Table 25. Spurious Emission Limits for Receivers**

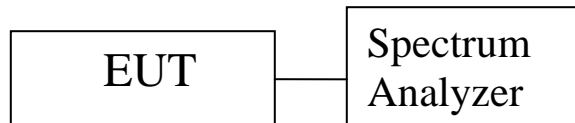
- (b) If a conducted measurement is made, no spurious output signals appearing at the antenna terminals shall exceed 2 nanowatts per any 4 kHz spurious frequency in the band 30-1000 MHz, or 5 nanowatts above 1 GHz.

**Test Procedures:** The EUT was programmed for receive mode only. Conducted measurements were taken at the antenna port of the EUT. 100 kHz resolution bandwidth was used from 30 MHz - 1 GHz and 300 kHz resolution was used for measurements done above 1 GHz. All plots are corrected for cable loss.

**Test Results:** Equipment is compliant with the Receiver Spurious Emissions Requirements of RSS-GEN.

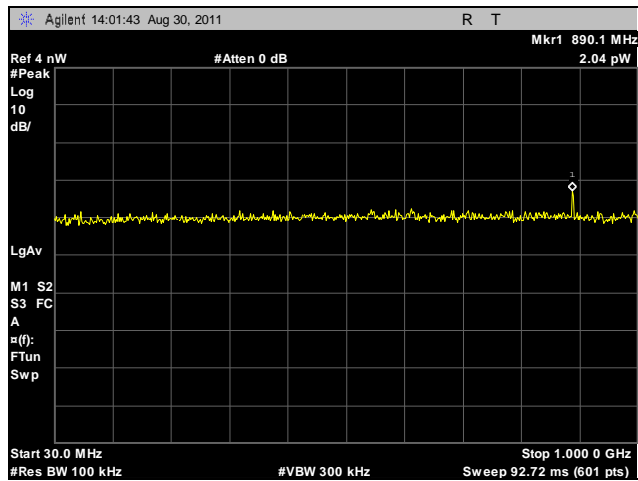
**Test Engineer(s):** Anderson Soungpanya

**Test Date(s):** 08/29/11

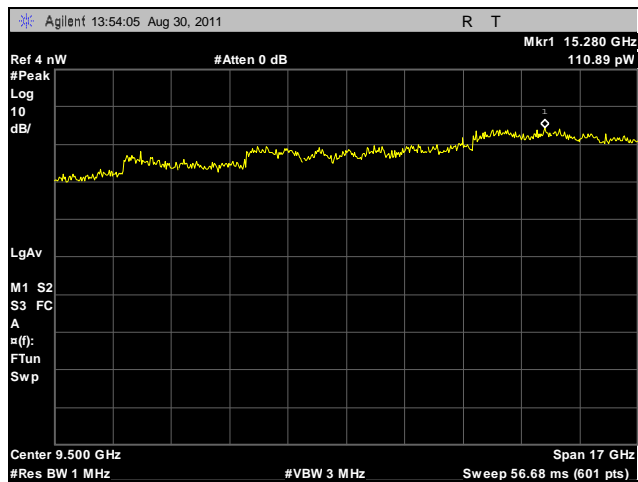


**Figure 6. Block Diagram, Conducted Receiver Spurious Emissions Test Setup**

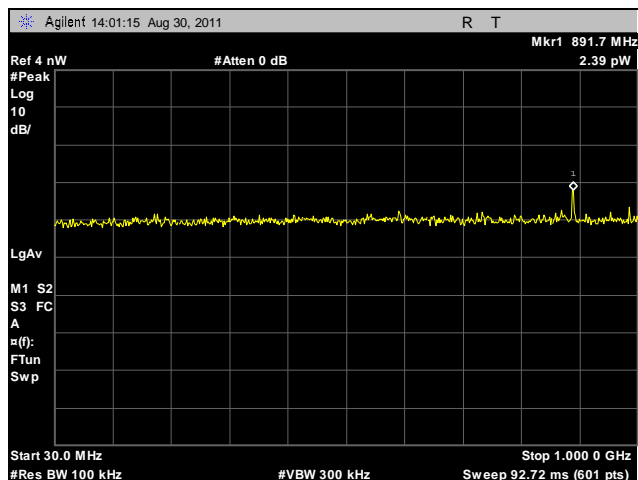
### Conducted Receiver Spurious Emissions



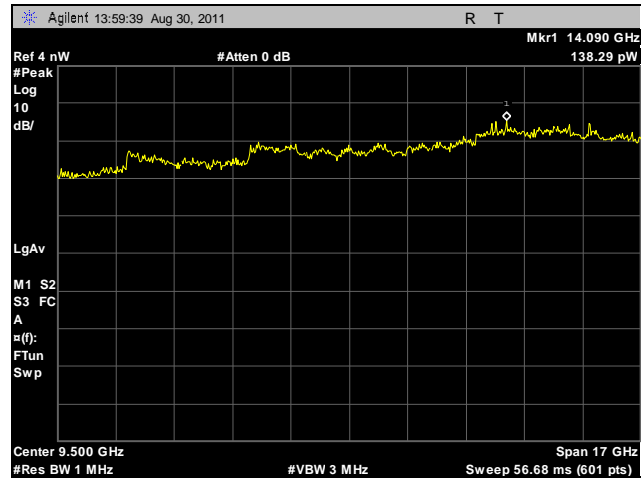
Plot 179. Receiver Spurious Emission, 30 MHz – 1 GHz, Port 0



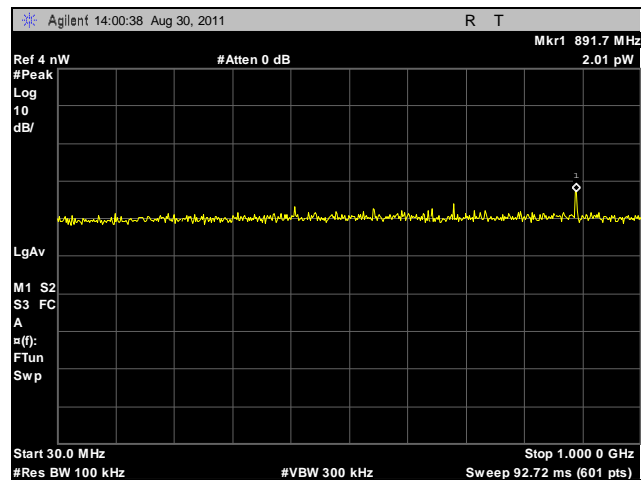
Plot 180. Receiver Spurious Emission, 1 GHz – 18 GHz, Port 0



Plot 181. Receiver Spurious Emission, 30 MHz – 1 GHz, Port 1



Plot 182. Receiver Spurious Emission, 1 GHz – 18 GHz, Port 1



Plot 183. Receiver Spurious Emission, 30 MHz – 1 GHz, Port 2



Plot 184. Receiver Spurious Emission, 1 GHz – 18 GHz, Port 2

## IV. Test Equipment

## Test Equipment

Calibrated test equipment utilized during testing was maintained in a current state of calibration per the requirements of ANSI/NCSL Z540-1-1994 and ANSI/ISO/IEC 17025:2000.

| MET Asset # | Equipment                 | Manufacturer      | Model        | Last Cal Date           | Cal Due Date |
|-------------|---------------------------|-------------------|--------------|-------------------------|--------------|
| 1S2583      | SPECTRUM ANALYZER         | AGILENT           | E4447A       | 3/18/2011               | 3/18/2012    |
| 1S2678      | LISN, DUAL-LINE V-NETWORK | TESEQ             | NNB 51       | 12/1/2010               | 12/1/2011    |
| 1S2399      | TURNTABLE CONTROLLER      | SUNOL SCIENCE     | SC99V        | NO CALIBRATION REQUIRED |              |
| 1S2481      | 10M CHAMBER               | ETS-LINDGREN      | DKE 8X8 DBL  | 11/6/2010               | 11/6/2011    |
| 1S2482      | 5 METER CHAMBER           | PANASHIELD        | 641431       | 11/13/2010              | 11/13/2011   |
| 1S2485      | BILOG ANTENNA             | TESEQ             | CBL6112D     | 5/12/2011               | 5/12/2012    |
| 1S2499      | MULTI DEVICE CONTROLLER   | ETS               | 2090         | NO CALIBRATION REQUIRED |              |
| 1S2421      | EMI TEST RECEIVER         | ROHDE & SCHWARZ   | ESIB7        | 6/17/2011               | 6/17/2012    |
| 1S2460      | SPECTRUM ANALYZER         | AGILENT           | E4407B       | 7/12/2011               | 7/12/2012    |
| 1S2603      | HORN ANTENNA              | EMCO              | 3117         | 4/15/2011               | 4/15/2013    |
| N/A         | HIGH PASS FILTER          | MICRO-TRONICS     | HPM13147     | SEE NOTE                |              |
| 1S2521      | THERMO-HYGROMETER         | FISHER SCIENTIFIC | 11-661-7D    | 12/2/2009               | 12/2/2011    |
| N/A         | DC-18GHZ COMBINER         | MINI CIRCUITS     | ZFRSC-183-S+ | SEE NOTE                |              |
| 1S2523      | PREAMP (1-26.5GHZ)        | AGILENT           | 8449B        | SEE NOTE                |              |
| 1S2128      | HARMONIC MIXER            | HEWLETT PACKARD   | 11970A       | 12/9/2010               | 12/9/2012    |
| 1S2129      | HARMONIC MIXER            | HEWLETT PACKARD   | 11970K       | 12/9/2010               | 12/9/2012    |

**Table 26. Test Equipment List**

Note: Functionally tested equipment is verified using calibrated instrumentation at the time of testing.

## **V. Certification & User's Manual Information**

## Certification & User's Manual Information

### A. Certification Information

The following is extracted from Title 47 of the Code of Federal Regulations, Part 2, Subpart I — Marketing of Radio frequency devices:

#### § 2.801 Radio-frequency device defined.

As used in this part, a radio-frequency device is any device which in its operation is capable of Emitting radio-frequency energy by radiation, conduction, or other means. Radio- frequency devices include, but are not limited to:

- (a) The various types of radio communication transmitting devices described throughout this chapter.
- (b) *The incidental, unintentional and intentional radiators defined in Part 15 of this chapter.*
- (c) The industrial, scientific, and medical equipment described in Part 18 of this chapter.
- (d) Any part or component thereof which in use emits radio-frequency energy by radiation, conduction, or other means.

#### § 2.803 Marketing of radio frequency devices prior to equipment authorization.

- (a) Except as provided elsewhere in this chapter, no person shall sell or lease, or offer for sale or lease (including advertising for sale or lease), or import, ship or distribute for the purpose of selling or leasing or offering for sale or lease, any radio frequency device unless:
  - (1) In the case of a device subject to certification, such device has been authorized by the Commission in accordance with the rules in this chapter and is properly identified and labeled as required by §2.925 and other relevant sections in this chapter; or
  - (2) In the case of a device that is not required to have a grant of equipment authorization issued by the Commission, but which must comply with the specified technical standards prior to use, such device also complies with all applicable administrative (including verification of the equipment or authorization under a Declaration of Conformity, where required), technical, labeling and identification requirements specified in this chapter.
- (d) Notwithstanding the provisions of paragraph (a) of this section, the offer for sale solely to business, commercial, industrial, scientific or medical users (but not an offer for sale to other parties or to end users located in a residential environment) of a radio frequency device that is in the conceptual, developmental, design or pre-production stage is permitted prior to equipment authorization or, for devices not subject to the equipment authorization requirements, prior to a determination of compliance with the applicable technical requirements *provided* that the prospective buyer is advised in writing at the time of the offer for sale that the equipment is subject to the FCC rules and that the equipment will comply with the appropriate rules before delivery to the buyer or to centers of distribution.



- (e)(1) Notwithstanding the provisions of paragraph (a) of this section, prior to equipment authorization or determination of compliance with the applicable technical requirements any radio frequency device may be operated, but not marketed, for the following purposes and under the following conditions:
- (i) *Compliance testing*;
  - (ii) Demonstrations at a trade show provided the notice contained in paragraph (c) of this section is displayed in a conspicuous location on, or immediately adjacent to, the device;
  - (iii) Demonstrations at an exhibition conducted at a business, commercial, industrial, scientific or medical location, but excluding locations in a residential environment, provided the notice contained in paragraphs (c) or (d) of this section, as appropriate, is displayed in a conspicuous location on, or immediately adjacent to, the device;
  - (iv) Evaluation of product performance and determination of customer acceptability, provided such operation takes place at the manufacturer's facilities during developmental, design or pre-production states; or
  - (v) Evaluation of product performance and determination of customer acceptability where customer acceptability of a radio frequency device cannot be determined at the manufacturer's facilities because of size or unique capability of the device, provided the device is operated at a business, commercial, industrial, scientific or medical user's site, but not at a residential site, during the development, design or pre-production stages.
- (e)(2) For the purpose of paragraphs (e)(1)(iv) and (e)(1)(v) of this section, the term *manufacturer's facilities* includes the facilities of the party responsible for compliance with the regulations and the manufacturer's premises, as well as the facilities of other entities working under the authorization of the responsible party in connection with the development and manufacture, but not the marketing, of the equipment.
- (f) For radio frequency devices subject to verification and sold solely to business, commercial, industrial, scientific and medical users (excluding products sold to other parties or for operation in a residential environment), parties responsible for verification of the devices shall have the option of ensuring compliance with the applicable technical specifications of this chapter at each end user's location after installation, provided that the purchase or lease agreement includes a proviso that such a determination of compliance be made and is the responsibility of the party responsible for verification of the equipment.

## Certification & User's Manual Information

The following is extracted from Title 47 of the Code of Federal Regulations, Part 2, Subpart J — Equipment Authorization Procedures:

### § 2.901 Basis and Purpose

- (a) In order to carry out its responsibilities under the Communications Act and the various treaties and international regulations, and in order to promote efficient use of the radio spectrum, the Commission has developed technical standards for radio frequency equipment and parts or components thereof. The technical standards applicable to individual types of equipment are found in that part of the rules governing the service wherein the equipment is to be operated.<sup>1</sup> *In addition to the technical standards provided, the rules governing the service may require that such equipment be verified by the manufacturer or importer, be authorized under a Declaration of Conformity, or receive an equipment authorization from the Commission by one of the following procedures: certification or registration.*
- (b) The following sections describe the verification procedure, the procedure for a Declaration of Conformity, and the procedures to be followed in obtaining certification from the Commission and the conditions attendant to such a grant.

### § 2.907 Certification.

- (a) Certification is an equipment authorization issued by the Commission, based on representation and test data submitted by the applicant.
- (b) Certification attaches to all units subsequently marketed by the grantee which are identical (see Section 2.908) to the sample tested except for permissive changes or other variations authorized by the Commission pursuant to Section 2.1043.

---

<sup>1</sup> In this case, the equipment is subject to the rules of Part 15. More specifically, the equipment falls under Subpart B (of Part 15), which deals with unintentional radiators.

## Certification & User's Manual Information

### § 2.948 Description of measurement facilities.

- (a) Each party making measurements of equipment that is subject to an equipment authorization under Part 15 or Part 18 of this chapter, regardless of whether the measurements are filed with the Commission or kept on file by the party responsible for compliance of equipment marketed within the U.S. or its possessions, shall compile a description of the measurement facilities employed.
- (1) If the measured equipment is subject to the verification procedure, the description of the measurement facilities shall be retained by the party responsible for verification of the equipment.
- (i) *If the equipment is verified through measurements performed by an independent laboratory, it is acceptable for the party responsible for verification of the equipment to rely upon the description of the measurement facilities retained by or placed on file with the Commission by that laboratory. In this situation, the party responsible for the verification of the equipment is not required to retain a duplicate copy of the description of the measurement facilities.*
- (ii) If the equipment is verified based on measurements performed at the installation site of the equipment, no specific site calibration data is required. It is acceptable to retain the description of the measurement facilities at the site at which the measurements were performed.
- (2) If the equipment is to be authorized by the Commission under the certification procedure, the description of the measurement facilities shall be filed with the Commission's Laboratory in Columbia, Maryland. The data describing the measurement facilities need only be filed once but must be updated as changes are made to the measurement facilities or as otherwise described in this section. At least every three years, the organization responsible for filing the data with the Commission shall certify that the data on file is current.

## Certification & User's Manual Information

### 1. Label and User's Manual Information

The following is extracted from Title 47 of the Code of Federal Regulations, Part 15, Subpart A — General:

#### § 15.19 Labeling requirements.

(a) *In addition to the requirements in Part 2 of this chapter, a device subject to certification or verification shall be labeled as follows:*

- (1) Receivers associated with the operation of a licensed radio service, e.g., FM broadcast under Part 73 of this chapter, land mobile operation under Part 90, etc., shall bear the following statement in a conspicuous location on the device:

This device complies with Part 15 of the FCC Rules. Operation is subject to the condition that this device does not cause harmful interference.

- (2) A stand-alone cable input selector switch, shall bear the following statement in a conspicuous location on the device:

This device is verified to comply with Part 15 of the FCC Rules for use with cable television service.

- (3) All other devices shall bear the following statement in a conspicuous location on the device:

*This device complies with Part 15 of the FCC Rules. Operation is subject to the following two conditions: (1) This device may not cause harmful interference, and (2) this device must accept any interference received, including interference that may cause undesired operation.*

- (4) Where a device is constructed in two or more sections connected by wires and marketed together, the statement specified under paragraph (a) of this section is required to be affixed only to the main control unit.

- (5) When the device is so small or for such use that it is not practicable to place the statement specified under paragraph (a) of this section on it, the information required by this paragraph shall be placed in a prominent location in the instruction manual or pamphlet supplied to the user or, alternatively, shall be placed on the container in which the device is marketed. However, the FCC identifier or the unique identifier, as appropriate, must be displayed on the device.

#### § 15.21 Information to user.

The users manual or instruction manual for an intentional or unintentional radiator shall caution the user that changes or modifications not expressly approved by the party responsible for compliance could void the user's authority to operate the equipment.

## Verification & User's Manual Information

The following is extracted from Title 47 of the Code of Federal Regulations, Part 15, Subpart B — Unintentional Radiators:

### § 15.105 Information to the user.

- (a) For a Class A digital device or peripheral, the instructions furnished the user shall include the following or similar statement, placed in a prominent location in the text of the manual:

Note: This equipment has been tested and found to comply with the limits for a Class A digital device, pursuant to Part 15 of the FCC Rules. These limits are designed to provide reasonable protection against harmful interference when the equipment is operated in a commercial environment. This equipment generates, uses, and can radiate radio frequency energy and, if not installed and used in accordance with the instruction manual, may cause harmful interference to radio communications. Operation of this equipment in a residential area is likely to cause harmful interference in which case the user will be required to correct the interference at own expense.

- (b) For a Class B digital device or peripheral, the instructions furnished the user shall include the following or similar statement, placed in a prominent location in the text of the manual:

Note: This equipment has been tested and found to comply with the limits for a Class B digital device, pursuant to Part 15 of the FCC Rules. These limits are designed to provide reasonable protection against harmful interference when the equipment is operated in a residential environment. This equipment generates, uses, and can radiate radio frequency energy and, if not installed and used in accordance with the instruction manual, may cause harmful interference to radio communications. However, there is no guarantee that interference will not occur in a particular installation. If this equipment does cause harmful interference to radio or television reception, which can be determined by turning the equipment off and on, the user is encouraged to try to correct the interference by one or more of the following measures:

- Reorient or relocate the receiving antenna.
- Increase the separation between the equipment and receiver.
- Connect the equipment into an outlet on a circuit different from that to which the receiver is connected.
- Consult the dealer or an experienced radio/TV technician for help.

## ICES-003 Procedural & Labeling Requirements

From the Industry Canada Electromagnetic Compatibility Advisory Bulletin entitled, "Implementation and Interpretation of the Interference-Causing Equipment Standard for Digital Apparatus, ICES-003" (EMCAB-3, Issue 2, July 1995):

"At present, CISPR 22: 2002 and ICES technical requirements are essentially equivalent. Therefore, if you have CISPR 22: 2002 approval by meeting CISPR Publication 22, the only additional requirements are: to attach a note to the report of the test results for compliance, indicating that these results are deemed satisfactory evidence of compliance with ICES-003 of the Canadian Interference-Causing Equipment Regulations; to maintain these records on file for the requisite five year period; and to provide the device with a notice of compliance in accordance with ICES-003."

### Procedural Requirements:

According to Industry Canada's Interference Causing Equipment Standard for Digital Apparatus ICES-003 Issue 4, February 2004:

- Section 6.1: A record of the measurements and results, showing the date that the measurements were completed, shall be retained by the manufacturer or importer for a period of at least five years from the date shown in the record and made available for examination on the request of the Minister.
- Section 6.2: A written notice indicating compliance must accompany each unit of digital apparatus to the end user. The notice shall be in the form of a label that is affixed to the apparatus. Where because of insufficient space or other constraints it is not feasible to affix a label to the apparatus, the notice may be in the form of a statement in the user's manual.

### Labeling Requirements:

The suggested text for the notice, in English and in French, is provided below, from the Annex of ICES-003:

This Class [<sup>2</sup>] digital apparatus complies with Canadian ICES-003.

Cet appareil numérique de la classe [<sup>1</sup>] est conforme à la norme NMB-003 du Canada.

---

<sup>2</sup> Insert either A or B but not both as appropriate for the equipment requirements.

# End of Report