



MET Laboratories, Inc. *Safety Certification - EMI - Telecom Environmental Simulation*

914 WEST PATAPSCO AVENUE • BALTIMORE, MARYLAND 21230-3432 • PHONE (410) 354-3300 • FAX (410) 354-3313

33439 WESTERN AVENUE • UNION CITY, CALIFORNIA 94587 • PHONE (510) 489-6300 • FAX (510) 489-6372

3162 BELICK STREET • SANTA CLARA, CALIFORNIA 95054 • PHONE (408) 748-3585 • FAX (510) 489-6372

July 14, 2010

Ubiquiti Networks
91 E. Tasman
San Jose, CA 95134

Dear Robert Pera,

Enclosed is the EMC Wireless test report for compliance testing of the Ubiquiti Networks, M365, tested to the requirements of Title 47 of the Code of Federal Regulations (CFR), Part 90 Subpart Z for Land Mobile Radio Services and Part 15 Subpart B for a Class A Digital Device.

Thank you for using the services of MET Laboratories, Inc. If you have any questions regarding these results or if MET can be of further service to you, please feel free to contact me.

Sincerely yours,
MET LABORATORIES, INC.

Jennifer Sanchez
Documentation Department

Reference: (\Ubiquiti Networks\EMCS82293-FCC90Z Rev. 2)

Certificates and reports shall not be reproduced except in full, without the written permission of MET Laboratories, Inc.



MET Laboratories, Inc. *Safety Certification - EMI - Telecom Environmental Simulation*

914 WEST PATAPSCO AVENUE • BALTIMORE, MARYLAND 21230-3432 • PHONE (410) 354-3300 • FAX (410) 354-3313

33439 WESTERN AVENUE • UNION CITY, CALIFORNIA 94587 • PHONE (510) 489-6300 • FAX (510) 489-6372

3162 BELICK STREET • SANTA CLARA, CALIFORNIA 95054 • PHONE (408) 748-3585 • FAX (510) 489-6372

Electromagnetic Compatibility Criteria Test Report

For the

**Ubiquiti Networks
Model M365**

Tested under

**The FCC Verification Rules
Contained in Title 47 of the CFR, Part 90, Subpart Z
for Private Land Mobile Radio Services
and Part 15, Subpart B for a Class A Digital Device**

MET Report: EMCS82293-FCC90Z Rev. 2

July 14, 2010

**Prepared For:
Ubiquiti Networks
91 E. Tasman
San Jose, CA 95134**

**Prepared By:
MET Laboratories, Inc.
3162 Belick St.
Santa Clara, CA 95054**



Electromagnetic Compatibility Criteria Test Report

For the

**Ubiquiti Networks
Model M365**

Tested under

**The FCC Verification Rules
Contained in Title 47 of the CFR, Part 90, Subpart Z
for Private Land Mobile Radio Services
and Part 15, Subpart B for a Class A Digital Device**

MET Report: EMCS82293-FCC90Z Rev. 2

Anderson Soungpanya
Electromagnetic Compatibility Lab

Jennifer Sanchez
Documentation Department

Engineering Statement: The measurements shown in this report were made in accordance with the procedures indicated, and the emissions from this equipment were found to be within the limits applicable. I assume full responsibility for the accuracy and completeness of these measurements, and for the qualifications of all persons taking them. It is further stated that upon the basis of the measurements made, the equipment tested is / is not capable of operation in accordance with the requirements of Part 90, Subpart Z and Part 15, Subpart B of the FCC Rules under normal use and maintenance.

Shawn McMillen, Lab Manager
Electromagnetic Compatibility Lab



Report Status Sheet

Revision	Report Date	Reason for Revision
∅	May 18, 2010	Initial Issue.
1	May 26, 2010	Revised to reflect engineer corrections.
2	July 14, 2010	Update Emission Designator



Table of Contents

1. Executive Summary	1
1.1. Testing Summary	2
2. Equipment Configuration.....	3
2.1. Overview	4
2.2. References	5
2.3. Test Site	5
2.4. Description of Test Sample	5
2.5. Equipment Configuration	6
2.6. Support Equipment	6
2.7. Ports and Cabling Information	6
2.8. Modifications	8
2.8.1. Modifications to EUT	8
2.8.2. Modifications to Test Standard	8
2.9. Disposition of EUT	8
3. Electromagnetic Compatibility Criteria for Unintentional Radiators	9
3.1. Conducted Emissions Limits.....	10
3.2. Radiated Emissions Limits.....	14
4. Electromagnetic Compatibility Criteria for Intentional Radiators	19
4.1. Peak Power Output.....	29
5. Electromagnetic Compatibility Occupied Bandwidth Requirements.....	42
5.1. Occupied Bandwidth (Emission Masks).....	42
6. Electromagnetic Compatibility Spurious Emissions at Antenna Terminal Requirements	48
6.1. Spurious Emissions at Antenna Terminals.....	48
7. Electromagnetic Compatibility Radiated Emissions Requirements	69
7.1. Radiated Emissions (Substitution Method).....	69
8. RF Exposure Requirements	78
8.1. Frequency Stability	79
9. Test Equipment	82
10. Certification Label & User’s Manual Information	83
10.1. Verification Information	84
10.2. Label and User’s Manual Information	88

All references to section numbers are taken directly from the standard/specification used. Only sections requiring testing or evaluation are included.



List of Tables

Table 1. Test Result Summary for Part 90Z.....	2
Table 2. EUT Summary.....	4
Table 3. References.....	5
Table 4. Equipment Configuration.....	6
Table 5. Support Equipment.....	6
Table 6. Ports and Cabling Information.....	6
Table 7. Conducted Limits for Radio Frequency Devices calculated from FCC Part 15 Section 15.107(a) (b).....	10
Table 8. Conducted Emissions - Voltage, AC Power, Phase Line 120V/60Hz.....	11
Table 9. Conducted Emissions - Voltage, AC Power, Neutral Line 120V/60Hz.....	11
Table 10. Radiated Emissions Limits calculated from FCC Part 15, §15.109 (a) (b).....	14
Table 11. Radiated Emissions Limits Test Results.....	15
Table 12. RF Output Power, Port 1 (HT5).....	21
Table 13. RF Output Power, Port 2 (HT5).....	21
Table 14. RF Output Power, Combined Ports (HT5).....	21
Table 15. RF Output Power, Port 1 (HT10).....	22
Table 16. RF Output Power, Port 2 (HT10).....	22
Table 17. RF Output Power, Combined Ports (HT10).....	22
Table 18. RF Output Power, Port 1 (HT20).....	23
Table 19. RF Output Power, Port 2 (HT20).....	23
Table 20. RF Output Power, Combined Ports (HT20).....	23
Table 21. PPSD Test Results – Port 1 (HT5).....	30
Table 22. PPSD Test Results – Port 2 (HT5).....	30
Table 23. PPSD Test Results – (HT5) Summed.....	31
Table 24. PPSD Test Results – (HT5) Combined Ports.....	31
Table 25. PPSD Test Results – Port 1 (HT10).....	32
Table 26. PPSD Test Results – Port 2 (HT10).....	32
Table 27. PPSD Test Results – (HT10) Summed.....	33
Table 28. PPSD Test Results – (HT10) Combined Ports.....	33
Table 29. PPSD Test Results – Port 1 (HT20).....	34
Table 30. PPSD Test Results – Port 2 (HT20).....	34
Table 31. PPSD Test Results – (HT20) Summed.....	34
Table 32. PPSD Test Results – (HT20) Combined Ports.....	34
Table 33. Radiated Harmonics, HT5.....	70
Table 34. Radiated Harmonics, HT10.....	72
Table 35. Radiated Harmonics, HT20.....	74
Table 36. Frequency Stability Test Results, Low Channel.....	80
Table 37. Frequency Stability Test Results, Mid Channel (3661MHz).....	80
Table 38. Frequency Stability Test Results, Mid Channel (3666MHz).....	81
Table 39. Frequency Stability Test Results, High Channel.....	81
Table 40. Test Equipment List.....	82



List of Plots

Plot 1. Radiated Emissions 30MHz – 1GHz	15
Plot 2. Radiated Emissions 1GHz – 10GHz	16
Plot 3. RF Output Power, Low Channel (HT5) – Port 1	24
Plot 4. RF Output Power, Mid Channel (HT5) – Port 1	24
Plot 5. RF Output Power, High Channel (HT5) – Port 1	24
Plot 6. RF Output Power, Low Channel (HT5) – Port 2	25
Plot 7. RF Output Power, Mid Channel (HT5) – Port 2	25
Plot 8. RF Output Power, High Channel (HT5) – Port 2	25
Plot 9. RF Output Power, Low Channel (HT10) – Port 1	26
Plot 10. RF Output Power, Mid Channel (HT10) – Port 1	26
Plot 11. RF Output Power, High Channel (HT10) – Port 1	26
Plot 12. RF Output Power, Low Channel (HT10) – Port 2	27
Plot 13. RF Output Power, Mid Channel (HT10) – Port 2	27
Plot 14. RF Output Power, High Channel (HT10) – Port 2	27
Plot 15. RF Output Power, Mid Channel (HT20) – Port 1	28
Plot 16. RF Output Power, Mid Channel (HT20) – Port 2	28
Plot 17. PPSD 5 MHz Low Ch (Port 1).....	35
Plot 18. PPSD 5 MHz Mid Ch (Port 1)	35
Plot 19. PPSD 5 MHz High Ch (Port 1).....	35
Plot 20. PPSD 5 MHz Low Ch (Port 2).....	36
Plot 21. PPSD 5 MHz Mid Ch (Port 2)	36
Plot 22. PPSD 5 MHz High Ch (Port 2).....	36
Plot 23. PPSD 5 MHz Low Ch (Combined Ports).....	37
Plot 24. PPSD 5 MHz Mid Ch (Combined Ports).....	37
Plot 25. PPSD 5 MHz High Ch (Combined Ports).....	37
Plot 26. PPSD 10 MHz Low Ch (Port 1).....	38
Plot 27. PPSD 10 MHz Mid Ch (Port 1)	38
Plot 28. PPSD 10 MHz High Ch (Port 1).....	38
Plot 29. PPSD 10 MHz Low Ch (Port 2).....	39
Plot 30. PPSD 10 MHz Mid Ch (Port 2)	39
Plot 31. PPSD 10 MHz High Ch (Port 2).....	39
Plot 32. PPSD 10 MHz Low Ch (Combined Ports).....	40
Plot 33. PPSD 10 MHz Mid Ch (Combined Ports)	40
Plot 34. PPSD 10 MHz High Ch (Combined Ports).....	40
Plot 35. PPSD 20 MHz Mid Ch (Port 1)	41
Plot 36. PPSD 20 MHz Mid Ch (Port 2)	41
Plot 37. PPSD 20 MHz Mid Ch (Combined Ports)	41
Plot 38. Occupied Bandwidth Low Channel (HT5) – Port 1	43
Plot 39. Occupied Bandwidth Mid Channel (HT5) – Port 1	43
Plot 40. Occupied Bandwidth High Channel (HT5) – Port 1	43
Plot 41. Occupied Bandwidth Low Channel (HT5) – Port 2	44
Plot 42. Occupied Bandwidth Mid Channel (HT5) – Port 2	44
Plot 43. Occupied Bandwidth High Channel (HT5) – Port 2	44
Plot 44. Occupied Bandwidth Low Channel (HT10) – Port 1	45
Plot 45. Occupied Bandwidth Mid Channel (HT10) – Port 1	45
Plot 46. Occupied Bandwidth High Channel (HT10) – Port 1	45
Plot 47. Occupied Bandwidth Low Channel (HT10) – Port 2	46
Plot 48. Occupied Bandwidth Mid Channel (HT10) – Port 2	46
Plot 49. Occupied Bandwidth High Channel (HT10) – Port 2	46



Plot 50. Occupied Bandwidth Mid Channel (HT20) – Port 1	47
Plot 51. Occupied Bandwidth Mid Channel (HT20) – Port 2	47
Plot 52. Conducted Spurious Emissions Low Ch, 30 MHz - 1GHz, (HT5) – Port 1	49
Plot 53. Conducted Spurious Emissions Low Ch, 1 GHz – 26GHz, (HT5) – Port 1	49
Plot 54. Conducted Spurious Emissions Low Ch, 26GHz – 40GHz, (HT5) – Port 1	49
Plot 55. Conducted Spurious Emissions Mid Ch, 30 MHz - 1GHz, (HT5) – Port 1	50
Plot 56. Conducted Spurious Emissions Mid Ch, 1 GHz – 26GHz, (HT5) – Port 1	50
Plot 57. Conducted Spurious Emissions Mid Ch, 26GHz – 40GHz, (HT5) – Port 1	50
Plot 58. Conducted Spurious Emissions High Ch, 30 MHz - 1GHz, (HT5) – Port 1	51
Plot 59. Conducted Spurious Emissions High Ch, 1 GHz – 26GHz, (HT5) – Port 1	51
Plot 60. Conducted Spurious Emissions High Ch, 26GHz – 40GHz, (HT5) – Port 1	51
Plot 61. Conducted Spurious Emissions Low Ch, 30 MHz - 1GHz, (HT5) – Port 2	52
Plot 62. Conducted Spurious Emissions Low Ch, 1 GHz – 26GHz, (HT5) – Port 2	52
Plot 63. Conducted Spurious Emissions Low Ch, 26GHz – 40GHz, (HT5) – Port 2	52
Plot 64. Conducted Spurious Emissions Mid Ch, 30 MHz - 1GHz, (HT5) – Port 2	53
Plot 65. Conducted Spurious Emissions Mid Ch, 1 GHz – 26GHz, (HT5) – Port 2	53
Plot 66. Conducted Spurious Emissions Mid Ch, 26GHz – 40GHz, (HT5) – Port 2	53
Plot 67. Conducted Spurious Emissions High Ch, 30 MHz - 1GHz, (HT5) – Port 2	54
Plot 68. Conducted Spurious Emissions High Ch, 1 GHz – 26GHz, (HT5) – Port 2	54
Plot 69. Conducted Spurious Emissions High Ch, 26GHz – 40GHz, (HT5) – Port 2	54
Plot 70. Conducted Spurious Emissions Low Ch, 30 MHz - 1GHz, (HT10) – Port 1	55
Plot 71. Conducted Spurious Emissions Low Ch, 1 GHz – 26GHz, (HT10) – Port 1	55
Plot 72. Conducted Spurious Emissions Low Ch, 26GHz – 40GHz, (HT10) – Port 1	55
Plot 73. Conducted Spurious Emissions Mid Ch, 30 MHz - 1GHz, (HT10) – Port 1	56
Plot 74. Conducted Spurious Emissions Mid Ch, 1 GHz – 26GHz, (HT10) – Port 1	56
Plot 75. Conducted Spurious Emissions Mid Ch, 26GHz – 40GHz, (HT10) – Port 1	56
Plot 76. Conducted Spurious Emissions High Ch, 30 MHz - 1GHz, (HT10) – Port 1	57
Plot 77. Conducted Spurious Emissions High Ch, 1 GHz – 26GHz, (HT10) – Port 1	57
Plot 78. Conducted Spurious Emissions High Ch, 26GHz – 40GHz, (HT10) – Port 1	57
Plot 79. Conducted Spurious Emissions Low Ch, 30 MHz - 1GHz, (HT10) – Port 2	58
Plot 80. Conducted Spurious Emissions Low Ch, 1 GHz – 26GHz, (HT10) – Port 2	58
Plot 81. Conducted Spurious Emissions Low Ch, 26GHz – 40GHz, (HT10) – Port 2	58
Plot 82. Conducted Spurious Emissions Mid Ch, 30 MHz - 1GHz, (HT10) – Port 2	59
Plot 83. Conducted Spurious Emissions Mid Ch, 1 GHz – 26GHz, (HT10) – Port 2	59
Plot 84. Conducted Spurious Emissions Mid Ch, 26GHz – 40GHz, (HT10) – Port 2	59
Plot 85. Conducted Spurious Emissions High Ch, 30 MHz - 1GHz, (HT10) – Port 2	60
Plot 86. Conducted Spurious Emissions High Ch, 1 GHz – 26GHz, (HT10) – Port 2	60
Plot 87. Conducted Spurious Emissions High Ch, 26GHz – 40GHz, (HT10) – Port 2	60
Plot 88. Conducted Spurious Emissions Mid Ch, 30 MHz - 1GHz, (HT20) – Port 1	61
Plot 89. Conducted Spurious Emissions Mid Ch, 1 GHz – 26GHz, (HT20) – Port 1	61
Plot 90. Conducted Spurious Emissions Mid Ch, 26GHz – 40GHz, (HT20) – Port 1	61
Plot 91. Conducted Spurious Emissions Mid Ch, 30 MHz - 1GHz, (HT20) – Port 2	62
Plot 92. Conducted Spurious Emissions Mid Ch, 1 GHz – 26GHz, (HT20) – Port 2	62
Plot 93. Conducted Spurious Emissions Mid Ch, 26GHz – 40GHz, (HT20) – Port 2	62
Plot 94. Conducted Band Edge Low Channel, HT5 – Port 1	63
Plot 95. Conducted Band Edge High Channel, HT5 – Port 1	63
Plot 96. Conducted Band Edge Low Channel, HT5 – Port 2	64
Plot 97. Conducted Band Edge High Channel, HT5 – Port 2	64
Plot 98. Conducted Band Edge Low Channel, HT10 – Port 1	65
Plot 99. Conducted Band Edge High Channel, HT10 – Port 1	65
Plot 100. Conducted Band Edge Low Channel, HT10 – Port 2	66



Plot 101. Conducted Band Edge High Channel, HT10 – Port 2.....	66
Plot 102. Conducted Band Edge Mid Channel (Low Band), HT20 – Port 1.....	67
Plot 103. Conducted Band Edge Mid Channel (High Band), HT20 – Port 1.....	67
Plot 104. Conducted Band Edge Mid Channel (Low Band), HT20 – Port 2.....	68
Plot 105. Conducted Band Edge Mid Channel (High Band), HT20 – Port 2.....	68
Plot 106. Radiated Spurious Low Channel, HT5 (1-18GHz) – All Ports.....	71
Plot 107. Radiated Spurious Mid Channel, HT5 (1-18GHz) – All Ports.....	71
Plot 108. Radiated Spurious High Channel, HT5 (1-18GHz) – All Ports.....	71
Plot 109. Radiated Spurious Low Channel, HT10 (1-18GHz) – All Ports.....	73
Plot 110. Radiated Spurious Mid Channel, HT10 (1-18GHz) – All Ports.....	73
Plot 111. Radiated Spurious High Channel, HT10 (1-18GHz) – All Ports.....	73
Plot 112. Radiated Spurious Mid Channel, HT20 (1-18GHz) – All Ports.....	74

List of Figures

Figure 1. Block Diagram of Test Configuration.....	7
Figure 2. RF Power Output Test Setup.....	20
Figure 3. PPSD Test Setup.....	29
Figure 4. Occupied Bandwidth Test Setup.....	42
Figure 5. Spurious Emissions at Antenna Terminals Test Setup.....	48

List of Photographs

Photograph 1. Ubiquiti Networks M365.....	5
Photograph 2. Conducted Emissions Test Setup.....	13
Photograph 3. Radiated Emission Limits 30MHz – 1GHz Test Setup.....	17
Photograph 4. Radiated Emission Limits 1GHz – 10GHz Test Setup.....	18
Photograph 5. Radiated Emission Spurious Test Setup.....	75
Photograph 6. Radiated Emission Spurious Bilog Antenna Test Setup.....	76
Photograph 7. Radiated Emission Spurious Horn Antenna Test Setup.....	77



List of Terms and Abbreviations

AC	Alternating Current
ACF	Antenna Correction Factor
Cal	Calibration
<i>d</i>	Measurement Distance
dB	Decibels
dB μ A	Decibels above one microamp
dB μ V	Decibels above one microvolt
dB μ A/m	Decibels above one microamp per meter
dB μ V/m	Decibels above one microvolt per meter
DC	Direct Current
E	Electric Field
DSL	Digital Subscriber Line
ESD	Electrostatic Discharge
EUT	Equipment Under Test
<i>f</i>	Frequency
FCC	Federal Communications Commission
GR-1089-CORE	(GR) General Requirement(s) imposed by the NEBS standard, (CORE) Central Office Recovery Express (AT&T), (1089) specifies various parts of the General Requirements under Bellcore Technical Standard, Requirements for Electromagnetic Compatibility and Electrical Safety - Generic Criteria for Network Telecommunications Equipment
GRP	Ground Reference Plane
H	Magnetic Field
HCP	Horizontal Coupling Plane
Hz	Hertz
IEC	International Electrotechnical Commission
kHz	kilohertz
kPa	kilopascal
kV	kilovolt
LISN	Line Impedance Stabilization Network
MHz	Megahertz
μ H	microhenry
μ	microfarad
μ s	microseconds
NEBS	Network Equipment-Building System
PRF	Pulse Repetition Frequency
RF	Radio Frequency
RMS	Root-Mean-Square
TWT	Traveling Wave Tube
V/m	Volts per meter
VCP	Vertical Coupling Plane



Executive Summary



1. Testing Summary

These tests were conducted on a sample of the equipment for the purpose of demonstrating compliance with Part 90, Subpart Z. All tests were conducted using measurement procedure ANSI TIA/EIA-603-A-2004.

Title 47 of the CFR, Part 90, Subpart Z, Reference and Test Description	Conformance			Comments
	Yes	No	N/A	
	<i>Yes - Equipment complies with the Requirement</i> <i>No - Equipment does not comply with the Requirement</i> <i>N/A - Not applicable to the equipment under tests</i>			
90.1319(b) Policies governing the use of the 3650–3700 MHz band.	✓			Compliant
2.1046; 90.1321(a) RF Power Output	✓			Compliant
2.1046; 90.1321(a) Peak Power Spectral Density	✓			Compliant
2.1049 Occupied Bandwidth	✓			Compliant
2.1051; 90.1323(a) Spurious Emissions at Antenna Terminals	✓			Compliant
2.1053; 15.209 Radiated Spurious Emissions	✓			Compliant
RF exposure 90.1335	✓			Compliant
Frequency Stability §2.1055, 90.213	✓			Compliant
15.107	✓			AC Power Line Conducted Emissions for unintentional radiators
15.109	✓			Radiated Spurious Emissions for unintentional radiators

Table 1. Test Result Summary for Part 90Z



Equipment Configuration



2. Equipment Configuration

2.1. Overview

MET Laboratories, Inc. was contracted by Ubiquiti Networks to perform testing on the M365 under purchase order number US100061.

This document describes the test setups, test methods, required test equipment, and the test limit criteria used to perform compliance testing of the Ubiquiti Networks., M365.

An EMC evaluation to determine compliance of the TB 4.9 with the requirements of Part 90, Subpart Z, was conducted. (All references are to the most current version of Title 47 of the Code of Federal Regulations in effect). In accordance with §2.1033, the following data is presented in support of the Certification of the TB4.9. Ubiquiti Networks. should retain a copy of this document and it should be kept on file for at least five years after the manufacturing of the EUT has been **permanently** discontinued. The results obtained relate only to the item(s) tested.

Model(s) Tested:	M365			
Model(s) Covered:	M365			
EUT Specifications:	Primary Power Source: Laptop			
	FCC ID: SWX- M365			
	Type of Modulations:	OFDM		
	Emission Designators:	5MHz	10MHz	20MHz
		4M61D7D	8M88D7D	17M8D7D
	RF Output Power (EIRP):	36.97dBm	39.96dBm	42.68dBm
	Equipment Code:	TNB		
EUT Frequency Ranges:	3656-3671MHz	3656-3666MHz	3661-3661MHz	
Analysis:	The results obtained relate only to the item(s) tested.			
Environmental Test Conditions:	Temperature: 15-35° C			
	Relative Humidity: 30-60%			
	Barometric Pressure: 860-1060 mbar			
Evaluated by:	Anderson Soungpanya			
Date(s):	April 2, April 5 & April 8, 2010			

Table 2. EUT Summary

2.2. References

CFR 47, Part 90, Subpart Z	Federal Communication Commission, Code of Federal Regulations, Title 47, Part 90: Private Land Mobile Radios Services, Subpart Z-Wireless Broadband Services in the 3650-3700MHz Band
CFR 47, Part 15, Subpart B	Electromagnetic Compatibility: Criteria for Radio Frequency Devices
ANSI C63.4:2003	Methods and Measurements of Radio-Noise Emissions from Low-Voltage Electrical And Electronic Equipment in the Range of 9 kHz to 40 GHz
ANSI C63.10-2009	American National Standard for Testing Unlicensed Wireless Devices
ANSI/NCSL Z540-1-1994	Calibration Laboratories and Measuring and Test Equipment - General Requirements
ANSI/ISO/IEC 17025:2000	General Requirements for the Competence of Testing and Calibration Laboratories

Table 3. References

2.3. Test Site

All testing was performed at MET Laboratories, Inc., 3162 Belick Street, Santa Clara, CA 95054. All equipment used in making physical determinations is accurate and bears recent traceability to the National Institute of Standards and Technology.

Radiated Emissions measurements were performed in a semi-anechoic chamber (equivalent to an Open Area Test Site). In accordance with §2.948(a)(3), a complete site description is contained at MET Laboratories.

2.4. Description of Test Sample

The Ubiquiti Networks M365, is a 3.65GHz 802.11n 2x2 MIMO radio.

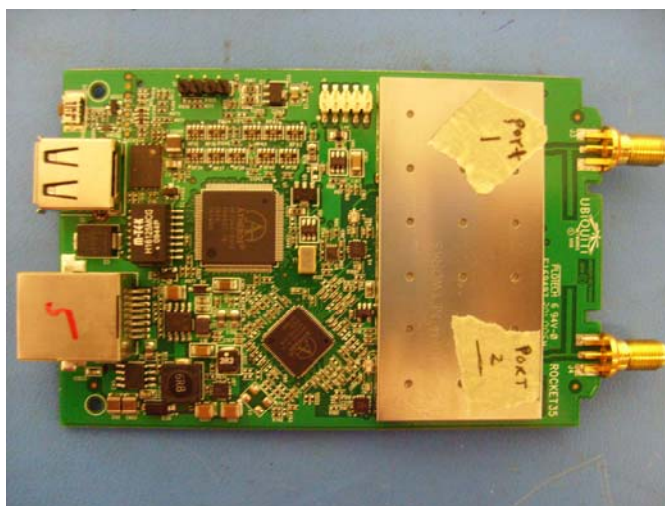

Photograph 1. Ubiquiti Networks M365



2.5. Equipment Configuration

The EUT was set up as outlined in Figure 1, Block Diagram of Test Setup. All cards, racks, etc., incorporated as part of the EUT is included in the following list.

Ref. ID	Name / Description	Model Number	Part Number	Serial Number
A	3.6GHz Radio	M35	M35	6
B	POE	UB1-POE-15-8	NA	0908-0012288

Table 4. Equipment Configuration

2.6. Support Equipment

Ubiquiti Networks supplied support equipment necessary for the operation and testing of the M365. All support equipment supplied is listed in the following Support Equipment List.

Ref. ID	Name / Description	Manufacturer	Model Number
D	Spectrum Analyzer	Agilent	E4407B
C	Laptop	Dell	Vostro 1000

Table 5. Support Equipment

2.7. Ports and Cabling Information

Ref. ID	Port name on EUT	Cable Description or reason for no cable	Qty.	Length (m)	Shielded (Y/N)	Termination Box ID & Port Name
	Antenna Port1	Coaxial Cable	1	0.1	Y	D
	Antenna Port2	Coaxial Cable	1	0.1	Y	D
	A, Ethernet	CAT 5	1	0.5-3m	Y	B, POE
	B, Lan	CAT 5	1	0.5-3m	Y	C, Laptop
	B, AC input	Power Cord	1	.5	N	100-240V AC power

Table 6. Ports and Cabling Information

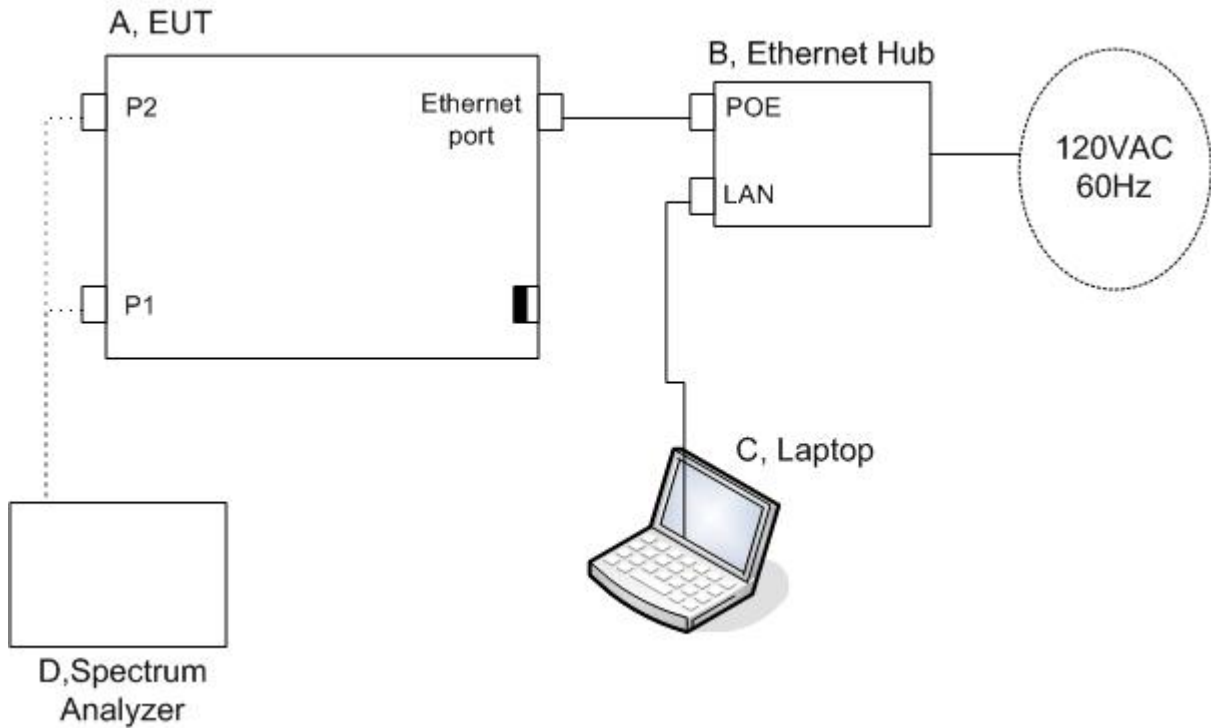

Figure 1. Block Diagram of Test Configuration



2.8. Modifications

2.8.1. Modifications to EUT

No modifications were made to the EUT.

2.8.2. Modifications to Test Standard

No modifications were made to the EUT.

2.9. Disposition of EUT

The test sample including all support equipment submitted to the Electro-Magnetic Compatibility Lab for testing was returned to Ubiquiti Networks upon completion of testing.



III. Electromagnetic Compatibility Criteria for Unintentional Radiators



3. Electromagnetic Compatibility Criteria for Unintentional Radiators

3.1. Conducted Emissions Limits

Test Requirement(s): **15.107 (a)** “Except for Class A digital devices, for equipment that is designed to be connected to the public utility (AC) power line, the radio frequency voltage that is conducted back onto the AC power line on any frequency or frequencies within the band 150 kHz to 30 MHz shall not exceed the limits in Table 7. Compliance with this provision shall be based on the measurement of the radio frequency voltage between each power line and ground at the power terminals.”

15.107 (b) “For a Class A digital device that is designed to be connected to the public utility (AC) power line, the radio frequency voltage that is conducted back onto the AC power line on any frequency or frequencies within the band 150 kHz to 30 MHz shall not exceed the limits in Table 7. Compliance with this provision shall be based on the measurement of the radio frequency voltage between each power line and ground at the power terminals. The lower limit applies at the band edges.”

Frequency range (MHz)	15.107(b), Class A Limits (dBµV)		15.107(a), Class B Limits (dBµV)	
	Quasi-Peak	Average	Quasi-Peak	Average
0.15- 0.5	79	66	66 - 56	56 - 46
0.5 – 5.0	73	60	56	46
5.0 - 30	73	60	60	50

Note — The lower limit shall apply at the transition frequencies.

Table 7. Conducted Limits for Radio Frequency Devices calculated from FCC Part 15 Section 15.107(a) (b)

Test Procedures: The EUT was placed on a 0.8m-high wooden table inside a semi-anechoic chamber. The method of testing, test conditions, and test procedures of ANSI C63.4 were used. The EUT was powered through a 50Ω/50µH LISN. An EMI receiver, connected to the measurement port of the LISN, scanned the frequency range from 150 kHz to 30 MHz in order to find the peak conducted emissions. All peak emissions within 6 dB of the limit were re-measured using a quasi-peak and/or average detector as appropriate.

Test Results: The EUT was found compliant with the Class B requirement(s) of this section. Measured emissions below applicable limits.

Test Engineer(s): Anderson Soungpanya

Test Date(s): 04/13/10



Conducted Emissions - Voltage, AC Power

Freq (MHz)	QP Amplitude	QP Limit	Delta	Results	Average Amplitude	Average Limit	Delta	Results
.171	52.78	64.915	-12.135	Pass	41.23	54.915	-13.685	Pass
.409	49.04	57.691	-8.651	Pass	42.77	47.691	-4.921	Pass
3.93	37.72	56	-18.28	Pass	23.61	46	-22.39	Pass
23.13	48.87	60	-11.13	Pass	44.26	50	-5.74	Pass

Table 8. Conducted Emissions - Voltage, AC Power, Phase Line 120V/60Hz

Freq (MHz)	QP Amplitude	QP Limit	Delta	Results	Average Amplitude	Average Limit	Delta	Results
.170	52.06	64.963	-12.903	Pass	41.26	54.963	-13.703	Pass
.252	31.44	61.703	-30.263	Pass	15.37	51.703	-36.333	Pass
.408	46.73	57.712	-10.982	Pass	37.35	47.712	-10.362	Pass
9.55	56.15	60	-3.85	Pass	25.97	50	-24.03	Pass
23.13	45.5	60	-14.5	Pass	43.68	50	-6.32	Pass

Table 9. Conducted Emissions - Voltage, AC Power, Neutral Line 120V/60Hz



Conducted Emissions - Voltage, Worst Case Emissions, AC Power

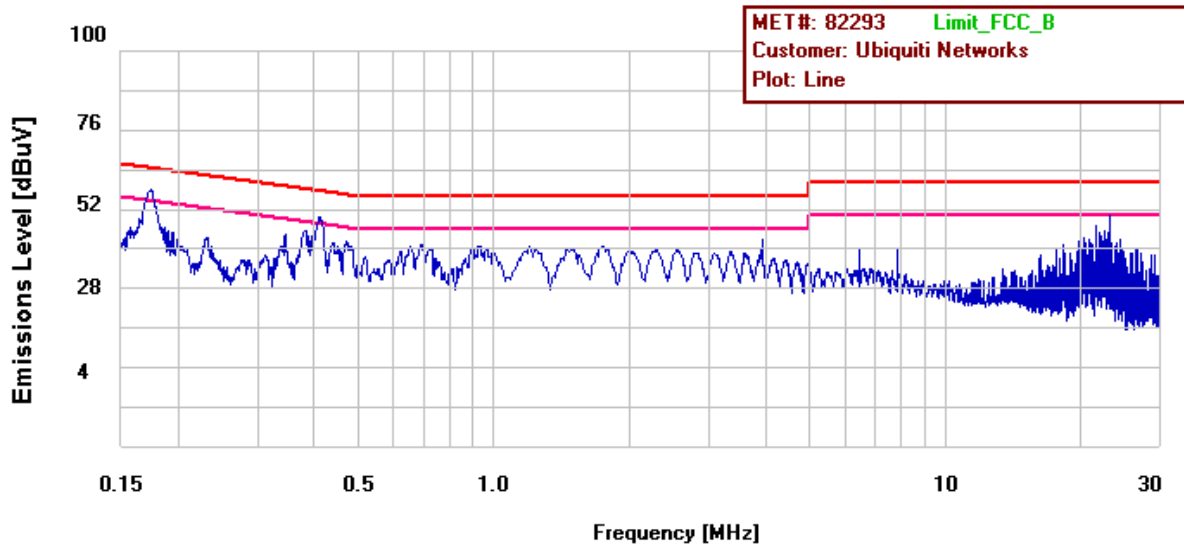

Conducted Emission, Phase Line Plots

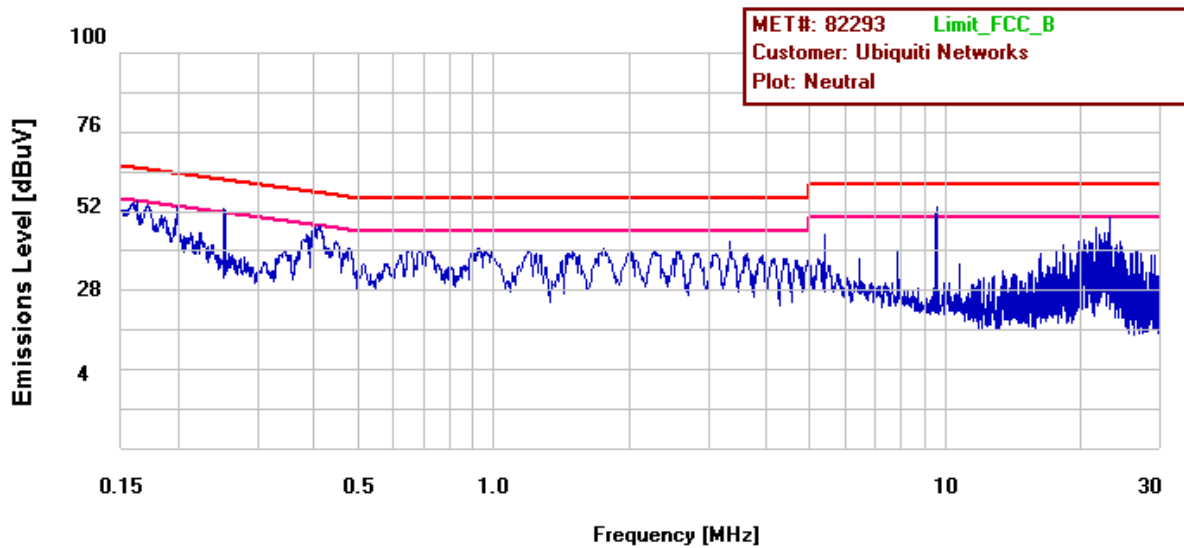

Conducted Emission, Neutral Line Plots

Conducted Emission Limits Test Setup



Photograph 2. Conducted Emissions Test Setup



3.2. Radiated Emissions Limits

Test Requirement(s): **15.109 (a)** Except for Class A digital devices, the field strength of radiated emissions from unintentional radiators at a distance of 3 meters shall not exceed the Class B limits expressed in Table 10.

15.109 (b) The field strength of radiated emissions from a Class A digital device, as determined at a distance of 10 meters, shall not exceed the Class A limits expressed in Table 10.

Frequency (MHz)	Field Strength (dBµV/m)	
	§15.109 (b), Class A Limit (dBµV) @ 10m	§15.109 (a), Class B Limit (dBµV) @ 3m
30 - 88	39.00	40.00
88 - 216	43.50	43.50
216 - 960	46.40	46.00
Above 960	49.50	54.00

Table 10. Radiated Emissions Limits calculated from FCC Part 15, §15.109 (a) (b)

Test Procedures: The EUT was placed on a 0.8m-high wooden table inside a semi-anechoic chamber. The method of testing and test conditions of ANSI C63.4 were used. An antenna was located 10 m from the EUT on an adjustable mast. A pre-scan was first performed in order to find prominent radiated emissions. For final emissions measurements at each frequency of interest, the EUT was rotated and the antenna height was varied between 1 m and 4 m in order to maximize the emission. Measurements in both horizontal and vertical polarities were made and the data was recorded. Unless otherwise specified, measurements were made using a quasi-peak detector with a 120 kHz bandwidth.

Test Results: The EUT was found compliant with the Class A requirement(s) of this section. Measured emissions below applicable limits.

Test Engineer(s): Anderson Soungpanya

Test Date(s): 04/13/10



Radiated Emissions Limits Test Results, Class A

Frequency (MHz)	Antenna Polarity	EUT Azimuth (Degrees)	Antenna Height (cm)	Uncorrected Amplitude (dBµV)	ACF (dB/m)	Pre Amp Gain (dB)	CBL (dB)	Corrected Amplitude (dBµV)	Limit (dBµV)	Margin (dB)
799.98	H	269	100	14.45	20.9	0	6.23	41.58	46	-4.42
800.02	V	170	112	11.9	20.3	0	6.23	38.43	46	-7.57
399.98	V	191	108	10.26	15.899	0	4.15	30.309	46	-15.691
399.98	H	127	100	10.92	16.4	0	4.15	31.47	46	-14.53
249.99	V	350	106	9.65	12.699	0	3.74	26.089	46	-19.911
64.79	V	116	99.82	15.423	6.121	0	2.11	23.654	40	-16.346
1600	H	213	123	87.29	28.832	75.758	9.31	49.674	54	-4.326
2000	H	200	100	77.2	30.988	75.27	10.43	43.348	54	-10.652

Table 11. Radiated Emissions Limits Test Results

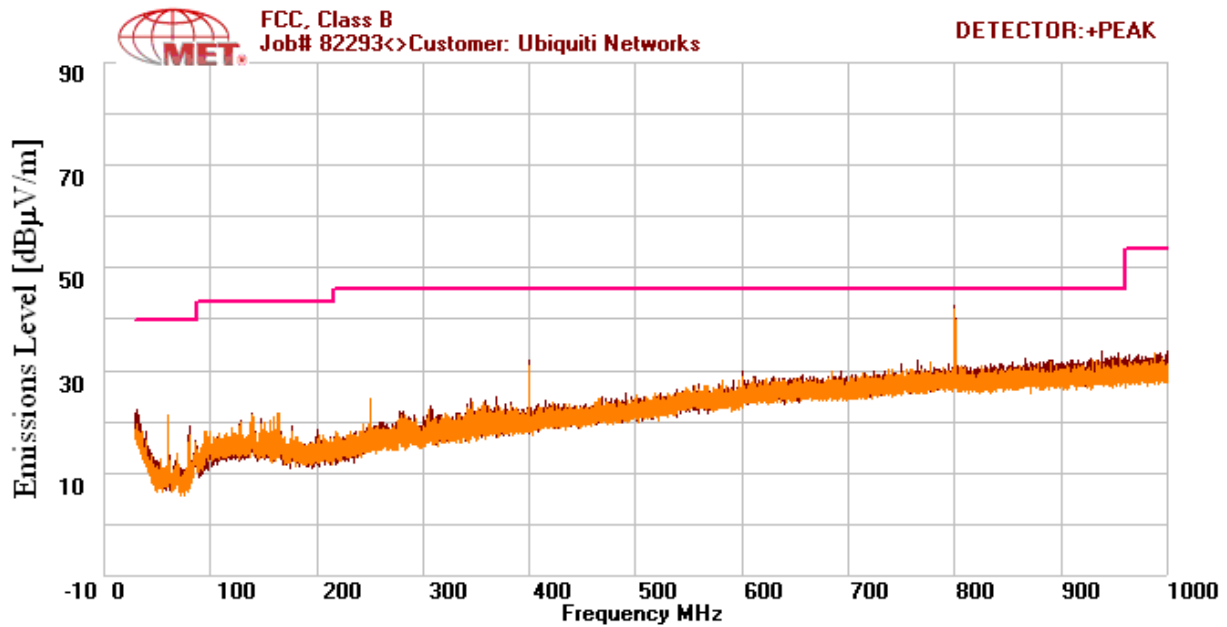

Plot 1. Radiated Emissions 30MHz – 1GHz

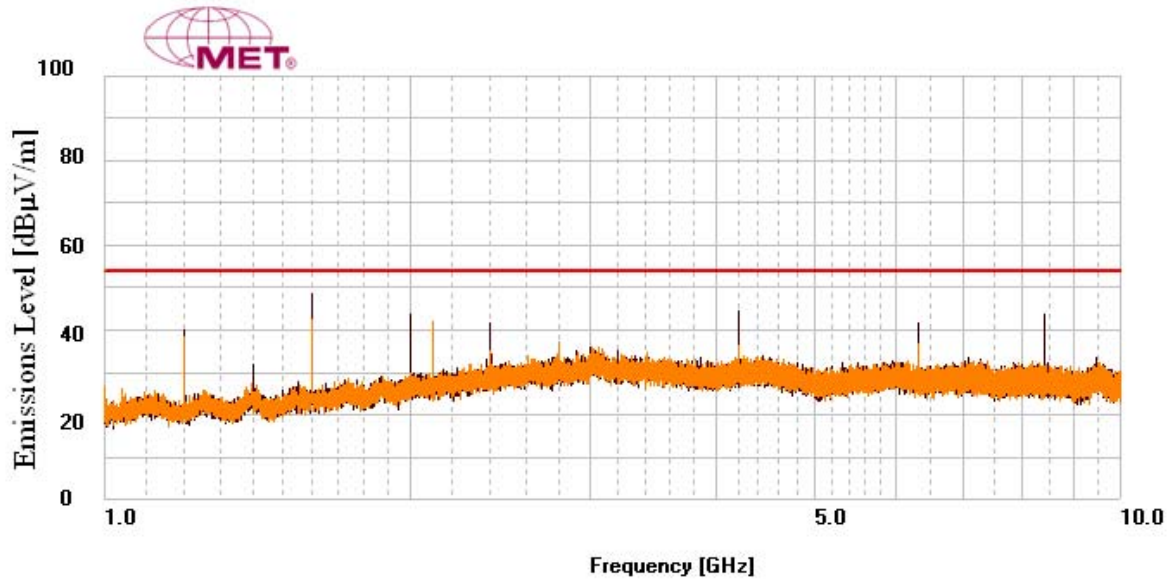

Plot 2. Radiated Emissions 1GHz – 10GHz

Radiated Emission Limits Test Setup



Photograph 3. Radiated Emission Limits 30MHz – 1GHz Test Setup

Radiated Emission Limits Test Setup



Photograph 4. Radiated Emission Limits 1GHz – 10GHz Test Setup



IV. Electromagnetic Compatibility Criteria for Intentional Radiators

4. Electromagnetic Compatibility RF Power Output Requirements

4.1. RF Power Output

Test Requirement(s): §2.1046 and §90.1321 (a)

Test Procedures: As required by 47 CFR 2.1046, *RF power output measurements* were made at the RF output terminals using a Directional Coupler through a Spectrum Analyzer.

A laptop was connected to EUT to control the RF power output and frequency. The EUT was connected to a Spectrum Analyzer through a Directional Coupler. A calibrated power meter capable of measuring a broad band modulated carrier was connected to the coupling port. The spectrum analyzer's channel power measuring option was used. Both the spectrum analyzer and power meter were compared to insure they both indicated the same output power for the EUT. The EUT power was adjusted to produce maximum output power as specified in the owner's manual. Measurements were performed at the low, mid and high channels for each of the EUT's bandwidths and modulations. For MIMO operation each port was measured and summed then compared to the limit for compliance.

Limits:
For Base and Fixed stations the EIRP limit is 5W / 5MHz.
For Base and Fixed stations the EIRP limit is 10W / 10MHz.
For Base and Fixed stations the EIRP limit is 20W / 20MHz.

Test Results: Equipment complies with 47CFR 2.1046 and 90.1321(a).

Test Engineer(s): Anderson Soungpanya

Test Date(s): 04/02/10

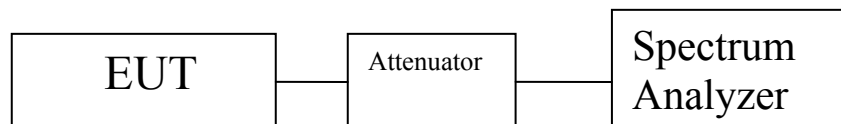

Figure 2. RF Power Output Test Setup



RF Output Power Test Results

Frequency (MHz)	Channel	Conducted Power (dBm)	Antenna Gain (dBi)	EIRP (dBm)	EIRP (mW)
3656	Low	16.76	17	33.76	2376.84
3661	Mid	16.24	17	33.24	2108.63
3671	High	16.33	17	33.33	2152.78
3656	Low	12.76	21	33.76	2376.84
3661	Mid	12.24	21	33.24	2108.63
3671	High	12.33	21	33.33	2152.78
3656	Low	5.76	28	33.76	2376.84
3661	Mid	5.24	28	33.24	2108.63
3671	High	5.33	28	33.33	2152.78

Table 12. RF Output Power, Port 1 (HT5)

Frequency (MHz)	Channel	Conducted Power (dBm)	Antenna Gain (dBi)	EIRP (dBm)	EIRP (mW)
3656	Low	17.15	17	34.15	2600.16
3661	Mid	17.34	17	34.34	2716.44
3671	High	16.54	17	33.54	2259.44
3656	Low	13.15	21	34.15	2600.16
3661	Mid	13.34	21	34.34	2716.44
3671	High	12.54	21	33.54	2259.44
3656	Low	6.15	28	34.15	2600.16
3661	Mid	6.34	28	34.34	2716.44
3671	High	5.54	28	33.54	2259.44

Table 13. RF Output Power, Port 2 (HT5)

Frequency (MHz)	Channel	Antenna Gain (dBi)	Sum of Ports mW	Limit mW	Margin mW	Sum of Ports dBm	Limit dBm	Margin dBm
3656	Low	17	4977.00	5000	-23.00	36.97	37	-0.03
3661	Mid	17	4825.07	5000	-174.93	36.84	37	-0.16
3671	High	17	4412.22	5000	-587.78	36.45	37	-0.55
3656	Low	21	4977.00	5000	-23.00	36.97	37	-0.03
3661	Mid	21	4825.07	5000	-174.93	36.84	37	-0.16
3671	High	21	4412.22	5000	-587.78	36.45	37	-0.55
3656	Low	28	4977.00	5000	-23.00	36.97	37	-0.03
3661	Mid	28	4825.07	5000	-174.93	36.84	37	-0.16
3671	High	28	4412.22	5000	-587.78	36.45	37	-0.55

Table 14. RF Output Power, Combined Ports (HT5)



RF Output Power Test Results

Frequency (MHz)	Channel	Conducted Power (dBm)	Antenna Gain (dBi)	EIRP (dBm)	EIRP (mW)
3656	Low	19.34	17	36.34	4305.27
3661	Mid	19.57	17	36.57	4539.42
3666	High	19.48	17	36.48	4446.31
3656	Low	15.34	21	36.34	4305.27
3661	Mid	15.57	21	36.57	4539.42
3666	High	15.48	21	36.48	4446.31
3656	Low	8.34	28	36.34	4305.27
3661	Mid	8.57	28	36.57	4539.42
3666	High	8.48	28	36.48	4446.31

Table 15. RF Output Power, Port 1 (HT10)

Frequency (MHz)	Channel	Conducted Power (dBm)	Antenna Gain (dBi)	EIRP (dBm)	EIRP (mW)
3656	Low	20.48	17	37.48	5597.58
3661	Mid	20.03	17	37.03	5046.61
3666	High	20.02	17	37.02	5035.01
3656	Low	16.48	21	37.48	5597.58
3661	Mid	16.03	21	37.03	5046.61
3666	High	16.02	21	37.02	5035.01
3656	Low	9.48	28	37.48	5597.58
3661	Mid	9.03	28	37.03	5046.61
3666	High	9.02	28	37.02	5035.01

Table 16. RF Output Power, Port 2 (HT10)

Frequency (MHz)	Channel	Antenna Gain (dBi)	Sum of Ports mW	Limit mW	Margin mW	Sum of Ports dBm	Limit dBm	Margin dBm
3656	Low	17	9902.84	10000	-97.16	39.96	40	-0.04
3661	Mid	17	9586.03	10000	-413.97	39.82	40	-0.18
3666	High	17	9481.32	10000	-518.68	39.77	40	-0.23
3656	Low	21	9902.84	10000	-97.16	39.96	40	-0.04
3661	Mid	21	9586.03	10000	-413.97	39.82	40	-0.18
3666	High	21	9481.32	10000	-518.68	39.77	40	-0.23
3656	Low	28	9902.84	10000	-97.16	39.96	40	-0.04
3661	Mid	28	9586.03	10000	-413.97	39.82	40	-0.18
3666	High	28	9481.32	10000	-518.68	39.77	40	-0.23

Table 17. RF Output Power, Combined Ports (HT10)



RF Output Power Test Results

Frequency (MHz)	Channel	Conducted Power (dBm)	Antenna Gain (dBi)	EIRP (dBm)	EIRP (mW)
3661	Mid	22.54	17	39.54	8994.98
3661	Mid	18.54	21	39.54	8994.98
3661	Mid	11.54	28	39.54	8994.98

Table 18. RF Output Power, Port 1 (HT20)

Frequency (MHz)	Channel	Conducted Power (dBm)	Antenna Gain (dBi)	EIRP (dBm)	EIRP (mW)
3661	Mid	22.80	17	39.8	9549.93
3661	Mid	18.80	21	39.8	9549.93
3661	Mid	11.80	28	39.8	9549.93

Table 19. RF Output Power, Port 2 (HT20)

Frequency (MHz)	Channel	Antenna Gain (dBi)	Sum of Ports mW	Limit mW	Margin mW	Sum of Ports dBm	Limit dBm	Margin dBm
3661	Mid	17	18544.90	20000	-1455.10	42.68	43	-0.32
3661	Mid	21	18544.90	20000	-1455.10	42.68	43	-0.32
3661	Mid	28	18544.90	20000	-1455.10	42.68	43	-0.32

Table 20. RF Output Power, Combined Ports (HT20)



RF Output Power Test Results

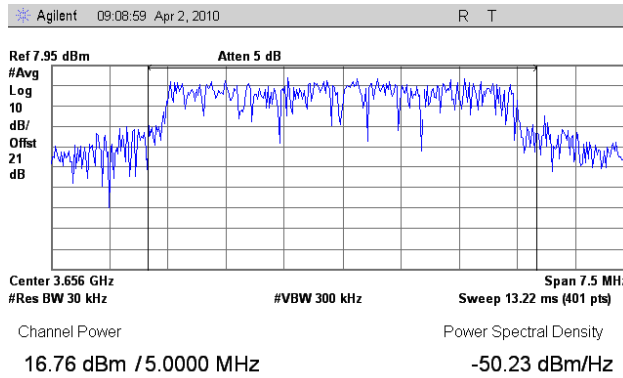

Plot 3. RF Output Power, Low Channel (HT5) – Port 1

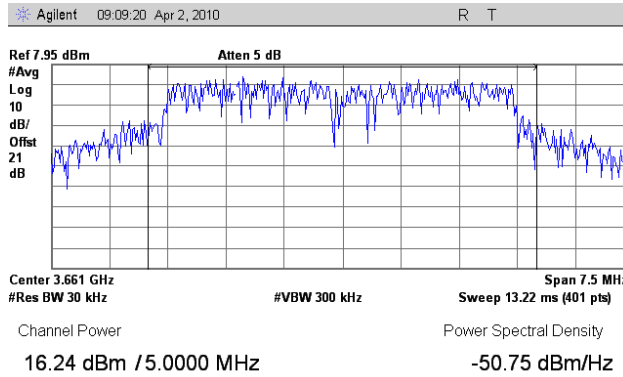

Plot 4. RF Output Power, Mid Channel (HT5) – Port 1

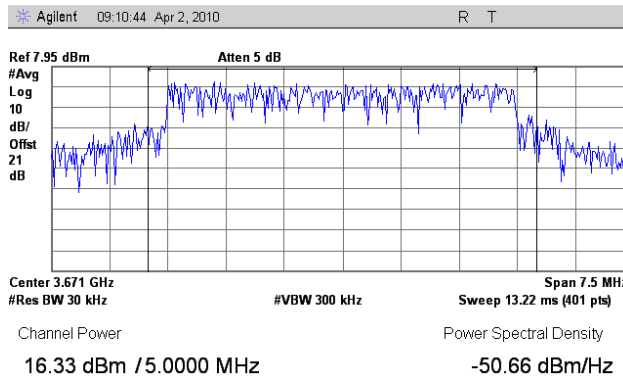

Plot 5. RF Output Power, High Channel (HT5) – Port 1



RF Output Power Test Results

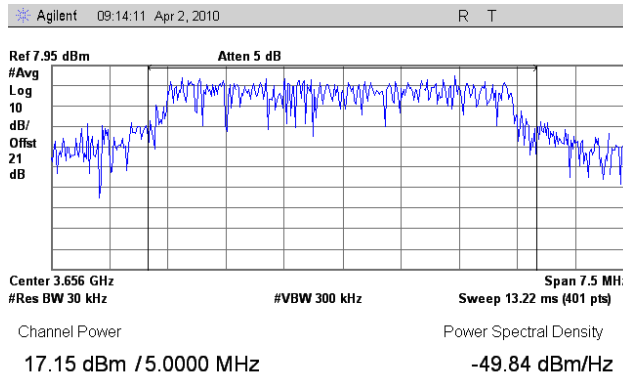

Plot 6. RF Output Power, Low Channel (HT5) – Port 2

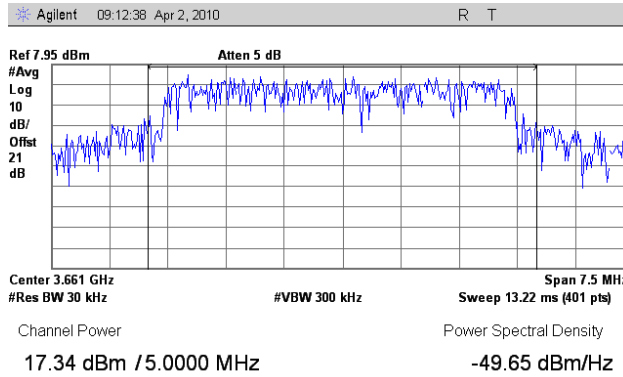

Plot 7. RF Output Power, Mid Channel (HT5) – Port 2

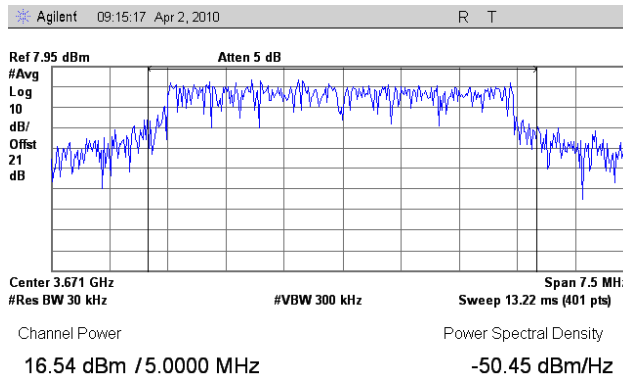

Plot 8. RF Output Power, High Channel (HT5) – Port 2



RF Output Power Test Results

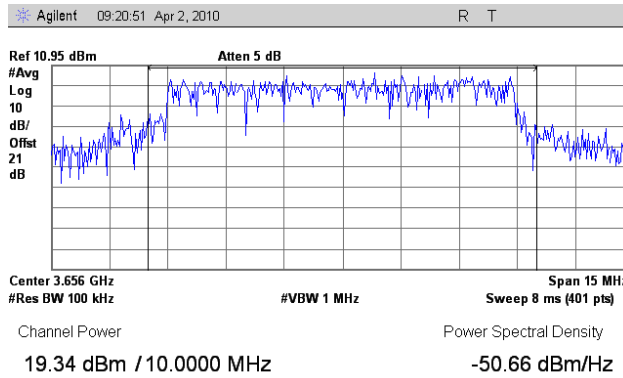

Plot 9. RF Output Power, Low Channel (HT10) – Port 1

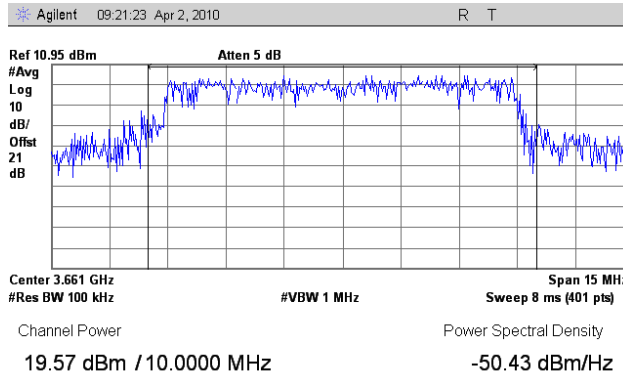

Plot 10. RF Output Power, Mid Channel (HT10) – Port 1

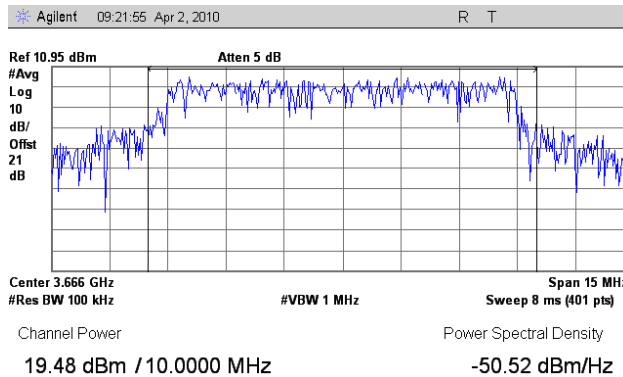

Plot 11. RF Output Power, High Channel (HT10) – Port 1



RF Output Power Test Results

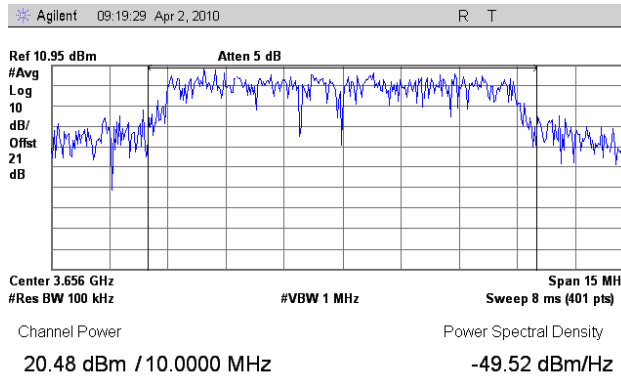

Plot 12. RF Output Power, Low Channel (HT10) – Port 2

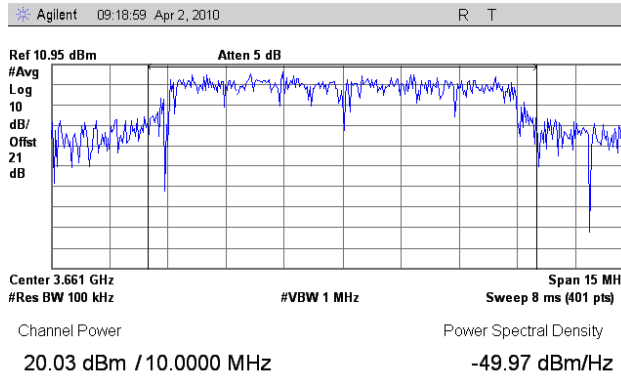

Plot 13. RF Output Power, Mid Channel (HT10) – Port 2

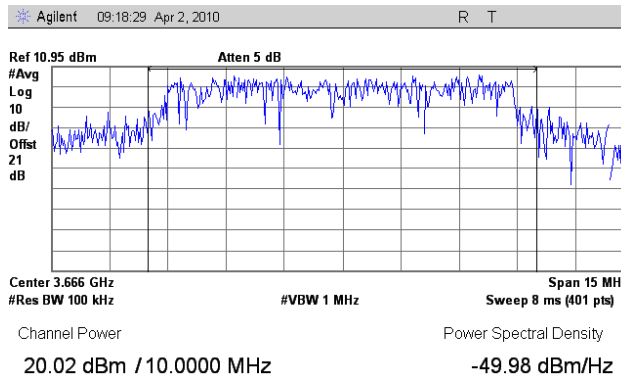

Plot 14. RF Output Power, High Channel (HT10) – Port 2



RF Output Power Test Results

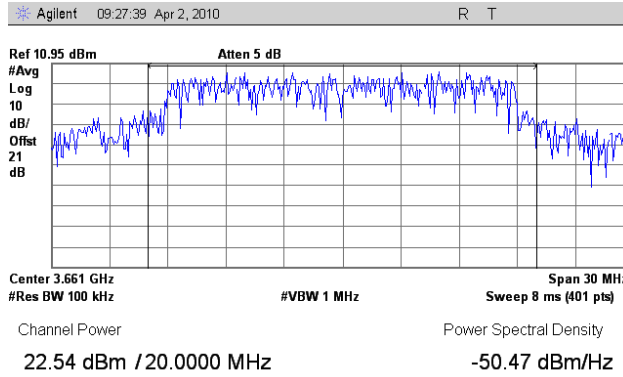

Plot 15. RF Output Power, Mid Channel (HT20) – Port 1

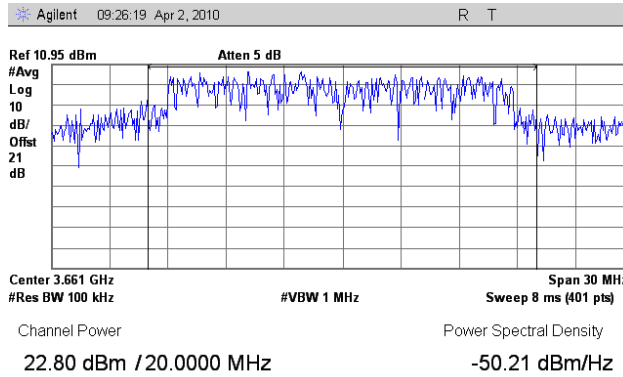

Plot 16. RF Output Power, Mid Channel (HT20) – Port 2

4.2. Peak Power Spectral Density

Test Requirement(s): §90.1321(a) check docket

Test Procedures: As required by 47 CFR 2.1046, *RF power output measurements* were made at the RF output terminals using a Directional Coupler through a Spectrum Analyzer and Power Meter.

A laptop was connected to EUT to control the RF power output and frequency. The EUT was connected to a Spectrum Analyzer through a directional coupler. A calibrated power meter capable of measuring a broad band modulated carrier was connected to the coupling port. The power meter was used to insure the EUT was operating at the required power level for the Spectral Density test. The Spectrum Analyzer was set to a RBW = 1 MHz and a VBW > 1MHz. A sample detector was selected on the spectrum analyzer along with power averaging. The Peak Power Spectral Density was determined by detecting the highest emission within the EUT's occupied bandwidth. Measurements were performed at the low, mid and high channels for each of the EUT's bandwidths and modulations. For MIMO operation each port was measured and summed then compared to the limit for compliance. Measurements were also taken with both ports 1 and 2 connected to a combiner then compared to the limit for compliance

Limits: For Base and Fixed stations the radiated Peak Power Spectral Density limit is 30dBm or 1000mW.

Test Results: Equipment complies with 47 CFR 2.1046 and 90.1321(a).

The following pages show measurements of Power Spectral Density plots which is recorded below:

Test Engineer(s): Anderson Soungpanya

Test Date(s): 04/02/10

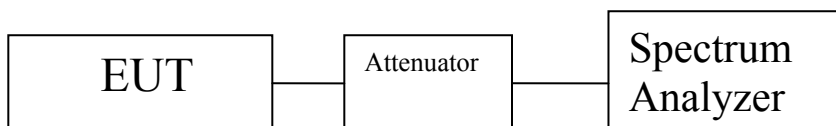

Figure 3. PPSD Test Setup



Peak Power Spectral Density Test Results

Frequency (MHz)	Channel	Power Spectral Density (dBm)	Antenna Gain (dBi)	Power Spectral Density EIRP (dBm)	Power Spectral Density EIRP (mW)
3656	Low	9.66	17	26.655	462.91
3661	Mid	9.34	17	26.337	430.23
3671	High	9.05	17	26.051	402.81
3656	Low	5.66	21	26.655	462.91
3661	Mid	5.34	21	26.337	430.23
3671	High	5.05	21	26.051	402.81
3656	Low	-1.35	28	26.655	462.91
3661	Mid	-1.66	28	26.337	430.23
3671	High	-1.95	28	26.051	402.81

Table 21. PPSD Test Results – Port 1 (HT5)

Frequency (MHz)	Channel	Power Spectral Density (dBm)	Antenna Gain (dBi)	Power Spectral Density EIRP (dBm)	Power Spectral Density EIRP (mW)
3656	Low	10.14	17	27.14	517.61
3661	Mid	10.26	17	27.26	532.11
3671	High	10.54	17	27.54	567.54
3656	Low	6.14	21	27.14	517.61
3661	Mid	6.26	21	27.26	532.11
3671	High	6.54	21	27.54	567.54
3656	Low	-0.86	28	27.14	517.61
3661	Mid	-0.74	28	27.26	532.11
3671	High	-0.46	28	27.54	567.54

Table 22. PPSD Test Results – Port 2 (HT5)



Peak Power Spectral Density Test Results

Frequency (MHz)	Channel	Antenna Gain (dBi)	Sum of Ports mW	Limit mW	Margin mW	Sum of Ports dBm	Limit dBm	Margin dBm
3656	Low	17	980.52	1000	-19.48	29.91	30	-0.09
3661	Mid	17	962.34	1000	-37.66	29.83	30	-0.17
3671	High	17	970.35	1000	-29.65	29.87	30	-0.13
3656	Low	21	980.52	1000	-19.48	29.91	30	-0.09
3661	Mid	21	962.34	1000	-37.66	29.83	30	-0.17
3671	High	21	970.35	1000	-29.65	29.87	30	-0.13
3656	Low	28	980.52	1000	-19.48	29.91	30	-0.09
3661	Mid	28	962.34	1000	-37.66	29.83	30	-0.17
3671	High	28	970.35	1000	-29.65	29.87	30	-0.13

Table 23. PPSD Test Results – (HT5) Summed

Frequency (MHz)	Channel	Power Spectral Density (dBm)	Antenna Gain (dBi)	Power Spectral Density EIRP (dBm)	Limit dBm	Margin dBm
3656	Low	12.71	17	29.71	30	-0.29
3661	Mid	12.88	17	29.88	30	-0.12
3671	High	12.71	17	29.71	30	-0.29
3656	Low	8.71	21	29.71	30	-0.29
3661	Mid	8.88	21	29.88	30	-0.12
3671	High	8.71	21	29.71	30	-0.29
3656	Low	1.71	28	29.71	30	-0.29
3661	Mid	1.88	28	29.88	30	-0.12
3671	High	1.71	28	29.71	30	-0.29

Table 24. PPSD Test Results – (HT5) Combined Ports



Peak Power Spectral Density Test Results

Frequency (MHz)	Channel	Power Spectral Density (dBm)	Antenna Gain (dBi)	Power Spectral Density EIRP (dBm)	Power Spectral Density EIRP (mW)
3656	Low	9.71	17	26.705	468.27
3661	Mid	9.39	17	26.389	435.41
3666	High	9.18	17	26.183	415.24
3656	Low	5.71	21	26.705	468.27
3661	Mid	5.39	21	26.389	435.41
3666	High	5.18	21	26.183	415.24
3656	Low	-1.30	28	26.705	468.27
3661	Mid	-1.61	28	26.389	435.41
3666	High	-1.82	28	26.183	415.24

Table 25. PPSD Test Results – Port 1 (HT10)

Frequency (MHz)	Channel	Power Spectral Density (dBm)	Antenna Gain (dBi)	Power Spectral Density EIRP (dBm)	Power Spectral Density EIRP (mW)
3656	Low	10.03	17	27.03	504.66
3661	Mid	9.48	17	26.481	444.73
3666	High	9.16	17	26.156	412.67
3656	Low	6.03	21	27.03	504.66
3661	Mid	5.48	21	26.481	444.73
3666	High	5.16	21	26.156	412.67
3656	Low	-0.97	28	27.03	504.66
3661	Mid	-1.52	28	26.481	444.73
3666	High	-1.84	28	26.156	412.67

Table 26. PPSD Test Results – Port 2 (HT10)



Peak Power Spectral Density Test Results

Frequency (MHz)	Channel	Antenna Gain (dBi)	Sum of Ports mW	Limit mW	Margin mW	Sum of Ports dBm	Limit dBm	Margin dBm
3656	Low	17	972.94	1000	-27.06	29.88	30	-0.12
3661	Mid	17	880.15	1000	-119.85	29.45	30	-0.55
3666	High	17	827.91	1000	-172.09	29.18	30	-0.82
3656	Low	21	972.94	1000	-27.06	29.88	30	-0.12
3661	Mid	21	880.15	1000	-119.85	29.45	30	-0.55
3666	High	21	827.91	1000	-172.09	29.18	30	-0.82
3656	Low	28	972.94	1000	-27.06	29.88	30	-0.12
3661	Mid	28	880.15	1000	-119.85	29.45	30	-0.55
3666	High	28	827.91	1000	-172.09	29.18	30	-0.82

Table 27. PPSD Test Results – (HT10) Summed

Frequency (MHz)	Channel	Power Spectral Density (dBm)	Antenna Gain (dBi)	Power Spectral Density EIRP (dBm)	Limit dBm	Margin dBm
3656	Low	12.84	17	29.84	30	-0.16
3661	Mid	12.83	17	29.83	30	-0.17
3666	High	12.85	17	29.85	30	-0.15
3656	Low	8.84	21	29.84	30	-0.16
3661	Mid	8.83	21	29.83	30	-0.17
3666	High	8.85	21	29.85	30	-0.15
3656	Low	1.84	28	29.84	30	-0.16
3661	Mid	1.83	28	29.83	30	-0.17
3666	High	1.85	28	29.85	30	-0.15

Table 28. PPSD Test Results – (HT10) Combined Ports



Peak Power Spectral Density Test Results

Frequency (MHz)	Channel	Power Spectral Density (dBm)	Antenna Gain (dBi)	Power Spectral Density EIRP (dBm)	Power Spectral Density EIRP (mW)
3661	Mid	9.80	17	26.799	478.52
3661	Mid	5.80	21	26.799	478.52
3661	Mid	-1.20	28	26.799	478.52

Table 29. PPSD Test Results – Port 1 (HT20)

Frequency (MHz)	Channel	Power Spectral Density (dBm)	Antenna Gain (dBi)	Power Spectral Density EIRP (dBm)	Power Spectral Density EIRP (mW)
3661	Mid	10.04	17	27.04	505.82
3661	Mid	6.04	21	27.04	505.82
3661	Mid	-0.96	28	27.04	505.82

Table 30. PPSD Test Results – Port 2 (HT20)

Frequency (MHz)	Channel	Antenna Gain (dBi)	Sum of Ports mW	Limit mW	Margin mW	Sum of Ports dBm	Limit dBm	Margin dBm
3661	Mid	17	984.34	1000	-15.66	29.93	30	-0.07
3661	Mid	21	984.34	1000	-15.66	29.93	30	-0.07
3661	Mid	28	984.34	1000	-15.66	29.93	30	-0.07

Table 31. PPSD Test Results – (HT20) Summed

Frequency (MHz)	Channel	Power Spectral Density (dBm)	Antenna Gain (dBi)	Power Spectral Density EIRP (dBm)	Limit dBm	Margin dBm
3661	Mid	12.87	17	29.87	30	-0.13
3661	Mid	8.87	21	29.87	30	-0.13
3661	Mid	1.87	28	29.87	30	-0.13

Table 32. PPSD Test Results – (HT20) Combined Ports



Peak Power Spectral Density Test Results

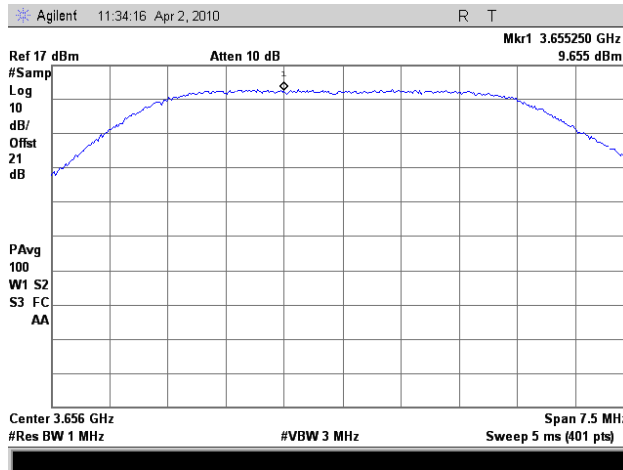

Plot 17. PPSD 5 MHz Low Ch (Port 1)

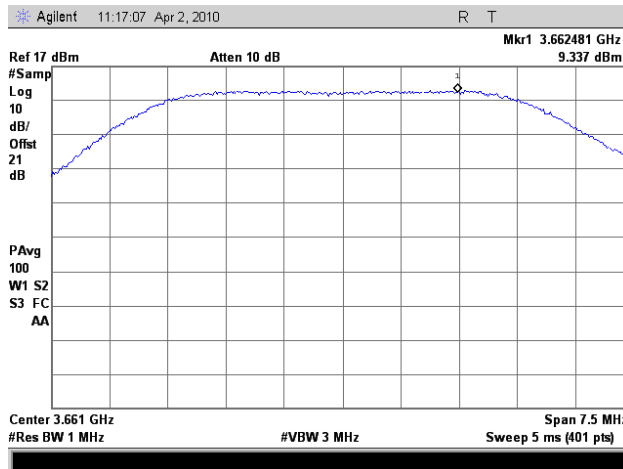

Plot 18. PPSD 5 MHz Mid Ch (Port 1)

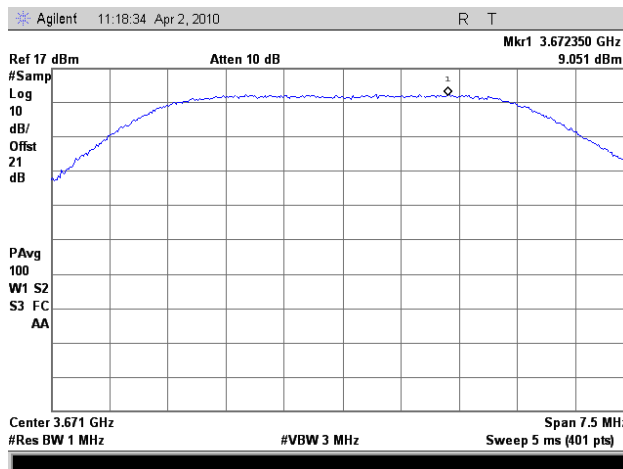

Plot 19. PPSD 5 MHz High Ch (Port 1)



Peak Power Spectral Density Test Results

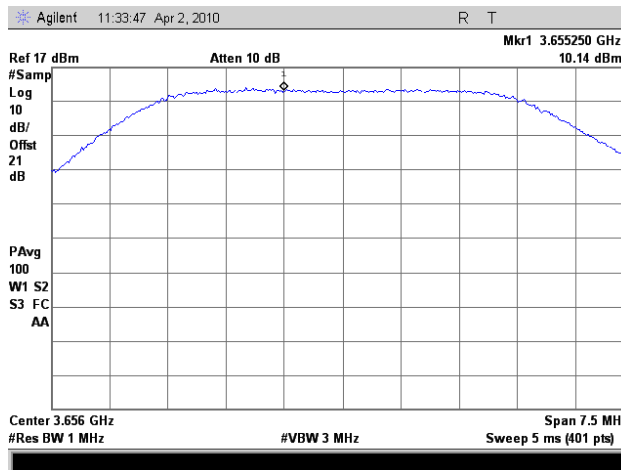

Plot 20. PPSD 5 MHz Low Ch (Port 2)

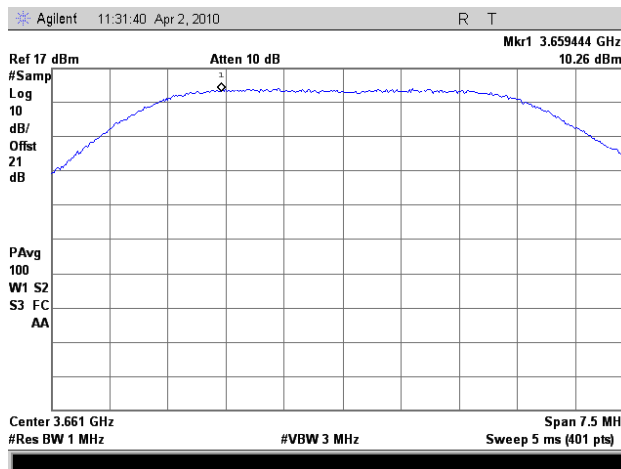

Plot 21. PPSD 5 MHz Mid Ch (Port 2)

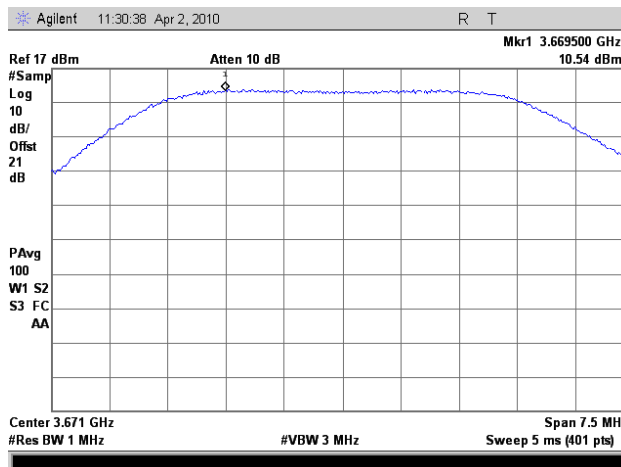

Plot 22. PPSD 5 MHz High Ch (Port 2)



Peak Power Spectral Density Test Results

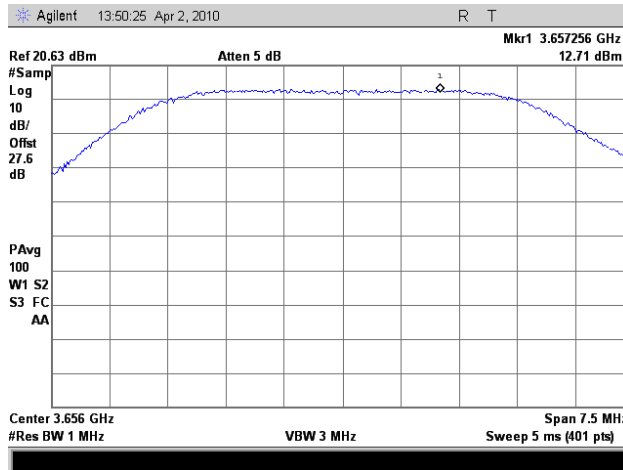

Plot 23. PPSD 5 MHz Low Ch (Combined Ports)

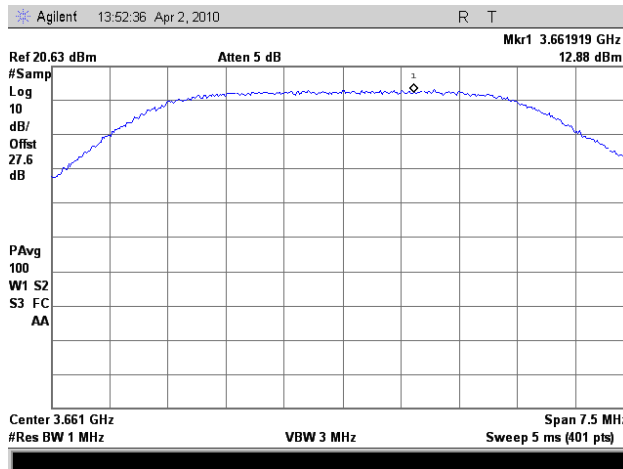

Plot 24. PPSD 5 MHz Mid Ch (Combined Ports)

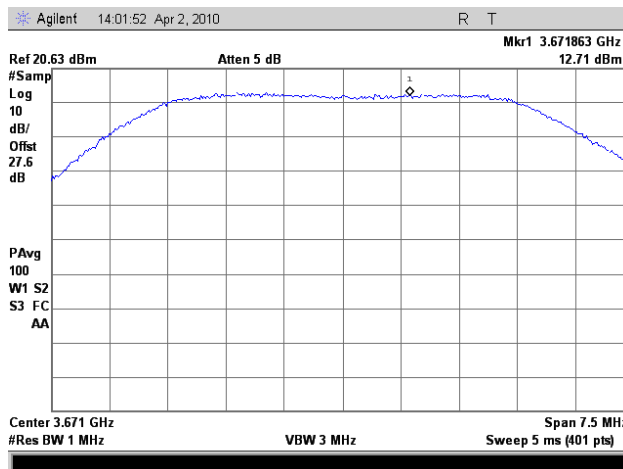

Plot 25. PPSD 5 MHz High Ch (Combined Ports)



Peak Power Spectral Density Test Results

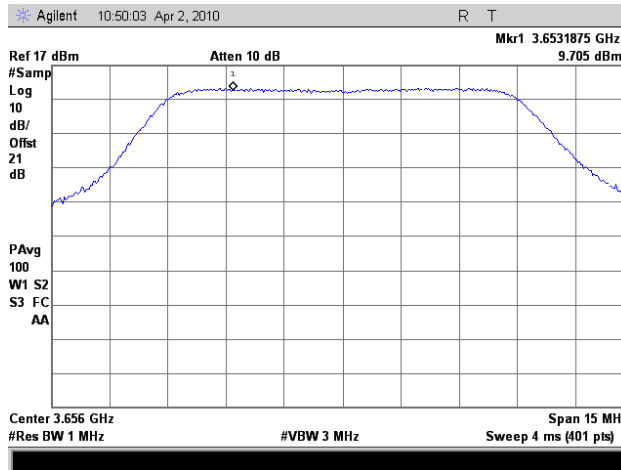

Plot 26. PPSD 10 MHz Low Ch (Port 1)

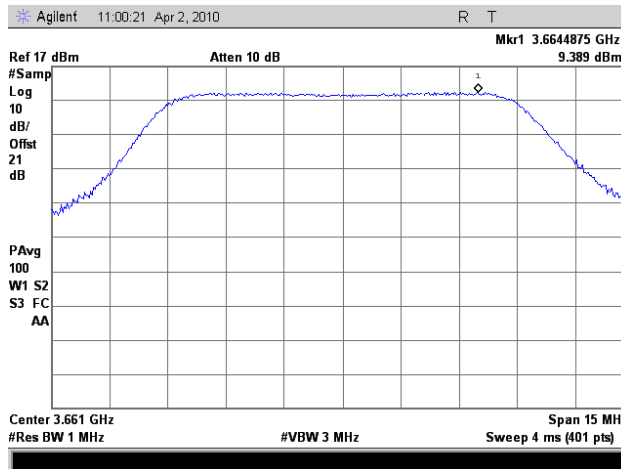

Plot 27. PPSD 10 MHz Mid Ch (Port 1)

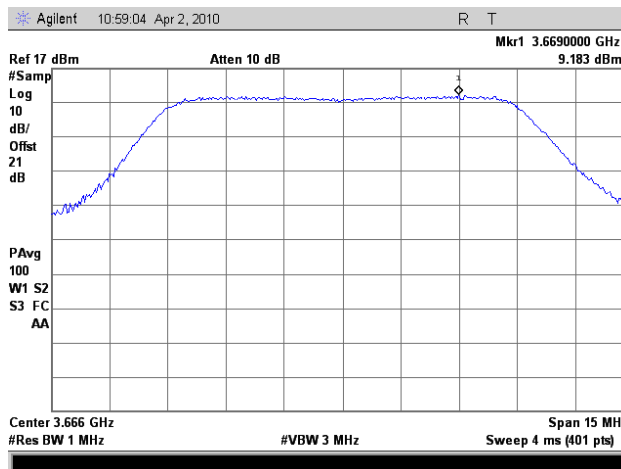

Plot 28. PPSD 10 MHz High Ch (Port 1)



Peak Power Spectral Density Test Results

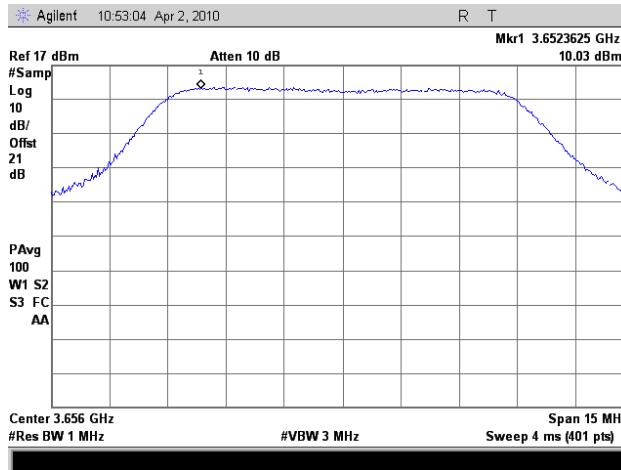

Plot 29. PPSD 10 MHz Low Ch (Port 2)

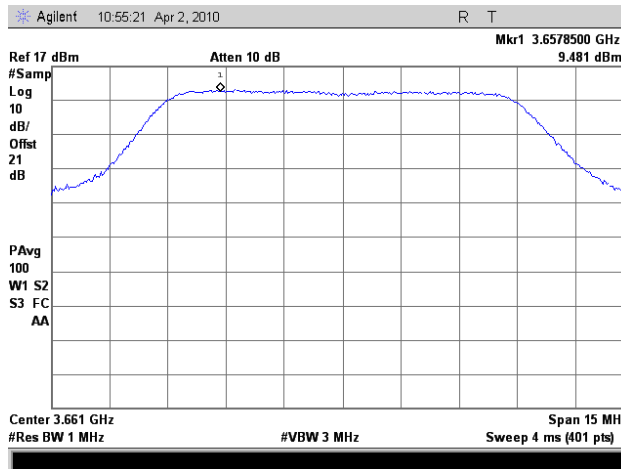

Plot 30. PPSD 10 MHz Mid Ch (Port 2)

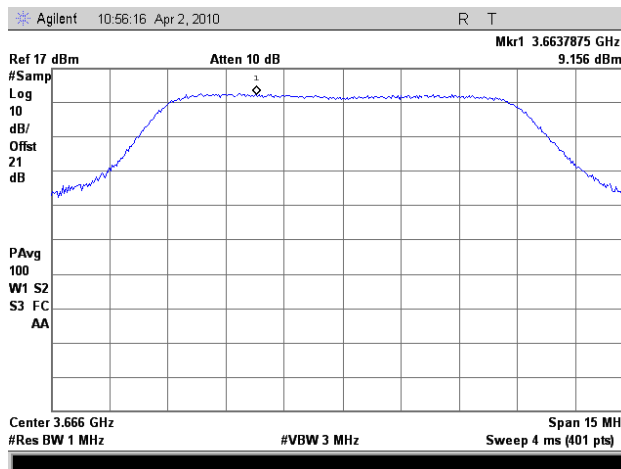

Plot 31. PPSD 10 MHz High Ch (Port 2)



Peak Power Spectral Density Test Results

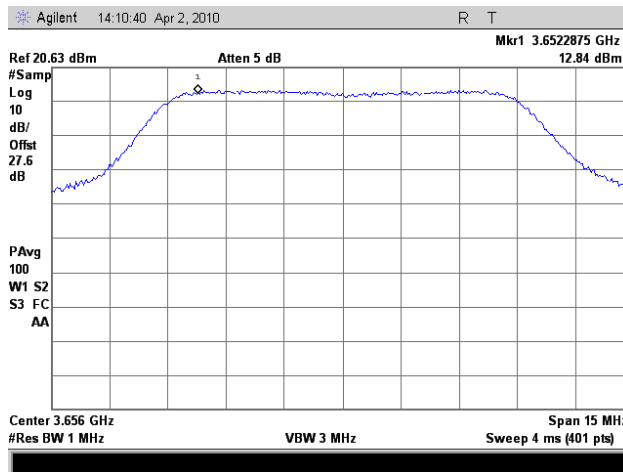

Plot 32. PPSD 10 MHz Low Ch (Combined Ports)

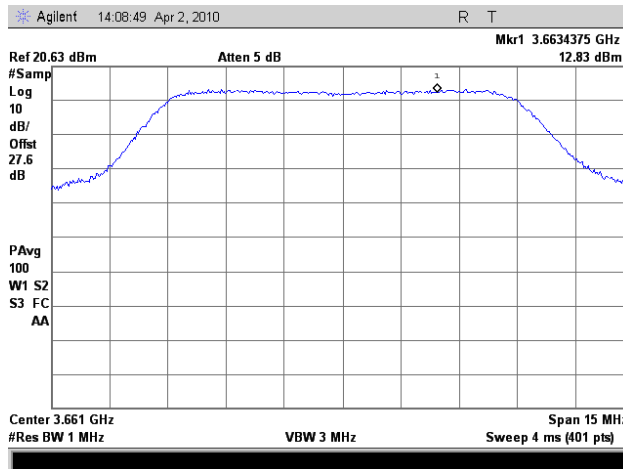

Plot 33. PPSD 10 MHz Mid Ch (Combined Ports)

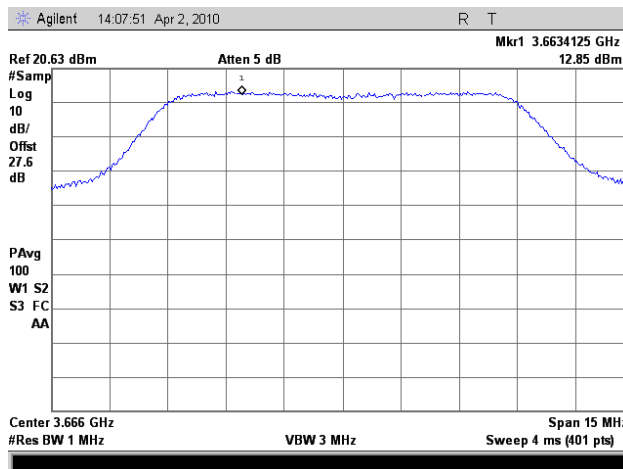

Plot 34. PPSD 10 MHz High Ch (Combined Ports)



Peak Power Spectral Density Test Results

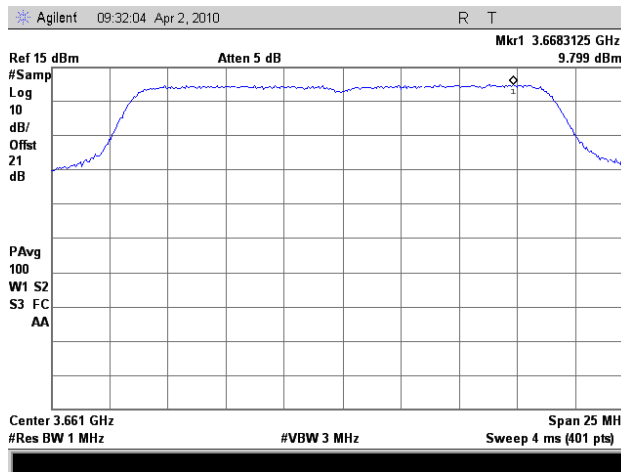

Plot 35. PPSD 20 MHz Mid Ch (Port 1)

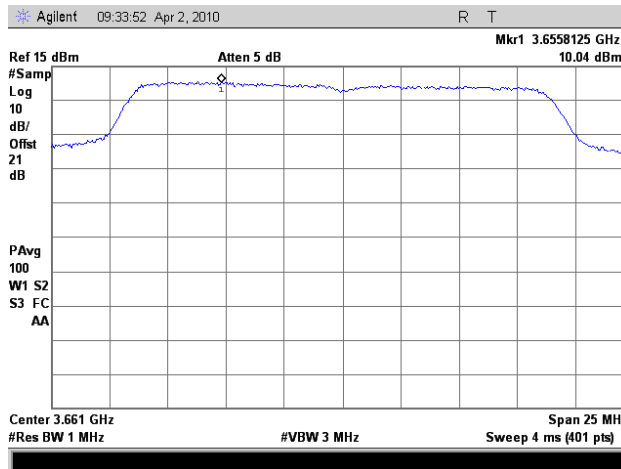

Plot 36. PPSD 20 MHz Mid Ch (Port 2)

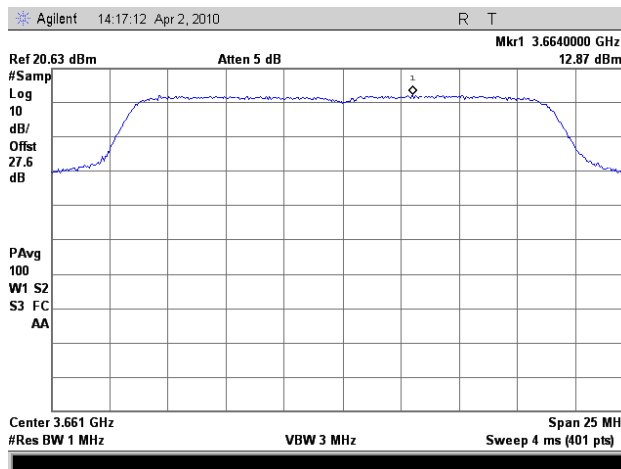

Plot 37. PPSD 20 MHz Mid Ch (Combined Ports)

5. Electromagnetic Compatibility Occupied Bandwidth Requirements

5.1. Occupied Bandwidth

Test Requirement(s): §2.1049

Test Procedures: As required by 47 CFR 2.1049, *occupied bandwidth measurements* were made at the RF output terminals using a Directional Coupler through a Spectrum Analyzer and Power Meter monitoring the power output level.

A laptop was connected to EUT to control the RF power output and frequency channel. The EUT was connected to a Spectrum Analyzer and a Power Meter to monitor the output power level. The measured highest Average Power was set relative to zero dB reference. The RBW of the Spectrum Analyzer was set to at least 1% of the channel bandwidth. The EUT power was adjusted at the maximum output power level. Measurements were carried out at the low, mid and high channels of the TX band.

Test Results: Equipment complies with Section 2.1049

The following pages show measurements of occupied band width.

Test Engineer(s): Anderson Soungpanya

Test Date(s): 04/02/10

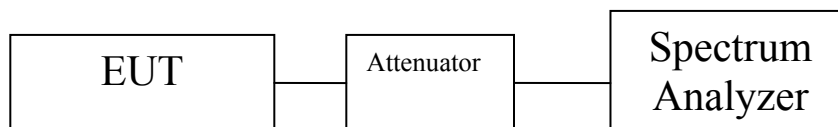
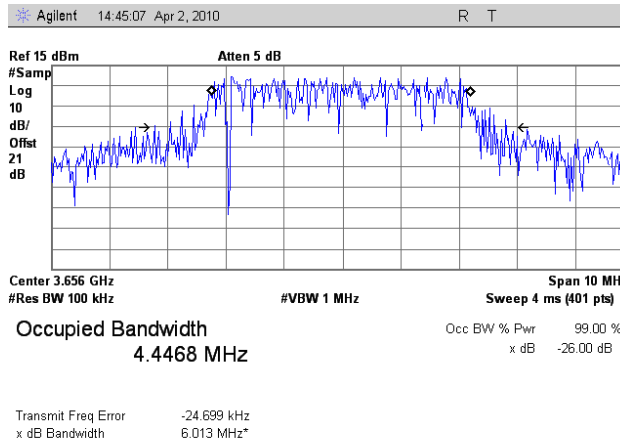

Figure 4. Occupied Bandwidth Test Setup



Occupied Bandwidth Test Results



Plot 38. Occupied Bandwidth Low Channel (HT5) – Port 1

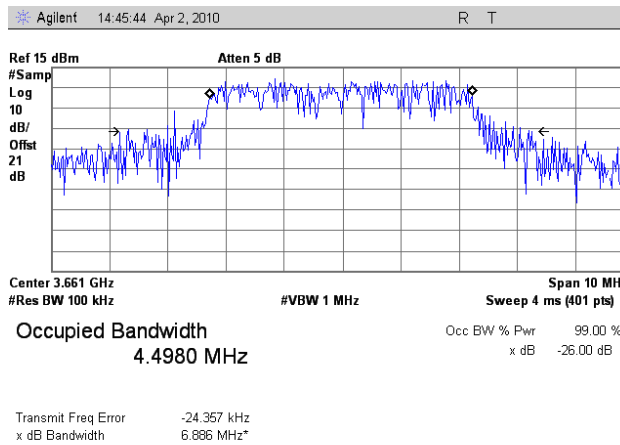

Plot 39. Occupied Bandwidth Mid Channel (HT5) – Port 1

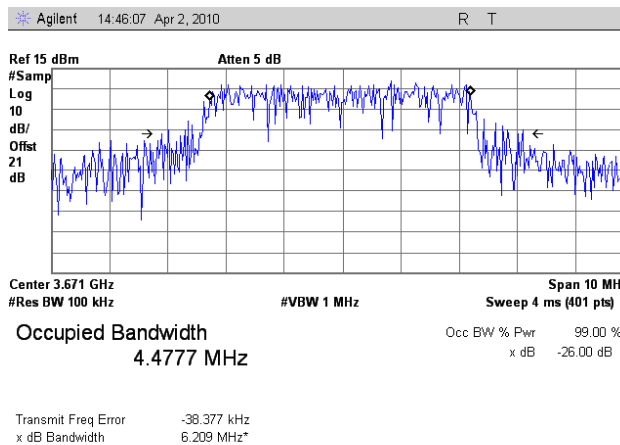

Plot 40. Occupied Bandwidth High Channel (HT5) – Port 1



Occupied Bandwidth Test Results

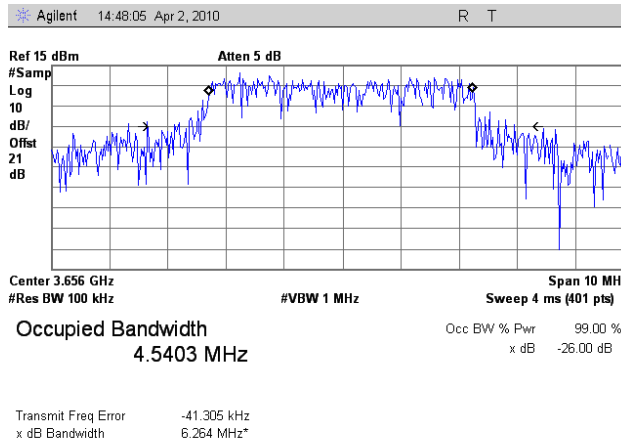

Plot 41. Occupied Bandwidth Low Channel (HT5) – Port 2

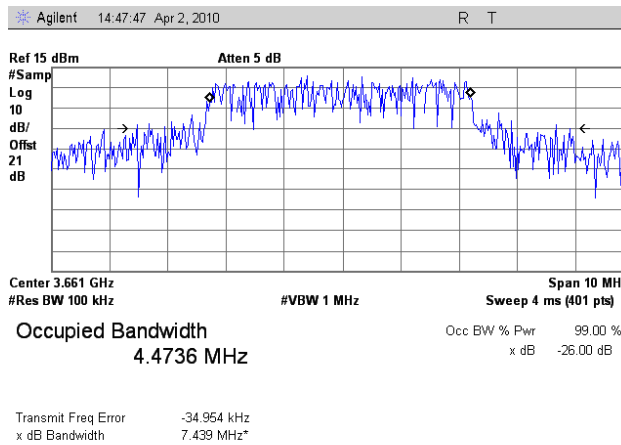

Plot 42. Occupied Bandwidth Mid Channel (HT5) – Port 2

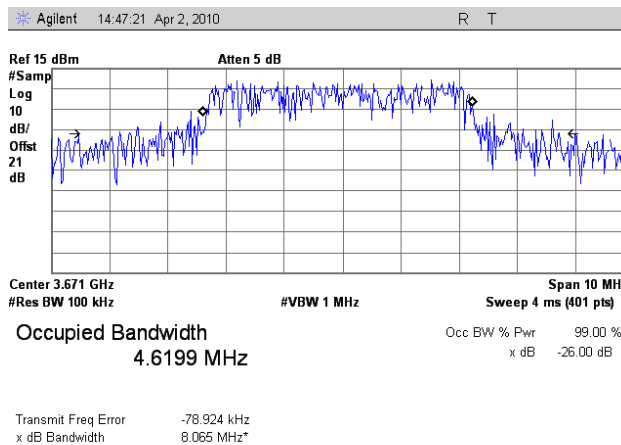

Plot 43. Occupied Bandwidth High Channel (HT5) – Port 2



Occupied Bandwidth Test Results

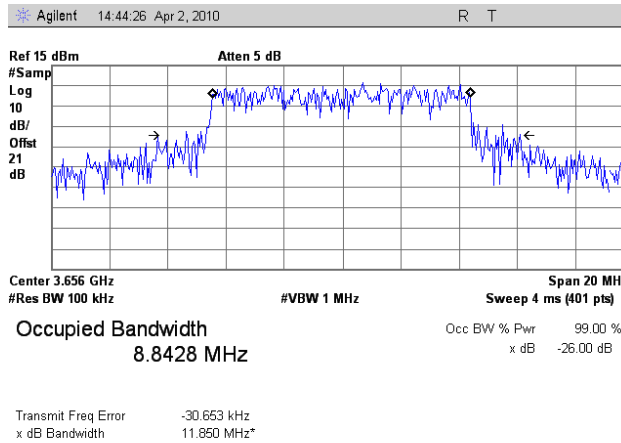

Plot 44. Occupied Bandwidth Low Channel (HT10) – Port 1

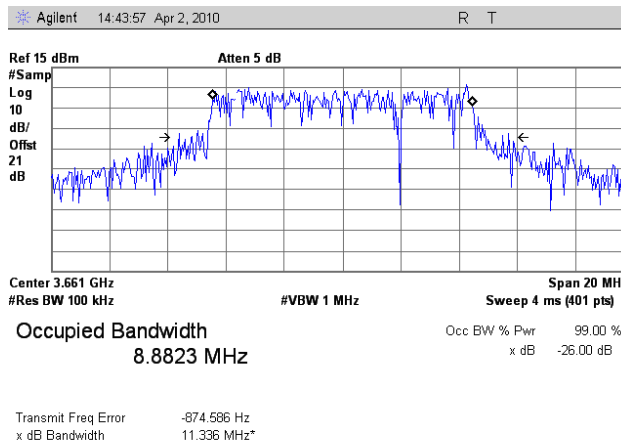

Plot 45. Occupied Bandwidth Mid Channel (HT10) – Port 1

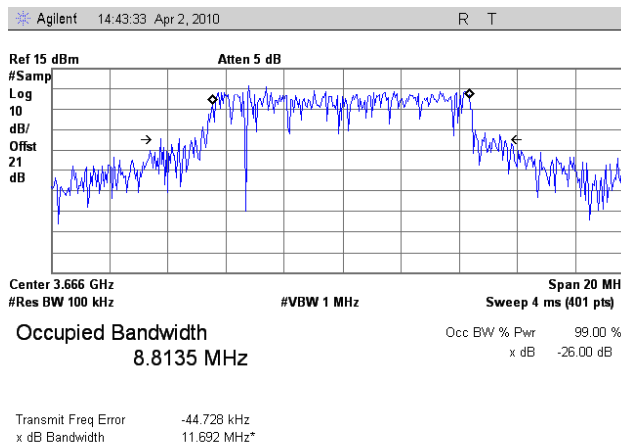

Plot 46. Occupied Bandwidth High Channel (HT10) – Port 1



Occupied Bandwidth Test Results

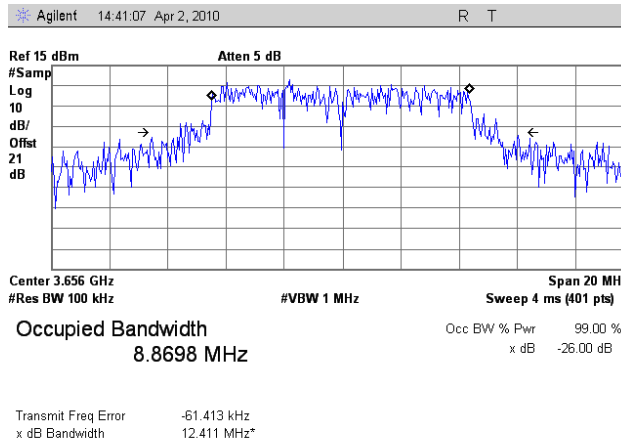

Plot 47. Occupied Bandwidth Low Channel (HT10) – Port 2

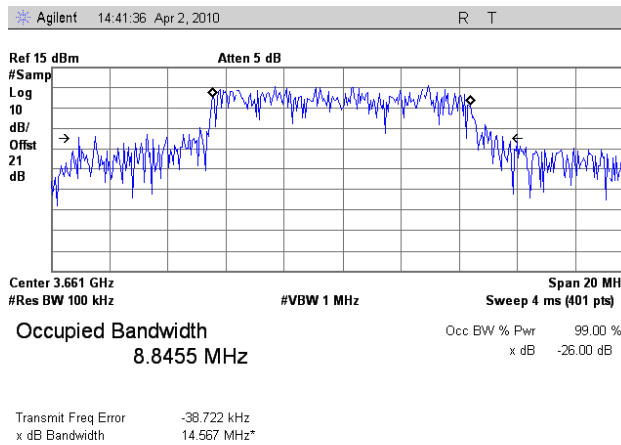

Plot 48. Occupied Bandwidth Mid Channel (HT10) – Port 2

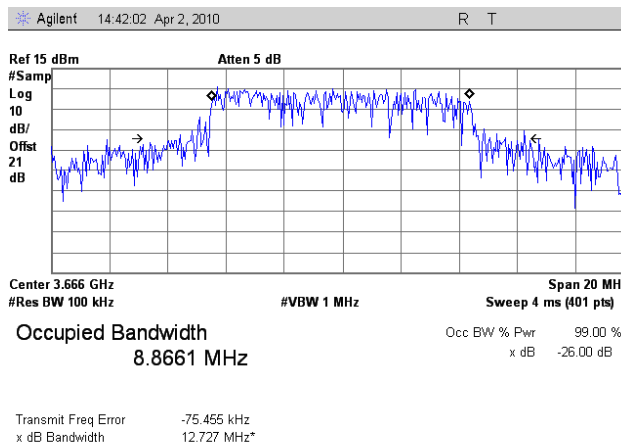

Plot 49. Occupied Bandwidth High Channel (HT10) – Port 2



Occupied Bandwidth Test Results

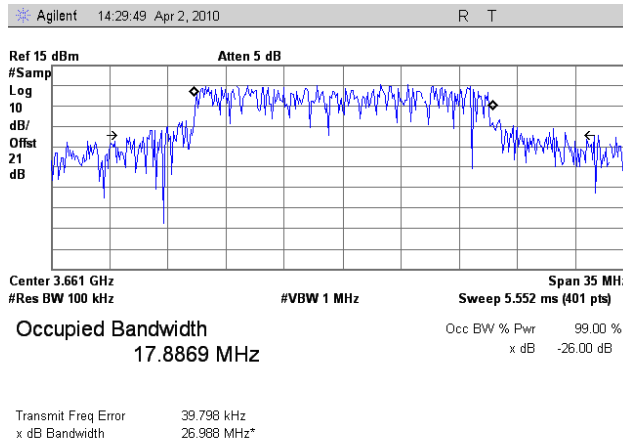

Plot 50. Occupied Bandwidth Mid Channel (HT20) – Port 1

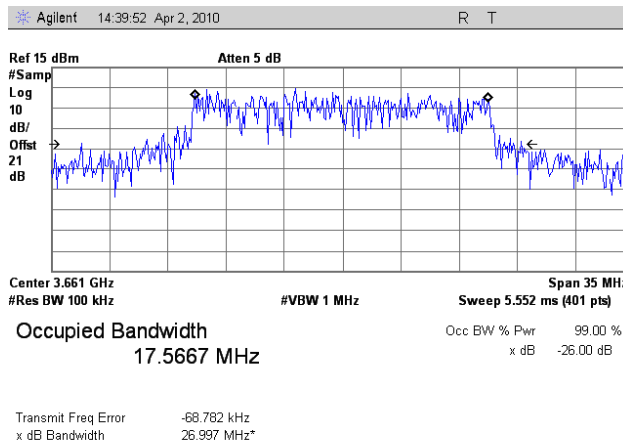

Plot 51. Occupied Bandwidth Mid Channel (HT20) – Port 2

6. Electromagnetic Compatibility Spurious Emissions at Antenna Terminal Requirements

6.1. Spurious Emissions at Antenna Terminals

Test Requirement(s): §2.1051 and §90.1323(a)

Test Procedures: As required by 47 CFR 2.1051, *spurious emissions at antenna terminal measurements* were made at the RF output terminals using a Directional Coupler through a Spectrum Analyzer and Power Meter.

A laptop was connected to EUT to control the RF power output and frequency channel. The EUT was connected to a Spectrum Analyzer through a broad band attenuator. The Spectrum Analyzer was set to sweep 30 MHz and up to 10th harmonic of the fundamental or 40GHz which ever is the lesser. The Spectrum Analyzer was set to a RBW = 1 MHz and a VBW > 1MHz. Measurements were made at the low, mid and high channels. Measurement were also carried out at the band edges of the band of operation.

Limits: The power of any emission outside the licensee's frequency band of operation shall be attenuated below the transmitters power (P) by at least $43 + 10\log(P)$ dB.

Test Results: Equipment complies with Section 2.1051 and 90.1323(a).

Test Engineer(s): Anderson Soungpanya

Test Date(s): 04/05/10

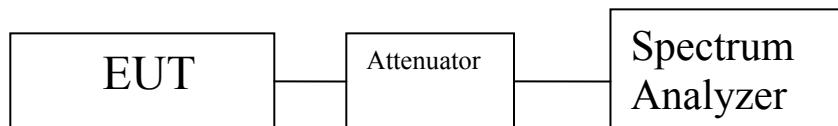
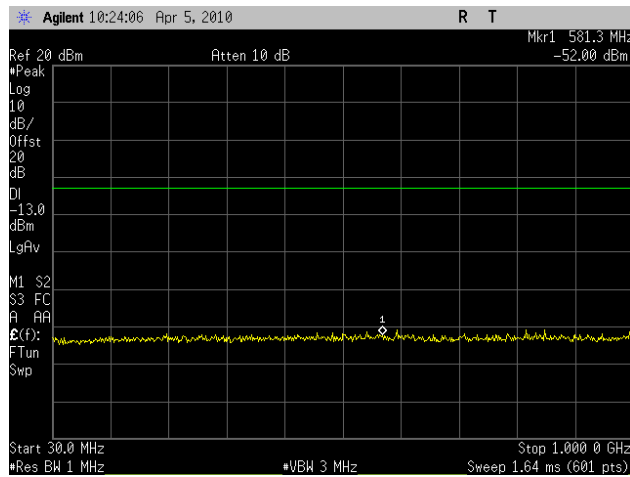

Figure 5. Spurious Emissions at Antenna Terminals Test Setup



Conducted Spurious Emissions Test Results



Plot 52. Conducted Spurious Emissions Low Ch, 30 MHz - 1GHz, (HT5) – Port 1

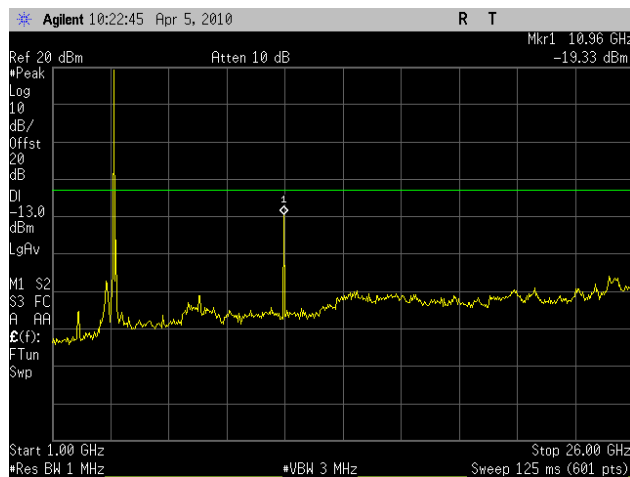

Plot 53. Conducted Spurious Emissions Low Ch, 1 GHz – 26GHz, (HT5) – Port 1

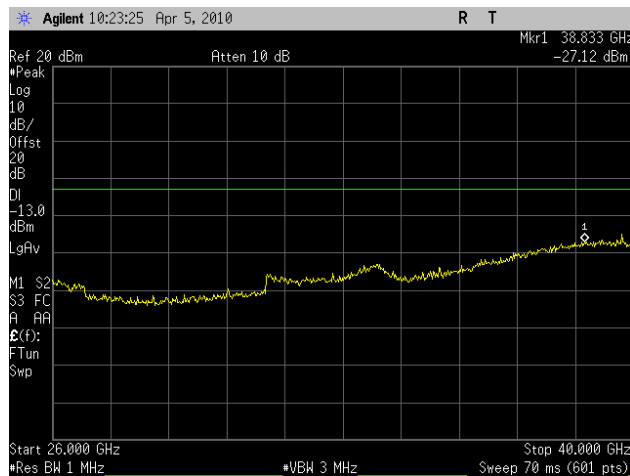

Plot 54. Conducted Spurious Emissions Low Ch, 26GHz – 40GHz, (HT5) – Port 1

Conducted Spurious Emissions Test Results

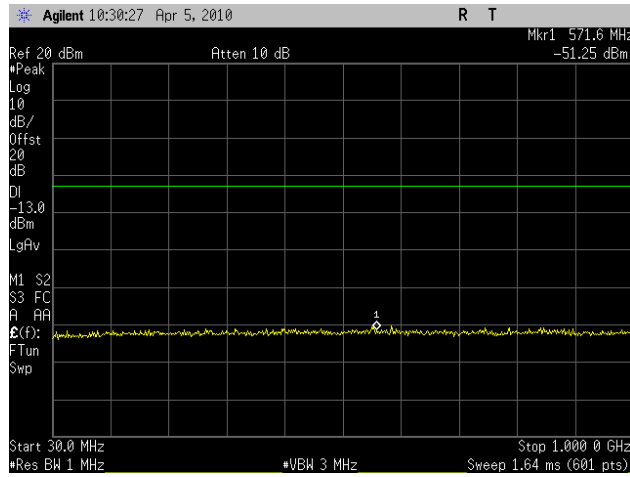

Plot 55. Conducted Spurious Emissions Mid Ch, 30 MHz - 1GHz, (HT5) – Port 1

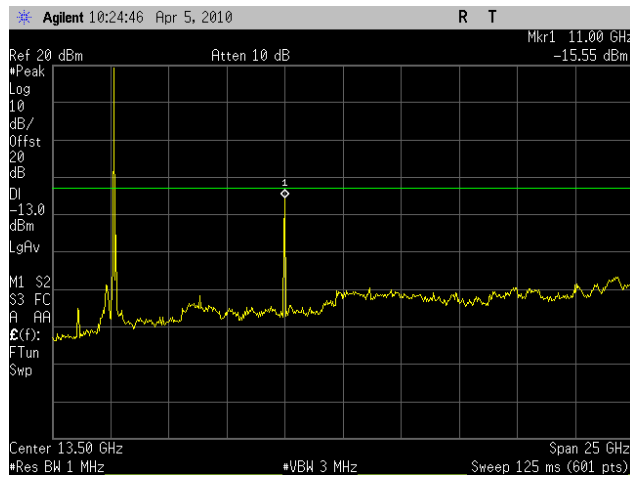

Plot 56. Conducted Spurious Emissions Mid Ch, 1 GHz – 26GHz, (HT5) – Port 1

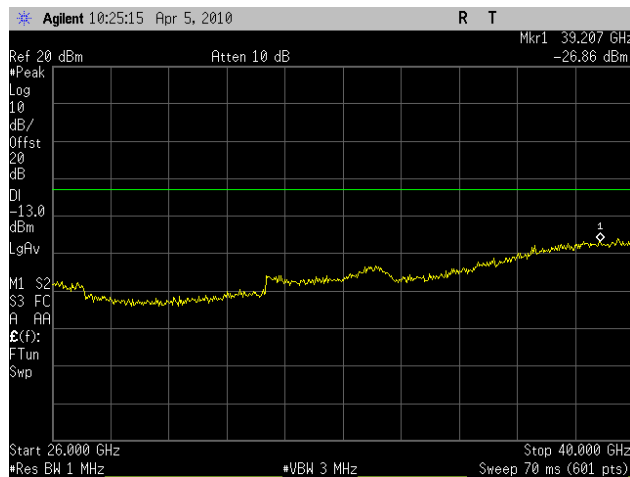

Plot 57. Conducted Spurious Emissions Mid Ch, 26GHz – 40GHz, (HT5) – Port 1

Conducted Spurious Emissions Test Results

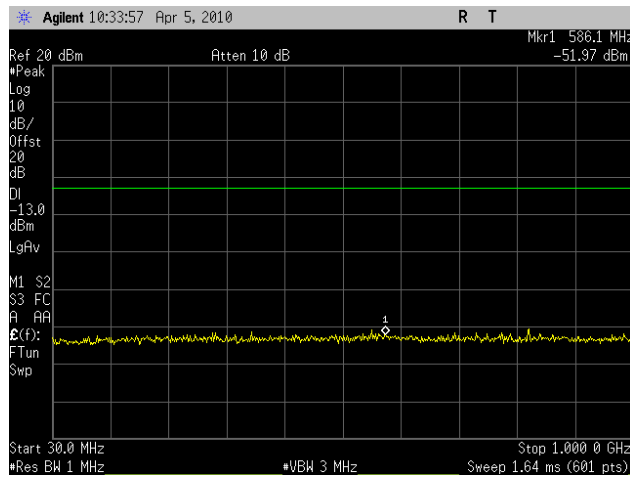

Plot 58. Conducted Spurious Emissions High Ch, 30 MHz - 1GHz, (HT5) – Port 1

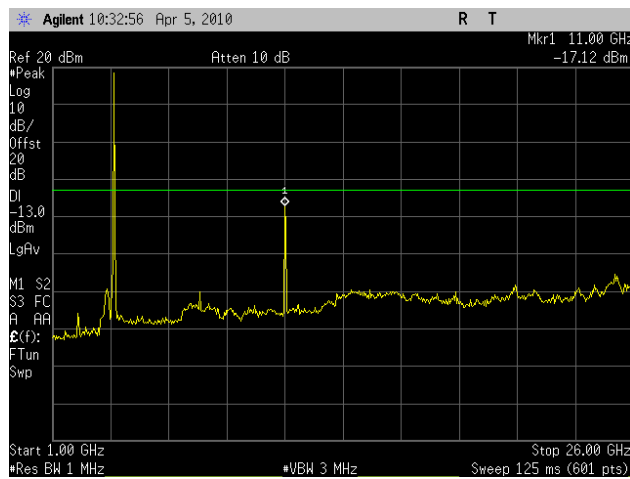

Plot 59. Conducted Spurious Emissions High Ch, 1 GHz – 26GHz, (HT5) – Port 1

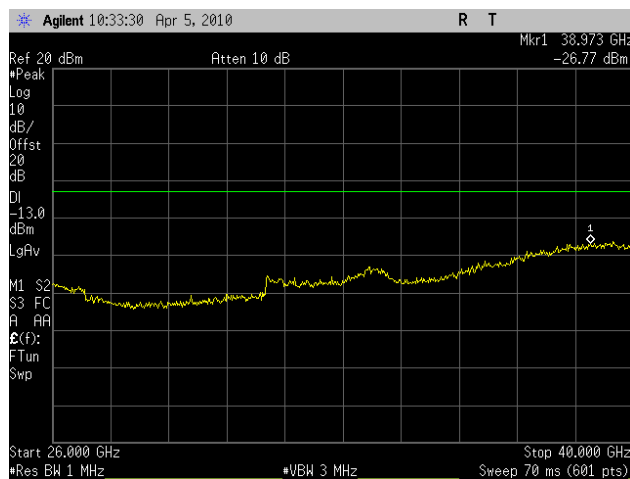

Plot 60. Conducted Spurious Emissions High Ch, 26GHz – 40GHz, (HT5) – Port 1



Conducted Spurious Emissions Test Results

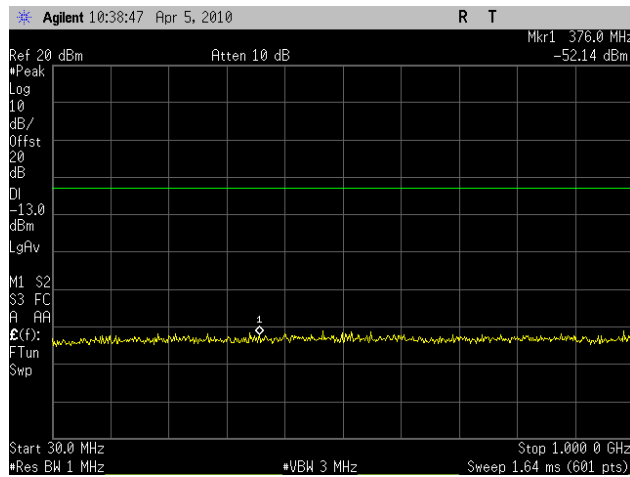

Plot 61. Conducted Spurious Emissions Low Ch, 30 MHz - 1GHz, (HT5) – Port 2

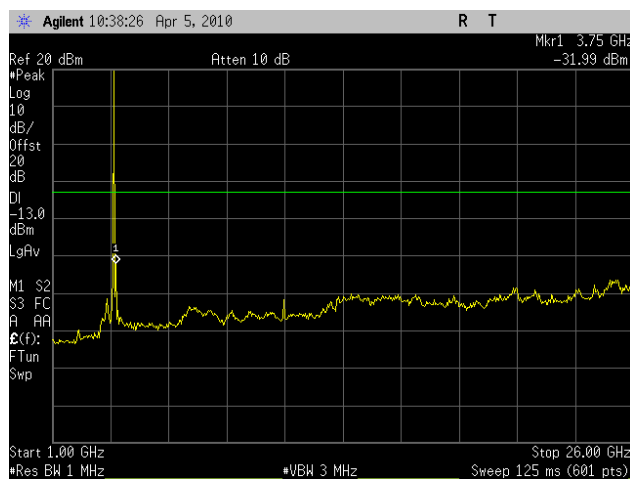

Plot 62. Conducted Spurious Emissions Low Ch, 1 GHz – 26GHz, (HT5) – Port 2

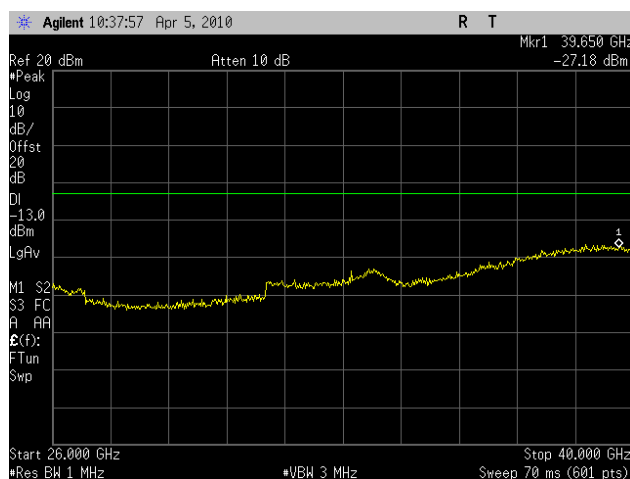

Plot 63. Conducted Spurious Emissions Low Ch, 26GHz – 40GHz, (HT5) – Port 2

Conducted Spurious Emissions Test Results

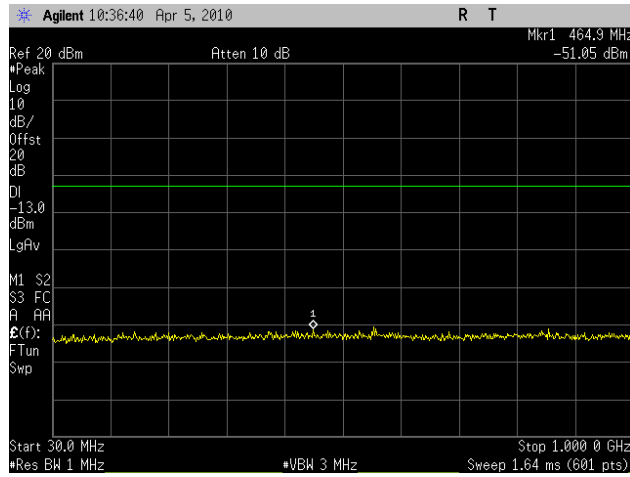

Plot 64. Conducted Spurious Emissions Mid Ch, 30 MHz - 1GHz, (HT5) – Port 2

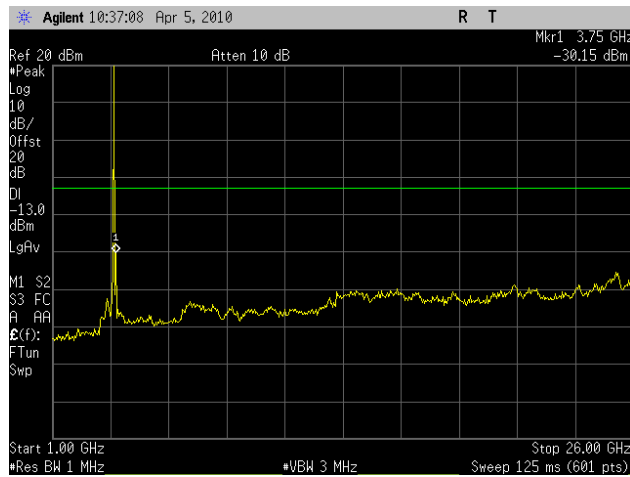

Plot 65. Conducted Spurious Emissions Mid Ch, 1 GHz – 26GHz, (HT5) – Port 2

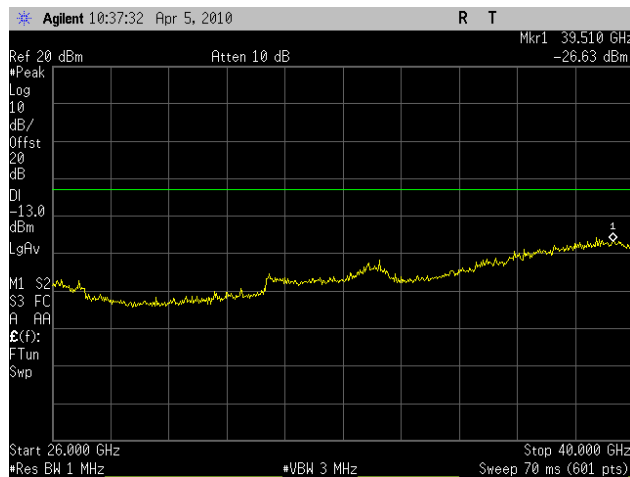

Plot 66. Conducted Spurious Emissions Mid Ch, 26GHz – 40GHz, (HT5) – Port 2



Conducted Spurious Emissions Test Results

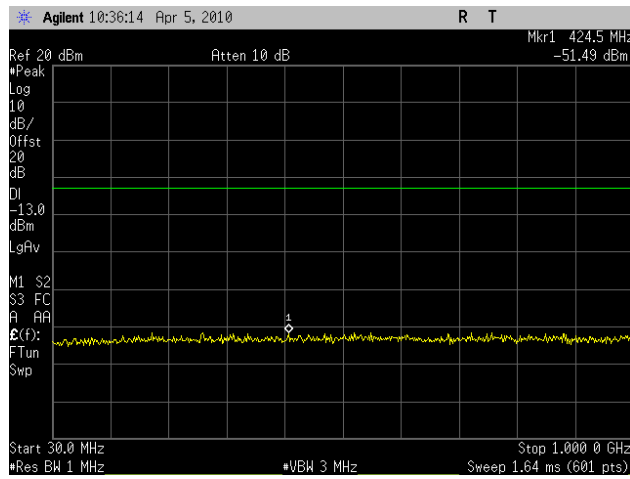

Plot 67. Conducted Spurious Emissions High Ch, 30 MHz - 1GHz, (HT5) – Port 2

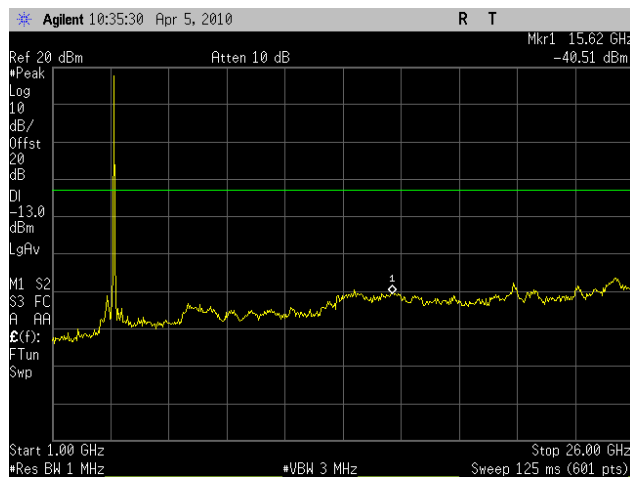

Plot 68. Conducted Spurious Emissions High Ch, 1 GHz – 26GHz, (HT5) – Port 2



Plot 69. Conducted Spurious Emissions High Ch, 26GHz – 40GHz, (HT5) – Port 2

Conducted Spurious Emissions Test Results

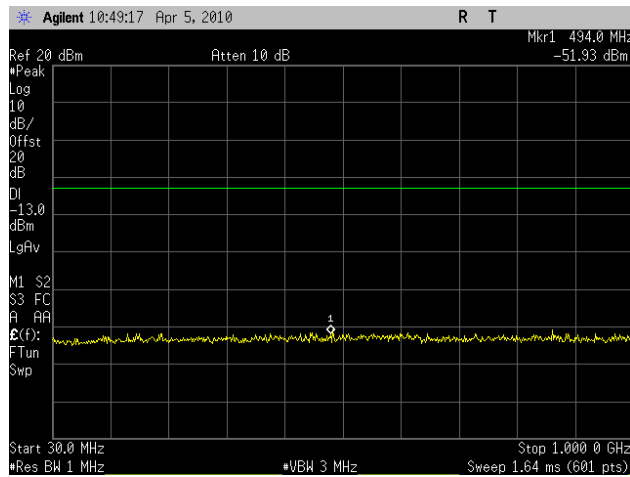

Plot 70. Conducted Spurious Emissions Low Ch, 30 MHz - 1GHz, (HT10) – Port 1

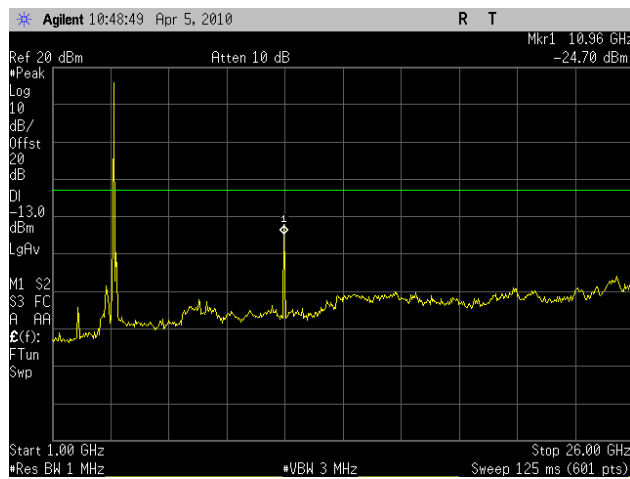

Plot 71. Conducted Spurious Emissions Low Ch, 1 GHz – 26GHz, (HT10) – Port 1

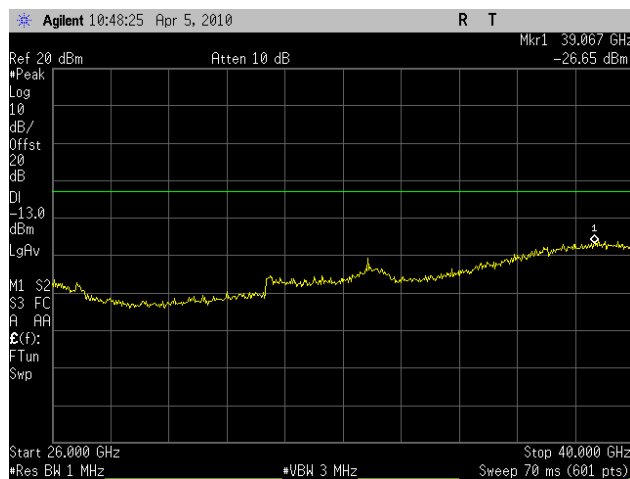

Plot 72. Conducted Spurious Emissions Low Ch, 26GHz – 40GHz, (HT10) – Port 1

Conducted Spurious Emissions Test Results

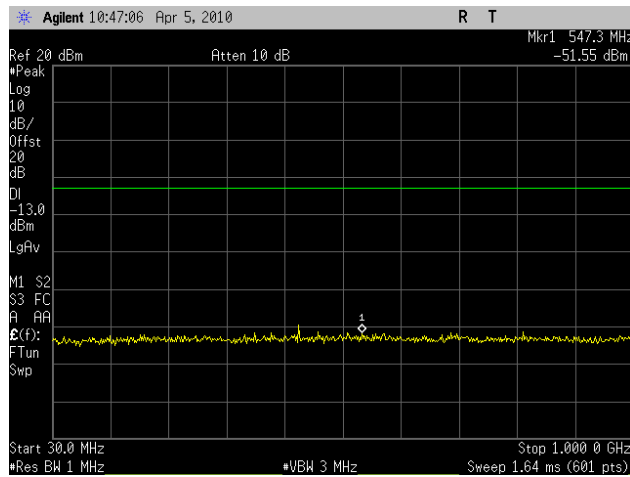

Plot 73. Conducted Spurious Emissions Mid Ch, 30 MHz - 1GHz, (HT10) – Port 1

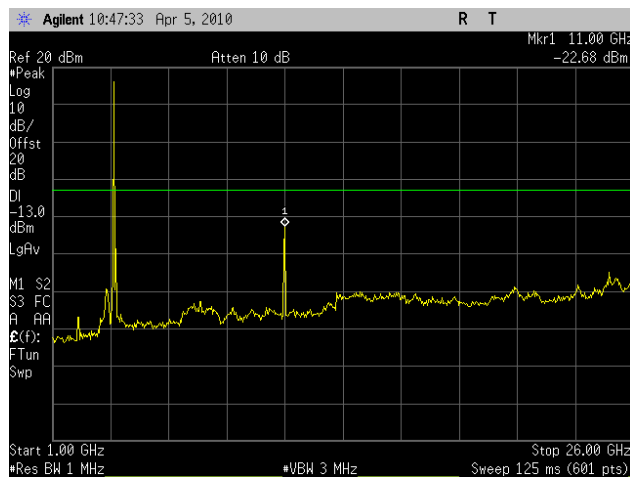

Plot 74. Conducted Spurious Emissions Mid Ch, 1 GHz – 26GHz, (HT10) – Port 1

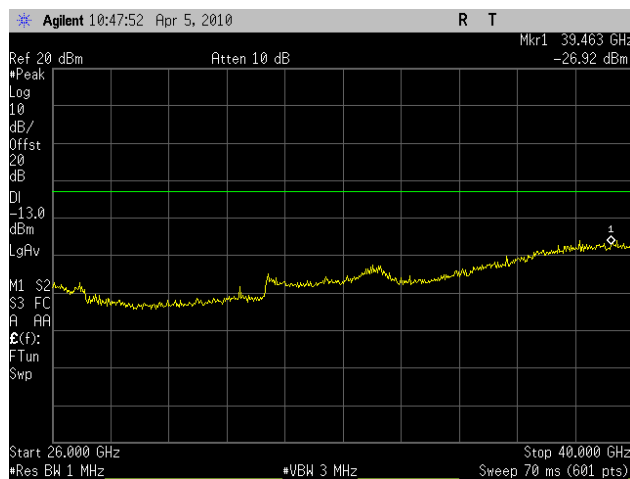

Plot 75. Conducted Spurious Emissions Mid Ch, 26GHz – 40GHz, (HT10) – Port 1



Conducted Spurious Emissions Test Results

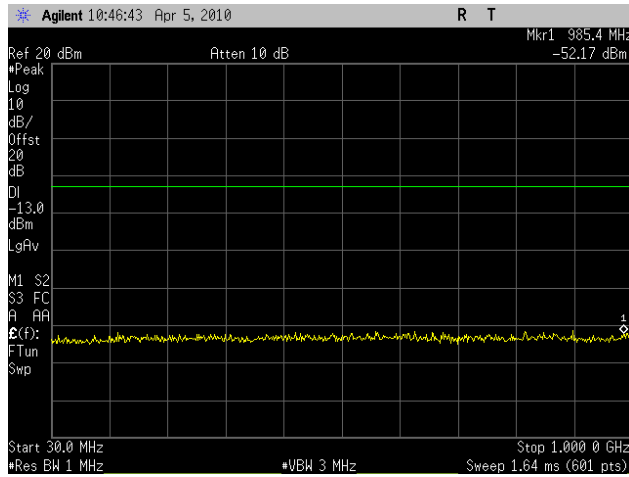

Plot 76. Conducted Spurious Emissions High Ch, 30 MHz - 1GHz, (HT10) – Port 1

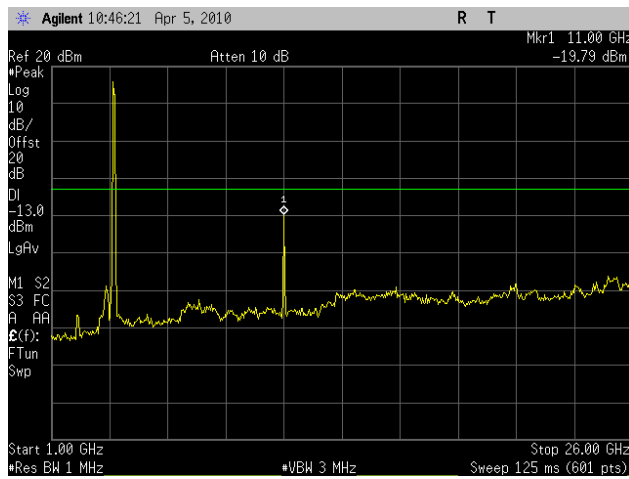

Plot 77. Conducted Spurious Emissions High Ch, 1 GHz – 26GHz, (HT10) – Port 1

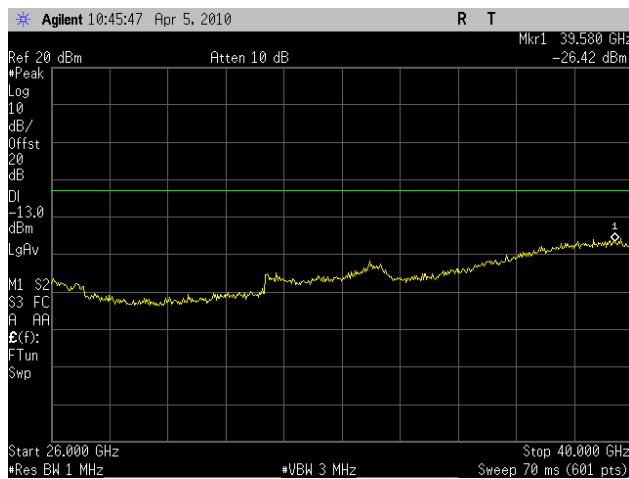

Plot 78. Conducted Spurious Emissions High Ch, 26GHz – 40GHz, (HT10) – Port 1



Conducted Spurious Emissions Test Results

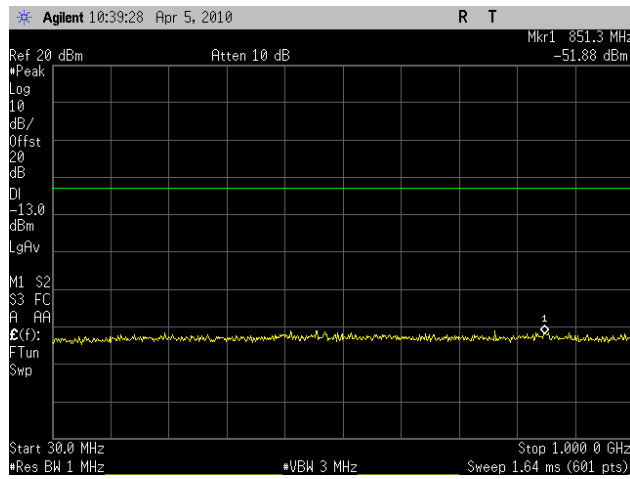

Plot 79. Conducted Spurious Emissions Low Ch, 30 MHz - 1GHz, (HT10) – Port 2

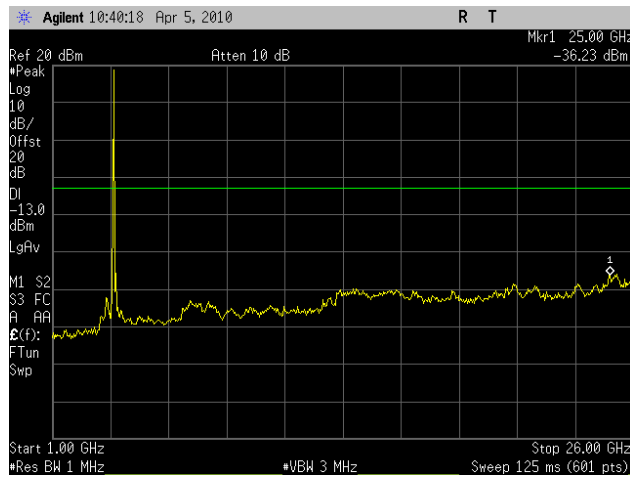

Plot 80. Conducted Spurious Emissions Low Ch, 1 GHz - 26GHz, (HT10) – Port 2

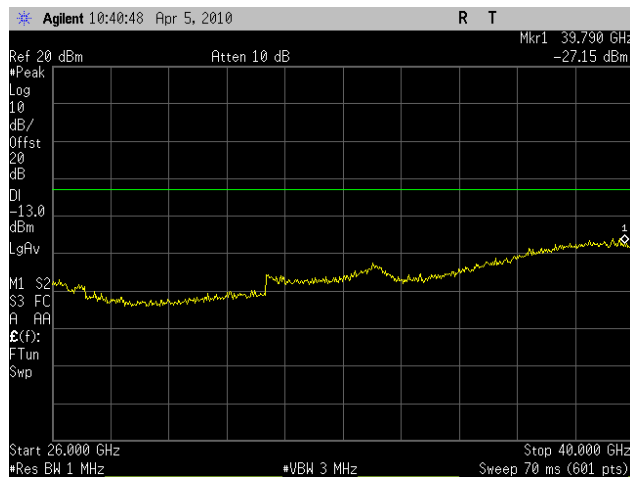

Plot 81. Conducted Spurious Emissions Low Ch, 26GHz - 40GHz, (HT10) – Port 2



Conducted Spurious Emissions Test Results

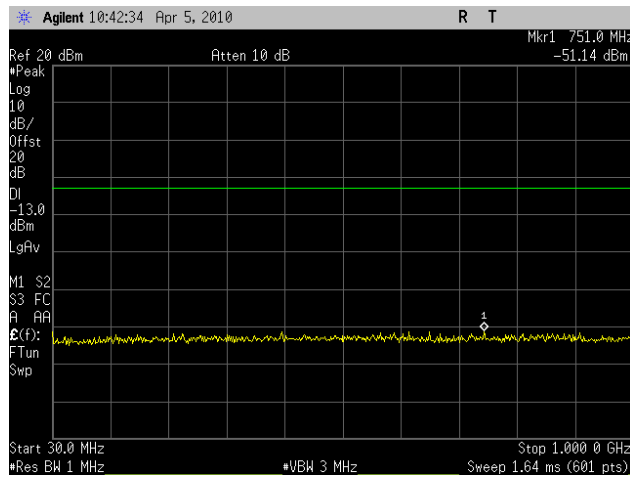

Plot 82. Conducted Spurious Emissions Mid Ch, 30 MHz - 1GHz, (HT10) – Port 2

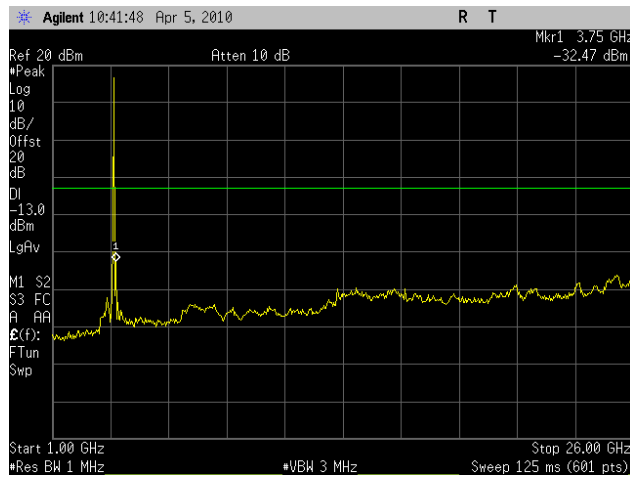

Plot 83. Conducted Spurious Emissions Mid Ch, 1 GHz - 26GHz, (HT10) – Port 2

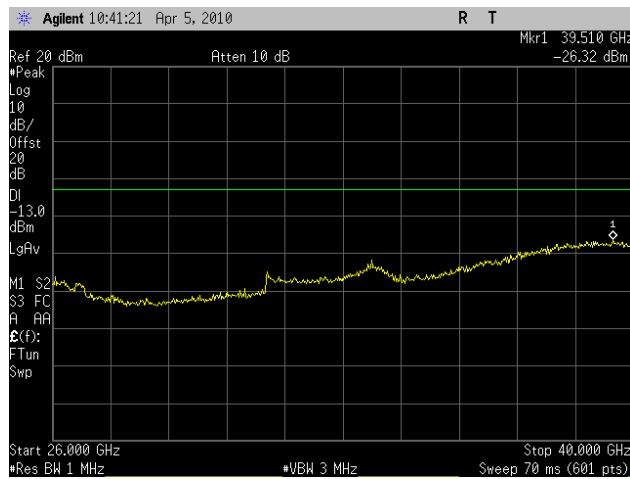

Plot 84. Conducted Spurious Emissions Mid Ch, 26GHz - 40GHz, (HT10) – Port 2



Conducted Spurious Emissions Test Results

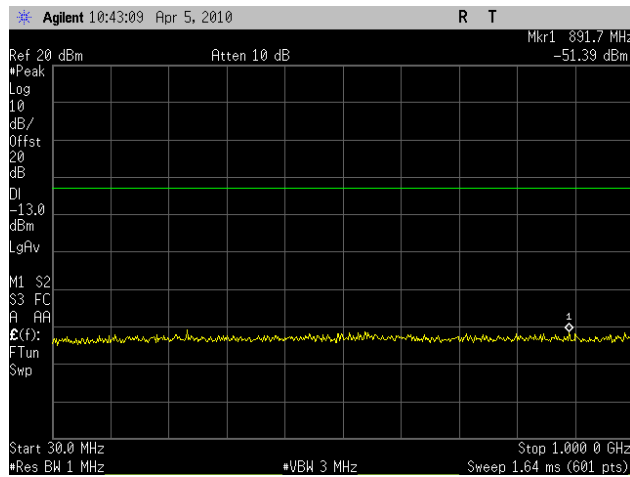

Plot 85. Conducted Spurious Emissions High Ch, 30 MHz - 1GHz, (HT10) – Port 2

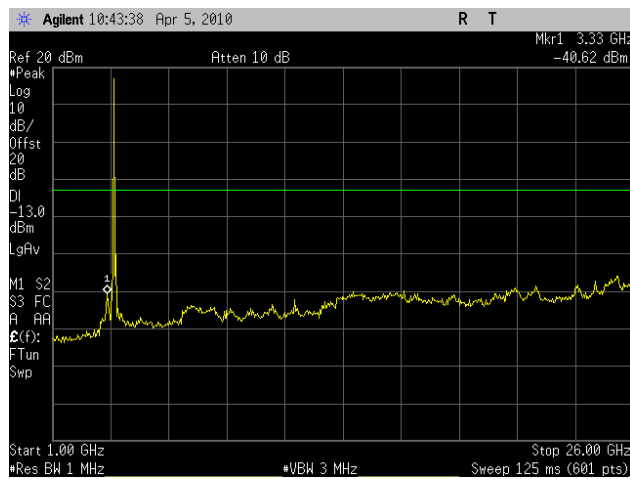

Plot 86. Conducted Spurious Emissions High Ch, 1 GHz – 26GHz, (HT10) – Port 2

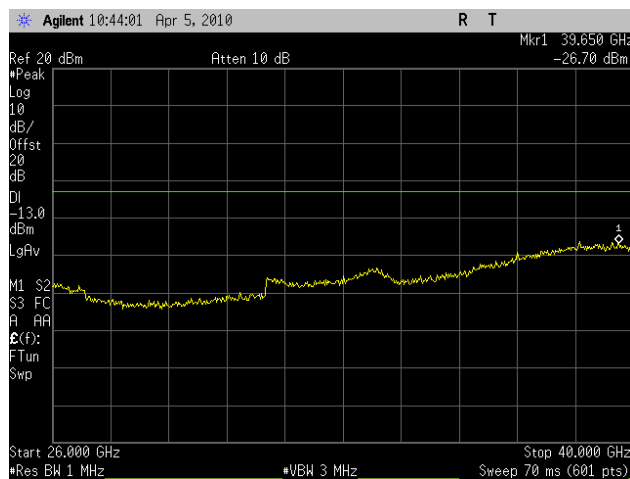

Plot 87. Conducted Spurious Emissions High Ch, 26GHz – 40GHz, (HT10) – Port 2



Conducted Spurious Emissions Test Results

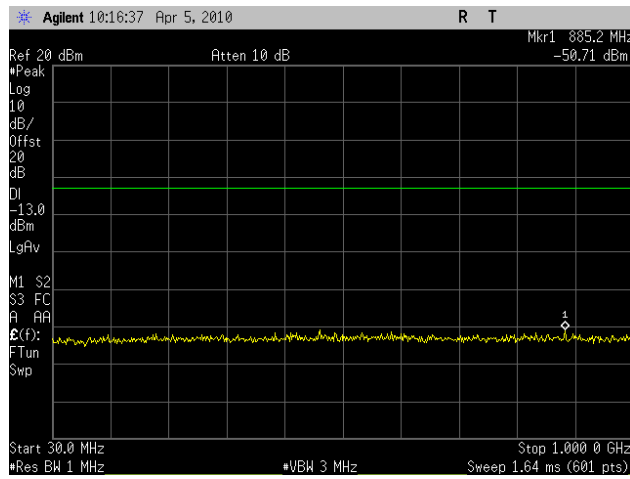

Plot 88. Conducted Spurious Emissions Mid Ch, 30 MHz - 1GHz, (HT20) – Port 1

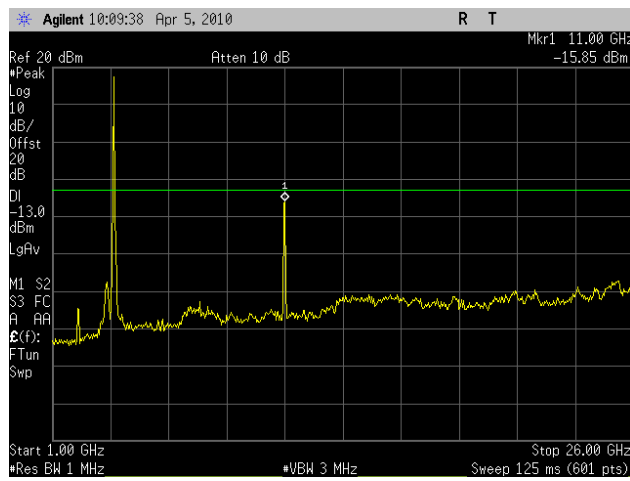

Plot 89. Conducted Spurious Emissions Mid Ch, 1 GHz – 26GHz, (HT20) – Port 1

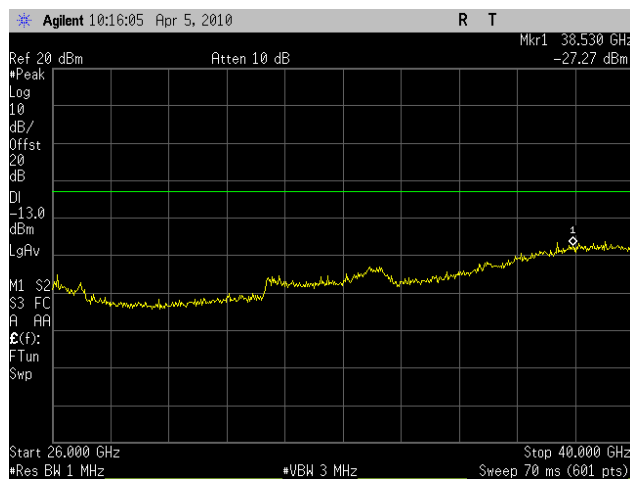

Plot 90. Conducted Spurious Emissions Mid Ch, 26GHz – 40GHz, (HT20) – Port 1



Conducted Spurious Emissions Test Results

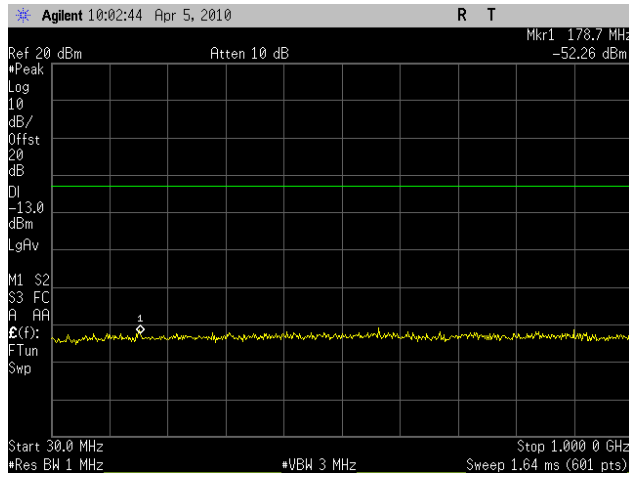

Plot 91. Conducted Spurious Emissions Mid Ch, 30 MHz - 1GHz, (HT20) – Port 2

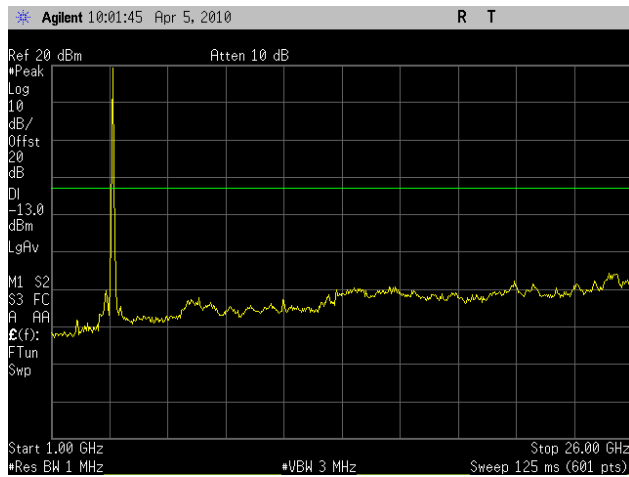

Plot 92. Conducted Spurious Emissions Mid Ch, 1 GHz – 26GHz, (HT20) – Port 2

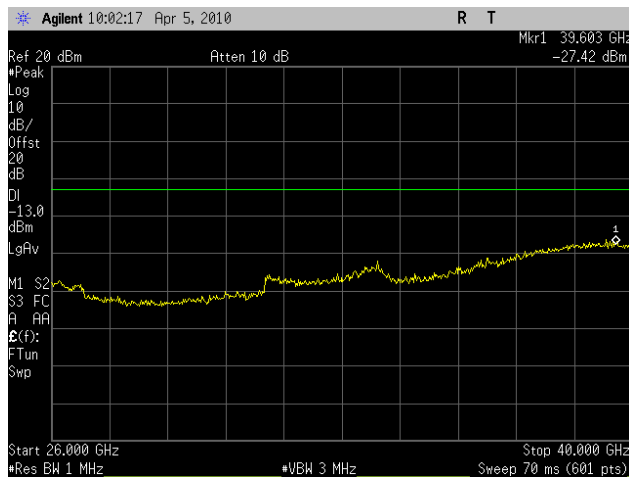

Plot 93. Conducted Spurious Emissions Mid Ch, 26GHz – 40GHz, (HT20) – Port 2



Conducted Band Edge Test Results

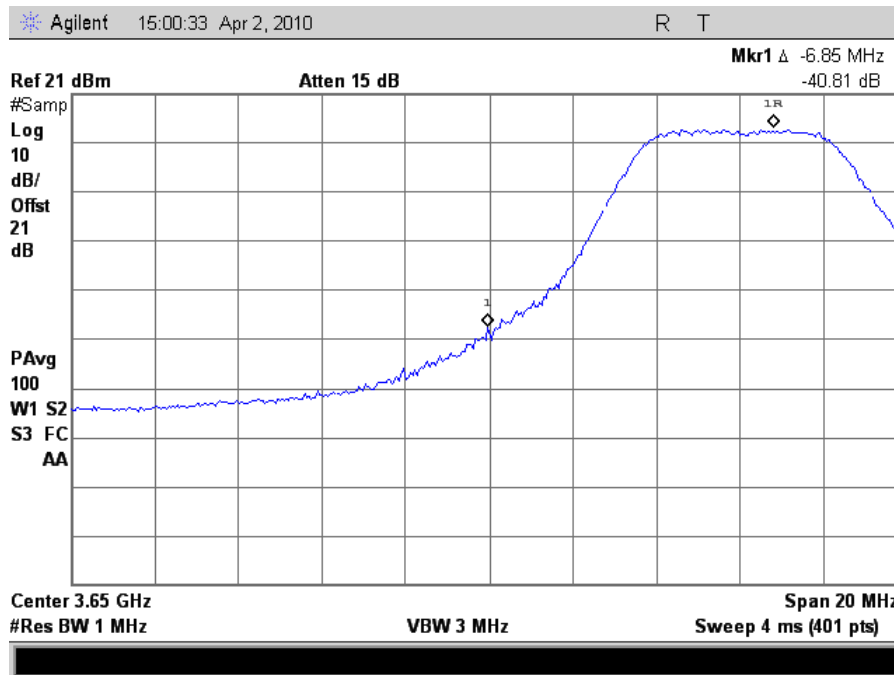

Plot 94. Conducted Band Edge Low Channel, HT5 – Port 1

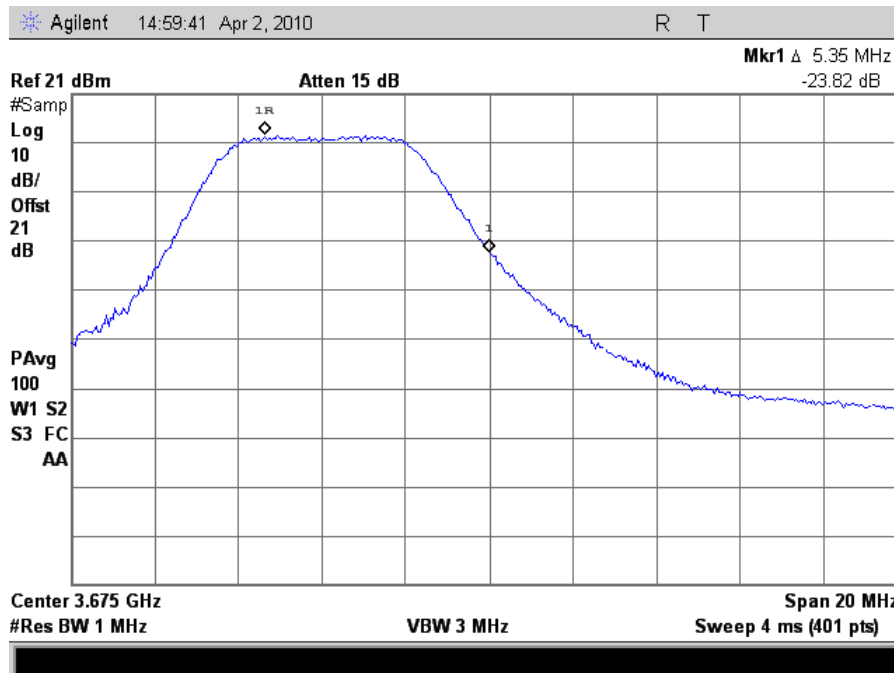

Plot 95. Conducted Band Edge High Channel, HT5 – Port 1



Conducted Band Edge Test Results

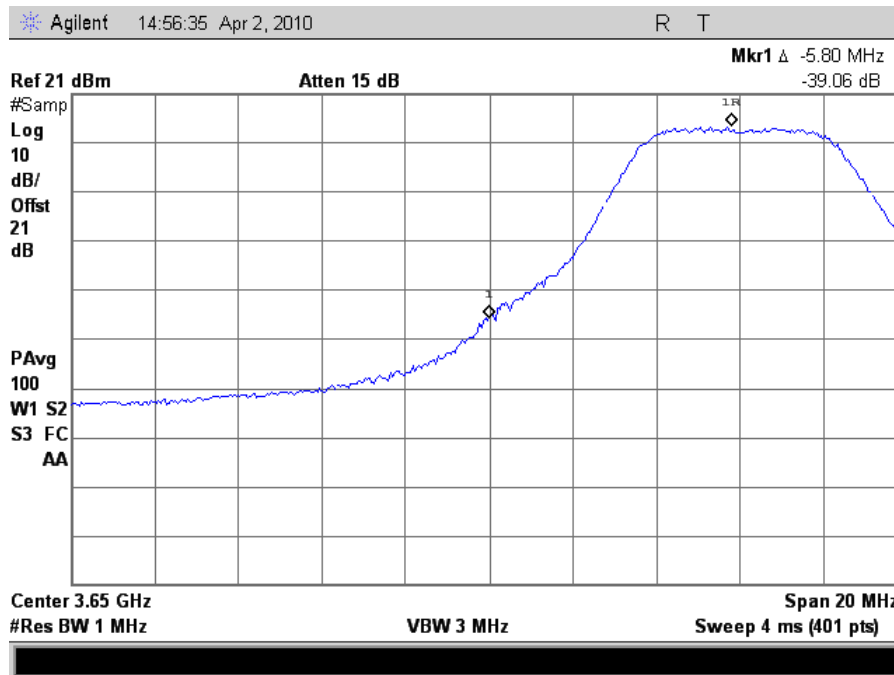

Plot 96. Conducted Band Edge Low Channel, HT5 – Port 2

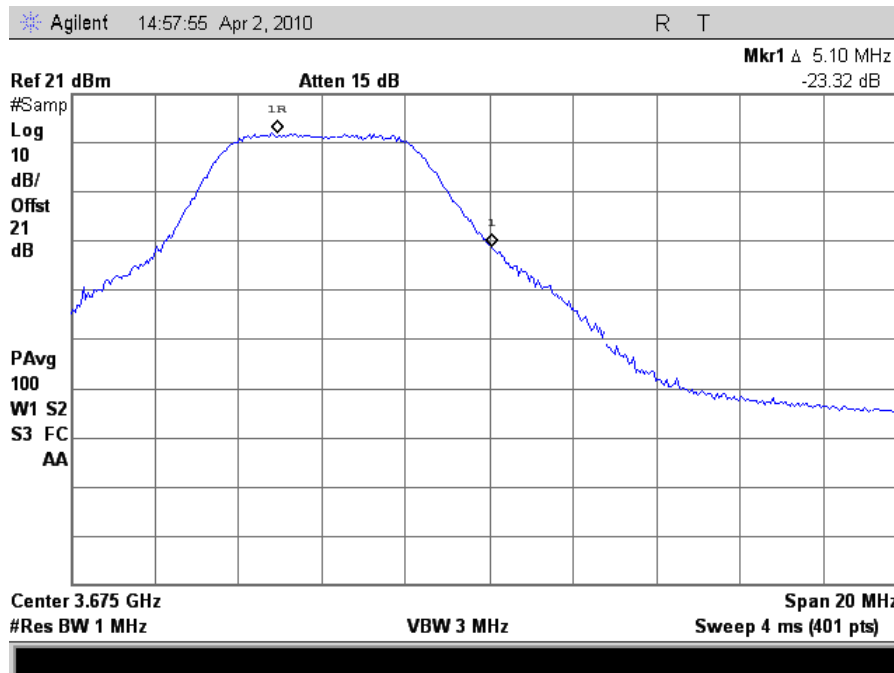

Plot 97. Conducted Band Edge High Channel, HT5 – Port 2



Conducted Band Edge Test Results

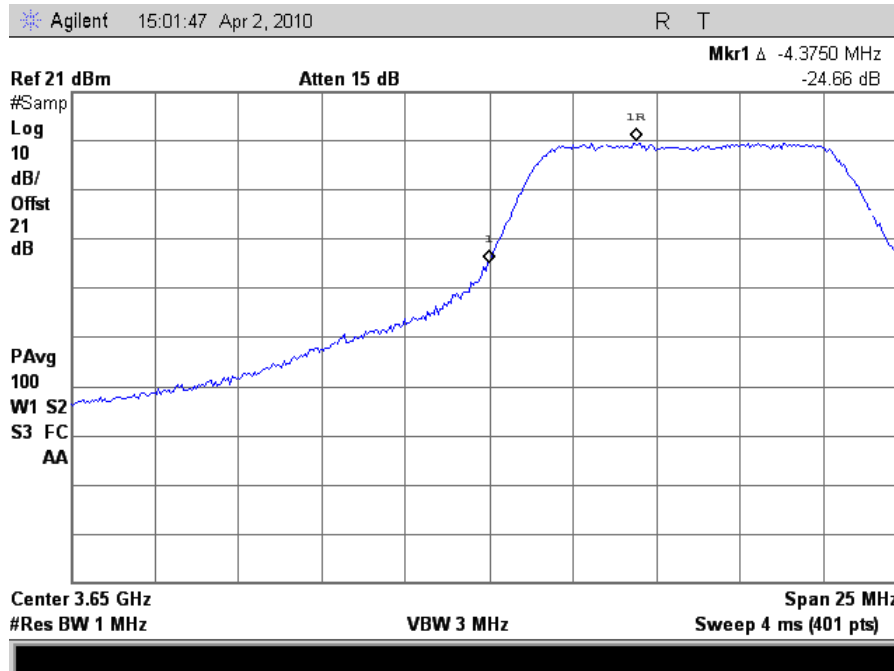

Plot 98. Conducted Band Edge Low Channel, HT10 – Port 1

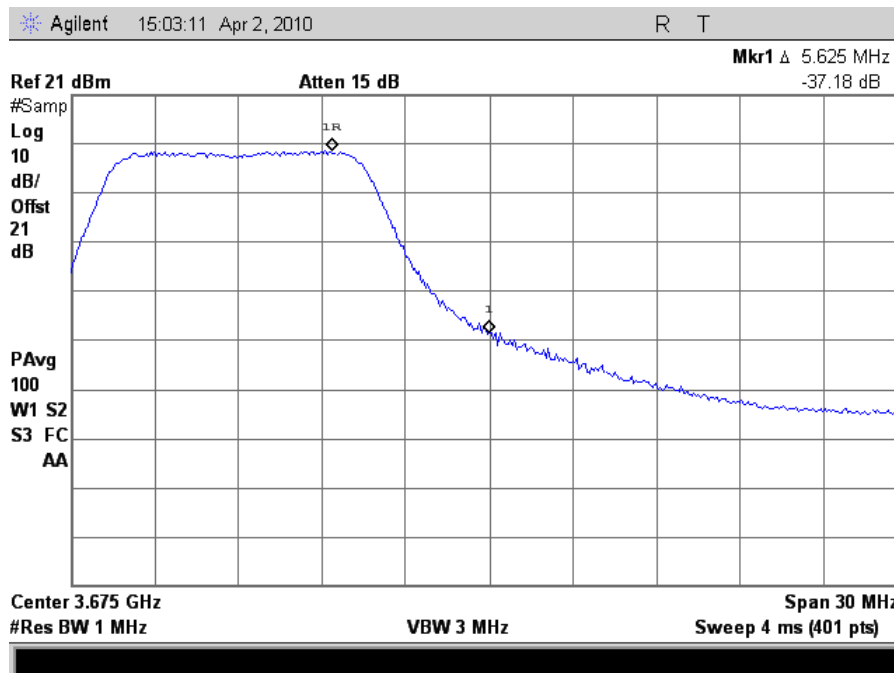

Plot 99. Conducted Band Edge High Channel, HT10 – Port 1



Conducted Band Edge Test Results

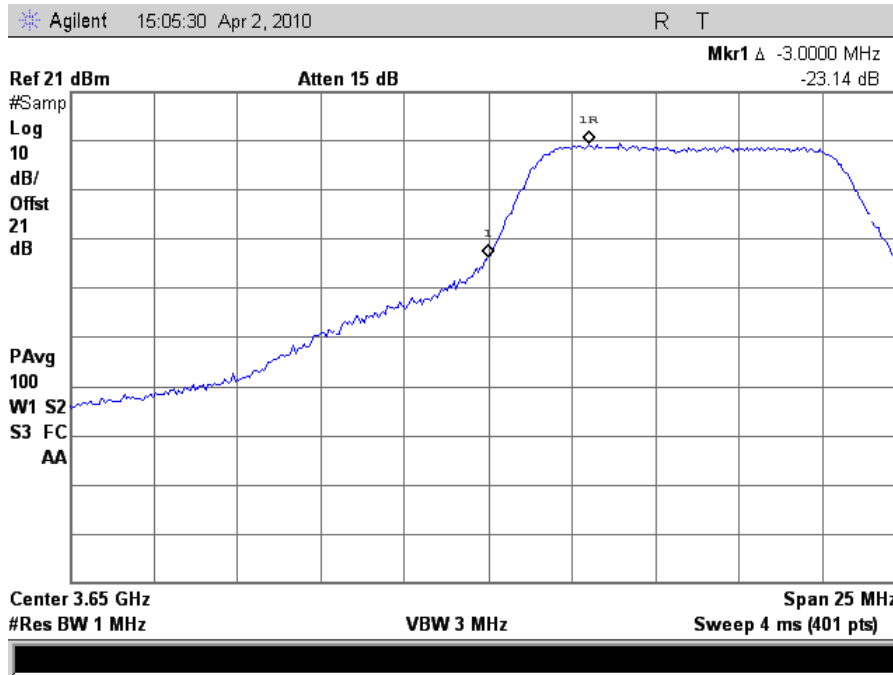

Plot 100. Conducted Band Edge Low Channel, HT10 – Port 2

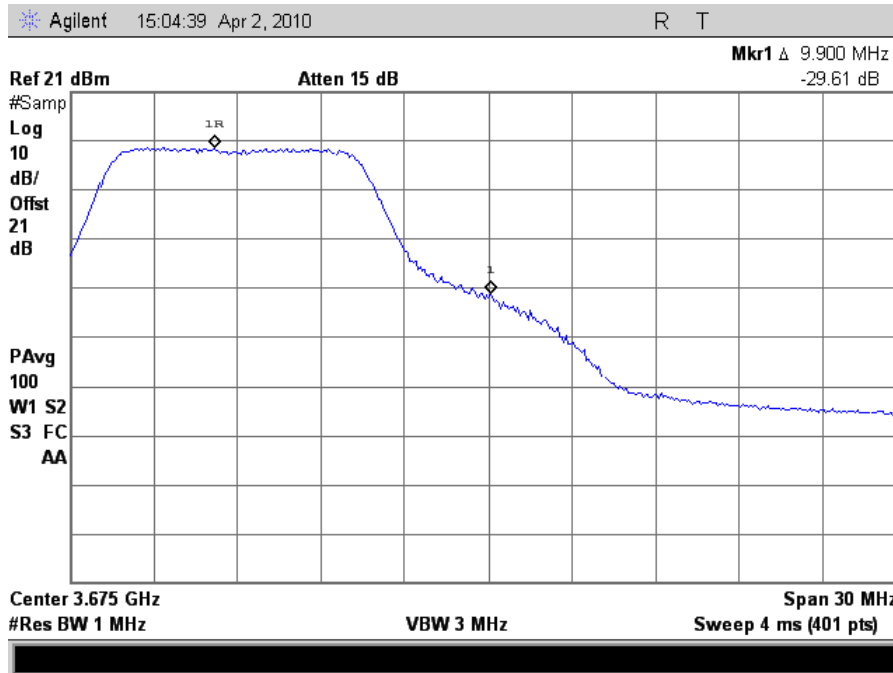

Plot 101. Conducted Band Edge High Channel, HT10 – Port 2



Conducted Band Edge Test Results

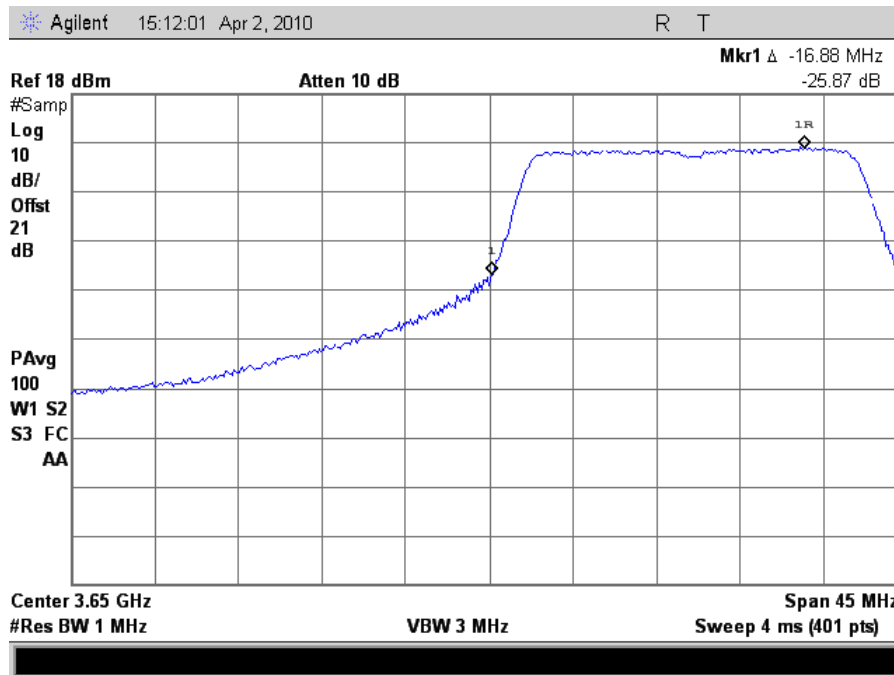

Plot 102. Conducted Band Edge Mid Channel (Low Band), HT20 – Port 1

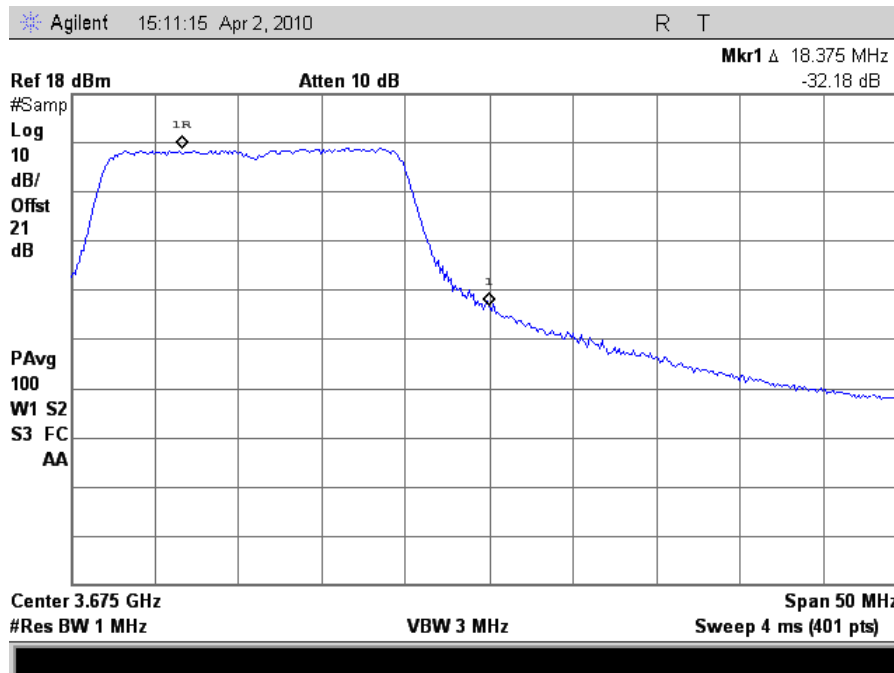

Plot 103. Conducted Band Edge Mid Channel (High Band), HT20 – Port 1



Conducted Band Edge Test Results

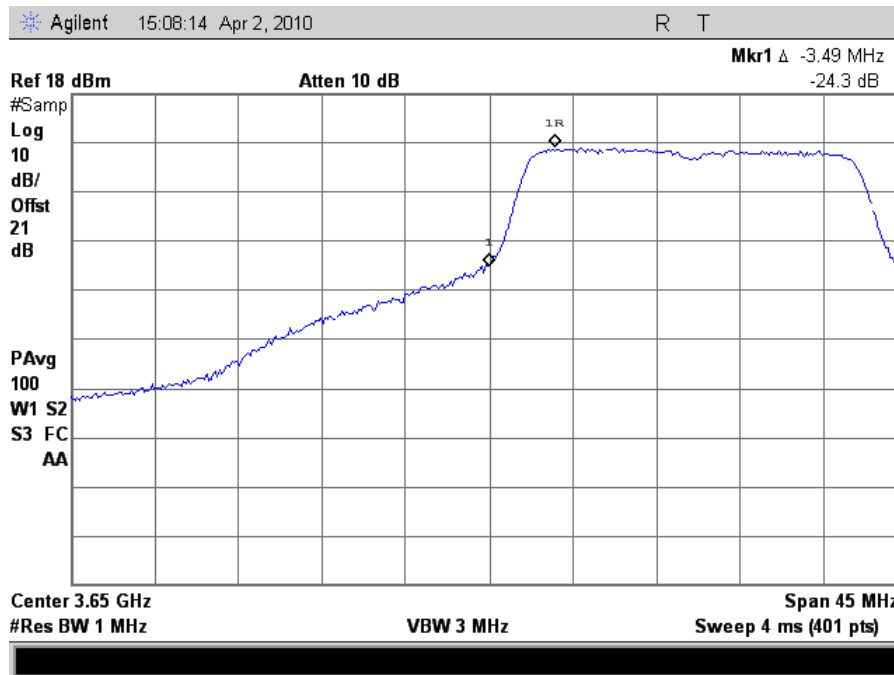

Plot 104. Conducted Band Edge Mid Channel (Low Band), HT20 – Port 2

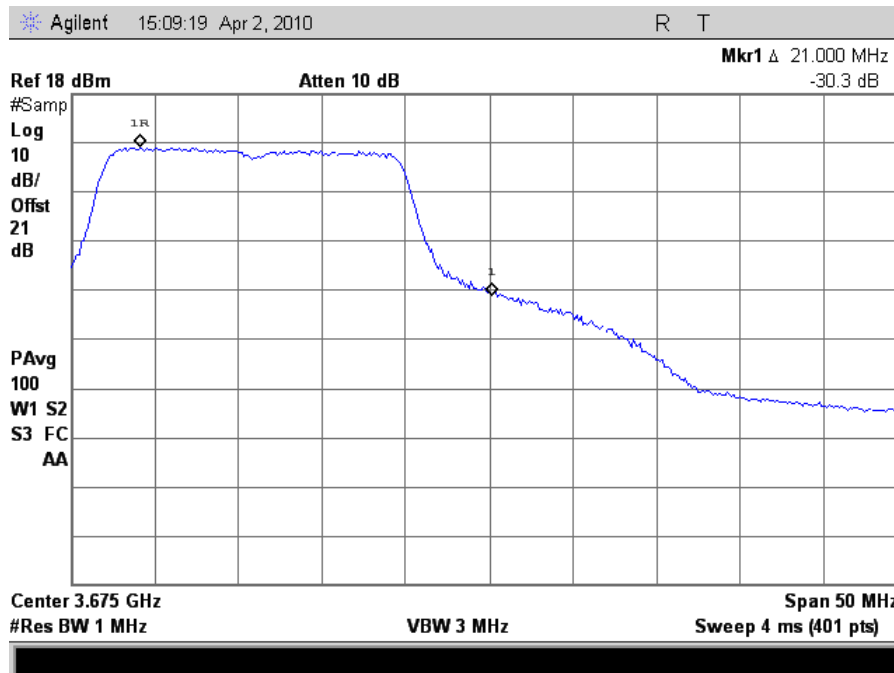

Plot 105. Conducted Band Edge Mid Channel (High Band), HT20 – Port 2



Electromagnetic Compatibility Radiated Emissions Requirements

6.2. Radiated Emissions (Substitution Method)

Test Requirement(s): §2.1053 and TIA/EIA-603-A-2001

Test Procedures: As required by 47 CFR 2.1053, *field strength of radiated spurious measurements* were made in accordance with the procedures of TIA/EIA-603-A-2001 "Land Mobile FM or PM Communications Equipment Measurement and Performance Standards".

Radiated emission measurements were performed inside a 10 meter semi-anechoic chamber. The EUT was set at a distance of 3m from the receiving antenna. The EUT's RF ports were terminated to 50ohm load. The EUT was set to transmit at the low, mid and high channels of the transmitter frequency range at its maximum power level. The EUT was rotated about 360⁰ and the receiving antenna scanned from 1-4m in order to capture the maximum emission. A calibrated antenna source was positioned in place of the EUT and the previously recorded signal was duplicated. The maximum EIRP of the emission was calculated by adding the forward power to the calibrated source plus its appropriate gain value. These steps were carried out with the receiving antenna in both vertical and horizontal polarization. Harmonic emissions up to the 10th or 40GHz, which ever was the lesser, were investigated.

The formula used to convert dBuV/m to dBm is as followed:

$$\text{EIRP} = E_o + 20\text{Log}D - 104.8$$

$$\text{EIRP} = \text{dBm}$$

$$E_o = \text{Corrected Field Strength in dBuV/m}$$

$$D = \text{Measurement Distance}$$

Test Results: Equipment complies with Section 2.1053 and TIA/EIA-603-A-2001.

Test Engineer(s): Anderson Soungpanya

Test Date(s): 04/08/10



Radiated Emissions (Substitution Method) Test Results

Freq. (GHz)	Antenna Polarity (H/V)	Raw Amp. @ 3 m (Peak) / (Avg)	P.Amp (dB)	Ant. Cor. Factor (dB/m)	Cable Loss (dB)	EUT Field Strength Final Amp. (dBµV/m)	EIRP (dBm)	Limit Detector Peak / Avg	Limit @ 3 m (dBµV/m)	Delta (dB)
7.312	V	45.41	35.02	35.64	5.94	51.96	-43.29	Peak	-13	-30.29
7.312	V	32.57	35.02	35.64	5.94	39.12	-56.13	Avg	-13	-43.13
10.968	V	44.36	34.82	37.72	6.95	54.21	-41.05	Peak	-13	-28.05
10.968	V	31.21	34.82	37.72	6.95	41.06	-54.20	Avg	-13	-41.20
14.624	V	45.41	33.97	39.63	7.81	58.88	-36.38	Peak	-13	-23.38
14.624	V	31.88	33.97	39.63	7.81	45.35	-49.91	Avg	-13	-36.91
Low Channel 3.656GHz										
Freq. (GHz)	Antenna Polarity (H/V)	Raw Amp. @ 3 m (Peak) / (Avg)	P.Amp (dB)	Ant. Cor. Factor (dB/m)	Cable Loss (dB)	EUT Field Strength Final Amp. (dBµV/m)	EIRP (dBm)	Limit Detector Peak / Avg	Limit @ 3 m (dBµV/m)	Delta (dB)
7.322	V	46.1	35.03	35.64	5.98	52.70	-42.56	Peak	-13	-29.56
7.322	V	33.09	35.03	35.64	5.98	39.69	-55.57	Avg	-13	-42.57
10.983	V	44.8	34.82	37.72	6.97	54.68	-40.58	Peak	-13	-27.58
10.983	V	31.08	34.82	37.72	6.97	40.96	-54.30	Avg	-13	-41.30
14.644	V	44.83	33.99	39.63	7.86	58.32	-36.93	Peak	-13	-23.93
14.644	V	32.05	33.99	39.63	7.86	45.54	-49.71	Avg	-13	-36.71
Mid Channel 3.661GHz										
Freq. (GHz)	Antenna Polarity (H/V)	Raw Amp. @ 3 m (Peak) / (Avg)	P.Amp (dB)	Ant. Cor. Factor (dB/m)	Cable Loss (dB)	EUT Field Strength Final Amp. (dBµV/m)	EIRP (dBm)	Limit Detector Peak / Avg	Limit @ 3 m (dBµV/m)	Delta (dB)
7.342	V	45.59	35.03	35.64	6.07	52.27	-42.99	Peak	-13	-29.99
7.342	V	32.88	35.03	35.64	6.07	39.56	-55.70	Avg	-13	-42.70
11.013	V	44.27	34.81	37.74	7.02	54.22	-41.03	Peak	-13	-28.03
11.013	V	31.12	34.81	37.74	7.02	41.07	-54.18	Avg	-13	-41.18
14.684	V	45.9	34.03	39.62	7.96	59.45	-35.81	Peak	-13	-22.81
14.684	V	31.35	34.03	39.62	7.96	44.90	-50.36	Avg	-13	-37.36
High Channel 3.671GHz										

Table 33. Radiated Harmonics, HT5

Notes: All other emissions were measured at the noise floor of the spectrum analyzer.



Radiated Spurious Test Results

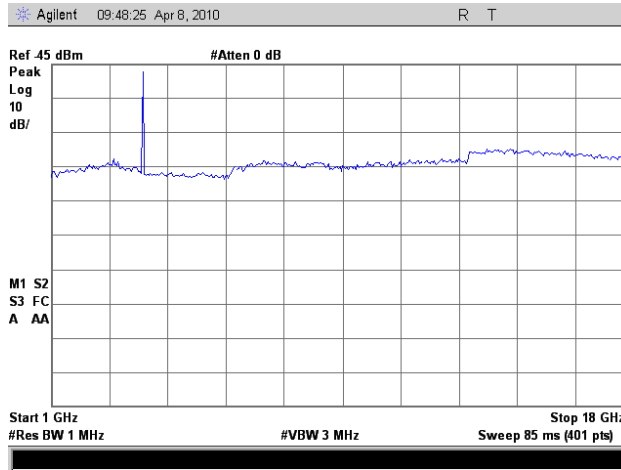

Plot 106. Radiated Spurious Low Channel, HT5 (1-18GHz) – All Ports

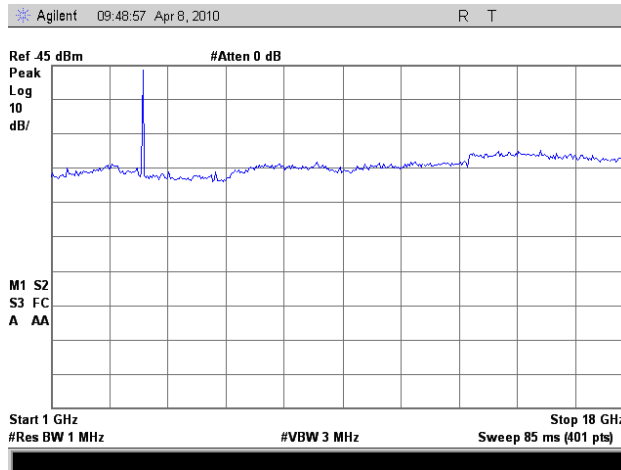

Plot 107. Radiated Spurious Mid Channel, HT5 (1-18GHz) – All Ports

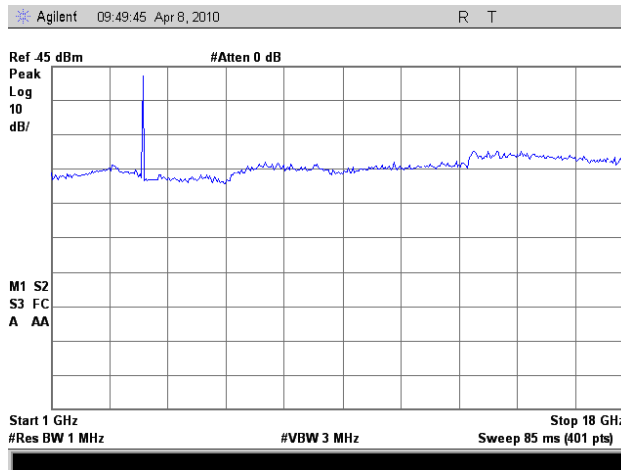

Plot 108. Radiated Spurious High Channel, HT5 (1-18GHz) – All Ports



Radiated Emissions (Substitution Method) Test Results

Freq. (GHz)	Antenna Polarity (H/V)	Raw Amp. @ 3 m (Peak) / (Avg)	P.Amp (dB)	Ant. Cor. Factor (dB/m)	Cable Loss (dB)	EUT Field Strength Final Amp. (dBµV/m)	EIRP (dBm)	Limit Detector Peak / Avg	Limit @ 3 m (dBµV/m)	Delta (dB)
7.312	V	44.42	35.02	35.64	5.94	50.97	-44.28	Peak	-13	-31.28
7.312	V	30.23	35.02	35.64	5.94	36.78	-58.47	Avg	-13	-45.47
10.968	V	45.52	34.82	37.72	6.95	55.37	-39.89	Peak	-13	-26.89
10.968	V	31.09	34.82	37.72	6.95	40.94	-54.32	Avg	-13	-41.32
14.624	V	45.53	33.97	39.63	7.81	59.00	-36.26	Peak	-13	-23.26
14.624	V	30.31	33.97	39.63	7.81	43.78	-51.48	Avg	-13	-38.48
Low Channel 3.656GHz										
Freq. (GHz)	Antenna Polarity (H/V)	Raw Amp. @ 3 m (Peak) / (Avg)	P.Amp (dB)	Ant. Cor. Factor (dB/m)	Cable Loss (dB)	EUT Field Strength Final Amp. (dBµV/m)	EIRP (dBm)	Limit Detector Peak / Avg	Limit @ 3 m (dBµV/m)	Delta (dB)
7.322	V	46.14	35.03	35.64	5.98	52.74	-42.52	Peak	-13	-29.52
7.322	V	31.14	35.03	35.64	5.98	37.74	-57.52	Avg	-13	-44.52
10.983	V	45.12	34.82	37.72	6.97	55.00	-40.26	Peak	-13	-27.26
10.983	V	30.81	34.82	37.72	6.97	40.69	-54.57	Avg	-13	-41.57
14.644	V	46.19	33.99	39.63	7.86	59.68	-35.57	Peak	-13	-22.57
14.644	V	31.4	33.99	39.63	7.86	44.89	-50.36	Avg	-13	-37.36
Mid Channel 3.661GHz										
Freq. (GHz)	Antenna Polarity (H/V)	Raw Amp. @ 3 m (Peak) / (Avg)	P.Amp (dB)	Ant. Cor. Factor (dB/m)	Cable Loss (dB)	EUT Field Strength Final Amp. (dBµV/m)	EIRP (dBm)	Limit Detector Peak / Avg	Limit @ 3 m (dBµV/m)	Delta (dB)
7.332	V	46.98	35.03	35.64	6.03	53.62	-41.64	Peak	-13	-28.64
7.332	V	31.74	35.03	35.64	6.03	38.38	-56.88	Avg	-13	-43.88
10.998	V	45.57	34.81	37.73	7.00	55.49	-39.77	Peak	-13	-26.77
10.998	V	31.26	34.81	37.73	7.00	41.18	-54.08	Avg	-13	-41.08
14.664	V	44.18	34.01	39.63	7.90	57.70	-37.56	Peak	-13	-24.56
14.664	V	30.19	34.01	39.63	7.90	43.71	-51.55	Avg	-13	-38.55
High Channel 3.666GHz										

Table 34. Radiated Harmonics, HT10

Notes: All other emissions were measured at the noise floor of the spectrum analyzer.



Radiated Spurious Test Results

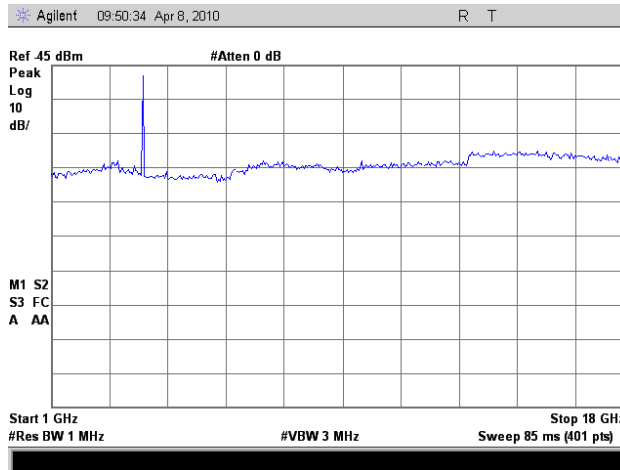

Plot 109. Radiated Spurious Low Channel, HT10 (1-18GHz) – All Ports

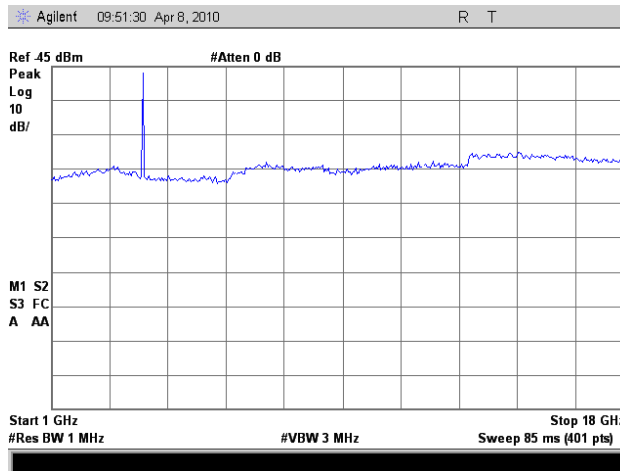

Plot 110. Radiated Spurious Mid Channel, HT10 (1-18GHz) – All Ports

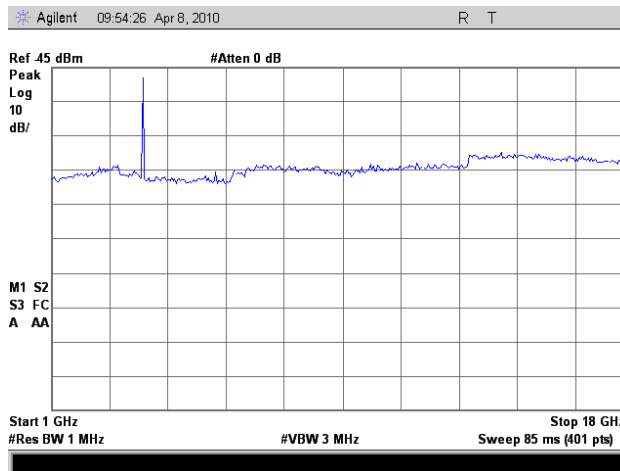

Plot 111. Radiated Spurious High Channel, HT10 (1-18GHz) – All Ports



Radiated Emissions (Substitution Method) Test Results

Low Channel 3.656GHz										
Freq. (GHz)	Antenna Polarity (H/V)	Raw Amp. @ 3 m (Peak) / (Avg)	P.Amp (dB)	Ant. Cor. Factor (dB/m)	Cable Loss (dB)	EUT Field Strength Final Amp. (dBµV/m)	EIRP (dBm)	Limit Detector Peak / Avg	Limit @ 3 m (dBµV/m)	Delta (dB)
7.322	V	46.19	35.03	35.64	5.98	52.79	-42.47	Peak	-13	-29.47
7.322	V	30.83	35.03	35.64	5.98	37.43	-57.83	Avg	-13	-44.83
10.983	V	45.17	34.82	37.72	6.97	55.05	-40.21	Peak	-13	-27.21
10.983	V	31.13	34.82	37.72	6.97	41.01	-54.25	Avg	-13	-41.25
14.644	V	45.9	33.99	39.63	7.86	59.39	-35.86	Peak	-13	-22.86
14.644	V	30.17	33.99	39.63	7.86	43.66	-51.59	Avg	-13	-38.59

Mid Channel 3.661GHz

Table 35. Radiated Harmonics, HT20

Notes: All other emissions were measured at the noise floor of the spectrum analyzer.

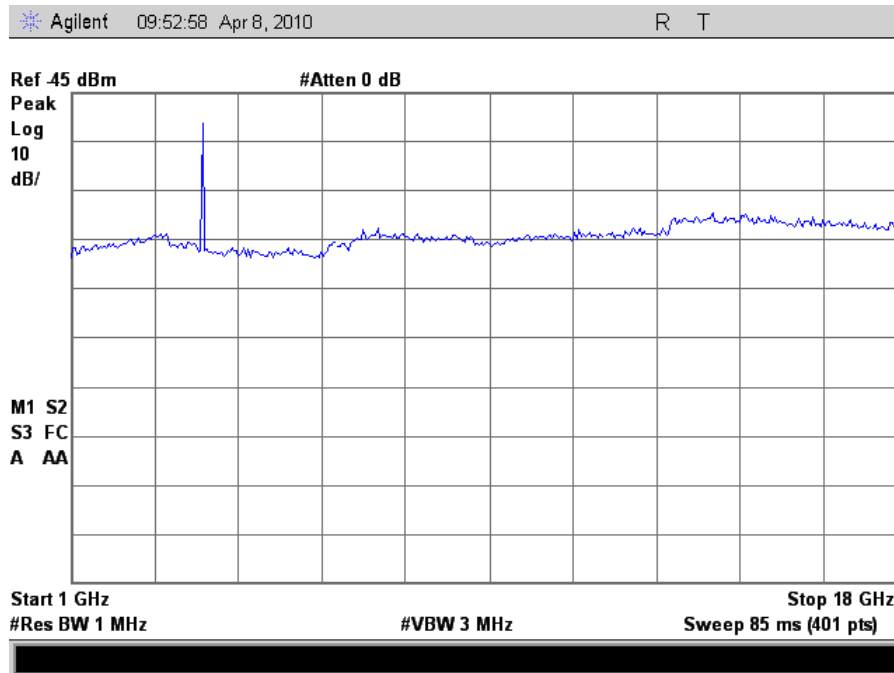

Plot 112. Radiated Spurious Mid Channel, HT20 (1-18GHz) – All Ports

Radiated Emissions Spurious Test Setup



Photograph 5. Radiated Emission Spurious Test Setup

Radiated Emissions Spurious Test Setup



Photograph 6. Radiated Emission Spurious Bilog Antenna Test Setup

Radiated Emissions Spurious Test Setup



Photograph 7. Radiated Emission Spurious Horn Antenna Test Setup



7. RF Exposure Requirements

RF Exposure Requirements: §90.1335, §1.1307(b), 2.1091, 2.1093: Systems operating under the provisions of this section shall be operated in a manner that ensures that the public is not exposed to radio frequency energy levels in excess of the Commission's guidelines.

RF Radiation Exposure Limit: §1.1307: As specified in this section, the Maximum Permissible Exposure (MPE) Limit shall be used to evaluate the environmental impact of human exposure to radiofrequency (RF) radiation as specified in Sec. 1.1307(b), except in the case of portable devices which shall be evaluated according to the provisions of Sec. 2.1093 of this chapter.

MPE Limit Calculation: EUT's operating frequencies @ 3650–3675 MHz
Limit for Uncontrolled exposure: 1 mW/cm² or 10 W/m²

Equation from page 18 of OET 65, Edition 97-01

EUT with 28 dBi Antenna

Conducted Power = 11.80 dBm
 $S = PG / 4\pi R^2$ or $R = \sqrt{PG} / 4\pi S$
where, S = Power Density (1 mW/cm²)
P = Power Input to antenna (15.13mW)
G = Antenna Gain (630.95 numeric)

$$R = (15.13 * 630.95 / 4 * 3.14)^{1/2} = (9549.926 / 12.56)^{1/2} = 27.57 \text{cm} \text{ in order to comply with } 1 \text{ mW/cm}^2$$

EUT with 21 dBi Antenna

Conducted Power = 18.80 dBm
 $S = PG / 4\pi R^2$ or $R = \sqrt{PG} / 4\pi S$
where, S = Power Density (1 mW/cm²)
P = Power Input to antenna (75.86mW)
G = Antenna Gain (125.90 numeric)

$$R = (75.89 * 125.90 / 4 * 3.14)^{1/2} = (9549.926 / 12.56)^{1/2} = 27.57 \text{cm} \text{ in order to comply with } 1 \text{ mW/cm}^2$$

EUT with 17 dBi Antenna

Conducted Power = 22.80 dBm
 $S = PG / 4\pi R^2$ or $R = \sqrt{PG} / 4\pi S$
where, S = Power Density (1 mW/cm²)
P = Power Input to antenna (190.54mW)
G = Antenna Gain (50.12 numeric)

$$R = (190.54 * 50.12 / 4 * 3.14)^{1/2} = (9549.926 / 12.56)^{1/2} = 27.57 \text{cm} \text{ in order to comply with } 1 \text{ mW/cm}^2$$



8. Electromagnetic Compatibility Frequency Stability Requirements

8.1. Frequency Stability

Test Requirement(s): §2.1055 and §90.213

Test Procedures: As required by 47 CFR 2.1055, *Frequency Stability measurements* were made at the RF output terminals using a Directional Coupler through a Spectrum Analyzer and Power Meter.

The EUT was placed in the Environmental Chamber and support equipments are outside the chamber on a table. The EUT was set to transmit a CW Frequency The frequency counter option on the Spectrum Analyzer was used to measure frequency deviations. The frequency drift was investigated for every 10^C increment until the unit is stabilized then recorded the reading in tabular format with the temperature range of -30 to 50^C.

Voltage supplied to EUT is 120 VAC reference temperature was done at 20^C. The voltage was varied by ± 15 % of nominal

Test Results: Equipment complies with Section 2.1055 and 90.213

Test Engineer(s): Anderson Soungpanya

Test Date(s): 04/05/2010



Frequency Stability Test Results

Low Channel					
	Voltage (AC)	Temperature (C)	Drift (kHz)	20 PPM Drift Limit (kHz)	Margin (kHz)
Reference @ 120VAC 20C	120	50	4.500000	73.12	-68.620
	120	40	2.250000	73.12	-70.870
	120	30	4.500000	73.12	-68.620
	120	20	0.000000	73.12	-73.120
	120	10	6.750000	73.12	-66.370
	3656.000000	120	0	13.500000	73.12
120		-10	18.000000	73.12	-55.120
120		-20	19.500000	73.12	-53.620
120		-30	13.500000	73.12	-59.620
102		20	0.750000	73.12	-72.370
138		20	2.250000	73.12	-70.870

Table 36. Frequency Stability Test Results, Low Channel

Mid Channel					
	Voltage (AC)	Temperature (C)	Drift (kHz)	20 PPM Drift Limit (kHz)	Margin (kHz)
Reference @ 120VAC 20C	120	50	9.000000	73.22	-64.220
	120	40	3.000000	73.22	-70.220
	120	30	3.750000	73.22	-69.470
	120	20	0.000000	73.22	-73.220
	120	10	6.750000	73.22	-66.470
	3661.000000	120	0	13.500000	73.22
120		-10	19.500000	73.22	-53.720
120		-20	21.000000	73.22	-52.220
120		-30	15.000000	73.22	-58.220
102		20	0.750000	73.22	-72.470
138		20	0.750000	73.22	-72.470

Table 37. Frequency Stability Test Results, Mid Channel (3661MHz)



Mid Channel					
	Voltage (AC)	Temperature (C)	Drift (kHz)	20 PPM Drift Limit (kHz)	Margin (kHz)
Reference @ 120VAC 20C	120	50	4.500000	73.32	-68.820
	120	40	3.000000	73.32	-70.320
	120	30	3.750000	73.32	-69.570
	120	20	0.000000	73.32	-73.320
	120	10	7.500000	73.32	-65.820
3666.000000	120	0	14.250000	73.32	-59.070
	120	-10	19.500000	73.32	-53.820
	120	-20	19.500000	73.32	-53.820
	120	-30	12.750000	73.32	-60.570
	102	20	0.750000	73.32	-72.570
	138	20	1.500000	73.32	-71.820

Table 38. Frequency Stability Test Results, Mid Channel (3666MHz)

High Channel					
	Voltage (AC)	Temperature (C)	Drift (kHz)	20 PPM Drift Limit (kHz)	Margin (kHz)
Reference @ 120VAC 20C	120	50	0.750000	73.42	-72.670
	120	40	3.750000	73.42	-69.670
	120	30	5.250000	73.42	-68.170
	120	20	0.000000	73.42	-73.420
	120	10	6.750000	73.42	-66.670
3671.000000	120	0	14.250000	73.42	-59.170
	120	-10	18.750000	73.42	-54.670
	120	-20	18.750000	73.42	-54.670
	120	-30	13.500000	73.42	-59.920
	102	20	0.750000	73.42	-72.670
	138	20	0.000000	73.42	-73.420

Table 39. Frequency Stability Test Results, High Channel



9. Test Equipment

Calibrated test equipment utilized during testing was maintained in a current state of calibration per the requirements of ANSI/NCSS Z540-1-1994 and ANSI/ISO/IEC 17025:2000.

MET Asset #	Equipment	Manufacturer	Model	Last Cal Date	Cal Due Date
1S2421	EMI RECEIVER	ROHDE&SCHWARZ	ESIB 7	05/27/2009	05/27/2010
1S2121	PRE-AMPLIFIER	HEWLETT PACKARD	8449B	SEE NOTE	
1S2501	EMI RECEIVER	Rohde & Schwarz	ESU40	4/27/2009	4/27/2010
1S2198	HORN ANTENNA	EMCO	3115	09/03/2009	09/03/2010
1S2603	HORN ANTENNA	ETS-LINDGREN	3117	4/9/2009	4/9/2011
1S2202	HORN ANTENNA	EMCO	3116	4/10/2007	4/10/2010
N/A	HIGH PASS FILTER	MICRO-TRONICS	HPM13146	SEE NOTE	
1S2041	COUPLER, BI DIRECTIONAL COAXIAL	NARDA	N/A	SEE NOTE	
1S2583	ANALYZER, SPECTRUM	AGILENT	E4447A	1/26/2010	1/26/2011
1S2460	ANALYZER, SPECTRUM 9 KHZ-40GHZ	AGILENT	E4407B	04/14/2009	04/14/2010
1S508	LISN	SOLAR ELECTRONICS	9252-50-R24-BNC	06/05/2009	06/05/2010
1S2512	TRANSIENT LIMITER	AGILENT	11947A	SEE NOTE	
1S2517	Thermo-Hygrometer	Fisher Scientific	11-661-7D	11/11/2009	11/11/2011
1S2482	CHAMBER, 5 METER	PANASHIELD	641431	10/16/2009	10/16/2010
1S2108	RECEIVER, EMI, RF FILTER SECTION	HEWLETT PACKARD	85460A	11/10/2009	11/10/2010
1S2399	TURNTABLE CONTROLLER	SUNOL SCIENCE	SC99V	SEE NOTE	
1S2484	BILOG ANTENNA	TESEQ	CBL6112D	01/27/2009	01/27/2011

Table 40. Test Equipment List

Note: Functionally tested equipment is verified using calibrated instrumentation at the time of testing.



Certification & User's Manual Information



10. Certification Label & User's Manual Information

10.1. Certification Information

The following is extracted from Title 47 of the Code of Federal Regulations, Part 2, Subpart I — Marketing of Radio frequency devices:

§ 2.801 Radio-frequency device defined.

As used in this part, a radio-frequency device is any device which in its operation is capable of Emitting radio-frequency energy by radiation, conduction, or other means. Radio- frequency devices include, but are not limited to:

- (a) The various types of radio communication transmitting devices described throughout this chapter.
- (b) *The incidental, unintentional and intentional radiators defined in Part 15 of this chapter.*
- (c) The industrial, scientific, and medical equipment described in Part 18 of this chapter.
- (d) Any part or component thereof which in use emits radio-frequency energy by radiation, conduction, or other means.

§ 2.803 Marketing of radio frequency devices prior to equipment authorization.

- (a) Except as provided elsewhere in this chapter, no person shall sell or lease, or offer for sale or lease (including advertising for sale or lease), or import, ship or distribute for the purpose of selling or leasing or offering for sale or lease, any radio frequency device unless:
 - (1) In the case of a device subject to certification, such device has been authorized by the Commission in accordance with the rules in this chapter and is properly identified and labeled as required by §2.925 and other relevant sections in this chapter; or
 - (2) In the case of a device that is not required to have a grant of equipment authorization issued by the Commission, but which must comply with the specified technical standards prior to use, such device also complies with all applicable administrative (including verification of the equipment or authorization under a Declaration of Conformity, where required), technical, labeling and identification requirements specified in this chapter.
- (d) Notwithstanding the provisions of paragraph (a) of this section, the offer for sale solely to business, commercial, industrial, scientific or medical users (but not an offer for sale to other parties or to end users located in a residential environment) of a radio frequency device that is in the conceptual, developmental, design or pre-production stage is permitted prior to equipment authorization or, for devices not subject to the equipment authorization requirements, prior to a determination of compliance with the applicable technical requirements *provided* that the prospective buyer is advised in writing at the time of the offer for sale that the equipment is subject to the FCC rules and that the equipment will comply with the appropriate rules before delivery to the buyer or to centers of distribution.



- (e)(1) Notwithstanding the provisions of paragraph (a) of this section, prior to equipment authorization or determination of compliance with the applicable technical requirements any radio frequency device may be operated, but not marketed, for the following purposes and under the following conditions:
- (i) *Compliance testing;*
 - (ii) Demonstrations at a trade show provided the notice contained in paragraph (c) of this section is displayed in a conspicuous location on, or immediately adjacent to, the device;
 - (iii) Demonstrations at an exhibition conducted at a business, commercial, industrial, scientific or medical location, but excluding locations in a residential environment, provided the notice contained in paragraphs (c) or (d) of this section, as appropriate, is displayed in a conspicuous location on, or immediately adjacent to, the device;
 - (iv) Evaluation of product performance and determination of customer acceptability, provided such operation takes place at the manufacturer's facilities during developmental, design or pre-production states; or
 - (v) Evaluation of product performance and determination of customer acceptability where customer acceptability of a radio frequency device cannot be determined at the manufacturer's facilities because of size or unique capability of the device, provided the device is operated at a business, commercial, industrial, scientific or medical user's site, but not at a residential site, during the development, design or pre-production stages.
- (e)(2) For the purpose of paragraphs (e)(1)(iv) and (e)(1)(v) of this section, the term *manufacturer's facilities* includes the facilities of the party responsible for compliance with the regulations and the manufacturer's premises, as well as the facilities of other entities working under the authorization of the responsible party in connection with the development and manufacture, but not the marketing, of the equipment.
- (f) For radio frequency devices subject to verification and sold solely to business, commercial, industrial, scientific and medical users (excluding products sold to other parties or for operation in a residential environment), parties responsible for verification of the devices shall have the option of ensuring compliance with the applicable technical specifications of this chapter at each end user's location after installation, provided that the purchase or lease agreement includes a provision that such a determination of compliance be made and is the responsibility of the party responsible for verification of the equipment.



The following is extracted from Title 47 of the Code of Federal Regulations, Part 2, Subpart Y — Equipment Authorization Procedures:

§ 2.901 Basis and Purpose

- (a) In order to carry out its responsibilities under the Communications Act and the various treaties and international regulations, and in order to promote efficient use of the radio spectrum, the Commission has developed technical standards for radio frequency equipment and parts or components thereof. The technical standards applicable to individual types of equipment are found in that part of the rules governing the service wherein the equipment is to be operated.¹ *In addition to the technical standards provided, the rules governing the service may require that such equipment be verified by the manufacturer or importer, be authorized under a Declaration of Conformity, or receive an equipment authorization from the Commission by one of the following procedures: certification or registration.*

- (b) The following sections describe the verification procedure, the procedure for a Declaration of Conformity, and the procedures to be followed in obtaining certification from the Commission and the conditions attendant to such a grant, whichever is applicable.

§ 2.902 Certification.

- (a) Certification is an equipment authorization issued by the Commission, based on representation and test data submitted by the applicant.

- (b) Certification attaches to all units subsequently marketed by the grantee which are identical (see Section 2.908) to the sample tested except for permissive changes or other variations authorized by the Commission pursuant to Section 2.1043.

¹ In this case, the equipment is subject to the rules of Part 15. More specifically, the equipment falls under Subpart B (of Part 15), which deals with unintentional radiators.



§ 2.948 Description of measurement facilities.

- (a) Each party making measurements of equipment that is subject to an equipment authorization under Part 15 or Part 18 of this chapter, regardless of whether the measurements are filed with the Commission or kept on file by the party responsible for compliance of equipment marketed within the U.S. or its possessions, shall compile a description of the measurement facilities employed.
 - (1) If the measured equipment is subject to the verification procedure, the description of the measurement facilities shall be retained by the party responsible for verification of the equipment.
 - (i) *If the equipment is verified through measurements performed by an independent laboratory, it is acceptable for the party responsible for verification of the equipment to rely upon the description of the measurement facilities retained by or placed on file with the Commission by that laboratory. In this situation, the party responsible for the verification of the equipment is not required to retain a duplicate copy of the description of the measurement facilities.*
 - (ii) If the equipment is verified based on measurements performed at the installation site of the equipment, no specific site calibration data is required. It is acceptable to retain the description of the measurement facilities at the site at which the measurements were performed.
 - (2) If the equipment is to be authorized by the Commission under the certification procedure, the description of the measurement facilities shall be filed with the Commission's Laboratory in Columbia, Maryland. The data describing the measurement facilities need only be filed once but must be updated as changes are made to the measurement facilities or as otherwise described in this section. At least every three years, the organization responsible for filing the data with the Commission shall certify that the data on file is current.



10.2. Label and User's Manual Information

The following is extracted from Title 47 of the Code of Federal Regulations, Part 15, Subpart A — General:

§ 15.19 Labeling requirements.

(a) *In addition to the requirements in Part 2 of this chapter, a device subject to certification or verification shall be labeled as follows:*

- (1) Receivers associated with the operation of a licensed radio service, e.g., FM broadcast under Part 73 of this chapter, land mobile operation under Part 90, etc., shall bear the following statement in a conspicuous location on the device:

This device complies with Part 15 of the FCC Rules. Operation is subject to the condition that this device does not cause harmful interference.

- (2) A stand-alone cable input selector switch, shall bear the following statement in a conspicuous location on the device:

This device is verified to comply with Part 15 of the FCC Rules for use with cable television service.

- (3) All other devices shall bear the following statement in a conspicuous location on the device:

This device complies with Part 15 of the FCC Rules. Operation is subject to the following two conditions: (1) This device may not cause harmful interference, and (2) this device must accept any interference received, including interference that may cause undesired operation.

- (4) Where a device is constructed in two or more sections connected by wires and marketed together, the statement specified under paragraph (a) of this section is required to be affixed only to the main control unit.

- (5) When the device is so small or for such use that it is not practicable to place the statement specified under paragraph (a) of this section on it, the information required by this paragraph shall be placed in a prominent location in the instruction manual or pamphlet supplied to the user or, alternatively, shall be placed on the container in which the device is marketed. However, the FCC identifier or the unique identifier, as appropriate, must be displayed on the device.



§ 15.21 Information to user.

The users manual or instruction manual for an intentional or unintentional radiator shall caution the user that changes or modifications not expressly approved by the party responsible for compliance could void the user's authority to operate the equipment.

The following is extracted from Title 47 of the Code of Federal Regulations, Part 15, Subpart B — Unintentional Radiators:

§ 15.105 Information to the user.

- (a) For a Class B digital device or peripheral, the instructions furnished the user shall include the following or similar statement, placed in a prominent location in the text of the manual:

Note: This equipment has been tested and found to comply with the limits for a Class B digital device, pursuant to Part 15 of the FCC Rules. These limits are designed to provide reasonable protection against harmful interference when the equipment is operated in a residential environment. This equipment generates, uses, and can radiate radio frequency energy and, if not installed and used in accordance with the instruction manual, may cause harmful interference to radio communications. However, there is no guarantee that interference will not occur in a particular installation. If this equipment does cause harmful interference to radio or television reception, which can be determined by turning the equipment off and on, the user is encouraged to try to correct the interference by one or more of the following measures:

- Reorient or relocate the receiving antenna.
- Increase the separation between the equipment and receiver.
- Connect the equipment into an outlet on a circuit different from that to which the receiver is connected.
- Consult the dealer or an experienced radio/TV technician for help.



End of Report