

M/N: LBE-M5-23  
25V=0.2A POE

FCC ID: SWX-LBE5M  
IC: 6545A-LBE5M

MAC ID

[Redacted MAC ID field]



# LBE-M5-23



File Name: LiteBeam LBE-M5-23 Device Artwork v03  
 Date: 3/18/15 ME: Addison Su  
 Revision: v03 -- Tooling update PM: Natalie Ku  
 Designer: Vivian Liu Arena Number: 300-00223

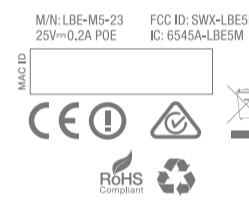
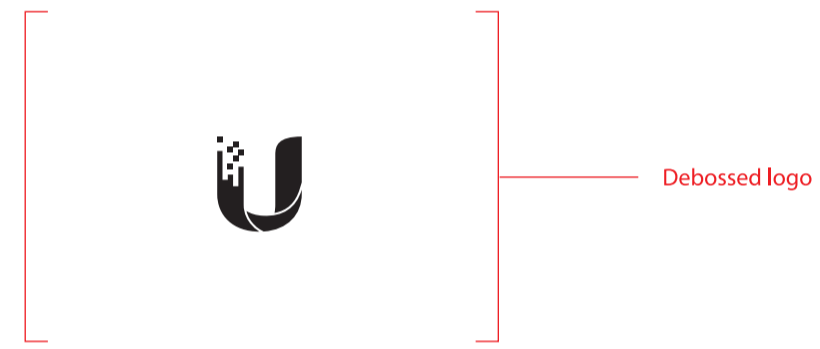
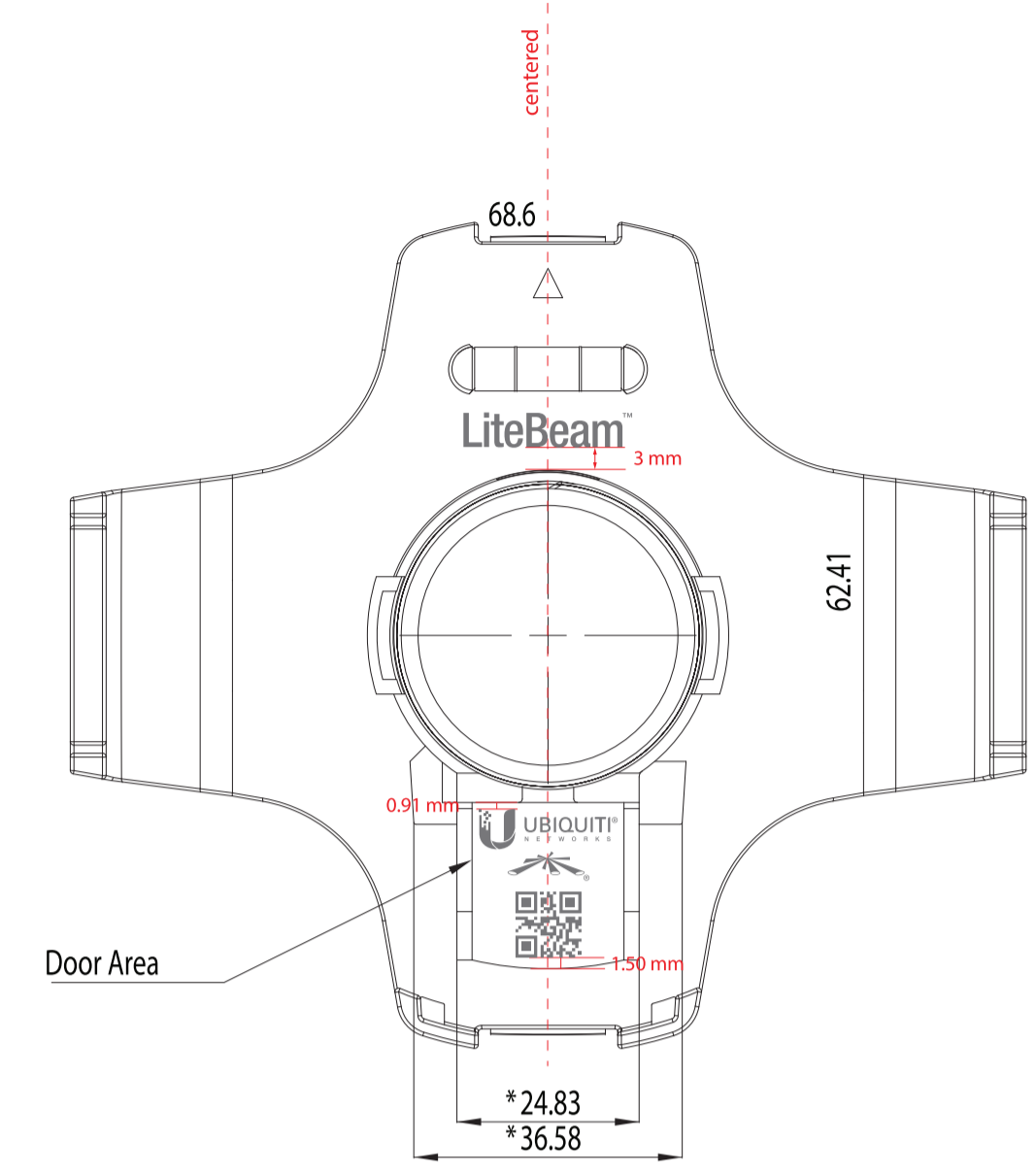
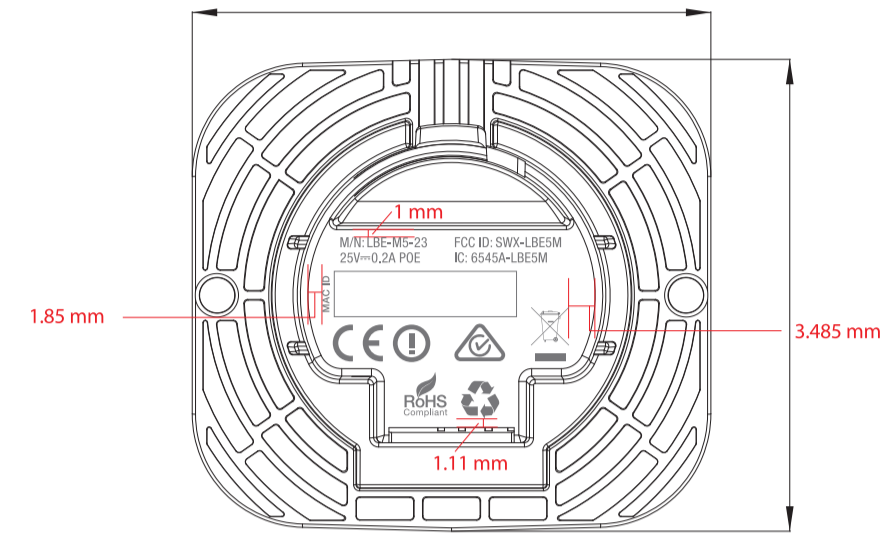
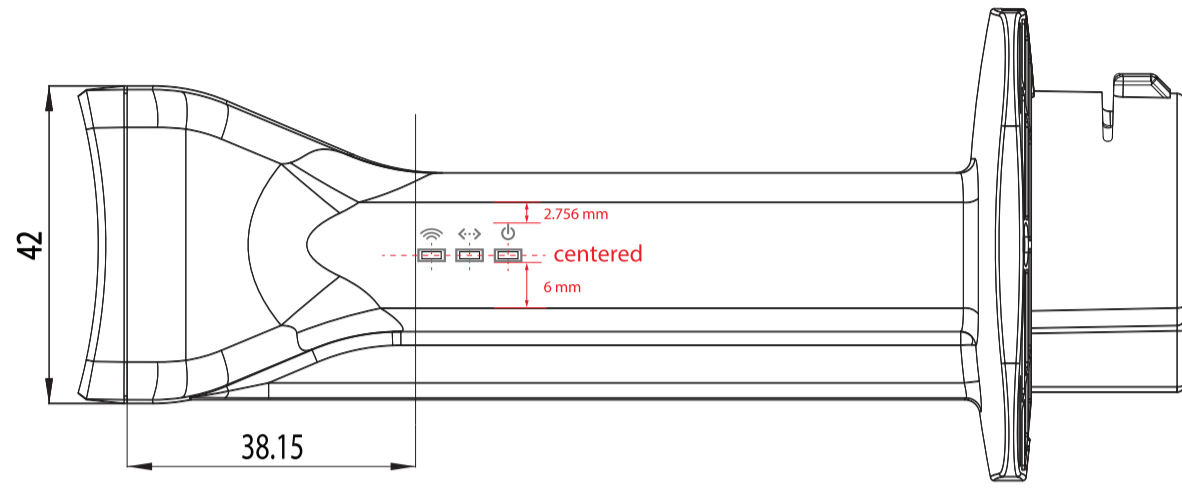
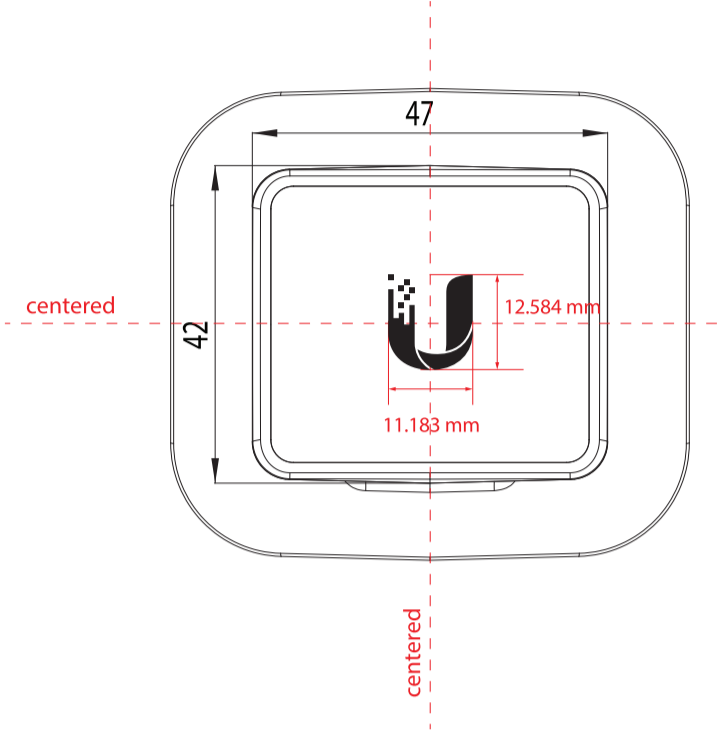
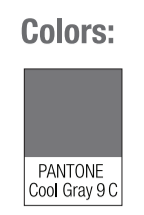

LiteBeam™



Pantone Cool Gray 9C

