



FCC RF Test Report

APPLICANT : Ubiquiti Network, Inc
EQUIPMENT : Access Point
BRAND NAME : UBIQUITI
MODEL NAME : LBE-5AC-16-120
FCC ID : SWX-LBE5AC120
STANDARD : FCC Part 15 Subpart C §15.247
CLASSIFICATION : (DTS) Digital Transmission System

The product was received on Jul. 06, 2015 and testing was completed on Jul. 20, 2015. We, SPORTON INTERNATIONAL INC., would like to declare that the tested sample has been evaluated in accordance with the test procedures and has been in compliance with the applicable technical standards.

The test results in this report apply exclusively to the tested model / sample. Without written approval of SPORTON INTERNATIONAL INC., the test report shall not be reproduced except in full.

Reviewed by: Joseph Lin / Supervisor

Approved by: Jones Tsai / Manager



SPORTON INTERNATIONAL INC.

No. 52, Hwa Ya 1st Rd., Hwa Ya Technology Park, Kwei-Shan District, Tao Yuan City, Taiwan, R.O.C.



TABLE OF CONTENTS

REVISION HISTORY 3

SUMMARY OF TEST RESULT 4

1 GENERAL DESCRIPTION 5

 1.1 Applicant 5

 1.2 Manufacturer 5

 1.3 Product Feature of Equipment Under Test 5

 1.4 Product Specification subjective to this standard 6

 1.5 Modification of EUT 6

 1.6 Testing Location 7

 1.7 Applicable Standards 8

2 TEST CONFIGURATION OF EQUIPMENT UNDER TEST 9

 2.1 Carrier Frequency and Channel 9

 2.2 Pre-Scanned RF Power 10

 2.3 Test Mode 11

 2.4 Connection Diagram of Test System 12

 2.5 Support Unit used in test configuration and system 13

 2.6 EUT Operation Test Setup 13

 2.7 Measurement Results Explanation Example 14

3 TEST RESULT 15

 3.1 6dB and 99% Bandwidth Measurement 15

 3.2 Peak Output Power Measurement 17

 3.3 Power Spectral Density Measurement 19

 3.4 Conducted Band Edges and Spurious Emission Measurement 21

 3.5 Radiated Band Edges and Spurious Emission Measurement 64

 3.6 AC Conducted Emission Measurement 69

 3.7 Antenna Requirements 73

4 LIST OF MEASURING EQUIPMENT 74

5 UNCERTAINTY OF EVALUATION 75

APPENDIX A. CONDUCTED TEST RESULTS

APPENDIX B. RADIATED TEST RESULTS

APPENDIX C. SETUP PHOTOGRAPHS



REVISION HISTORY

REPORT NO.	VERSION	DESCRIPTION	ISSUED DATE
FR570612	Rev. 01	Initial issue of report	Aug. 10, 2015



SUMMARY OF TEST RESULT

Report Section	FCC Rule	IC Rule	Description	Limit	Result	Remark
3.1	15.247(a)(2)	RSS-210 A8.2(a)	6dB Bandwidth	$\geq 0.5\text{MHz}$	Pass	-
3.1	-	RSS-Gen 6.6	99% Bandwidth	-	Pass	-
3.2	15.247(b)	RSS-210 A8.4	Power Output Measurement	$\leq 30\text{dBm}$	Pass	-
3.3	15.247(e)	RSS-210 A8.2(b)	Power Spectral Density	$\leq 8\text{dBm}/3\text{kHz}$	Pass	-
3.4	15.247(d)	RSS-210 A8.5	Conducted Band Edges	$\leq 20\text{dBc}$	Pass	-
			Conducted Spurious Emission		Pass	-
3.5	15.247(d)	RSS-210 A8.5	Radiated Band Edges and Radiated Spurious Emission	15.209(a) & 15.247(d)	Pass	Under limit 2.40 dB at 11470.000 MHz
3.6	15.207	RSS-Gen 8.8	AC Conducted Emission	15.207(a)	Pass	Under limit 13.60 dB at 0.510 MHz
3.7	15.203 & 15.247(b)	RSS-210 A8.4	Antenna Requirement	N/A	Pass	-



1 General Description

1.1 Applicant

Ubiquiti Network, Inc

12F, No. 105, Song Ren Rd., SinYi District, Taipei 110, Taiwan

1.2 Manufacturer

Ubiquiti Network, Inc

12F, No. 105, Song Ren Rd., SinYi District, Taipei 110, Taiwan

1.3 Product Feature of Equipment Under Test

Product Feature	
Equipment	Access Point
Brand Name	UBIQUITI
Model Name	LBE-5AC-16-120
FCC ID	SWX-LBE5AC120
EUT supports Radios application	WLAN 11ac VHT10/VHT20/VHT30/VHT40/VHT50/VHT60/VHT80
EUT Stage	Production Unit

Remark: The above EUT's information was declared by manufacturer. Please refer to the specifications or user's manual for more detailed description.



1.4 Product Specification subjective to this standard

Product Specification subjective to this standard							
Tx/Rx Channel Frequency Range	802.11ac: 5725~5850MHz.						
Maximum Output Power to antenna	MIMO<Ant. 1+2> 802.11ac VHT10 : 29.93 dBm (0.9840 W) 802.11ac VHT20 : 29.79 dBm (0.9528 W) 802.11ac VHT30 : 29.64 dBm (0.9204 W) 802.11ac VHT40 : 29.25 dBm (0.8414 W) 802.11ac VHT50 : 29.34 dBm (0.8590 W) 802.11ac VHT60 : 29.37 dBm (0.8650 W) 802.11ac VHT80 : 29.46 dBm (0.8831 W)						
99% Occupied Bandwidth	802.11ac VHT10 : 10.48MHz 802.11ac VHT20 : 19.02MHz 802.11ac VHT30 : 28.17MHz 802.11ac VHT40 : 37.02MHz 802.11ac VHT50 : 45.38MHz 802.11ac VHT60 : 55.53MHz 802.11ac VHT80 : 76.20MHz						
Antenna Type	802.11ac : Sector Antenna type with gain 16.00 dBi						
Type of Modulation	802.11ac : OFDM (BPSK / QPSK / 16QAM / 64QAM / 256QAM)						
FCC/IC fixed Point to Point classification	Point to Point						
Antenna Function for Transmitter	<table border="1"> <thead> <tr> <th></th> <th>Ant. 1</th> <th>Ant. 2</th> </tr> </thead> <tbody> <tr> <td>802.11 ac MIMO</td> <td>V</td> <td>V</td> </tr> </tbody> </table>		Ant. 1	Ant. 2	802.11 ac MIMO	V	V
	Ant. 1	Ant. 2					
802.11 ac MIMO	V	V					

1.5 Modification of EUT

No modifications are made to the EUT during all test items.



1.6 Testing Location

Sporton Lab is accredited to ISO 17025 by Taiwan Accreditation Foundation (TAF code : 1190) and the FCC designation No. TW1022 under the FCC 2.948(e) by Mutual Recognition Agreement (MRA) in FCC Test.

Test Site	SPORTON INTERNATIONAL INC.	
Test Site Location	No. 52, Hwa Ya 1 st Rd., Hwa Ya Technology Park, Kwei-Shan District, Tao Yuan City, Taiwan, R.O.C. TEL: +886-3-327-3456 FAX: +886-3-328-4978	
Test Site No.	Sporton Site No.	
	TH05-HY	CO05-HY

Test Site	SPORTON INTERNATIONAL INC.	
Test Site Location	No. 58, Aly. 75, Ln. 564, Wenhua 3rd Rd. Kwei-Shan District, Tao Yuan City, Taiwan, R.O.C. TEL: +886-3-327-0855	
Test Site No.	Sporton Site No.	
	03CH10-HY	

Note: The test site complies with ANSI C63.4 2009 requirement.



1.7 Applicable Standards

According to the specifications of the manufacturer, the EUT must comply with the requirements of the following standards:

- ♦ FCC Part 15 Subpart C §15.247
- ♦ FCC KDB Publication No. 558074 D01 DTS Meas. Guidance v03r03
- ♦ FCC KDB 662911 D01 Multiple Transmitter Output v02r01.
- ♦ FCC KDB 644545 D01 Guidance for IEEE 802 11ac Old Rules v01r02
- ♦ ANSI C63.10-2009

Remark:

1. All test items were verified and recorded according to the standards and without any deviation during the test.
2. FCC permits the use of the 1.5 meter table as an alternative in C63.10-2013 through inquiry tracking number 961829.
3. This EUT has also been tested and complied with the requirements of FCC Part 15, Subpart B, recorded in a separate test report.



2 Test Configuration of Equipment Under Test

The EUT has been associated with peripherals and configuration operated in a manner tended to maximize its emission characteristics in a typical application. Frequency range investigated: conducted emission (150 kHz to 30 MHz) and radiated emission (9 kHz to the 10th harmonic of the highest fundamental frequency or to 40 GHz, whichever is lower). For radiated measurement, pre-scanned in three orthogonal panels, X, Y, Z. The worst cases (Y plane) were recorded in this report.

The final configuration from all the combinations and the worst-case data rates were investigated by measuring the maximum power across all the data rates and modulation modes under section 2.2.

Based on the worst configuration found above, the RF power setting is set individually to meet FCC compliance limit for the final conducted and radiated tests shown in section 2.3.

2.1 Carrier Frequency and Channel

Frequency Band	Channel	Freq. (MHz)	Channel	Freq. (MHz)
5725-5850 MHz	147	5735	158	5790
	148	5740	159	5795
	149	5745	160	5800
	150	5750	161	5805
	151	5755	162	5810
	152	5760	163	5815
	153	5765	164	5820
	154	5770	165	5825
	155	5775	166	5830
	156	5780	167	5835
	157	5785	168	5840



2.2 Pre-Scanned RF Power

Preliminary tests were performed in different data rate and data rate associated with the highest power were chosen for full test shown in the following tables.

MIMO<Ant. 1+2>

5GHz 802.11ac VHT10 mode									
Data Rate (MHz)	MCS0	MCS1	MCS2	MCS3	MCS4	MCS5	MCS6	MCS7	MCS8
Peak Power (dBm)	29.93	29.87	29.92	29.91	29.16	29.90	29.86	29.87	29.76

5GHz 802.11ac VHT20 mode									
Data Rate (MHz)	MCS0	MCS1	MCS2	MCS3	MCS4	MCS5	MCS6	MCS7	MCS8
Peak Power (dBm)	29.79	29.74	29.73	29.75	29.74	29.59	29.76	29.24	29.41

5GHz 802.11ac VHT30 mode									
Data Rate (MHz)	MCS0	MCS1	MCS2	MCS3	MCS4	MCS5	MCS6	MCS7	MCS8
Peak Power (dBm)	29.64	29.27	29.52	29.40	29.56	29.39	29.04	29.28	29.35

5GHz 802.11ac VHT40 mode										
Data Rate (MHz)	MCS0	MCS1	MCS2	MCS3	MCS4	MCS5	MCS6	MCS7	MCS8	MCS9
Peak Power (dBm)	29.25	28.96	28.96	28.84	28.83	29.06	28.64	28.45	28.58	28.52

5GHz 802.11ac VHT50 mode										
Data Rate (MHz)	MCS0	MCS1	MCS2	MCS3	MCS4	MCS5	MCS6	MCS7	MCS8	MCS9
Peak Power (dBm)	29.34	28.38	28.58	28.47	28.52	28.73	28.33	28.22	28.32	28.42

5GHz 802.11ac VHT60 mode										
Data Rate (MHz)	MCS0	MCS1	MCS2	MCS3	MCS4	MCS5	MCS6	MCS7	MCS8	MCS9
Peak Power (dBm)	29.37	28.64	28.57	28.11	28.43	28.53	28.25	28.09	27.87	28.23

5GHz 802.11ac VHT80 mode										
Data Rate (MHz)	MCS0	MCS1	MCS2	MCS3	MCS4	MCS5	MCS6	MCS7	MCS8	MCS9
Peak Power (dBm)	29.46	29.00	28.87	29.22	29.28	29.03	29.06	29.27	29.19	29.18

Note: MIMO Ant. 1+2 is a calculated result from sum of the power MIMO Ant. 1 and MIMO Ant. 2.



2.3 Test Mode

Final test mode of conducted test items and radiated spurious emissions are considering the modulation and worse data rates from the power table described in section 2.2.

MIMO Antenna

<5GHz>

Modulation	Data Rate
802.11ac VHT10	MCS0
802.11ac VHT20	MCS0
802.11ac VHT30	MCS0
802.11ac VHT40	MCS0
802.11ac VHT50	MCS0
802.11ac VHT60	MCS0
802.11ac VHT80	MCS0

Test Cases	
AC Conducted Emission	Mode 1 : WLAN Link + PoE + RJ45 Link

2.4 Connection Diagram of Test System

<WLAN Tx Mode>

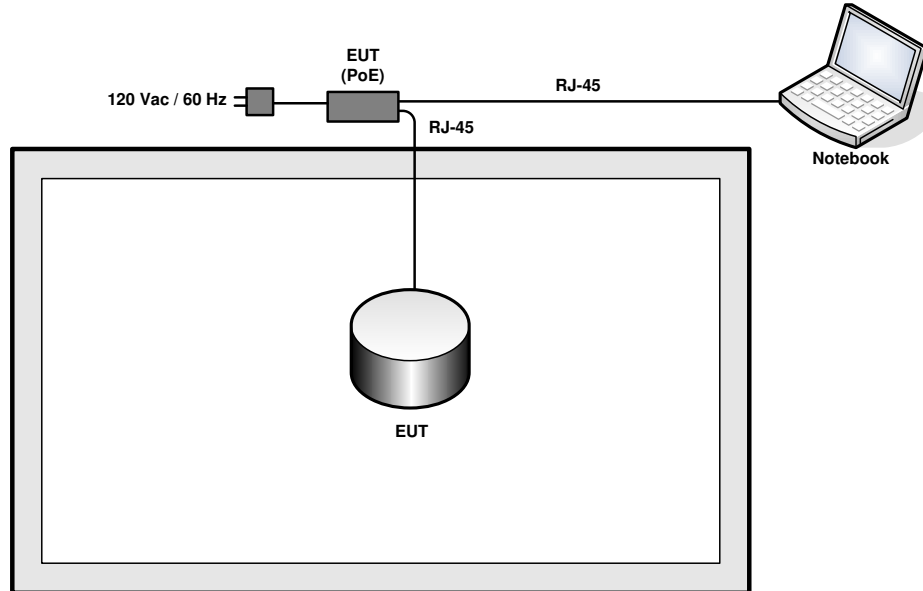

<AC Conducted Emission Mode>

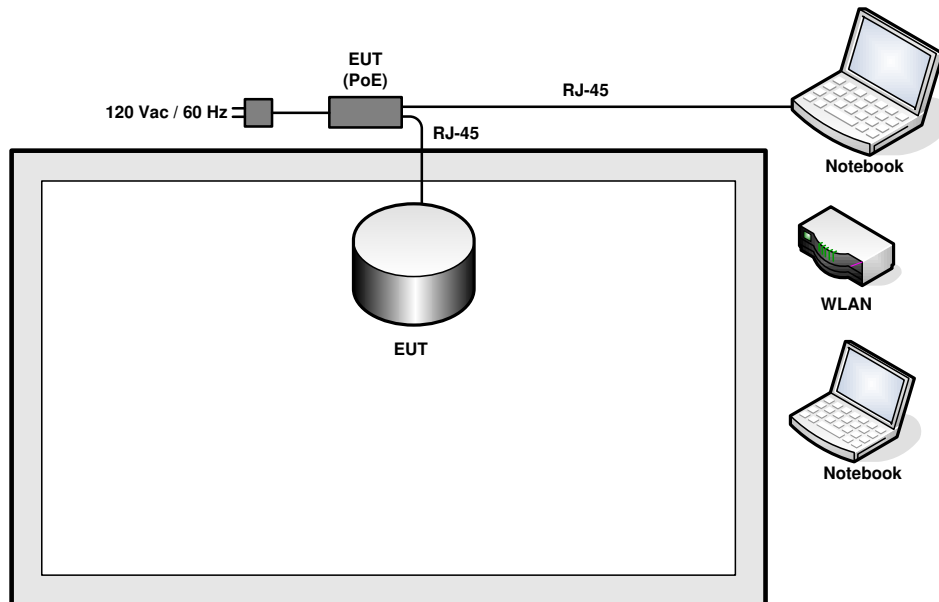



2.5 Support Unit used in test configuration and system

Item	Equipment	Trade Name	Model Name	FCC ID	Data Cable	Power Cord
1.	Notebook	DELL	Latitude E6320	FCC DoC/ Contains FCC ID: QDS-BRCM1054	N/A	AC I/P: Unshielded, 1.2 m DC O/P: Shielded, 1.8 m
2.	Notebook	DELL	P20G	FCC DoC/ Contains FCC ID:QDS-BRCM1051	N/A	AC I/P: Unshielded, 1.2 m DC O/P: Shielded, 1.8 m
3.	AP	Ubiquiti	NBE-5AC-16	SWX-NBE5AC16	N/A	N/A

2.6 EUT Operation Test Setup

The programmed RF utility “Cart tool”, is installed in EUT to provide channel selection, power level, data rate and the application type. RF Utility can send transmitting signal for all testing. The RF output power selection is for the setting of RF output power expected by the customer and is going to be fixed on the firmware of the final end product.



2.7 Measurement Results Explanation Example

For all conducted test items:

The offset level is set in the spectrum analyzer to compensate the RF cable loss and attenuator factor between EUT conducted output port and spectrum analyzer. With the offset compensation, the spectrum analyzer reading level is exactly the EUT RF output level.

Example:

The spectrum analyzer offset is derived from RF cable loss and attenuator factor.

Offset = RF cable loss + attenuator factor.

Following shows an offset computation example with cable loss 4.2 dB and 10dB attenuator.

$$\begin{aligned} \text{Offset(dB)} &= \text{RF cable loss(dB)} + \text{attenuator factor(dB)}. \\ &= 4.2 + 10 = 14.2 \text{ (dB)} \end{aligned}$$

3 Test Result

3.1 6dB and 99% Bandwidth Measurement

3.1.1 Limit of 6dB and 99% Bandwidth

The minimum 6 dB bandwidth shall be at least 500 kHz.

3.1.2 Measuring Instruments

The measuring equipment is listed in the section 4 of this test report.

3.1.3 Test Procedures

1. The testing follows FCC KDB Publication No. 558074 DTS D01 Meas. Guidance v03r02
2. The RF output of EUT was connected to the spectrum analyzer by RF cable and attenuator. The path loss was compensated to the results for each measurement.
3. Set to the maximum power setting and enable the EUT transmit continuously.
4. Make the measurement with the spectrum analyzer's resolution bandwidth (RBW) = 100 kHz. Set the Video bandwidth (VBW) = 300 kHz. In order to make an accurate measurement. The 6 dB bandwidth must be greater than 500 kHz.
5. For 99% Bandwidth Measurement, the spectrum analyzer's resolution bandwidth (RBW) = 1MHz and set the Video bandwidth (VBW) = 3MHz.
6. Measure and record the results in the test report.

3.1.4 Test Setup

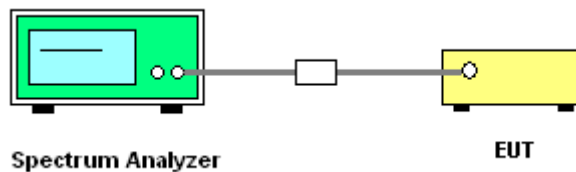



3.1.5 Test Result of 6dB and 99% Occupied Bandwidth

Please refer to Appendix A of this report.

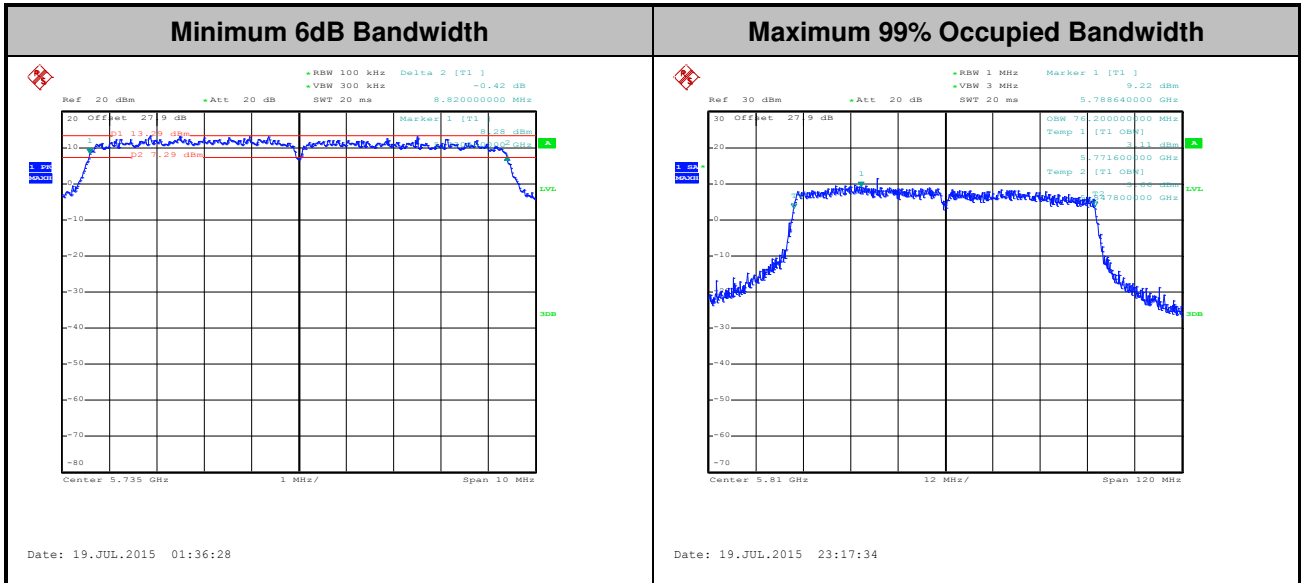

Note : The occupied channel bandwidth is maintained within the band of operation for all of the modulations.

3.2 Peak Output Power Measurement

3.2.1 Limit of Peak Output Power

For systems using digital modulation in the 5725-5850MHz band that are used exclusively for fixed, point-to-point operations may employ transmitting antennas with directional gain greater than 6 dBi without any corresponding reduction in transmitter conducted output power.

3.2.2 Measuring Instruments

The measuring equipment is listed in the section 4 of this test report.

3.2.3 Test Procedures

1. The testing follows the Measurement Procedure of FCC KDB No. 558074 DTS D01 Meas. Guidance v03r02.
2. The RF output of EUT was connected to the power meter by RF cable and attenuator. The path loss was compensated to the results for each measurement.
3. Set to the maximum power setting and enable the EUT transmit continuously.
4. Measure the conducted output power and record the results in the test report.
5. For MIMO mode, calculation method follows FCC KDB 662911 D01 Multiple Transmitter Output v02r01.

3.2.4 Test Setup

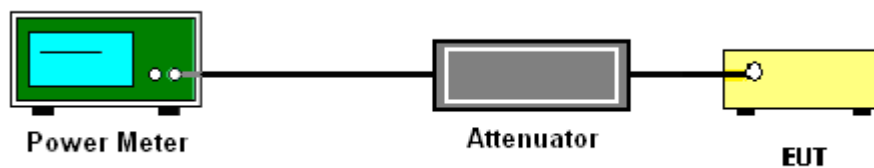



3.2.5 Test Result of Peak Output Power

Please refer to Appendix A of this report.

3.2.6 Test Result of Average output Power (Reporting Only)

Please refer to Appendix A of this report.



3.3 Power Spectral Density Measurement

3.3.1 Limit of Power Spectral Density

The peak power spectral density shall not be greater than 8dBm in any 3kHz band at any time interval of continuous transmission. The same method of determining the conducted output power shall be used to determine the power spectral density.

3.3.2 Measuring Instruments

The measuring equipment is listed in the section 4 of this test report.

3.3.3 Test Procedures

1. The testing follows Measurement Procedure 10.2 Method PKPSD of FCC KDB Publication No. 558074 D01 DTS Meas. Guidance v03r02
2. The RF output of EUT was connected to the spectrum analyzer by RF cable and attenuator. The path loss was compensated to the results for each measurement.
3. Set to the maximum power setting and enable the EUT transmit continuously.
4. Make the measurement with the spectrum analyzer's resolution bandwidth (RBW) = 3 kHz. Video bandwidth VBW = 10 kHz In order to make an accurate measurement, set the span to 1.5 times DTS Channel Bandwidth. (6dB BW)
5. Detector = peak, Sweep time = auto couple, Trace mode = max hold, Allow trace to fully stabilize. Use the peak marker function to determine the maximum power level.
6. Measure and record the results in the test report.
7. For MIMO mode, calculation method follows FCC KDB 662911 D01 Multiple Transmitter Output v02r01.

If measurements performed using method (2) plus $10 \log(N)$ exceeds the emission limit, the test should choose method (1) before declaring that the device fails the emission limit.

Method (1): Measure and sum the spectra across the outputs.

The total final Power Spectral Density is from a device with 2 transmitter outputs. The spectrum measurements of the individual outputs are all performed with the same span and number of points, the spectrum value in the first spectral bin of output 1 is summed with that in the first spectral bin of output 2 to obtain the value for the first frequency bin of the summed spectrum.

Method (2): Measure and add $10 \log(N)$ dB, where N is the number of outputs. (N=2)

3.3.4 Test Setup

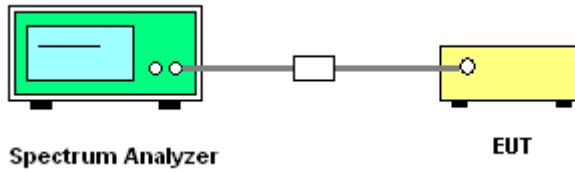

3.3.5 Test Result of Power Spectral Density

Please refer to Appendix A of this report.

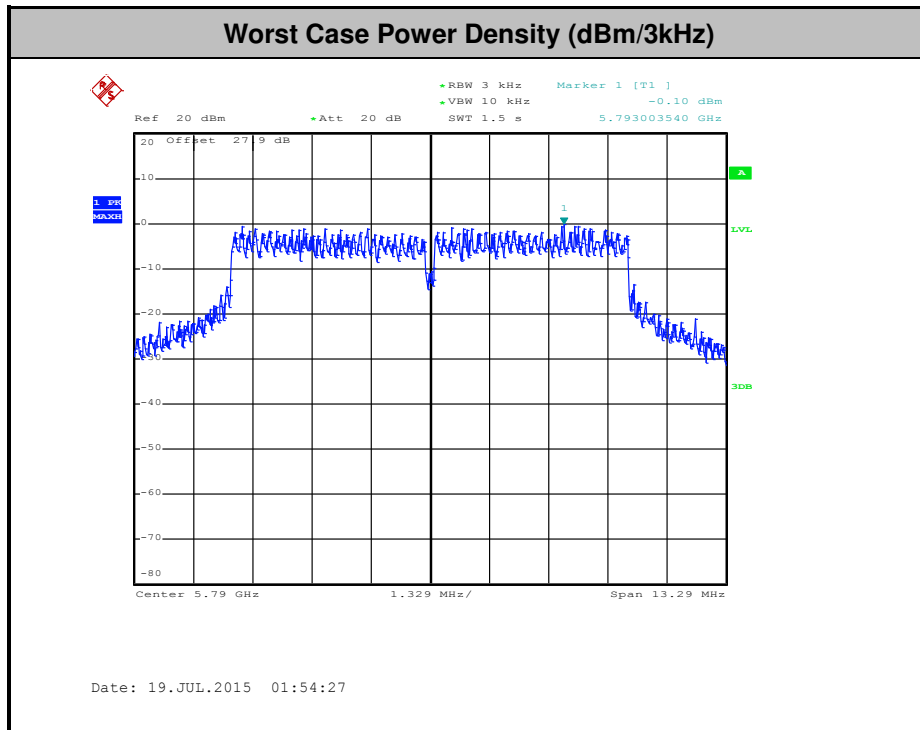

3.4 Conducted Band Edges and Spurious Emission Measurement

3.4.1 Limit of Conducted Band Edges and Spurious Emission Measurement

In any 100 kHz bandwidth outside of the authorized frequency band, the emissions which fall in the non-restricted bands shall be attenuated at least 20 dB / 30dB relative to the maximum PSD level in 100 kHz by RF conducted measurement and radiated emissions which fall in the restricted bands, as defined in Section 15.205(a), must also comply with the radiated emission limits specified in Section 15.209(a).

3.4.2 Measuring Instruments

The measuring equipment is listed in the section 4 of this test report.

3.4.3 Test Procedures

1. The testing follows FCC KDB Publication No. 558074 D01 DTS Meas. Guidance v03r02.
2. The RF output of EUT was connected to the spectrum analyzer by RF cable and attenuator. The path loss was compensated to the results for each measurement.
3. Set to the maximum power setting and enable the EUT transmit continuously.
4. Set RBW = 100 kHz, VBW=300 kHz, Peak Detector. Unwanted Emissions measured in any 100 kHz bandwidth outside of the authorized frequency band shall be attenuated by at least 20 dB relative to the maximum in-band peak PSD level in 100 kHz when maximum peak conducted output power procedure is used. If the transmitter complies with the conducted power limits based on the use of RMS averaging over a time interval, the attenuation required under this paragraph shall be 30 dB instead of 20 dB per 15.247(d).
5. Measure and record the results in the test report.
6. The RF fundamental frequency should be excluded against the limit line in the operating frequency band.

3.4.4 Test Setup

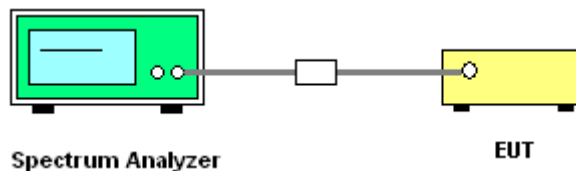



3.4.5 Test Result of Conducted Band Edges and Spurious Emission

Number of TX = 2, Ant. 1 (Measured)

Number of TX :	2	Ant. :	1
Test Mode :	802.11ac VHT10	Temperature :	23~26°C
Test Band :	5GHz Low	Relative Humidity :	45~54%
Test Channel :	147	Test Engineer :	Osolemio Chang

WLAN 802.11ac VHT10 Channel 147

100kHz PSD reference Level

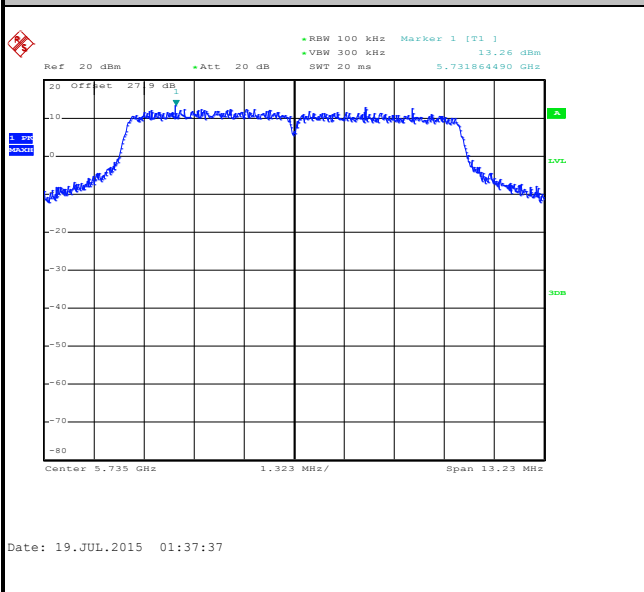

Low Channel Plot

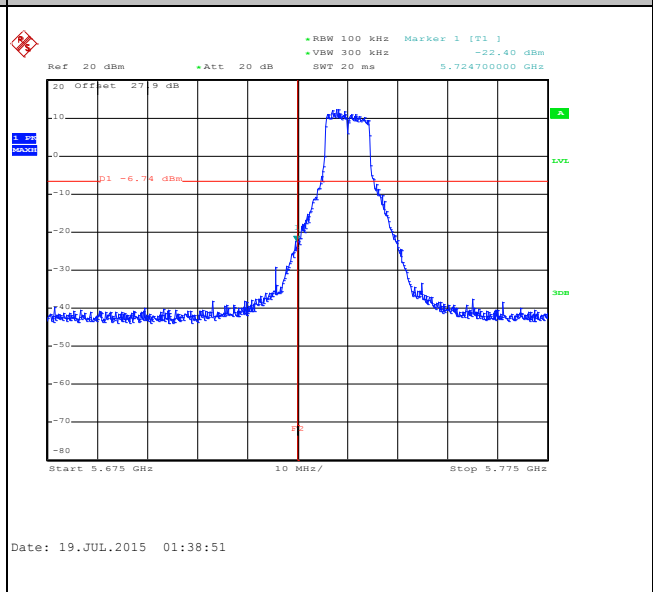

Spurious Emission 30MHz~3GHz

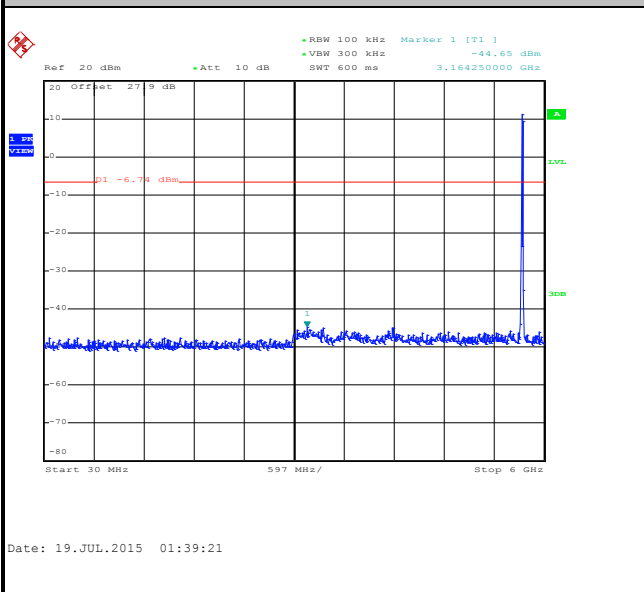

Spurious Emission 2GHz~25GHz

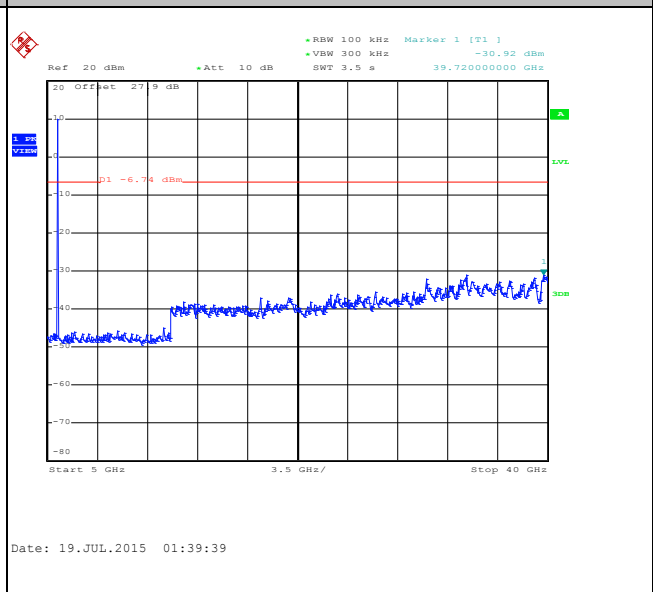



Number of TX :	2	Ant. :	1
Test Mode :	802.11ac VHT10	Temperature :	23~26°C
Test Band :	5GHz Low	Relative Humidity :	45~54%
Test Channel :	158	Test Engineer :	Osolemio Chang

WLAN 802.11ac VHT20 Channel 158

100kHz PSD reference Level

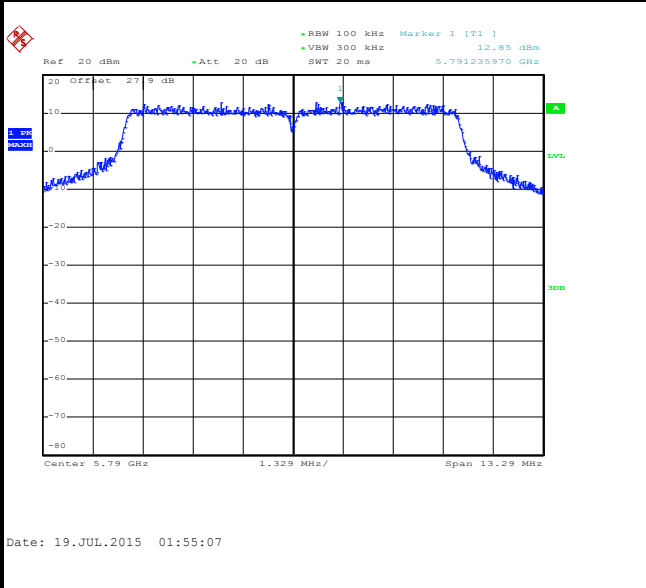

Spurious Emission 30MHz~3GHz

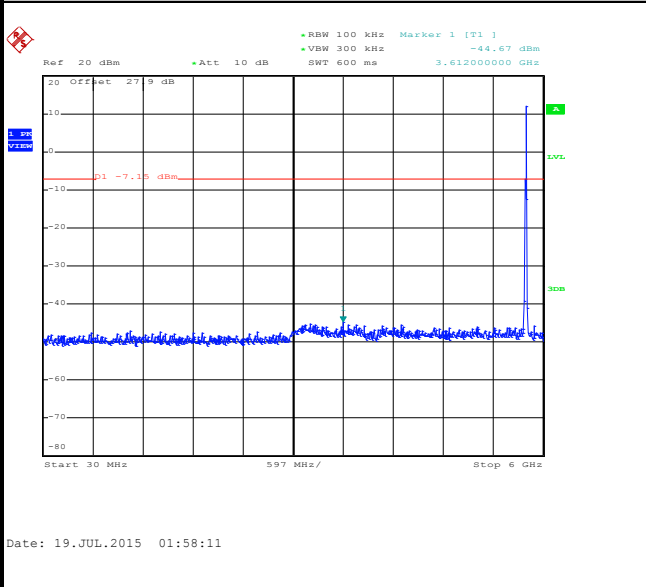

Spurious Emission 2GHz~25GHz

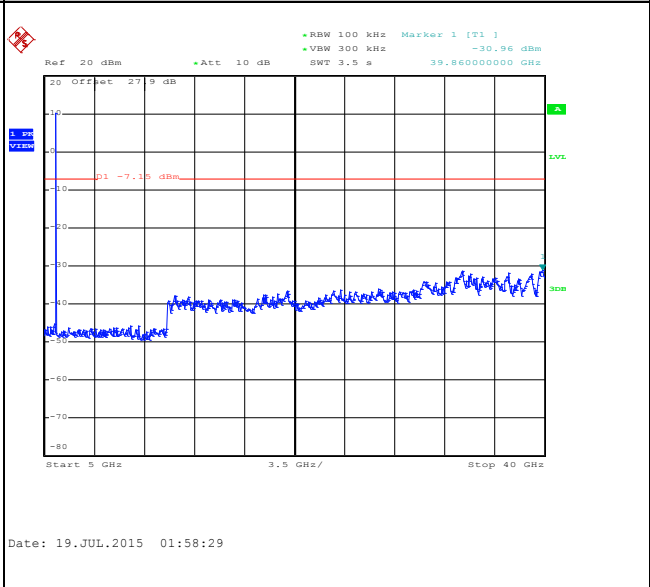



Number of TX :	2	Ant. :	1
Test Mode :	802.11ac VHT10	Temperature :	23~26°C
Test Band :	5GHz Low	Relative Humidity :	45~54%
Test Channel :	168	Test Engineer :	Osolemio Chang

WLAN 802.11ac VHT10 Channel 168

100kHz PSD reference Level

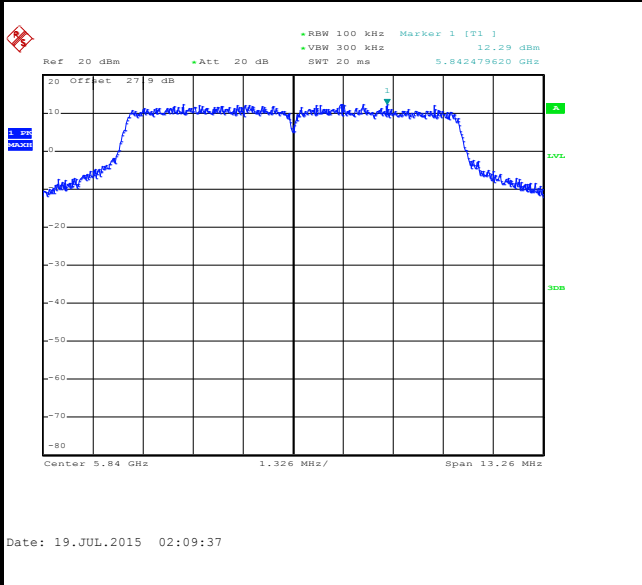

High Channel Plot

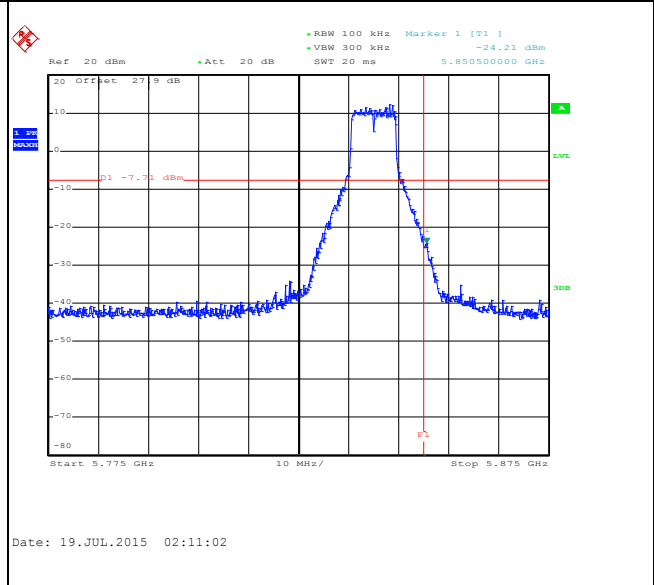

Spurious Emission 30MHz~3GHz

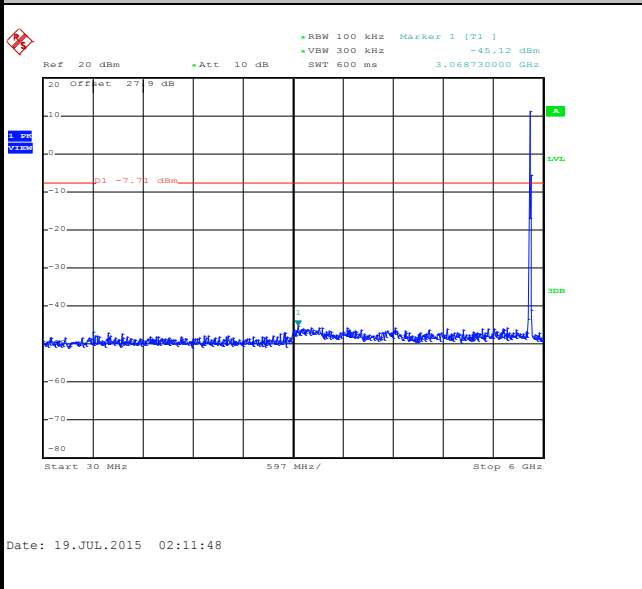

Spurious Emission 2GHz~25GHz

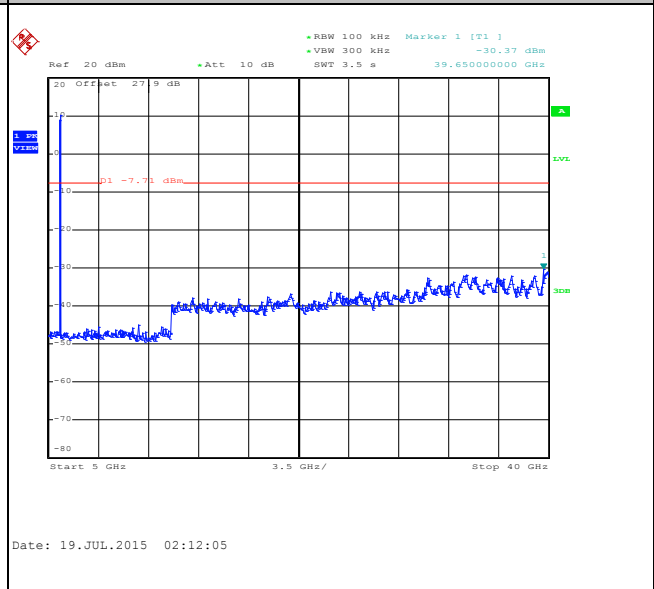



Number of TX :	2	Ant. :	1
Test Mode :	802.11ac VHT20	Temperature :	23~26°C
Test Band :	5GHz Low	Relative Humidity :	45~54%
Test Channel :	148	Test Engineer :	Osolemio Chang

WLAN 802.11ac VHT20 Channel 148

100kHz PSD reference Level

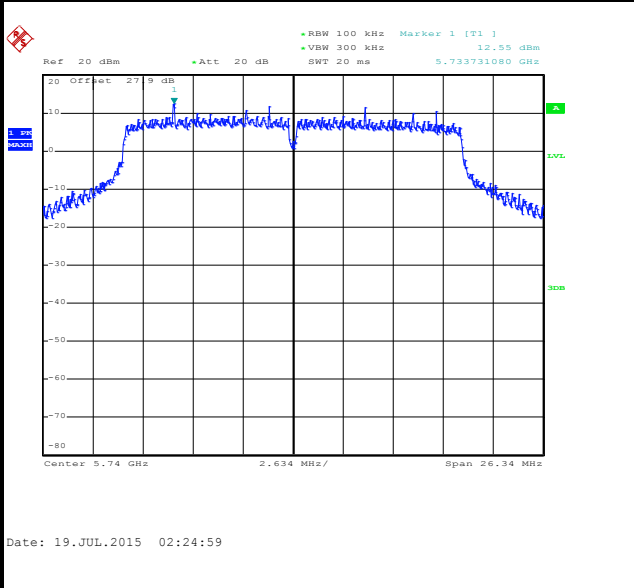

Low Channel Plot

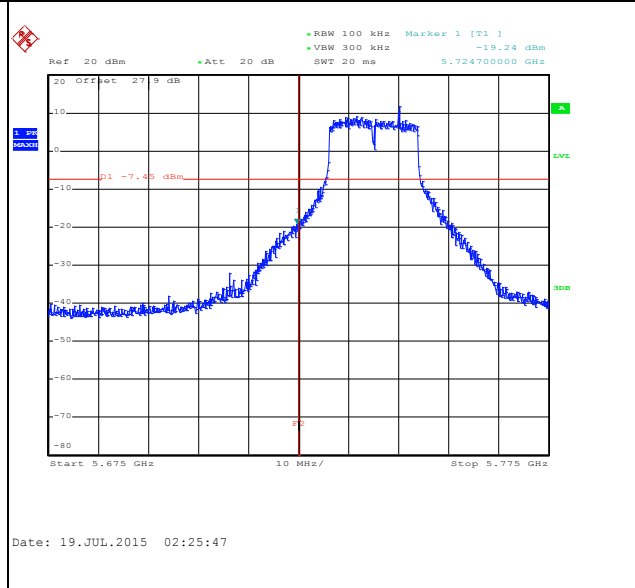

Spurious Emission 30MHz~3GHz

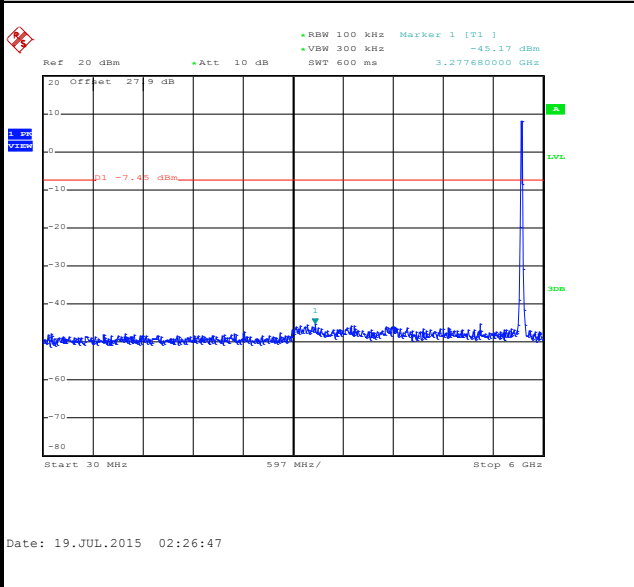

Spurious Emission 2GHz~25GHz

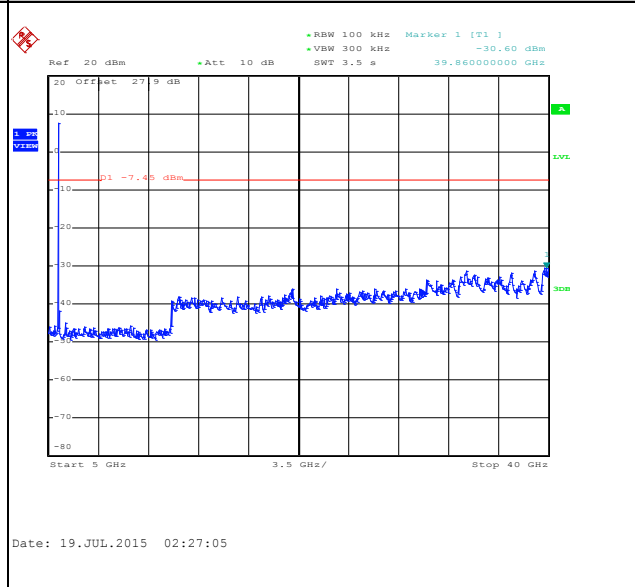



Number of TX :	2	Ant. :	1
Test Mode :	802.11ac VHT40	Temperature :	23~26°C
Test Band :	5GHz Low	Relative Humidity :	45~54%
Test Channel :	158	Test Engineer :	Osolemio Chang

WLAN 802.11ac VHT20 Channel 158

100kHz PSD reference Level

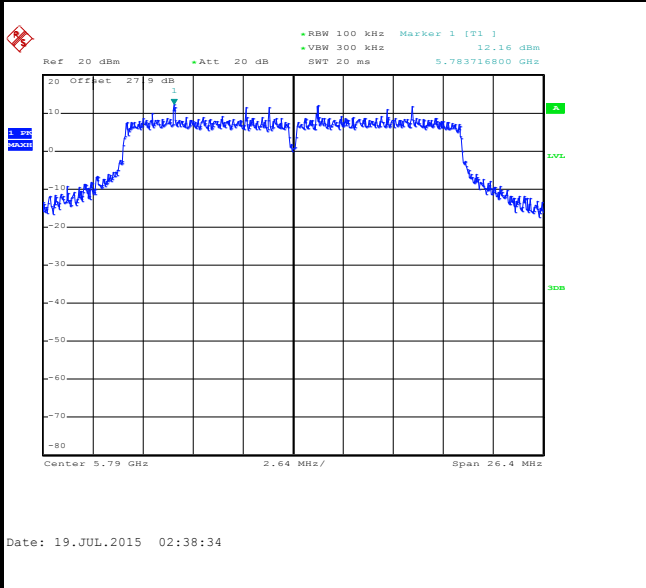

Spurious Emission 30MHz~3GHz

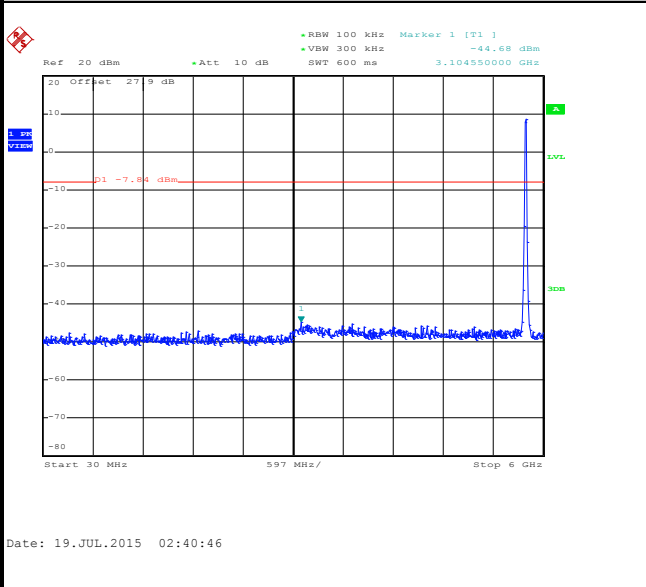

Spurious Emission 2GHz~25GHz

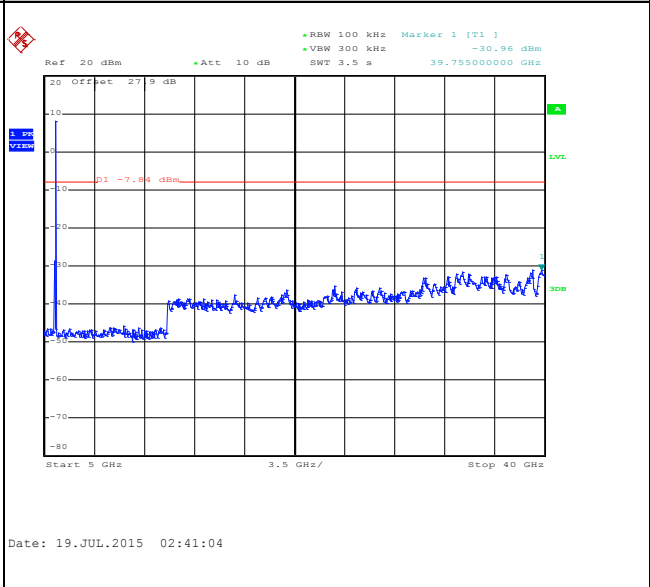



Number of TX :	2	Ant. :	1
Test Mode :	802.11ac VHT20	Temperature :	23~26°C
Test Band :	5GHz Low	Relative Humidity :	45~54%
Test Channel :	167	Test Engineer :	Osolemio Chang

WLAN 802.11ac VHT20 Channel 167

100kHz PSD reference Level

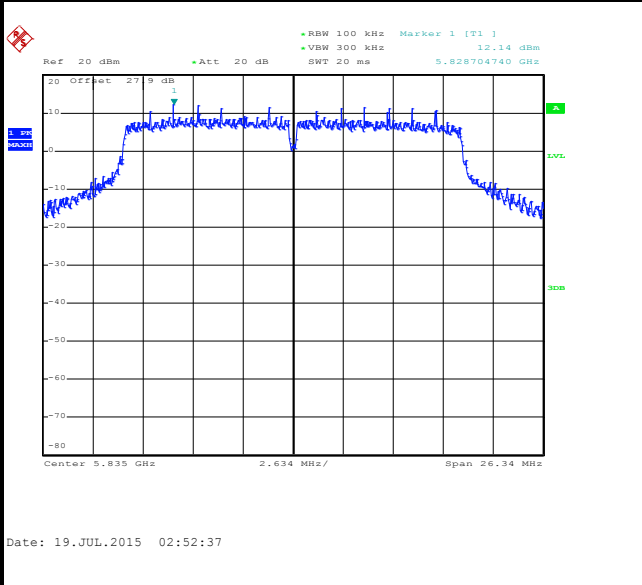

High Channel Plot

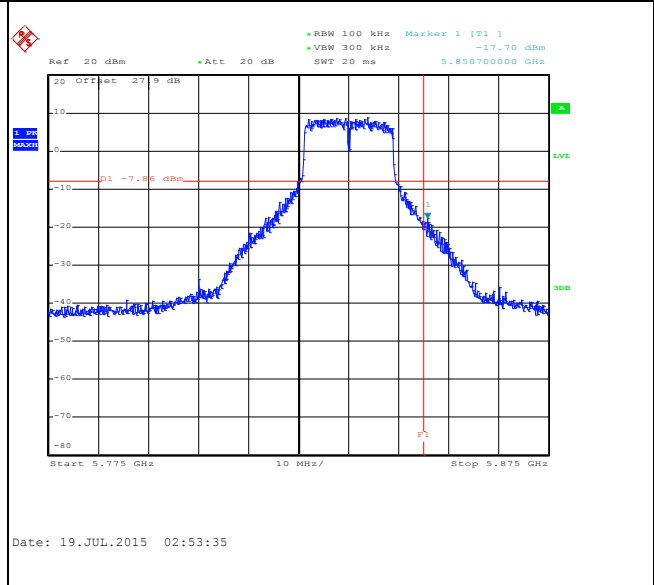

Spurious Emission 30MHz~3GHz

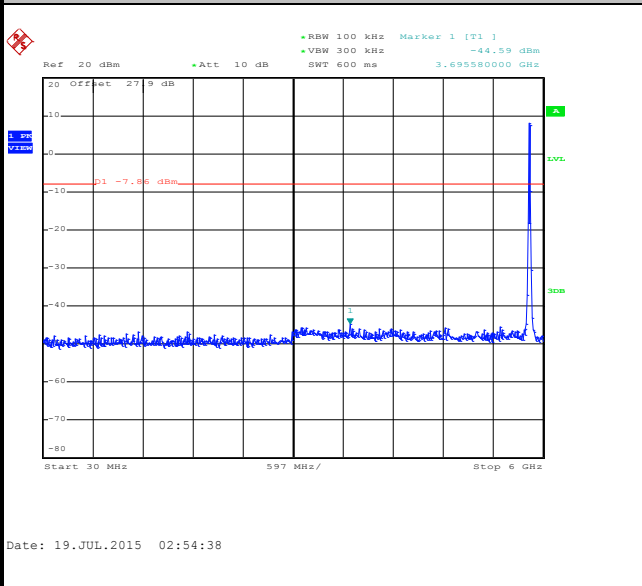

Spurious Emission 2GHz~25GHz

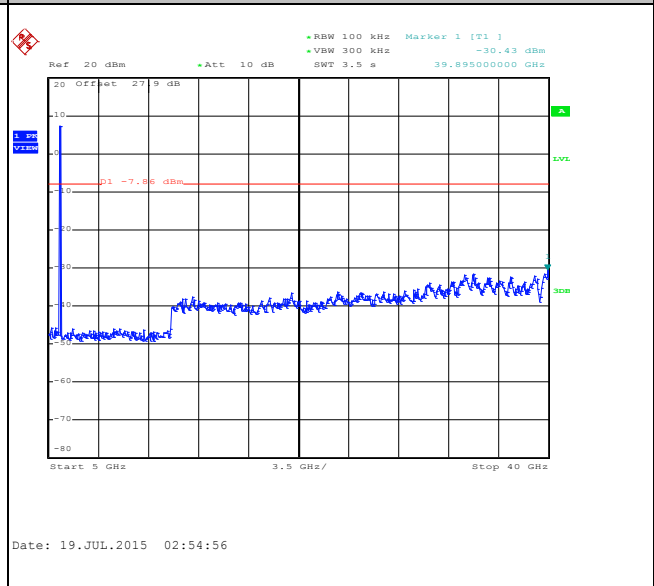



Number of TX :	2	Ant. :	1
Test Mode :	802.11ac VHT30	Temperature :	23~26°C
Test Band :	5GHz Low	Relative Humidity :	45~54%
Test Channel :	149	Test Engineer :	Osolemio Chang

WLAN 802.11ac VHT30 Channel 149

100kHz PSD reference Level

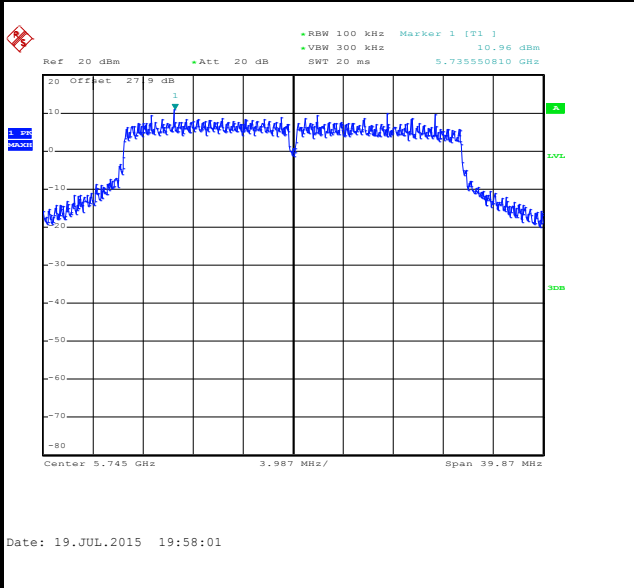

Low Channel Plot

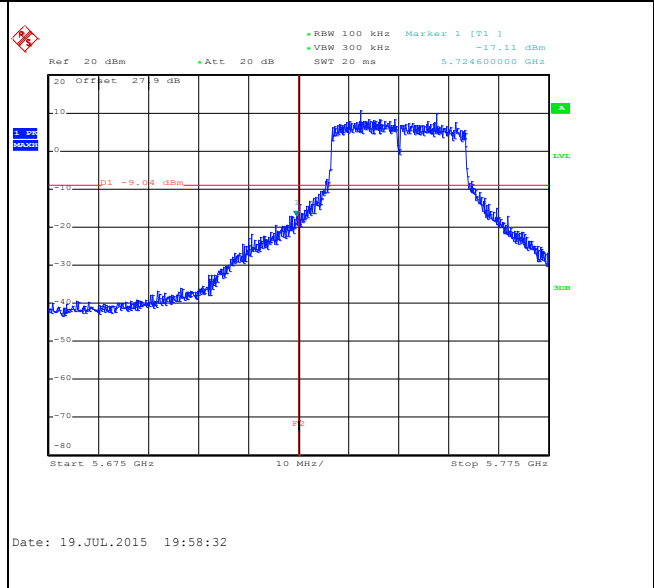

Spurious Emission 30MHz~3GHz

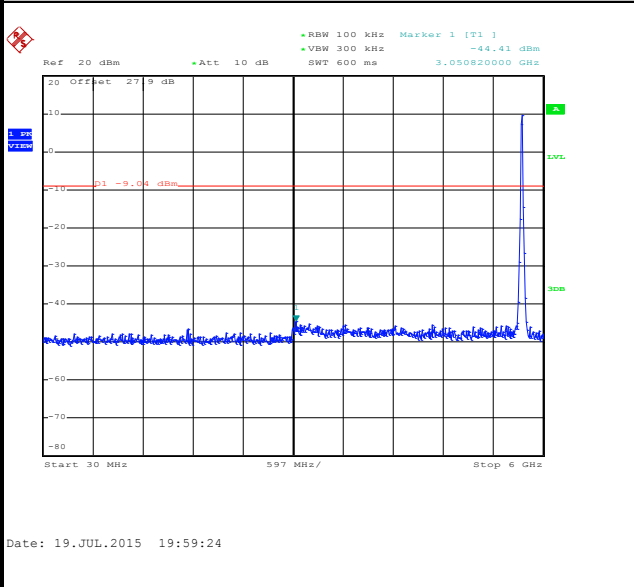

Spurious Emission 2GHz~25GHz

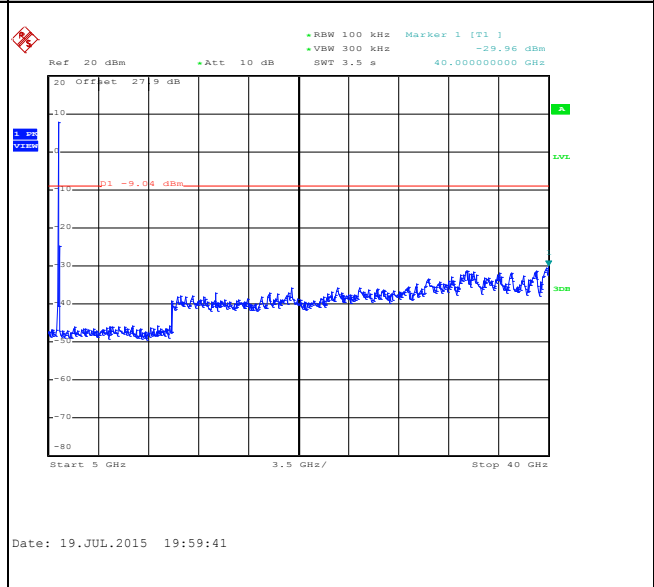



Number of TX :	2	Ant. :	1
Test Mode :	802.11ac VHT30	Temperature :	23~26°C
Test Band :	5GHz Low	Relative Humidity :	45~54%
158	06	Test Engineer :	Osolemio Chang

WLAN 802.11ac VHT30 Channel 158

100kHz PSD reference Level

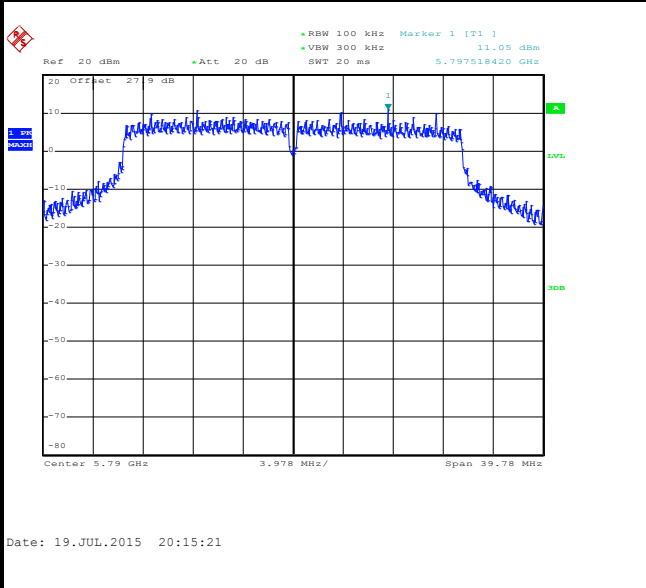

Spurious Emission 30MHz~3GHz

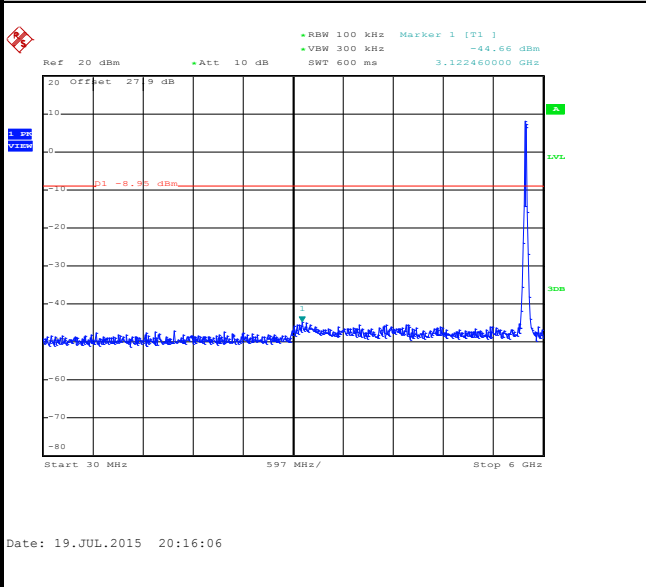

Spurious Emission 2GHz~25GHz

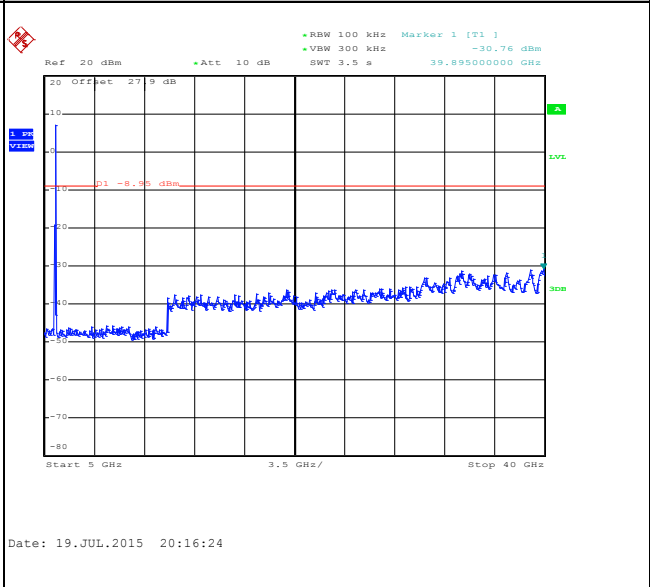



Number of TX :	2	Ant. :	1
Test Mode :	802.11ac VHT30	Temperature :	23~26°C
Test Band :	5GHz Low	Relative Humidity :	45~54%
Test Channel :	166	Test Engineer :	Osolemio Chang

WLAN 802.11ac VHT30 Channel 166

100kHz PSD reference Level

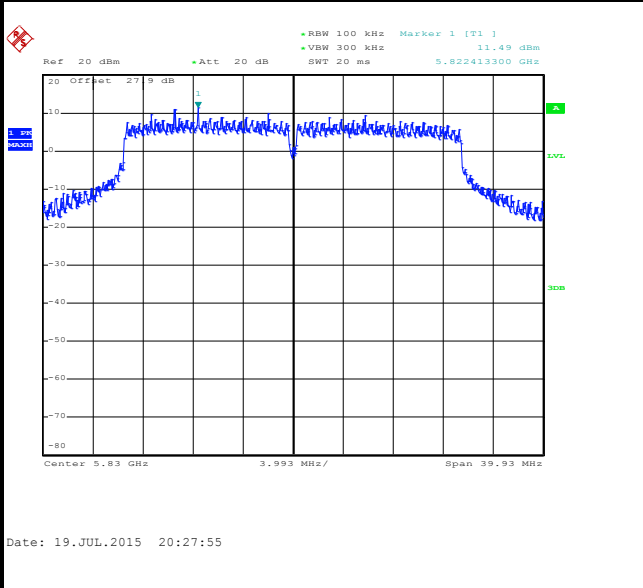

High Channel Plot

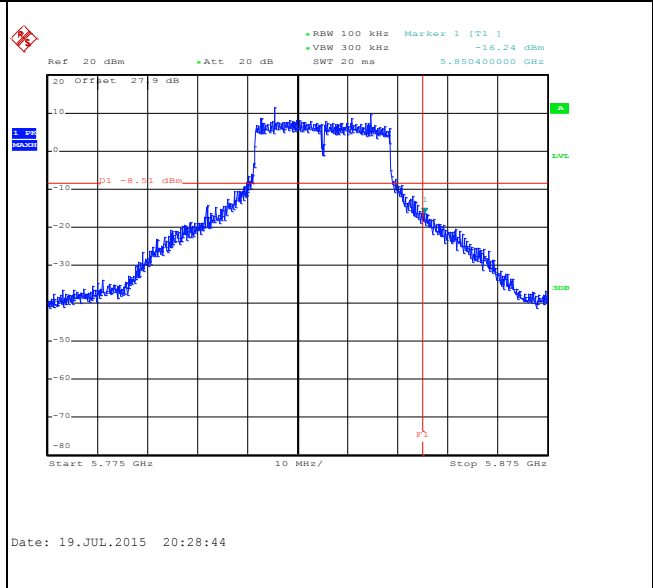

Spurious Emission 30MHz~3GHz

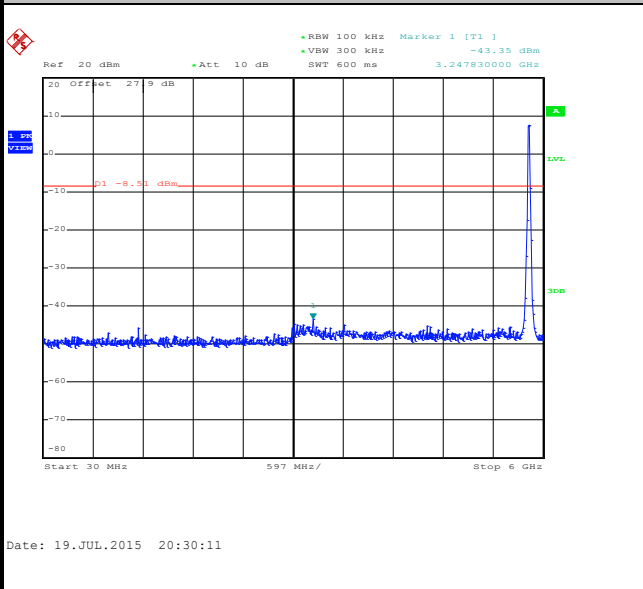

Spurious Emission 2GHz~25GHz

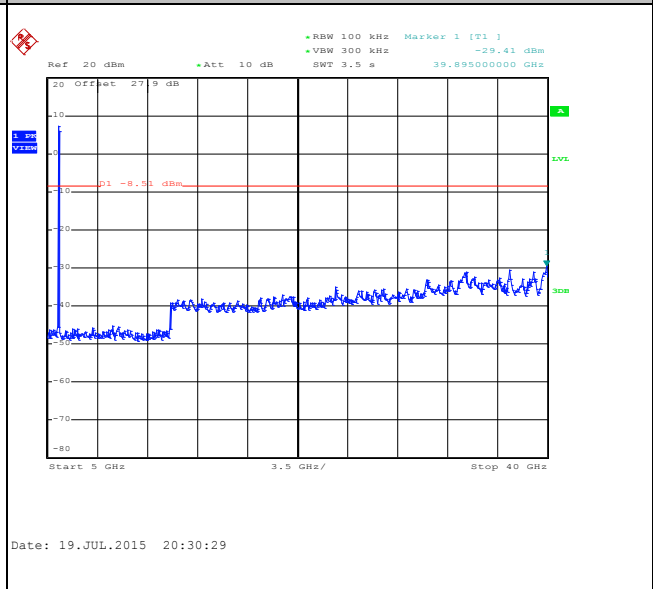



Number of TX :	2	Ant. :	1
Test Mode :	802.11ac VHT40	Temperature :	23~26°C
Test Band :	5GHz Low	Relative Humidity :	45~54%
Test Channel :	150	Test Engineer :	Osolemio Chang

WLAN 802.11ac VHT40 Channel 150

100kHz PSD reference Level

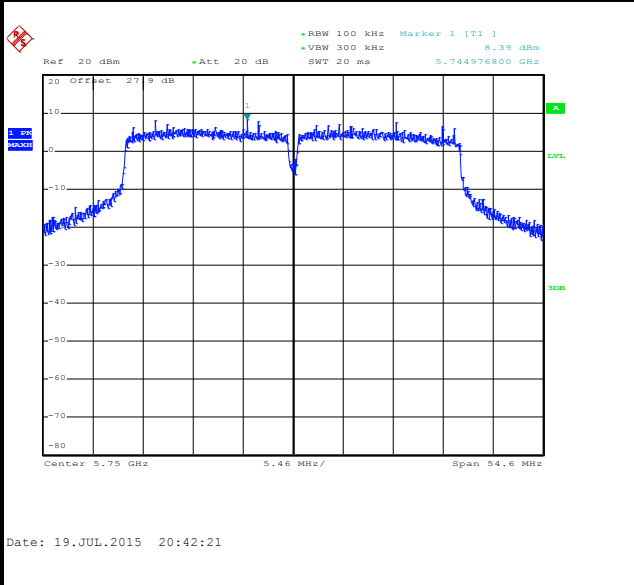

Low Channel Plot

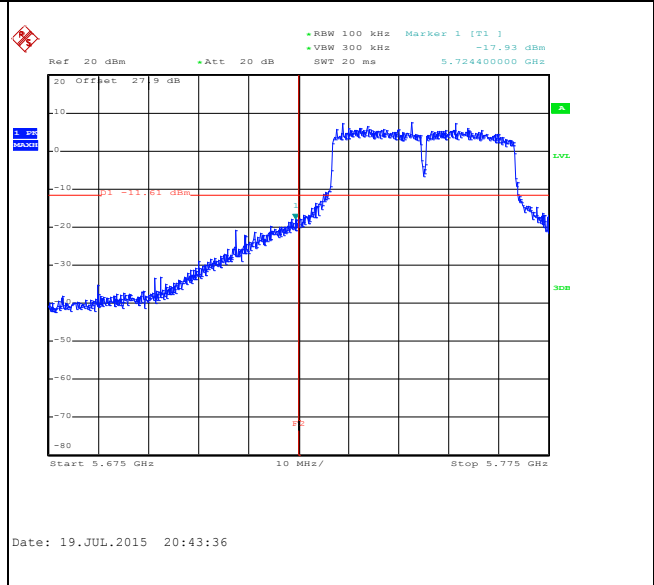

Spurious Emission 30MHz~3GHz

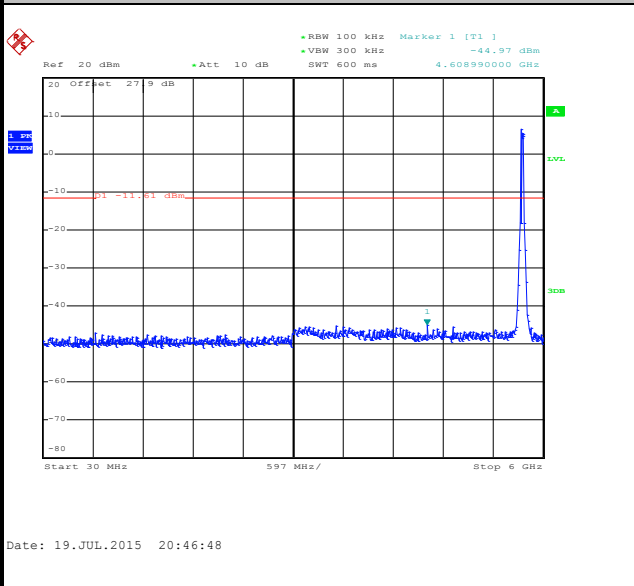

Spurious Emission 2GHz~25GHz

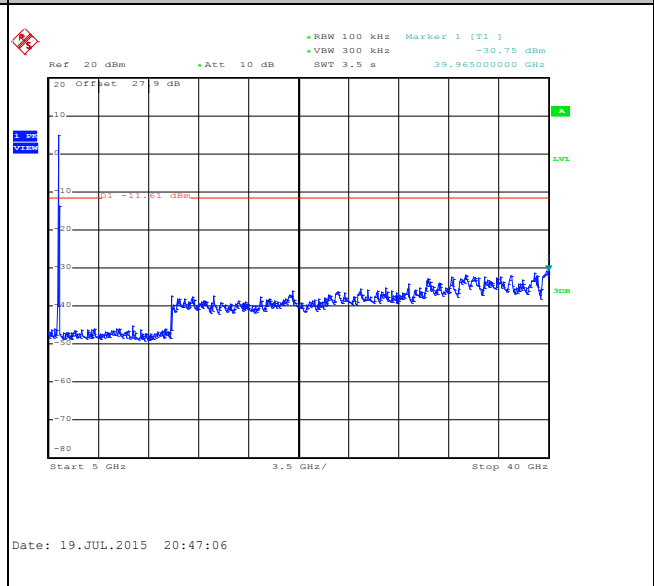



Number of TX :	2	Ant. :	1
Test Mode :	802.11ac VHT40	Temperature :	23~26°C
Test Band :	5GHz Low	Relative Humidity :	45~54%
Test Channel :	158	Test Engineer :	Osolemio Chang

WLAN 802.11ac VHT40 Channel 158

100kHz PSD reference Level

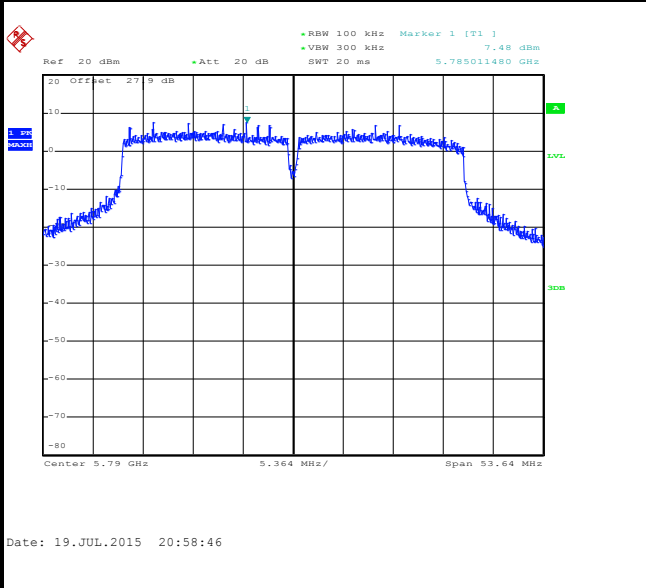

Spurious Emission 30MHz~3GHz

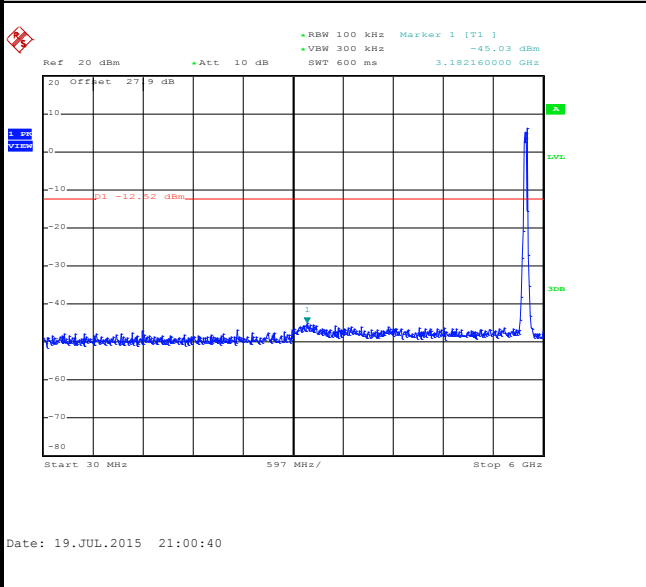

Spurious Emission 2GHz~25GHz

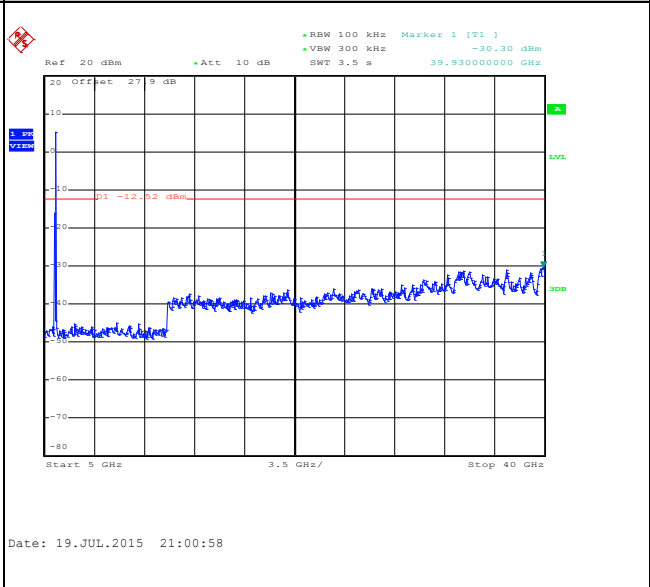



Number of TX :	2	Ant. :	1
Test Mode :	802.11ac VHT40	Temperature :	23~26°C
Test Band :	5GHz Low	Relative Humidity :	45~54%
Test Channel :	165	Test Engineer :	Osolemio Chang

WLAN 802.11ac VHT40 Channel 165

100kHz PSD reference Level

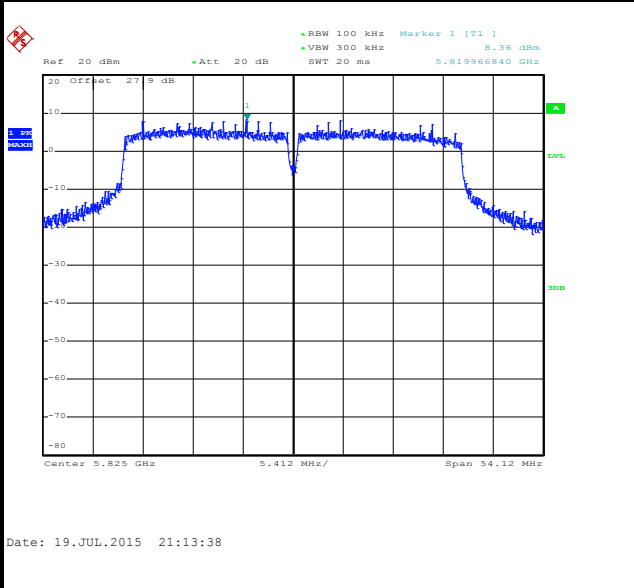

High Channel Plot

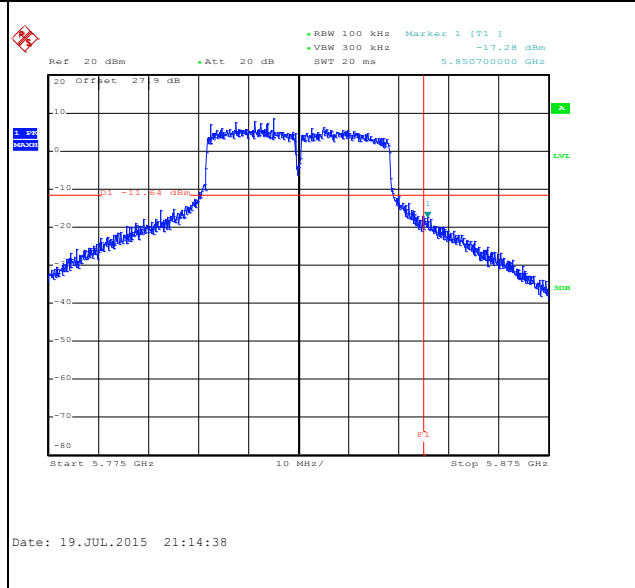

Spurious Emission 30MHz~3GHz

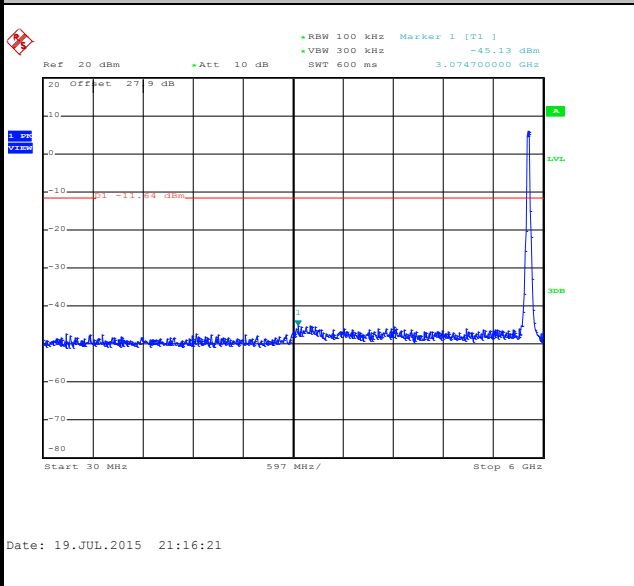

Spurious Emission 2GHz~25GHz

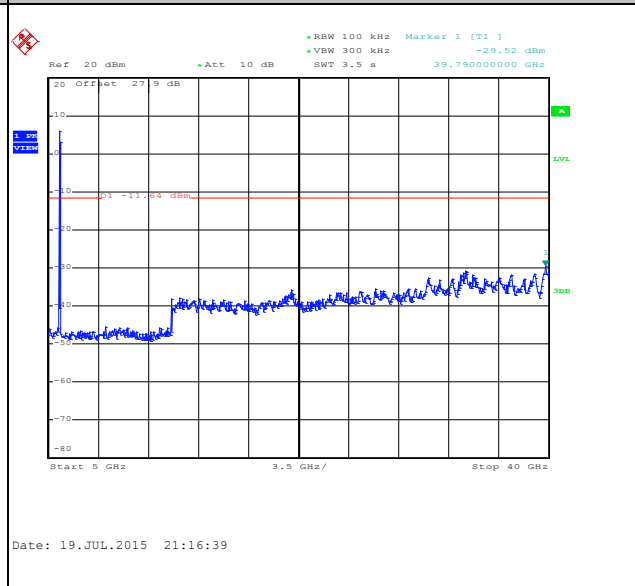



Number of TX :	2	Ant. :	1
Test Mode :	802.11ac VHT50	Temperature :	23~26°C
Test Band :	5GHz Low	Relative Humidity :	45~54%
Test Channel :	151	Test Engineer :	Osolemio Chang

WLAN 802.11ac VHT50 Channel 151

100kHz PSD reference Level

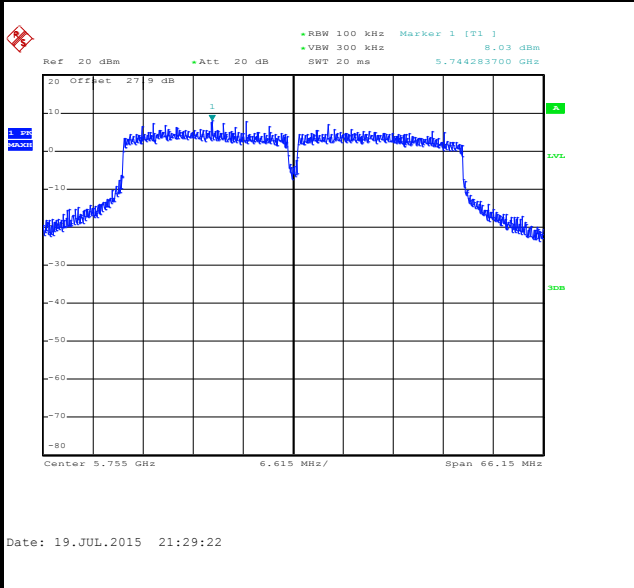

Low Channel Plot

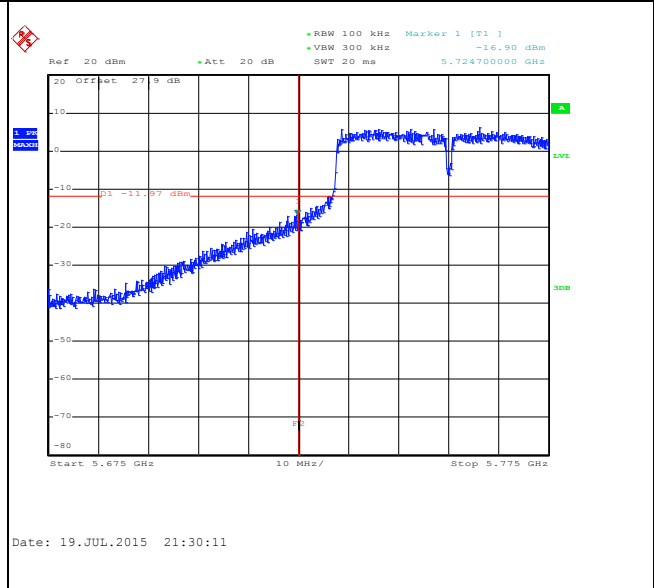

Spurious Emission 30MHz~3GHz

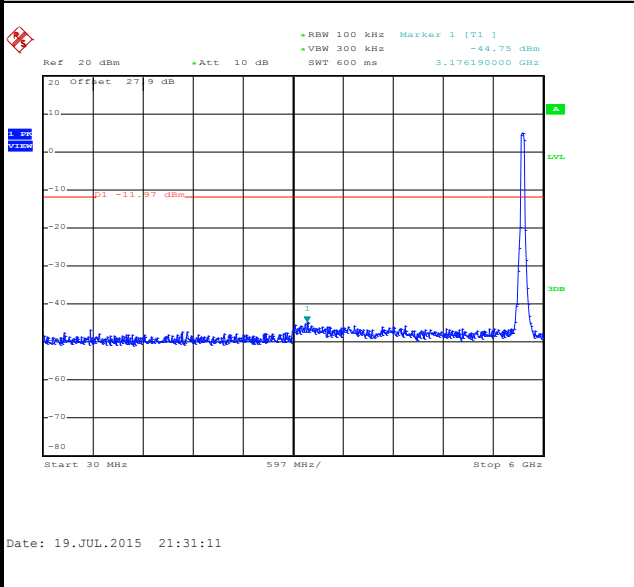

Spurious Emission 2GHz~25GHz

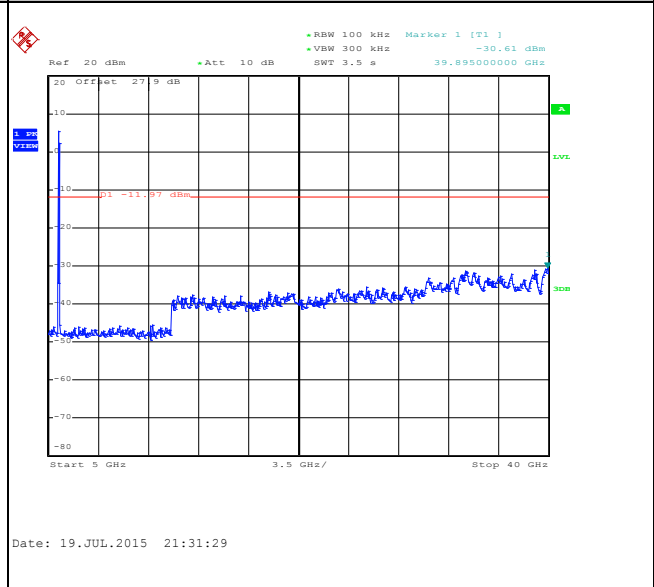



Number of TX :	1	Ant. :	1
Test Mode :	802.11ac VHT50	Temperature :	23~26°C
Test Band :	5GHz Low	Relative Humidity :	45~54%
Test Channel :	158	Test Engineer :	Osolemio Chang

WLAN 802.11ac VHT50 Channel 158

100kHz PSD reference Level

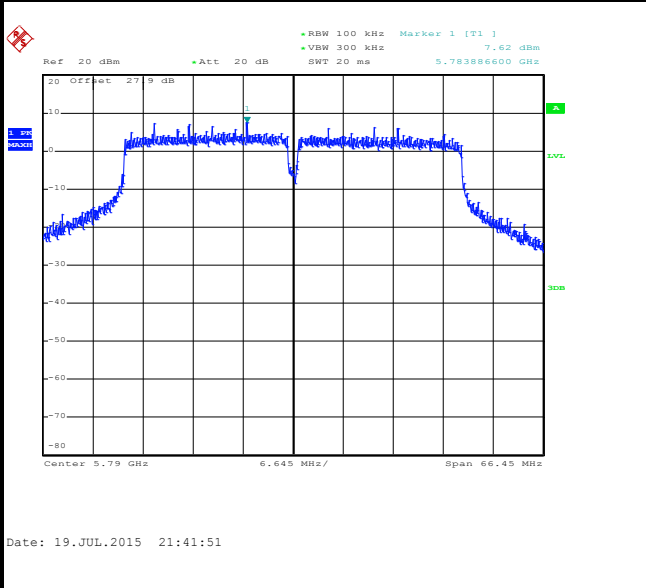

Spurious Emission 30MHz~3GHz

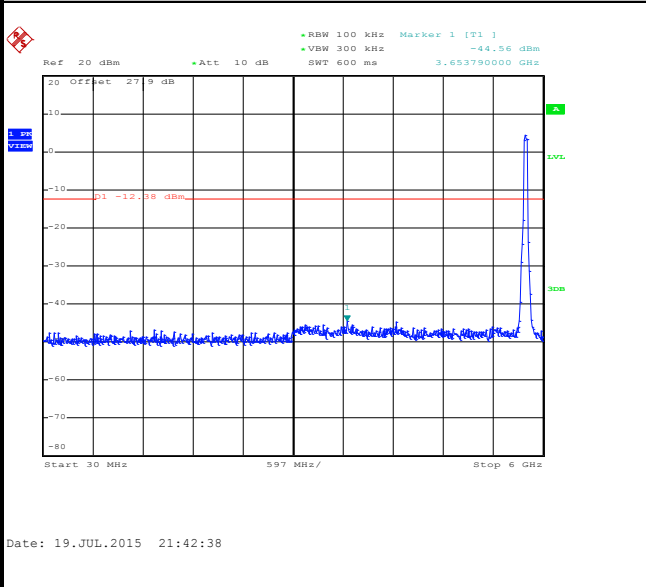

Spurious Emission 2GHz~25GHz

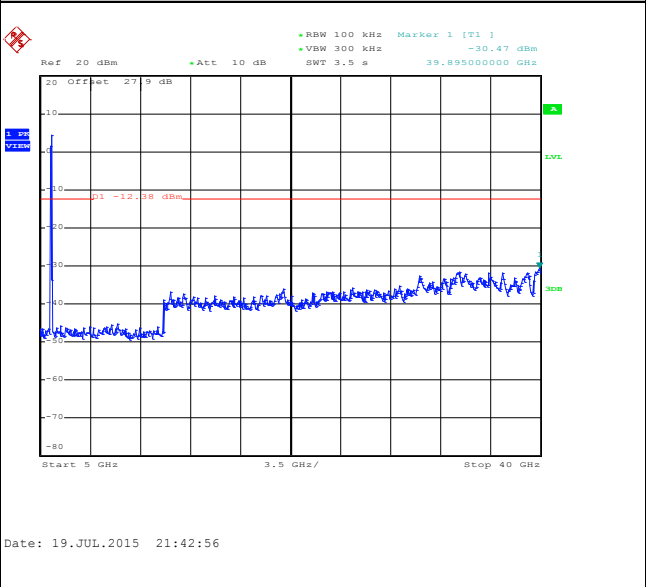



Number of TX :	1	Ant. :	1
Test Mode :	802.11ac VHT50	Temperature :	23~26°C
Test Band :	5GHz Low	Relative Humidity :	45~54%
Test Channel :	164	Test Engineer :	Osolemio Chang

WLAN 802.11ac VHT50 Channel 164

100kHz PSD reference Level

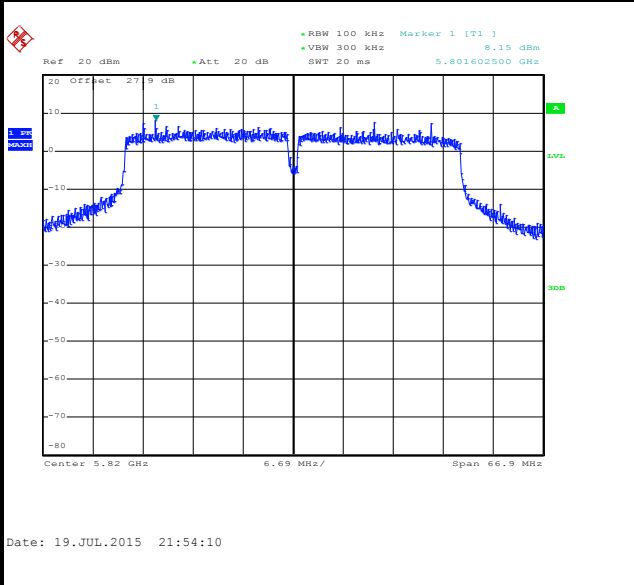

High Channel Plot

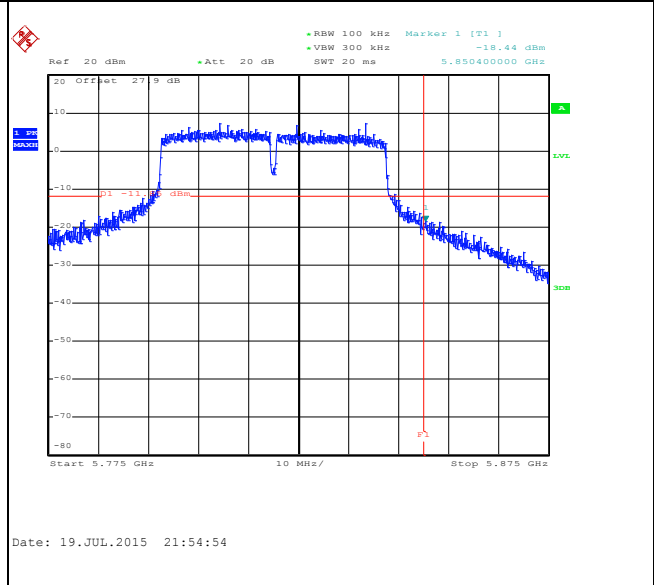

Spurious Emission 30MHz~3GHz

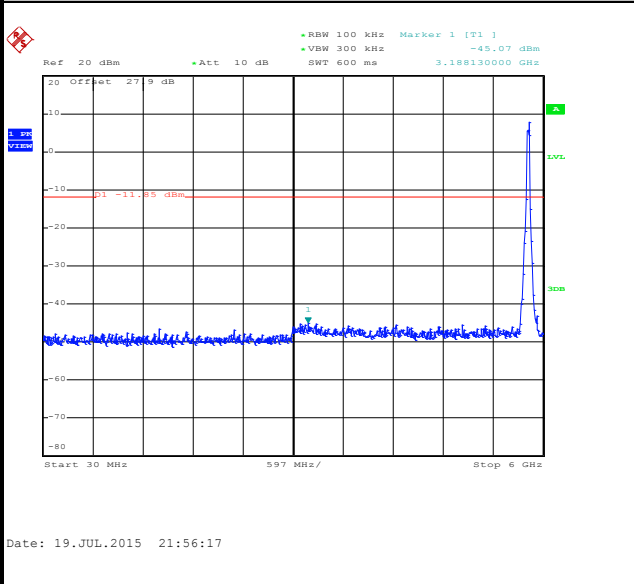

Spurious Emission 2GHz~25GHz

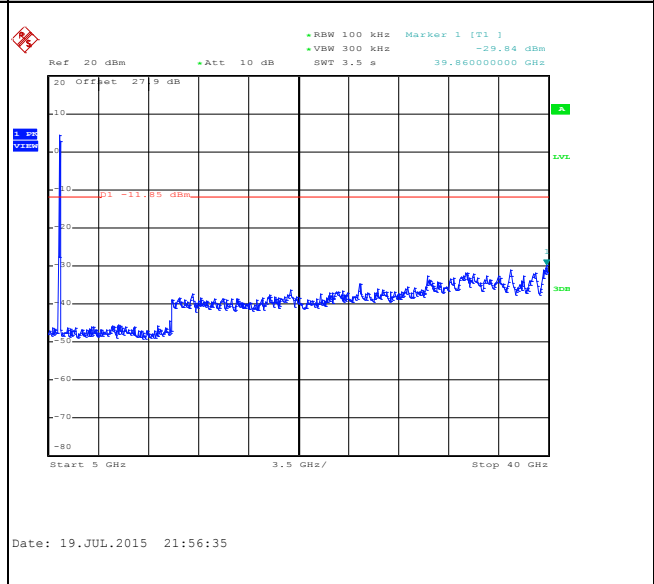



Number of TX :	2	Ant. :	1
Test Mode :	802.11ac VHT60	Temperature :	23~26°C
Test Band :	5GHz Low	Relative Humidity :	45~54%
Test Channel :	152	Test Engineer :	Osolemio Chang

WLAN 802.11ac VHT60 Channel 152

100kHz PSD reference Level

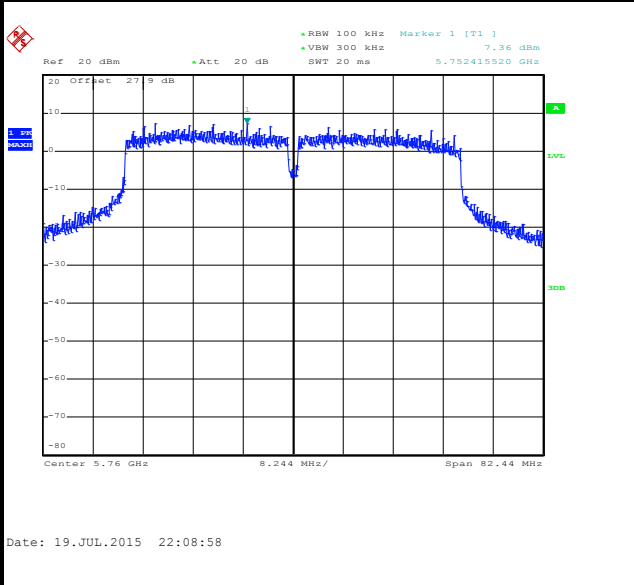

Low Channel Plot

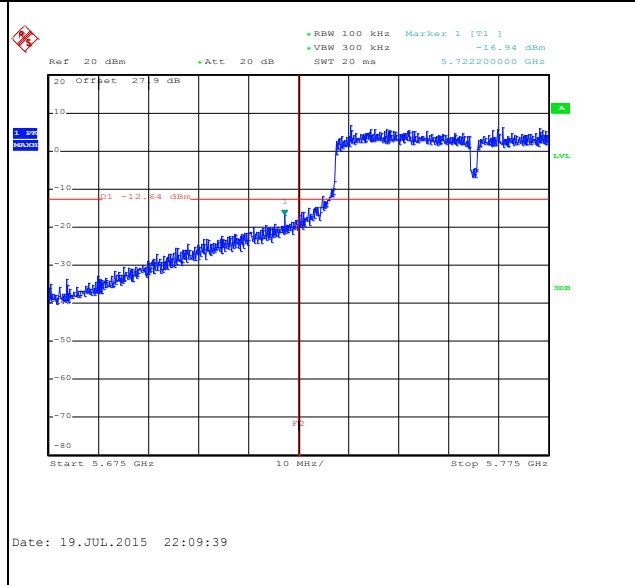

Spurious Emission 30MHz~3GHz

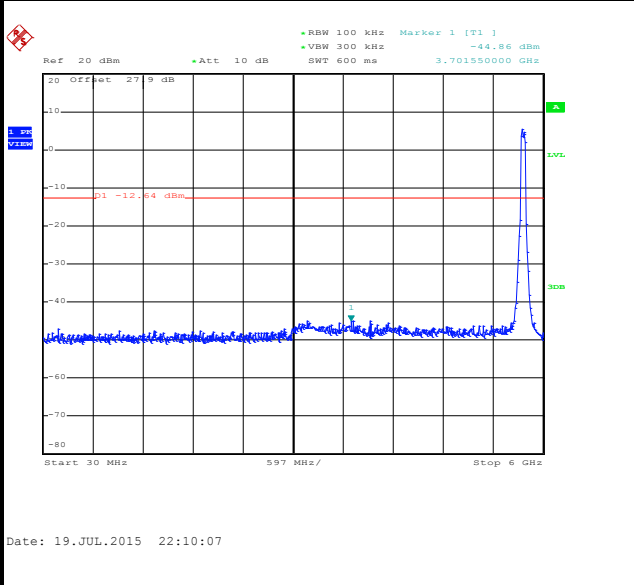

Spurious Emission 2GHz~25GHz

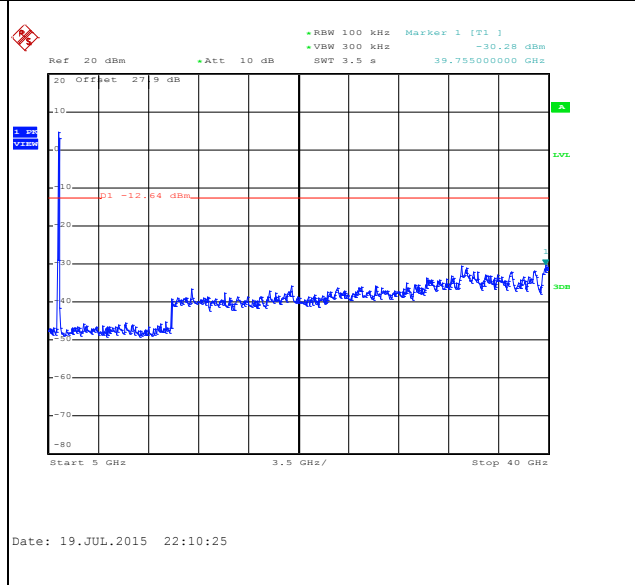



Number of TX :	2	Ant. :	1
Test Mode :	802.11ac VHT60	Temperature :	23~26°C
Test Band :	5GHz Low	Relative Humidity :	45~54%
Test Channel :	158	Test Engineer :	Osolemio Chang

WLAN 802.11ac VHT60 Channel 158

100kHz PSD reference Level

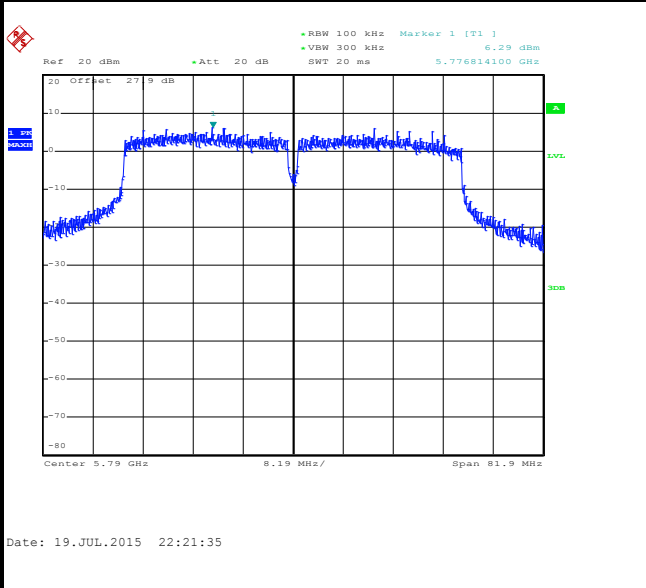

Spurious Emission 30MHz~3GHz

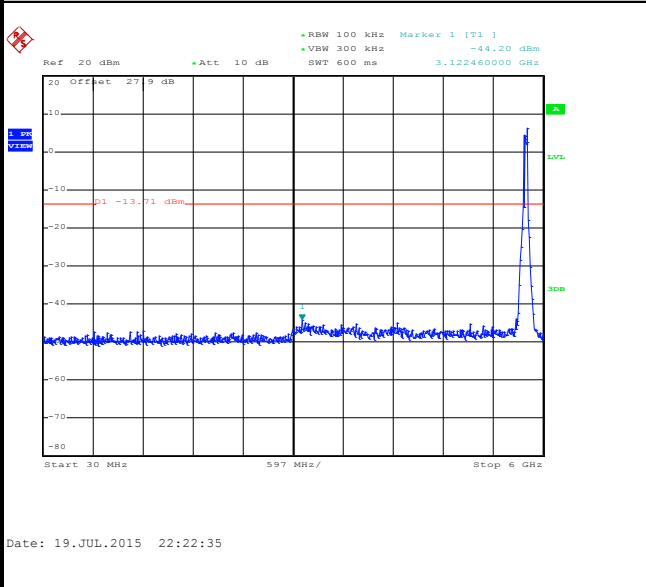

Spurious Emission 2GHz~25GHz

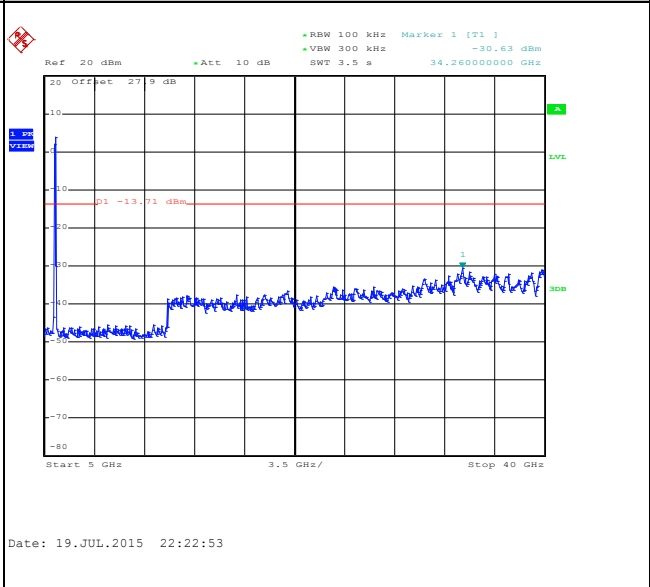



Number of TX :	2	Ant. :	1
Test Mode :	802.11ac VHT60	Temperature :	23~26°C
Test Band :	5GHz Low	Relative Humidity :	45~54%
Test Channel :	163	Test Engineer :	Osolemio Chang

WLAN 802.11ac VHT60 Channel 163

100kHz PSD reference Level

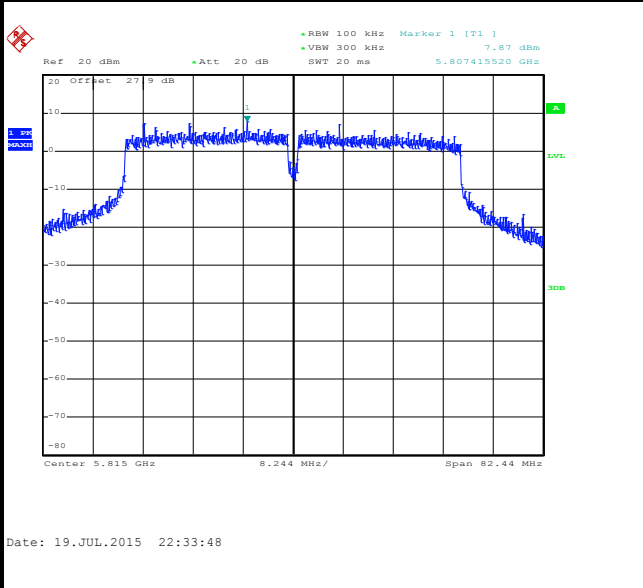

High Channel Plot

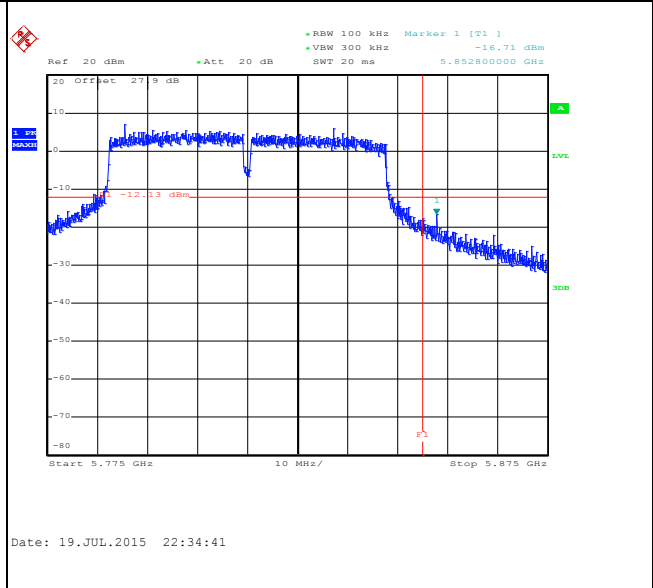

Spurious Emission 30MHz~3GHz

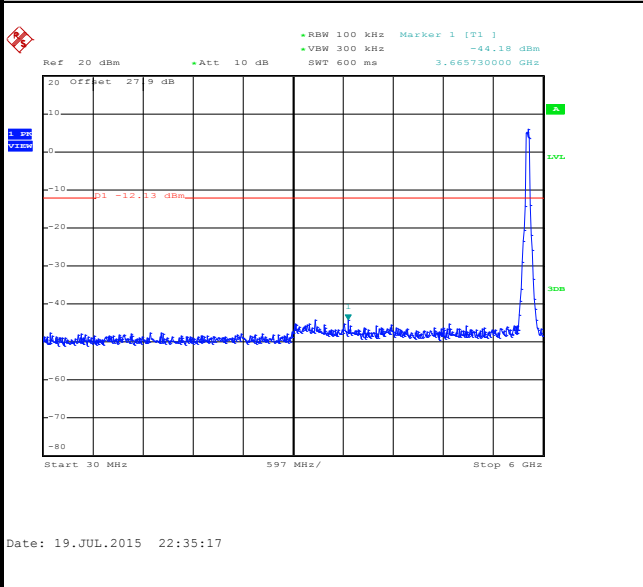

Spurious Emission 2GHz~25GHz

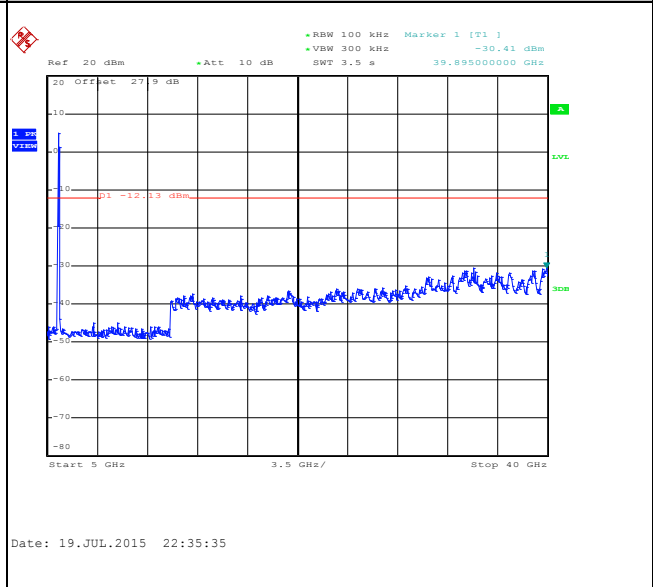



Number of TX :	2	Ant. :	1
Test Mode :	802.11ac VHT80	Temperature :	23~26°C
Test Band :	5GHz Low	Relative Humidity :	45~54%
Test Channel :	154	Test Engineer :	Osolemio Chang

WLAN 802.11ac VHT80 Channel 154

100kHz PSD reference Level

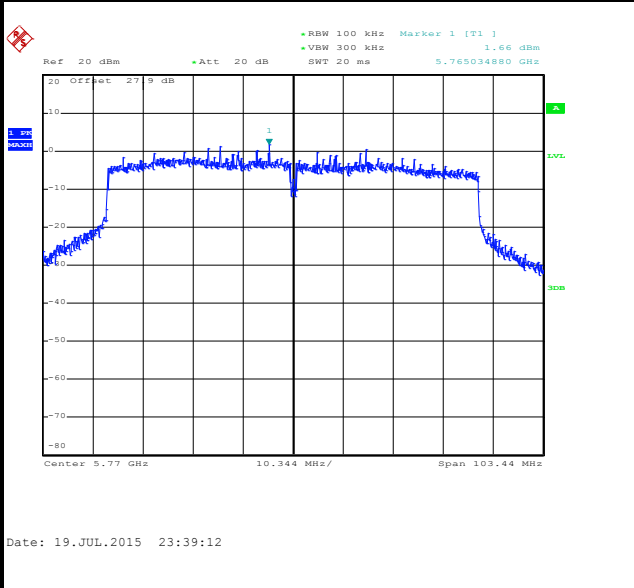

Low Channel Plot

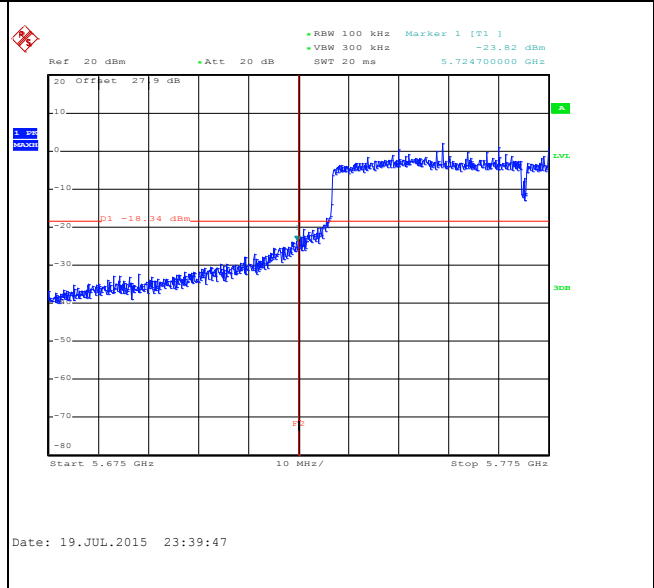

Spurious Emission 30MHz~3GHz

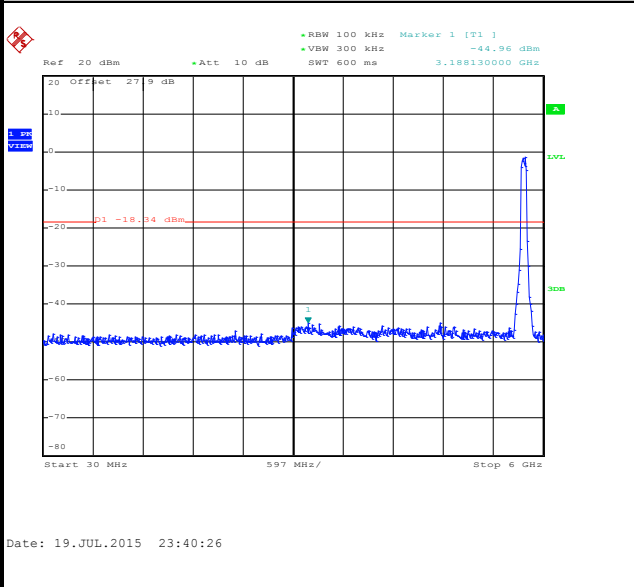

Spurious Emission 2GHz~25GHz

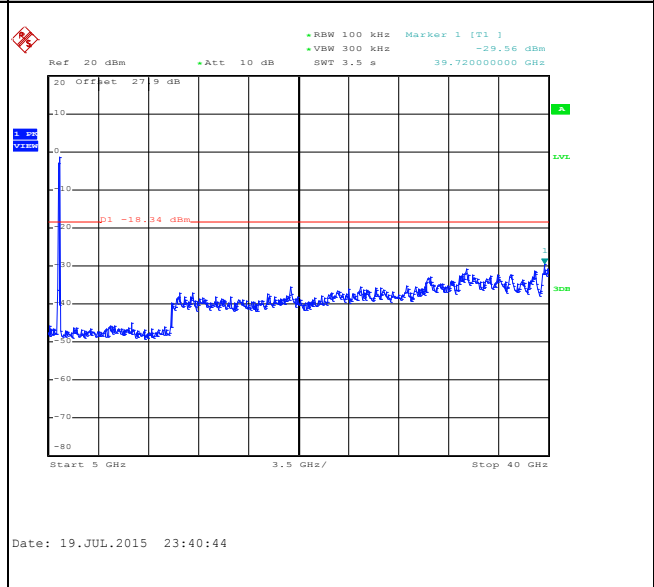



Number of TX :	2	Ant. :	1
Test Mode :	802.11ac VHT80	Temperature :	23~26°C
Test Band :	5GHz Low	Relative Humidity :	45~54%
Test Channel :	158	Test Engineer :	Osolemio Chang

WLAN 802.11ac VHT80 Channel 158

100kHz PSD reference Level

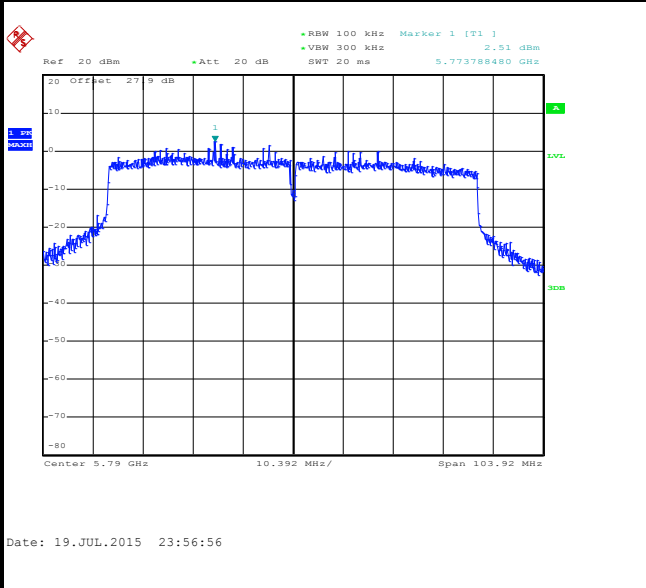

Spurious Emission 30MHz~3GHz

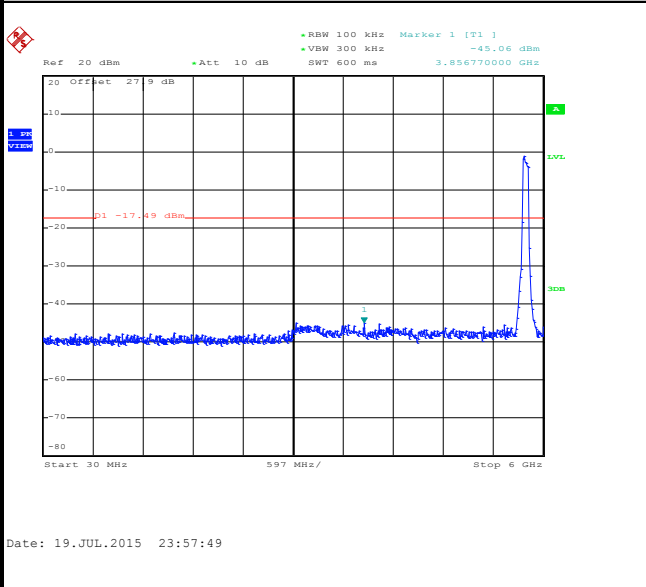

Spurious Emission 2GHz~25GHz

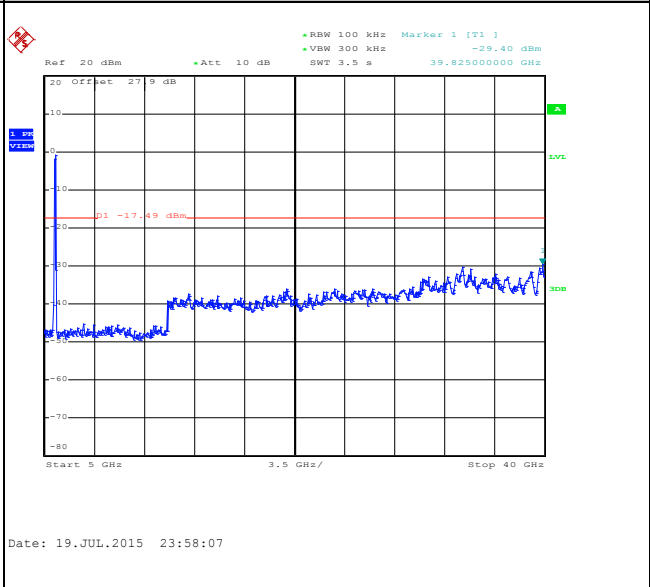



Number of TX :	2	Ant. :	1
Test Mode :	802.11ac VHT80	Temperature :	23~26°C
Test Band :	5GHz Low	Relative Humidity :	45~54%
Test Channel :	162	Test Engineer :	Osolemio Chang

WLAN 802.11ac VHT80 Channel 162

100kHz PSD reference Level

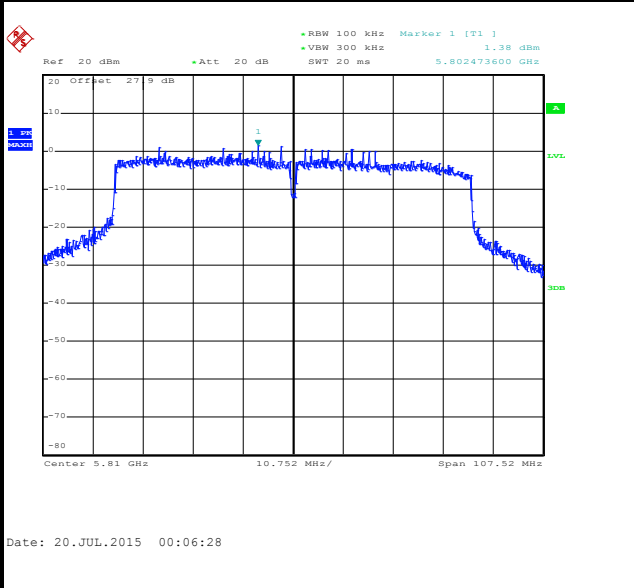

High Channel Plot

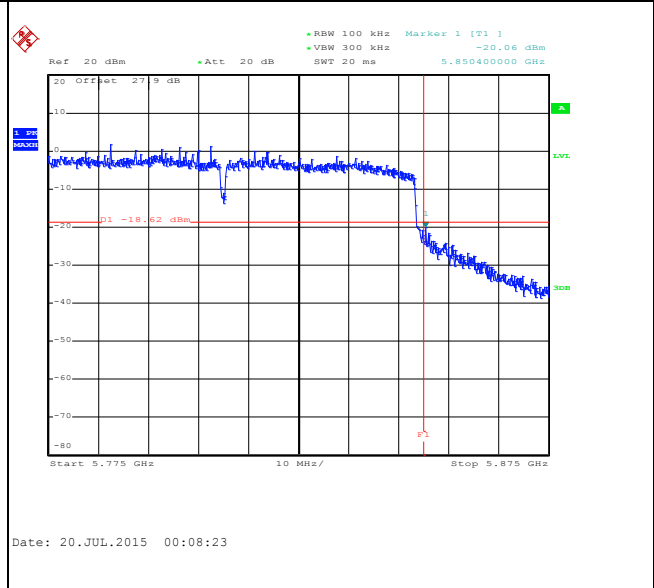

Spurious Emission 30MHz~3GHz

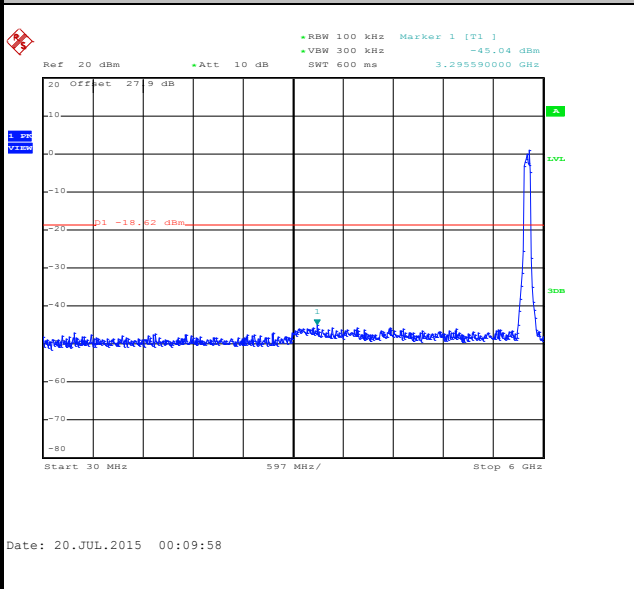

Spurious Emission 2GHz~25GHz

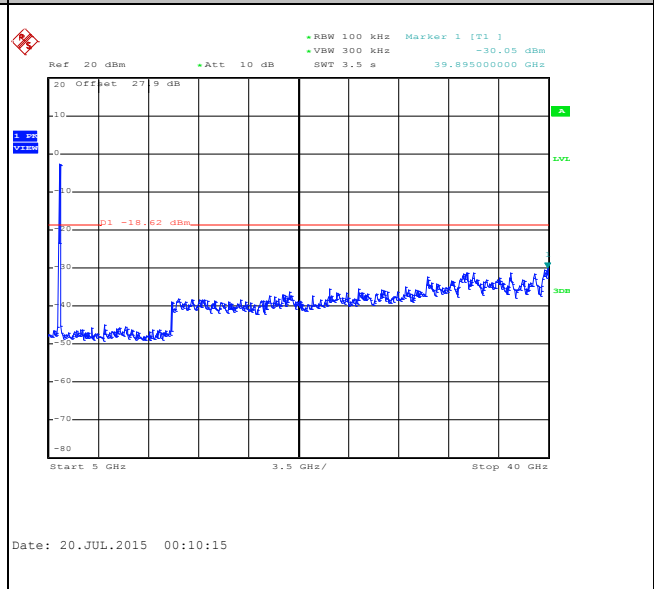



Number of TX = 2, Ant. 2 (Measured)

Number of TX :	2	Ant. :	2
Test Mode :	802.11ac VHT10	Temperature :	23~26°C
Test Band :	5GHz Low	Relative Humidity :	45~54%
Test Channel :	147	Test Engineer :	Osolemio Chang

WLAN 802.11ac VHT10 Channel 147

100kHz PSD reference Level

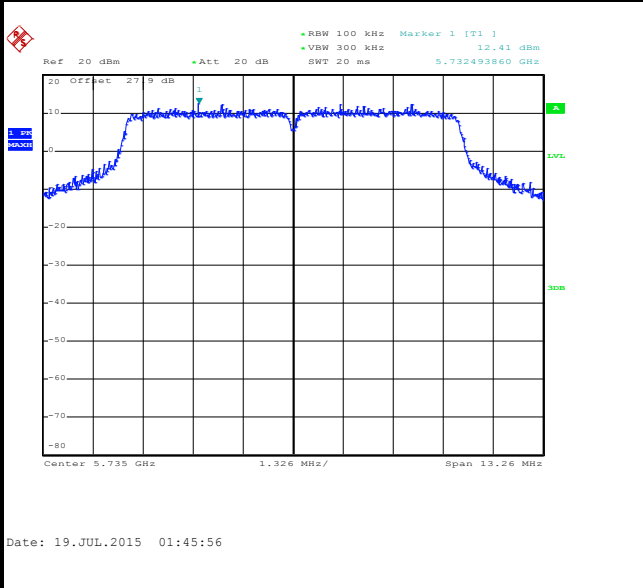

Low Channel Plot

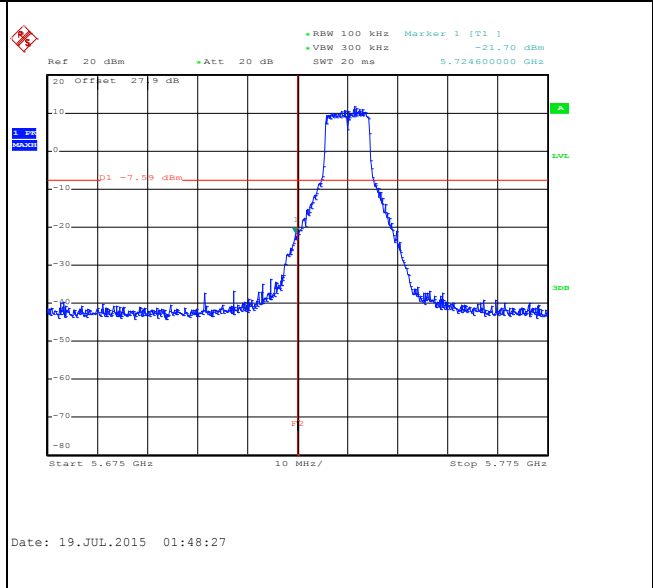

Spurious Emission 30MHz~3GHz

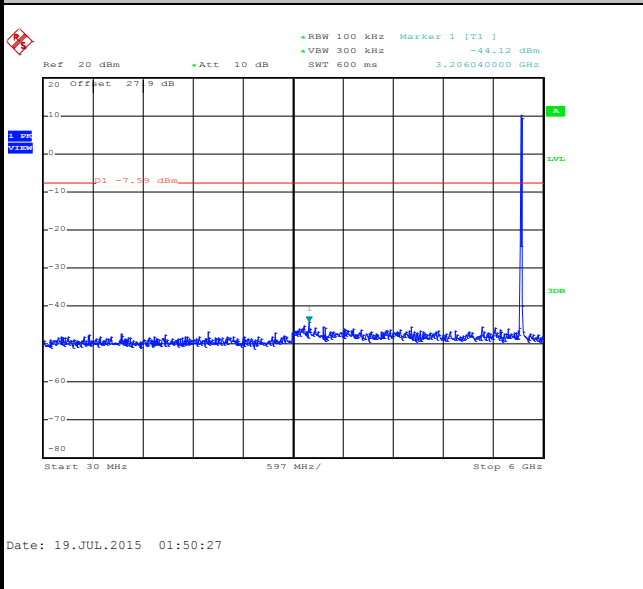

Spurious Emission 2GHz~25GHz

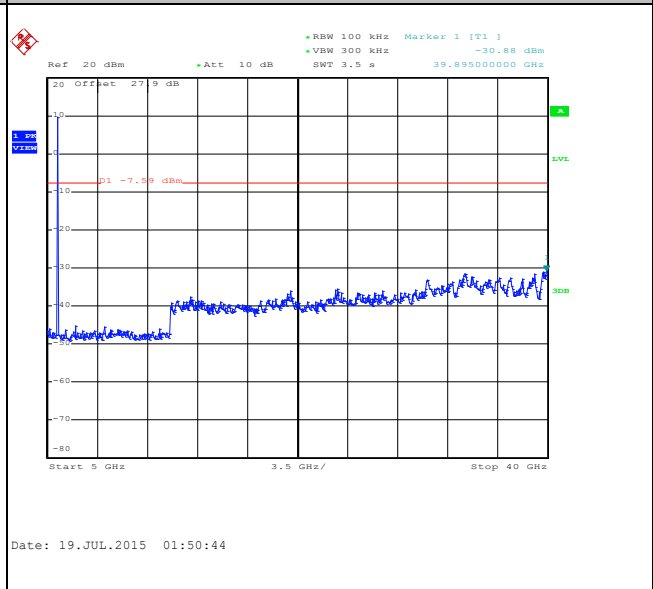



Number of TX :	2	Ant. :	2
Test Mode :	802.11ac VHT10	Temperature :	23~26°C
Test Band :	5GHz Low	Relative Humidity :	45~54%
Test Channel :	158	Test Engineer :	Osolemio Chang

WLAN 802.11ac VHT10 Channel 158

100kHz PSD reference Level

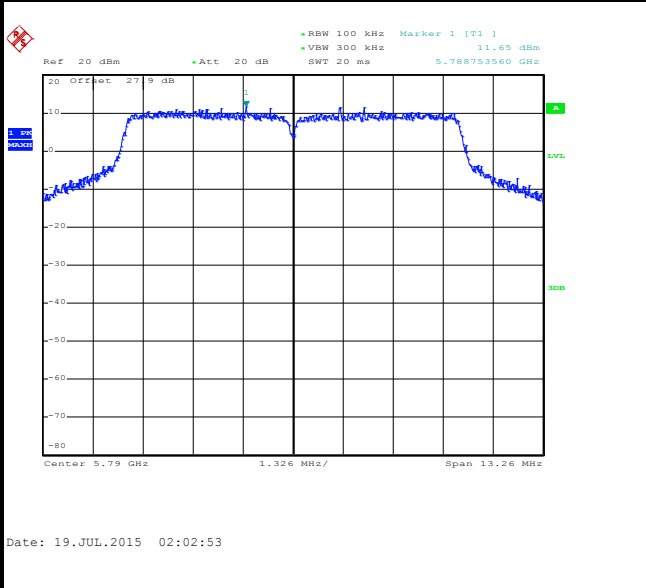

Spurious Emission 30MHz~3GHz

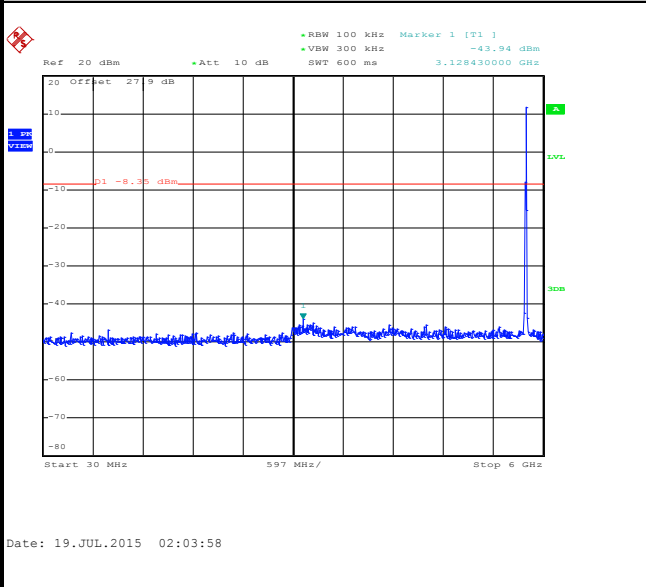

Spurious Emission 2GHz~25GHz

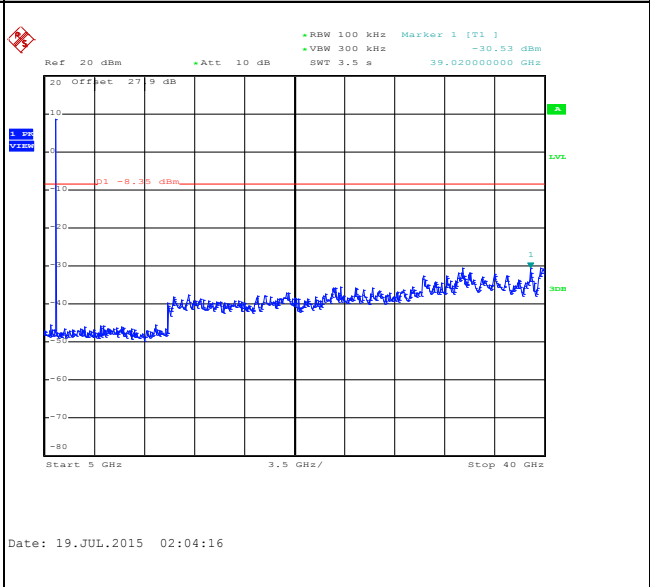



Number of TX :	2	Ant. :	2
Test Mode :	802.11ac VHT10	Temperature :	23~26°C
Test Band :	5GHz Low	Relative Humidity :	45~54%
Test Channel :	168	Test Engineer :	Osolemio Chang

WLAN 802.11ac VHT10 Channel 168

100kHz PSD reference Level

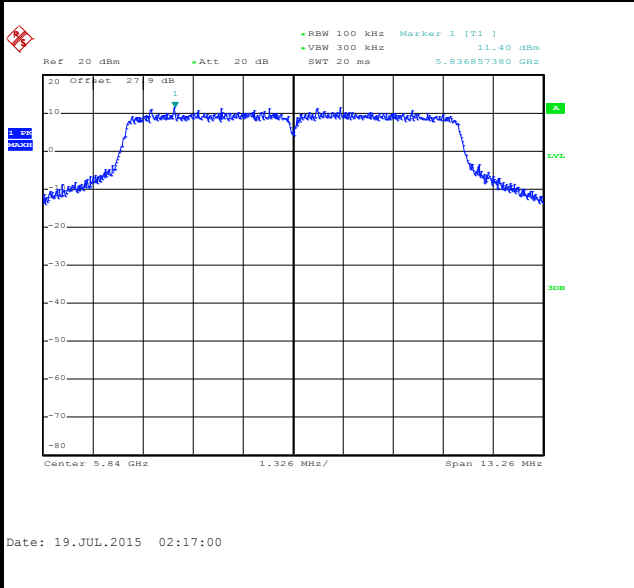

High Channel Plot

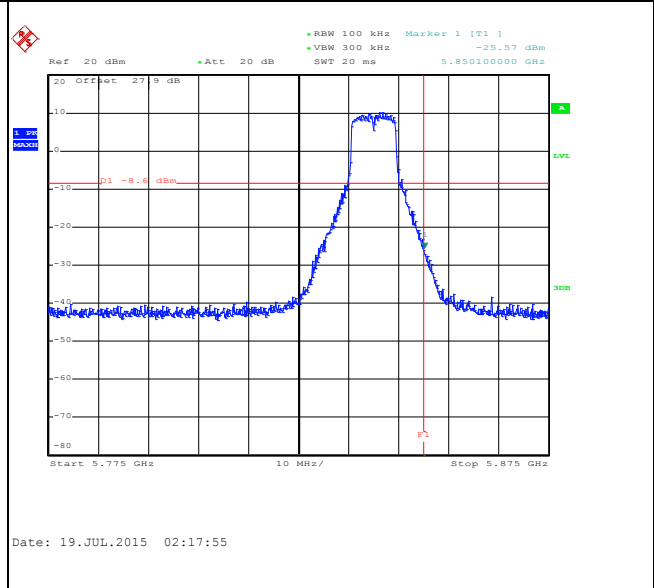

Spurious Emission 30MHz~3GHz

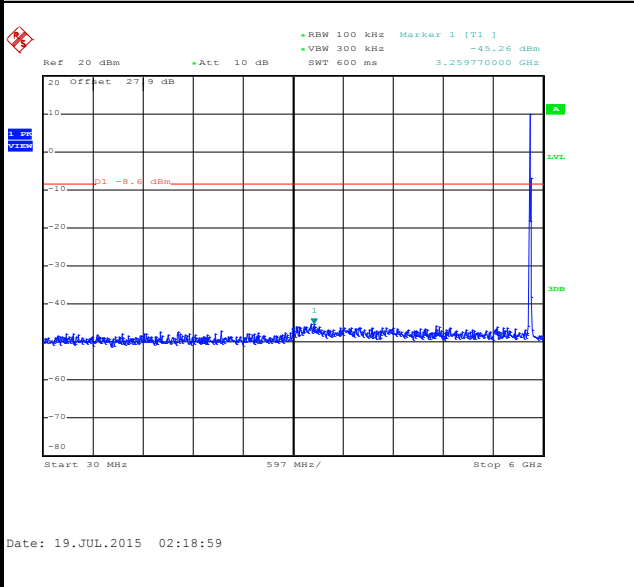

Spurious Emission 2GHz~25GHz

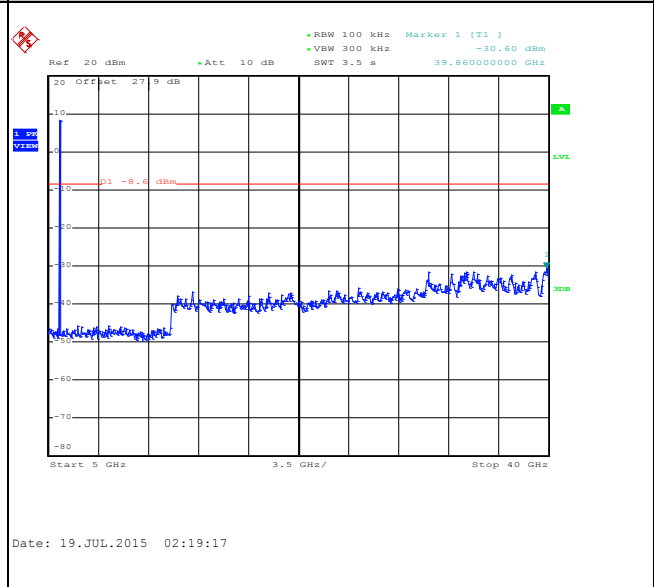



Number of TX :	2	Ant. :	2
Test Mode :	802.11ac VHT20	Temperature :	23~26°C
Test Band :	5GHz Low	Relative Humidity :	45~54%
Test Channel :	148	Test Engineer :	Osolemio Chang

WLAN 802.11ac VHT20 Channel 148

100kHz PSD reference Level

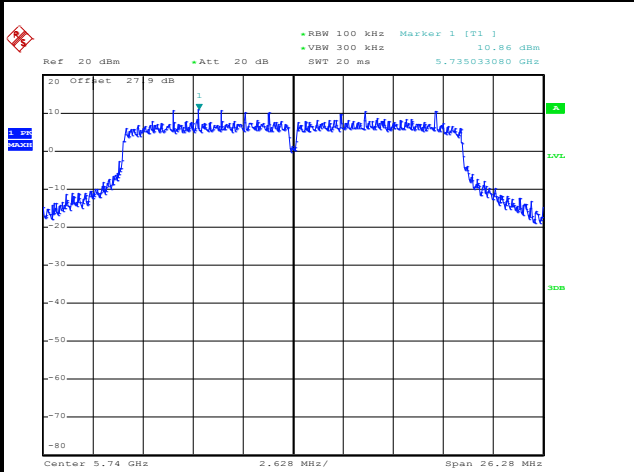

Date: 19.JUL.2015 02:31:45

Low Channel Plot

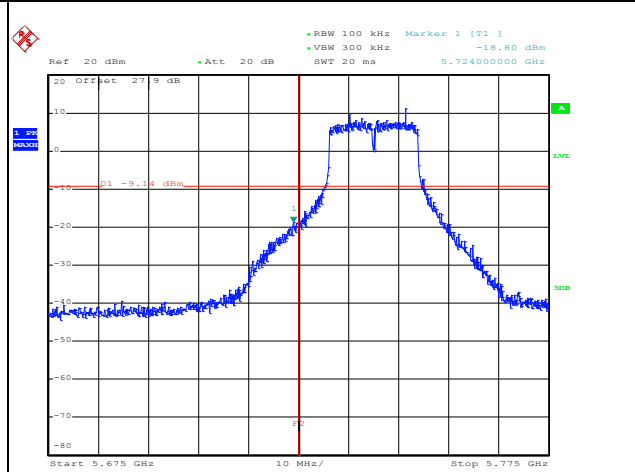

Date: 19.JUL.2015 02:32:27

Spurious Emission 30MHz~3GHz

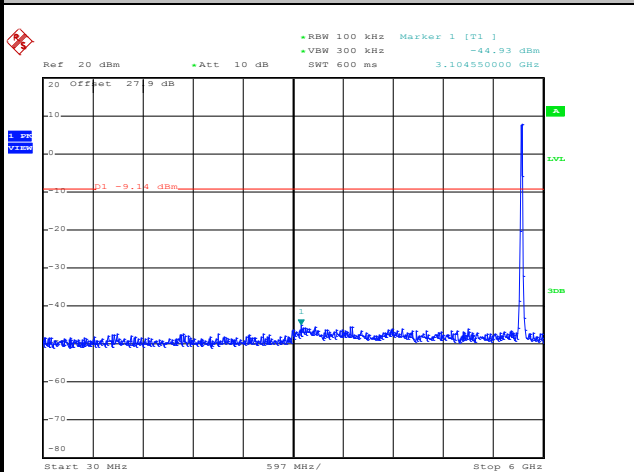

Date: 19.JUL.2015 02:32:59

Spurious Emission 2GHz~25GHz

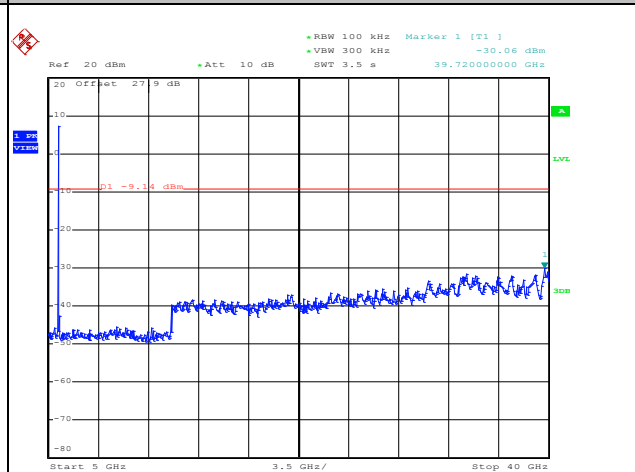

Date: 19.JUL.2015 02:33:17



Number of TX :	2	Ant. :	2
Test Mode :	802.11ac VHT40	Temperature :	23~26°C
Test Band :	5GHz Low	Relative Humidity :	45~54%
Test Channel :	158	Test Engineer :	Osolemio Chang

WLAN 802.11ac VHT20 Channel 158

100kHz PSD reference Level

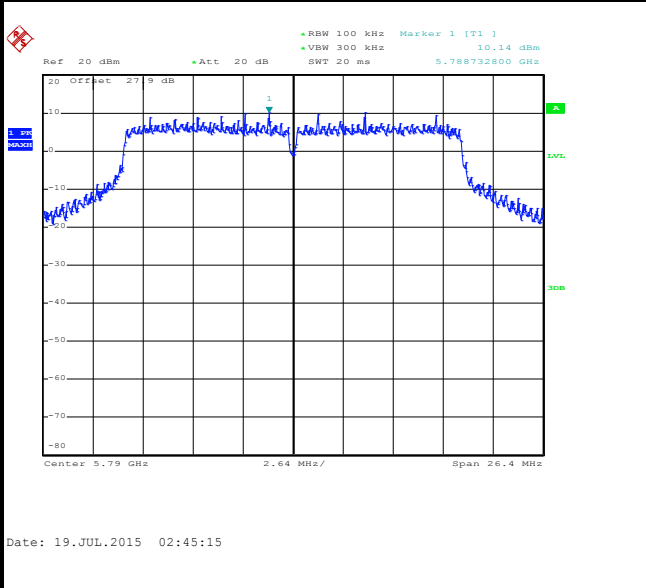

Spurious Emission 30MHz~3GHz

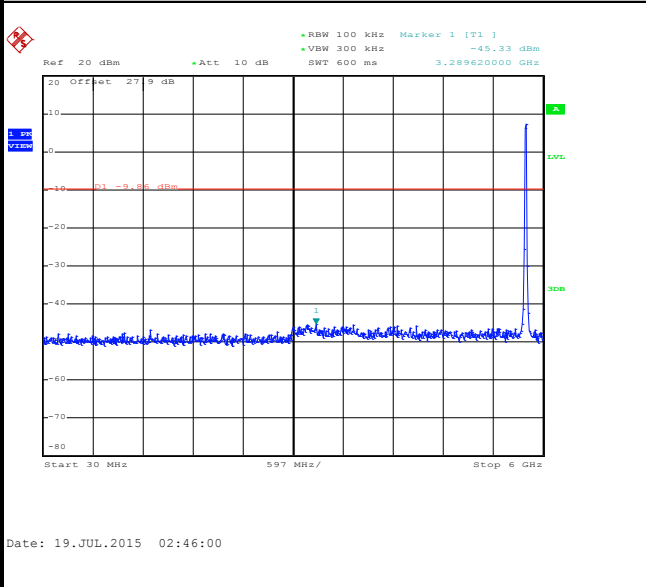

Spurious Emission 2GHz~25GHz

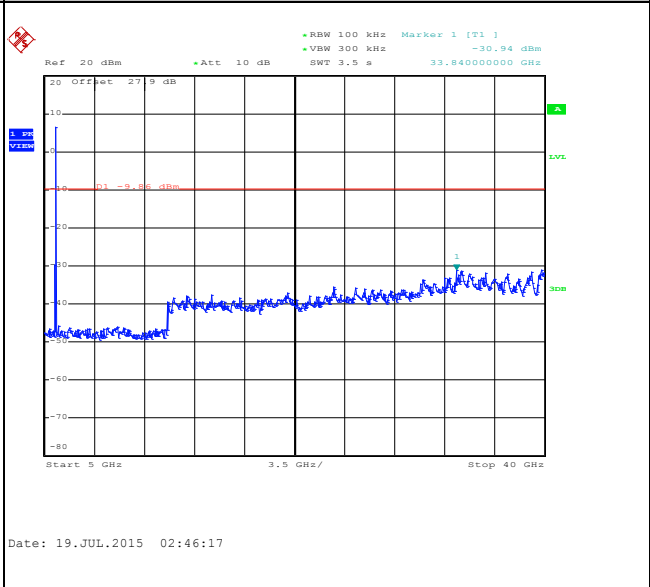



Number of TX :	2	Ant. :	2
Test Mode :	802.11ac VHT20	Temperature :	23~26°C
Test Band :	5GHz Low	Relative Humidity :	45~54%
Test Channel :	167	Test Engineer :	Osolemio Chang

WLAN 802.11ac VHT20 Channel 167

100kHz PSD reference Level

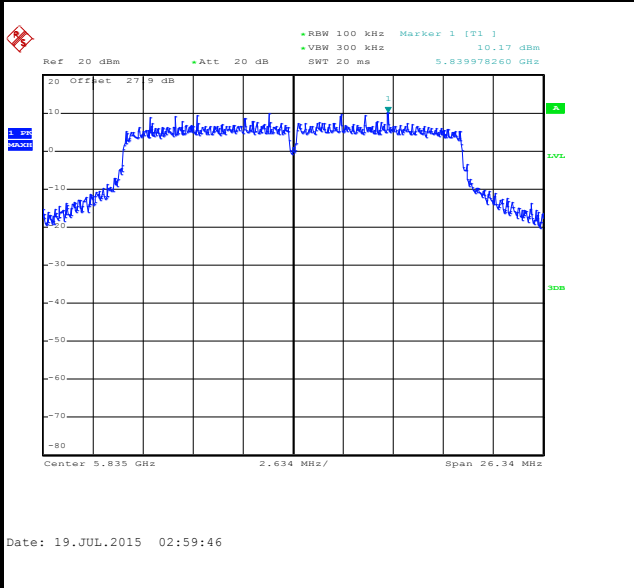

High Channel Plot

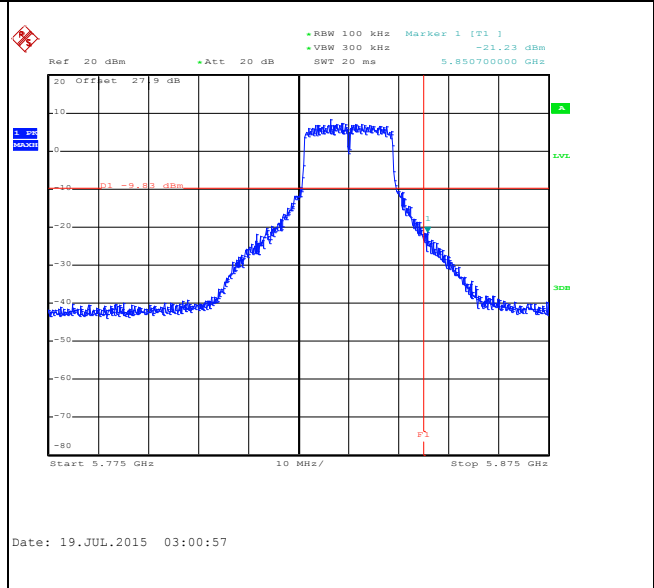

Spurious Emission 30MHz~3GHz

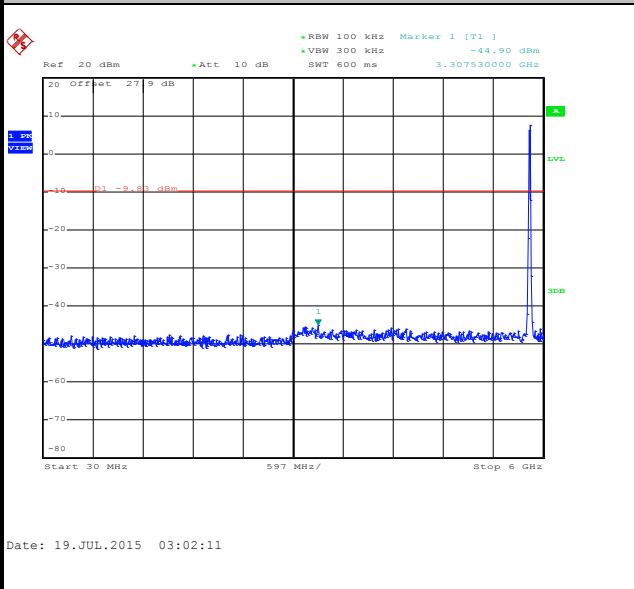

Spurious Emission 2GHz~25GHz

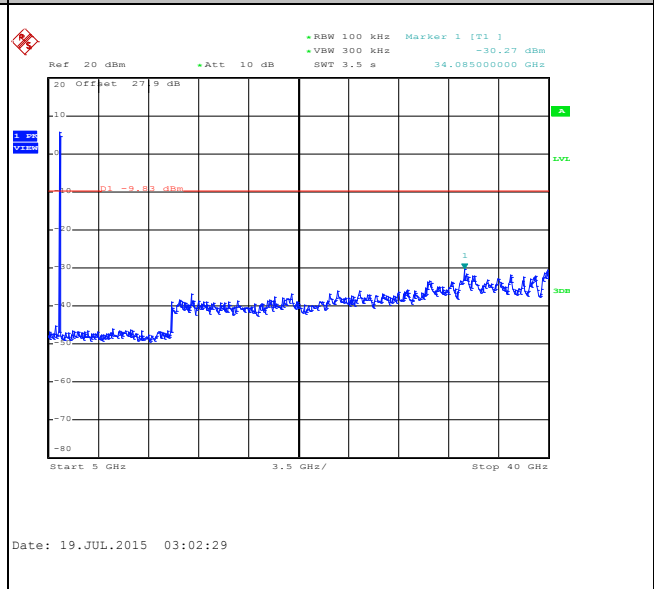



Number of TX :	2	Ant. :	2
Test Mode :	802.11ac VHT30	Temperature :	23~26°C
Test Band :	5GHz Low	Relative Humidity :	45~54%
Test Channel :	149	Test Engineer :	Osolemio Chang

WLAN 802.11ac VHT30 Channel 149

100kHz PSD reference Level

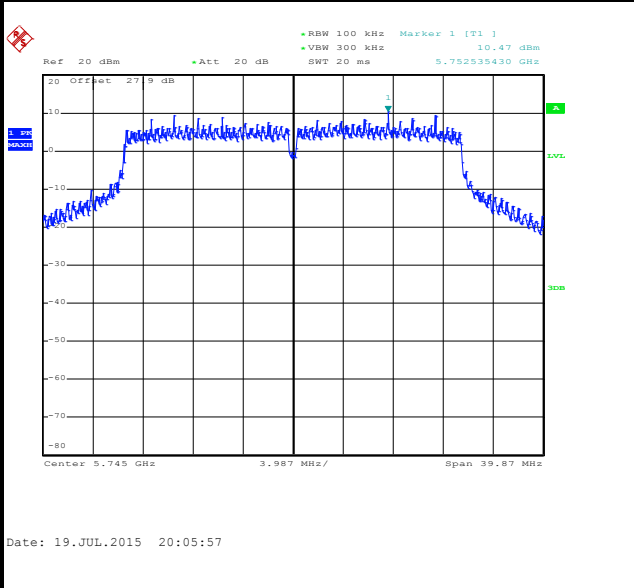

Low Channel Plot

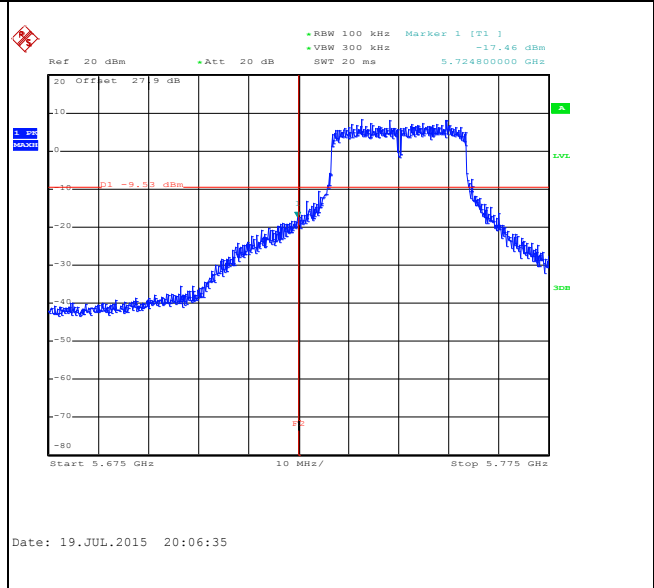

Spurious Emission 30MHz~3GHz

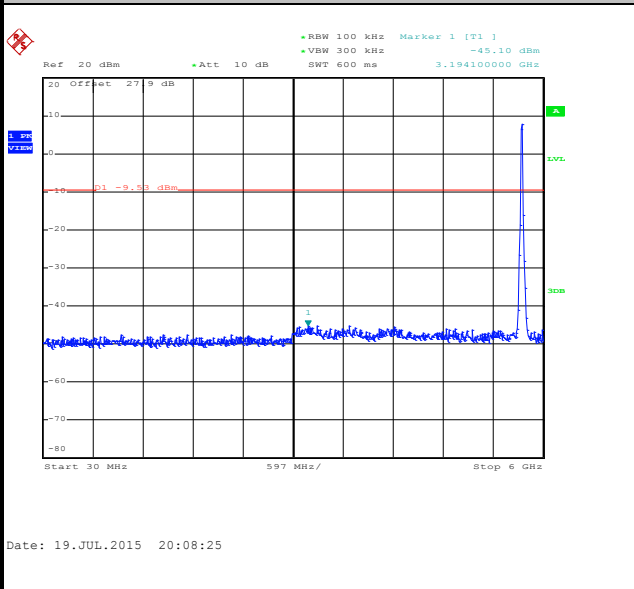

Spurious Emission 2GHz~25GHz

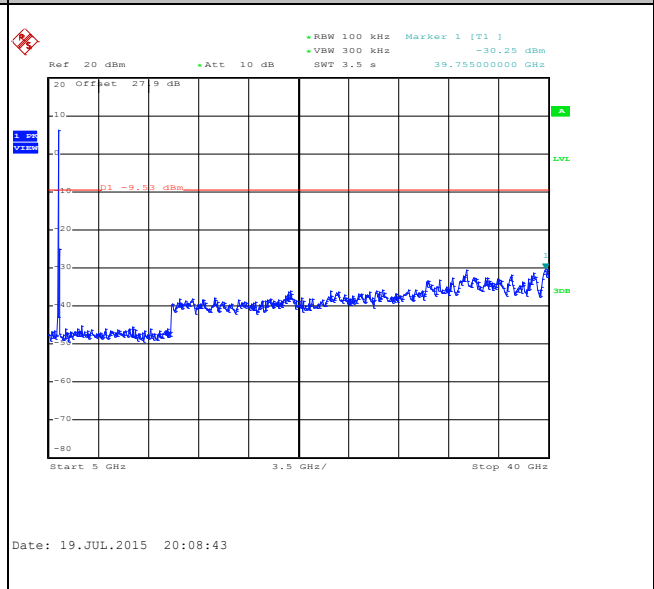



Number of TX :	2	Ant. :	2
Test Mode :	802.11ac VHT30	Temperature :	23~26°C
Test Band :	5GHz Low	Relative Humidity :	45~54%
158	06	Test Engineer :	Osolemio Chang

WLAN 802.11ac VHT30 Channel 158

100kHz PSD reference Level

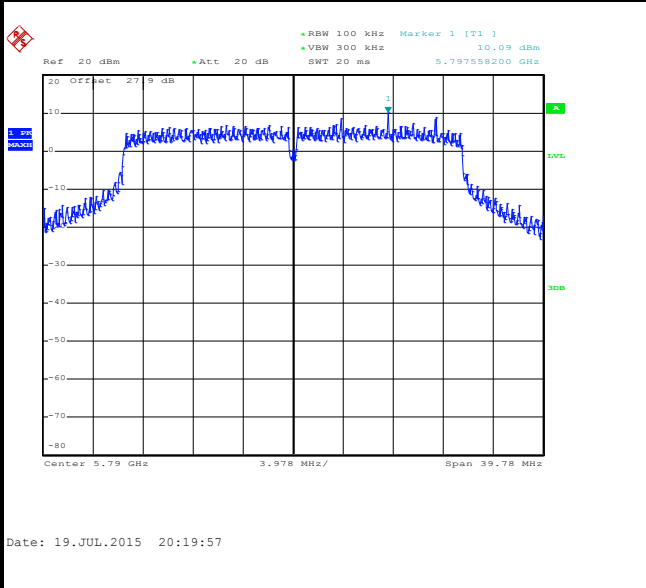

Spurious Emission 30MHz~3GHz

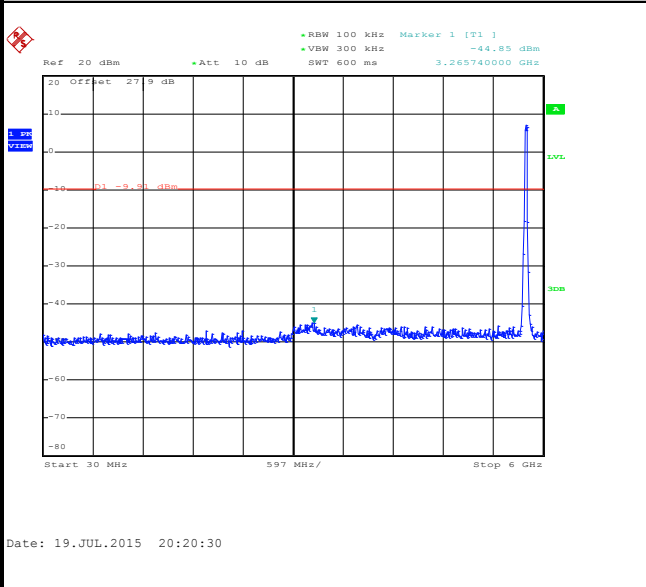

Spurious Emission 2GHz~25GHz

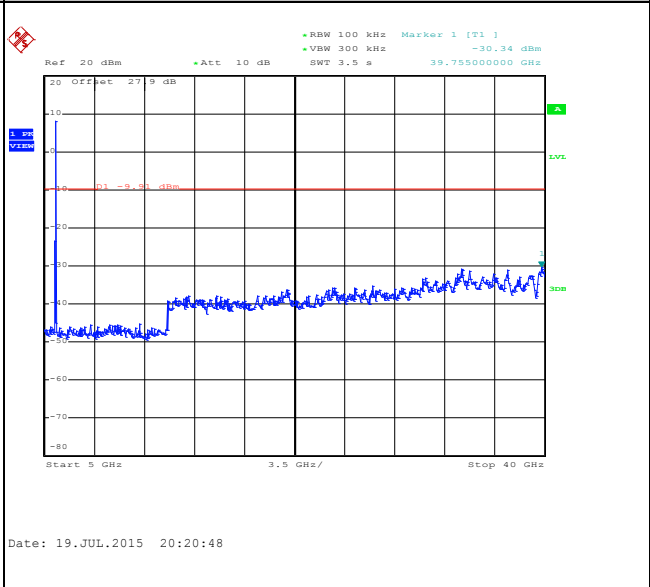



Number of TX :	2	Ant. :	2
Test Mode :	802.11ac VHT30	Temperature :	23~26°C
Test Band :	5GHz Low	Relative Humidity :	45~54%
Test Channel :	166	Test Engineer :	Osolemio Chang

WLAN 802.11ac VHT30 Channel 166

100kHz PSD reference Level

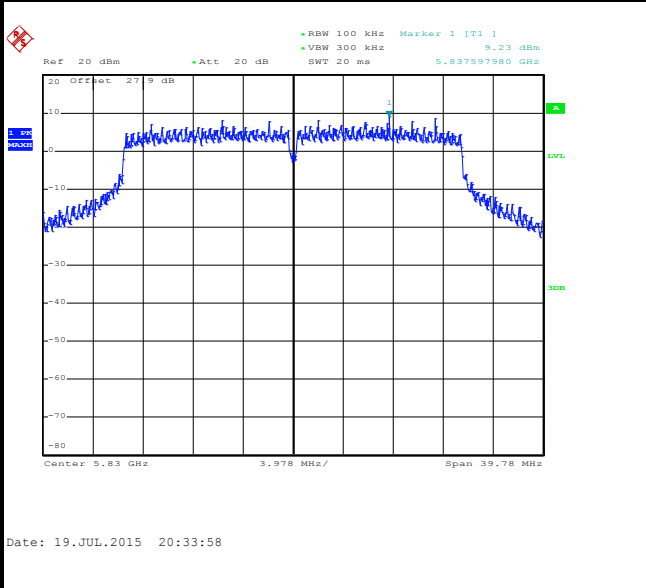

High Channel Plot

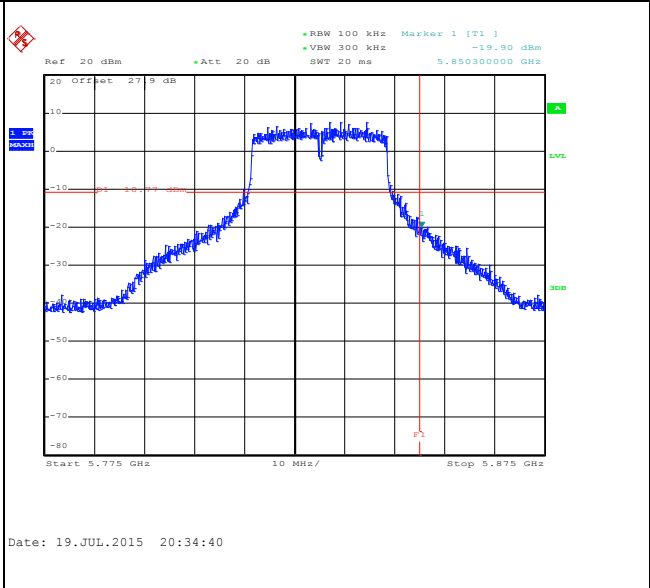

Spurious Emission 30MHz~3GHz

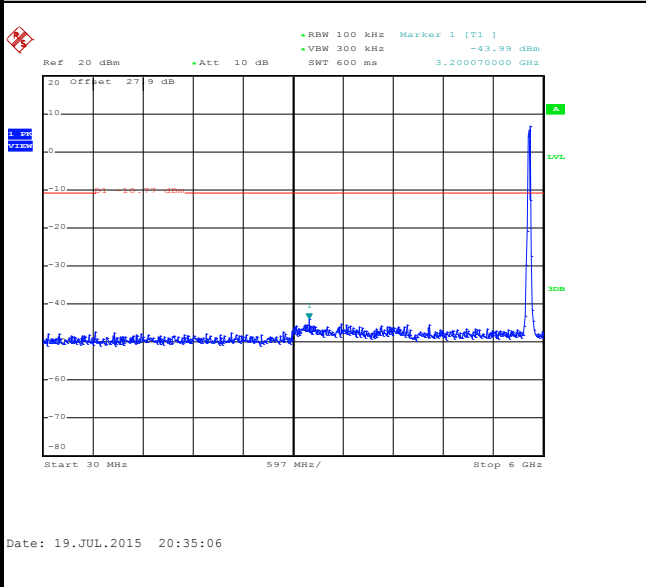

Spurious Emission 2GHz~25GHz

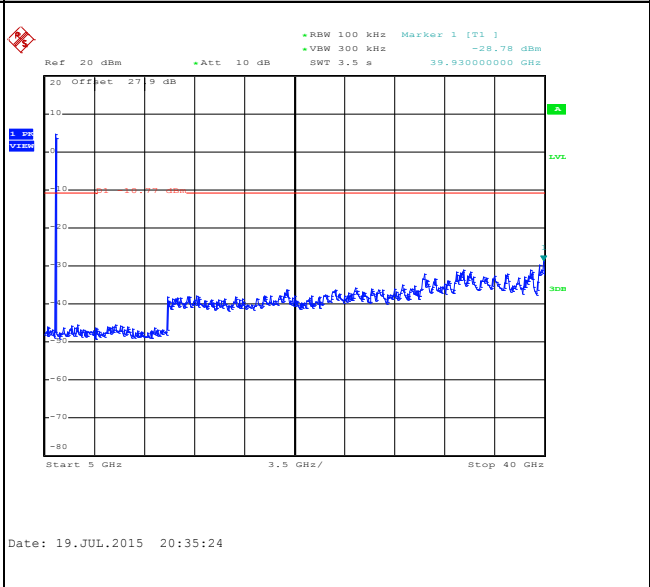



Number of TX :	2	Ant. :	2
Test Mode :	802.11ac VHT40	Temperature :	23~26°C
Test Band :	5GHz Low	Relative Humidity :	45~54%
Test Channel :	150	Test Engineer :	Osolemio Chang

WLAN 802.11ac VHT40 Channel 150

100kHz PSD reference Level

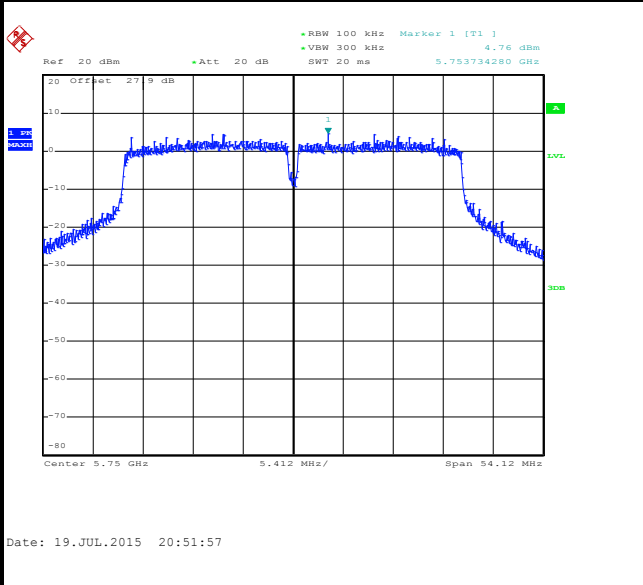

Low Channel Plot

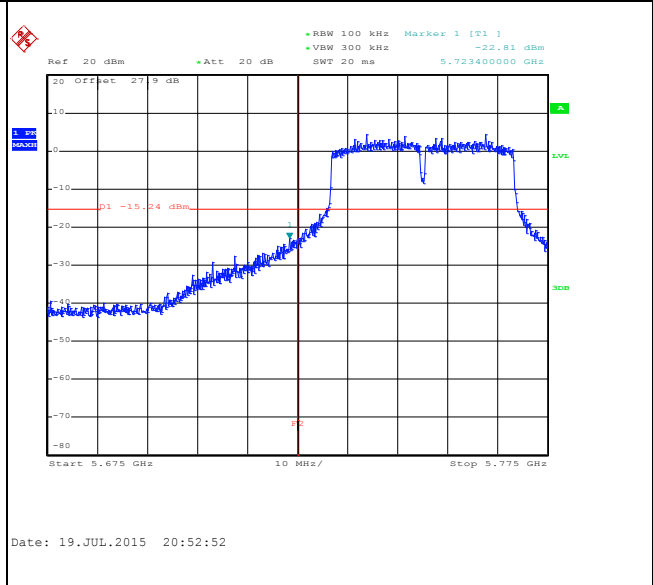

Spurious Emission 30MHz~3GHz

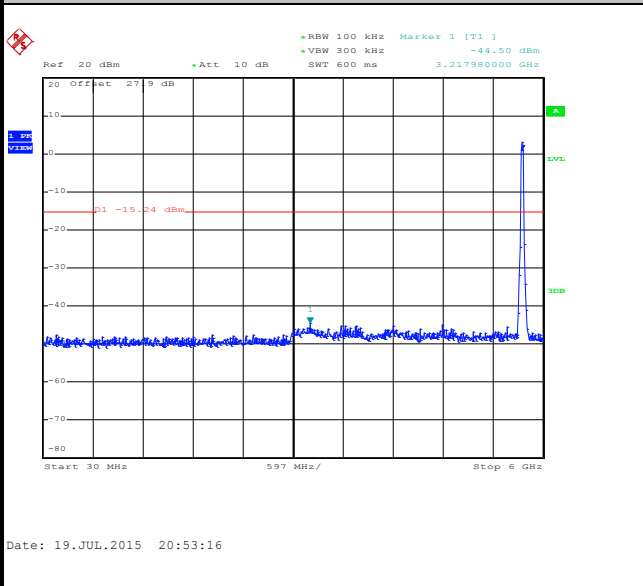

Spurious Emission 2GHz~25GHz

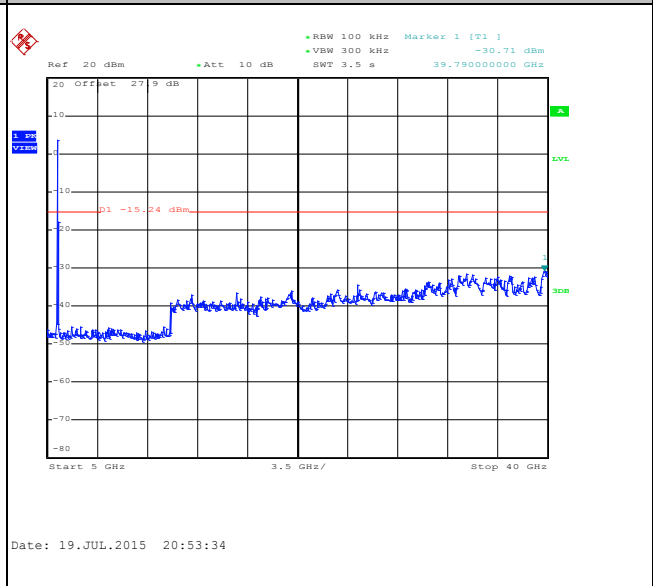



Number of TX :	2	Ant. :	2
Test Mode :	802.11ac VHT40	Temperature :	23~26°C
Test Band :	5GHz Low	Relative Humidity :	45~54%
Test Channel :	158	Test Engineer :	Osolemio Chang

WLAN 802.11ac VHT40 Channel 158

100kHz PSD reference Level

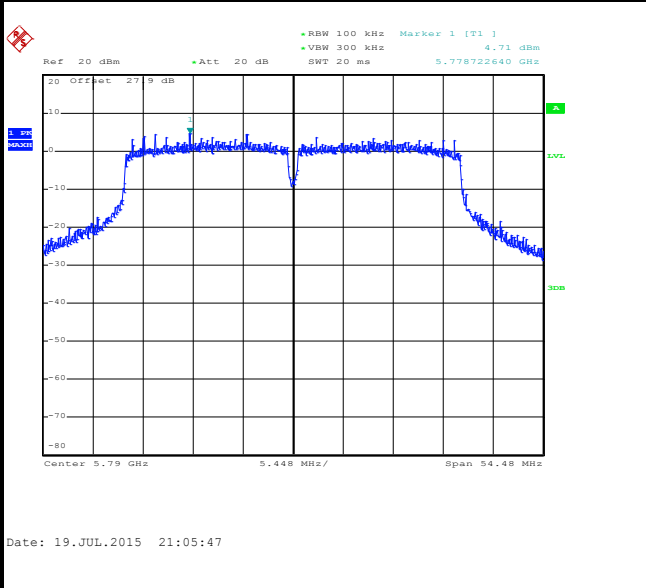

Spurious Emission 30MHz~3GHz

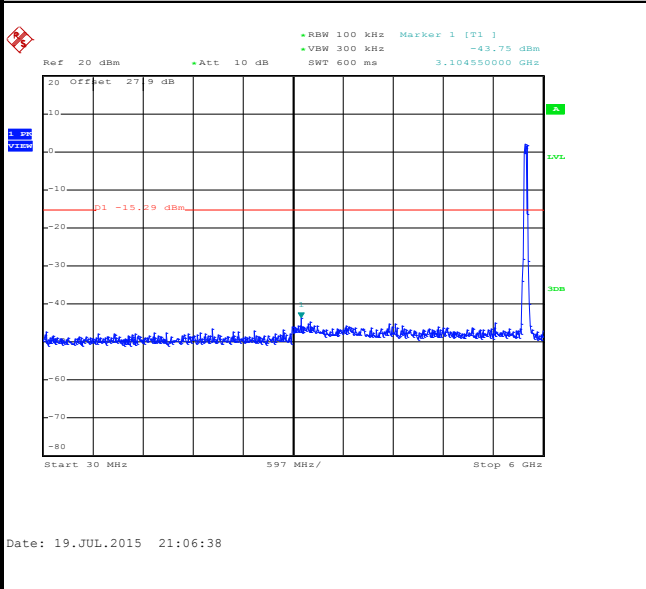

Spurious Emission 2GHz~25GHz

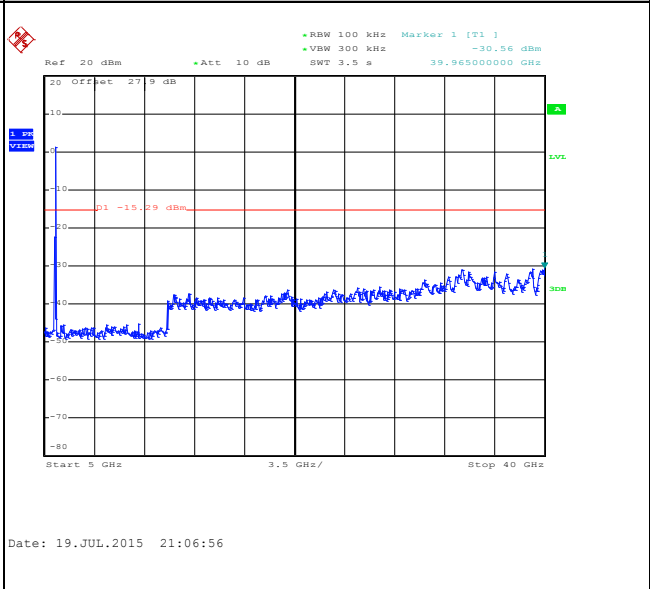



Number of TX :	2	Ant. :	2
Test Mode :	802.11ac VHT40	Temperature :	23~26°C
Test Band :	5GHz Low	Relative Humidity :	45~54%
Test Channel :	165	Test Engineer :	Osolemio Chang

WLAN 802.11ac VHT40 Channel 165

100kHz PSD reference Level

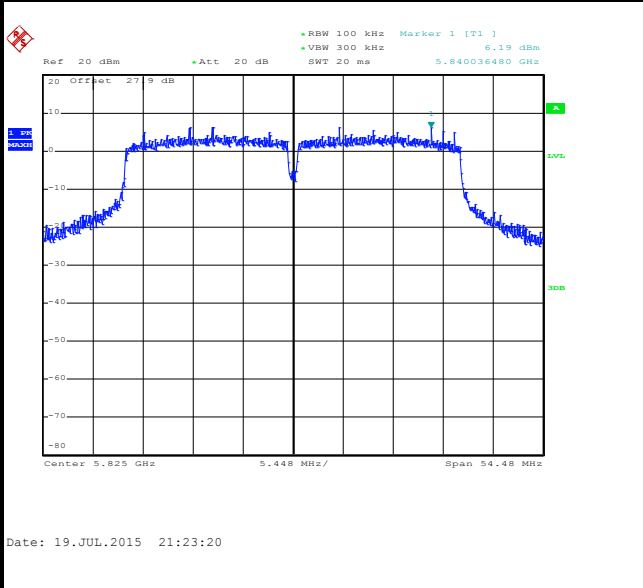

High Channel Plot

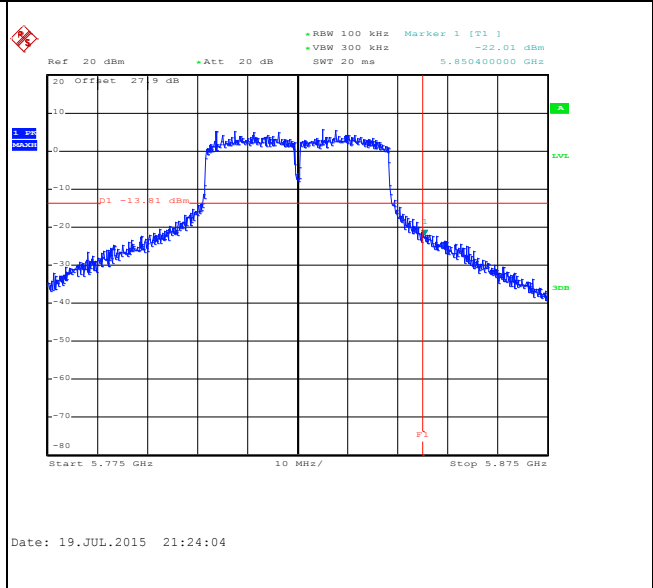

Spurious Emission 30MHz~3GHz

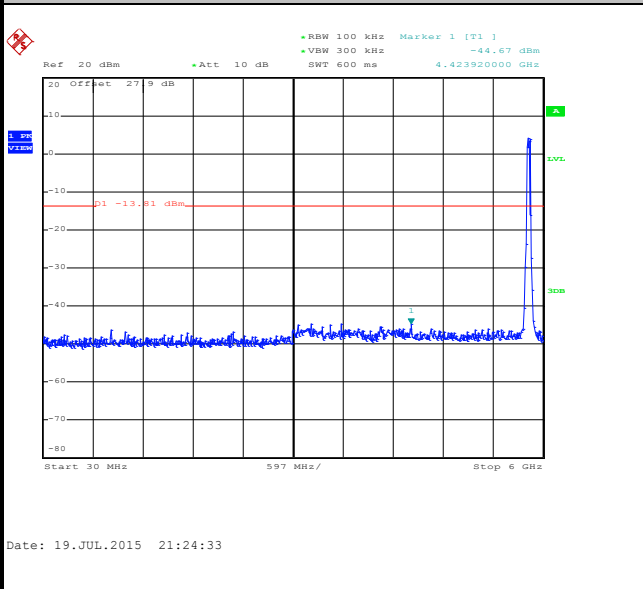

Spurious Emission 2GHz~25GHz

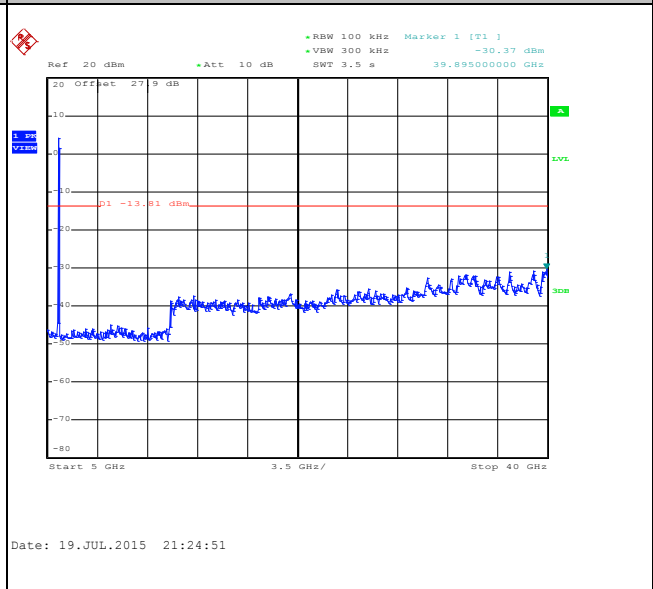



Number of TX :	2	Ant. :	2
Test Mode :	802.11ac VHT50	Temperature :	23~26°C
Test Band :	5GHz Low	Relative Humidity :	45~54%
Test Channel :	151	Test Engineer :	Osolemio Chang

WLAN 802.11ac VHT50 Channel 151

100kHz PSD reference Level

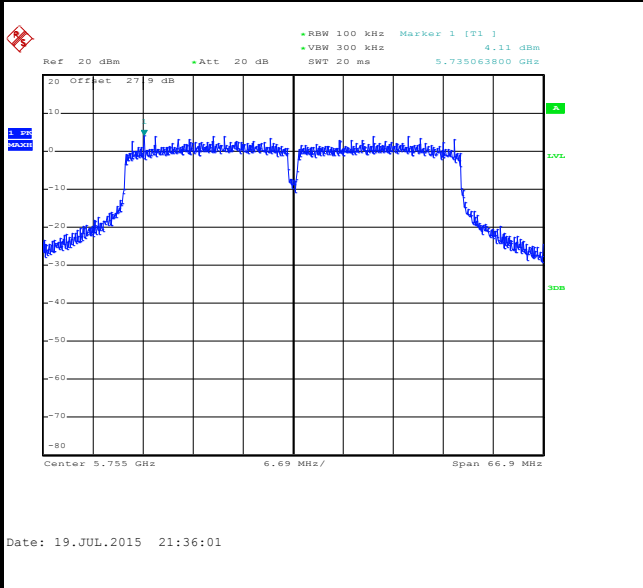

Low Channel Plot

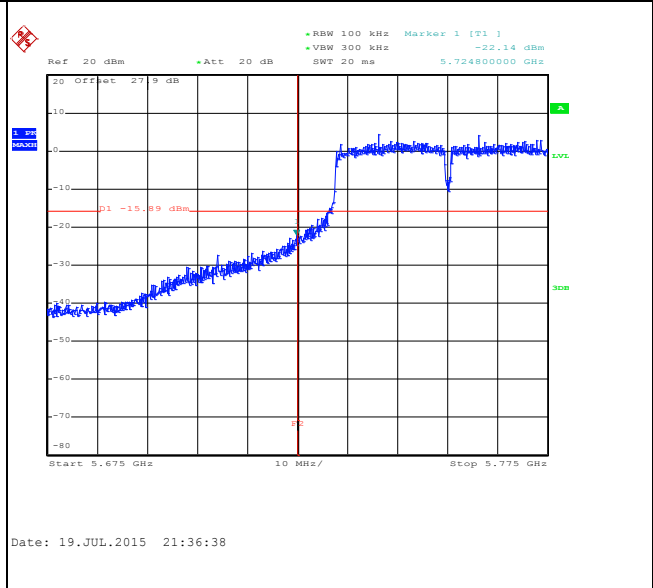

Spurious Emission 30MHz~3GHz

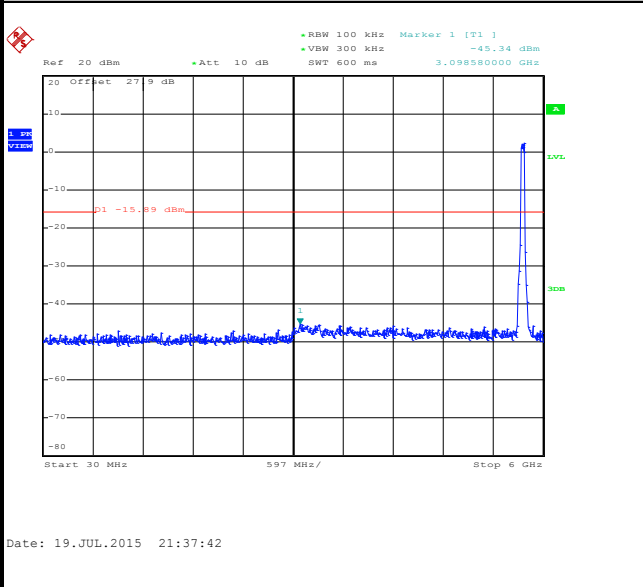

Spurious Emission 2GHz~25GHz

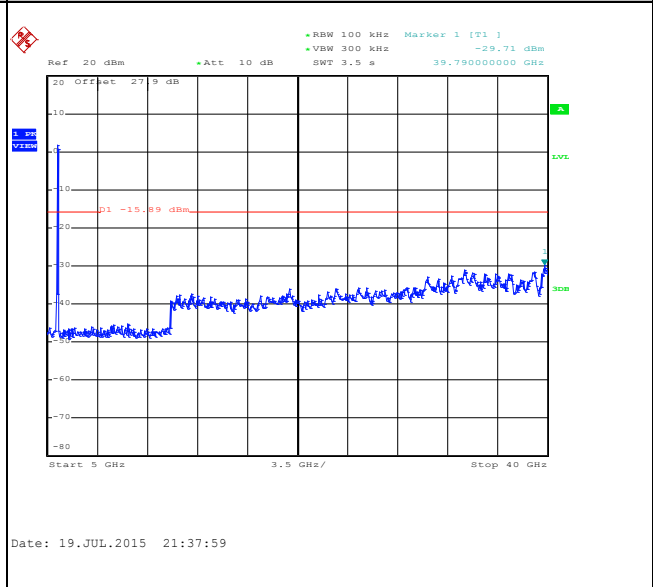



Number of TX :	2	Ant. :	2
Test Mode :	802.11ac VHT50	Temperature :	23~26°C
Test Band :	5GHz Low	Relative Humidity :	45~54%
Test Channel :	158	Test Engineer :	Osolemio Chang

WLAN 802.11ac VHT50 Channel 158

100kHz PSD reference Level

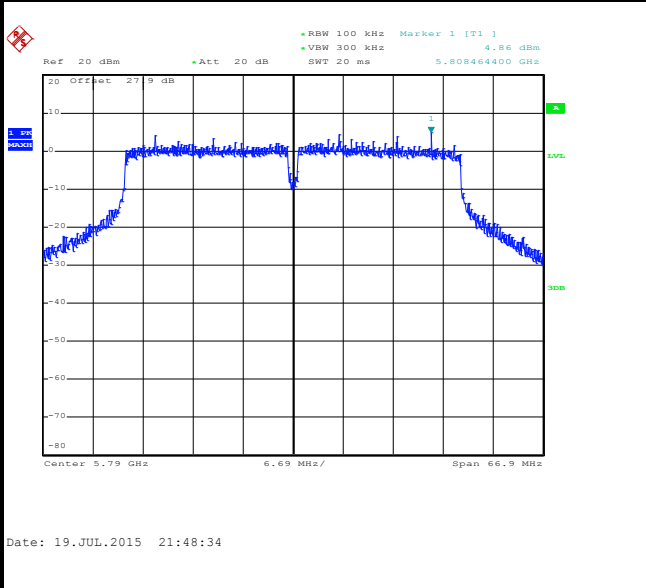

Spurious Emission 30MHz~3GHz

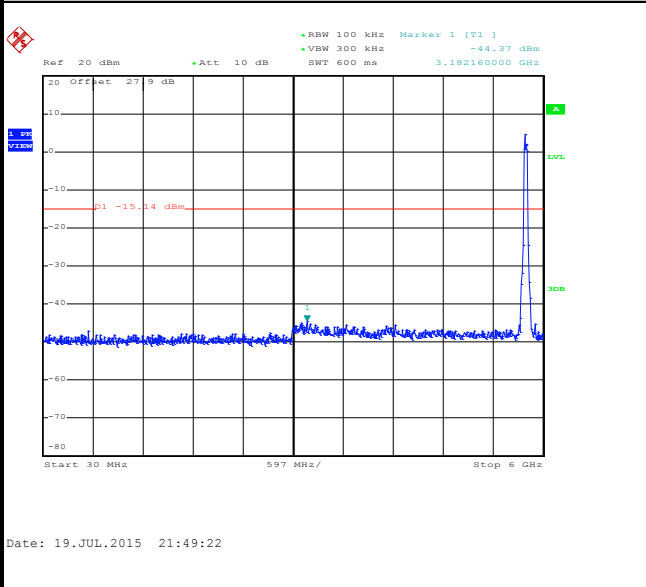

Spurious Emission 2GHz~25GHz

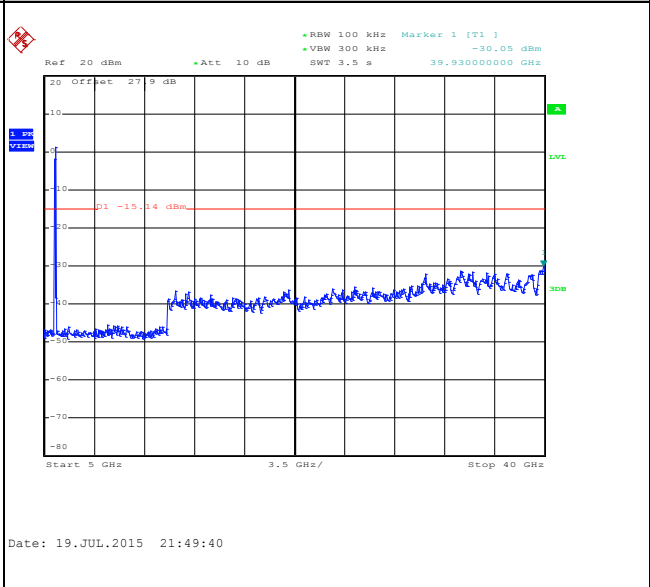



Number of TX :	2	Ant. :	2
Test Mode :	802.11ac VHT50	Temperature :	23~26°C
Test Band :	5GHz Low	Relative Humidity :	45~54%
Test Channel :	164	Test Engineer :	Osolemio Chang

WLAN 802.11ac VHT50 Channel 164

100kHz PSD reference Level

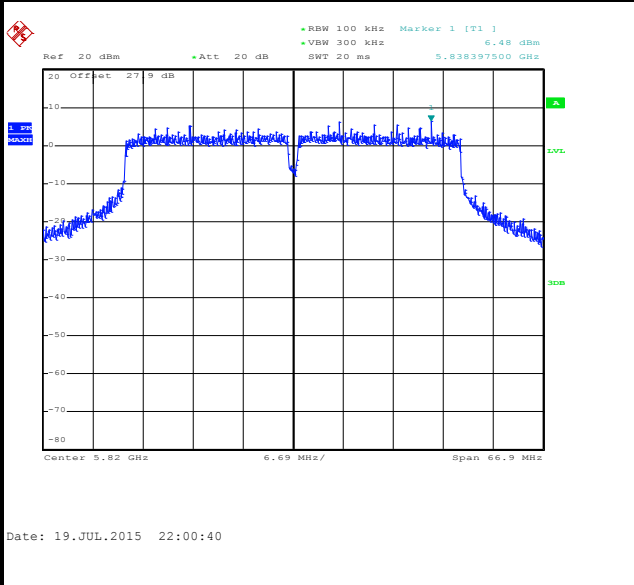

High Channel Plot

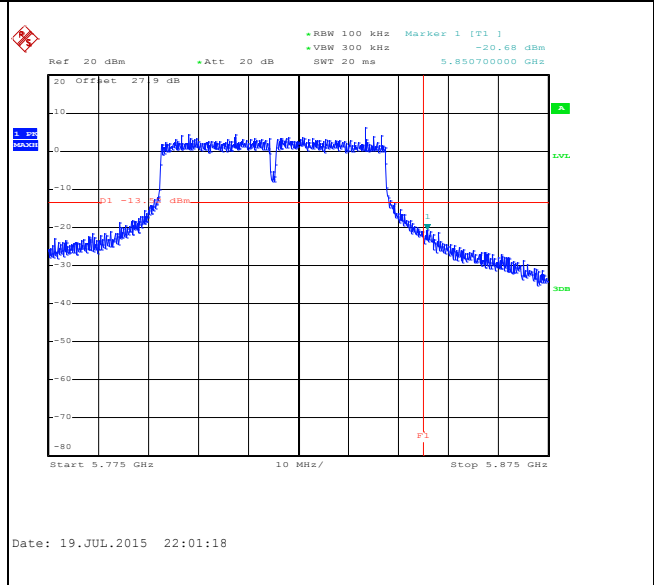

Spurious Emission 30MHz~3GHz

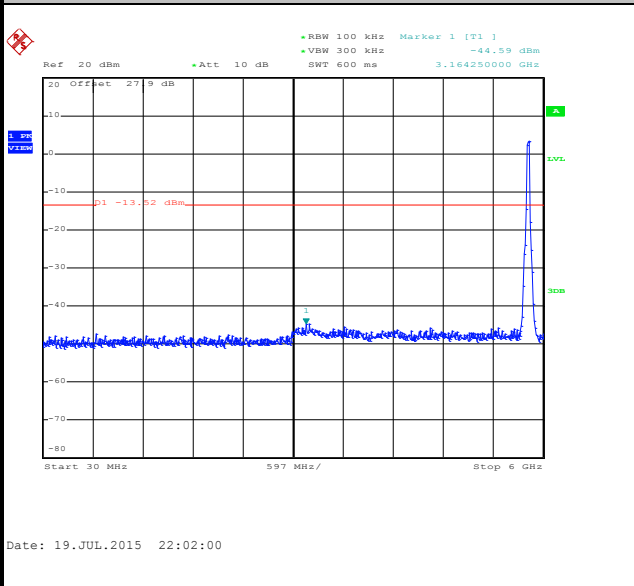

Spurious Emission 2GHz~25GHz

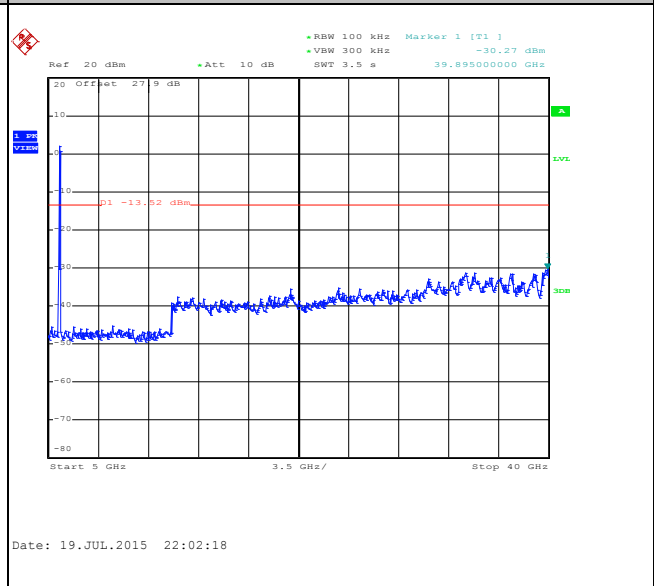



Number of TX :	2	Ant. :	2
Test Mode :	802.11ac VHT60	Temperature :	23~26°C
Test Band :	5GHz Low	Relative Humidity :	45~54%
Test Channel :	152	Test Engineer :	Osolemio Chang

WLAN 802.11ac VHT60 Channel 152

100kHz PSD reference Level

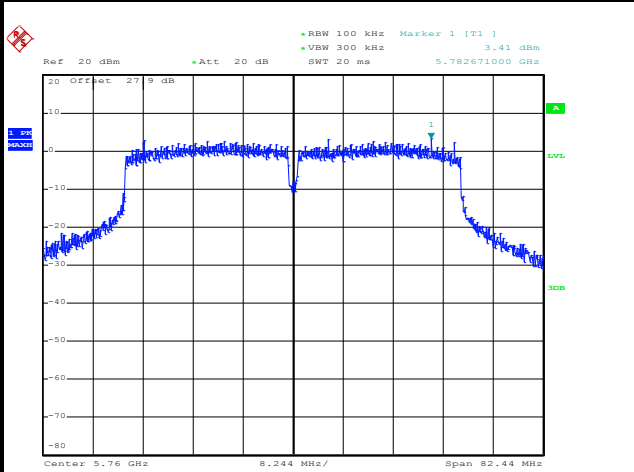

Date: 19.JUL.2015 22:14:38

Low Channel Plot

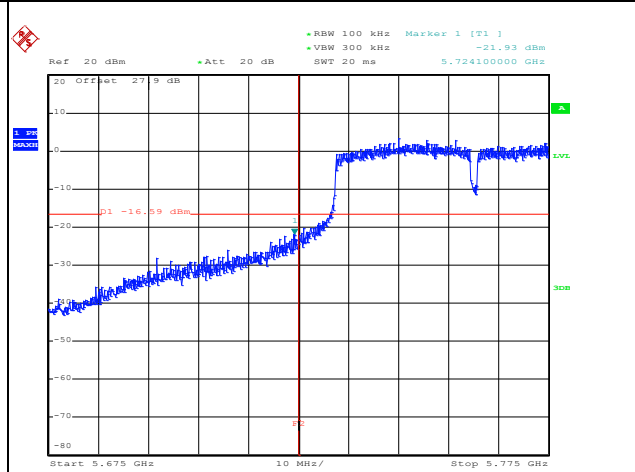

Date: 19.JUL.2015 22:15:17

Spurious Emission 30MHz~3GHz

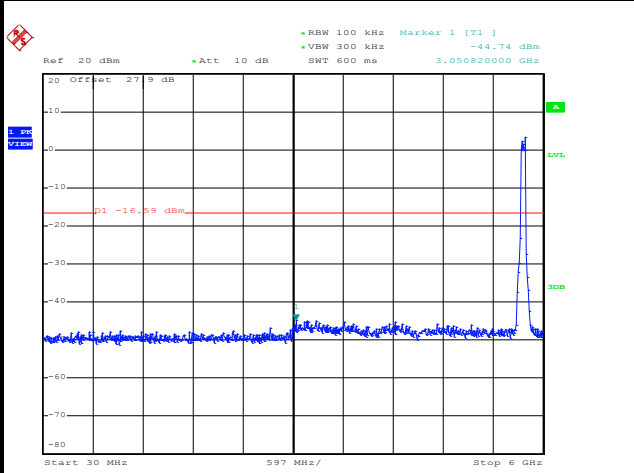

Date: 19.JUL.2015 22:16:14

Spurious Emission 2GHz~25GHz

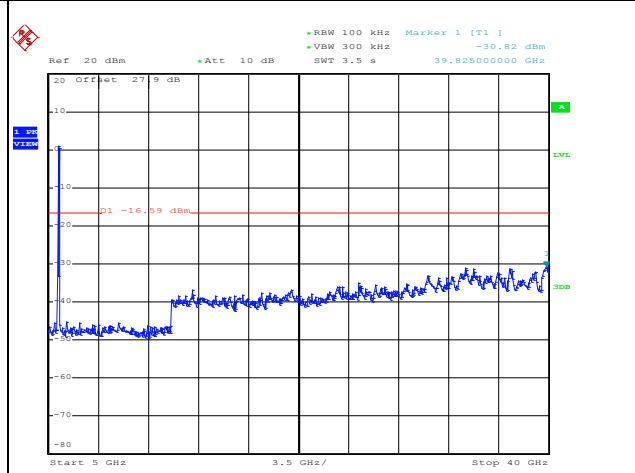

Date: 19.JUL.2015 22:16:32



Number of TX :	2	Ant. :	2
Test Mode :	802.11ac VHT60	Temperature :	23~26°C
Test Band :	5GHz Low	Relative Humidity :	45~54%
Test Channel :	158	Test Engineer :	Osolemio Chang

WLAN 802.11ac VHT60 Channel 158

100kHz PSD reference Level

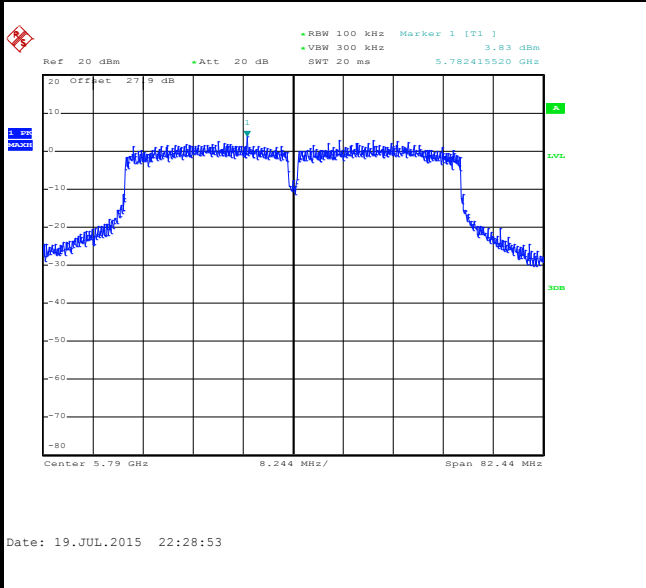

Spurious Emission 30MHz~3GHz

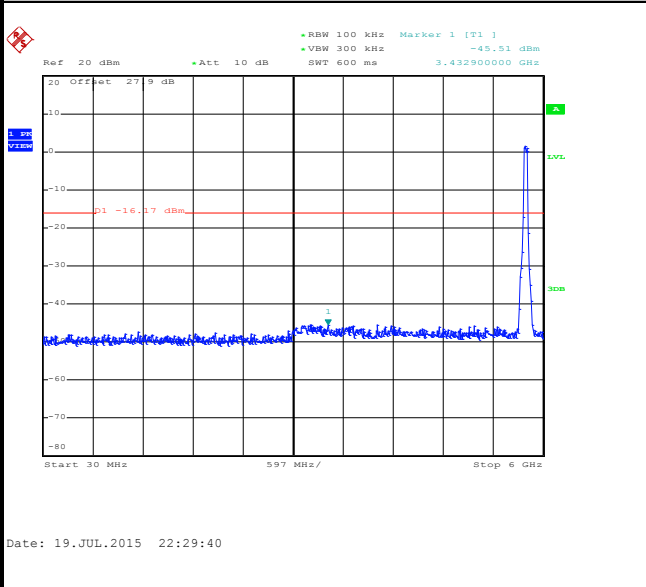

Spurious Emission 2GHz~25GHz

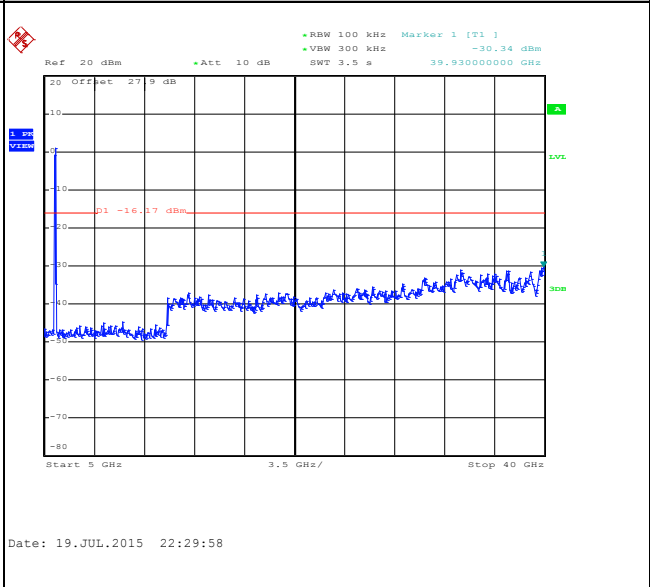



Number of TX :	2	Ant. :	2
Test Mode :	802.11ac VHT60	Temperature :	23~26°C
Test Band :	5GHz Low	Relative Humidity :	45~54%
Test Channel :	163	Test Engineer :	Osolemio Chang

WLAN 802.11ac VHT60 Channel 163

100kHz PSD reference Level

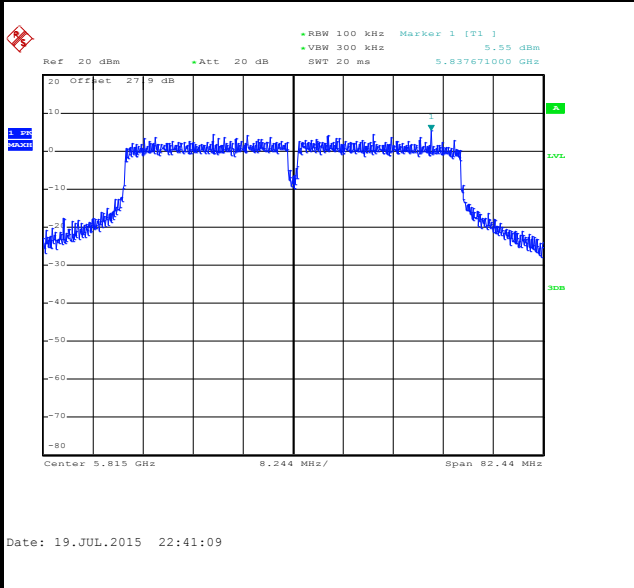

High Channel Plot

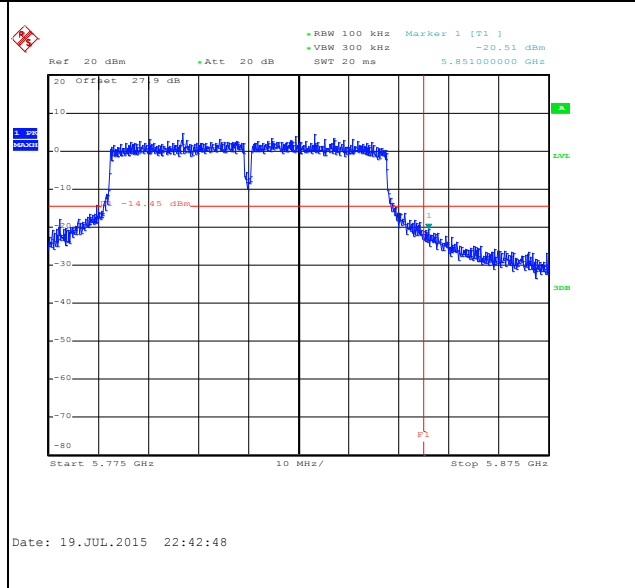

Spurious Emission 30MHz~3GHz

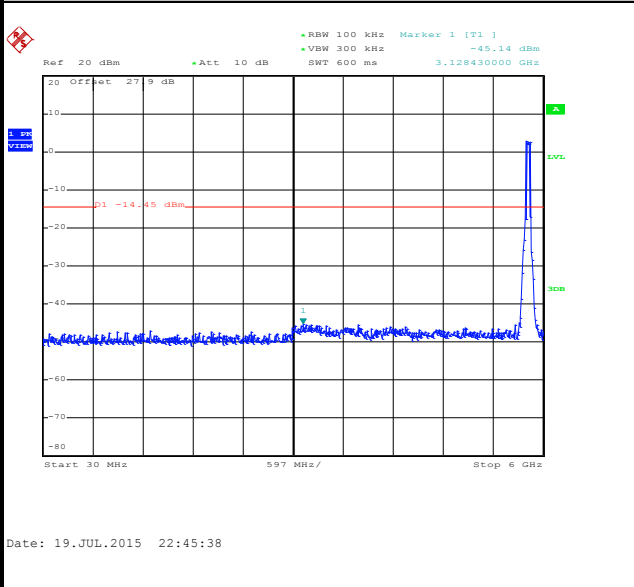

Spurious Emission 2GHz~25GHz

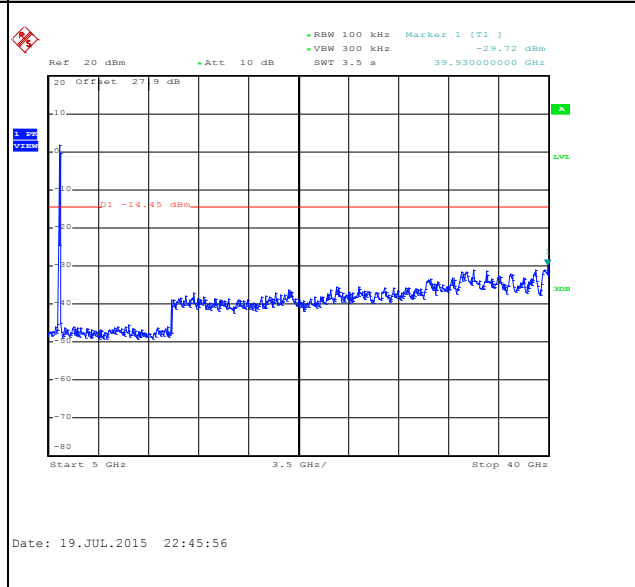



Number of TX :	2	Ant. :	2
Test Mode :	802.11ac VHT80	Temperature :	23~26°C
Test Band :	5GHz Low	Relative Humidity :	45~54%
Test Channel :	154	Test Engineer :	Osolemio Chang

WLAN 802.11ac VHT80 Channel 154

100kHz PSD reference Level

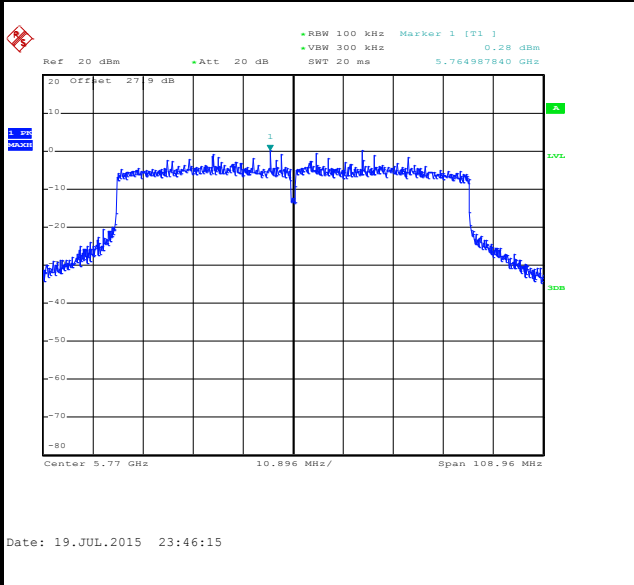

Low Channel Plot

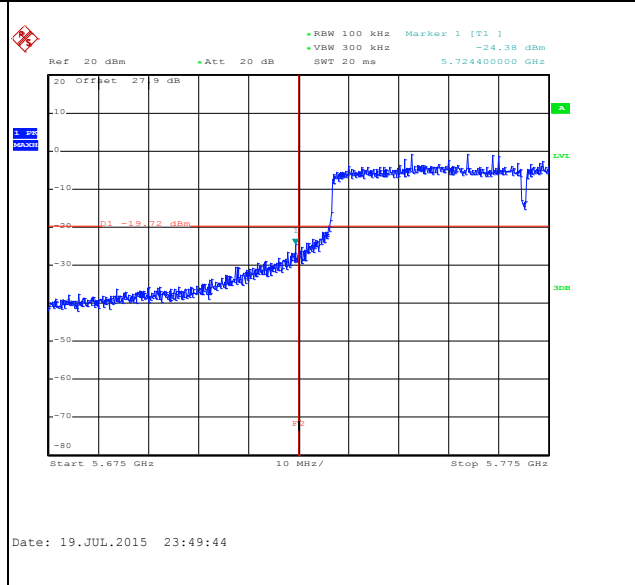

Spurious Emission 30MHz~3GHz

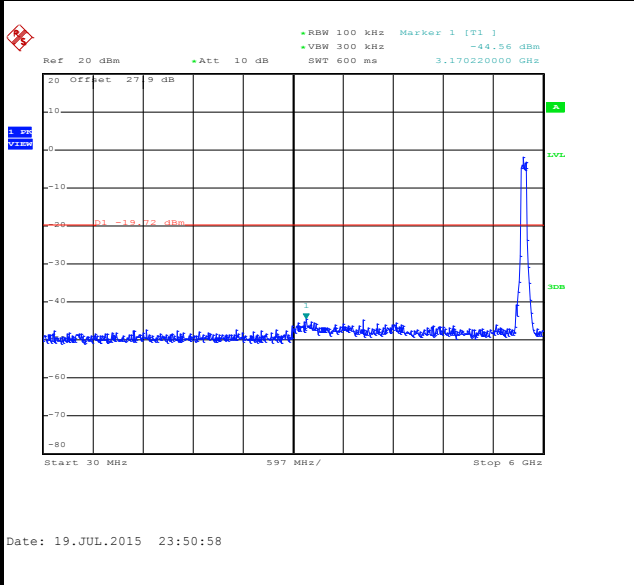

Spurious Emission 2GHz~25GHz

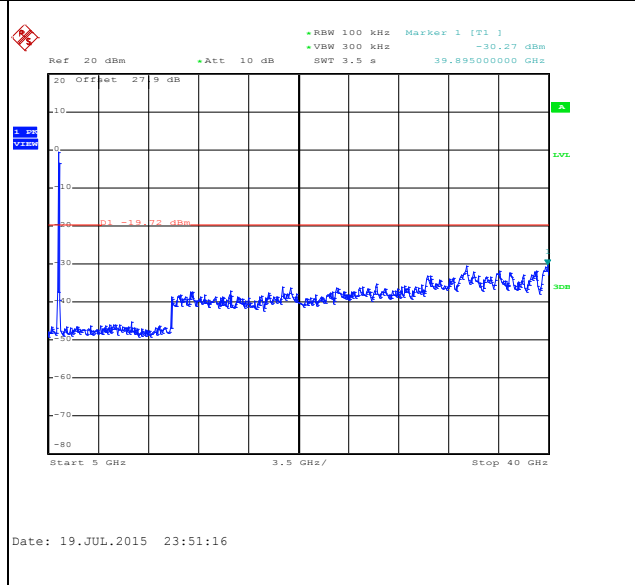



Number of TX :	2	Ant. :	2
Test Mode :	802.11ac VHT80	Temperature :	23~26°C
Test Band :	5GHz Low	Relative Humidity :	45~54%
Test Channel :	158	Test Engineer :	Osolemio Chang

WLAN 802.11ac VHT80 Channel 158

100kHz PSD reference Level

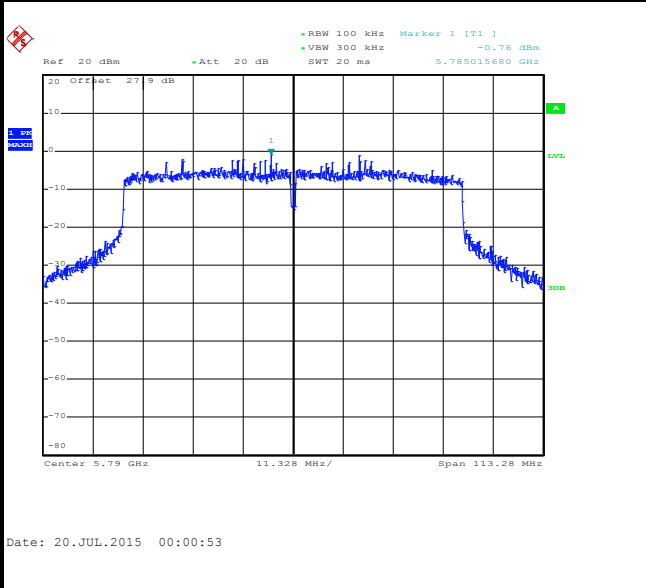

Spurious Emission 30MHz~3GHz

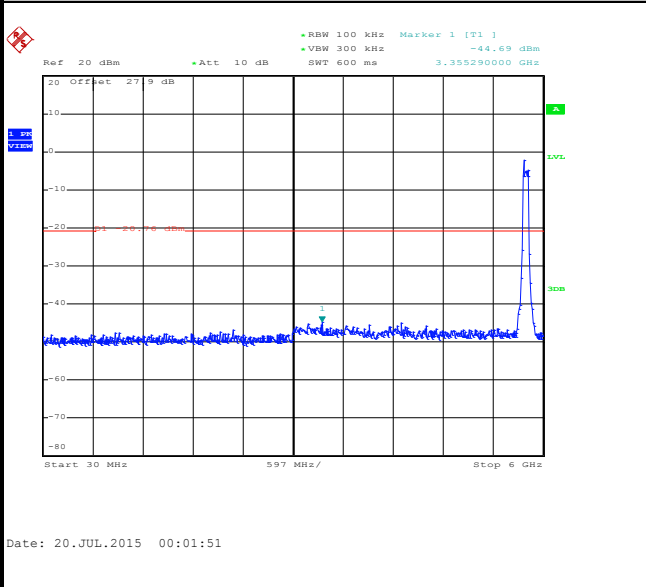

Spurious Emission 2GHz~25GHz

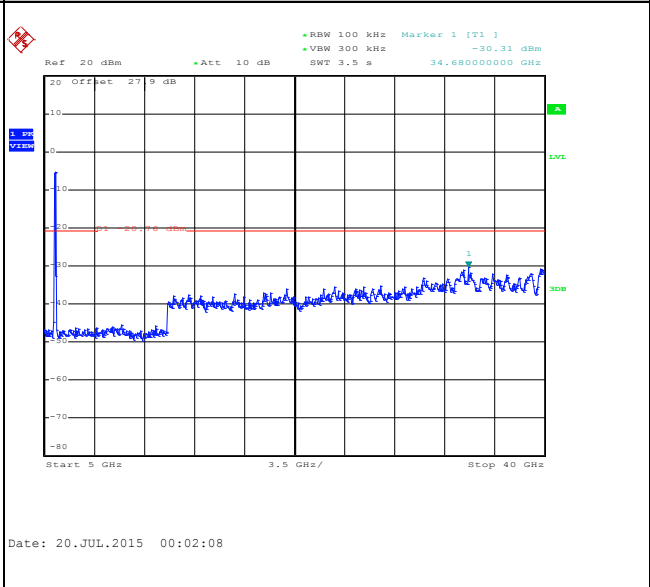



Number of TX :	2	Ant. :	2
Test Mode :	802.11ac VHT80	Temperature :	23~26°C
Test Band :	5GHz Low	Relative Humidity :	45~54%
Test Channel :	162	Test Engineer :	Osolemio Chang

WLAN 802.11ac VHT80 Channel 162

100kHz PSD reference Level

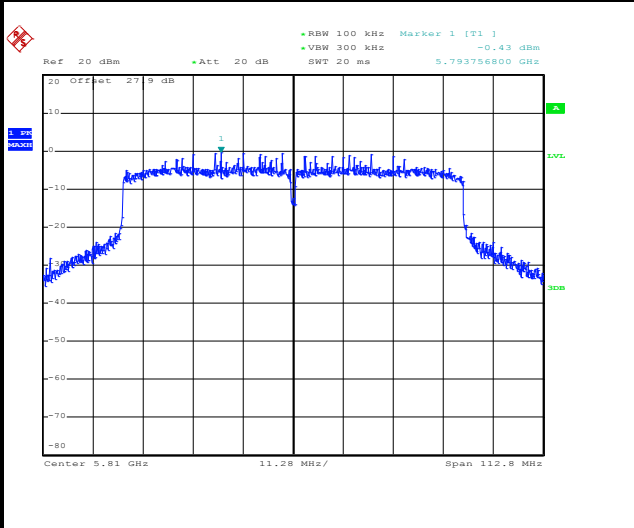

Date: 20.JUL.2015 00:14:22

High Channel Plot

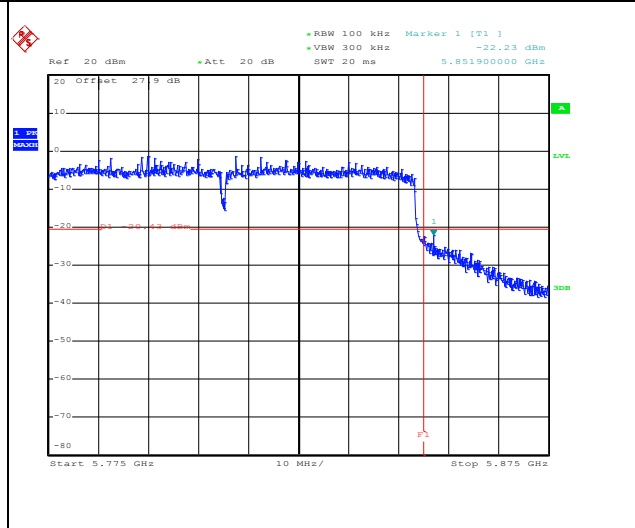

Date: 20.JUL.2015 00:15:57

Spurious Emission 30MHz~3GHz

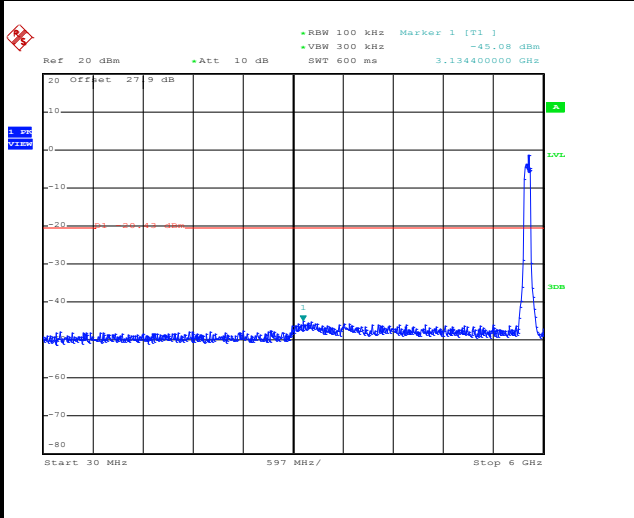

Date: 20.JUL.2015 00:16:56

Spurious Emission 2GHz~25GHz

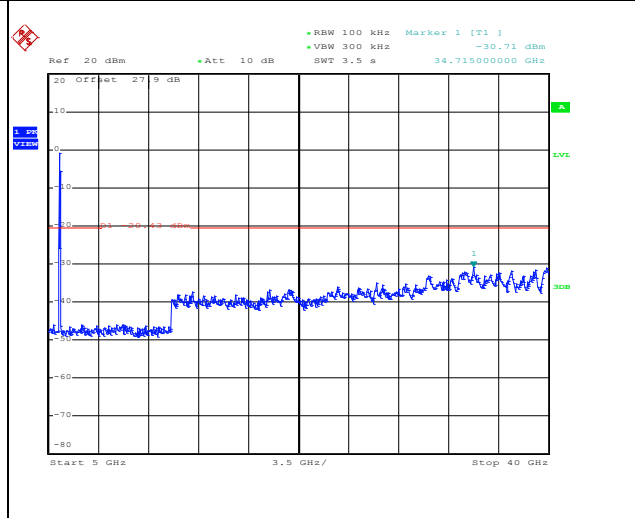

Date: 20.JUL.2015 00:17:14



3.5 Radiated Band Edges and Spurious Emission Measurement

3.5.1 Limit of Radiated band edge and Spurious Emission Measurement

In any 100 kHz bandwidth outside the intentional radiator frequency band, all harmonics/spurious must be at least 20 dB below the highest emission level within the authorized band. If the output power of this device was measured by spectrum analyzer, the attenuation under this paragraph shall be 30 dB instead of 20 dB. In addition, radiated emissions which fall in the restricted bands must also comply with the FCC section 15.209 limits as below.

Frequency (MHz)	Field Strength (microvolts/meter)	Measurement Distance (meters)
0.009 – 0.490	2400/F(kHz)	300
0.490 – 1.705	24000/F(kHz)	30
1.705 – 30.0	30	30
30 – 88	100	3
88 – 216	150	3
216 - 960	200	3
Above 960	500	3

3.5.2 Measuring Instruments

The measuring equipment is listed in the section 4 of this test report.



3.5.3 Test Procedure

1. The testing follows FCC KDB Publication No. 558074 D01 DTS Meas. Guidance v03r02.
2. The EUT was arranged to its worst case and then tune the antenna tower (from 1 m to 4 m) and turntable (from 0 degree to 360 degrees) to find the maximum reading. A pre-amp and a high pass filter are used for the test in order to get better signal level.
3. The EUT was placed on a turntable with 0.8 meter for frequency below 1GHz and 1.5 meter for frequency above 1GHz respectively above ground.
4. The EUT was set 3 meters from the interference receiving antenna, which was mounted on the top of a variable height antenna tower.
5. Corrected Reading: Antenna Factor + Cable Loss + Read Level - Preamp Factor = Level
6. For measurement below 1GHz, If the emission level of the EUT measured by the peak detector is 3 dB lower than the applicable limit, the peak emission level will be reported. Otherwise, the emission measurement will be repeated using the quasi-peak detector and reported.
7. Use the following spectrum analyzer settings:
 - (1) Span shall wide enough to fully capture the emission being measured;
 - (2) Set RBW=100 kHz for $f < 1$ GHz; VBW \geq RBW; Sweep = auto; Detector function = peak; Trace = max hold;
 - (3) Set RBW = 1 MHz, VBW= 3MHz for $f \geq 1$ GHz for peak measurement.
For average measurement:
 - VBW = 10 Hz, when duty cycle is no less than 98 percent.
 - VBW $\geq 1/T$, when duty cycle is less than 98 percent where T is the minimum transmission duration over which the transmitter is on and is transmitting at its maximum power control level for the tested mode of operation.



Antenna	Band	Duty Cycle(%)	T(us)	1/T(kHz)	VBW Setting
1+2	5GHz 802.11n VHT10 for Ant 1	100	-	-	10Hz
1+2	5GHz 802.11n VHT10 for Ant 2	100	-	-	
1+2	5GHz 802.11n VHT20 for Ant 1	100	-	-	
1+2	5GHz 802.11n VHT20 for Ant 2	100	-	-	
1+2	5GHz 802.11n VHT30 for Ant 1	100	-	-	
1+2	5GHz 802.11n VHT30 for Ant 2	100	-	-	
1+2	5GHz 802.11n VHT40 for Ant 1	100	-	-	
1+2	5GHz 802.11n VHT40 for Ant 2	100	-	-	
1+2	5GHz 802.11n VHT50 for Ant 1	100	-	-	
1+2	5GHz 802.11n VHT50 for Ant 2	100	-	-	
1+2	5GHz 802.11n VHT60 for Ant 1	99.06	-	-	
1+2	5GHz 802.11n VHT60 for Ant 2	99.06	-	-	
1+2	5GHz 802.11n VHT80 for Ant 1	98.67	-	-	
1+2	5GHz 802.11n VHT80 for Ant 2	98.67	-	-	

3.5.4 Test Setup

For radiated emissions below 30MHz

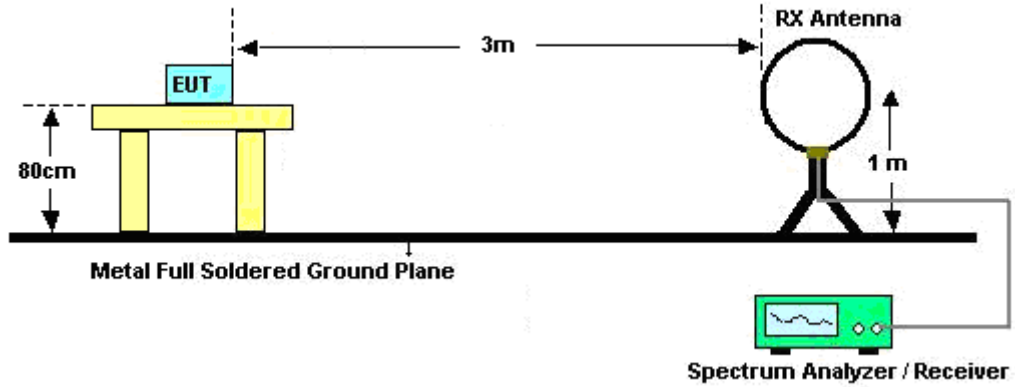

For radiated emissions from 30MHz to 1GHz

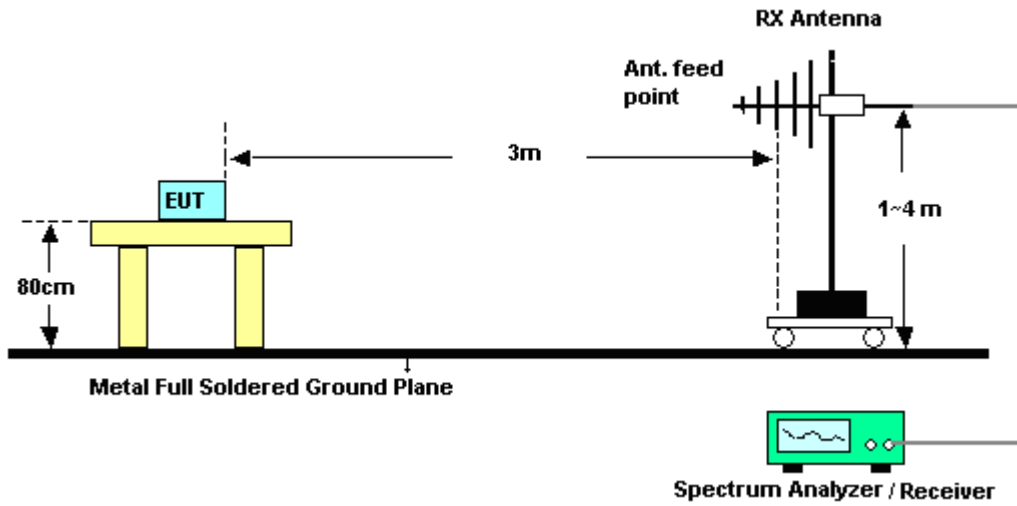

For radiated emissions above 1GHz

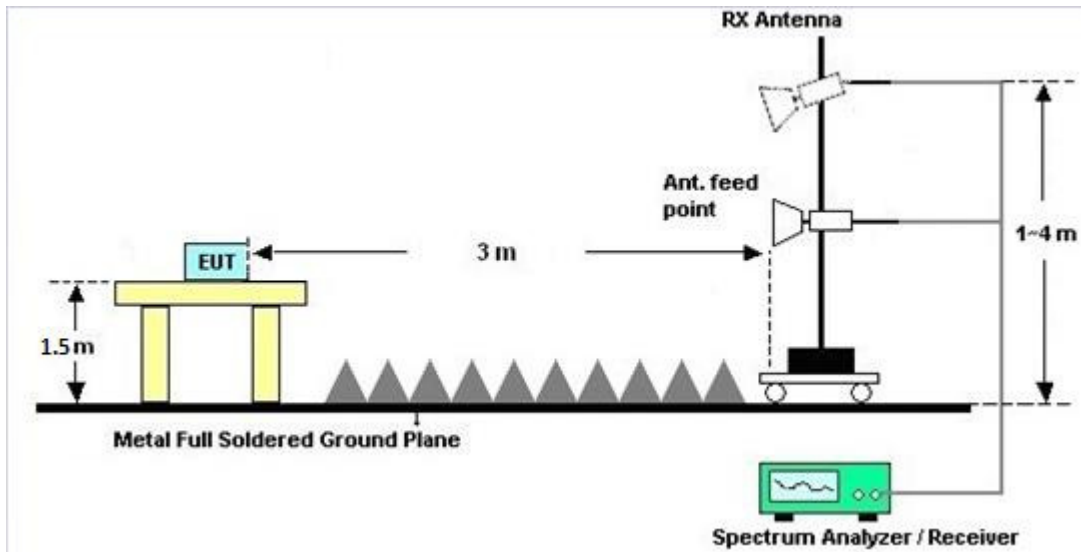

3.5.5 Test Results of Radiated Emissions (9kHz ~ 30MHz)

The low frequency, which started from 9 kHz to 30MHz, was pre-scanned and the result which was 20dB lower than the limit line per 15.31(o) was not reported.

3.5.6 Test Result of Radiated Spurious at Band Edges

Please refer to Appendix B of this report.

3.5.7 Test Result of Radiated Spurious Emission (30MHz ~ 10th Harmonic)

Please refer to Appendix B of this report.



3.6 AC Conducted Emission Measurement

3.6.1 Limit of AC Conducted Emission

For equipment that is designed to be connected to the public utility (AC) power line, the radio frequency voltage that is conducted back onto the AC power line on any frequency or frequencies within the band 150 kHz to 30 MHz shall not exceed the limits in the following table.

Frequency of Emission (MHz)	Conducted Limit (dB μ V)	
	Quasi-Peak	Average
0.15-0.5	66 to 56*	56 to 46*
0.5-5	56	46
5-30	60	50

*Decreases with the logarithm of the frequency.

3.6.2 Measuring Instruments

The measuring equipment is listed in the section 4 of this test report.

3.6.3 Test Procedures

1. The EUT was placed 0.4 meter from the conducting wall of the shielding room, and it was kept at least 80 centimeters from any other grounded conducting surface.
2. Connect EUT to the power mains through a line impedance stabilization network (LISN).
3. All the support units are connecting to the other LISN.
4. The LISN provides 50 ohm coupling impedance for the measuring instrument.
5. The FCC states that a 50 ohm, 50 microhenry LISN should be used.
6. Both sides of AC line were checked for maximum conducted interference.
7. The frequency range from 150 kHz to 30 MHz was searched.
8. Set the test-receiver system to Peak Detect Function and specified bandwidth (IF bandwidth = 9kHz) with Maximum Hold Mode.

3.6.4 Test Setup

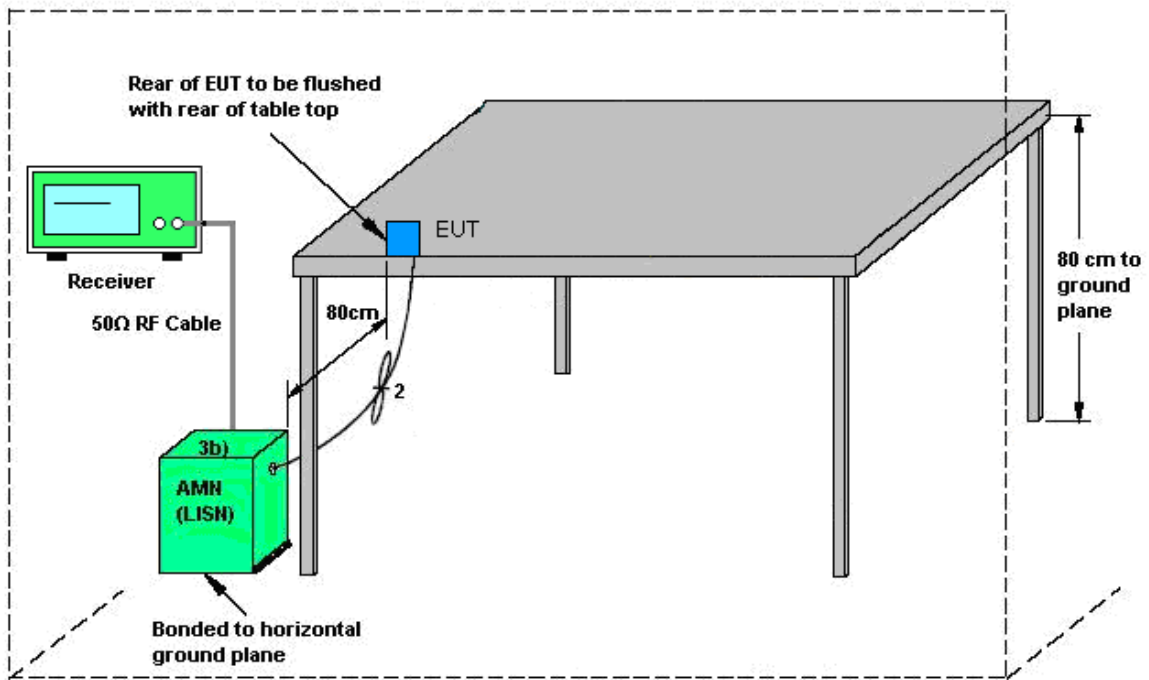

AMN = Artificial mains network (LISN)
AE = Associated equipment
EUT = Equipment under test
ISN = Impedance stabilization network



3.6.5 Test Result of AC Conducted Emission

Test Mode :	Mode 1	Temperature :	25~27°C
Test Engineer :	Eric Jeng	Relative Humidity :	58~61%
Test Voltage :	120Vac / 60Hz	Phase :	Line
Function Type :	WLAN Link + PoE + RJ45 Link		

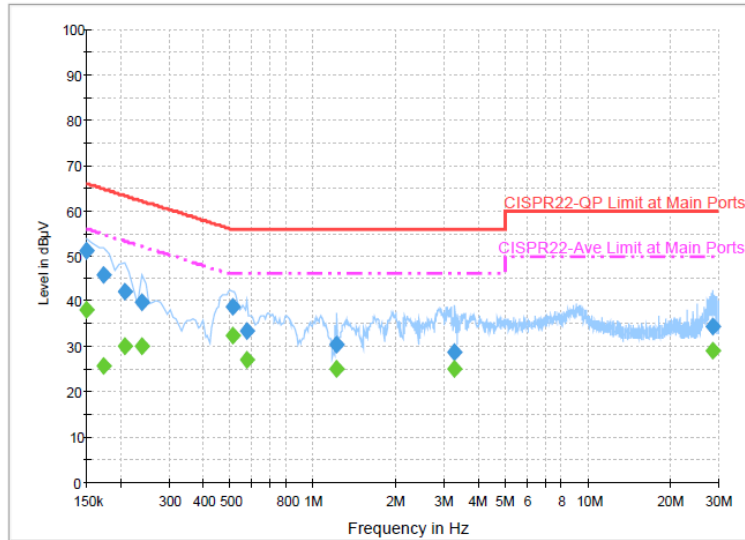

Final Result : QuasiPeak

Frequency (MHz)	QuasiPeak (dBµV)	Filter	Line	Corr. (dB)	Margin (dB)	Limit (dBµV)
0.150000	51.3	Off	L1	19.5	14.7	66.0
0.174000	45.7	Off	L1	19.5	19.1	64.8
0.206000	42.2	Off	L1	19.4	21.2	63.4
0.238000	39.6	Off	L1	19.5	22.6	62.2
0.510000	38.9	Off	L1	19.5	17.1	56.0
0.574000	33.5	Off	L1	19.5	22.5	56.0
1.222000	30.4	Off	L1	19.6	25.6	56.0
3.294000	28.9	Off	L1	19.7	27.1	56.0
28.502000	34.4	Off	L1	20.0	25.6	60.0

Final Result : Average

Frequency (MHz)	Average (dBµV)	Filter	Line	Corr. (dB)	Margin (dB)	Limit (dBµV)
0.150000	38.0	Off	L1	19.5	18.0	56.0
0.174000	25.6	Off	L1	19.5	29.2	54.8
0.206000	30.1	Off	L1	19.4	23.3	53.4
0.238000	30.1	Off	L1	19.5	22.1	52.2
0.510000	32.4	Off	L1	19.5	13.6	46.0
0.574000	26.9	Off	L1	19.5	19.1	46.0
1.222000	25.1	Off	L1	19.6	20.9	46.0
3.294000	25.1	Off	L1	19.7	20.9	46.0
28.502000	29.2	Off	L1	20.0	20.8	50.0



Test Mode :	Mode 1	Temperature :	25~27°C
Test Engineer :	Eric Jeng	Relative Humidity :	58~61%
Test Voltage :	120Vac / 60Hz	Phase :	Neutral
Function Type :	WLAN Link + PoE + RJ45 Link		

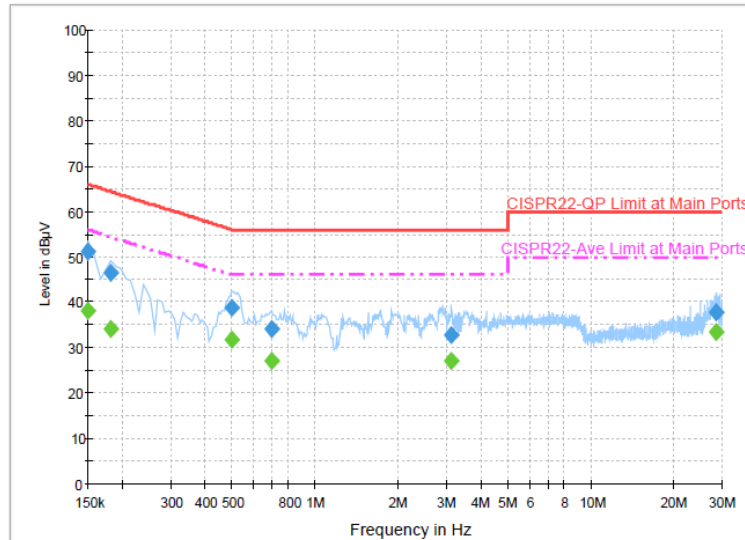

Final Result : QuasiPeak

Frequency (MHz)	QuasiPeak (dBµV)	Filter	Line	Corr. (dB)	Margin (dB)	Limit (dBµV)
0.150000	51.3	Off	N	19.5	14.7	66.0
0.182000	46.5	Off	N	19.5	17.9	64.4
0.502000	39.0	Off	N	19.4	17.0	56.0
0.694000	34.0	Off	N	19.6	22.0	56.0
3.126000	32.7	Off	N	19.7	23.3	56.0
28.686000	37.9	Off	N	20.2	22.1	60.0

Final Result : Average

Frequency (MHz)	Average (dBµV)	Filter	Line	Corr. (dB)	Margin (dB)	Limit (dBµV)
0.150000	38.1	Off	N	19.5	17.9	56.0
0.182000	34.2	Off	N	19.5	20.2	54.4
0.502000	31.8	Off	N	19.4	14.2	46.0
0.694000	27.1	Off	N	19.6	18.9	46.0
3.126000	27.2	Off	N	19.7	18.8	46.0
28.686000	33.4	Off	N	20.2	16.6	50.0



3.7 Antenna Requirements

3.7.1 Standard Applicable

Per 15.247(c)(1)(ii), systems operating in the 5725-5850 MHz band that are used exclusively for fixed, point-to-point operations may employ transmitting antennas with directional gain greater than 6 dBi without any corresponding reduction in transmitter conducted output power.

Per 15.247(e), for digitally modulated systems, the power spectral density conducted from the intentional radiator to the antenna shall not be greater than 8 dBm in any 3 kHz band during any time interval of continuous transmission. This power spectral density shall be determined in accordance with the provisions of 15.247 (b). The same method of determining the conducted output power shall be used to determine the power spectral density.

3.7.2 Antenna Anti-Replacement Construction

An embedded-in antenna design is used.

3.7.3 Antenna Gain

FCC KDB 662911 D01 Multiple Transmitter Output v02r01.

For CDD transmissions, directional gain is calculated as

Directional gain = $G_{ANT} + \text{Array Gain}$, where Array Gain is as follows.

For power spectral density (PSD) measurements on all devices,

Array Gain = $10 \log(N_{ANT}/N_{SS}=1)$ dB.

For power measurements on IEEE 802.11 devices,

Array Gain = 0 dB (i.e., no array gain) for $N_{ANT} \leq 4$.

The directional gain "DG" is calculated as following table.

			DG for Power (dBi)	DG for PSD (dBi)	Power Limit Reduction (dB)	PSD Limit Reduction (dB)
	Ant. 1 (dBi)	Ant. 2 (dBi)				
5 GHz	16.00	16.00	16.00	19.01	10.00	13.01



4 List of Measuring Equipment

Instrument	Manufacturer	Model No.	Serial No.	Characteristics	Calibration Date	Test Date	Due Date	Remark
Power Meter	Anritsu	ML2495A	1218006	300MHz~40GHz	Oct. 18, 2014	Jul. 18, 2015~ Jul. 20, 2015	Oct. 17, 2015	Conducted (TH05-HY)
Power Sensor	Anritsu	MA2411B	1126017	300MHz~40GHz	Oct. 18, 2014	Jul. 18, 2015~ Jul. 20, 2015	Oct. 17, 2015	Conducted (TH05-HY)
Spectrum Analyzer	Rohde & Schwarz	FSP40	100057	9kHz-40GHz	Oct. 17, 2014	Jul. 18, 2015~ Jul. 20, 2015	Oct. 16, 2015	Conducted (TH05-HY)
Preamplifier	MITEQ	AMF-7D-0010 1800-30-10P	1590074	1GHz~18GHz	Jul. 01, 2015	Jul. 15, 2015~ Jul. 17, 2015	Jun. 30, 2016	Radiation (03CH12-HY)
Preamplifier	COM-POWER	PA-103A	161075	10MHz~1GHz	Apr. 09, 2015	Jul. 15, 2015~ Jul. 17, 2015	Apr. 08, 2016	Radiation (03CH12-HY)
EMI Test Receiver	Rohde & Schwarz	ESU26	100472	20Hz~26.5GHz	Jan. 19, 2015	Jul. 15, 2015~ Jul. 17, 2015	Jan. 18, 2016	Radiation (03CH12-HY)
Horn Antenna	SCHWARZBE CK	BBHA 9120 D	9120D-124 1	1GHz ~ 18GHz	Apr. 22, 2015	Jul. 15, 2015~ Jul. 17, 2015	Apr. 21, 2016	Radiation (03CH12-HY)
SHF-EHF Horn Antenna	SCHWARZBE CK	BBHA 9170	BBHA9170 251	18GHz- 40GHz	Oct. 02, 2014	Jul. 15, 2015~ Jul. 17, 2015	Oct. 01, 2015	Radiation (03CH12-HY)
Preamplifier	Agilent	8449B	3008A023 75	1GHz~26.5GHz	Jan. 15, 2015	Jul. 15, 2015~ Jul. 17, 2015	Jan. 14, 2016	Radiation (03CH12-HY)
Antenna Mast	EMEC	AM-BS-4500- B	N/A	1m~4m	N/A	Jul. 15, 2015~ Jul. 17, 2015	N/A	Radiation (03CH12-HY)
Turn Table	EMEC	TT2000	N/A	0-360 degre	N/A	Jul. 15, 2015~ Jul. 17, 2015	N/A	Radiation (03CH12-HY)
EMI Test Receiver	Rohde & Schwarz	ESCS 30	100356	9kHz – 2.75GHz	Dec. 01, 2014	Jul. 13, 2015	Nov. 30, 2015	Conduction (CO05-HY)
LISN	Rohde & Schwarz	ENV216	100080	9kHz~30MHz	Dec. 02, 2014	Jul. 13, 2015	Dec. 01, 2015	Conduction (CO05-HY)
AC Power Source	ChainTek	APC-1000W	N/A	N/A	N/A	Jul. 13, 2015	N/A	Conduction (CO05-HY)
LISN (for auxiliary equipment)	Rohde & Schwarz	ENV216	100081	9kHz~30MHz	Dec. 08, 2014	Jul. 13, 2015	Dec. 07, 2015	Conduction (CO05-HY)



5 Uncertainty of Evaluation

Uncertainty of Conducted Emission Measurement (150kHz ~ 30MHz)

Measuring Uncertainty for a Level of Confidence of 95% ($U = 2Uc(y)$)	2.26
---	------

Uncertainty of Radiated Emission Measurement (30 MHz ~ 1000 MHz)

Measuring Uncertainty for a Level of Confidence of 95% ($U = 2Uc(y)$)	5.10
---	------



Appendix A. Conducted Test Results

Test Engineer:	Osolemio Chang	Temperature:	23.4	°C
Test Date:	2015/7/20	Relative Humidity:	53.7	%

IC 5.8GHz Band										
Mod.	Data Rate	NTX	Channel	Freq. (MHz)	99% Occupied BW (MHz)		6dB BW (MHz)		6dB BW Limit (MHz)	Pass/Fail
					Ant 1	Ant 2	Ant 1	Ant 2		
VHT10	MCS0	2	147	5735	10.36	10.34	8.82	8.84	0.50	Pass
VHT10	MCS0	2	158	5790	10.48	10.44	8.86	8.84	0.50	Pass
VHT10	MCS0	2	168	5840	10.32	10.28	8.84	8.84	0.50	Pass
VHT20	MCS0	2	148	5740	18.78	18.75	17.56	17.52	0.50	Pass
VHT20	MCS0	2	158	5790	19.02	18.96	17.60	17.60	0.50	Pass
VHT20	MCS0	2	167	5835	18.87	18.84	17.56	17.56	0.50	Pass
VHT30	MCS0	2	149	5745	27.81	27.86	26.58	26.58	0.50	Pass
VHT30	MCS0	2	158	5790	28.17	27.81	26.52	26.52	0.50	Pass
VHT30	MCS0	2	166	5830	28.13	27.81	26.62	26.52	0.50	Pass
VHT40	MCS0	2	150	5750	36.96	36.72	36.40	36.08	0.50	Pass
VHT40	MCS0	2	158	5790	36.78	36.72	35.76	36.32	0.50	Pass
VHT40	MCS0	2	165	5825	37.02	36.78	36.08	36.32	0.50	Pass
VHT50	MCS0	2	151	5755	45.15	45.00	44.10	44.60	0.50	Pass
VHT50	MCS0	2	158	5790	45.23	45.23	44.30	44.60	0.50	Pass
VHT50	MCS0	2	164	5820	45.30	45.38	44.60	44.60	0.50	Pass
VHT60	MCS0	2	152	5760	55.26	55.08	54.96	54.96	0.50	Pass
VHT60	MCS0	2	158	5790	55.44	55.08	54.60	54.96	0.50	Pass
VHT60	MCS0	2	163	5815	55.53	55.53	54.96	54.96	0.50	Pass
VHT80	MCS0	2	154	5770	75.96	75.96	68.96	72.64	0.50	Pass
VHT80	MCS0	2	158	5790	75.84	75.84	69.28	75.52	0.50	Pass
VHT80	MCS0	2	162	5810	76.20	76.20	71.68	75.20	0.50	Pass

IC 5.8GHz Band																
Mod.	Data Rate	N _{TX}	Channel	Freq. (MHz)	Peak Conducted Power (dBm)			Conducted Power Limit (dBm)		DG (dBi)		EIRP Power (dBm)		EIRP Power Limit (dBm)		Pass /Fail
					Ant 1	Ant 2	SUM	Ant 1	Ant 2	Ant 1	Ant 2	Ant 1	Ant 2	Ant 1	Ant 2	
VHT10	MCS0	2	147	5735	26.87	26.97	29.93	30.00	16.00	16.00	45.93	46.00	46.00	46.00	Pass	
VHT10	MCS0	2	158	5790	26.79	26.10	29.47	30.00	16.00	16.00	45.47	46.00	46.00	46.00	Pass	
VHT10	MCS0	2	168	5840	26.66	25.98	29.34	30.00	16.00	16.00	45.34	46.00	46.00	46.00	Pass	
VHT20	MCS0	2	148	5740	26.94	26.61	29.79	30.00	16.00	16.00	45.79	46.00	46.00	46.00	Pass	
VHT20	MCS0	2	158	5790	26.92	26.14	29.56	30.00	16.00	16.00	45.56	46.00	46.00	46.00	Pass	
VHT20	MCS0	2	167	5835	26.88	26.45	29.68	30.00	16.00	16.00	45.68	46.00	46.00	46.00	Pass	
VHT30	MCS0	2	149	5745	26.91	26.33	29.64	30.00	16.00	16.00	45.64	46.00	46.00	46.00	Pass	
VHT30	MCS0	2	158	5790	26.85	26.04	29.47	30.00	16.00	16.00	45.47	46.00	46.00	46.00	Pass	
VHT30	MCS0	2	166	5830	26.70	25.93	29.34	30.00	16.00	16.00	45.34	46.00	46.00	46.00	Pass	
VHT40	MCS0	2	150	5750	26.70	24.50	28.75	30.00	16.00	16.00	44.75	46.00	46.00	46.00	Pass	
VHT40	MCS0	2	158	5790	26.38	24.25	28.45	30.00	16.00	16.00	44.45	46.00	46.00	46.00	Pass	
VHT40	MCS0	2	165	5825	26.82	25.56	29.25	30.00	16.00	16.00	45.25	46.00	46.00	46.00	Pass	
VHT50	MCS0	2	151	5755	26.75	24.65	28.84	30.00	16.00	16.00	44.84	46.00	46.00	46.00	Pass	
VHT50	MCS0	2	158	5790	26.36	24.03	28.36	30.00	16.00	16.00	44.36	46.00	46.00	46.00	Pass	
VHT50	MCS0	2	164	5820	26.85	25.73	29.34	30.00	16.00	16.00	45.34	46.00	46.00	46.00	Pass	
VHT60	MCS0	2	152	5760	26.77	24.49	28.79	30.00	16.00	16.00	44.79	46.00	46.00	46.00	Pass	
VHT60	MCS0	2	158	5790	26.30	24.38	28.46	30.00	16.00	16.00	44.46	46.00	46.00	46.00	Pass	
VHT60	MCS0	2	163	5815	26.98	25.63	29.37	30.00	16.00	16.00	45.37	46.00	46.00	46.00	Pass	
VHT80	MCS0	2	154	5770	26.55	25.44	29.04	30.00	16.00	16.00	45.04	46.00	46.00	46.00	Pass	
VHT80	MCS0	2	158	5790	27.08	24.60	29.02	30.00	16.00	16.00	45.02	46.00	46.00	46.00	Pass	
VHT80	MCS0	2	162	5810	27.23	25.51	29.46	30.00	16.00	16.00	45.46	46.00	46.00	46.00	Pass	

Note: Measured power (dBm) has offset with cable loss.

IC 5.8GHz Band									
Mod.	Data Rate	N _{TX}	Channel	Freq. (MHz)	Duty Factor (dB)		Average Conducted Power (dBm)		
					Ant 1	Ant 2	Ant 1	Ant 2	SUM
VHT10	MCS0	2	147	5735	0.00	0.00	23.49	23.58	26.55
VHT10	MCS0	2	158	5790	0.00	0.00	23.29	22.20	25.79
VHT10	MCS0	2	168	5840	0.00	0.00	23.14	22.09	25.66
VHT20	MCS0	2	148	5740	0.00	0.00	23.30	22.74	26.04
VHT20	MCS0	2	158	5790	0.00	0.00	23.32	22.13	25.78
VHT20	MCS0	2	167	5835	0.00	0.00	23.34	22.65	26.02
VHT30	MCS0	2	149	5745	0.00	0.00	23.50	22.38	25.99
VHT30	MCS0	2	158	5790	0.00	0.00	23.41	22.04	25.79
VHT30	MCS0	2	166	5830	0.00	0.00	23.26	21.72	25.57
VHT40	MCS0	2	150	5750	0.00	0.00	22.87	19.79	24.61
VHT40	MCS0	2	158	5790	0.00	0.00	22.23	19.78	24.19
VHT40	MCS0	2	165	5825	0.00	0.00	23.22	20.92	25.23
VHT50	MCS0	2	151	5755	0.00	0.00	22.95	19.81	24.67
VHT50	MCS0	2	158	5790	0.00	0.00	22.30	19.68	24.19
VHT50	MCS0	2	164	5820	0.00	0.00	23.18	21.47	25.42
VHT60	MCS0	2	152	5760	0.04	0.04	23.13	20.03	24.86
VHT60	MCS0	2	158	5790	0.04	0.04	22.48	19.71	24.32
VHT60	MCS0	2	163	5815	0.04	0.04	23.14	21.40	25.37
VHT80	MCS0	2	154	5770	0.06	0.06	17.81	16.57	20.24
VHT80	MCS0	2	158	5790	0.06	0.06	18.53	15.57	20.31
VHT80	MCS0	2	162	5810	0.06	0.06	18.46	16.51	20.60

Note: Measured power (dBm) has offset with cable loss.

IC 5.8GHz Band												
Mod.	Data Rate	NTX	Channel	Freq. (MHz)	Peak PSD (dBm/3kHz)			Antenna Gain		Peak PSD Limit (dBm/3kHz)		Pass/Fail
					Ant 1	Ant 2	Worse + 3.01	Ant 1	Ant 2	Ant 1	Ant 2	
VHT10	MCS0	2	147	5735	0.38	-0.84	3.39	19.01		8.00		Pass
VHT10	MCS0	2	158	5790	-0.10	-0.13	2.91	19.01		8.00		Pass
VHT10	MCS0	2	168	5840	-0.29	-2.22	2.72	19.01		8.00		Pass
VHT20	MCS0	2	148	5740	-2.97	-2.69	0.32	19.01		8.00		Pass
VHT20	MCS0	2	158	5790	-3.18	-4.64	-0.17	19.01		8.00		Pass
VHT20	MCS0	2	167	5835	-2.28	-4.96	0.73	19.01		8.00		Pass
VHT30	MCS0	2	149	5745	-4.37	-5.39	-1.36	19.01		8.00		Pass
VHT30	MCS0	2	158	5790	-4.48	-5.21	-1.47	19.01		8.00		Pass
VHT30	MCS0	2	166	5830	-4.57	-4.88	-1.56	19.01		8.00		Pass
VHT40	MCS0	2	150	5750	-6.02	-9.16	-3.01	19.01		8.00		Pass
VHT40	MCS0	2	158	5790	-6.82	-8.42	-3.81	19.01		8.00		Pass
VHT40	MCS0	2	165	5825	-5.77	-7.67	-2.76	19.01		8.00		Pass
VHT50	MCS0	2	151	5755	-6.47	-10.23	-3.46	19.01		8.00		Pass
VHT50	MCS0	2	158	5790	-7.00	-10.94	-3.99	19.01		8.00		Pass
VHT50	MCS0	2	164	5820	-6.67	-8.02	-3.66	19.01		8.00		Pass
VHT60	MCS0	2	152	5760	-7.09	-10.39	-4.08	19.01		8.00		Pass
VHT60	MCS0	2	158	5790	-7.57	-11.35	-4.56	19.01		8.00		Pass
VHT60	MCS0	2	163	5815	-7.69	-9.56	-4.68	19.01		8.00		Pass
VHT80	MCS0	2	154	5770	-11.76	-15.85	-8.75	19.01		8.00		Pass
VHT80	MCS0	2	158	5790	-12.57	-15.29	-9.56	19.01		8.00		Pass
VHT80	MCS0	2	162	5810	-13.01	-15.29	-10.00	19.01		8.00		Pass

Measured power density (dBm) has offset with cable loss.



Appendix B. Radiated Spurious Emission

Test Engineer :	Elvis Chen, Stan Hsieh, and Karl Hou	Temperature :	22~25°C
		Relative Humidity :	55~58%

15C Band 4 5750~5850MHz

WIFI 802.11ac VHT10 (Harmonic @ 3m)

WIFI	Note	Frequency	Level	Over	Limit	Read	Antenna	Cable	Preamp	Ant	Table	Peak	Pol.
Ant.				Limit	Line	Level	Factor	Loss	Factor	Pos	Pos	Avg.	
1+2		(MHz)	(dBμV/m)	(dB)	(dBμV/m)	(dBμV)	(dB/m)	(dB)	(dB)	(cm)	(deg)	(P/A)	(H/V)
802.11ac CH 147 5735MHz		5736	130.34	-	-	122.14	32.54	8.33	32.67	202	2	P	H
		5736	122.73	-	-	114.53	32.54	8.33	32.67	202	2	A	H
		11470	50.42	-23.58	74	60.64	40.02	12.56	62.8	100	0	P	H
		5733	125.49	-	-	117.3	32.53	8.33	32.67	215	3	P	V
		5733	120.17	-	-	111.98	32.53	8.33	32.67	215	3	A	V
		11470	61.67	-12.33	74	71.89	40.02	12.56	62.8	163	32	P	V
		11470	51.6	-2.4	54	61.82	40.02	12.56	62.8	163	32	A	V
802.11ac CH 158 5790MHz		5791	129.05	-	-	120.8	32.58	8.35	32.68	183	0	P	H
		5791	121.94	-	-	113.69	32.58	8.35	32.68	183	0	A	H
		11580	57.29	-16.71	74	67.49	39.88	12.66	62.74	160	36	P	H
		11580	48.14	-5.86	54	58.34	39.88	12.66	62.74	160	36	A	H
		5791	126.29	-	-	118.04	32.58	8.35	32.68	200	3	P	V
		5791	118.87	-	-	110.62	32.58	8.35	32.68	200	3	A	V
		11580	61.15	-12.85	74	71.35	39.88	12.66	62.74	236	12	P	V
		11580	50.6	-3.4	54	60.8	39.88	12.66	62.74	236	12	A	V



WIFI	Note	Frequency	Level	Over	Limit	Read	Antenna	Cable	Preamp	Ant	Table	Peak	Pol.
Ant.				Limit	Line	Level	Factor	Loss	Factor	Pos	Pos	Avg.	
1+2		(MHz)	(dBμV/m)	(dB)	(dBμV/m)	(dBμV)	(dB/m)	(dB)	(dB)	(cm)	(deg)	(P/A)	(H/V)
802.11ac CH 168 5840MHz		5838	126.55	-	-	118.25	32.61	8.39	32.7	193	2	P	H
		5838	120.96	-	-	112.66	32.61	8.39	32.7	193	2	A	H
		11680	59.13	-14.87	74	69.33	39.69	12.77	62.66	362	61	P	H
		11680	50.36	-3.64	54	60.56	39.69	12.77	62.66	362	61	A	H
Remark	1. No other spurious found. 2. All results are PASS against Peak and Average limit line.												



15C Band 4 5750~5850MHz

WIFI 802.11ac VHT20 (Harmonic @ 3m)

WIFI	Note	Frequency	Level	Over	Limit	Read	Antenna	Cable	Preamp	Ant	Table	Peak	Pol.
Ant.				Limit	Line	Level	Factor	Loss	Factor	Pos	Pos	Avg.	
1+2		(MHz)	(dBμV/m)	(dB)	(dBμV/m)	(dBμV)	(dB/m)	(dB)	(dB)	(cm)	(deg)	(P/A)	(H/V)
802.11ac CH 148 5740MHz		5738	125.34	-	-	117.14	32.54	8.33	32.67	191	3	P	H
		5738	119.46	-	-	111.26	32.54	8.33	32.67	191	3	A	H
		11480	49.22	-24.78	74	59.42	40.02	12.58	62.8	100	0	P	H
		5742	125.16	-	-	116.96	32.54	8.33	32.67	207	3	P	V
		5742	117.07	-	-	108.87	32.54	8.33	32.67	207	3	A	V
		11482	51.93	-22.07	74	62.14	40.01	12.58	62.8	153	37	P	V
		11482	46.19	-7.81	54	56.4	40.01	12.58	62.8	153	37	A	V
802.11ac CH 158 5790MHz		5789	127.22	-	-	118.97	32.58	8.35	32.68	199	2	P	H
		5789	119.14	-	-	110.89	32.58	8.35	32.68	199	2	A	H
		11580	48.93	-25.07	74	59.13	39.88	12.66	62.74	100	0	P	H
		5788	122.45	-	-	114.2	32.58	8.35	32.68	221	3	P	V
		5788	116.04	-	-	107.79	32.58	8.35	32.68	221	3	A	V
		11582	50.69	-23.31	74	60.89	39.88	12.66	62.74	100	0	P	V



WIFI	Note	Frequency	Level	Over	Limit	Read	Antenna	Cable	Preamp	Ant	Table	Peak	Pol.
Ant.				Limit	Line	Level	Factor	Loss	Factor	Pos	Pos	Avg.	
1+2		(MHz)	(dBμV/m)	(dB)	(dBμV/m)	(dBμV)	(dB/m)	(dB)	(dB)	(cm)	(deg)	(P/A)	(H/V)
802.11ac CH 167 5835MHz		5836	124.7	-	-	116.41	32.6	8.39	32.7	173	3	P	H
		5836	117.74	-	-	109.45	32.6	8.39	32.7	173	3	A	H
		11670	51.55	-22.45	74	61.79	39.69	12.73	62.66	160	37	P	H
		11670	43.18	-10.82	54	53.42	39.69	12.73	62.66	160	37	A	H
Remark	1. No other spurious found. 2. All results are PASS against Peak and Average limit line.												



15C Band 4 5750~5850MHz

WIFI 802.11ac VHT30 (Harmonic @ 3m)

WIFI	Note	Frequency	Level	Over	Limit	Read	Antenna	Cable	Preamp	Ant	Table	Peak	Pol.
Ant.				Limit	Line	Level	Factor	Loss	Factor	Pos	Pos	Avg.	
1+2		(MHz)	(dBμV/m)	(dB)	(dBμV/m)	(dBμV)	(dB/m)	(dB)	(dB)	(cm)	(deg)	(P/A)	(H/V)
802.11ac CH 149 5745MHz		5747	124.21	-	-	116.01	32.54	8.33	32.67	190	2	P	H
		5747	117.89	-	-	109.69	32.54	8.33	32.67	190	2	A	H
		11490	48.41	-25.59	74	58.62	40.01	12.58	62.8	100	0	P	H
		5743	121.22	-	-	113.02	32.54	8.33	32.67	218	0	P	V
		5743	114.98	-	-	106.78	32.54	8.33	32.67	218	0	A	V
		11488	51.71	-22.29	74	61.92	40.01	12.58	62.8	160	27	P	V
		11488	43.8	-10.2	54	54.01	40.01	12.58	62.8	160	27	A	V
802.11ac CH 158 5790MHz		5788	123.53	-	-	115.28	32.58	8.35	32.68	194	0	P	H
		5788	117.07	-	-	108.82	32.58	8.35	32.68	194	0	A	H
		11580	49	-25	74	59.2	39.88	12.66	62.74	100	0	P	H
		5788	120.84	-	-	112.59	32.58	8.35	32.68	221	4	P	V
		5788	114.27	-	-	106.02	32.58	8.35	32.68	221	4	A	V
		11582	51.37	-22.63	74	61.57	39.88	12.66	62.74	136	32	P	V
		11582	42.43	-11.57	54	52.63	39.88	12.66	62.74	136	32	A	V



WIFI	Note	Frequency	Level	Over	Limit	Read	Antenna	Cable	Preamp	Ant	Table	Peak	Pol.
Ant.				Limit	Line	Level	Factor	Loss	Factor	Pos	Pos	Avg.	
1+2		(MHz)	(dBμV/m)	(dB)	(dBμV/m)	(dBμV)	(dB/m)	(dB)	(dB)	(cm)	(deg)	(P/A)	(H/V)
802.11ac CH 166 5830MHz		5832	123.11	-	-	114.81	32.6	8.39	32.69	199	1	P	H
		5832	115.96	-	-	107.66	32.6	8.39	32.69	199	1	A	H
		11658	48.38	-25.62	74	58.61	39.72	12.73	62.68	100	0	P	H
		5828	119.19	-	-	110.89	32.6	8.39	32.69	193	3	P	V
		5828	112.49	-	-	104.19	32.6	8.39	32.69	193	3	A	V
		11662	51.14	-22.86	74	61.37	39.72	12.73	62.68	181	12	P	V
		11662	42.39	-11.61	54	52.62	39.72	12.73	62.68	181	12	A	V
Remark	1. No other spurious found. 2. All results are PASS against Peak and Average limit line.												



15C Band 4 5750~5850MHz

WIFI 802.11ac VHT40 (Harmonic @ 3m)

WIFI	Note	Frequency	Level	Over	Limit	Read	Antenna	Cable	Preamp	Ant	Table	Peak	Pol.	
Ant.				Limit	Line	Level	Factor	Loss	Factor	Pos	Pos	Avg.		
1+2		(MHz)	(dBμV/m)	(dB)	(dBμV/m)	(dBμV)	(dB/m)	(dB)	(dB)	(cm)	(deg)	(P/A)	(H/V)	
802.11ac CH 150 5750MHz		5748	123.24	-	-	115.04	32.54	8.33	32.67	186	2	P	H	
		5748	116.44	-	-	108.24	32.54	8.33	32.67	186	2	A	H	
		11500	47.74	-26.26	74	57.96	40	12.58	62.8	100	0	P	H	
			5752	119.08	-	-	110.86	32.56	8.33	32.67	219	0	P	V
			5752	112.73	-	-	104.51	32.56	8.33	32.67	219	0	A	V
			11502	48.97	-25.03	74	59.19	40	12.58	62.8	100	0	P	V
802.11ac CH 158 5790MHz		5792	122.29	-	-	114.04	32.58	8.35	32.68	182	0	P	H	
		5792	115.51	-	-	107.26	32.58	8.35	32.68	182	0	A	H	
		11578	47.41	-26.59	74	57.61	39.88	12.66	62.74	100	0	P	H	
			5788	119.77	-	-	111.52	32.58	8.35	32.68	208	3	P	V
			5788	113	-	-	104.75	32.58	8.35	32.68	208	3	A	V
			11578	48.26	-25.74	74	58.46	39.88	12.66	62.74	100	0	P	V



WIFI	Note	Frequency	Level	Over	Limit	Read	Antenna	Cable	Preamp	Ant	Table	Peak	Pol.
Ant.				Limit	Line	Level	Factor	Loss	Factor	Pos	Pos	Avg.	
1+2		(MHz)	(dBμV/m)	(dB)	(dBμV/m)	(dBμV)	(dB/m)	(dB)	(dB)	(cm)	(deg)	(P/A)	(H/V)
802.11ac CH 165 5825MHz		5823	122.28	-	-	113.98	32.6	8.39	32.69	198	1	P	H
		5823	114.74	-	-	106.44	32.6	8.39	32.69	198	1	A	H
		11650	47.88	-26.12	74	58.09	39.75	12.73	62.69	100	0	P	H
		5824	118.81	-	-	110.51	32.6	8.39	32.69	184	3	P	V
		5824	111.27	-	-	102.97	32.6	8.39	32.69	184	3	A	V
		11652	47.88	-26.12	74	58.11	39.72	12.73	62.68	100	0	P	V
Remark	1. No other spurious found. 2. All results are PASS against Peak and Average limit line.												



15C Band 4 5750~5850MHz

WIFI 802.11ac VHT50 (Harmonic @ 3m)

WIFI	Note	Frequency	Level	Over	Limit	Read	Antenna	Cable	Preamp	Ant	Table	Peak	Pol.
Ant.				Limit	Line	Level	Factor	Loss	Factor	Pos	Pos	Avg.	
1+2		(MHz)	(dBμV/m)	(dB)	(dBμV/m)	(dBμV)	(dB/m)	(dB)	(dB)	(cm)	(deg)	(P/A)	(H/V)
802.11ac CH 151 5755MHz		5757	122	-	-	113.78	32.56	8.33	32.67	199	1	P	H
		5757	115.15	-	-	106.93	32.56	8.33	32.67	199	1	A	H
		11512	48.32	-25.68	74	58.54	40	12.58	62.8	100	0	P	H
802.11ac CH 158 5790MHz		5788	121.74	-	-	113.49	32.58	8.35	32.68	169	0	P	H
		5788	114.88	-	-	106.63	32.58	8.35	32.68	169	0	A	H
		11580	47.42	-26.58	74	57.62	39.88	12.66	62.74	100	0	P	H



WIFI	Note	Frequency	Level	Over	Limit	Read	Antenna	Cable	Preamp	Ant	Table	Peak	Pol.
Ant.				Limit	Line	Level	Factor	Loss	Factor	Pos	Pos	Avg.	
1+2		(MHz)	(dBμV/m)	(dB)	(dBμV/m)	(dBμV)	(dB/m)	(dB)	(dB)	(cm)	(deg)	(P/A)	(H/V)
802.11ac CH 164 5820MHz		5818	120.14	-	-	111.85	32.59	8.39	32.69	171	0	P	H
		5818	113.4	-	-	105.11	32.59	8.39	32.69	171	0	A	H
		11638	47.45	-26.55	74	57.66	39.75	12.73	62.69	100	0	P	H
		5818	117.7	-	-	109.41	32.59	8.39	32.69	194	4	P	V
		5818	110.57	-	-	102.28	32.59	8.39	32.69	194	4	A	V
		11643	47.92	-26.08	74	58.13	39.75	12.73	62.69	100	0	P	V
Remark	1. No other spurious found. 2. All results are PASS against Peak and Average limit line.												



15C Band 4 5750~5850MHz

WIFI 802.11ac VHT60 (Harmonic @ 3m)

WIFI	Note	Frequency	Level	Over	Limit	Read	Antenna	Cable	Preamp	Ant	Table	Peak	Pol.
Ant.				Limit	Line	Level	Factor	Loss	Factor	Pos	Pos	Avg.	
1+2		(MHz)	(dBμV/m)	(dB)	(dBμV/m)	(dBμV)	(dB/m)	(dB)	(dB)	(cm)	(deg)	(P/A)	(H/V)
802.11ac CH 152 5760MHz		5758	121.09	-	-	112.87	32.56	8.33	32.67	187	2	P	H
		5758	114.35	-	-	106.13	32.56	8.33	32.67	187	2	A	H
		11522	46	-28	74	56.2	39.97	12.62	62.79	100	0	P	H
802.11ac CH 158 5790MHz		5788	120.66	-	-	112.41	32.58	8.35	32.68	185	3	P	H
		5788	113.9	-	-	105.65	32.58	8.35	32.68	185	3	A	H
		11578	46.2	-27.8	74	56.4	39.88	12.66	62.74	100	0	P	H



WIFI	Note	Frequency	Level	Over	Limit	Read	Antenna	Cable	Preamp	Ant	Table	Peak	Pol.
Ant.				Limit	Line	Level	Factor	Loss	Factor	Pos	Pos	Avg.	
1+2		(MHz)	(dBμV/m)	(dB)	(dBμV/m)	(dBμV)	(dB/m)	(dB)	(dB)	(cm)	(deg)	(P/A)	(H/V)
802.11ac CH 163 5815MHz		5813	119.57	-	-	111.28	32.59	8.39	32.69	178	0	P	H
		5813	112.69	-	-	104.4	32.59	8.39	32.69	178	0	A	H
		11628	44.66	-29.34	74	54.88	39.78	12.7	62.7	100	0	P	H
		5813	116.21	-	-	107.92	32.59	8.39	32.69	183	3	P	V
		5813	109.93	-	-	101.64	32.59	8.39	32.69	183	3	A	V
		11628	46.14	-27.86	74	56.36	39.78	12.7	62.7	100	0	P	V
Remark	1. No other spurious found. 2. All results are PASS against Peak and Average limit line.												



15C Band 4 5750~5850MHz

WIFI 802.11ac VHT80 (Harmonic @ 3m)

WIFI	Note	Frequency	Level	Over	Limit	Read	Antenna	Cable	Preamp	Ant	Table	Peak	Pol.
Ant.				Limit	Line	Level	Factor	Loss	Factor	Pos	Pos	Avg.	
1+2		(MHz)	(dBμV/m)	(dB)	(dBμV/m)	(dBμV)	(dB/m)	(dB)	(dB)	(cm)	(deg)	(P/A)	(H/V)
802.11ac CH 154 5770MHz		5772	120.75	-	-	112.5	32.57	8.35	32.67	202	3	P	H
		5772	113.35	-	-	105.1	32.57	8.35	32.67	202	3	A	H
		11538	44.88	-29.12	74	55.09	39.94	12.62	62.77	100	0	P	H
4802.11ac CH 158 5790MHz		5788	118.68	-	-	110.43	32.58	8.35	32.68	171	0	P	H
		5788	111.66	-	-	103.41	32.58	8.35	32.68	171	0	A	H
		11578	44.18	-29.82	74	54.38	39.88	12.66	62.74	100	0	P	H



WIFI	Note	Frequency	Level	Over	Limit	Read	Antenna	Cable	Preamp	Ant	Table	Peak	Pol.
Ant.				Limit	Line	Level	Factor	Loss	Factor	Pos	Pos	Avg.	
1+2		(MHz)	(dBμV/m)	(dB)	(dBμV/m)	(dBμV)	(dB/m)	(dB)	(dB)	(cm)	(deg)	(P/A)	(H/V)
802.11ac CH 162 5810MHz		5808	118.98	-	-	110.69	32.59	8.39	32.69	160	0	P	H
		5808	111.11	-	-	102.82	32.59	8.39	32.69	160	0	A	H
		11618	43.15	-30.85	74	53.37	39.78	12.7	62.7	100	0	P	H
		5808	116.16	-	-	107.87	32.59	8.39	32.69	188	3	P	V
		5808	108.88	-	-	100.59	32.59	8.39	32.69	188	3	A	V
		11618	43.92	-30.08	74	54.14	39.78	12.7	62.7	100	0	P	V
Remark	1. No other spurious found. 2. All results are PASS against Peak and Average limit line.												



15C Emission below 1GHz

5GHz WIFI 802.11ac VHT10 (LF)

WIFI	Note	Frequency	Level	Over	Limit	Read	Antenna	Cable	Preamp	Ant	Table	Peak	Pol.	
Ant.				Limit	Line	Level	Factor	Loss	Factor	Pos	Pos	Avg.		
1+2		(MHz)	(dBμV/m)	(dB)	(dBμV/m)	(dBμV)	(dB/m)	(dB)	(dB)	(cm)	(deg)	(P/A)	(H/V)	
5GHz 802.11ac VHT10 LF		125.04	40.23	-3.27	43.5	59.61	11.95	1.33	32.66	100	0	P	H	
		224.94	42.24	-3.76	46	62.7	10.65	1.62	32.73			P	H	
		240.06	40.79	-5.21	46	59.92	11.98	1.62	32.73			P	H	
		325.2	35.65	-10.35	46	51.97	14.5	1.94	32.76			P	H	
		524.7	30.25	-15.75	46	42.28	18.45	2.47	32.95			P	H	
		624.8	34.64	-11.36	46	45.15	19.89	2.62	33.02			P	H	
	Remark	1. No other spurious found. 2. All results are PASS against limit line.												



Note symbol

*	Fundamental Frequency which can be ignored. However, the level of any unwanted emissions shall not exceed the level of the fundamental frequency per 15.209(c).
!	Test result is over limit line.
P/A	Peak or Average
H/V	Horizontal or Vertical



A calculation example for radiated spurious emission is shown as below:

WIFI	Note	Frequency	Level	Over	Limit	Read	Antenna	Cable	Preamp	Ant	Table	Peak	Pol.
Ant.				Limit	Line	Level	Factor	Loss	Factor	Pos	Pos	Avg.	
1+2		(MHz)	(dBμV/m)	(dB)	(dBμV/m)	(dBμV)	(dB/m)	(dB)	(dB)	(cm)	(deg)	(P/A)	(H/V)
802.11b		2390	55.45	-18.55	74	54.51	32.22	4.58	35.86	103	308	P	H
CH 01													
2412MHz		2390	43.54	-10.46	54	42.6	32.22	4.58	35.86	103	308	A	H

- Level(dBμV/m) =
Antenna Factor(dB/m) + Cable Loss(dB) + Read Level(dBμV) - Preamp Factor(dB)
- Over Limit(dB) = Level(dBμV/m) – Limit Line(dBμV/m)

For Peak Limit @ 2390MHz:

- Level(dBμV/m)
= Antenna Factor(dB/m) + Cable Loss(dB) + Read Level(dBμV) - Preamp Factor(dB)
= 32.22(dB/m) + 4.58(dB) + 54.51(dBμV) – 35.86 (dB)
= 55.45 (dBμV/m)
- Over Limit(dB)
= Level(dBμV/m) – Limit Line(dBμV/m)
= 55.45(dBμV/m) – 74(dBμV/m)
= -18.55(dB)

For Average Limit @ 2390MHz:

- Level(dBμV/m)
= Antenna Factor(dB/m) + Cable Loss(dB) + Read Level(dBμV) - Preamp Factor(dB)
= 32.22(dB/m) + 4.58(dB) + 42.6(dBμV) – 35.86 (dB)
= 43.54 (dBμV/m)
- Over Limit(dB)
= Level(dBμV/m) – Limit Line(dBμV/m)
= 43.54(dBμV/m) – 54(dBμV/m)
= -10.46(dB)

Both peak and average measured complies with the limit line, so test result is “PASS”.