



Compliance Testing, LLC

Previously Flom Test Lab

EMI, EMC, RF Testing Experts Since 1963

toll-free: (866) 311-3268

fax: (480) 926-3598

<http://www.ComplianceTesting.com>

info@ComplianceTesting.com

Test Report

Prepared for: Ubiquiti Networks, Inc

Model: B-DB-AC, Bullet
& Bullet AC-IP67

Description: Dual Band Networking Device

Serial Number: N/A

FCC ID: SWX-BDBAC
IC: 6545A-BDBAC

To

FCC Part 15.407 DFS

Date of Issue: August 15, 2018

On the behalf of the applicant:

Ubiquiti Networks, Inc
2580 Orchard Parkway
San Jose, CA 95131

Attention of:

Mark Feil, Engineer
Ph: (408)942-3085
E-mail: mark.feil@ubnt.com

Prepared By
Compliance Testing, LLC
1724 S. Nevada Way
Mesa, AZ 85204
(480) 926-3100 phone / (480) 926-3598 fax
www.compliancetesting.com
Project No: p1790008

Poona Saber
Project Test Engineer

This report may not be reproduced, except in full, without written permission from Compliance Testing.
All results contained herein relate only to the sample tested.



Test Report Revision History

Revision	Date	Revised By	Reason for Revision
1.0	April 5, 2018	Poona Saber	Original Document
2.0	August 15, 2018	Poona Saber	Added the antenna gain units on page 8 Updated page 7 and page 8 for conducted power and maximum EIRP level
3.0	August 6, 2019	Poona Saber	Revised reference testing table and added measurement uncertainty
4.0	August 8, 2019	Poona Saber	Added Bullet AC-IP67 as the extra model with note on page 6



Table of Contents

<u>Description</u>	<u>Page</u>
Standard Test Conditions Engineering Practices	6
Description of the U-NII device	8
Test Results Summary	10
Conducted Setup for Master with injection at the Master	16
Conducted Setup for Client with injection at the Client	17
Radar Waveform Calibration	18
Channel Loading	22
U-NII Detection Bandwidth	26
Initial CACT	27
Radar Burst at the Beginning of the Channel Availability Check Time	28
Radar Burst at the End of the Channel Availability Check Time	29
Statistical Performance Check	33
Short Pulse Radar Test Summary	37
Test Equipment Utilized	42



ILAC / A2LA

Compliance Testing, LLC, has been accredited in accordance with the recognized International Standard ISO/IEC 17025:2005. This accreditation demonstrates technical competence for a defined scope and the operation of a laboratory quality management system (refer to the joint ISO-ILAC-IAF Communiqué dated January 2009).

The tests results contained within this test report all fall within our scope of accreditation, unless noted below.

Please refer to <http://www.compliancetesting.com/labscope.html> for current scope of accreditation.

Testing Certificate Number: **2152.01**



FCC Site Reg. #349717

IC Site Reg. #2044A-2

Non-accredited tests contained in this report:

N/A



The applicant has been cautioned as to the following

15.21 - Information to User

The user's manual or instruction manual for an intentional radiator shall caution the user that changes or modifications not expressly approved by the party responsible for compliance could void the user's authority to operate the equipment.

15.27(a) - Special Accessories

Equipment marked to a consumer must be capable of complying with the necessary regulations in the configuration in which the equipment is marketed. Where special accessories, such as shielded cables and/or special connectors are required to enable an unintentional or intentional radiator to comply with the emission limits in this part, the equipment must be marketed with, i.e. shipped and sold with, those special accessories. However, in lieu of shipping or packaging the special accessories with the unintentional or intentional radiator, the responsible party may employ other methods of ensuring that the special accessories are provided to the consumer without an additional charge.

Information detailing any alternative method used to supply the special accessories for a grant of equipment authorization or retained in the verification records, as appropriate. The party responsible for the equipment, as detailed in § 2.909 of this chapter, shall ensure that these special accessories are provided with the equipment. The instruction manual for such devices shall include appropriate instructions on the first page of text concerned with the installation of the device that these special accessories must be used with the device. It is the responsibility of the user to use the needed special accessories supplied with the equipment.



Standard Test Conditions Engineering Practices

Except as noted herein, the following conditions and procedures were observed during the testing:

In accordance with ANSI C63.10-2013 and unless otherwise indicated in the specific measurement results, the ambient temperature of the actual EUT was maintained within the range of 10° to 40°C (50° to 104°F) unless the particular equipment requirements specified testing over a different temperature range. Also, unless otherwise indicated, the humidity levels were in the range of 10% to 90% relative humidity.

Measurement results, unless otherwise noted, are worst-case measurements.

Environmental Conditions		
Temperature (°C)	Humidity (%)	Pressure (mbar)
25.4 – 26.6	21.4 – 22.5	976.7 – 980.9

EUT Operation during Tests

EUT is powered by POE (Power over Ethernet) Ethernet cable.

EUT Description

Model: B-DB-AC, Bullet & Bullet AC-IP67

Description: Dual Band Networking Device

Firmware: N/A

Software: N/A

Serial Number:

Additional Information: The Bullet AC (Model: B-DB-AC) is a dual band networking device that is powered over ethernet (passive POE, 24V) and provides an N-type antenna connection. It features dual-band AC mode operation in 5GHz and 2.4GHz bands. Channel loading of approximately 17% or greater was maintained from Master to client on tested channel for some of the testing.

Unit can be configured as both Master and Client and testing was done conducted with injection at Master.



EUT Specifications	15.407
Equipment Code	NII
System Architecture	IP based
Model(s) Tested	802.11 ac-VHT 20,40,80
Model(s) Covered	802.11 ac- VHT20 802.11 ac- VHT40 802.11 ac- VHT80
Maximum Output Power (Conducted)	22.2 dBm
Frequency Ranges covered	5250 - 5350 MHz, 5470 – 5725 MHz
EUT temperature range	-30°C to 75°C
Bandwidths	10/20/30/40/50/60/80 MHz
Data Rates	MCS0
Modulations	BPSK, QPSK, 16-QAM, 64-QAM, 256-QAM



Description of the U-NII device

1. The operating frequency range(s) of the equipment is:
 - U-NII-1 (5150-5250 MHz)
 - U-NII-2A (5250-5350 MHz)
 - U-NII-2C (5470-5725 MHz)
 - U-NII-3 (5725-5850 MHz)
2. This device operates as a master and/or client
3. This device is being tested for DFS as a Master. This device has radar detection in both Master and Client modes.
4. The highest and the lowest possible power level (equivalent isotropic radiated power (EIRP)) of the equipment.
 - a. 28.2 dBm – highest possible EIRP
 - b. 6.8 dBm – lowest possible EIRP
5. List all antenna assemblies and their corresponding gains. a. If radiated tests are to be performed, the U-NII Device should be tested with the lowest gain antenna assembly (regardless of antenna type). The report should indicate which antenna assembly was used for the tests. For devices with adjustable output power, list the output power range and the maximum EIRP for each antenna assembly.

Model No.	Manufacturer	Antenna Type	Gain
UniFi Omni	Ubiquiti	Omni	Lowest 4 dBi Highest 13 dBi
AM-5AC22-45	Ubiquiti	Sector	22 dBi
RD-5G34	Ubiquiti	Dish	34 dBi

6. Conducted testing was done on the antenna port.
7. The antenna that was used for DFS threshold level was a 4 dBi Omni based on the lowest gain antenna and the DFS detection threshold was set to -60 dBm.
8. Antenna Connector impedance is 50 Ohms.
9. The system is IP based and method used for channel loading involves what is called "iperf" traffic through both radios. An 'iperf' server is started on the laptop connected to the station/client device . UDP 'iperf' traffic from the master side, of desired throughput, is started on a laptop on the AP side to reach the wanted utilization (master to client traffic). The throughput doesn't directly correlate to a utilization rate. The exact utilization achieved is dependent upon both the radio BW used and the data rate entered in the command that starts traffic. The utilization rate shown on the display uses industry standard methods for channel utilization calculation (reported by the QCA chip). We had the display refresh set at 1 second intervals (if the rate changed, we had 1 second resolution as far as reporting accuracy). In this configuration actual traffic (with simulated packets) keeps radio activity at the desired utilization rate.



10. TPC: The device ALWAYS operates within the limits of the grant's power tables.
 - a. Software limits the maximum conducted output power based upon the product, mode (PTP or PTMP), antenna type, antenna gain, channel width, and frequency.
 - b. The professional installer has a maximum power setting on the user interface which may be used to REDUCE the power level below the maximum allowed.
 - i. If the professional installer specifies a maximum power setting which is GREATER THAN the maximum allowed under the grant for the current conditions (product, mode, antenna type, antenna gain, channel width, and frequency), then this SETTING HAS NO EFFECT.
 - ii. Should the frequency change to one where the professional installer's specified maximum is LESS THAN the maximum conducted power level on the grant, then the lesser setting would take effect.
 - iii. This allows the professional installer to limit the conducted output power across multiple frequencies which have different conducted power limits. This applies to client mode devices which are scanning for masters across frequencies, master mode devices which change frequencies after radar detection, master modes with automatic channel selection, etc.

11. The power on cycle for the device is about 20 seconds from power connected to start of CAC.

12. Manufacturer declaration:
 - Information regarding the parameters of the detected radar waveforms is not available to the professional installer or an end user.
 - In order to obtain detailed parameters of detected radar waveforms, the product must be specially provisioned by Ubiquiti for DFS/FCC testing.

13. Channel selection:
 - The professional installer may configure a master device to start on a specific frequency, or choose "auto" to have the software select the best frequency automatically.
 - The professional installer may also block channels from use, including DFS channels, through the use of a frequency list.
 - The frequency list is a pre-determined list of frequencies that the device may operate on.
 - By simply omitting any frequency they so choose, the professional installer can block that frequency.
 - The frequency list may either be entered from a keyboard or a selection GUI. In the frequency list selection GUI, checkboxes for DFS channels are tagged with the suffix, "(DFS)", to indicate that DFS is required for those frequencies.



Test Results Summary

Specification	Rule part	Description of Test	Pass, Fail, N/A	Comments
UNII Detection Bandwidth	FCC 15.407 2) RSS 247 6.3.1	Radar detection across frequency spectrum	Pass	
Performance Requirements Check	FCC 15.407 2)(ii) RSS 247 6.3.2 (b)	Initial Channel Availability Check Time (CAC)	Pass	
	FCC 15.407 2)(ii) RSS 247 6.3.2 (b)	Radar Burst at the Beginning of the CAC	Pass	
	FCC 15.407 2)(ii) RSS 247 6.3.2 (b)	Radar Burst at the end of the CAC	Pass	
Performance Requirements Check	FCC 15.407 2)(iii) RSS 247 6.3.2 (c)	Channel Move Time	Pass	
	FCC 15.407 2) RSS 247 6.3.2 (d)	Channel Closing Transmission Time	Pass	
	FCC 15.407 2)(iv) RSS 247 6.3.2 (e)	Non-Occupancy Period	Pass	
In-service Monitoring	FCC 15.407 2) RSS 247 6.3	Statistical Performance Check	Pass	

References	Description
KDB 905462 D02	UNII DFS Compliance Procedures New Rules v01r02
CFR47, Part 15, Subpart E	Unlicensed Nation Information Infrastructure Devices (U-NII)
ANSI C63.10-2013	American National standard for testing Unlicensed Wireless Devices
ISO/IEC 17025:2005	General requirements for the Competence of Testing and Calibrations Laboratories
KDB 644545 D03	Guidance for IEEE 802 11ac New Rules
KDB 789033 D02	General U-NII Test Procedures New Rules V01
KDB 926956 D01	U-NII transition Plan



Requirement	Operational Mode		
	Master	Client Without Radar Detection	Client With Radar Detection
Non-Occupancy Period	Yes	Not required	Yes
DFS Detection Threshold	Yes	Not required	Yes
Channel Availability Check Time	Yes	Not required	Not required
U-NII Detection Bandwidth	Yes	Not required	Yes

Requirement	Operational Mode	
	Master Device or Client with Radar Detection	Client Without Radar Detection
DFS Detection Threshold	Yes	Not required
Channel Closing Transmission Time	Yes	Yes
Channel Move Time	Yes	Yes
U-NII Detection Bandwidth	Yes	Not required

Additional requirements for devices with multiple bandwidth modes	Master Device or Client with Radar Detection	Client Without Radar Detection
U-NII Detection Bandwidth and Statistical Performance Check	All BW modes must be tested	Not required
Channel Move Time and Channel Closing Transmission Time	Test using widest BW mode available	Test using the widest BW mode available for the link
All other tests	Any single BW mode	Not required

Note: Frequencies selected for statistical performance check (Section 7.8.4) should include several frequencies within the radar detection bandwidth and frequencies near the edge of the radar detection bandwidth. For 802.11 devices it is suggested to select frequencies in each of the bonded 20 MHz channels and the channel center frequency.



Maximum Transmit Power	Value (See Notes 1, 2, and 3)
EIRP ≥ 200 milliwatt	-64 dBm
EIRP < 200 milliwatt and power spectral density < 10 dBm/MHz	-62 dBm
EIRP < 200 milliwatt that do not meet the power spectral density requirement	-64 dBm

Note 1: This is the level at the input of the receiver assuming a 0 dBi receive antenna.
Note 2: Throughout these test procedures an additional 1 dB has been added to the amplitude of the test transmission waveforms to account for variations in measurement equipment. This will ensure that the test signal is at or above the detection threshold level to trigger a DFS response.
Note 3: EIRP is based on the highest antenna gain. For MIMO devices refer to KDB Publication 662911 D01.

Parameter	Value
Non-occupancy period	Minimum 30 minutes
Channel Availability Check Time	60 seconds
Channel Move Time	10 seconds See Note 1.
Channel Closing Transmission Time	200 milliseconds + an aggregate of 60 milliseconds over remaining 10 second period. See Notes 1 and 2.
U-NII Detection Bandwidth	Minimum 100% of the U-NII 99% transmission power bandwidth. See Note 3.

Note 1: *Channel Move Time* and the *Channel Closing Transmission Time* should be performed with Radar Type 0. The measurement timing begins at the end of the Radar Type 0 burst.
Note 2: The *Channel Closing Transmission Time* is comprised of 200 milliseconds starting at the beginning of the *Channel Move Time* plus any additional intermittent control signals required to facilitate a *Channel* move (an aggregate of 60 milliseconds) during the remainder of the 10 second period. The aggregate duration of control signals will not count quiet periods in between transmissions.
Note 3: During the *U-NII Detection Bandwidth* detection test, radar type 0 should be used. For each frequency step the minimum percentage of detection is 90 percent. Measurements are performed with no data traffic.



Radar Type	Pulse Width (μsec)	PRI (μsec)	Number of Pulses	Minimum Percentage of Successful Detection	Minimum Number of Trials
0	1	1428	18	See Note 1	See Note 1
1	1	Test A/Test B	See 905462 D02	60%	30
2	1-5	150-230	23-29	60%	30
3	6-10	200-500	16-18	60%	30
4	11-20	200-500	12-16	60%	30
Aggregate (Radar Types 1-4)				80%	120

Note 1: Short Pulse Radar Type 0 should be used for the detection bandwidth test, channel move time, and channel closing time tests.



Radar Type	Pulse Width (μsec)	Chirp Width (MHz)	PRI (μsec)	Number of Pulses per Burst	Number of Bursts	Minimum Percentage of Successful Detection	Minimum Number of Trials
5	50-100	5-20	1000-2000	1-3	8-20	80%	30

Note: The center frequency for each of the 30 trials of the Bin 5 radar is randomly selected within 80% of the Occupied Bandwidth.

Each waveform is defined as follows:

1. The transmission period for the Long Pulse Radar test signal is 12 seconds.
2. There are a total of 8 to 20 Bursts in the 12 second period, with the number of Bursts being randomly chosen. This number is Burst Count.
3. Each Burst consists of 1 to 3 pulses, with the number of pulses being randomly chosen. Each Burst within the 12 second sequence may have a different number of pulses.
4. The pulse width is between 50 and 100 microseconds, with the pulse width being randomly chosen. Each pulse within a Burst will have the same pulse width. Pulses in different Bursts may have different pulse widths.
5. Each pulse has a linear frequency modulated chirp between 5 and 20MHz, with the chirp width being randomly chosen. Each pulse within a Burst will have the same chirp width. Pulses in different Bursts may have different chirp widths. The chirp is centered on the pulse. For example, with radar frequency of 5300MHz and a 20MHz chirped signal, the chirp starts at 5290MHz and ends at 5310MHz.
6. If more than one pulse is present in a Burst, the time between the pulses will be between 1000 and 2000 microseconds, with the time being randomly chosen. If three pulses are present in a Burst, the random time interval between the first and second pulses is chosen independently of the random time interval between the second and third pulses.
7. The 12 second transmission period is divided into even intervals. The number of intervals is equal to Burst Count. Each interval is of length $(12,000,000 / \text{Burst Count})$ microseconds. Each interval contains one Burst. The start time for the Burst, relative to the beginning of the interval, is between 1 and $[(12,000,000 / \text{Burst Count}) - (\text{Total Burst Length}) + (\text{One Random PRI Interval})]$ microseconds, with the start time being randomly chosen. The step interval for the start time is 1 microsecond. The start time for each Burst is chosen randomly.

A representative example of a Long Pulse Radar Type waveform:

1. The total test waveform length is 12 seconds.
2. Eight (8) Bursts are randomly generated for the Burst Count.
3. Burst 1 has 2 randomly generated pulses.
4. The pulse width (for both pulses) is randomly selected to be 75 microseconds.
5. The PRI is randomly selected to be at 1213 microseconds.
6. Bursts 2 through 8 are generated using steps 3 – 5.
7. Each Burst is contained in even intervals of 1,500,000 microseconds. The starting location for Pulse 1, Burst 1 is randomly generated (1 to 1,500,000 minus the total Burst 1 length + 1 random PRI interval) at the 325,001 microsecond step. Bursts 2 through 8 randomly fall in successive 1,500,000 microsecond intervals (i.e. Burst 2 falls in the 1,500,001 – 3,000,000 microsecond range).



Radar Type	Pulse Width (μsec)	PRI (μsec)	Pulses per Hop	Hopping Rate (kHz)	Hopping Sequence Length (msec)	Minimum Percentage of Successful Detection	Minimum Number of Trials
6	1	333	9	0.333	300	70%	30

The first frequency in a hopping sequence is selected randomly from the group of 475 integer frequencies from 5250 – 5724MHz. Next, the frequency that was just chosen is removed from the group and a frequency is randomly selected from the remaining 474 frequencies in the group. This process continues until all 475 frequencies are chosen for the set. For selection of a random frequency, the frequencies remaining within the group are always treated as equally likely.



Conducted Setup for Master with injection at the Master

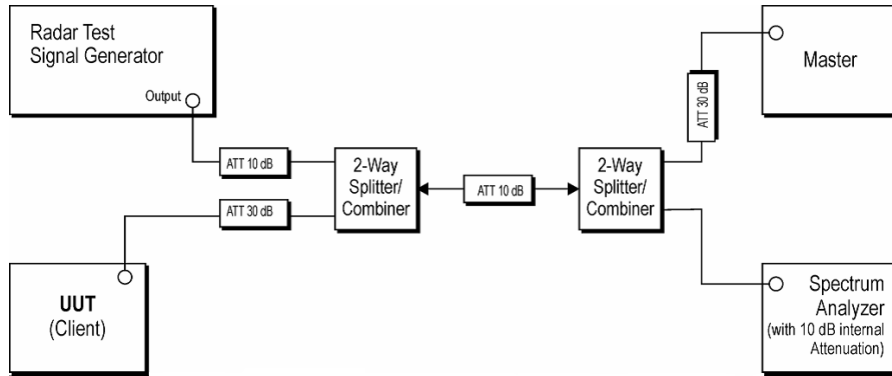



Conducted Setup for Client with injection at the Client

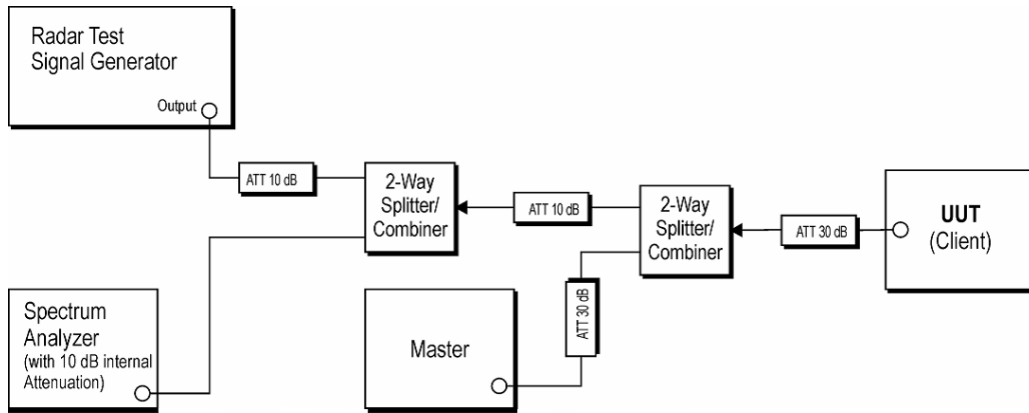



Radar Waveform Calibration

The equipment was setup per the diagram below. The amplitude of each wave form adjusted to compensate for the lowest antenna gain used with the EUT.

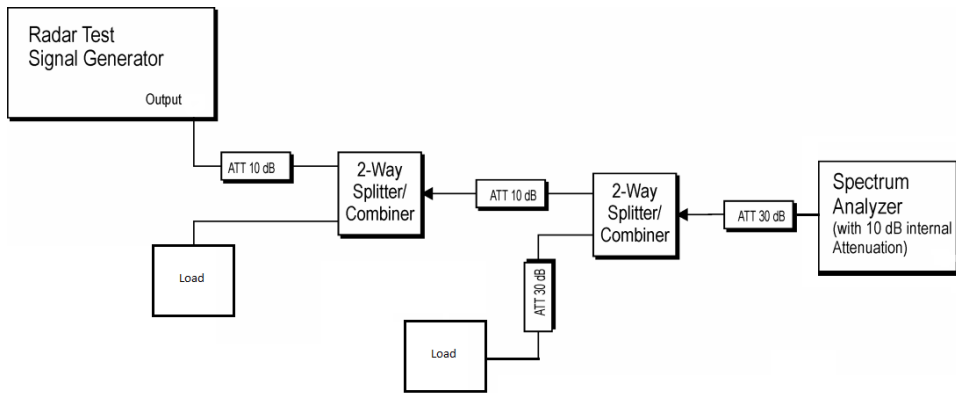

Waveform Calibration Test Setup Diagram

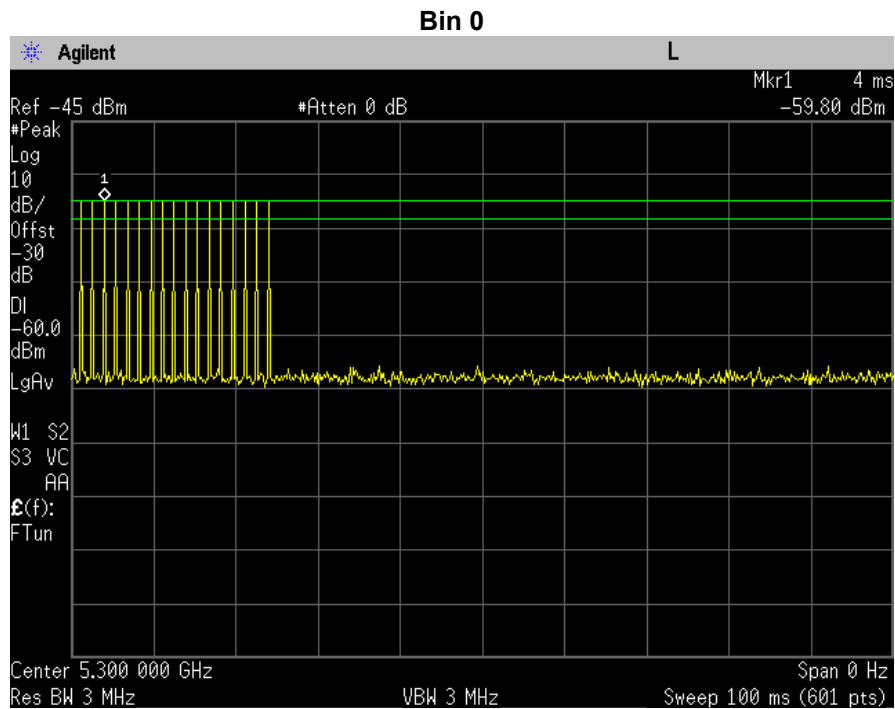



Bin 1

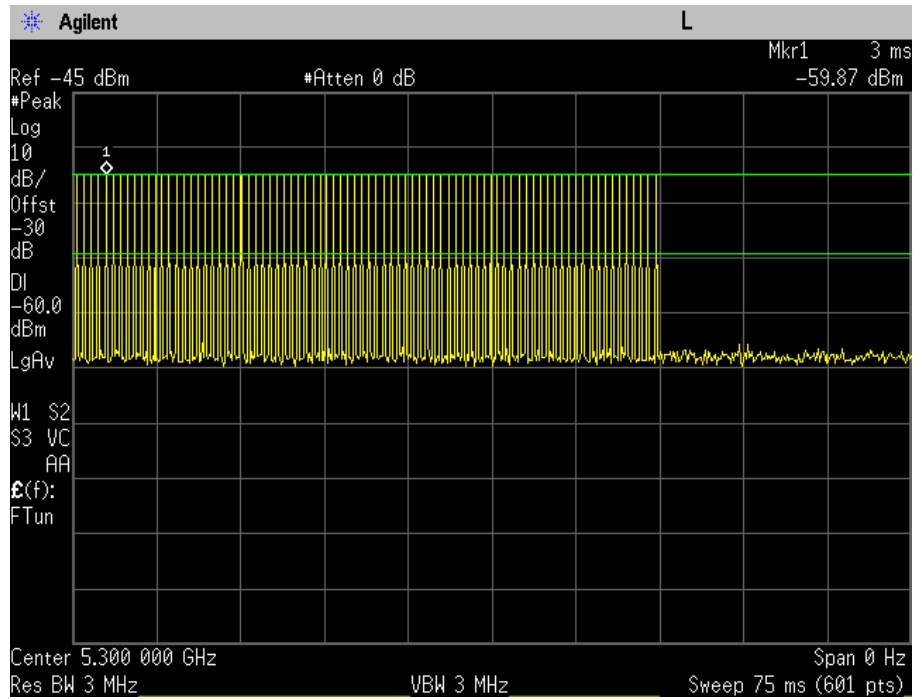

Bin 2

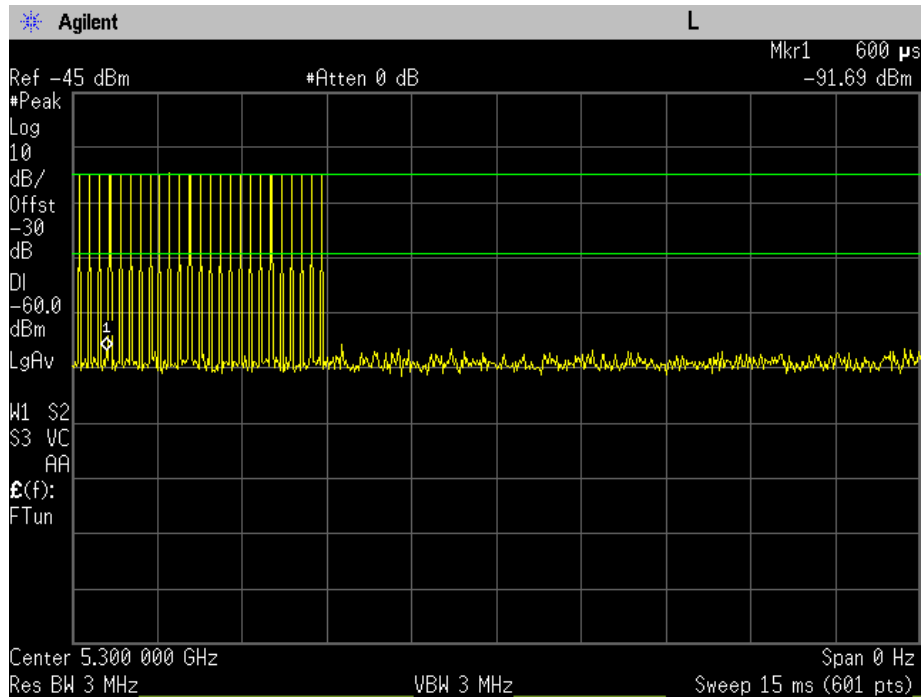



Bin 3

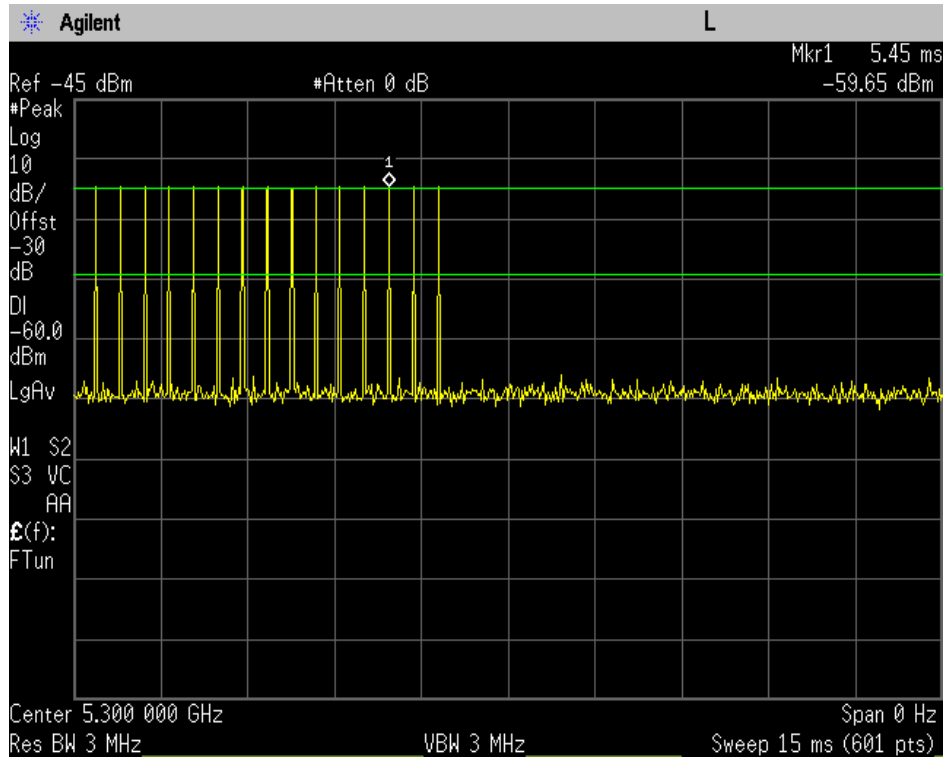

Bin 4

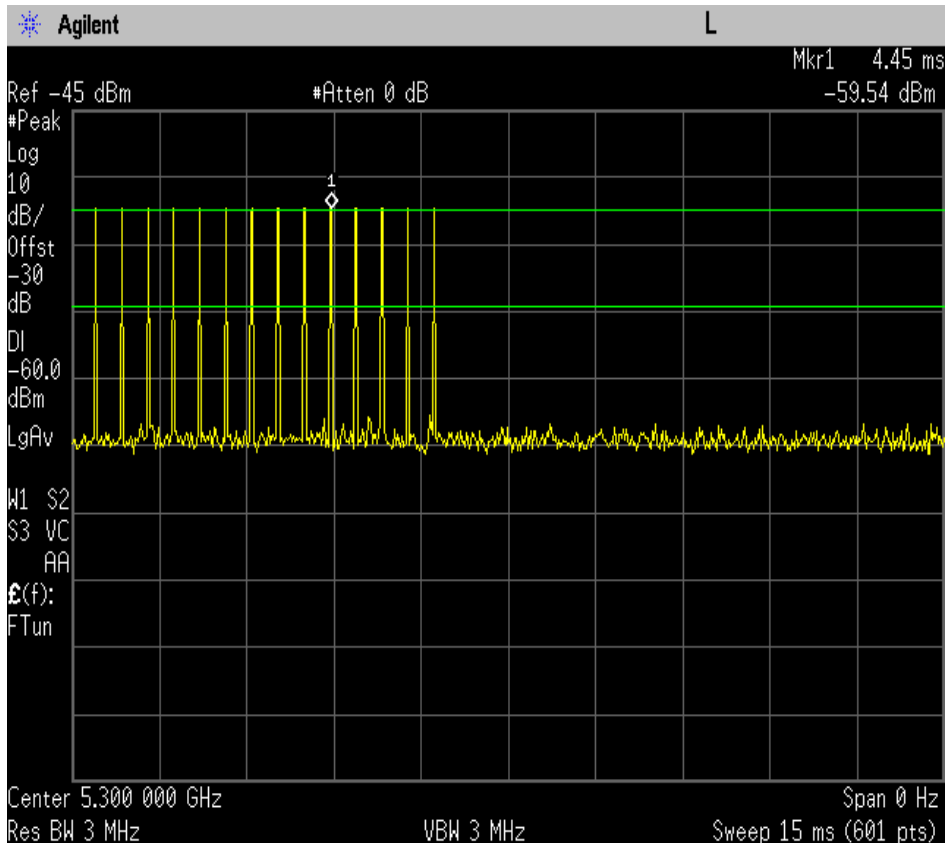



Bin 5

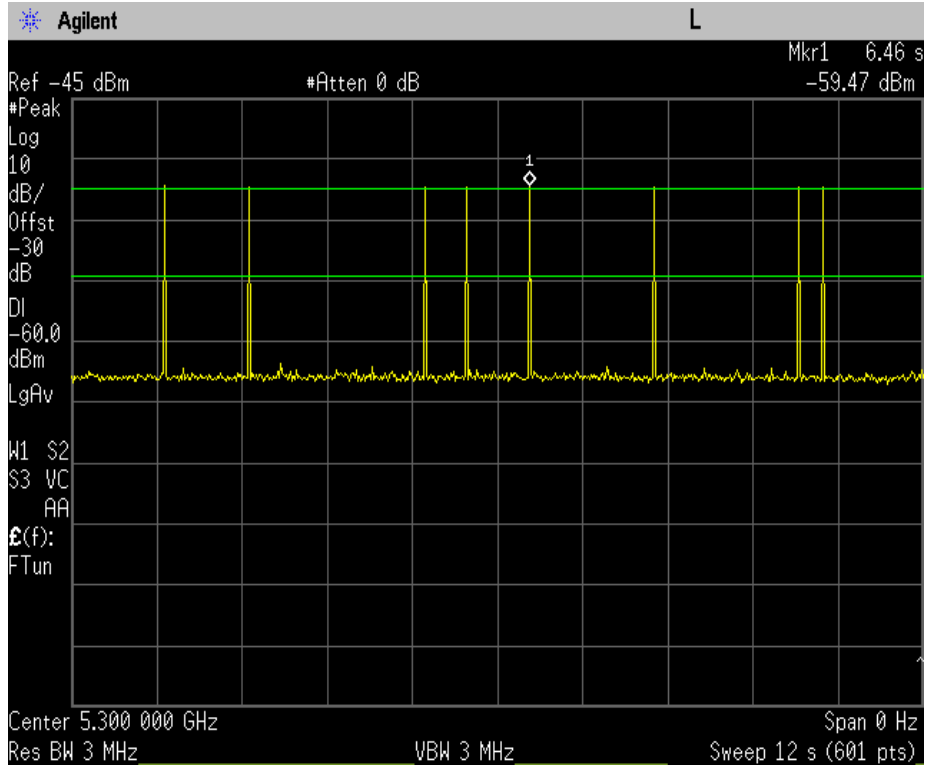

Bin 6

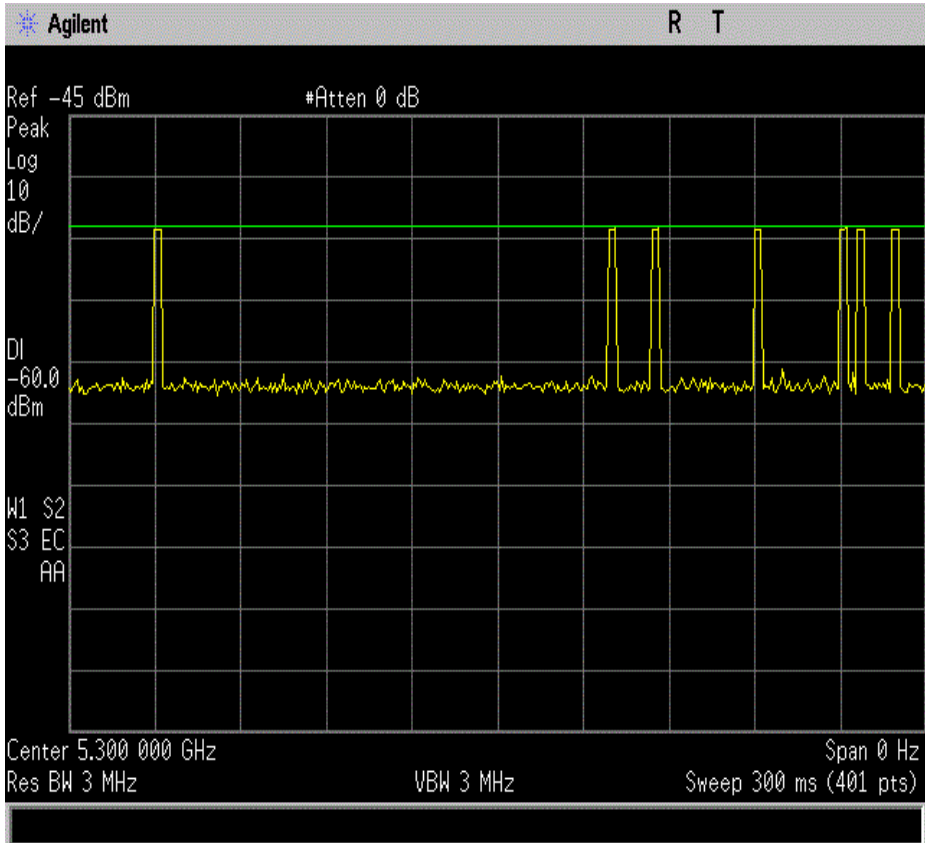



Channel Loading

Engineer: Poona Saber

Test Date: 2/12/2018

Test Requirements

System testing will be performed with channel-loading using means appropriate to the data types that are used by the unlicensed device. The following requirements apply:

- a) The data file must be of a type that is typical for the device (i.e., MPEG-2, MPEG-4, WAV, MP3, MP4, AVI, etc.) and must generally be transmitting in a streaming mode.
- b) Software to ping the client is permitted to simulate data transfer but must have random ping intervals.
- c) Timing plots are required with calculations demonstrating a minimum channel loading of approximately 17% or greater. For example, channel loading can be estimated by setting the spectrum analyzer for zero span and approximate the Time On/ (Time On + Off Time). This can be done with any appropriate channel BW and modulation type.

Test Procedure

Traffic is generated through iperf from the master to the client. The spectrum analyzer is set to 1MHz RBW and 3MHz VBW with a sweep time of 600ms. The plots below show the traffic for each bandwidth tested.

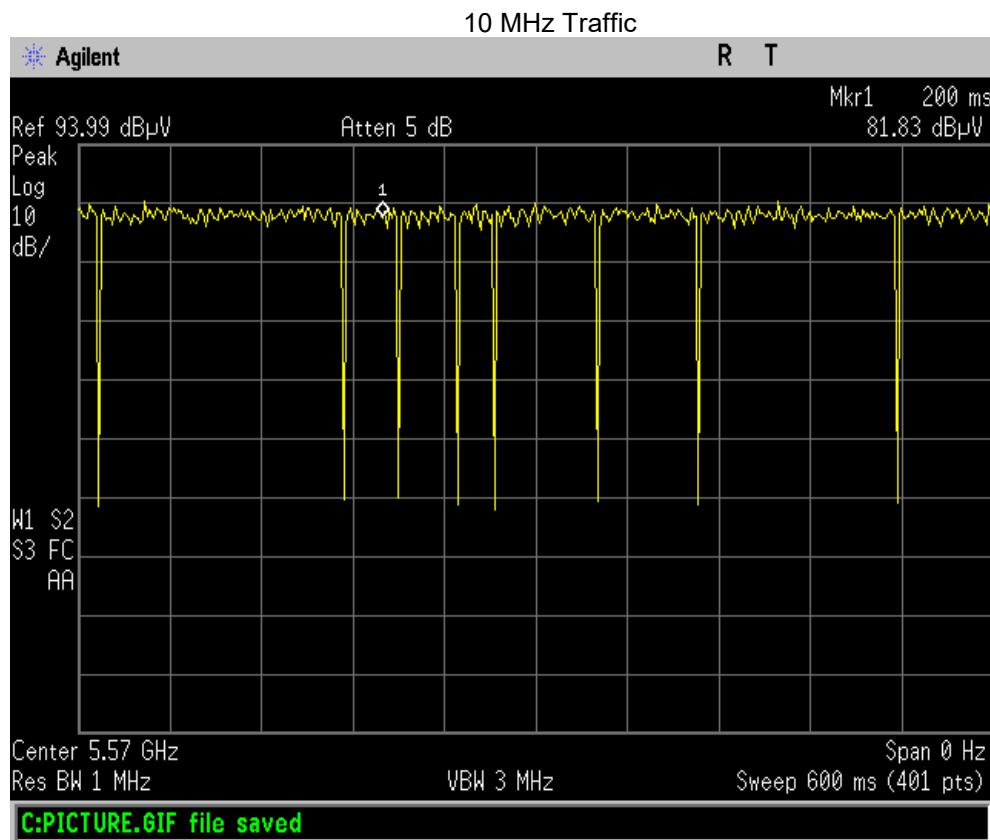



20 MHz Traffic

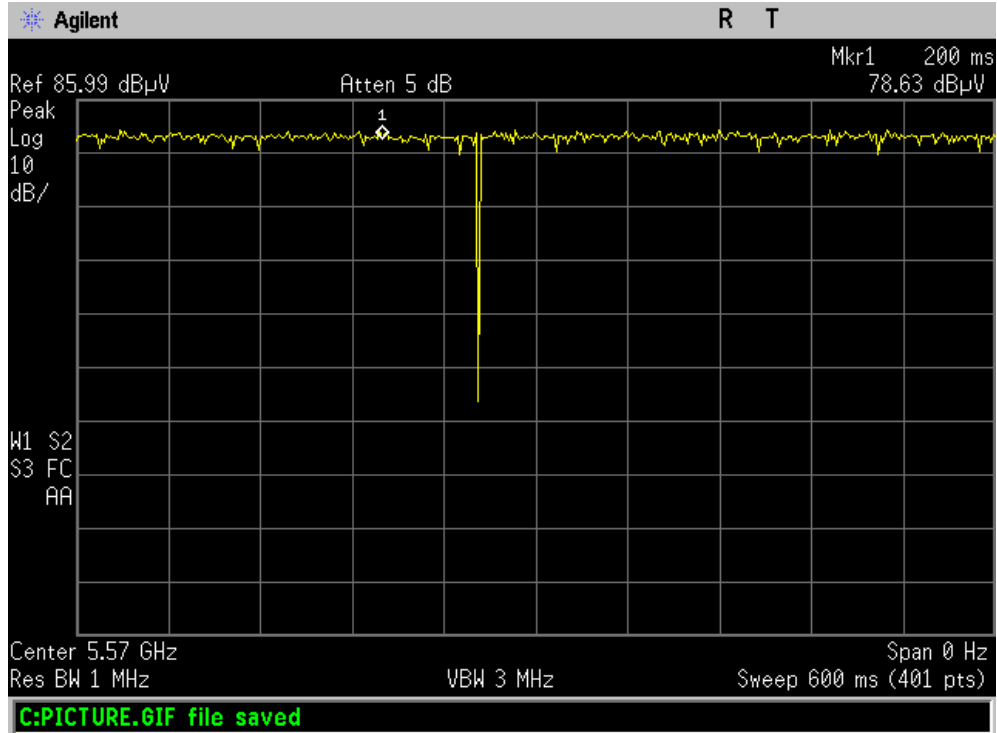

30 MHz Traffic

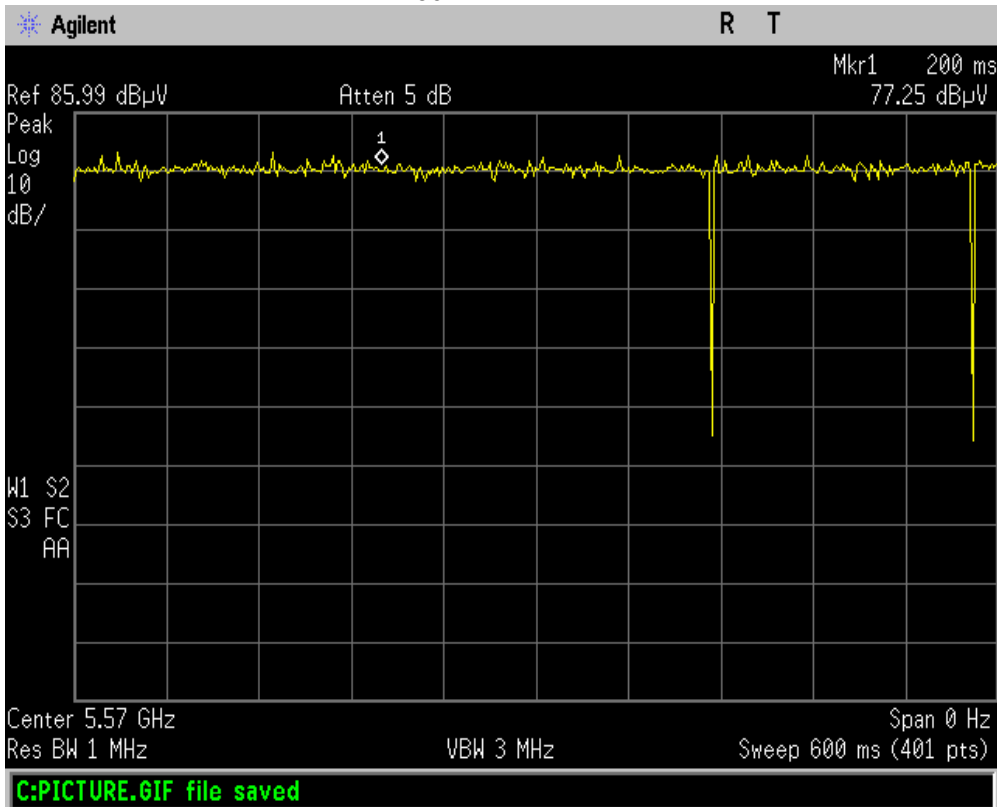



40 MHz Traffic

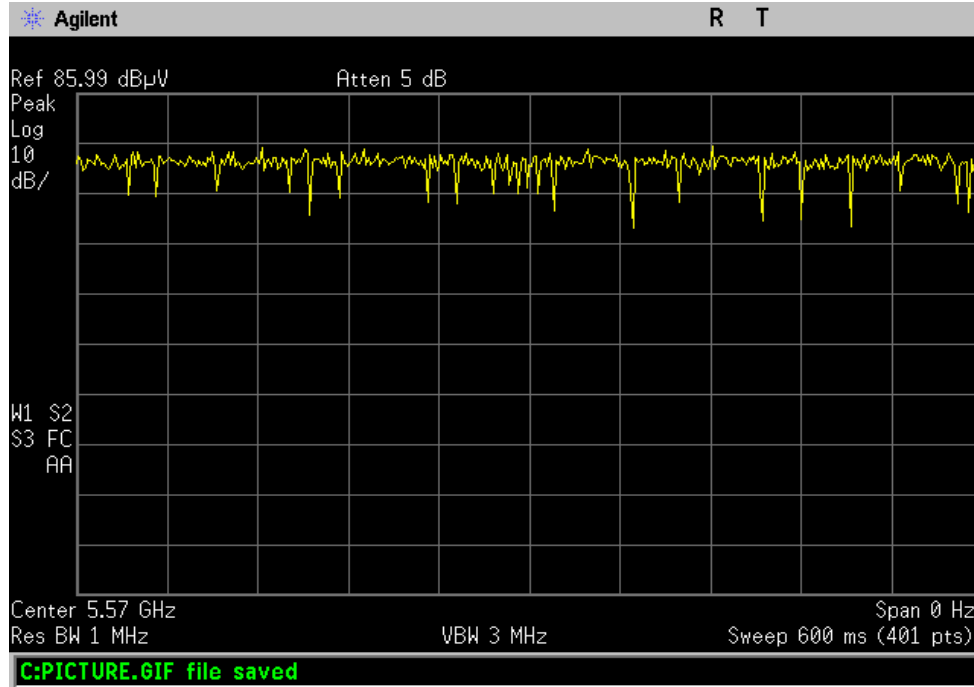

50 MHz Traffic

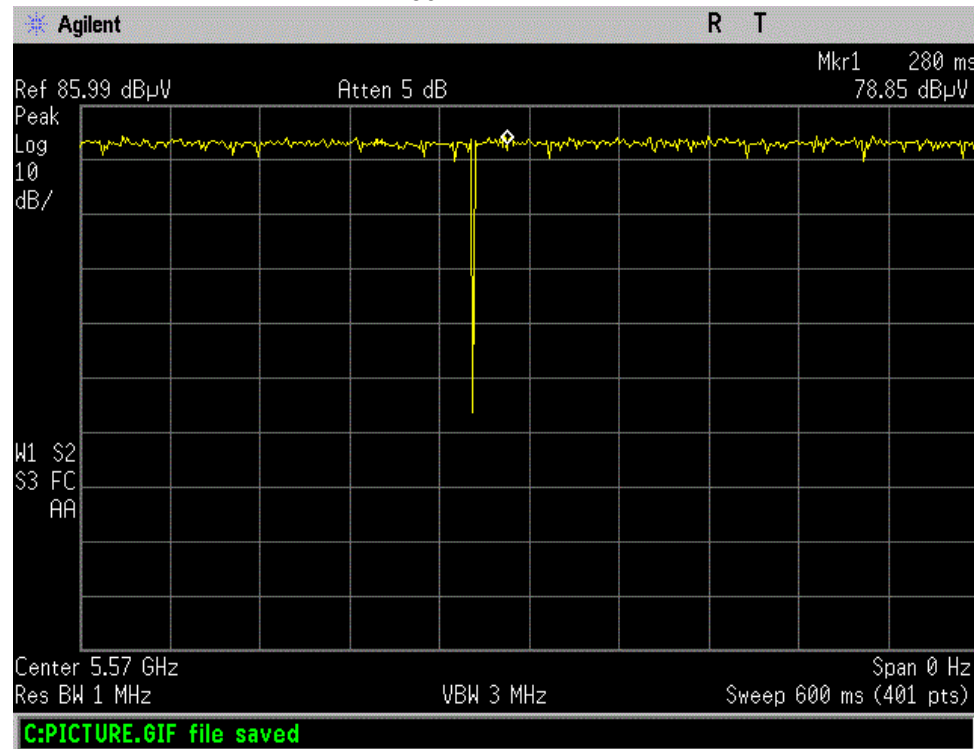



60 MHz Traffic

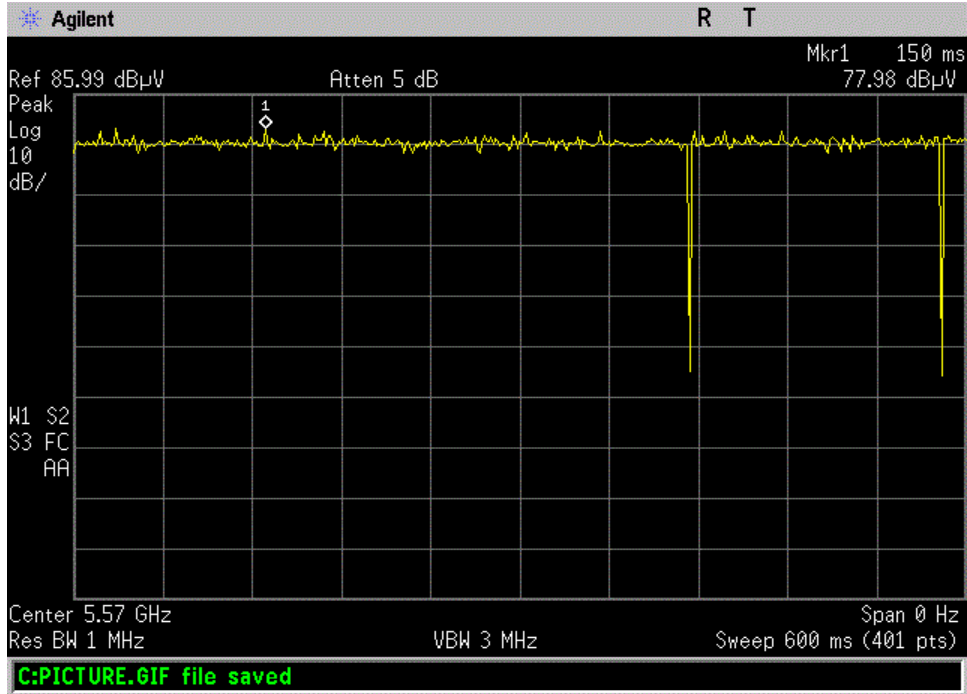

80 MHz Traffic

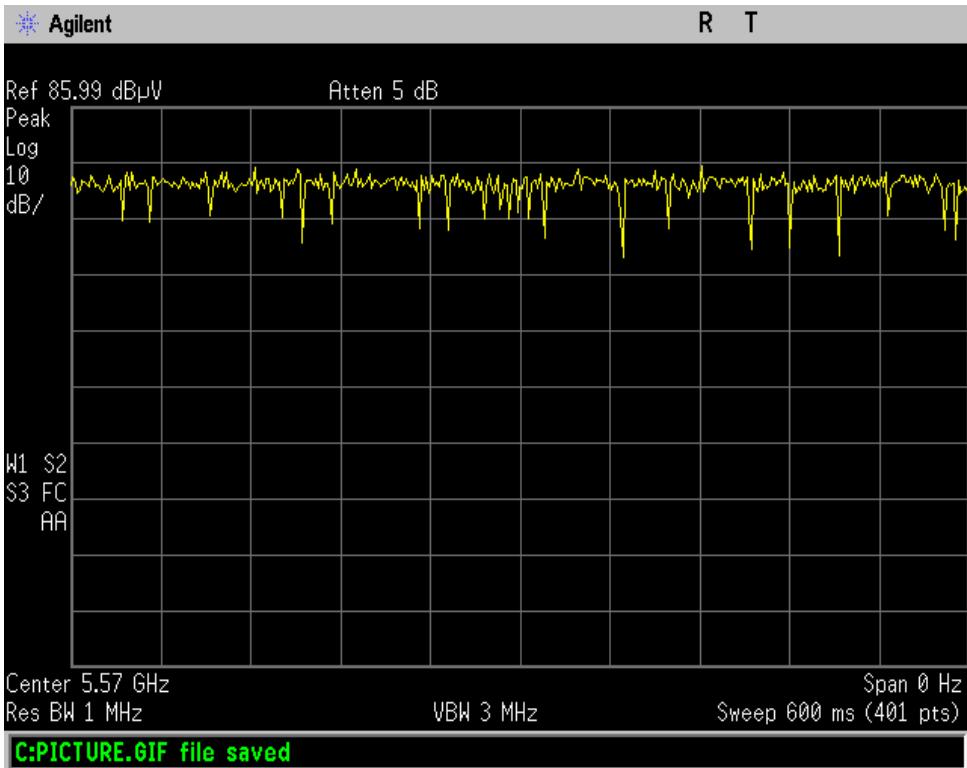



U-NII Detection Bandwidth

Engineer: Poona Saber

Test Date: 2/12/18

Test Requirements

The U-NII Detection Bandwidth must meet the U-NII Detection Bandwidth criterion as specified in 905462. Otherwise, the EUT does not comply with DFS requirements. In the case that the U-NII Detection Bandwidth is greater than or equal to the 99 percent power bandwidth for the measured F_H and F_L , the test can be truncated and the U-NII Detection Bandwidth can be reported as the measured F_H and F_L .

Test Procedure

The EUT was setup as a standalone device with no associated client and with no traffic. A single radar burst of types 0-4 was injected into the EUT at the center frequency of the channel and the response noted. A minimum of 10 trials was performed. The frequency of the radar signal was then decreased in 5MHz steps until the detection fell below the U-NII detection criterion. The frequency was then increased 5MHz and then decreased in 1MHz steps until the detection rate began to fall. This was noted as F_L . This was repeated on the other side of the center of the carrier and the frequency noted as F_H .

The U-NII Detection Bandwidth was calculated as follows:

$$\text{U-NII Detection Bandwidth} = F_H - F_L$$

Bandwidths (MHz)	FH (MHz)	FL (MHz)	FH-FL (MHz)	99% BW (MHz)	80% of 99% Bandwidth (MHz)	Delta (MHz)
10	5605	5595	10	8.88	7.1	-2.9
20	5610	5590	20	17.68	14.14	-5.86
30	5615	5585	30	26.70	21.36	-8.64
40	5618	5581	37	36.18	28.94	-8.06
50	5624	5576	48	44.42	35.53	-12.47
60	5629	5572	57	54.57	43.65	-13.35
80	5640	5560	80	75.49	60.39	-19.61

See Annex A for statistical Bandwidth test results



Initial CACT

Engineer: Alex Macoon

Test Date: 3/27/2018

Initial Channel Availability Check Time criteria

Definition

The Initial Channel Availability Check Time tests that the EUT does not emit beacon, control, or data signals on the test Channel until the power-up sequence has been completed and the U-NII device checks for Radar Waveforms for one minute on the test Channel.

Test Procedure

The monitoring spectrum analyzer was set to a zero span with a 3 MHz RBW and a 3 MHz VBW with a sweep time of 2.5 minutes. The EUT was powered on and instructed to operate on the appropriate U-NII Channel that incorporates DFS functions. At the same time the EUT was powered on the spectrum analyzer was triggered to sweep.

Requirement

The EUT should not transmit any beacon or data transmissions until at least 1 minute after the completion of the power-on cycle.

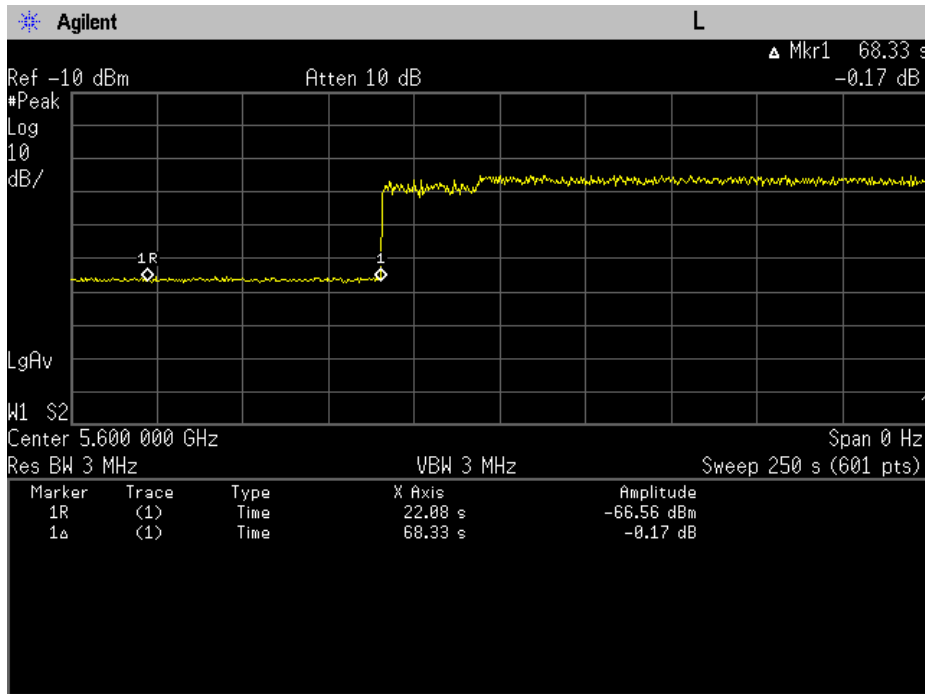



Radar Burst at the Beginning of the Channel Availability Check Time

Definition

The Radar Burst at the Beginning of the Channel Availability Check Time is to verify successful radar detection on the test channel during a period equal to the channel availability check time. A radar burst equal to the DFS detection threshold + 1dB is used.

Test Procedure

The monitoring spectrum analyzer was set to a zero span with a 3 MHz RBW and a 3 MHz VBW with a sweep time of 2.5 minutes. The EUT was powered on and instructed to operate on the appropriate U-NII Channel that incorporates DFS functions. At the same time the EUT was powered on the spectrum analyzer was triggered to sweep.

A single Burst of one of the Short Pulse Radar Types 0-4 was commenced within a 6 second window starting at the beginning of the channel availability check time. An additional 1 dB was added to the radar test signal to ensure it was at or above the DFS Detection Threshold.

Requirement

During the 2.5 minute measurement window the EUT will not transmit on that channel.

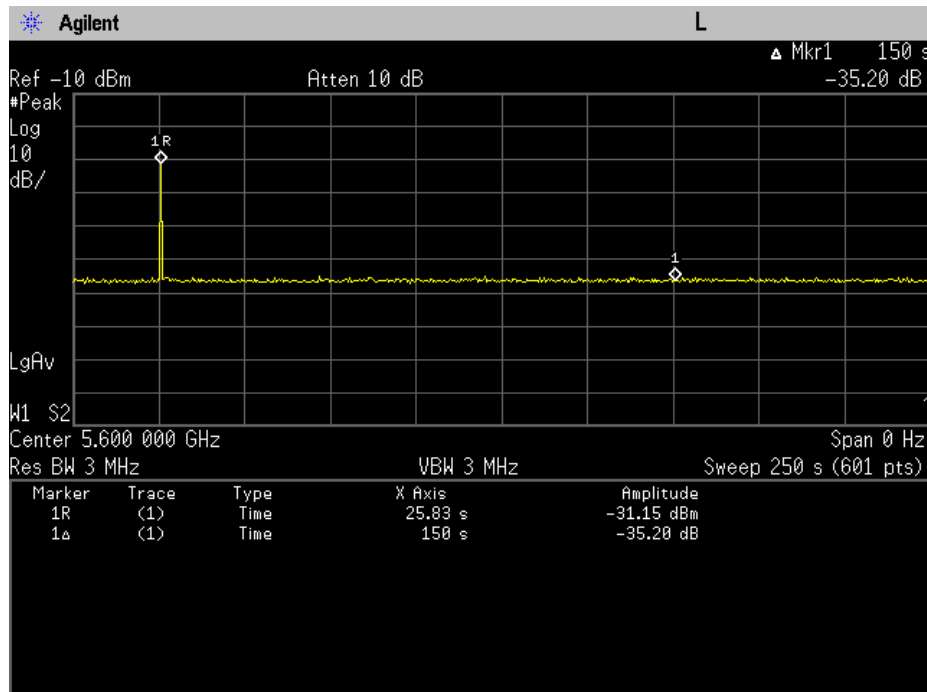



Radar Burst at the End of the Channel Availability Check Time

Definition

The Radar Burst at the End of the Channel Availability Check Time is to verify successful radar detection on the test channel during a period equal to the channel availability check time. A radar burst equal to the DFS detection threshold + 1dB is used.

Test Procedure

A single Burst of one of the Short Pulse Radar Types 0-4 was commenced within a 6 second window after the startup routine + 54 seconds. An additional 1 dB was added to the radar test signal to ensure it was at or above the DFS Detection Threshold.

Requirement

During the 2.5 minute measurement window the EUT will not transmit on that channel.

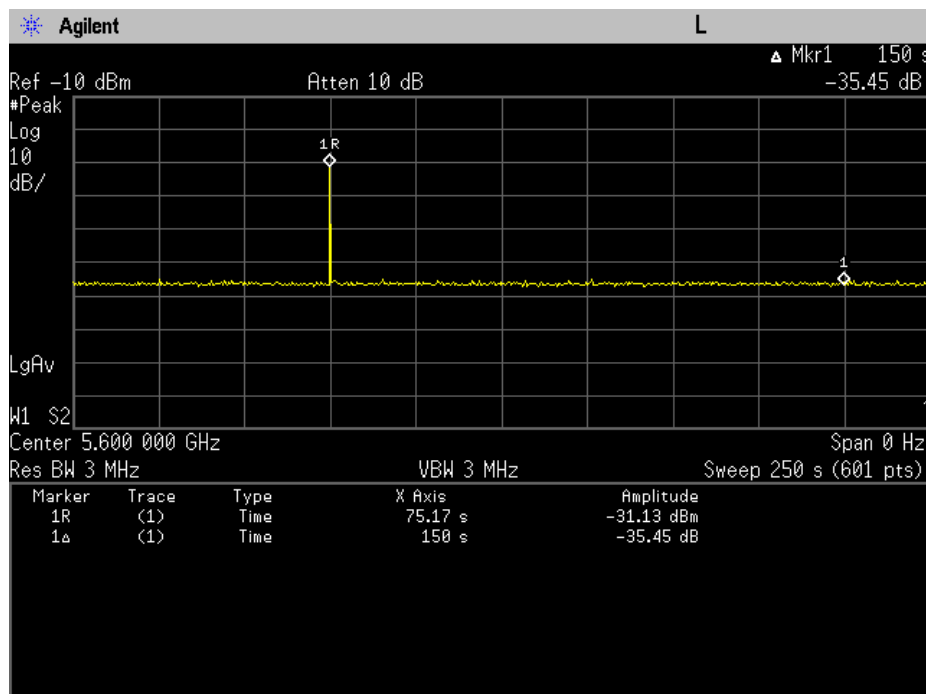



In-Service Monitoring for Channel Move Time, Channel Closing Transmission Time and Non-Occupancy Period

These tests define how the following DFS parameters are verified during In-Service Monitoring;

- Channel Closing Transmission Time
- Channel Move Time
- Non-Occupancy Period

The steps below define the procedure to determine the above mentioned parameters when a radar Burst with a level equal to the DFS Detection Threshold + 1dB is generated on the Operating Channel of the U-NII device (In- Service Monitoring).

- a. One frequency will be chosen from the Operating Channels of the EUT within the 5250-5350MHz or 5470-5725MHz bands. For 802.11 devices, the test frequency must contain control signals. This can be verified by disabling channel loading and monitoring the spectrum analyzer. If no control signals are detected, another frequency must be selected within the emission bandwidth where control signals are detected.
- b. In case the EUT is a U-NII device operating as a Client Device (with or without DFS), a U-NII device operating as a Master Device will be used to allow the EUT (Client device) to Associate with the Master Device. In case the EUT is a Master Device, a U-NII device operating as a Client Device will be used and it is assumed that the Client will Associate with the EUT (Master). In both cases for conducted tests, the Radar Waveform generator will be connected to the Master Device. Stream the channel loading test file from the Master Device to the Client Device on the test Channel for the entire period of the test.
- c. At time T0 the Radar Waveform generator sends a Burst of pulses for one of the Radar Type 0. An additional 1 dB is added to the radar test signal to ensure it is at or above the DFS Detection Threshold, accounting for equipment variations/errors.
- d. Observe the transmissions of the EUT at the end of the radar Burst on the Operating Channel for duration greater than 10 seconds. Measure and record the transmissions from the EUT during the observation time (Channel Move Time). Measure and record the Channel Move Time and Channel Closing Transmission Time if radar detection occurs.
- e. When operating as a Master Device, monitor the EUT for more than 30 minutes following instant T2 to verify that the EUT does not resume any transmissions on this Channel. Perform this test once and record the measurement result.
- f. In case the EUT is a U-NII device operating as a Client Device with In-Service Monitoring, perform steps a) to f).



Channel Move time

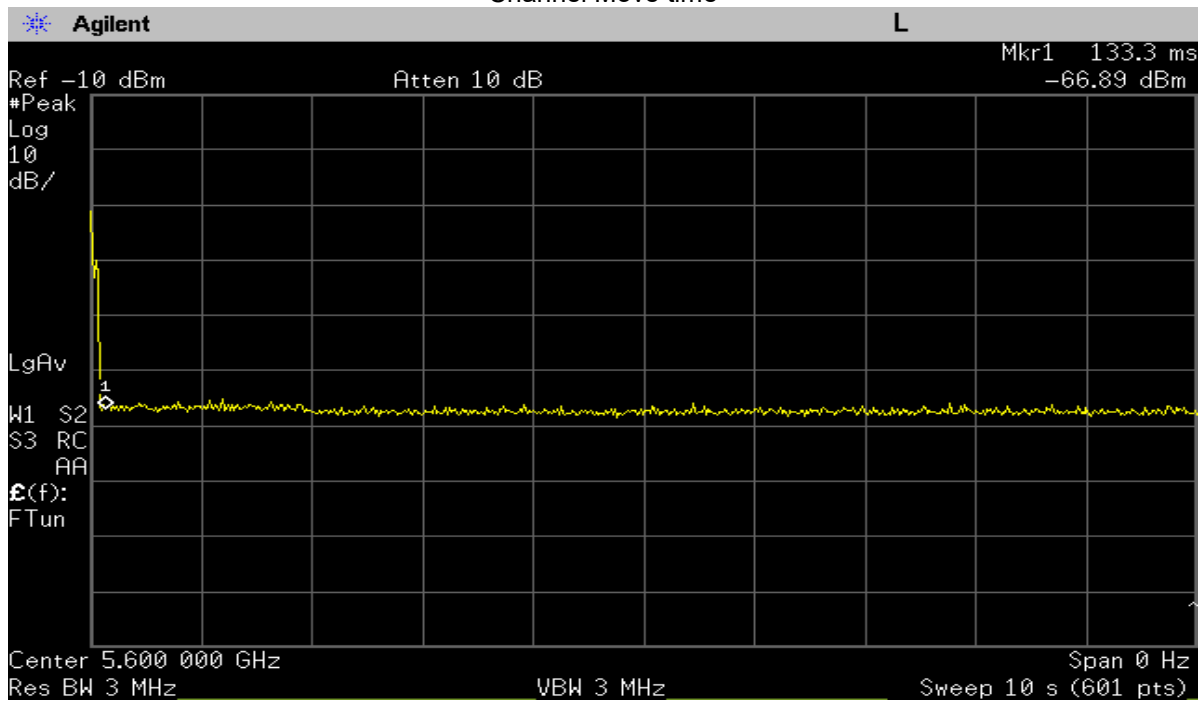

Channel Closing time

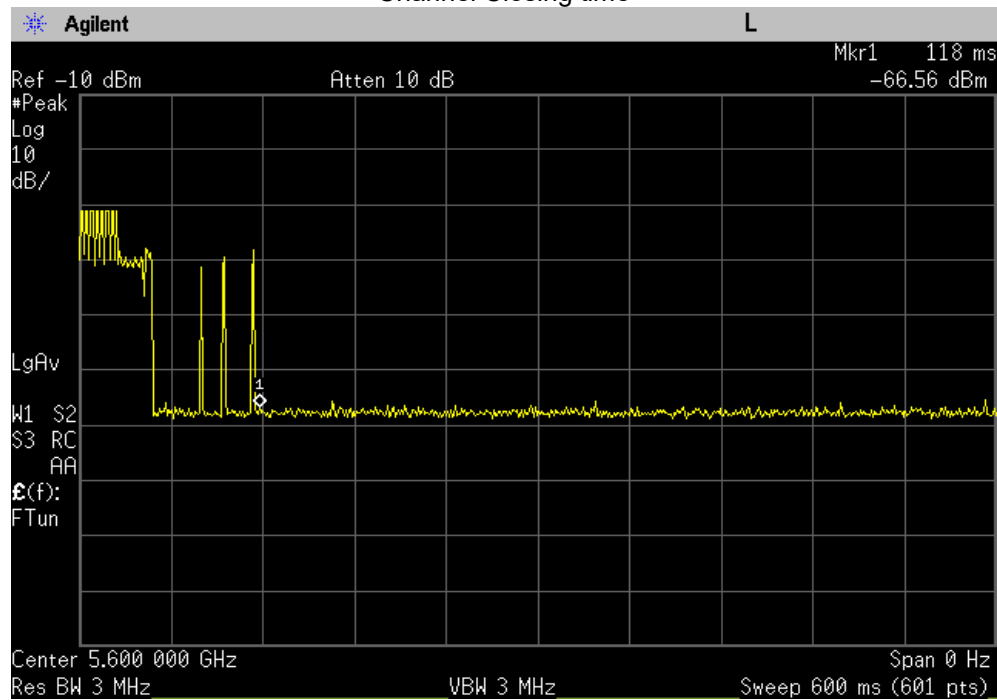



Non occupancy time

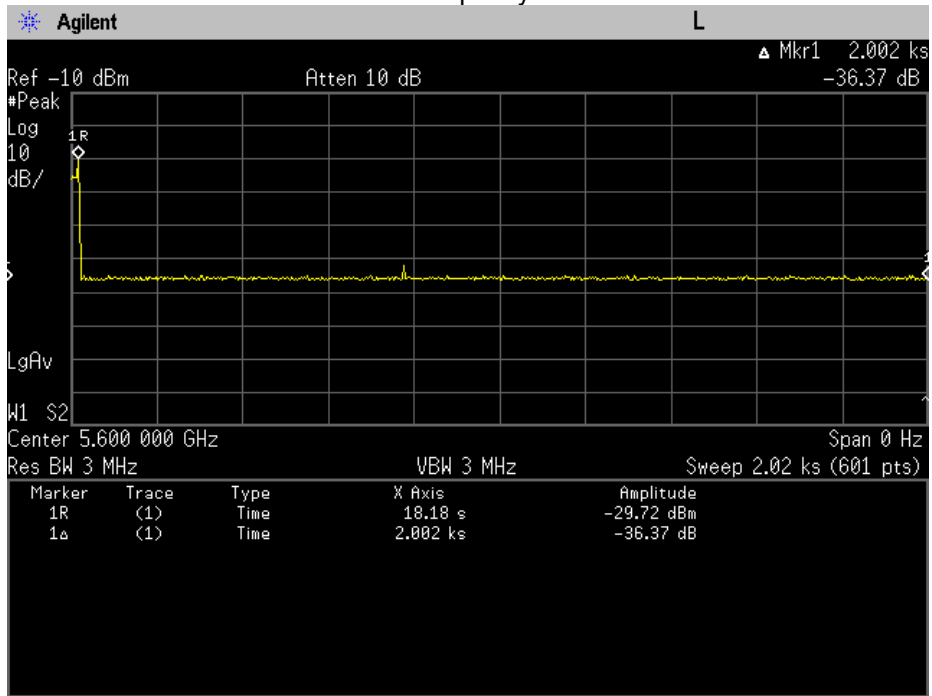



Statistical Performance Check

The steps below define the procedure to determine the minimum percentage of successful detection requirements when a radar burst with a level equal to the DFS Detection Threshold + 1dB is generated on the Operating Channel of the U-NII device (In- Service Monitoring).

- a) One frequency will be chosen from the Operating Channels of the EUT within the 5250-5350MHz or 5470-5725MHz bands.
- b) In case the EUT is a U-NII device operating as a Client Device (with or without Radar Detection), a U-NII device operating as a Master Device will be used to allow the EUT (Client device) to Associate with the Master Device. In case the EUT is a Master Device, a U-NII device operating as a Client Device will be used and it is assumed that the Client will associate with the EUT 905462 D02 UNII DFS Compliance Procedures New Rules v01r02 Page 37 (Master). In both cases for conducted tests, the Radar Waveform generator will be connected to the Master Device. Stream the channel loading test file from the Master Device to the Client Device on the test Channel for the entire period of the test.
- c) At time T0 the Radar Waveform generator sends the individual waveform for each of the Radar Types 1- 6 on the Operating Channel. An additional 1 dB is added to the radar test signal to ensure it is at or above the DFS Detection Threshold, accounting for equipment variations/errors.
- d) Observe the transmissions of the EUT at the end of the Burst on the Operating Channel for duration greater than 10 seconds for Radar Type 0 to ensure detection occurs.
- e) Observe the transmissions of the EUT at the end of the Burst on the Operating Channel for duration greater than 22 seconds for Long Pulse Radar Type 5 to ensure detection occurs.
- f) In case the EUT is a U-NII device operating as a Client Device with In-Service Monitoring, perform steps a) to f).

Long Pulse Radar Test

Three subsets of trials are performed with a minimum of ten trials per subset. The frequency is determined below:

- a) the Channel center frequency
- b) tuned frequencies such that 90% of the Long Pulse Type 5 frequency modulation is within the low edge of the UUT Occupied Bandwidth and
- c) tuned frequencies such that 90% of the Long Pulse Type 5 frequency modulation is within the high edge of the UUT Occupied Bandwidth .

See Annex B for Statistical Performance Check results

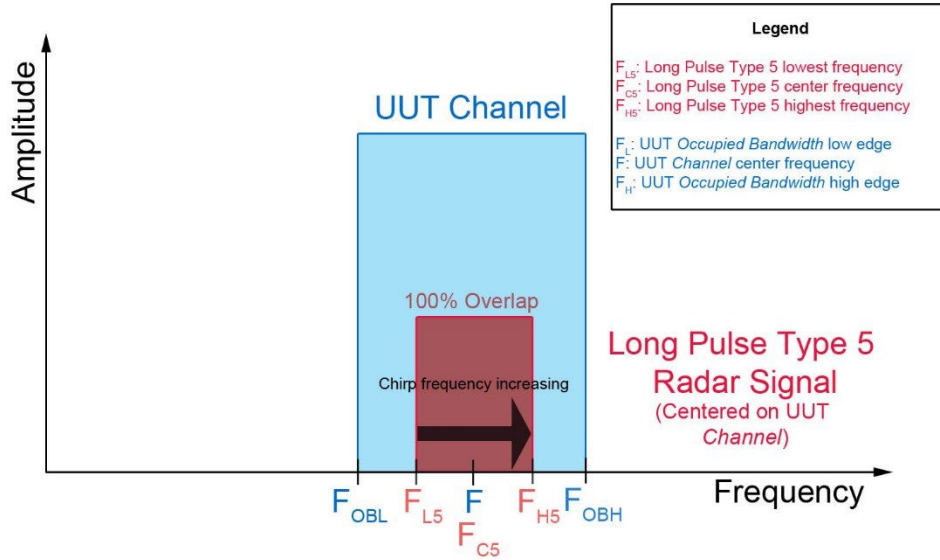

For subset case 1: the center frequency of the signal generator will remain fixed at the center of the UUT Channel.

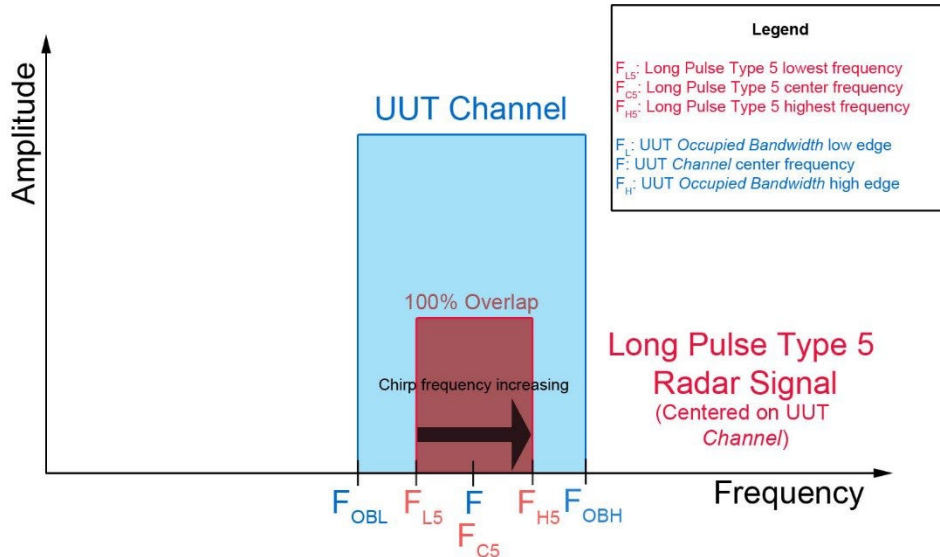

For subset case 2: to retain 90% frequency overlap between the radar signal and the UUT Occupied Bandwidth, the center frequency of the signal generator will vary for each of the ten trials in subset case 2. The center frequency of the signal generator for each trial is calculated by:

$$F_L + (0.4 * Chirp Width [in MHz])$$

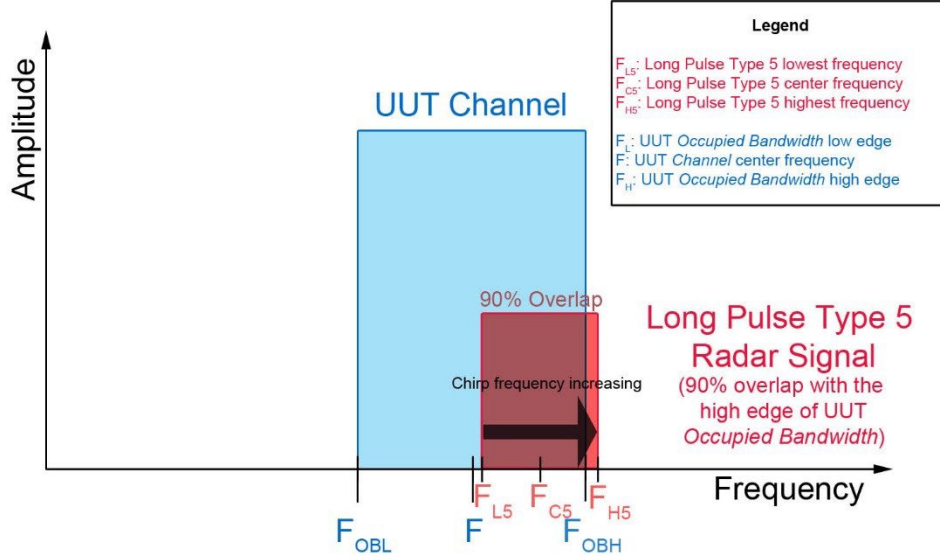

For subset case 3: to retain 90% frequency overlap between the radar signal and the UUT *Occupied Bandwidth*, the center frequency of the signal generator will vary for each of the ten trials in subset case 3. The center frequency of the signal generator for each trial is calculated by:
 $F_H - (0.4 * \text{Chirp Width [in MHz]})$



For subset case 1: the center frequency of the signal generator will remain fixed at the center of the UUT *Channel*.
For subset case 2: to retain 90% frequency overlap between the radar signal and the UUT *Occupied Bandwidth*, the center frequency of the signal generator will vary for each of the ten trials in subset case 2. The center frequency of the signal generator for each trial is calculated by:
 $FL + (0.4 * Chirp\ Width\ [in\ MHz])$

For subset case 3: to retain 90% frequency overlap between the radar signal and the UUT *Occupied Bandwidth*, the center frequency of the signal generator will vary for each of the ten trials in subset case 3. The center frequency of the signal generator for each trial is calculated by:
 $FH - (0.4 * Chirp\ Width\ [in\ MHz])$

The percentage of successful detection is calculated by dividing the sum of the detections for the three subsets by the sum of trials for the three subsets: 100

7.8.4.3 Frequency Hopping Radar Test

Statistical data will be gathered to determine the ability of the device to detect the Frequency Hopping radar test signal (radar type 6) found in **Table 7**. The device can utilize a test mode to demonstrate when detection occurs to prevent the need to reset the device between trial runs. The probability of successful detection is calculated by:



Short Pulse Radar Test Summary

Once the performance requirements check is complete, statistical data will be gathered to determine the ability of the device to detect the radar test waveforms. The device can utilize a test mode to demonstrate when detection occurs to prevent the need to reset the device between trials. The percentage of successful detection is calculated by:

$$\frac{\text{Total Waveform Detections}}{\text{Total Waveform Trials}} = \text{Percentage of Successful Detection Radar Waveform } N = P_dN$$

In addition an aggregate minimum percentage of successful detection across all Short Pulse Radar Types 1-4 is required and is calculated as follows:

$$\frac{Pd1 + Pd2 + Pd3 + Pd4}{4}$$

10MHz Bandwidth

Radar Type	Number of Trials	Number of Successful Detections	Minimum Percentage of Successful Detection
1	30	30	100%
2	30	30	100%
3	30	30	100%
4	30	30	100%
Aggregate (100% + 100% + 100% + 100%)/4 = 100%			

20MHz Bandwidth

Radar Type	Number of Trials	Number of Successful Detections	Minimum Percentage of Successful Detection
1	30	30	100%
2	30	30	100%
3	30	30	100%
4	30	30	100%
Aggregate (100% + 100% + 100% + 100%)/4 = 100%			



30MHz Bandwidth

Radar Type	Number of Trials	Number of Successful Detections	Minimum Percentage of Successful Detection
1	30	20	66%
2	30	18	60%
3	30	28	93%
4	30	28	93%

Aggregate $(66\% + 60\% + 93\% + 93\%)/4 = 78\%$

40MHz Bandwidth

Radar Type	Number of Trials	Number of Successful Detections	Minimum Percentage of Successful Detection
1	30	23	77%
2	30	30	100%
3	30	30	100%
4	30	22	73%

Aggregate $77\% + 100\% + 100\% + 73\%/4 = 87.5\%$

50MHz Bandwidth

Radar Type	Number of Trials	Number of Successful Detections	Minimum Percentage of Successful Detection
1	30	22	73%
2	30	28	93%
3	30	26	87%
4	30	19	63%

Aggregate $(73\% + 93\% + 87\% + 63\%)/4 = 79\%$



60MHz Bandwidth

Radar Type	Number of Trials	Number of Successful Detections	Minimum Percentage of Successful Detection
1	30	19	63%
2	30	19	63%
3	30	27	90%
4	30	23	77%

Aggregate $(63\% + 63\% + 90\% + 77\%)/4 = 73.25\%$

80MHz Bandwidth

Radar Type	Number of Trials	Number of Successful Detections	Minimum Percentage of Successful Detection
1	30	22	73%
2	30	21	70%
3	30	29	97%
4	30	28	93%

Aggregate $(73\% + 70\% + 97\% + 93\%)/4 = 83.25\%$

See Annex C for Bins 1-4 used for all Bandwidth tests



Long Pulse Radar Test

Statistical data will be gathered to determine the ability of the device to detect the Long Pulse Radar Type 5. The device can utilize a test mode to demonstrate when detection occurs to prevent the need to reset the device between trials. The percentage of successful detection is calculated by:

$$\frac{\text{Total Waveform Detections}}{\text{Total Waveform Trials}} \times 100$$

10MHz Bandwidth

Radar Type	Number of Trials	Number of Successful Detections	Minimum Percentage of Successful Detection
5	30	30	100

20MHz Bandwidth

Radar Type	Number of Trials	Number of Successful Detections	Minimum Percentage of Successful Detection
5	30	25	83

30MHz Bandwidth

Radar Type	Number of Trials	Number of Successful Detections	Minimum Percentage of Successful Detection
5	30	24	80

40MHz Bandwidth

Radar Type	Number of Trials	Number of Successful Detections	Minimum Percentage of Successful Detection
5	30	24	80

50MHz Bandwidth

Radar Type	Number of Trials	Number of Successful Detections	Minimum Percentage of Successful Detection
5	30	25	83

60MHz Bandwidth

Radar Type	Number of Trials	Number of Successful Detections	Minimum Percentage of Successful Detection
5	30	24	80

80MHz Bandwidth

Radar Type	Number of Trials	Number of Successful Detections	Minimum Percentage of Successful Detection
5	30	24	80

See Annex D for Bin 5 used for all Bandwidth tests



Frequency Hopping Radar Test

Statistical data will be gathered to determine the ability of the device to detect the Frequency Hopping radar test signal. The probability of successful detection is calculated by:

$$\frac{\text{Total Waveform Detections}}{\text{Total Waveform Trials}} \times 100$$

10MHz Bandwidth

Radar Type	Number of Trials	Number of Successful Detections	Minimum Percentage of Successful Detection
6	30	29	97

20MHz Bandwidth

Radar Type	Number of Trials	Number of Successful Detections	Minimum Percentage of Successful Detection
6	30	26	87

30MHz Bandwidth

Radar Type	Number of Trials	Number of Successful Detections	Minimum Percentage of Successful Detection
6	30	27	90

40MHz Bandwidth

Radar Type	Number of Trials	Number of Successful Detections	Minimum Percentage of Successful Detection
6	30	27	90

50MHz Bandwidth

Radar Type	Number of Trials	Number of Successful Detections	Minimum Percentage of Successful Detection
6	30	29	97

60MHz Bandwidth

Radar Type	Number of Trials	Number of Successful Detections	Minimum Percentage of Successful Detection
6	30	27	90

80MHz Bandwidth

Radar Type	Number of Trials	Number of Successful Detections	Minimum Percentage of Successful Detection
6	30	26	87



Measurement Uncertainty

Test Procedure	Uncertainty
Conducted RF Power	±.75dB
Conducted Emissions (AC Line)	±3.21dB
Radiated Emissions (Signal Line)	±4.5dB
Radiated Spurious Emissions	±4.82
Conducted Spurious Emissions	± 2.49 dB
Occupied Bandwidth	±5%
Power Spectral Density	±1.8dB
DTS Bandwidth	±3%
Frequency	±1Hz
Harmonic Currents	95%
Voltage Flicker	95%
AC Voltage	± 2.3 %
DC Voltage	± 0.12 %
Temperature	± 1.0 deg C
Humidity	± 4.32 %

Test Equipment Utilized

Description	Manufacturer	Model #	CT Asset #	Last Cal Date	Cal Due Date
Spectrum Analyzer	Keysight	E4407B	i00331	11/21/2017	11/21/2018
Signal Generator	Hewlett Packard	83650A	i00353	Verified on : 2/12/18	
PXI housing	National Instruments	PXI-1042	i00443	N/A	N/A
Imbedded Controller	National Instruments	PXI-8106		N/A	N/A
RF Up-converter	National Instruments	PXI-5610		N/A	N/A
Arbitrary wave form generator	National Instruments	PXI-5421		N/A	N/A
Signal Generator	Aeroflex	PXI-3025		N/A	N/A
RF Synthesizer	Aeroflex	PXI-3010		N/A	N/A
Pre-amp	Hewlett Packard	8449A	i00028	Verified on : 2/12/18	
Combiner/Splitter	Mini-Circuits	ZX10R-14-S	N/A	N/A	N/A
Mixer	Mini-Circuits	ZX05-83LH-S	N/A	N/A	N/A

END OF TEST REPORT