



427 West 12800 South
Draper, UT 84020

Test Report Certification

FCC ID	SWX-AF60XRR
ISED ID	6545A-AF60XRR
Equipment Under Test	AF60-XRR
Test Report Serial Number	TR8572_03
Date of Test(s)	14 July through 23 August, 2023
Report Issue Date	4 December 2023

Test Specification	Applicant
47 CFR FCC Part 15, Subpart E RSS-GEN	Ubiquiti Inc. 685 Third Avenue New York, NY 10019 U.S.A.



NVLAP LAB CODE 600241-0

Certification of Engineering Report

This report has been prepared by Unified Compliance Laboratory (UCL) to document compliance of the device described below with the requirement of Federal Communication Commissions (FCC) Part 15, Subpart E. This report may be reproduced in full. Partial reproduction of this report may only be made with the written consent of the laboratory. The results in this report apply only to the sample tested.

Applicant	UBIQUITI
Manufacturer	UBIQUITI
Brand Name	UBIQUITI
Model Number	AF60-XRR
FCC ID	SWX-AF60XRR
ISED ID	6545A-AF60XRR

On this 4th day of December 2023, I individually and for Unified Compliance Laboratory certify that the statements made in this engineering report are true, complete and correct to the best of my knowledge and are made in good faith.

Although NVLAP has accredited the Unified Compliance Laboratory testing facilities, this report must not be used to claim product certification, approval, or endorsement by NVLAP, NIST or any agency of the U.S. federal government.

Unified Compliance Laboratory



Written By: Clay Allred



Reviewed By: Joseph W. Jackson

Revision History		
Revision	Description	Date
01	Original Report Release	20 October 2023
02	Amend PSD Limits in Section 5.6	27 November 2023
03	Amend PSD Limits in Section 5.6	4 December 2023

Table of Contents

1	Client Information.....	5
1.1	Applicant.....	5
1.2	Manufacturer.....	5
2	Equipment Under Test (EUT).....	6
2.1	Identification of EUT.....	6
2.2	Description of EUT.....	6
2.3	EUT and Support Equipment.....	6
2.4	Interface Ports on EUT.....	7
2.5	Operating Environment.....	7
2.6	Operating Modes.....	7
2.7	EUT Exercise Software.....	7
2.8	Block Diagram of Test Configuration.....	8
2.9	Modification Incorporated/Special Accessories on EUT.....	8
2.10	Deviation, Opinions Additional Information or Interpretations from Test Standard.....	8
3	Test Specification, Method and Procedures.....	9
3.1	Test Specification.....	9
3.2	Methods & Procedures.....	9
3.3	FCC Part 15, Subpart E.....	9
3.4	Results.....	9
3.5	Test Location.....	9
4	Test Equipment.....	11
4.1	Conducted Emissions at Mains Ports.....	11
4.2	Direct Connect at the Antenna Port Tests.....	11
4.3	Radiated Emissions.....	12
4.4	Equipment Calibration.....	13
4.5	Measurement Uncertainty.....	13
5	Test Results.....	14
5.1	§15.203 Antenna Requirements.....	14
5.2	Conducted Emissions at Mains Ports Data.....	14
5.3	§15.403(i) 26 dB Emissions Bandwidth.....	16
5.4	§15.403(a)(3) Maximum Average Output Power.....	17
5.5	§15.407(b)(7) Spurious Emissions.....	18
5.6	§15.407(a) Maximum Power Spectral Density.....	24

1 Client Information

1.1 Applicant

Company	Ubiquiti Inc. 685 Third Avenue New York, NY 10017 U.S.A.
Contact Name	Alex Macon
Title	Compliance Manager

1.2 Manufacturer

Company	Ubiquiti Inc. 685 Third Avenue New York, NY 10017 U.S.A.
Contact Name	Alex Macon
Title	Compliance Manager

2 Equipment Under Test (EUT)

2.1 Identification of EUT

Brand Name	UBIQUITI
Model Number	AF60-XRR
Serial Number	FCECDAFFE77E
Dimensions (cm)	77.9 x 66.4 x 38.3

2.2 Description of EUT

The AF60-XRR is a 60 GHz point-to-point wireless bridge which provides 2.5+ Gbps throughput connectivity over long distances. The AF60-XRR provides an integrated high-gain dish antenna for high speed, long-range point-to-point links. The AF60-XRR provides a 5 GHz 2x2 radio with cross polarized elements as a backup radio for operation redundancies. The AF60-XRR also includes a Bluetooth management radio for setup and configuration. The AF60-XRR is powered from a 48 Volt PoE Power Adapter.

The table below show the channels used within the different modulation bandwidths.

Band	WiFi Mode	Modulation Bandwidth	Modulation Type	Frequency (MHz)
UNII-3	a	20 MHz	OFDM	5745, 5775, 5825
	n	20 MHz	HT	5745, 5775, 5825
	n	40 MHz	HT	5755, 5775, 5795
	ac	20 MHz	VHT	5745, 5775, 5825
	ac	40 MHz	VHT	5755, 5775, 5795
	ac	80 MHz	VHT	5775

This report covers the circuitry of the device subject to FCC Part 15, Subpart E. The circuitry of the device subject to FCC Part 15 Subpart B was found to be compliant and is covered under a separate Unified Compliance Laboratory test report.

2.3 EUT and Support Equipment

The EUT and support equipment used during the test are listed below.

Brand Name Model Number Serial Number	Description	Name of Interface Ports / Interface Cables
BN: UBIQUITI MN: AF60-XRR (Note 1) SN: FCECDAFFE77E	Wireless Access Point	See Section 2.4

BN: UBIQUITI MN: UPOE-at SN: N/A	PoE Injector Power Supply	Shielded or Un-shielded Cat 5e cable/1 meter
BN: Dell MN: XPS 13 SN: N/A	Laptop Personal Computer	Shielded or Un-shielded Cat 5e cable/1 meter

Notes: (1) EUT

(2) Interface port connected to EUT (See Section 2.4)

The support equipment listed above was not modified in order to achieve compliance with this standard.

2.4 Interface Ports on EUT

Name of Ports	No. of Ports Fitted to EUT	Cable Description/Length
AC	1	3 conductor power cord/80 cm
PoE	1	Shielded or Un-shielded Cat 5e cable/1 meter
LAN	1	Shielded or Un-shielded Cat 5e cable/1 meter

2.5 Operating Environment

Power Supply	120 Vac to 48 Volts PoE Power
AC Mains Frequency	60 Hz
Temperature	22.0 – 26.0 °C
Humidity	22.4 – 48.3 %
Barometric Pressure	1003 mBar

2.6 Operating Modes

The AF60-XRR was tested using test software in order to enable a constant transmission. The measurements within this report are corrected to reference a 100% duty cycle. All emission modes of 802.11 a/n/ac were investigated. All measurements are reported with the worst-case mode (802.11ac) unless otherwise stated.

2.7 EUT Exercise Software

EUT firmware version 1.0 was used to operate the transmitter using a constant transmit mode.

2.8 Block Diagram of Test Configuration

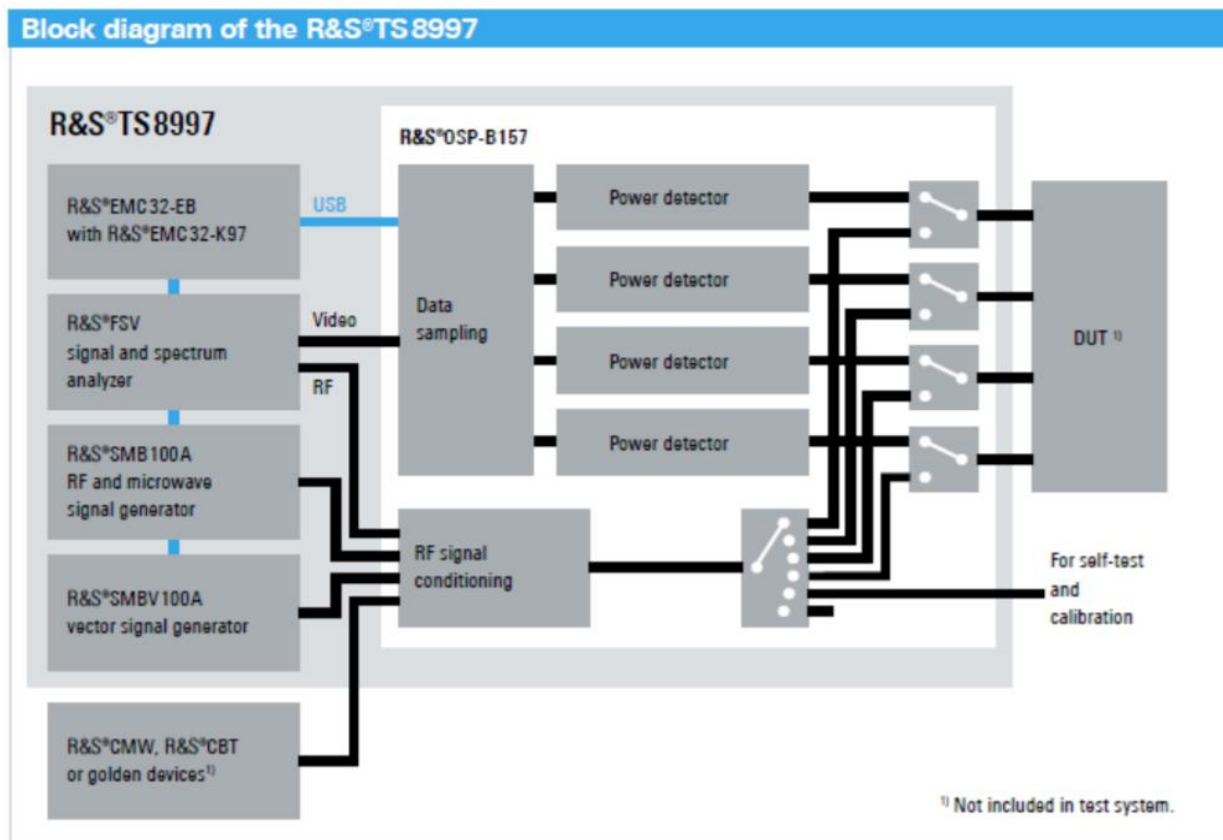

Diagram 1: Test Configuration Block Diagram

2.9 Modification Incorporated/Special Accessories on EUT

There were no modifications made to the EUT during testing to comply with the specification.

2.10 Deviation, Opinions Additional Information or Interpretations from Test Standard

There were no deviations, opinions, additional information or interpretations from the test specification.

3 Test Specification, Method and Procedures

3.1 Test Specification

Title	47 CFR FCC Part 15, Subpart E, Section 15.407 Limits and methods of measurement of radio interference characteristics of Unlicensed National Information Infrastructure Devices
Purpose of Test	The tests were performed to demonstrate initial compliance

3.2 Methods & Procedures

3.2.1 47 CFR FCC Part 15 Section 15.407

See test standard for details.

3.3 FCC Part 15, Subpart E

3.3.1 Summary of Tests

FCC Section	ISED Section	Environmental Phenomena	Frequency Range (MHZ)	Result
15.407(a)	N/A	Antenna requirements	Structural Requirement	Compliant
15.407(b)	RSS-Gen	Conducted Disturbance at Mains Port	0.15 to 30	Compliant
15.407(c)	RSS-247 §6.2.2, §6.2.3	Bandwidth Requirement	5725 to 5850	Compliant
15.407(e)	RSS-247 §6.2.2, §6.2.3	Peak Output Power	5725 to 5850	Compliant
15.407(f)	RSS-247 §6.2.2, §6.2.3	Antenna Conducted Spurious Emissions	0.009 to 40000	N/A
15.407(g)	RSS-247 §6.2.2, §6.2.3	Radiated Spurious Emissions	0.009 to 40000	Compliant
15.407(h)	RSS-247 §6.2.2, §6.2.3	Peak Power Spectral Density	5725 to 5850	Compliant

The testing was performed according to the procedures in ANSI C63.10-2013, KDB 789033 and 47 CFR Part 15. Where applicable, KDB 662911 was followed to sum required measurements.

3.4 Results

In the configuration tested, the EUT complied with the requirements of the specification.

3.5 Test Location

Testing was performed at the Unified Compliance Laboratory 3-Meter 10-Meter chambers located at 427 West 12800 South, Draper, UT 84020. Unified Compliance Laboratory is accredited by National Voluntary Laboratory Accreditation Program (NVLAP); NVLAP Code 600241-0 which is effective until

30 June 2024. This site has also been registered with Innovations, Science and Economic Development (ISED) department as was accepted under Appendix B, Phase 1 procedures of the APEC Tel MRA for Canadian recognition. ISED No.: 25346, effective until 30 June 2024. Unified Compliance Laboratory has been assigned Conformity Assessment Number US0223 by ISED.

4 Test Equipment

4.1 Conducted Emissions at Mains Ports

Type of Equipment	Manufacturer	Model Number	Asset Number	Date of Last Calibration	Due Date of Calibration
EMI Receiver	AFJ	FFT3010	UCL-2500	8/29/2023	8/29/2024
LISN	AFJ	LS16C/10	UCL-6749	12/6/2021	12/6/2023
ISN	Teseq	ISN T800	UCL-2974	6/27/2023	6/27/2024
AC Power Source	Laplace Instruments	AC1000A	UCL-2857	N/A	N/A
Test Software	UCL	Revision 1	UCL-3107	N/A	N/A

Table 1: List of equipment used for Conducted Emissions Testing at Mains Port

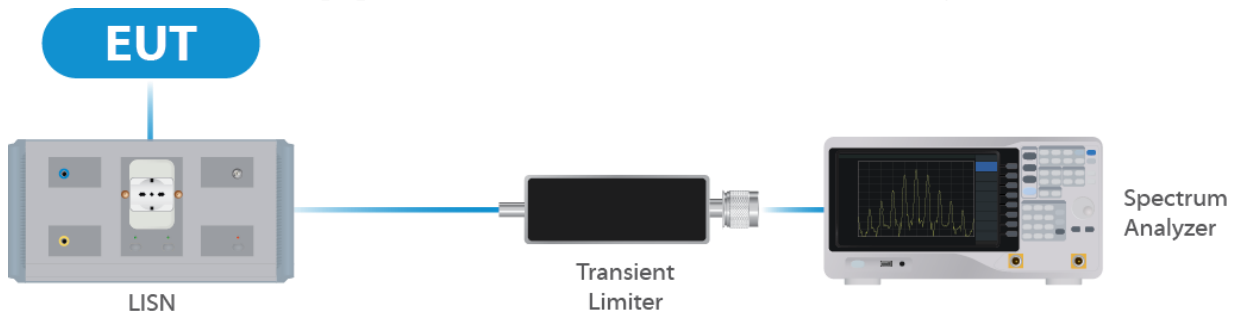

Figure 1: Conducted Emissions Test

4.2 Direct Connect at the Antenna Port Tests

Type of Equipment	Manufacturer	Model Number	Asset Number	Date of Last Calibration	Due Date of Calibration
Spectrum Analyzer	R&S	FSV40	UCL-2861	11/07/2022	11/07/2023
Signal Generator	R&S	SMB100A	UCL-2864	N/A	N/A
Vector Signal Generator	R&S	SMBV100A	UCL-2873	N/A	N/A
Switch Extension	R&S	OSP-B157WX	UCL-2867	2/22/2023	2/22/2024
Switch Extension	R&S	OSP-150W	UCL-2870	2/22/2023	2/22/2024

Table 2: List of equipment used for Direct Connect at the Antenna Port

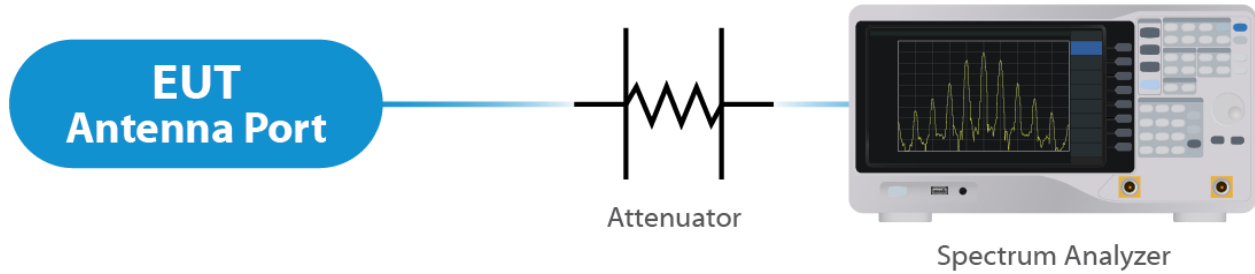

Figure 2: Direct Connect at the Antenna Port Test



Figure 3: Output Power Measurement

4.3 Radiated Emissions

Type of Equipment	Manufacturer	Model Number	Asset Number	Date of Last Calibration	Due Date of Calibration
EMI Receiver	Keysight	N9038A	UCL-2778	1/27/2023	1/27/2024
Pre-Amplifier 9 kHz – 1 GHz	Sonoma Instruments	310N	UCL-2889	12/7/2022	12/7/2023
Broadband Antenna	Scwarzbeck	VULB 9163	UCL-3062	2/22/2023	2/22/2025
Broadband Antenna	Scwarzbeck	VULB 9163	UCL-3071	1/11/2023	1/11/2024
Double Ridge Horn Antenna	Scwarzbeck	BBHA 9120D	UCL-3065	3/10/2023	3/10/2024
15 - 40 GHz Horn Antenna	Scwarzbeck	BBHA 9170	UCL-2487	3/10/2023	3/10/2024
1 – 18 GHz Amplifier	Com-Power	PAM 118A	UCL-3833	12/9/2022	12/9/2023
Test Software	UCL	Revision 1	UCL-3108	N/A	N/A

Table 3: List of equipment used for Radiated Emissions

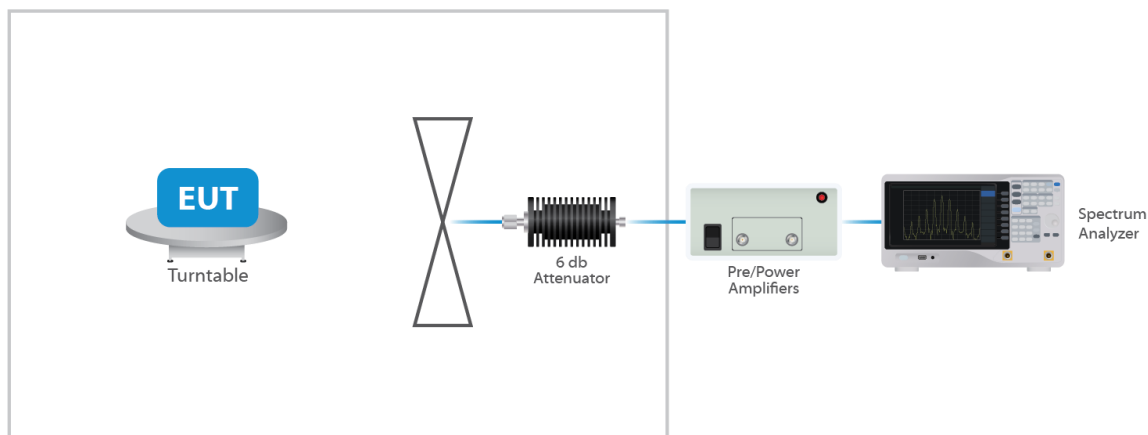

Figure 4: Radiated Emissions Test

4.4 Equipment Calibration

All applicable equipment is calibrated using either an independent calibration laboratory or Unified Compliance Laboratory personnel at intervals defined in ANSI C63.4:2014 following outlined calibration procedures. All measurement instrumentation is traceable to the National Institute of Standards and Technology (NIST). Supporting documentation relative to traceability is on file and is available for examination upon request.

4.5 Measurement Uncertainty

Test	Uncertainty (\pm dB)	Confidence (%)
Conducted Emissions	1.44	95
Radiated Emissions (9 kHz to 30 MHz)	2.50	95
Radiated Emissions (30 MHz to 1 GHz)	4.38	95
Radiated Emissions (1 GHz to 18 GHz)	4.37	95
Radiated Emissions (18 GHz to 40 GHz)	3.93	95
Direct Connect Tests	K Factor	Value
Emissions Bandwidth	2	2.0%
Output Power	2	1.0 dB
Peak Power Spectral Density	2	1.3 dB
Band Edge	2	0.8 dB
Transmitter Spurious Emissions	2	1.8 dB

5 Test Results

5.1 §15.203 Antenna Requirements

The EUT uses a dish antenna structure. The maximum gain of the antenna 26 dBi. This is an 802.11 device and utilizes CDD as described in KDB 662911 D01. The antenna is not user replaceable. The EUT has a 2x2 transmitter and the chains are cross polarized.

Results

The EUT complied with the specification

5.2 Conducted Emissions at Mains Ports Data

5.2.1 Line

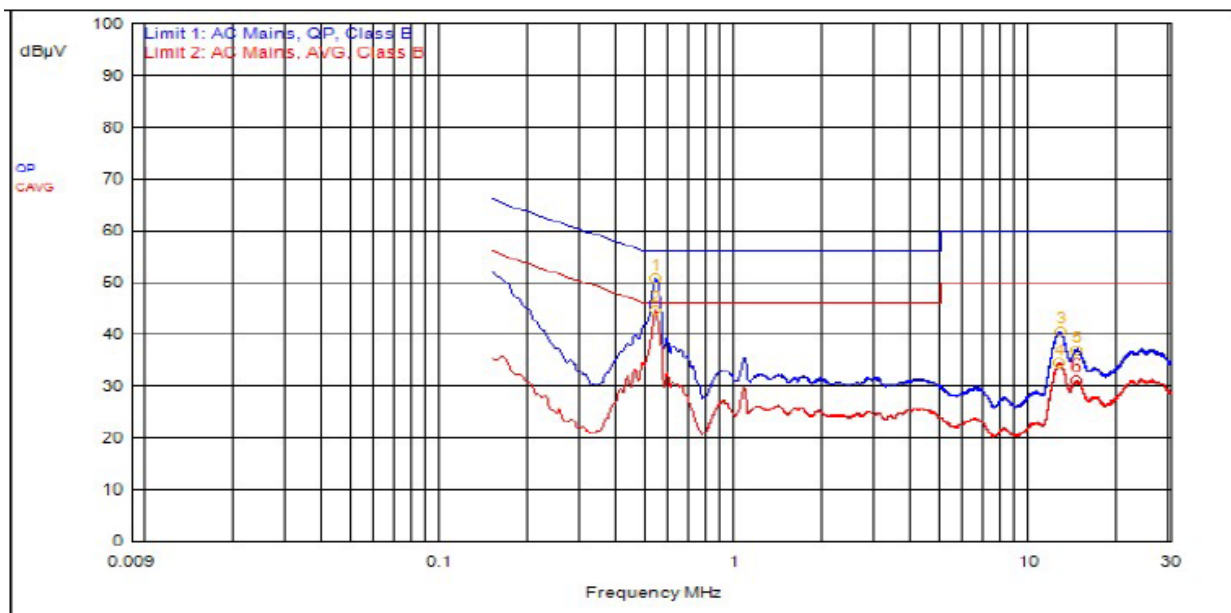

ID	Frequency	Probe	Cable	Atten.	Detector	Meter Read	Meas Level	Limit 1	Limit 1 Dist.	Limit 2	Limit 2 Dist.
1	534,000kHz	12.4	0.0		QPeak	38.4	50.8	56.0	-5.2		
3	12.558MHz	12.4	0.2		QPeak	27.9	40.5	60.0	-19.5		
5	14.262MHz	12.5	0.2		QPeak	24.2	36.9	60.0	-23.1		
2	534,000kHz	12.4	0.0		C_AVG	32.2	44.6			46.0	-1.4
4	12.501MHz	12.4	0.2		C_AVG	21.8	34.4			50.0	-15.6
6	14.265MHz	12.5	0.2		C_AVG	18.4	31.0			50.0	-19.0

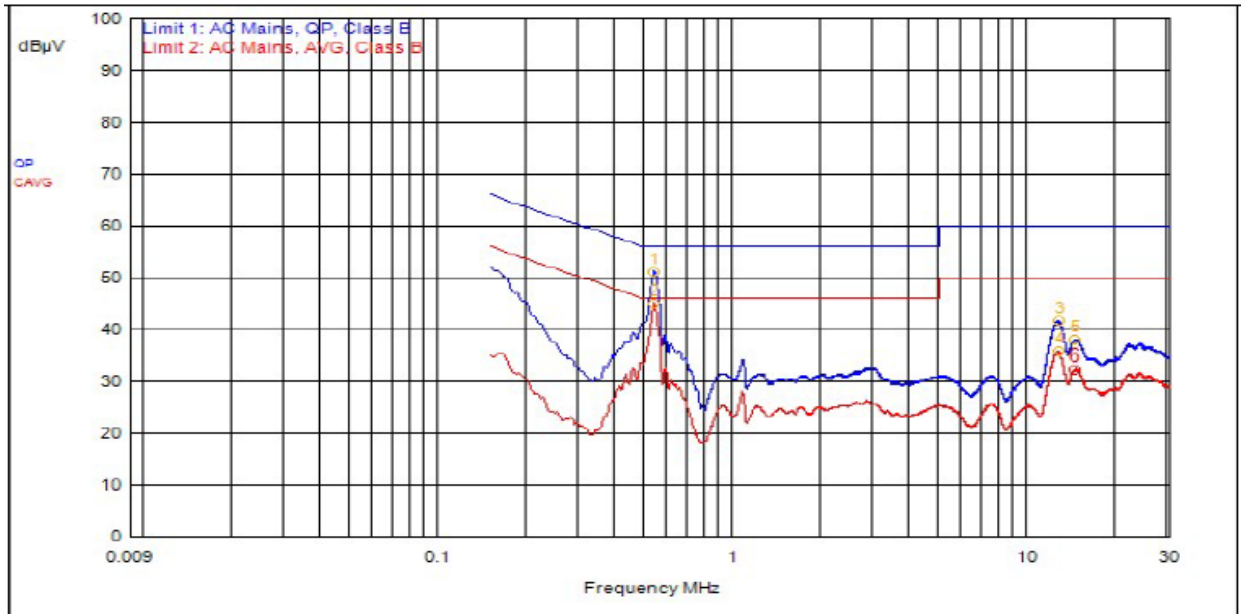

ID	Frequency	Probe	Cable	Atten.	Detector	Meter Read	Meas Level	Limit 1	Limit 1 Dist.	Limit 2	Limit 2 Dist.
1	534,000kHz	12.4	0.0		QPeak	38.8	51.2	56.0	-4.8		
3	12.558MHz	12.4	0.2		QPeak	29.0	41.6	60.0	-18.4		
5	14.334MHz	12.5	0.2		QPeak	25.4	38.1	60.0	-21.9		
2	537,000kHz	12.4	0.0		C_AVG	32.7	45.1			46.0	-0.9
4	12.576MHz	12.4	0.2		C_AVG	23.2	35.8			50.0	-14.2
6	14.337MHz	12.5	0.2		C_AVG	19.6	32.2			50.0	-17.8

5.2.2 Neutral

Result

The EUT complied with the specification limit.

5.3 §15.403(i) 26 dB Emissions Bandwidth

All chains were measured under the guidance of KDB 789033 Section II.C. and KDB 66291 D01. Please see associated annex for details on instrument settings.

Nominal BW (MHz)	Frequency (MHz)	99% Bandwidth (MHz)	26 dB Bandwidth (MHz)
a 20	5745	16.6	21.5
a 20	5775	16.6	21.4
a 20	5825	16.6	20.8
n 20	5745	17.8	22.1
n 20	5775	17.8	22.1
n 20	5825	17.8	22.1
n 40	5755	37.0	41.7
n 40	5775	36.5	41.6
n 40	5795	36.5	42.8
ac 20	5745	17.8	22.0
ac 20	5775	17.7	21.6
ac 20	5825	17.8	21.9
ac 40	5755	36.5	40.8
ac 40	5775	36.8	41.6
ac 40	5795	36.5	41.4
ac 80	5775	76.0	83.5

Result

All chains were tested and the highest bandwidth per chain is reported above.

The 26 dB bandwidths are reported for information purposes. Please see Annex for bandwidth measurements.

5.4 §15.403(a)(3) Maximum Average Output Power

All chains were measured and summed under the guidance of KDB 789033 Section II. E.2. and KDB 66291 D01. Please see associated annex for details on instrument settings.

The maximum average RF conducted output power measured for this device was 20.38 dBm or 109.14 mW. The limit is 30 dBm, or 1 Watt when using antennas with 6 dBi or less gain (or greater in the case of a fixed, point-to-point device). The antenna has a gain of 26 dBi.

Modulation (BW)	Frequency (MHz)	Data Rate	TP Setting	Conducted Output Power *	Measured EIRP
OFDM 20	5745	Mcs0	56	20.03	46.03
OFDM 20	5775	Mcs0	54	18.66	44.66
OFDM 20	5825	Mcs0	52	17.26	43.26
HT 20	5745	Mcs0	56	20.15	46.15
HT 20	5775	Mcs0	54	18.70	44.70
HT 20	5825	Mcs0	52	17.24	43.24
HT 40	5755	Mcs0	58	20.36	46.36
HT 40	5775	Mcs0	57	19.78	45.78
HT 40	5795	Mcs0	56	19.23	45.23
VHT 20	5745	Mcs0	56	20.06	46.06
VHT 20	5775	Mcs0	54	18.71	44.71
VHT 20	5825	Mcs0	52	17.24	43.24
VHT 40	5755	Mcs0	58	20.38	46.38
VHT 40	5775	Mcs0	57	19.77	45.77
VHT 40	5795	Mcs0	56	19.22	45.22
VHT 80	5775	Mcs0	55	18.46	44.46

Result

In the configuration tested, the maximum summed average RF output power was less than 1 watt; therefore, the EUT complied with the requirements of the specification (see spectrum analyzer plots in attached Annex).

* Gated EIRP shown in the Annex is the conducted measurement

5.5 §15.407(b)(7) Spurious Emissions

5.5.1 Conducted Spurious Emissions

The frequency ranges from the lowest frequency generated or used in the device to the tenth harmonic of the highest fundamental frequency was investigated to measure any antenna-conducted emissions. The graphs show the measurement data from spurious emissions noted across the frequency range when transmitting at the lowest frequency, middle frequency and upper frequency. Shown within the annex are plots with the EUT turned to the upper and lower channels with the antenna gain of 26 dBi accounted for. These demonstrate compliance with the provisions of this section at the band edges.

All emissions shall be limited to a level of -27 dBm/MHz at 75 MHz or more above or below the band edge increasing linearly to 10 dBm/MHz at 25 MHz above or below the band edge, and from 25 MHz above or below the band edge increasing linearly to a level of 15.6 dBm/MHz at 5 MHz above or below the band edge, and from 5 MHz above or below the band edge increasing linearly to a level of 27 dBm/MHz at the band edge.

Result

Conducted spurious emissions were attenuated below the limit; therefore, the EUT complies with the specification.

5.5.2 Radiated Spurious Emissions in the Restricted Bands of § 15.205

The EUT uses various power settings based on the channel in use. In order to reduce test time, the radiated spurious emissions at the lowest, middle, and highest channel were measured at the maximum power.

Correction Factor = Antenna Factor + Cable Loss - Pre-Amplifier Gain, and is added to the Receiver reading.

Result

All emissions in the restricted bands of § 15.205 met the limits specified in § 15.209; therefore, the EUT complies with the specification. See Annex for Conducted Band edge plots.

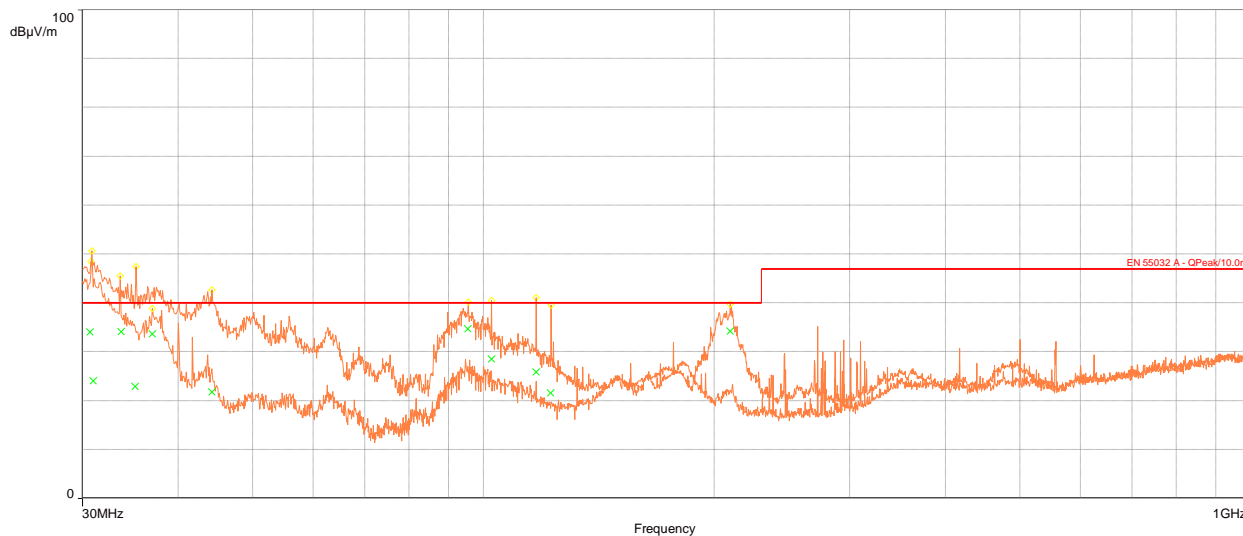

QuasiPeak (11)

Frequency (MHz)	Level (dBµV/m)	Limit (dBµV/m)	Margin (dB)	Azimuth (°)	Height	Pol.	Correction (dB)
30.682	34.08	40.00	-5.92	281.00	1.00	Vertical	-11.88
35.17	22.89	40.00	-17.11	154.00	1.14	Vertical	-11.60
44.253	21.78	40.00	-18.22	264.00	1.33	Vertical	-11.28
95.4	34.73	40.00	-5.27	174.00	1.86	Vertical	-13.88
102.46	28.53	40.00	-11.47	160.00	1.37	Vertical	-13.34
117.14	25.83	40.00	-14.17	269.00	1.15	Vertical	-15.47
122.25	21.54	40.00	-18.46	167.00	1.14	Vertical	-16.15
209.6	34.22	40.00	-5.78	221.00	1.14	Vertical	-14.79
30.938	24.05	40.00	-15.95	74.00	3.13	Horizontal	-11.81
33.65	34.17	40.00	-5.83	310.00	2.42	Horizontal	-11.81
36.999	33.62	40.00	-6.38	292.00	2.41	Horizontal	-11.74

Table 4: Radiated Emissions 30 – 1000 MHz

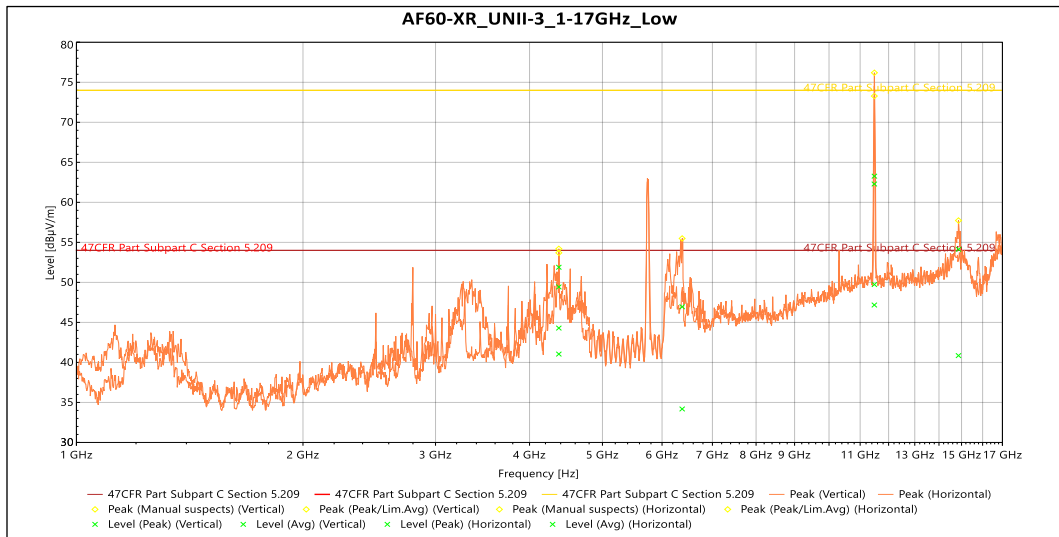

Peak

Frequency	Level (dBµV/m)	Limit (dBµV/m)	Margin (dB)	Azimuth (°)	Height (m)	Pol.	Correction (dB)
4.3751 GHz	51.888	74	-22.112	80	3.793	Vertical	-9.856
6.3809 GHz	46.947	74	-27.053	126	2.816	Vertical	-6.303
11.488 GHz	62.293	74	-11.707	110	2.32	Vertical	6.074
4.3752 GHz	49.433	74	-24.567	84	1.643	Horizontal	-9.855
11.49 GHz	63.274	74	-10.726	101	1.643	Horizontal	6.014
14.861 GHz	54.126	74	-19.874	95	2.15	Horizontal	8.291

Avg

Frequency	Level (dBµV/m)	Limit (dBµV/m)	Margin (dB)	Azimuth (°)	Height (m)	Pol.	Correction (dB)
4.3751 GHz	44.287	54	-9.713	80	3.793	Vertical	-9.856
6.3809 GHz	34.182	54	-19.818	126	2.816	Vertical	-6.303
11.488 GHz	47.172	54	-6.828	110	2.32	Vertical	6.074
4.3752 GHz	41.044	54	-12.956	84	1.643	Horizontal	-9.855
11.49 GHz	49.726	54	-4.274	101	1.643	Horizontal	6.014
14.861 GHz	40.847	54	-13.153	95	2.15	Horizontal	8.291

Table 5: Transmitting on the Lowest Frequency 5745 MHz 1 – 17 GHz

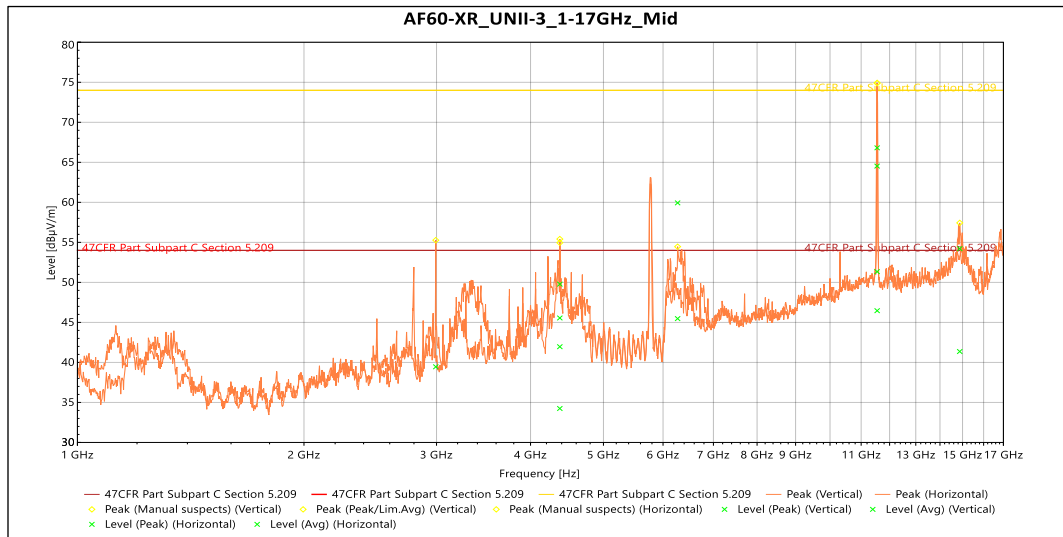

Peak

Frequency	Level (dBµV/m)	Limit (dBµV/m)	Margin (dB)	Azimuth (°)	Height (m)	Pol.	Correction (dB)
4.3751 GHz	45.546	74	-28.454	81	1.829	Vertical	-9.856
6.2737 GHz	59.935	74	-14.065	96	1.643	Vertical	-6.667
11.552 GHz	66.805	74	-7.195	98	1.643	Vertical	5.863
2.9936 GHz	39.453	74	-34.547	159	2.321	Horizontal	-12.939
4.3752 GHz	49.777	74	-24.223	105	3.662	Horizontal	-9.855
11.55 GHz	64.527	74	-9.473	120	1.5	Horizontal	5.86
14.872 GHz	54.211	74	-19.789	132	4	Horizontal	8.906

Avg

Frequency	Level (dBµV/m)	Limit (dBµV/m) (dBµV/m)	Margin (dB)	Azimuth (°)	Height (m)	Pol.	Correction (dB)
4.3751 GHz	34.242	54	-19.758	81	1.829	Vertical	-9.856
6.2737 GHz	45.47	54	-8.53	96	1.643	Vertical	-6.667
11.552 GHz	46.455	54	-7.545	98	1.643	Vertical	5.863
2.9936 GHz	26.435	54	-27.565	159	2.321	Horizontal	-12.939
4.3752 GHz	41.96	54	-12.04	105	3.662	Horizontal	-9.855
11.55 GHz	51.339	54	-2.661	120	1.5	Horizontal	5.86
14.872 GHz	41.363	54	-12.637	132	4	Horizontal	8.906

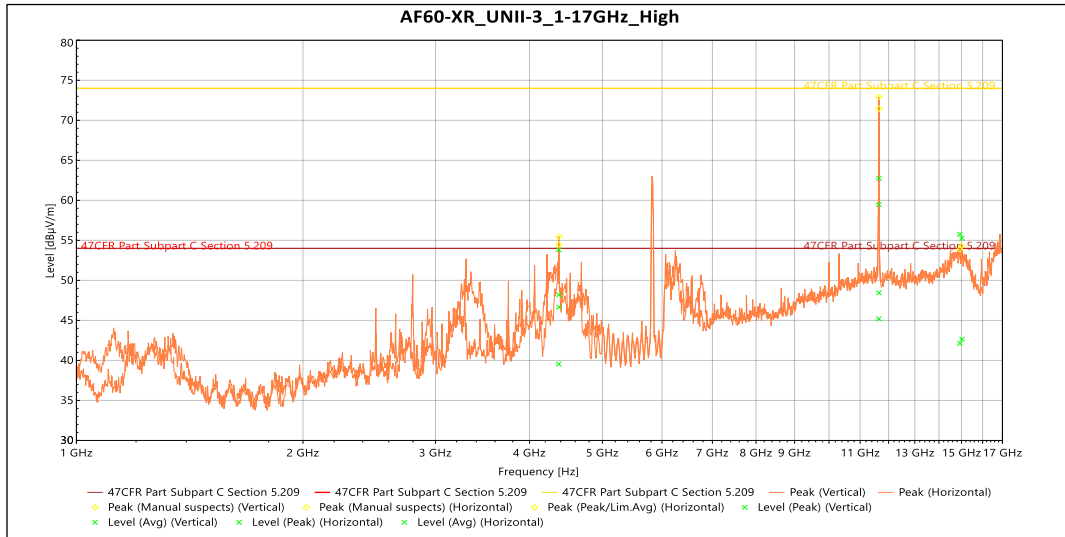
Table 6: Transmitting on the Middle Frequency 5775 MHz 1 – 17 GHz



Peak

Frequency	Level (dBµV/m)	Limit (dBµV/m)	Margin (dB)	Azimuth (°)	Height (m)	Pol.	Correction (dB)
4.3749 GHz	48.175	74	-25.825	83	1.829	Vertical	-9.856
11.652 GHz	62.726	74	-11.274	104	1.5	Vertical	5.506
14.921 GHz	55.779	74	-18.221	222	3.153	Vertical	9.765
4.375 GHz	53.807	74	-20.193	87	3.662	Horizontal	-9.856
11.646 GHz	59.469	74	-14.531	121	1.829	Horizontal	5.331
15.02 GHz	55.274	74	-18.726	357	3.798	Horizontal	10.193

Avg

Frequency	Level (dBµV/m)	Limit (dBµV/m)	Margin (dB)	Azimuth (°)	Height (m)	Pol.	Correction (dB)
4.3749 GHz	39.532	54	-14.468	83	1.829	Vertical	-9.856
11.652 GHz	48.441	54	-5.559	104	1.5	Vertical	5.506
14.921 GHz	42.113	54	-11.887	222	3.153	Vertical	9.765
4.375 GHz	46.647	54	-7.353	87	3.662	Horizontal	-9.856
11.646 GHz	45.195	54	-8.805	121	1.829	Horizontal	5.331
15.02 GHz	42.651	54	-11.349	357	3.798	Horizontal	10.193

Table 7: Transmitting on the Highest Frequency 5825 MHz 1 – 17 GHz

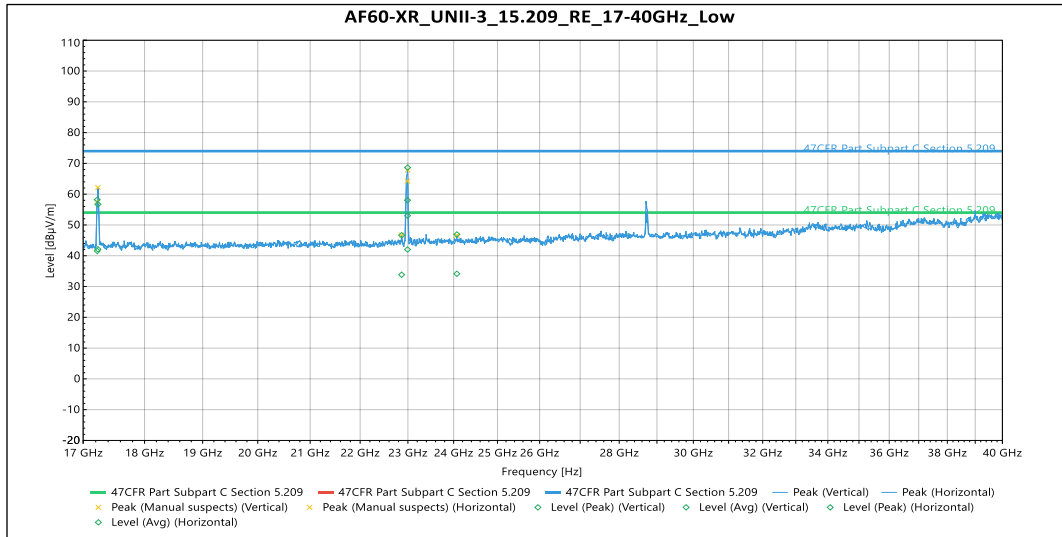

Peak

Frequency	Level (dBµV/m)	Limit (dBµV/m)	Margin (dB)	Azimuth (°)	Pol.	Correction (dB)
17.236 GHz	56.689	74	-17.311	87	Vertical	-5.612
22.992 GHz	58.039	74	-15.961	92	Vertical	-4.572
24.072 GHz	46.92	74	-27.08	309	Vertical	-5.148
17.225 GHz	58.2	74	-15.8	90	Horizontal	-5.628
22.866 GHz	46.675	74	-27.325	313	Horizontal	-5.105
22.993 GHz	68.649	74	-5.351	81	Horizontal	-4.579

Avg

Frequency	Level (dBµV/m)	Limit (dBµV/m)	Margin (dB)	Azimuth (°)	Pol.	Correction (dB)
17.236 GHz	42.105	54	-11.895	87	Vertical	-5.612
22.992 GHz	42.021	54	-11.979	92	Vertical	-4.572
24.072 GHz	34.143	54	-19.857	309	Vertical	-5.148
17.225 GHz	41.557	54	-12.443	90	Horizontal	-5.628
22.866 GHz	33.833	54	-20.167	313	Horizontal	-5.105
22.993 GHz	53.024	54	-0.976	81	Horizontal	-4.579

Table 8: Transmitting on the Lowest Frequency 5745 MHz 17 – 40 GHz (Worse Case)

5.6 §15.407(a) Maximum Power Spectral Density

All chains were measured and summed under the guidance of KDB 789033 Section II. F. and KDB 66291 D01. Please see associated annex for details on instrument settings.

The maximum average power spectral density conducted from the intentional radiator of the antenna shall not be greater than 1w (30 dBm) in any 500 kHz band during any time interval of continuous transmission.

If transmitting antennas of directional gain greater than 6 dBi are used, both the maximum conducted output power and PSD shall be reduced by the amount in dB that the directional gain exceeds 6 dBi. However, since this device is a fixed point-to-point device, no corresponding reduction in transmitter conducted power was considered.

The EUT has a 2x2 transmitter and the chains are cross polarized.

Results of this testing are summarized.

Modulation (BW)	Frequency (MHz)	Data Rate	TP Setting	Measured PSD
OFDM 20	5745	Mcs0	56	2.27
OFDM 20	5775	Mcs0	54	0.72
OFDM 20	5825	Mcs0	52	-0.63
HT 20	5745	Mcs0	56	2.07
HT 20	5775	Mcs0	54	0.65
HT 20	5825	Mcs0	52	-0.78
HT 40	5755	Mcs0	58	-0.02
HT 40	5775	Mcs0	57	-1.26
HT 40	5795	Mcs0	56	-1.73
VHT 20	5745	Mcs0	56	1.98
VHT 20	5775	Mcs0	54	0.66
VHT 20	5825	Mcs0	52	-0.78
VHT 40	5755	Mcs0	58	-0.21
VHT 40	5775	Mcs0	57	-1.11
VHT 40	5795	Mcs0	56	-1.65
VHT 80	5775	Mcs0	55	-4.47

Result

The maximum summed average power spectral density limit is 30 dBm, therefore, the EUT complies with the specification.

-- End of Test Report --