

FCC Test Report

Report No.: RFBFPJ-WTW-P20120001A

FCC ID: SWX-AF60HD

Test Model: AF60-HD

Received Date: 2021/7/20

Test Date: 2021/9/29

Issued Date: 2021/10/18

Applicant: Ubiquiti Inc.

Address: 685 Third Avenue, New York, New York 10017 USA

Issued By: Bureau Veritas Consumer Products Services (H.K.) Ltd., Taoyuan Branch
Hsin Chu Laboratory

Lab Address: E-2, No.1, Li Hsin 1st Road, Hsinchu Science Park, Hsinchu City 300,
Taiwan

Test Location (1): E-2, No.1, Li Hsin 1st Road, Hsinchu Science Park, Hsinchu City 300,
Taiwan

Test Location (2): No. 49, Ln. 206, Wende Rd., Shangshan Tsuen, Chiung Lin Hsiang, Hsin
Chu Hsien 307, Taiwan

**FCC Registration /
Designation Number:** 723255 / TW2022 for Test Location (1)
736135 / TW0004 for Test Location (2)



This report is for your exclusive use. Any copying or replication of this report to or for any other person or entity, or use of our name or trademark, is permitted only with our prior written permission. This report sets forth our findings solely with respect to the test samples identified herein. The results set forth in this report are not indicative or representative of the quality or characteristics of the lot from which a test sample was taken or any similar or identical product specifically and expressly noted. Our report includes all of the tests requested by you and the results thereof based upon the information that you provided to us. You have 60 days from date of issuance of this report to notify us of any material error or omission caused by our negligence, provided, however, that such notice shall be in writing and shall specifically address the issue you wish to raise. A failure to raise such issue within the prescribed time shall constitute your unqualified acceptance of the completeness of this report, the tests conducted and the correctness of the report contents. Unless specific mention, the uncertainty of measurement has been explicitly taken into account to declare the compliance or non-compliance to the specification.

Table of Contents

Release Control Record	3
1 Certificate of Conformity	4
2 Summary of Test Results	5
2.1 Measurement Uncertainty.....	5
2.2 Modification Record.....	5
3 General Information	6
3.1 General Description of EUT.....	6
3.2 Description of Test Modes.....	7
3.2.1 Test Mode Applicability and Tested Channel Detail.....	8
3.3 Description of Support Units.....	10
3.3.1 Configuration of System under Test.....	11
3.4 General Description of Applied Standards.....	12
4 Test Types and Results	13
4.1 Radiated Emission Measurement.....	13
4.1.1 Limits of Radiated Emission Measurement.....	13
4.1.2 Test Instruments.....	14
4.1.3 Test Procedures.....	16
4.1.4 Deviation from Test Standard.....	17
4.1.5 Test Setup.....	18
4.1.6 EUT Operating Conditions.....	19
4.1.7 Test Results.....	20
4.2 6dB Bandwidth Measurement.....	44
4.2.1 Limits of 6dB Bandwidth Measurement.....	44
4.2.2 Test Setup.....	44
4.2.3 Test Instruments.....	44
4.2.4 Test Procedure.....	45
4.2.5 Deviation from Test Standard.....	45
4.2.6 EUT Operating Conditions.....	45
4.2.7 Test Result.....	46
4.3 Output Power Measurement.....	47
4.3.1 Limits of Output Power Measurement.....	47
4.3.2 Test Setup.....	48
4.3.3 Test Instruments.....	48
4.3.4 Test Procedures.....	49
4.3.5 Deviation from Test Standard.....	49
4.3.6 EUT Operating Conditions.....	49
4.3.7 Test Results.....	50
5 Pictures of Test Arrangements	51
Appendix – Information of the Testing Laboratories	52

Release Control Record

Issue No.	Description	Date Issued
RFBFPJ-WTW-P20120001A	Original release.	2021/10/18

1 Certificate of Conformity

Product: airFiber 60 HD
Brand: UBIQUITI
Test Model: AF60-HD
Sample Status: Engineering sample
Applicant: Ubiquiti Inc.
Test Date: 2021/9/29
Standards: 47 CFR FCC Part 15, Subpart C (Section 15.255)
ANSI C63.10: 2013

The above equipment has been tested by **Bureau Veritas Consumer Products Services (H.K.) Ltd., Taoyuan Branch**, and found compliance with the requirement of the above standards. The test record, data evaluation & Equipment Under Test (EUT) configurations represented herein are true and accurate accounts of the measurements of the sample's EMC characteristics under the conditions specified in this report.

Prepared by : Phoenix Huang , **Date:** 2021/10/18
Phoenix Huang / Specialist

Approved by : Clark Lin , **Date:** 2021/10/18
Clark Lin / Technical Manager

2 Summary of Test Results

47 CFR FCC Part 15, Subpart C (Section 15.255)			
FCC Clause	Test Item	Result	Remarks
15.207	AC Power Conducted Emission	NA	Refer to Note 1 below
15.255(e)	6dB Bandwidth	-	Reference only.
15.255 (c) & (e)	Output Power	Pass	Meet the requirement of limit.
15.255(d)	Spurious Emissions	Pass	Meet the requirement of limit. Minimum passing margin is -3.7 dB at 17977.08 MHz.
15.255(f)	Frequency Stability	NA	Refer to Note 1 below

Note:

1. Only 6dB Bandwidth & Output Power & Spurious Emissions were performed for this addendum. The others testing data refer to original test report.
2. Determining compliance based on the results of the compliance measurement, not taking into account measurement instrumentation uncertainty.

2.1 Measurement Uncertainty

Where relevant, the following measurement uncertainty levels have been estimated for tests performed on the EUT as specified in CISPR 16-4-2:

Measurement	Frequency	Expanded Uncertainty (k=2) (\pm)
Radiated Emissions up to 1 GHz	9kHz ~ 30MHz	3.1 dB
	30MHz ~ 1GHz	5.4 dB
Radiated Emissions above 1 GHz	1GHz ~ 18GHz	5.0 dB
	18GHz ~ 40GHz	5.3 dB
	40GHz ~ 200GHz	5.4 dB

2.2 Modification Record

There were no modifications required for compliance.

3 General Information

3.1 General Description of EUT

Product	airFiber 60 HD
Brand	UBIQUITI
Test Model	AF60-HD
Status of EUT	Engineering sample
Power Supply Method	48 Vdc from PoE
Modulation Type	$\pi/2$ -BPSK, $\pi/2$ -QPSK, $\pi/2$ -16QAM
Modulation Technology	OFDM
Transfer Rate	4620 Mbps
Operating Frequency	57 ~ 71 GHz
Output Power (EIRP)	59.4 GHz: 50.34 dBm 61.56 GHz: 51.83 dBm 63.72 GHz: 50.12 dBm
Antenna Type	Refer to Note
Antenna Connector	Refer to Note
Accessory Device	PoE Adapter x 1
Data Cable Supplied	NA

Note:

- This report is prepared for FCC Class II permissive change. The difference compared with the Report No.: RFBFPJ-WTW-P20120001 design is as the following information:
 - ◆ Added 4320MHz bandwidth operation channel by software.
- According to above conditions, only 6dB Bandwidth & Output Power & Spurious Emissions, needs to be performed. And all data are verified to meet the requirements.
- The EUT has below radios as following table:

Radio 1	Radio 2	Radio 3
BT LE	WiGig (60GHz)	GPS

- Simultaneously transmission condition.

Condition	Technology	
1	BT LE	WiGig (60GHz)

Note: The emission of the simultaneous operation has been evaluated and no non-compliance was found.

- The EUT must be supplied with a PoE adapter as following table:

Brand	Model No.	Spec.
UBIQUITI	GP-H480-065G	AC Input: 100-240 Vac, 0.75A MAX, 50/60 Hz DC Output: 48 Vdc, 0.65 A AC Input Cable: Unshielded, 0.6 m

- The antennas type and connector type, please refer to the following table:

Antenna No.	Antenna Net Gain (dBi)	Frequency Range	Antenna Type	Connector Type
WiGig (60GHz)	35	57-71GHz	Dish	None
BT	3	2.4~2.4835GHz	internal	None

- The above EUT information is declared by manufacturer and for more detailed features description, please refer to the manufacturer's specifications or user's manual.
- The above Antenna information is declared by manufacturer and for more detailed features description, please refer to the manufacturer's specifications, the laboratory shall not be held responsible.

3.2 Description of Test Modes

3 channels are provided for EUT.

Channel's Number	9	10	11
Frequency (GHz)	59.4	61.56	63.72

3.2.1 Test Mode Applicability and Tested Channel Detail

EUT CONFIGURE MODE	APPLICABLE TO				DESCRIPTION
	BW	OP	RE < 1G	RE ≥ 1G	
-	√	√	√	√	-

Where **BW**: 6dB Bandwidth **OP**: Output Power
RE < 1G: Radiated Emission below 1GHz **RE ≥ 1G**: Radiated Emission above 1GHz

6dB Bandwidth Test:

- Pre-Scan has been conducted to determine the worst-case mode from all possible combinations between available modulations, data rates and antenna ports (if EUT with antenna diversity architecture).
- Following channel(s) was (were) selected for the final test as listed below.

AVAILABLE CHANNEL	TESTED CHANNEL	MODULATION TECHNOLOGY	MODULATION TYPE	DATA RATE (Mbps)
9 to 11	9, 10, 11	OFDM	$\pi/2$ -BPSK	385

Output Power Measurement:

- Pre-Scan has been conducted to determine the worst-case mode from all possible combinations between available modulations, data rates and antenna ports (if EUT with antenna diversity architecture).
- Following channel(s) was (were) selected for the final test as listed below.

AVAILABLE CHANNEL	TESTED CHANNEL	MODULATION TECHNOLOGY	MODULATION TYPE	DATA RATE (Mbps)
9 to 11	9, 10, 11	OFDM	$\pi/2$ -BPSK	385

Radiated Emission Test (Below 1GHz):

- Pre-Scan has been conducted to determine the worst-case mode from all possible combinations between available modulations, data rates and antenna ports (if EUT with antenna diversity architecture).
- Following channel(s) was (were) selected for the final test as listed below.

AVAILABLE CHANNEL	TESTED CHANNEL	MODULATION TECHNOLOGY	MODULATION TYPE	DATA RATE (Mbps)
9 to 11	9, 10, 11	OFDM	$\pi/2$ -BPSK	385

Radiated Emission Test (Above 1GHz):

- Pre-Scan has been conducted to determine the worst-case mode from all possible combinations between available modulations, data rates and antenna ports (if EUT with antenna diversity architecture).
- Following channel(s) was (were) selected for the final test as listed below.

AVAILABLE CHANNEL	TESTED CHANNEL	MODULATION TECHNOLOGY	MODULATION TYPE	DATA RATE (Mbps)
9 to 11	9, 10, 11	OFDM	$\pi/2$ -BPSK	385

Test Condition:

APPLICABLE TO	ENVIRONMENTAL CONDITIONS	INPUT POWER	TESTED BY
BW	23 deg. C, 62 %RH	120Vac, 60Hz	Spencer Liao
OP	25 deg. C, 66 %RH	120Vac, 60Hz	Spencer Liao
RE<1G	25 deg. C, 75 %RH	120Vac, 60Hz	Carter Lin
RE≥1G	25 deg. C, 66~75 %RH	120Vac, 60Hz	Carter Lin, Spencer Liao

3.3 Description of Support Units

The EUT has been tested as an independent unit together with other necessary accessories or support units. The following support units or accessories were used to form a representative test configuration during the tests.

ID	Product	Brand	Model No.	Serial No.	FCC ID	Remarks
A.	Laptop	DELL	E5430	HYV4VY1	FCC DoC	Provided by Lab

Note:

1. All power cords of the above support units are non-shielded (1.8m).

ID	Descriptions	Qty.	Length (m)	Shielding (Yes/No)	Cores (Qty.)	Remarks
1.	RJ-45 Cable	1	3	No	0	Provided by Lab
2.	RJ-45 Cable	1	10	No	0	Provided by Lab
3.	AC Cable	1	0.6	No	0	Supplied by client
4.	Fiber Cable	1	10	Yes	0	Provided by Lab

3.3.1 Configuration of System under Test

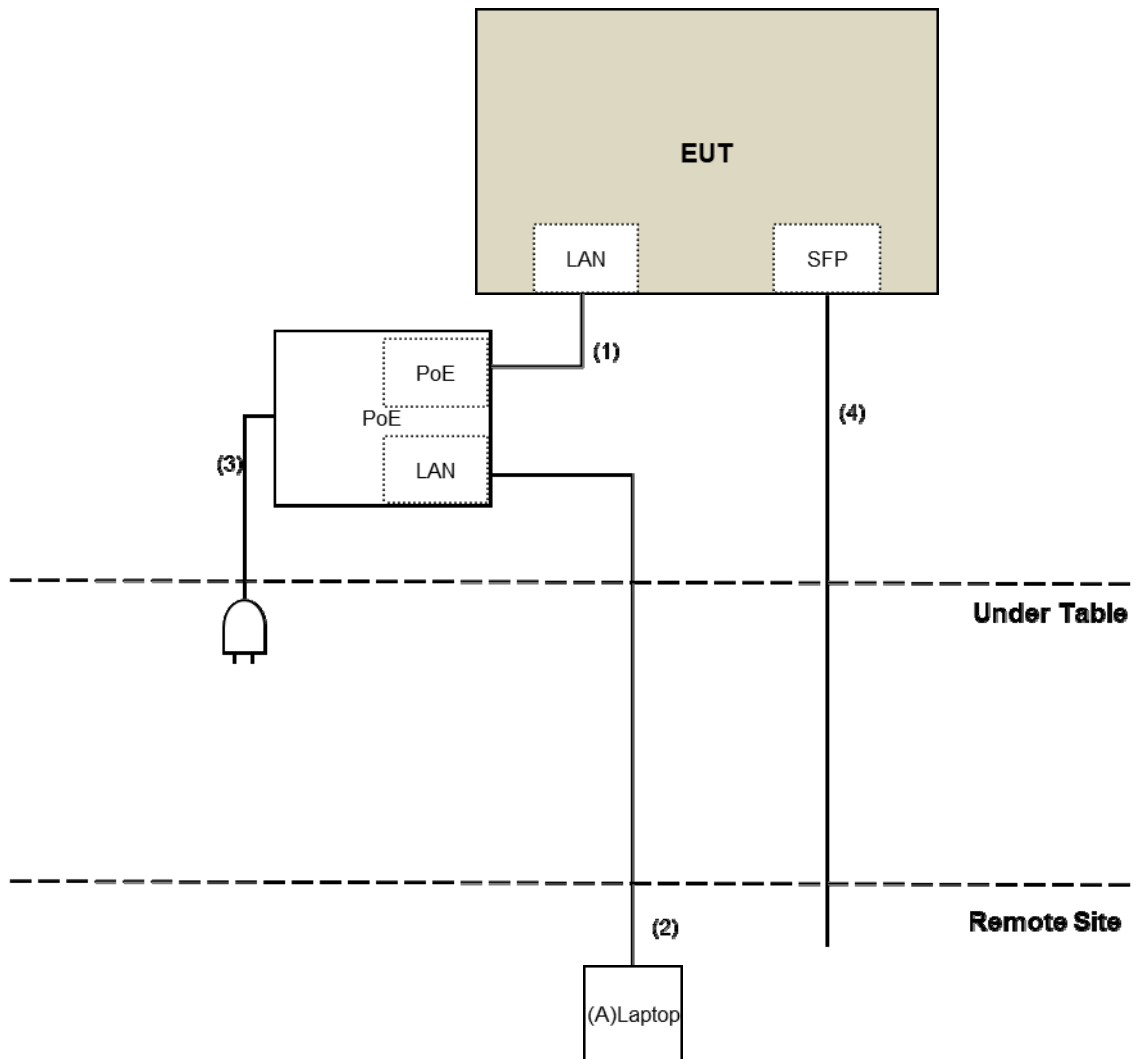

3.4 General Description of Applied Standards

The EUT is a RF Product. According to the specifications of the manufacturer, it must comply with the requirements of the following standards:

FCC Part 15, Subpart C (15.255)

ANSI C63.10-2013

All test items have been performed and recorded as per the above standards.

4 Test Types and Results

4.1 Radiated Emission Measurement

4.1.1 Limits of Radiated Emission Measurement

Spurious Emission	
Frequency Range	Limitation
Radiated emissions below 40GHz	Part 15.209
Between 40GHz and 200GHz	90pW/cm ² (at 3 meter)

Note: The levels of the spurious emissions shall not exceed the level of the fundamental emission

Emissions radiated outside of the specified bands, shall be according to the general radiated limits in 15.209 as following:

Frequencies (MHz)	Field strength (microvolts/meter)	Measurement distance (meters)
0.009-0.490	2400/F(kHz)	300
0.490-1.705	24000/F(kHz)	30
1.705-30.0	30	30
30-88	100	3
88-216	150	3
216-960	200	3
Above 960	500	3

Note:

1. The lower limit shall apply at the transition frequencies.
2. Emission level (dBuV/m) = 20 log Emission level (uV/m).
3. As shown in 15.35(b), for frequencies above 1000MHz, the field strength limits are based on average detector, however, the peak field strength of any emission shall not exceed the maximum permitted average limits, specified above by more than 20dB under any condition of modulation.
4. Section 15.205 restricted bands of operation shall compliance with the limits in Section 15.209.

4.1.2 Test Instruments

For Below 40GHz:

Description & Manufacturer	Model No.	Serial No.	Calibrated Date	Calibrated Until
Test Receiver Agilent	N9038A	MY50010156	2021/7/22	2022/7/21
Software	ADT_Radiated_V8.7.08	NA	NA	NA
Antenna Tower & Turn Table Max-Full	MF-7802	MF780208406	NA	NA
Pre_Amplifier EMCI	EMC001340	980142	2021/5/24	2022/5/23
LOOP ANTENNA Electro-Metrics	EM-6879	264	2021/3/5	2022/3/4
RF Coaxial Cable JYEBO	5D-FB	LOOPCAB-001	2021/1/7	2022/1/6
RF Coaxial Cable JYEBO	5D-FB	LOOPCAB-002	2021/1/7	2022/1/6
Pre_Amplifier Mini-Circuits	ZFL-1000VH2	QA0838008	2020/10/20	2021/10/19
Trilog Broadband Antenna SCHWARZBECK	VULB 9168	9168-361	2020/11/5	2021/11/4
RF Coaxial Cable COMMATE/PEWC	8D	966-3-1	2021/3/16	2022/3/15
RF Coaxial Cable COMMATE/PEWC	8D	966-3-2	2021/3/16	2022/3/15
RF Coaxial Cable COMMATE/PEWC	8D	966-3-3	2021/3/16	2022/3/15
Fixed attenuator Mini-Circuits	UNAT-5+	PAD-3m-3-01	2021/9/23	2022/9/22
Horn Antenna Schwarzbeck	BBHA9120-D	9120D-406	2020/11/22	2021/11/21
Pre_Amplifier EMCI	EMC12630SE	980384	2021/1/11	2022/1/10
RF Coaxial Cable EMCI	EMC104-SM-SM-1500	180504	2021/4/26	2022/4/25
RF Coaxial Cable EMCI	EMC104-SM-SM-2000	180601	2021/6/8	2022/6/7
RF Coaxial Cable EMCI	EMC104-SM-SM-6000	210201	2021/5/13	2022/5/12
Fix tool for Boresight antenna tower LIOW GUU	FBA-01	FBA_SIP01	NA	NA
Spectrum Analyzer Keysight	N9030A	MY54490679	2021/7/9	2022/7/8
Pre_Amplifier EMCI	EMC184045SE	980387	2021/1/11	2022/1/10
Horn Antenna Schwarzbeck	BBHA 9170	BBHA9170519	2020/11/22	2021/11/21
RF Cable-Frequency range: 1-40GHz EMCI	EMC102-KM-KM-1200	160924	2021/1/11	2022/1/10
RF cable (40GHz) EMCI	EMC-KM-KM-4000	200214	2021/3/10	2022/3/9

- Note: 1. The test was performed in 966 Chamber No. 3.
 2. The calibrations are traceable to NML/ROC and NIST/USA.
 3. Tested Date: 2021/9/29

For Above 40GHz:

Description & Manufacturer	Model No.	Serial No.	Calibrated Date	Calibrated Until
Spectrum Analyzer Keysight	N9030A	MY55330160	2021/2/5	2022/2/4
Zero-Bias Detector Vdi	WR15ZBD	WR15R5 1-30	CoC	CoC
4CH Infiniivision Oscilloscope Keysight	DSOX6004A	MY55190202	2021/6/28	2022/6/27
OXE89 Horn Antenna QuinStar	QWH-UCRR00	924200002	2020/1/20	2022/1/19
50G~75G Conical Horn Antenna Keysight	WR15CH-Conical Horn Antenna	WR15CH_001	2020/1/20	2022/1/19
75G~110G Conical Horn Antenna Keysight	WR10CH-Conical Horn Antenna	WR10CH_001	2020/1/20	2022/1/19
110G~170G Conical Horn Antenna Keysight	WR6.5CH-Conical Horn Antenna	WR6.5CH_001	2020/1/20	2022/1/19
140G~220G Conical Horn Antenna Keysight	WR5.1CH-Conical Horn Antenna	WR5.1CH_001	2019/12/9	2021/12/8
N9029AV15-DC9 - 50-75 GHz VDI Standard Downconverter with 9VDC supply Keysight	SA Extension WR15	SAX 381	CoC	CoC
N9029AV10-DC9 - 75-110 GHz VDI Standard Downconverter with 9VDC supply Keysight	SA Extension WR10	SAX 378	CoC	CoC
N9029AV06-DC9 - 110-170 GHz VDI Standard Downconverter with 9VDC supply Keysight	SA Extension WR6.5	SAX 377	CoC	CoC
N9029AV05-DC9 - 140-220 GHz VDI Standard Downconverter with 9VDC supply Keysight	SA Extension WR5.1	SAX 375	2019/12/9	2021/12/8
Power Meter VDI	PM5	431V	2019/12/9	2021/12/8
Boresight Antenna Tower & Turn Table Max-Full	MF-7802BS	MF780208530	NA	NA
Antenna Tower & Turn Table CT	NA	NA	NA	NA

- Note: 1. The test was performed in 966 Chamber No. 6.
 2. The calibrations are traceable to NML/ROC and NIST/USA.
 3. Certificate of Conformance (CoC) which is issued by manufacturer states that the product meets the specification.
 4. Tested Date: 2021/9/29

4.1.3 Test Procedures

For Radiated emission below 30MHz

- a. The EUT was placed on the top of a rotating table 0.8 meters above the ground at a 3 meter chamber room. The table was rotated 360 degrees to determine the position of the highest radiation.
- b. The EUT was set 3 meters away from the interference-receiving antenna, which was mounted on the top of a variable-height antenna tower.
- c. Parallel, perpendicular, and ground-parallel orientations of the antenna are set to make the measurement.
- d. For each suspected emission, the EUT was arranged to its worst case and the rotatable table was turned from 0 degrees to 360 degrees to find the maximum reading.
- e. The test-receiver system was set to Quasi-Peak Detect Function and Specified Bandwidth with Maximum Hold Mode.

Note:

1. The resolution bandwidth and video bandwidth of test receiver/spectrum analyzer is 9kHz at frequency below 30MHz.

For Radiated emission 30MHz to 40GHz

- a. The EUT was placed on the top of a rotating table 0.8 meters (for 30MHz ~ 1GHz) / 1.5 meters (for above 1GHz) above the ground at 3 meter chamber room for test. The table was rotated 360 degrees to determine the position of the highest radiation.
- b. The EUT was set 3 meters away from the interference-receiving antenna, which was mounted on the top of a variable-height antenna tower.
- c. The height of antenna is varied from one meter to four meters above the ground to determine the maximum value of the field strength. Both horizontal and vertical polarizations of the antenna are set to make the measurement.
- d. For each suspected emission, the EUT was arranged to its worst case and then the antenna was tuned to heights from 1 meter to 4 meters and the rotatable table was turned from 0 degrees to 360 degrees to find the maximum reading.
- e. The test-receiver system was set to quasi-peak detect function and specified bandwidth with maximum hold mode when the test frequency is below 1 GHz.
- f. The test-receiver system was set to peak and average detects function and specified bandwidth with maximum hold mode when the test frequency is above 1 GHz. If the peak reading value also meets average limit, measurement with the average detector is unnecessary.

Note:

1. The resolution bandwidth and video bandwidth of test receiver/spectrum analyzer is 120kHz for Quasi-peak detection (QP) at frequency below 1GHz.
2. The resolution bandwidth of test receiver/spectrum analyzer is 1 MHz and the video bandwidth is 3 MHz for Peak detection (PK) and Average detection (AV) at frequency above 1GHz.
3. All modes of operation were investigated and the worst-case emissions are reported.

For Radiated emission above 40GHz

- a. Connect the test antenna covering the appropriate frequency range to a spectrum analyzer via an external mixer to the spectrum analyzer.
- b. Set spectrum analyzer RBW = 1 MHz, VBW = 3 MHz, average detector.
- c. Calculate the distance to the far field boundary and determine the maximum measurement distance.
- d. Perform an exploratory search for emissions and determine the approximate direction at which each observed emission emanates from the EUT.
- e. Exploratory measurements be made at a closer distance than the validated maximum measurement distance.
- f. Perform a final measurement; begin with the test antenna at the approximate position where the maximum level occurred during the exploratory scan.
- g. Slowly scan the test antenna around this position, slowly vary the test antenna polarization by rotating through at least 0° to 180°, and slowly vary the orientation of the test antenna to find the final position, polarization, and orientation at which the maximum level of the emission is observed.
- h. Record the measured reading with the test antenna fixed at this maximized position, polarization, and orientation. Record the measurement distance.
- i. Calculate the maximum field strength of the emission at the measurement distance and the adjusted/corrected power at the output of the test antenna.
- j. Calculate the EIRP from the measured field strength and then convert to the linear.
- k. Calculate the power density at the distance specified by the limit from the field strength at the distance specified by the limit.
- l. Repeat the preceding sequence for every emission observed in the frequency band under investigation.

4.1.4 Deviation from Test Standard

No deviation.

4.1.5 Test Setup

For Radiated emission below 30MHz

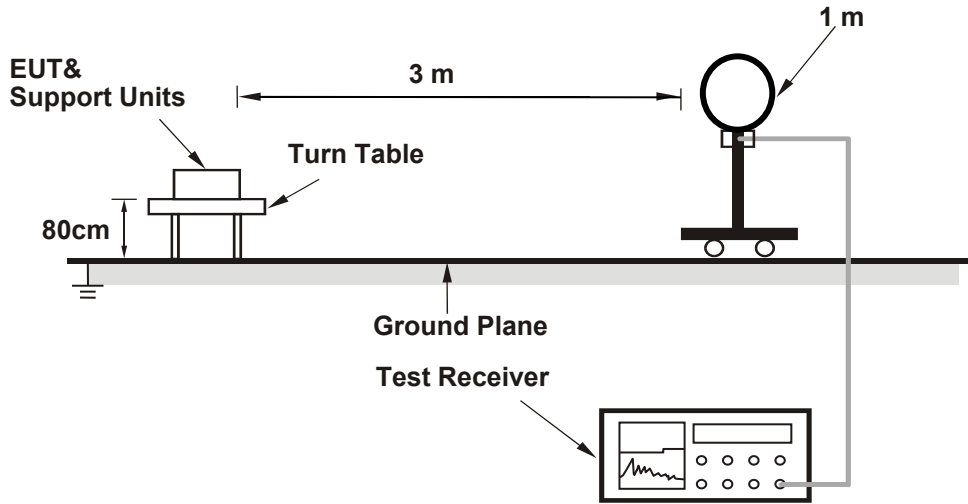

For Radiated emission 30MHz to 1GHz

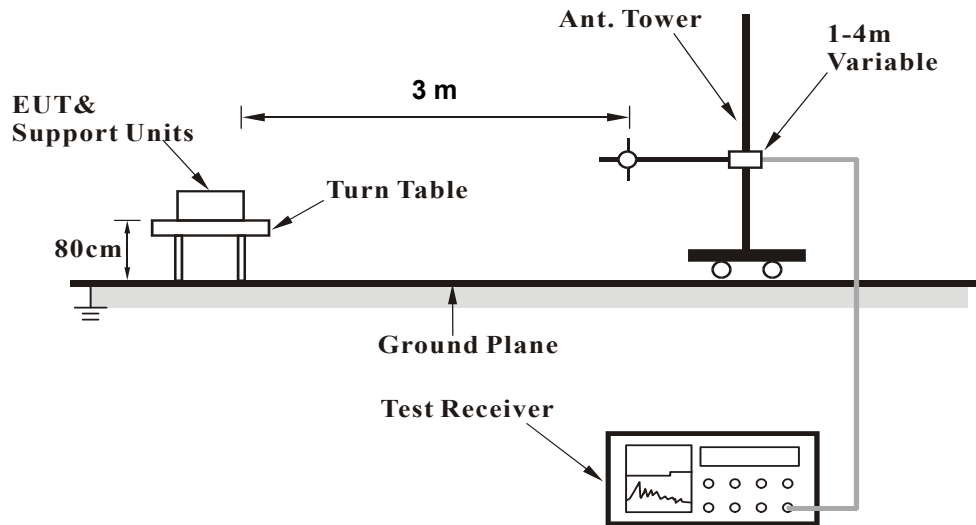

For Radiated emission 1GHz to 50GHz

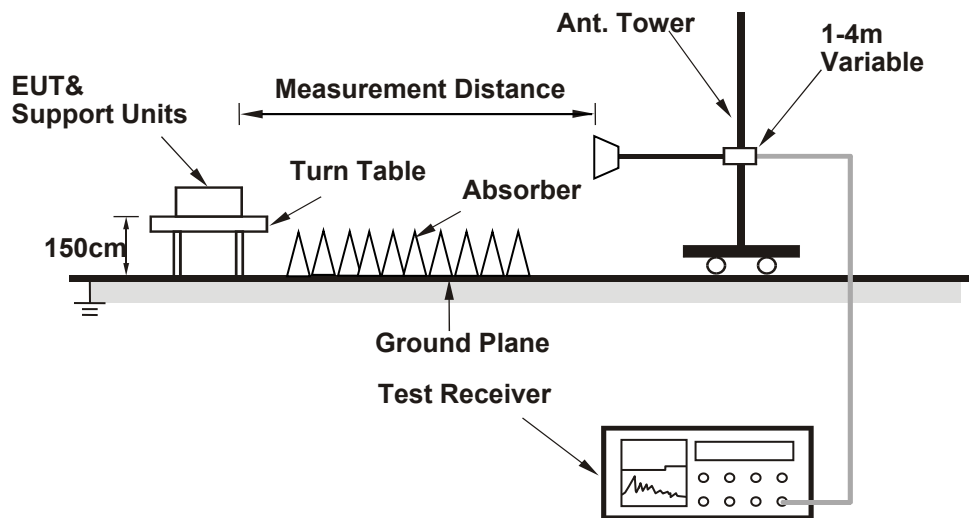

For Radiated emission above 50GHz

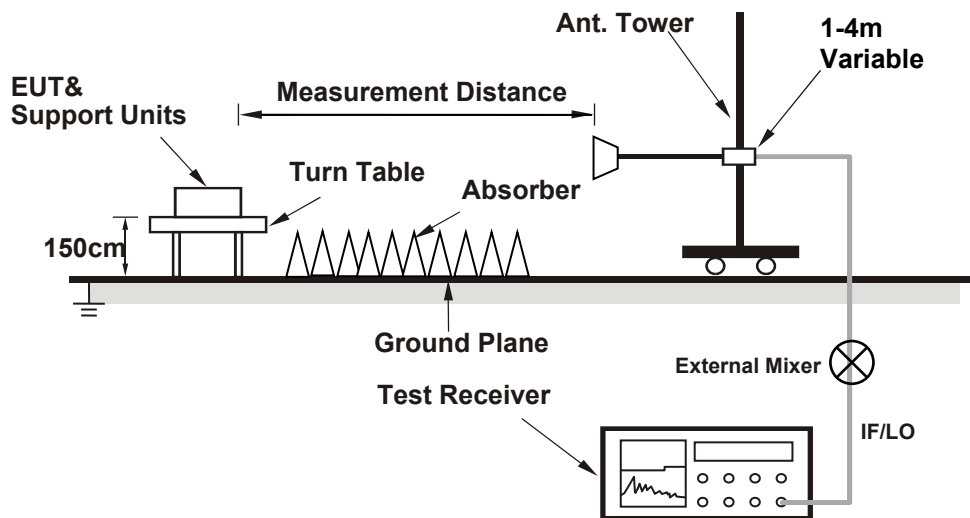

For the actual test configuration, please refer to the attached file (Test Setup Photo).

4.1.6 EUT Operating Conditions

- Placed the EUT on the testing table.
- Controlling software (Qualcomm Radio Control Toolkit v4.0-00158) has been activated to set the EUT under transmission condition continuously at specific channel frequency.

4.1.7 Test Results

Above 1GHz Data:
For 1~18 GHz

RF Mode	TX WiGig	Channel	CH 9 : 59.4 GHz
Frequency Range	1GHz ~ 18GHz	Detector Function	Peak (PK) Average (AV)

Antenna Polarity & Test Distance : Horizontal at 3 m								
No	Frequency (MHz)	Emission Level (dBuV/m)	Limit (dBuV/m)	Margin (dB)	Antenna Height (m)	Table Angle (Degree)	Raw Value (dBuV)	Correction Factor (dB/m)
1	2493.00	42.7 PK	74.0	-31.3	3.37 H	69	43.9	-1.2
2	2493.00	32.8 AV	54.0	-21.2	3.37 H	69	34.0	-1.2
3	3669.32	45.4 PK	74.0	-28.6	3.05 H	5	44.2	1.2
4	3669.32	36.0 AV	54.0	-18.0	3.05 H	5	34.8	1.2
5	17977.89	60.5 PK	74.0	-13.5	1.55 H	191	37.2	23.3
6	17977.89	50.1 AV	54.0	-3.9	1.55 H	191	26.8	23.3

Remarks:

1. Emission Level(dBuV/m) = Raw Value(dBuV) + Correction Factor(dB/m)
2. Correction Factor(dB/m) = Antenna Factor(dB/m) + Cable Factor(dB) – Pre-Amplifier Factor(dB)
3. Margin value = Emission Level – Limit value
4. The other emission levels were very low against the limit.

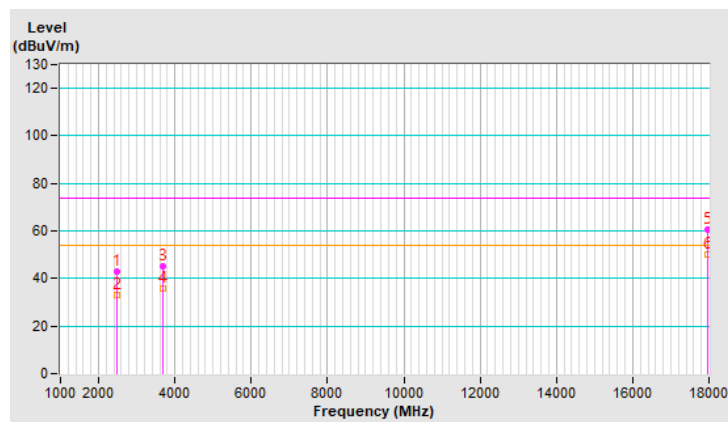

RF Mode	TX WiGig	Channel	CH 9 : 59.4 GHz
Frequency Range	1GHz ~ 18GHz	Detector Function	Peak (PK) Average (AV)

Antenna Polarity & Test Distance : Vertical at 3 m

No	Frequency (MHz)	Emission Level (dBuV/m)	Limit (dBuV/m)	Margin (dB)	Antenna Height (m)	Table Angle (Degree)	Raw Value (dBuV)	Correction Factor (dB/m)
1	2492.44	42.2 PK	74.0	-31.8	3.36 V	73	43.4	-1.2
2	2492.44	32.6 AV	54.0	-21.4	3.36 V	73	33.8	-1.2
3	3670.06	45.4 PK	74.0	-28.6	3.02 V	17	44.2	1.2
4	3670.06	36.2 AV	54.0	-17.8	3.02 V	17	35.0	1.2
5	17976.71	60.2 PK	74.0	-13.8	1.60 V	188	36.9	23.3
6	17976.71	49.9 AV	54.0	-4.1	1.60 V	188	26.6	23.3

Remarks:

1. Emission Level(dBuV/m) = Raw Value(dBuV) + Correction Factor(dB/m)
2. Correction Factor(dB/m) = Antenna Factor(dB/m) + Cable Factor(dB) – Pre-Amplifier Factor(dB)
3. Margin value = Emission Level – Limit value
4. The other emission levels were very low against the limit.

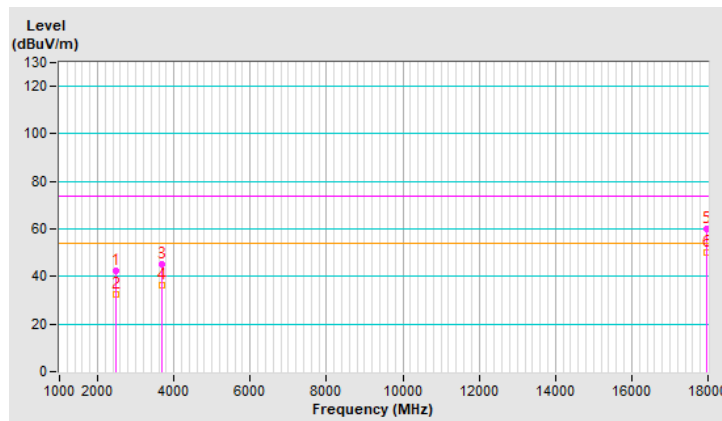

RF Mode	TX WiGig	Channel	CH 10 : 61.56 GHz
Frequency Range	1GHz ~ 18GHz	Detector Function	Peak (PK) Average (AV)

Antenna Polarity & Test Distance : Horizontal at 3 m								
No	Frequency (MHz)	Emission Level (dBuV/m)	Limit (dBuV/m)	Margin (dB)	Antenna Height (m)	Table Angle (Degree)	Raw Value (dBuV)	Correction Factor (dB/m)
1	2492.95	41.4 PK	74.0	-32.6	3.31 H	63	42.6	-1.2
2	2492.95	32.1 AV	54.0	-21.9	3.31 H	63	33.3	-1.2
3	3669.32	45.4 PK	74.0	-28.6	3.05 H	30	44.2	1.2
4	3669.32	36.4 AV	54.0	-17.6	3.05 H	30	35.2	1.2
5	17977.01	60.4 PK	74.0	-13.6	1.58 H	178	37.1	23.3
6	17977.01	49.9 AV	54.0	-4.1	1.58 H	178	26.6	23.3

Remarks:

1. Emission Level(dBuV/m) = Raw Value(dBuV) + Correction Factor(dB/m)
2. Correction Factor(dB/m) = Antenna Factor(dB/m) + Cable Factor(dB) – Pre-Amplifier Factor(dB)
3. Margin value = Emission Level – Limit value
4. The other emission levels were very low against the limit.

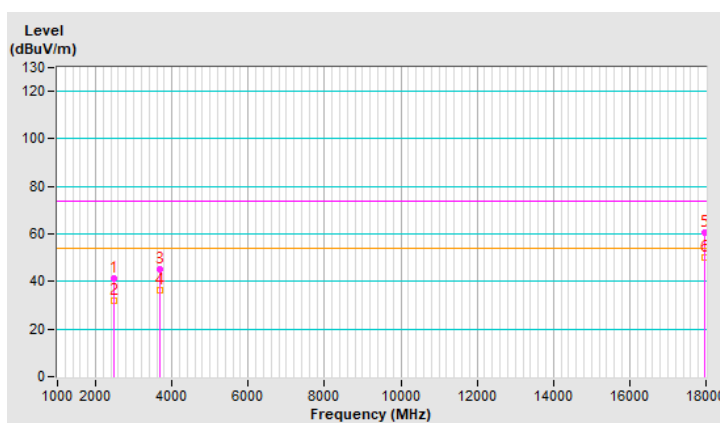

RF Mode	TX WiGig	Channel	CH 10 : 61.56 GHz
Frequency Range	1GHz ~ 18GHz	Detector Function	Peak (PK) Average (AV)

Antenna Polarity & Test Distance : Vertical at 3 m

No	Frequency (MHz)	Emission Level (dBuV/m)	Limit (dBuV/m)	Margin (dB)	Antenna Height (m)	Table Angle (Degree)	Raw Value (dBuV)	Correction Factor (dB/m)
1	2492.71	42.1 PK	74.0	-31.9	3.38 V	84	43.3	-1.2
2	2492.71	32.6 AV	54.0	-21.4	3.38 V	84	33.8	-1.2
3	3669.52	45.4 PK	74.0	-28.6	3.07 V	7	44.2	1.2
4	3669.52	35.9 AV	54.0	-18.1	3.07 V	7	34.7	1.2
5	17977.08	60.3 PK	74.0	-13.7	1.62 V	179	37.0	23.3
6	17977.08	50.3 AV	54.0	-3.7	1.62 V	179	27.0	23.3

Remarks:

1. Emission Level(dBuV/m) = Raw Value(dBuV) + Correction Factor(dB/m)
2. Correction Factor(dB/m) = Antenna Factor(dB/m) + Cable Factor(dB) – Pre-Amplifier Factor(dB)
3. Margin value = Emission Level – Limit value
4. The other emission levels were very low against the limit.

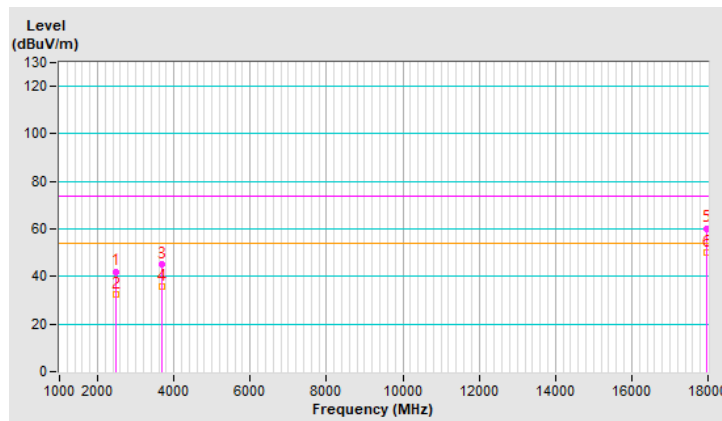

RF Mode	TX WiGig	Channel	CH 11 : 63.72 GHz
Frequency Range	1GHz ~ 18GHz	Detector Function	Peak (PK) Average (AV)

Antenna Polarity & Test Distance : Horizontal at 3 m								
No	Frequency (MHz)	Emission Level (dBuV/m)	Limit (dBuV/m)	Margin (dB)	Antenna Height (m)	Table Angle (Degree)	Raw Value (dBuV)	Correction Factor (dB/m)
1	2492.97	41.8 PK	74.0	-32.2	3.42 H	83	43.0	-1.2
2	2492.97	32.3 AV	54.0	-21.7	3.42 H	83	33.5	-1.2
3	3669.68	45.2 PK	74.0	-28.8	3.01 H	13	44.0	1.2
4	3669.68	35.8 AV	54.0	-18.2	3.01 H	13	34.6	1.2
5	17976.86	59.7 PK	74.0	-14.3	1.64 H	179	36.4	23.3
6	17976.86	49.4 AV	54.0	-4.6	1.64 H	179	26.1	23.3

Remarks:

1. Emission Level(dBuV/m) = Raw Value(dBuV) + Correction Factor(dB/m)
2. Correction Factor(dB/m) = Antenna Factor(dB/m) + Cable Factor(dB) – Pre-Amplifier Factor(dB)
3. Margin value = Emission Level – Limit value
4. The other emission levels were very low against the limit.

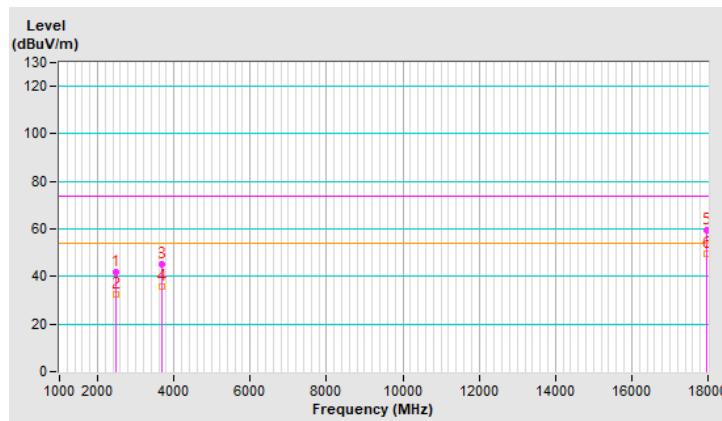

RF Mode	TX WiGig	Channel	CH 11 : 63.72 GHz
Frequency Range	1GHz ~ 18GHz	Detector Function	Peak (PK) Average (AV)

Antenna Polarity & Test Distance : Vertical at 3 m

No	Frequency (MHz)	Emission Level (dBuV/m)	Limit (dBuV/m)	Margin (dB)	Antenna Height (m)	Table Angle (Degree)	Raw Value (dBuV)	Correction Factor (dB/m)
1	2492.73	42.8 PK	74.0	-31.2	3.40 V	80	44.0	-1.2
2	2492.73	32.9 AV	54.0	-21.1	3.40 V	80	34.1	-1.2
3	3669.38	45.0 PK	74.0	-29.0	3.01 V	24	43.8	1.2
4	3669.38	35.8 AV	54.0	-18.2	3.01 V	24	34.6	1.2
5	17977.22	59.8 PK	74.0	-14.2	1.63 V	181	36.5	23.3
6	17977.22	49.8 AV	54.0	-4.2	1.63 V	181	26.5	23.3

Remarks:

1. Emission Level(dBuV/m) = Raw Value(dBuV) + Correction Factor(dB/m)
2. Correction Factor(dB/m) = Antenna Factor(dB/m) + Cable Factor(dB) – Pre-Amplifier Factor(dB)
3. Margin value = Emission Level – Limit value
4. The other emission levels were very low against the limit.

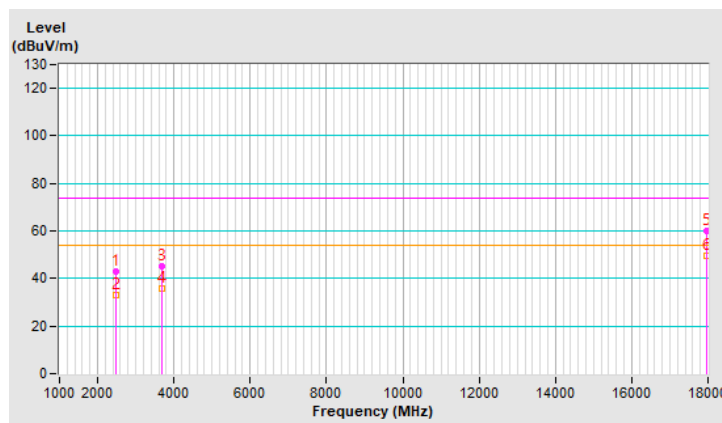

For 18~40 GHz

RF Mode	TX WiGig	Channel	CH 9 : 59.4 GHz
Frequency Range	18GHz ~ 40GHz	Detector Function	Peak (PK) Average (AV)

Antenna Polarity & Test Distance : Horizontal at 3 m

No	Frequency (MHz)	Emission Level (dBuV/m)	Limit (dBuV/m)	Margin (dB)	Antenna Height (m)	Table Angle (Degree)	Raw Value (dBuV)	Correction Factor (dB/m)
1	18544.55	38.9 PK	74.0	-35.1	1.44 H	87	45.5	-6.6
2	18544.55	34.2 AV	54.0	-19.8	1.44 H	87	40.8	-6.6
3	28113.45	42.7 PK	74.0	-31.3	1.89 H	271	44.5	-1.8
4	28113.45	37.5 AV	54.0	-16.5	1.89 H	271	39.3	-1.8
5	38818.41	44.4 PK	74.0	-29.6	1.75 H	190	39.9	4.5
6	38818.41	37.4 AV	54.0	-16.6	1.75 H	190	32.9	4.5

Remarks:

1. Emission Level(dBuV/m) = Raw Value(dBuV) + Correction Factor(dB/m)
2. Correction Factor(dB/m) = Antenna Factor(dB/m) + Cable Factor(dB) – Pre-Amplifier Factor(dB)
3. Margin value = Emission Level – Limit value
4. The other emission levels were very low against the limit.

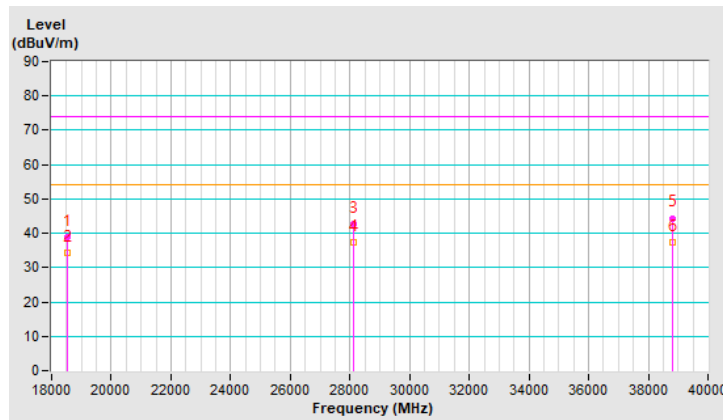

RF Mode	TX WiGig	Channel	CH 9 : 59.4 GHz
Frequency Range	18GHz ~ 40GHz	Detector Function	Peak (PK) Average (AV)

Antenna Polarity & Test Distance : Vertical at 3 m

No	Frequency (MHz)	Emission Level (dBuV/m)	Limit (dBuV/m)	Margin (dB)	Antenna Height (m)	Table Angle (Degree)	Raw Value (dBuV)	Correction Factor (dB/m)
1	18544.25	39.1 PK	74.0	-34.9	1.39 V	86	45.7	-6.6
2	18544.25	34.4 AV	54.0	-19.6	1.39 V	86	41.0	-6.6
3	28113.39	43.0 PK	74.0	-31.0	1.92 V	271	44.8	-1.8
4	28113.39	37.7 AV	54.0	-16.3	1.92 V	271	39.5	-1.8
5	38819.01	43.8 PK	74.0	-30.2	1.80 V	204	39.3	4.5
6	38819.01	37.1 AV	54.0	-16.9	1.80 V	204	32.6	4.5

Remarks:

1. Emission Level(dBuV/m) = Raw Value(dBuV) + Correction Factor(dB/m)
2. Correction Factor(dB/m) = Antenna Factor(dB/m) + Cable Factor(dB) – Pre-Amplifier Factor(dB)
3. Margin value = Emission Level – Limit value
4. The other emission levels were very low against the limit.

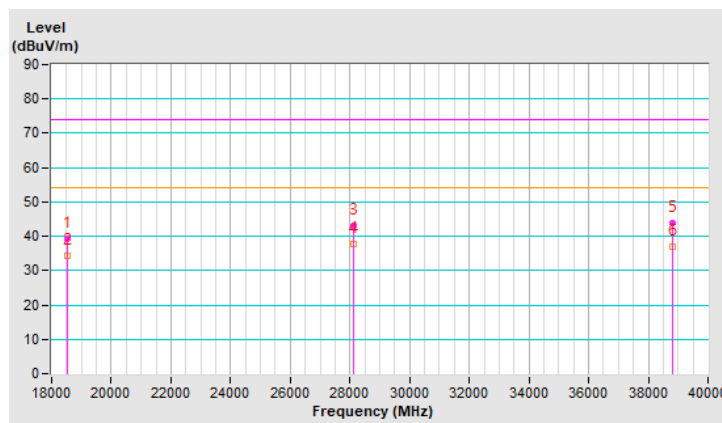

RF Mode	TX WiGig	Channel	CH 10 : 61.56 GHz
Frequency Range	18GHz ~ 40GHz	Detector Function	Peak (PK) Average (AV)

Antenna Polarity & Test Distance : Horizontal at 3 m								
No	Frequency (MHz)	Emission Level (dBuV/m)	Limit (dBuV/m)	Margin (dB)	Antenna Height (m)	Table Angle (Degree)	Raw Value (dBuV)	Correction Factor (dB/m)
1	18544.13	39.4 PK	74.0	-34.6	1.37 H	77	46.0	-6.6
2	18544.13	34.9 AV	54.0	-19.1	1.37 H	77	41.5	-6.6
3	28112.60	42.4 PK	74.0	-31.6	1.95 H	267	44.2	-1.8
4	28112.60	37.3 AV	54.0	-16.7	1.95 H	267	39.1	-1.8
5	38819.03	44.0 PK	74.0	-30.0	1.84 H	195	39.5	4.5
6	38819.03	37.4 AV	54.0	-16.6	1.84 H	195	32.9	4.5

Remarks:

1. Emission Level(dBuV/m) = Raw Value(dBuV) + Correction Factor(dB/m)
2. Correction Factor(dB/m) = Antenna Factor(dB/m) + Cable Factor(dB) – Pre-Amplifier Factor(dB)
3. Margin value = Emission Level – Limit value
4. The other emission levels were very low against the limit.

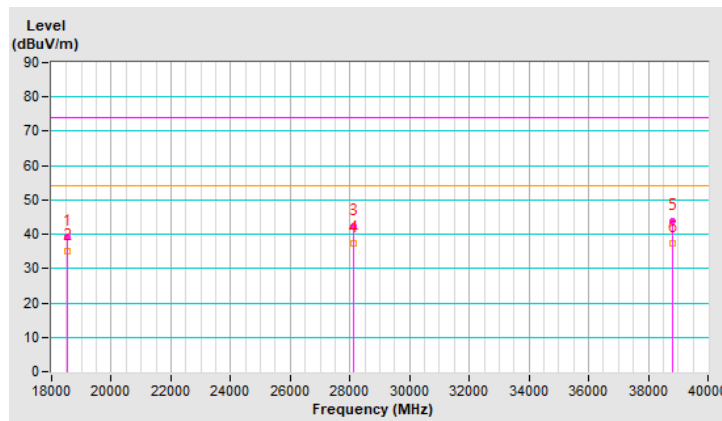

RF Mode	TX WiGig	Channel	CH 10 : 61.56 GHz
Frequency Range	18GHz ~ 40GHz	Detector Function	Peak (PK) Average (AV)

Antenna Polarity & Test Distance : Vertical at 3 m								
No	Frequency (MHz)	Emission Level (dBuV/m)	Limit (dBuV/m)	Margin (dB)	Antenna Height (m)	Table Angle (Degree)	Raw Value (dBuV)	Correction Factor (dB/m)
1	18543.55	38.7 PK	74.0	-35.3	1.43 V	86	45.3	-6.6
2	18543.55	34.0 AV	54.0	-20.0	1.43 V	86	40.6	-6.6
3	28113.19	43.0 PK	74.0	-31.0	1.88 V	283	44.8	-1.8
4	28113.19	37.9 AV	54.0	-16.1	1.88 V	283	39.7	-1.8
5	38818.29	44.2 PK	74.0	-29.8	1.80 V	190	39.7	4.5
6	38818.29	37.3 AV	54.0	-16.7	1.80 V	190	32.8	4.5

Remarks:

1. Emission Level(dBuV/m) = Raw Value(dBuV) + Correction Factor(dB/m)
2. Correction Factor(dB/m) = Antenna Factor(dB/m) + Cable Factor(dB) – Pre-Amplifier Factor(dB)
3. Margin value = Emission Level – Limit value
4. The other emission levels were very low against the limit.

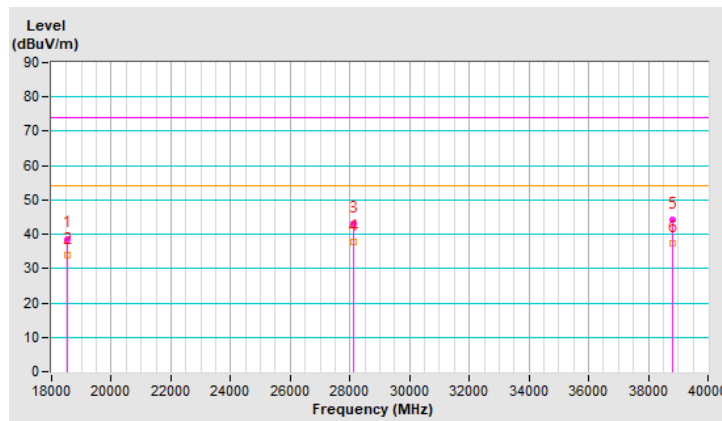

RF Mode	TX WiGig	Channel	CH 11 : 63.72 GHz
Frequency Range	18GHz ~ 40GHz	Detector Function	Peak (PK) Average (AV)

Antenna Polarity & Test Distance : Horizontal at 3 m								
No	Frequency (MHz)	Emission Level (dBuV/m)	Limit (dBuV/m)	Margin (dB)	Antenna Height (m)	Table Angle (Degree)	Raw Value (dBuV)	Correction Factor (dB/m)
1	18544.15	39.1 PK	74.0	-34.9	1.40 H	84	45.7	-6.6
2	18544.15	34.3 AV	54.0	-19.7	1.40 H	84	40.9	-6.6
3	28113.45	42.6 PK	74.0	-31.4	1.97 H	278	44.4	-1.8
4	28113.45	37.5 AV	54.0	-16.5	1.97 H	278	39.3	-1.8
5	38818.78	43.8 PK	74.0	-30.2	1.84 H	195	39.3	4.5
6	38818.78	37.4 AV	54.0	-16.6	1.84 H	195	32.9	4.5

Remarks:

1. Emission Level(dBuV/m) = Raw Value(dBuV) + Correction Factor(dB/m)
2. Correction Factor(dB/m) = Antenna Factor(dB/m) + Cable Factor(dB) – Pre-Amplifier Factor(dB)
3. Margin value = Emission Level – Limit value
4. The other emission levels were very low against the limit.

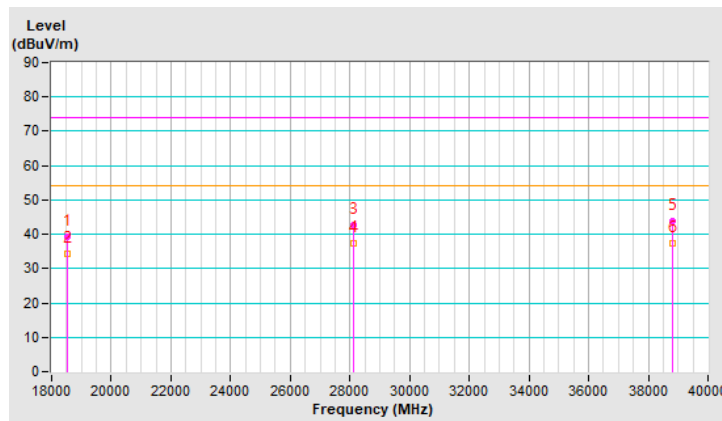

RF Mode	TX WiGig	Channel	CH 11 : 63.72 GHz
Frequency Range	18GHz ~ 40GHz	Detector Function	Peak (PK) Average (AV)

Antenna Polarity & Test Distance : Vertical at 3 m								
No	Frequency (MHz)	Emission Level (dBuV/m)	Limit (dBuV/m)	Margin (dB)	Antenna Height (m)	Table Angle (Degree)	Raw Value (dBuV)	Correction Factor (dB/m)
1	18544.68	38.8 PK	74.0	-35.2	1.37 V	102	45.4	-6.6
2	18544.68	34.0 AV	54.0	-20.0	1.37 V	102	40.6	-6.6
3	28113.76	43.3 PK	74.0	-30.7	1.89 V	262	45.1	-1.8
4	28113.76	38.0 AV	54.0	-16.0	1.89 V	262	39.8	-1.8
5	38818.53	43.8 PK	74.0	-30.2	1.82 V	216	39.3	4.5
6	38818.53	36.8 AV	54.0	-17.2	1.82 V	216	32.3	4.5

Remarks:

1. Emission Level(dBuV/m) = Raw Value(dBuV) + Correction Factor(dB/m)
2. Correction Factor(dB/m) = Antenna Factor(dB/m) + Cable Factor(dB) – Pre-Amplifier Factor(dB)
3. Margin value = Emission Level – Limit value
4. The other emission levels were very low against the limit.

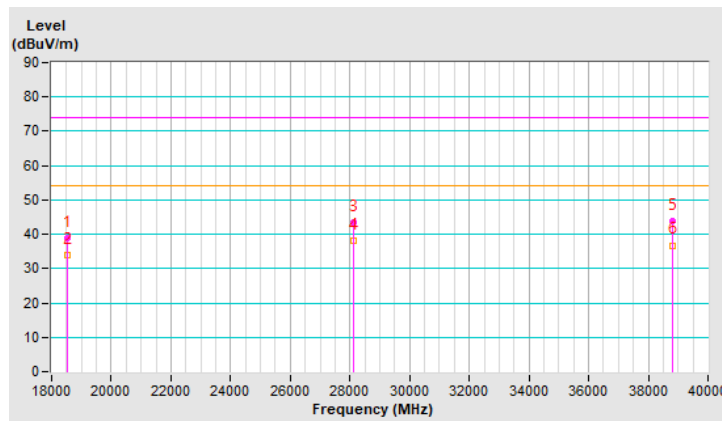

For above 40 GHz

RF Mode	TX WiGig	Channel	CH 9 : 59.4 GHz
Frequency Range	40GHz ~ 200GHz	Detector Function	Average (AV)

Antenna Polarity : Horizontal										
No.	Frequency (GHz)	SA Value (dBm)	Power (dBm)	Gain of test Antenna (dBi)	E _{Meas} (dB μ V/m)	EIRP Level (dBm/MHz)	Power Density (pW/cm ²)	Power Density Limit (pW/cm ²)	Margin (pW/cm ²)	Pass/Fail
1	42.29	-73.22	-70.56	20.30	69.44	-35.26	0.26	90.00	-89.74	Pass
2	54.35	-71.64	-66.58	19.90	76.02	-28.68	1.20	90.00	-88.80	Pass
3	73.67	-71.36	-81.58	21.40	62.17	-42.53	0.05	90.00	-89.95	Pass
4	101.96	-92.54	-81.52	21.50	64.93	-39.77	0.09	90.00	-89.91	Pass
5	117.00	-91.59	-71.70	20.50	76.93	-27.77	1.48	90.00	-88.52	Pass
6	193.72	-95.99	-80.79	23.90	68.83	-35.87	0.23	90.00	-89.77	Pass
Antenna Polarity : Vertical										
No.	Frequency (GHz)	SA Value (dBm)	Power (dBm)	Gain of test Antenna (dBi)	E _{Meas} (dB μ V/m)	EIRP Level (dBm/MHz)	Power Density (pW/cm ²)	Power Density Limit (pW/cm ²)	Margin (pW/cm ²)	Pass/Fail
1	41.38	-73.56	-70.36	20.30	69.45	-35.25	0.26	90.00	-89.74	Pass
2	54.46	-71.70	-65.72	19.90	76.87	-27.83	1.46	90.00	-88.54	Pass
3	73.82	-71.85	-80.89	21.40	62.85	-41.85	0.06	90.00	-89.94	Pass
4	102.32	-92.47	-81.43	21.50	65.03	-39.67	0.10	90.00	-89.90	Pass
5	116.59	-91.30	-70.91	20.50	77.68	-27.02	1.76	90.00	-88.24	Pass
6	192.04	-95.68	-80.62	23.90	68.92	-35.78	0.23	90.00	-89.77	Pass

Remarks:

1. The measured power level is converted to EIRP using the equation:

Follow ANSI 63.10 section 9.4 Equations to calculate and extrapolate field strength

$$E_{Meas} \text{ (dB}\mu\text{V/m)} = 126.8 - 20\log(\lambda) + P - G$$

where:

E_{Meas} is the field strength of the emission at the measurement distance, in dB μ V/m

P is the power measured at the output of the test antenna, in dBm

λ is the wavelength of the emission under investigation [300/fMHz], in m

G is the gain of the test antenna, in dBi

Follow ANSI 63.10 section 9.5 Equations to calculate EIRP

$$\text{EIRP Level (dBm/MHz)} = E_{Meas} \text{ (dB}\mu\text{V/m)} + 20 \cdot \log(d_{Meas}) - 104.7$$

E_{Meas} is the field strength of the emission at the measurement distance, in dB μ V/m

d_{Meas} is the measurement distance, in m

Measurements made at 1 meter distance.

2. Power density formula as follows

Follow ANSI 63.10 section 9.6 Equations to calculate power density

$$PD = \text{EIRP}_{Linear} / 4\pi d^2$$

PD is the power density at the distance specified by the limit, in W/m²

EIRP_{Linear} is the equivalent isotropically radiated power, in watts

d is the 3 m distance.

3. The far-field boundary is given in ANSI 63.10 as:

$$R \text{ far field} = (2 \cdot L^2) / \lambda$$

L is the Largest Antenna Dimension of measurement antenna, including the reflector

λ is the wavelength

Frequency (GHz)	L (m)	Lambda (m)	R (Far Field) (m)
40	0.03	0.0075	0.240
50	0.03	0.0060	0.300

Frequency (GHz)	L (m)	Lambda (m)	R (Far Field) (m)
50	0.025	0.0060	0.208
75	0.025	0.0040	0.313

Frequency (GHz)	L (m)	Lambda (m)	R (Far Field) (m)
75	0.018	0.0040	0.162
110	0.018	0.0027	0.238

Frequency (GHz)	L (m)	Lambda (m)	R (Far Field) (m)
110	0.012	0.0027	0.106
170	0.012	0.0018	0.163

Frequency (GHz)	L (m)	Lambda (m)	R (Far Field) (m)
170	0.008	0.0018	0.073
260	0.008	0.0012	0.111

RF Mode	TX WiGig	Channel	CH 10 : 61.56 GHz
Frequency Range	40GHz ~ 200GHz	Detector Function	Average (AV)

Antenna Polarity : Horizontal

No.	Frequency (GHz)	SA Value (dBm)	Power (dBm)	Gain of test Antenna (dBi)	E _{Meas} (dB μ V/m)	EIRP Level (dBm/MHz)	Power Density (pW/cm ²)	Power Density Limit (pW/cm ²)	Margin (pW/cm ²)	Pass/Fail
1	41.90	-73.56	-70.84	20.30	78.57	-26.13	2.15	90.00	-87.85	Pass
2	53.90	-71.82	-66.48	19.90	85.59	-19.11	10.85	90.00	-79.15	Pass
3	74.08	-71.48	-81.53	21.40	71.75	-32.95	0.45	90.00	-89.55	Pass
4	102.39	-92.82	-81.87	21.50	74.12	-30.58	0.77	90.00	-89.23	Pass
5	117.02	-91.98	-71.68	20.50	86.46	-18.24	13.27	90.00	-76.73	Pass
6	194.36	-95.48	-80.80	23.90	78.34	-26.36	2.04	90.00	-87.96	Pass

Antenna Polarity : Vertical

No.	Frequency (GHz)	SA Value (dBm)	Power (dBm)	Gain of test Antenna (dBi)	E _{Meas} (dB μ V/m)	EIRP Level (dBm/MHz)	Power Density (pW/cm ²)	Power Density Limit (pW/cm ²)	Margin (pW/cm ²)	Pass/Fail
1	40.91	-73.78	-70.55	20.30	78.71	-25.99	2.23	90.00	-87.77	Pass
2	53.92	-71.50	-65.67	19.90	86.39	-18.31	13.04	90.00	-76.96	Pass
3	74.49	-71.31	-80.80	21.40	72.52	-32.18	0.54	90.00	-89.46	Pass
4	101.72	-92.90	-81.30	21.50	74.63	-30.07	0.87	90.00	-89.13	Pass
5	115.84	-92.13	-70.72	20.50	87.34	-17.36	16.25	90.00	-73.76	Pass
6	191.86	-95.88	-80.53	23.90	78.50	-26.20	2.12	90.00	-87.88	Pass

Remarks:

1. The measured power level is converted to EIRP using the equation:

Follow ANSI 63.10 section 9.4 Equations to calculate and extrapolate field strength

$$E_{Meas} \text{ (dB}\mu\text{V/m)} = 126.8 - 20\log(\lambda) + P - G$$

where:

E_{Meas} is the field strength of the emission at the measurement distance, in dB μ V/m

P is the power measured at the output of the test antenna, in dBm

λ is the wavelength of the emission under investigation [300/fMHz], in m

G is the gain of the test antenna, in dBi

Follow ANSI 63.10 section 9.5 Equations to calculate EIRP

$$\text{EIRP Level (dBm/MHz)} = E_{Meas} \text{ (dB}\mu\text{V/m)} + 20 \cdot \log(d_{Meas}) - 104.7$$

E_{Meas} is the field strength of the emission at the measurement distance, in dB μ V/m

d_{Meas} is the measurement distance, in m

Measurements made at 1 meter distance.

2. Power density formula as follows

Follow ANSI 63.10 section 9.6 Equations to calculate power density

$$PD = \text{EIRP}_{Linear} / 4\pi d^2$$

PD is the power density at the distance specified by the limit, in W/m²

EIRP_{Linear} is the equivalent isotropically radiated power, in watts

d is the 3 m distance.

3. The far-field boundary is given in ANSI 63.10 as:

$$R \text{ far field} = (2 \cdot L^2) / \lambda$$

L is the Largest Antenna Dimension of measurement antenna, including the reflector

λ is the wavelength

Frequency (GHz)	L (m)	Lambda (m)	R (Far Field) (m)
40	0.03	0.0075	0.240
50	0.03	0.0060	0.300

Frequency (GHz)	L (m)	Lambda (m)	R (Far Field) (m)
50	0.025	0.0060	0.208
75	0.025	0.0040	0.313

Frequency (GHz)	L (m)	Lambda (m)	R (Far Field) (m)
75	0.018	0.0040	0.162
110	0.018	0.0027	0.238

Frequency (GHz)	L (m)	Lambda (m)	R (Far Field) (m)
110	0.012	0.0027	0.106
170	0.012	0.0018	0.163

Frequency (GHz)	L (m)	Lambda (m)	R (Far Field) (m)
170	0.008	0.0018	0.073
260	0.008	0.0012	0.111

RF Mode	TX WiGig	Channel	CH 11 : 63.72 GHz
Frequency Range	40GHz ~ 200GHz	Detector Function	Average (AV)

Antenna Polarity : Horizontal										
No.	Frequency (GHz)	SA Value (dBm)	Power (dBm)	Gain of test Antenna (dBi)	E _{Meas} (dB μ V/m)	EIRP Level (dBm/MHz)	Power Density (pW/cm ²)	Power Density Limit (pW/cm ²)	Margin (pW/cm ²)	Pass/Fail
1	41.62	-73.88	-70.92	20.30	78.51	-26.19	2.13	90.00	-87.87	Pass
2	53.91	-71.55	-66.54	19.90	85.52	-19.18	10.69	90.00	-79.31	Pass
3	73.80	-72.25	-81.47	21.40	71.76	-32.94	0.45	90.00	-89.55	Pass
4	102.55	-93.07	-81.61	21.50	74.38	-30.32	0.82	90.00	-89.18	Pass
5	117.28	-91.77	-71.56	20.50	86.58	-18.12	13.64	90.00	-76.36	Pass
6	194.15	-95.84	-80.49	23.90	78.65	-26.05	2.19	90.00	-87.81	Pass
Antenna Polarity : Vertical										
No.	Frequency (GHz)	SA Value (dBm)	Power (dBm)	Gain of test Antenna (dBi)	E _{Meas} (dB μ V/m)	EIRP Level (dBm/MHz)	Power Density (pW/cm ²)	Power Density Limit (pW/cm ²)	Margin (pW/cm ²)	Pass/Fail
1	41.39	-73.55	-70.20	20.30	79.16	-25.54	2.47	90.00	-87.53	Pass
2	54.03	-71.59	-65.97	19.90	86.09	-18.61	12.19	90.00	-77.81	Pass
3	74.08	-72.11	-81.18	21.40	72.09	-32.61	0.48	90.00	-89.52	Pass
4	101.55	-93.02	-81.35	21.50	74.57	-30.13	0.86	90.00	-89.14	Pass
5	116.10	-91.54	-70.92	20.50	87.17	-17.53	15.62	90.00	-74.38	Pass
6	192.07	-95.75	-80.58	23.90	78.45	-26.25	2.10	90.00	-87.90	Pass

Remarks:

1. The measured power level is converted to EIRP using the equation:

Follow ANSI 63.10 section 9.4 Equations to calculate and extrapolate field strength

$$E_{Meas} \text{ (dB}\mu\text{V/m)} = 126.8 - 20\log(\lambda) + P - G$$

where:

E_{Meas} is the field strength of the emission at the measurement distance, in dB μ V/m

P is the power measured at the output of the test antenna, in dBm

λ is the wavelength of the emission under investigation [300/fMHz], in m

G is the gain of the test antenna, in dBi

Follow ANSI 63.10 section 9.5 Equations to calculate EIRP

$$\text{EIRP Level (dBm/MHz)} = E_{Meas} \text{ (dB}\mu\text{V/m)} + 20 \cdot \log(d_{Meas}) - 104.7$$

E_{Meas} is the field strength of the emission at the measurement distance, in dB μ V/m

d_{Meas} is the measurement distance, in m

Measurements made at 1 meter distance.

2. Power density formula as follows

Follow ANSI 63.10 section 9.6 Equations to calculate power density

$$PD = \text{EIRP}_{Linear} / 4\pi d^2$$

PD is the power density at the distance specified by the limit, in W/m²

EIRP_{Linear} is the equivalent isotropically radiated power, in watts

d is the 3 m distance.

3. The far-field boundary is given in ANSI 63.10 as:

$$R \text{ far field} = (2 \cdot L^2) / \lambda$$

L is the Largest Antenna Dimension of measurement antenna, including the reflector

λ is the wavelength

Frequency (GHz)	L (m)	Lambda (m)	R (Far Field) (m)
40	0.03	0.0075	0.240
50	0.03	0.0060	0.300

Frequency (GHz)	L (m)	Lambda (m)	R (Far Field) (m)
50	0.025	0.0060	0.208
75	0.025	0.0040	0.313

Frequency (GHz)	L (m)	Lambda (m)	R (Far Field) (m)
75	0.018	0.0040	0.162
110	0.018	0.0027	0.238

Frequency (GHz)	L (m)	Lambda (m)	R (Far Field) (m)
110	0.012	0.0027	0.106
170	0.012	0.0018	0.163

Frequency (GHz)	L (m)	Lambda (m)	R (Far Field) (m)
170	0.008	0.0018	0.073
260	0.008	0.0012	0.111

Below 1GHz Data:

RF Mode	TX WiGig	Channel	CH 9 : 59.4 GHz
Frequency Range	9kHz ~ 1GHz	Detector Function	Quasi-Peak (QP)

Antenna Polarity & Test Distance : Horizontal at 3 m								
No	Frequency (MHz)	Emission Level (dBuV/m)	Limit (dBuV/m)	Margin (dB)	Antenna Height (m)	Table Angle (Degree)	Raw Value (dBuV)	Correction Factor (dB/m)
1	31.44	29.9 QP	40.0	-10.1	1.00 H	18	43.8	-13.9
2	86.85	34.2 QP	40.0	-5.8	2.50 H	52	52.4	-18.2
3	120.89	30.8 QP	43.5	-12.7	3.00 H	138	44.9	-14.1
4	176.58	35.1 QP	43.5	-8.4	2.50 H	293	48.3	-13.2
5	249.50	31.1 QP	46.0	-14.9	1.50 H	75	44.2	-13.1
6	374.70	32.8 QP	46.0	-13.2	1.00 H	56	41.6	-8.8

Remarks:

1. Emission Level(dBuV/m) = Raw Value(dBuV) + Correction Factor(dB/m)
2. Correction Factor(dB/m) = Antenna Factor(dB/m) + Cable Factor(dB) – Pre-Amplifier Factor(dB)
3. Margin value = Emission Level – Limit value
4. The other emission levels were very low against the limit of frequency range 30MHz~1000MHz.
5. The emission levels were very low against the limit of frequency range 9kHz~30MHz: the amplitude of spurious emissions attenuated more than 20 dB below the permissible value to be report.

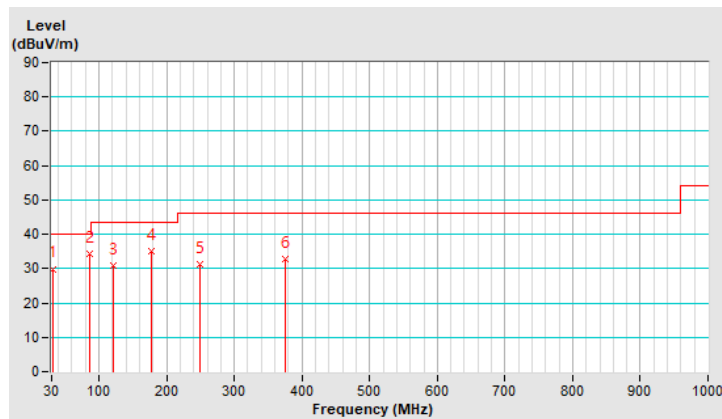

RF Mode	TX WiGig	Channel	CH 9 : 59.4 GHz
Frequency Range	9kHz ~ 1GHz	Detector Function	Quasi-Peak (QP)

Antenna Polarity & Test Distance : Vertical at 3 m								
No	Frequency (MHz)	Emission Level (dBuV/m)	Limit (dBuV/m)	Margin (dB)	Antenna Height (m)	Table Angle (Degree)	Raw Value (dBuV)	Correction Factor (dB/m)
1	43.23	34.6 QP	40.0	-5.4	1.00 V	265	47.5	-12.9
2	82.91	35.1 QP	40.0	-4.9	1.50 V	89	53.0	-17.9
3	120.94	30.6 QP	43.5	-12.9	2.00 V	123	44.6	-14.0
4	175.15	36.5 QP	43.5	-7.0	2.00 V	130	49.6	-13.1
5	208.41	30.0 QP	43.5	-13.5	1.00 V	119	45.1	-15.1
6	874.93	30.6 QP	46.0	-15.4	1.00 V	243	28.8	1.8

Remarks:

1. Emission Level(dBuV/m) = Raw Value(dBuV) + Correction Factor(dB/m)
2. Correction Factor(dB/m) = Antenna Factor(dB/m) + Cable Factor(dB) – Pre-Amplifier Factor(dB)
3. Margin value = Emission Level – Limit value
4. The other emission levels were very low against the limit of frequency range 30MHz~1000MHz.
5. The emission levels were very low against the limit of frequency range 9kHz~30MHz: the amplitude of spurious emissions attenuated more than 20 dB below the permissible value to be report.

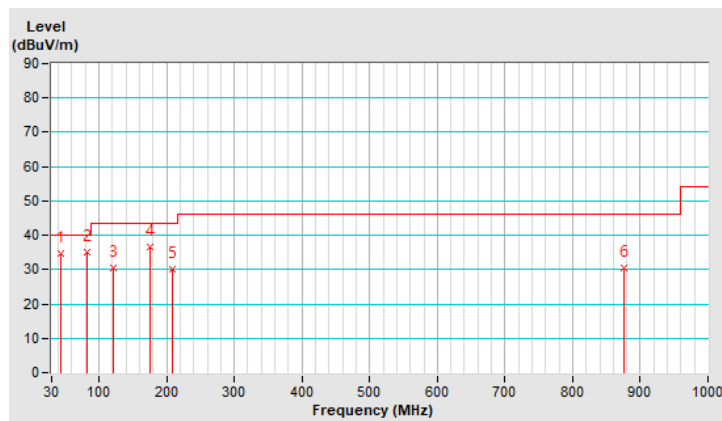

RF Mode	TX WiGig	Channel	CH 10 : 61.56 GHz
Frequency Range	9kHz ~ 1GHz	Detector Function	Quasi-Peak (QP)

Antenna Polarity & Test Distance : Horizontal at 3 m								
No	Frequency (MHz)	Emission Level (dBUV/m)	Limit (dBUV/m)	Margin (dB)	Antenna Height (m)	Table Angle (Degree)	Raw Value (dBUV)	Correction Factor (dB/m)
1	32.60	29.5 QP	40.0	-10.5	1.00 H	31	43.4	-13.9
2	87.06	34.5 QP	40.0	-5.5	2.00 H	47	52.7	-18.2
3	121.80	31.4 QP	43.5	-12.1	2.00 H	148	45.5	-14.1
4	176.25	34.7 QP	43.5	-8.8	3.00 H	281	47.9	-13.2
5	250.23	31.5 QP	46.0	-14.5	1.00 H	64	44.6	-13.1
6	375.10	32.4 QP	46.0	-13.6	1.00 H	49	41.2	-8.8

Remarks:

1. Emission Level(dBUV/m) = Raw Value(dBUV) + Correction Factor(dB/m)
2. Correction Factor(dB/m) = Antenna Factor(dB/m) + Cable Factor(dB) – Pre-Amplifier Factor(dB)
3. Margin value = Emission Level – Limit value
4. The other emission levels were very low against the limit of frequency range 30MHz~1000MHz.
5. The emission levels were very low against the limit of frequency range 9kHz~30MHz: the amplitude of spurious emissions attenuated more than 20 dB below the permissible value to be report.

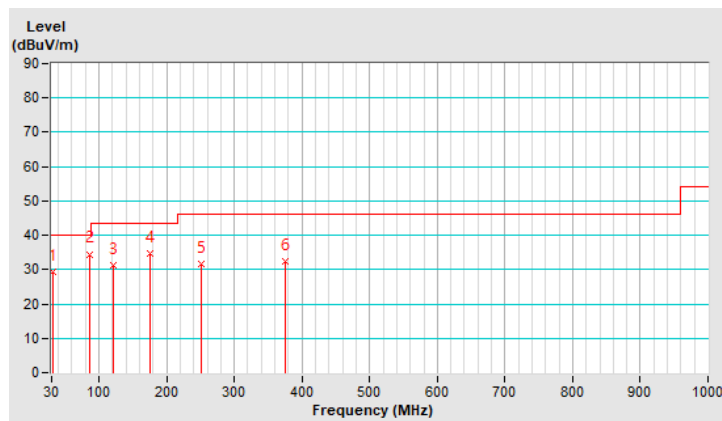

RF Mode	TX WiGig	Channel	CH 10 : 61.56 GHz
Frequency Range	9kHz ~ 1GHz	Detector Function	Quasi-Peak (QP)

Antenna Polarity & Test Distance : Vertical at 3 m

No	Frequency (MHz)	Emission Level (dBUV/m)	Limit (dBUV/m)	Margin (dB)	Antenna Height (m)	Table Angle (Degree)	Raw Value (dBUV)	Correction Factor (dB/m)
1	42.83	33.9 QP	40.0	-6.1	1.00 V	266	46.8	-12.9
2	82.84	35.0 QP	40.0	-5.0	1.50 V	74	52.9	-17.9
3	121.41	29.9 QP	43.5	-13.6	1.50 V	139	44.0	-14.1
4	175.04	36.0 QP	43.5	-7.5	3.00 V	111	49.1	-13.1
5	207.69	30.4 QP	43.5	-13.1	1.00 V	119	45.5	-15.1
6	874.45	31.3 QP	46.0	-14.7	1.50 V	255	29.5	1.8

Remarks:

1. Emission Level(dBuV/m) = Raw Value(dBuV) + Correction Factor(dB/m)
2. Correction Factor(dB/m) = Antenna Factor(dB/m) + Cable Factor(dB) – Pre-Amplifier Factor(dB)
3. Margin value = Emission Level – Limit value
4. The other emission levels were very low against the limit of frequency range 30MHz~1000MHz.
5. The emission levels were very low against the limit of frequency range 9kHz~30MHz: the amplitude of spurious emissions attenuated more than 20 dB below the permissible value to be report.

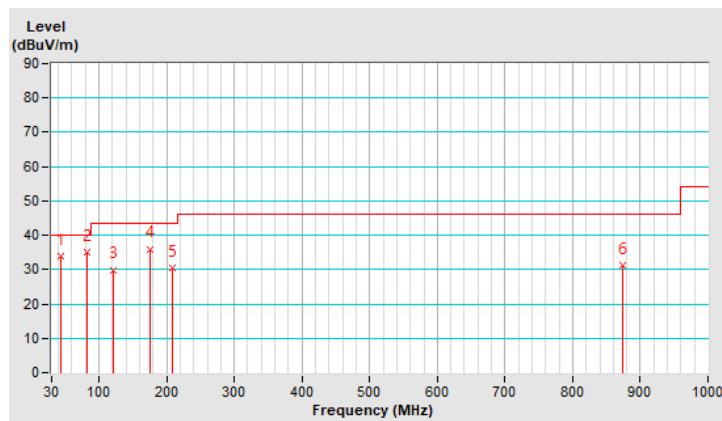

RF Mode	TX WiGig	Channel	CH 11 : 63.72 GHz
Frequency Range	9kHz ~ 1GHz	Detector Function	Quasi-Peak (QP)

Antenna Polarity & Test Distance : Horizontal at 3 m								
No	Frequency (MHz)	Emission Level (dBUV/m)	Limit (dBUV/m)	Margin (dB)	Antenna Height (m)	Table Angle (Degree)	Raw Value (dBUV)	Correction Factor (dB/m)
1	31.30	30.7 QP	40.0	-9.3	1.00 H	21	44.7	-14.0
2	86.92	34.1 QP	40.0	-5.9	1.50 H	42	52.3	-18.2
3	120.99	30.7 QP	43.5	-12.8	2.00 H	129	44.7	-14.0
4	177.28	34.6 QP	43.5	-8.9	2.00 H	305	47.9	-13.3
5	249.65	31.4 QP	46.0	-14.6	1.00 H	88	44.5	-13.1
6	375.51	32.3 QP	46.0	-13.7	1.00 H	57	41.1	-8.8

Remarks:

1. Emission Level(dBUV/m) = Raw Value(dBUV) + Correction Factor(dB/m)
2. Correction Factor(dB/m) = Antenna Factor(dB/m) + Cable Factor(dB) – Pre-Amplifier Factor(dB)
3. Margin value = Emission Level – Limit value
4. The other emission levels were very low against the limit of frequency range 30MHz~1000MHz.
5. The emission levels were very low against the limit of frequency range 9kHz~30MHz: the amplitude of spurious emissions attenuated more than 20 dB below the permissible value to be report.

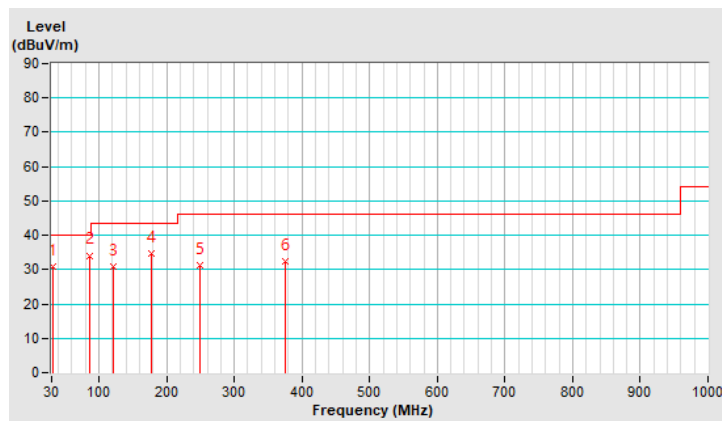

RF Mode	TX WiGig	Channel	CH 11 : 63.72 GHz
Frequency Range	9kHz ~ 1GHz	Detector Function	Quasi-Peak (QP)

Antenna Polarity & Test Distance : Vertical at 3 m

No	Frequency (MHz)	Emission Level (dBuV/m)	Limit (dBuV/m)	Margin (dB)	Antenna Height (m)	Table Angle (Degree)	Raw Value (dBuV)	Correction Factor (dB/m)
1	42.96	33.6 QP	40.0	-6.4	1.00 V	247	46.5	-12.9
2	82.34	35.2 QP	40.0	-4.8	1.50 V	83	53.0	-17.8
3	121.24	29.9 QP	43.5	-13.6	2.00 V	146	43.9	-14.0
4	175.64	35.5 QP	43.5	-8.0	2.00 V	125	48.6	-13.1
5	208.46	29.9 QP	43.5	-13.6	1.00 V	145	45.0	-15.1
6	875.07	30.4 QP	46.0	-15.6	1.00 V	260	28.6	1.8

Remarks:

1. Emission Level(dBuV/m) = Raw Value(dBuV) + Correction Factor(dB/m)
2. Correction Factor(dB/m) = Antenna Factor(dB/m) + Cable Factor(dB) – Pre-Amplifier Factor(dB)
3. Margin value = Emission Level – Limit value
4. The other emission levels were very low against the limit of frequency range 30MHz~1000MHz.
5. The emission levels were very low against the limit of frequency range 9kHz~30MHz: the amplitude of spurious emissions attenuated more than 20 dB below the permissible value to be report.

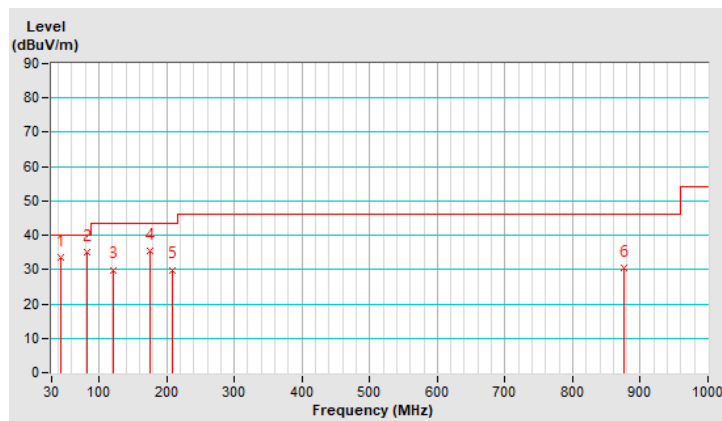

4.2 6dB Bandwidth Measurement

4.2.1 Limits of 6dB Bandwidth Measurement

None: For reporting purposes only.

4.2.2 Test Setup

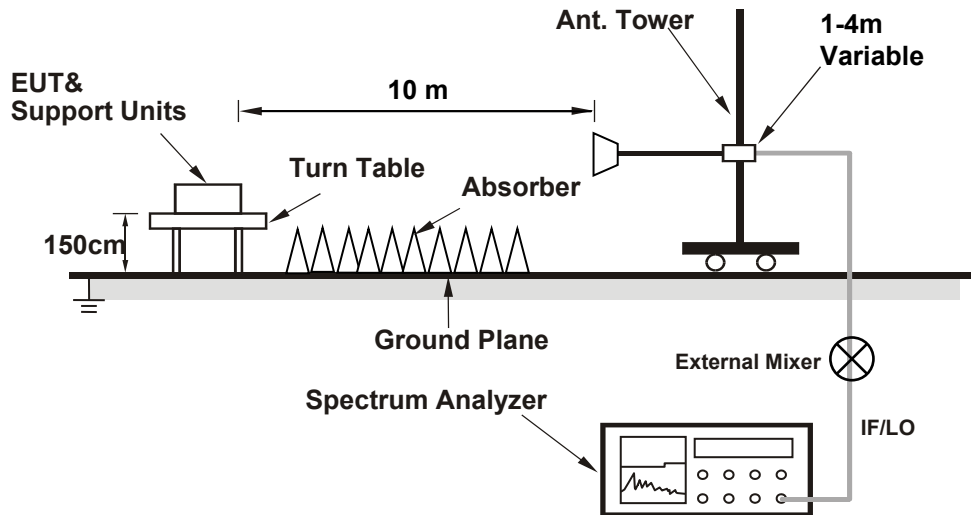

4.2.3 Test Instruments

Description & Manufacturer	Model No.	Serial No.	Calibrated Date	Calibrated Until
Spectrum Analyzer Keysight	N9030A	MY55330160	2021/2/5	2022/2/4
50G~75G Conical Horn Antenna Keysight	WR15CH-Conical Horn Antenna	WR15CH_001	2020/1/20	2022/1/19
N9029AV15-DC9 - 50-75 GHz VDI Standard Downconverter with 9VDC supply Keysight	SA Extension WR15	SAX 381	CoC	CoC
Antenna Tower & Turn Table CT	NA	NA	NA	NA

- Note: 1. The test was performed in 966 Chamber No. 6.
 2. The calibrations are traceable to NML/ROC and NIST/USA.
 3. Certificate of Conformance (CoC) which is issued by manufacturer states that the product meets the specification.
 4. Tested Date: 2021/9/29

4.2.4 Test Procedure

- a. Set resolution bandwidth (RBW) = 100kHz
- b. Set the video bandwidth (VBW) $\geq 3 \times$ RBW, Detector = Peak.
- c. Trace mode = max hold.
- d. Sweep = auto couple.
- e. Measure the maximum width of the emission that is constrained by the frequencies associated with the two amplitude points (upper and lower) that are attenuated by 6 dB relative to the maximum level measured in the fundamental emission

4.2.5 Deviation from Test Standard

No deviation.

4.2.6 EUT Operating Conditions

The software provided by client to enable the EUT under transmission condition continuously at lowest, middle and highest channel frequencies individually.

4.2.7 Test Result

Channel	Frequency (GHz)	6dB Bandwidth (GHz)
9	59.4	1.865
10	61.56	2.193
11	63.72	2.799

Spectrum Plot of Worst Value

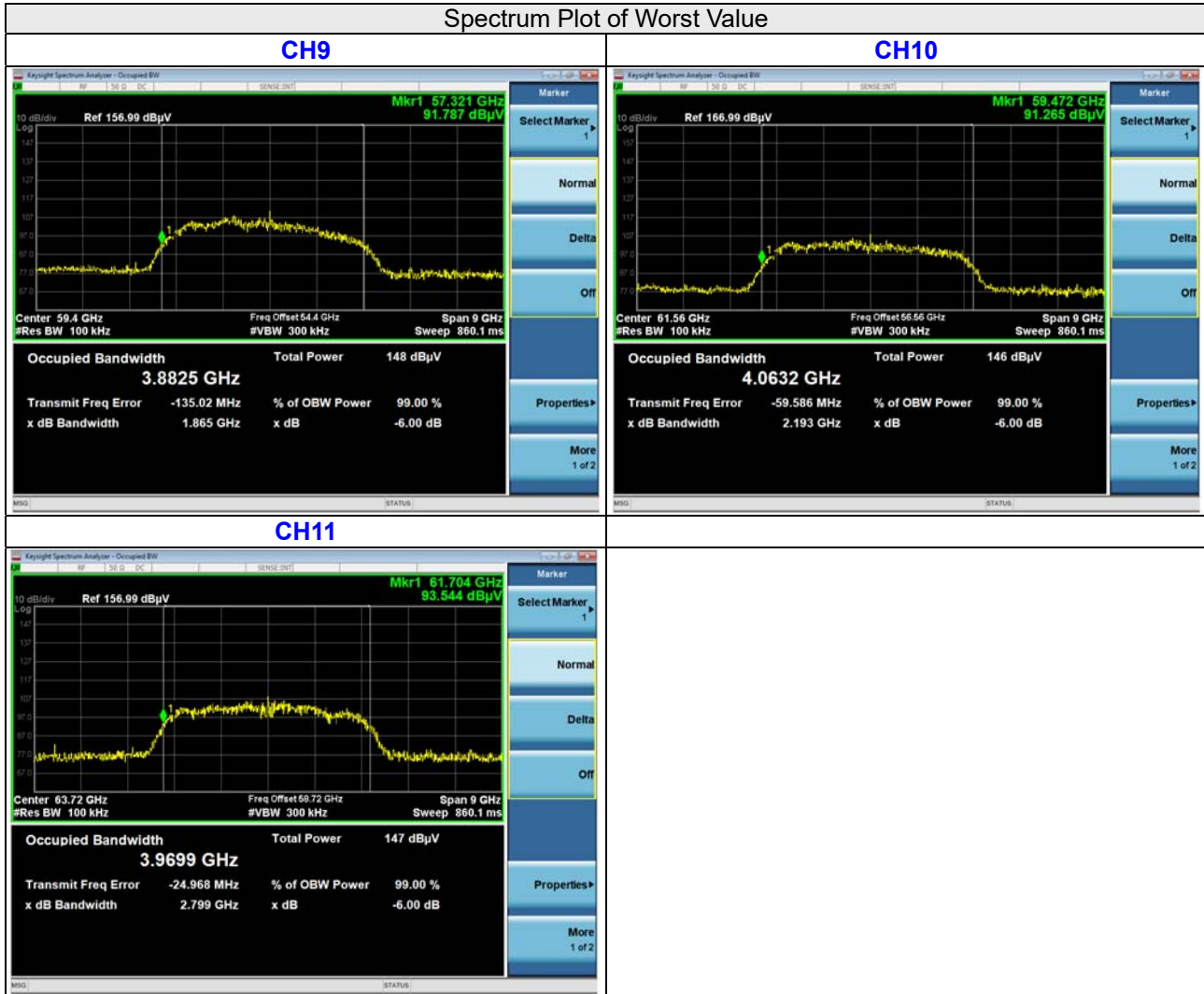

4.3 Output Power Measurement

4.3.1 Limits of Output Power Measurement

15.255 (c) & (e)

Output Power (EIRP)					
Applicable	Type		Average EIRP Power	Peak EIRP Power	
	Fixed field disturbance sensors and short-range devices for interactive motion sensing	(a)	For fixed field disturbance sensors that occupy 500 MHz or less of bandwidth and that are contained wholly within the frequency band 61.0-61.5 GHz	40dBm (*Note 3)	43dBm (*Note 3)
		(b)	For fixed field disturbance sensors other than those operating under the provisions of (a) above, and short-range devices for interactive motion sensing	-	10dBm
V	Products other than fixed field disturbance sensors and short-range devices for interactive motion sensing	(c)	For fixed point-to-point transmitters located outdoors	82dBm (*Note 1)	85dBm (*Note 2)
		(d)	For other devices	40dBm	43dBm

Note:

- The average power of any emission shall not exceed 82 dBm, and shall be reduced by 2 dB for every dB that the antenna gain is less than 51 dBi.
- The peak power of any emission shall not exceed 85 dBm, and shall be reduced by 2 dB for every dB that the antenna gain is less than 51 dBi.
- In addition, the average power of any emission outside of the 61.0-61.5 GHz band, measured during the transmit interval, but still within the 57-71 GHz band, shall not exceed 10 dBm, and the peak power of any emission shall not exceed 13 dBm.

Peak Output Power (Conducted Power)			
Applicable	Type	6dB Bandwidth	Maximum Conducted Power
	For fixed field disturbance sensors other than those operating under the provisions of (a) above, and short-range devices for interactive motion sensing	-	-10 dBm (0.1mW)
V	Other	Greater than or equal to 100 MHz	500mW
		Less than 100MHz	500mW x (B/100)

Note:

- B is 6dB Bandwidth (measured with a 100kHz resolution bandwidth)
- Peak transmitter output power shall be measured with an RF detector that has a detection bandwidth that encompasses the 57-71 GHz band and the has a video bandwidth of at least 10 MHz, or using an equivalent measurement method.
- For purposes of demonstrating compliance with this RSS, corrections to the transmitter output power may be made due to the antenna and circuit loss.

4.3.2 Test Setup

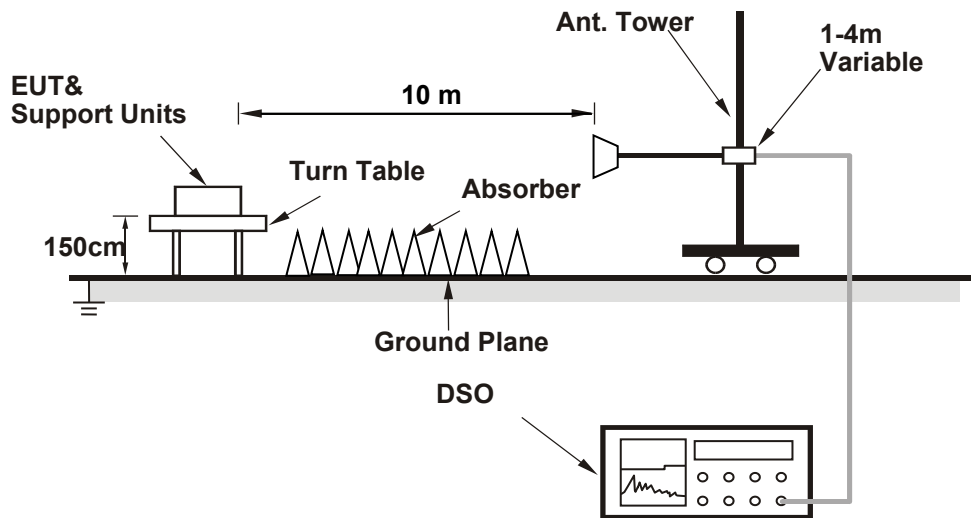

4.3.3 Test Instruments

Description & Manufacturer	Model No.	Serial No.	Calibrated Date	Calibrated Until
Spectrum Analyzer Keysight	N9030A	MY55330160	2021/2/5	2022/2/4
Zero-Bias Detector Vdi	WR15ZBD	WR15R5 1-30	CoC	CoC
4CH Infiniivision Oscilloscope Keysight	DSOX6004A	MY55190202	2021/6/28	2022/6/27
50G~75G Conical Horn Antenna Keysight	WR15CH-Conical Horn Antenna	WR15CH_001	2020/1/20	2022/1/19
N9029AV15-DC9 - 50-75 GHz VDI Standard Downconverter with 9VDC supply Keysight	SA Extension WR15	SAX 381	CoC	CoC
Antenna Tower & Turn Table CT	NA	NA	NA	NA

- Note: 1. The test was performed in 966 Chamber No. 6.
 2. The calibrations are traceable to NML/ROC and NIST/USA.
 3. Certificate of Conformance (CoC) which is issued by manufacturer states that the product meets the specification.
 4. Tested Date: 2021/9/29

4.3.4 Test Procedures

- a. Place the EUT in a continuous transmission mode.
- b. For radiated emission measurements, attach a test receive antenna for the fundamental frequency band to the RF input of an RF detector or a downconverter with an RF detector at the output.
- c. Connect the video output of the detector to the 50 ohm input of the DSO.
- d. Place the test receive antenna in the main beam of the EUT at a distance which will provide a signal within the operating range of the RF detector.
- e. Set the sampling rate of the DSO to the required value. Adjust the memory depth, the triggering and the sweep speed to obtain a display which is representative of the signal considering the type of modulation.
- f. For radiated emission measurements, calculate the distance to the far field boundary of the fundamental emission using following equation

$$R \text{ far field} = (2 * L^2) / \lambda$$

Where:

L is the Largest Antenna Dimension of either the EUT antenna or measurement antenna, including the reflector

λ is the wavelength

Frequency (GHz)	L (m)	Lambda (m)	R (Far Field) (m)
59.4	0.15	0.00505	8.911
61.56	0.15	0.00487	9.24
63.72	0.15	0.00471	9.554

*Measurements made at 10 meter distance.

- g. Perform radiated emission measurements to keep maximize the received signal from the EUT in the far field.
- h. Record the average and peak from the DSO and the measurement distance.
- i. Disconnect the EUT from the RF input port of the instrumentation system.
- j. Connect a mm-wave source to the RF input port of the instrumentation system via a waveguide variable attenuator. The mm-wave source is unmodulated.
- k. Using substitution measurement.
- l. Measure and note the power.
- m. For conducted power measurements, calculate the conducted power using following equation

$$P_{\text{cond}} = \text{EIRP} - G_{\text{dBi}}$$

4.3.5 Deviation from Test Standard

No deviation.

4.3.6 EUT Operating Conditions

Same as Item 4.2.6.

4.3.7 Test Results

For Output Power (EIRP)

Channel	Frequency (GHz)	DSO Value (mV)	Power (dBm)	Gain of Test Antenna (dBi)	E _{Meas} (dB μ V/m)	EIRP Level (dBm)	EIRP Limit (dBm)	Pass/Fail
9	59.4	534.20	-17.19	20.50	135.04	50.34 PK	53.00	Pass
		447.60	-22.99	20.50	129.24	44.54 AV	50.00	Pass
10	61.56	542.20	-15.11	21.40	136.53	51.83 PK	53.00	Pass
		458.30	-21.08	21.40	130.56	45.86 AV	50.00	Pass
11	63.72	515.20	-17.12	21.40	134.82	50.12 PK	53.00	Pass
		442.80	-23.06	21.40	128.88	44.18 AV	50.00	Pass

Note:

1. The measured power level is converted to EIRP using the equation:

Follow ANSI 63.10 section 9.4 Equations to calculate and extrapolate field strength

$$E_{\text{Meas}} \text{ (dB}\mu\text{V/m)} = 126.8 - 20\log(\lambda) + P - G$$

where:

E_{Meas} is the field strength of the emission at the measurement distance, in dB μ V/m

P is the power measured at the output of the test antenna, in dBm

λ is the wavelength of the emission under investigation [300/fMHz], in m

G is the gain of the test antenna, in dBi

Follow ANSI 63.10 section 9.5 Equations to calculate EIRP

$$\text{EIRP Level (dBm/MHz)} = E_{\text{Meas}} \text{ (dB}\mu\text{V/m)} + 20 \cdot \log(d_{\text{Meas}}) - 104.7$$

where:

EIRP is the equivalent isotropically radiated power, in dBm

E_{Meas} is the field strength of the emission at the measurement distance, in dB μ V/m

d_{Meas} is the measurement distance, in m

Measurements made at 10 meter distance.

2. The EIRP was evaluated on vertical and horizontal polarization, the worst case is Vertical polarization.

For Peak Output Power (Conducted Power)

Channel	Frequency (GHz)	EIRP (dBm)	Max. Gain (dBi)	Conducted Output Power (dBm)	Conducted Output Power (mW)	Conducted Output Power limit (mW)	Pass /Fail
9	59.4	50.34	35	15.34	34.20	500	Pass
10	61.56	51.83	35	16.83	48.19	500	Pass
11	63.72	50.12	35	15.12	32.51	500	Pass

5 Pictures of Test Arrangements

Please refer to the attached file (Test Setup Photo).

Appendix – Information of the Testing Laboratories

We, Bureau Veritas Consumer Products Services (H.K.) Ltd., Taoyuan Branch, were founded in 1988 to provide our best service in EMC, Radio, Telecom and Safety consultation. Our laboratories are FCC recognized accredited test firms and accredited according to ISO/IEC 17025.

If you have any comments, please feel free to contact us at the following:

Lin Kou EMC/RF Lab

Tel: 886-2-26052180

Fax: 886-2-26051924

Hsin Chu EMC/RF/Telecom Lab

Tel: 886-3-6668565

Fax: 886-3-6668323

Hwa Ya EMC/RF/Safety Lab

Tel: 886-3-3183232

Fax: 886-3-3270892

Email: service.adt@tw.bureauveritas.com

Web Site: www.bureauveritas-adt.com

The address and road map of all our labs can be found in our web site also.

--- END ---