

## FCC Test Report

**Report No.:** RFBFPJ-WTW-P20120001

**FCC ID:** SWX-AF60HD

**Test Model:** AF60-HD

**Received Date:** Dec. 01, 2020

**Test Date:** Dec. 05 to 09, 2020

**Issued Date:** Jan. 15, 2021

**Applicant:** Ubiquiti Inc.

**Address:** 685 Third Avenue, New York, New York 10017 USA

**Issued By:** Bureau Veritas Consumer Products Services (H.K.) Ltd., Taoyuan Branch  
Hsin Chu Laboratory

**Lab Address:** E-2, No.1, Li Hsin 1st Road, Hsinchu Science Park, Hsinchu City 300,  
Taiwan

**Test Location:** E-2, No.1, Li Hsin 1st Road, Hsinchu Science Park, Hsinchu City 300,  
Taiwan

**FCC Registration /  
Designation Number:** 723255 / TW2022



This report is for your exclusive use. Any copying or replication of this report to or for any other person or entity, or use of our name or trademark, is permitted only with our prior written permission. This report sets forth our findings solely with respect to the test samples identified herein. The results set forth in this report are not indicative or representative of the quality or characteristics of the lot from which a test sample was taken or any similar or identical product unless specifically and expressly noted. Our report includes all of the tests requested by you and the results thereof based upon the information that you provided to us. You have 60 days from date of issuance of this report to notify us of any material error or omission caused by our negligence, provided, however, that such notice shall be in writing and shall specifically address the issue you wish to raise. A failure to raise such issue within the prescribed time shall constitute your unqualified acceptance of the completeness of this report, the tests conducted and the correctness of the report contents. Unless specific mention, the uncertainty of measurement has been explicitly taken into account to declare the compliance or non-compliance to the specification.

## Table of Contents

|   |           |
|---|-----------|
| <b>Release Control Record</b> .....                           | <b>4</b>  |
| <b>1 Certificate of Conformity</b> .....                      | <b>5</b>  |
| <b>2 Summary of Test Results</b> .....                        | <b>6</b>  |
| 2.1 Measurement Uncertainty .....                             | 6         |
| 2.2 Modification Record .....                                 | 6         |
| <b>3 General Information</b> .....                            | <b>7</b>  |
| 3.1 General Description of EUT .....                          | 7         |
| 3.2 Description of Test Modes .....                           | 8         |
| 3.2.1 Test Mode Applicability and Tested Channel Detail ..... | 9         |
| 3.3 Description of Support Units .....                        | 11        |
| 3.3.1 Configuration of System under Test .....                | 12        |
| 3.4 General Description of Applied Standards .....            | 14        |
| <b>4 Test Types and Results</b> .....                         | <b>15</b> |
| 4.1 Radiated Emission Measurement .....                       | 15        |
| 4.1.1 Limits of Radiated Emission Measurement .....           | 15        |
| 4.1.2 Test Instruments .....                                  | 16        |
| 4.1.3 Test Procedures .....                                   | 19        |
| 4.1.4 Deviation from Test Standard .....                      | 20        |
| 4.1.5 Test Setup .....  | 21        |
| 4.1.6 EUT Operating Conditions .....                          | 22        |
| 4.1.7 Test Results .....                                      | 23        |
| 4.2 Conducted Emission Measurement .....                      | 55        |
| 4.2.1 Limits of Conducted Emission Measurement .....          | 55        |
| 4.2.2 Test Instruments .....                                  | 55        |
| 4.2.3 Test Procedures .....                                   | 56        |
| 4.2.4 Deviation from Test Standard .....                      | 56        |
| 4.2.5 Test Setup .....  | 56        |
| 4.2.6 EUT Operating Conditions .....                          | 56        |
| 4.2.7 Test Results .....                                      | 57        |
| 4.3 6dB Bandwidth Measurement .....                           | 65        |
| 4.3.1 Limits of 6dB Bandwidth Measurement .....               | 65        |
| 4.3.2 Test Setup .....  | 65        |
| 4.3.3 Test Instruments .....                                  | 65        |
| 4.3.4 Test Procedure .....                                    | 65        |
| 4.3.5 Deviation from Test Standard .....                      | 65        |
| 4.3.6 EUT Operating Conditions .....                          | 65        |
| 4.3.7 Test Result .....                                       | 66        |
| 4.4 Output Power Measurement .....                            | 67        |
| 4.4.1 Limits of Output Power Measurement .....                | 67        |
| 4.4.2 Test Setup .....  | 68        |
| 4.4.3 Test Instruments .....                                  | 68        |
| 4.4.4 Test Procedures .....                                   | 69        |
| 4.4.5 Deviation from Test Standard .....                      | 69        |
| 4.4.6 EUT Operating Conditions .....                          | 69        |
| 4.4.7 Test Results .....                                      | 70        |
| 4.5 Frequency Stability Measurement .....                     | 71        |
| 4.5.1 Limits of Frequency Stability Measurement .....         | 71        |
| 4.5.2 Test Setup .....  | 71        |
| 4.5.3 Test Instruments .....                                  | 72        |
| 4.5.4 Test Procedure .....                                    | 72        |
| 4.5.5 Deviation from Test Standard .....                      | 72        |
| 4.5.6 EUT Operating Condition .....                           | 72        |
| 4.5.7 Test Results .....                                      | 73        |

|          |   |           |
|----------|---|-----------|
| <b>5</b> | <b>Pictures of Test Arrangements.....</b>                       | <b>74</b> |
|          | <b>Appendix – Information of the Testing Laboratories .....</b> | <b>75</b> |

### Release Control Record

| Issue No.            | Description       | Date Issued   |
|----------------------|-------------------|---------------|
| RFBFPJ-WTW-P20120001 | Original release. | Jan. 15, 2021 |

## 1 Certificate of Conformity

**Product:** airFiber 60 HD

**Brand:** UBIQUITI

**Test Model:** AF60-HD

**Sample Status:** Engineering sample

**Applicant:** Ubiquiti Inc.

**Test Date:** Dec. 05 to 09, 2020

**Standards:** 47 CFR FCC Part 15, Subpart C (Section 15.255)  
ANSI C63.10: 2013

The above equipment has been tested by **Bureau Veritas Consumer Products Services (H.K.) Ltd., Taoyuan Branch**, and found compliance with the requirement of the above standards. The test record, data evaluation & Equipment Under Test (EUT) configurations represented herein are true and accurate accounts of the measurements of the sample's EMC characteristics under the conditions specified in this report.

**Prepared by :**



, **Date:**

Jan. 15, 2021

Joyce Kuo / Specialist

**Approved by :**



, **Date:**

Jan. 15, 2021

Clark Lin / Technical Manager

## 2 Summary of Test Results

| 47 CFR FCC Part 15, Subpart C (Section 15.255) |                             |        |  |
|--|-----------------------------|--------|--|
| FCC Clause                                     | Test Item                   | Result | Remarks  |
| 15.207   | AC Power Conducted Emission | Pass   | Meet the requirement of limit.<br>Minimum passing margin is -4.43 dB at 0.52891 MHz. |
| 15.255(e)                                      | 6dB Bandwidth               | -      | Reference only.  |
| 15.255 (c) & (e)                               | Output Power                | Pass   | Meet the requirement of limit.   |
| 15.255(d)                                      | Spurious Emissions          | Pass   | Meet the requirement of limit.<br>Minimum passing margin is -3.9 dB at 17966.53 MHz. |
| 15.255(f)                                      | Frequency Stability         | Pass   | Meet the requirement of limit.   |

**Note:**

Determining compliance based on the results of the compliance measurement, not taking into account measurement instrumentation uncertainty.

### 2.1 Measurement Uncertainty

Where relevant, the following measurement uncertainty levels have been estimated for tests performed on the EUT as specified in CISPR 16-4-2:

| Measurement                        | Frequency      | Expanded Uncertainty (k=2) ( $\pm$ ) |
|------------------------------------|----------------|--------------------------------------|
| Conducted Emissions at mains ports | 150kHz ~ 30MHz | 1.9 dB                               |
| Radiated Emissions up to 1 GHz     | 9kHz ~ 30MHz   | 3.1 dB                               |
|                                    | 30MHz ~ 1GHz   | 5.4 dB                               |
| Radiated Emissions above 1 GHz     | 1GHz ~ 18GHz   | 5.0 dB                               |
|                                    | 18GHz ~ 40GHz  | 5.3 dB                               |

### 2.2 Modification Record

There were no modifications required for compliance.

### 3 General Information

#### 3.1 General Description of EUT

|                       |  |
|-----------------------|--|
| Product               | airFiber 60 HD   |
| Brand                 | UBIQUITI   |
| Test Model            | AF60-HD  |
| Status of EUT         | Engineering sample   |
| Power Supply Method   | 48 Vdc from PoE  |
| Modulation Type       | $\pi/2$ -BPSK, $\pi/2$ -QPSK, $\pi/2$ -16QAM   |
| Modulation Technology | OFDM   |
| Transfer Rate         | 4620 Mbps  |
| Operating Frequency   | 57 ~ 71 GHz  |
| Output Power (EIRP)   | 58.32 GHz: 50.48 dBm<br>60.48 GHz: 51.14 dBm<br>62.64 GHz: 51.95 dBm<br>64.80 GHz: 50.37 dBm |
| Antenna Type          | Refer to Note  |
| Antenna Connector     | Refer to Note  |
| Accessory Device      | PoE Adapter x 1, power cord x1   |
| Data Cable Supplied   | NA   |

Note:

1. The EUT has below radios as following table:

| Radio 1 | Radio 2       | Radio 3 |
|---------|---------------|---------|
| BT LE   | WiGig (60GHz) | GPS     |

2. Simultaneously transmission condition.

| Condition | Technology |               |
|-----------|------------|---------------|
| 1         | BT LE      | WiGig (60GHz) |

Note: The emission of the simultaneous operation has been evaluated and no non-compliance was found.

3. The EUT must be supplied with a PoE adapter as following table:

| Brand    | Model No.    | Spec.   |
|----------|--------------|---|
| UBIQUITI | GP-H480-065G | AC Input: 100-240 Vac, 0.75A MAX, 50/60Hz<br>DC Output: 48 Vdc, 0.65A<br>AC Input Cable: Unshielded, 0.6m |

4. The antennas type and connector type, please refer to the following table:

| Antenna No.   | Antenna Net Gain (dBi) | Frequency Range | Antenna Type | Connector Type |
|---------------|------------------------|-----------------|--------------|----------------|
| WiGig (60GHz) | 35                     | 57-71GHz        | Dish         | None           |
| BT            | 3                      | 2.4~2.4835GHz   | internal     | None           |

5. The above EUT information is declared by manufacturer and for more detailed features description, please refer to the manufacturer's specifications or user's manual.

6. The above Antenna information is declared by manufacturer and for more detailed features description, please refer to the manufacturer's specifications, the laboratory shall not be held responsible.

### 3.2 Description of Test Modes

4 channels are provided for EUT.

|                  |       |       |       |       |
|------------------|-------|-------|-------|-------|
| Channel's Number | 1     | 2     | 3     | 4     |
| Frequency (MHz)  | 58320 | 60480 | 62640 | 64800 |



### 3.2.1 Test Mode Applicability and Tested Channel Detail

| EUT CONFIGURE MODE | APPLICABLE TO |    |    |    |         |         | DESCRIPTION |
|--------------------|---------------|----|----|----|---------|---------|-------------|
|                    | PLC           | BW | OP | FS | RE < 1G | RE ≥ 1G |             |
| -                  | √             | √  | √  | √  | √       | √       | -           |

Where **PLC**: Power Line Conducted Emission      **BW**: 6dB Bandwidth  
**OP**: Output Power      **FS**: Frequency Stability  
**RE < 1G**: Radiated Emission below 1GHz      **RE ≥ 1G**: Radiated Emission above 1GHz

#### **Power Line Conducted Emission Test:**

- Pre-Scan has been conducted to determine the worst-case mode from all possible combinations between available modulations, data rates and antenna ports (if EUT with antenna diversity architecture).
- Following channel(s) was (were) selected for the final test as listed below.

| AVAILABLE CHANNEL | TESTED CHANNEL | MODULATION TECHNOLOGY | MODULATION TYPE | DATA RATE (Mbps) |
|-------------------|----------------|-----------------------|-----------------|------------------|
| 1 to 4            | 1, 2, 3, 4     | OFDM                  | $\pi/2$ -BPSK   | 385              |

#### **6dB Bandwidth Test:**

- Pre-Scan has been conducted to determine the worst-case mode from all possible combinations between available modulations, data rates and antenna ports (if EUT with antenna diversity architecture).
- Following channel(s) was (were) selected for the final test as listed below.

| AVAILABLE CHANNEL | TESTED CHANNEL | MODULATION TECHNOLOGY | MODULATION TYPE | DATA RATE (Mbps) |
|-------------------|----------------|-----------------------|-----------------|------------------|
| 1 to 4            | 1, 2, 3, 4     | OFDM                  | $\pi/2$ -BPSK   | 385              |

#### **Output Power Measurement:**

- Pre-Scan has been conducted to determine the worst-case mode from all possible combinations between available modulations, data rates and antenna ports (if EUT with antenna diversity architecture).
- Following channel(s) was (were) selected for the final test as listed below.

| AVAILABLE CHANNEL | TESTED CHANNEL | MODULATION TECHNOLOGY | MODULATION TYPE | DATA RATE (Mbps) |
|-------------------|----------------|-----------------------|-----------------|------------------|
| 1 to 4            | 1, 2, 3, 4     | OFDM                  | $\pi/2$ -BPSK   | 385              |

#### **Frequency Stability Test:**

- Following channel(s) was (were) selected for the final test as listed below.

| AVAILABLE CHANNEL | TESTED CHANNEL | MODULATION TECHNOLOGY | MODULATION TYPE | DATA RATE (Mbps) |
|-------------------|----------------|-----------------------|-----------------|------------------|
| 1 to 4            | 1              | OFDM                  | $\pi/2$ -BPSK   | 385              |

### **Radiated Emission Test (Below 1GHz):**

- Pre-Scan has been conducted to determine the worst-case mode from all possible combinations between available modulations, data rates and antenna ports (if EUT with antenna diversity architecture).
- Following channel(s) was (were) selected for the final test as listed below.

| AVAILABLE CHANNEL | TESTED CHANNEL | MODULATION TECHNOLOGY | MODULATION TYPE | DATA RATE (Mbps) |
|-------------------|----------------|-----------------------|-----------------|------------------|
| 1 to 4            | 1, 2, 3, 4     | OFDM                  | $\pi/2$ -BPSK   | 385              |

### **Radiated Emission Test (Above 1GHz):**

- Pre-Scan has been conducted to determine the worst-case mode from all possible combinations between available modulations, data rates and antenna ports (if EUT with antenna diversity architecture).
- Following channel(s) was (were) selected for the final test as listed below.

| AVAILABLE CHANNEL | TESTED CHANNEL | MODULATION TECHNOLOGY | MODULATION TYPE | DATA RATE (Mbps) |
|-------------------|----------------|-----------------------|-----------------|------------------|
| 1 to 4            | 1, 2, 3, 4     | OFDM                  | $\pi/2$ -BPSK   | 385              |

### **Test Condition:**

| APPLICABLE TO | ENVIRONMENTAL CONDITIONS | INPUT POWER  | TESTED BY    |
|---------------|--------------------------|--------------|--------------|
| PLC           | 25 deg. C, 75 %RH        | 120Vac, 60Hz | Ryan Du      |
| BW            | 23 deg. C, 62 %RH        | 120Vac, 60Hz | Sampson Chen |
| OP            | 25 deg. C, 66 %RH        | 120Vac, 60Hz | Sampson Chen |
| FS            | 23 deg. C, 62 %RH        | 120Vac, 60Hz | Sampson Chen |
| RE<1G         | 25 deg. C, 69 %RH        | 120Vac, 60Hz | Ryan Du      |
| RE≥1G         | 25 deg. C, 69 %RH        | 120Vac, 60Hz | Ryan Du      |

### 3.3 Description of Support Units

The EUT has been tested as an independent unit together with other necessary accessories or support units. The following support units or accessories were used to form a representative test configuration during the tests.

| ID | Product | Brand | Model No. | Serial No. | FCC ID  | Remarks         |
|----|---------|-------|-----------|------------|---------|-----------------|
| A. | Laptop  | DELL  | E5430     | HYV4VY1    | FCC DoC | Provided by Lab |

Note:

1. All power cords of the above support units are non-shielded (1.8m).

| ID | Descriptions | Qty. | Length (m) | Shielding (Yes/No) | Cores (Qty.) | Remarks            |
|----|--------------|------|------------|--------------------|--------------|--------------------|
| 1. | RJ-45 Cable  | 1    | 3          | No                 | 0            | Provided by Lab    |
| 2. | RJ-45 Cable  | 1    | 10         | No                 | 0            | Provided by Lab    |
| 3. | AC Cable     | 1    | 0.6        | No                 | 0            | Supplied by client |
| 4. | Fiber Cable  | 1    | 10         | Yes                | 0            | Provided by Lab    |

### 3.3.1 Configuration of System under Test

For Power Line Conducted Emission Test:

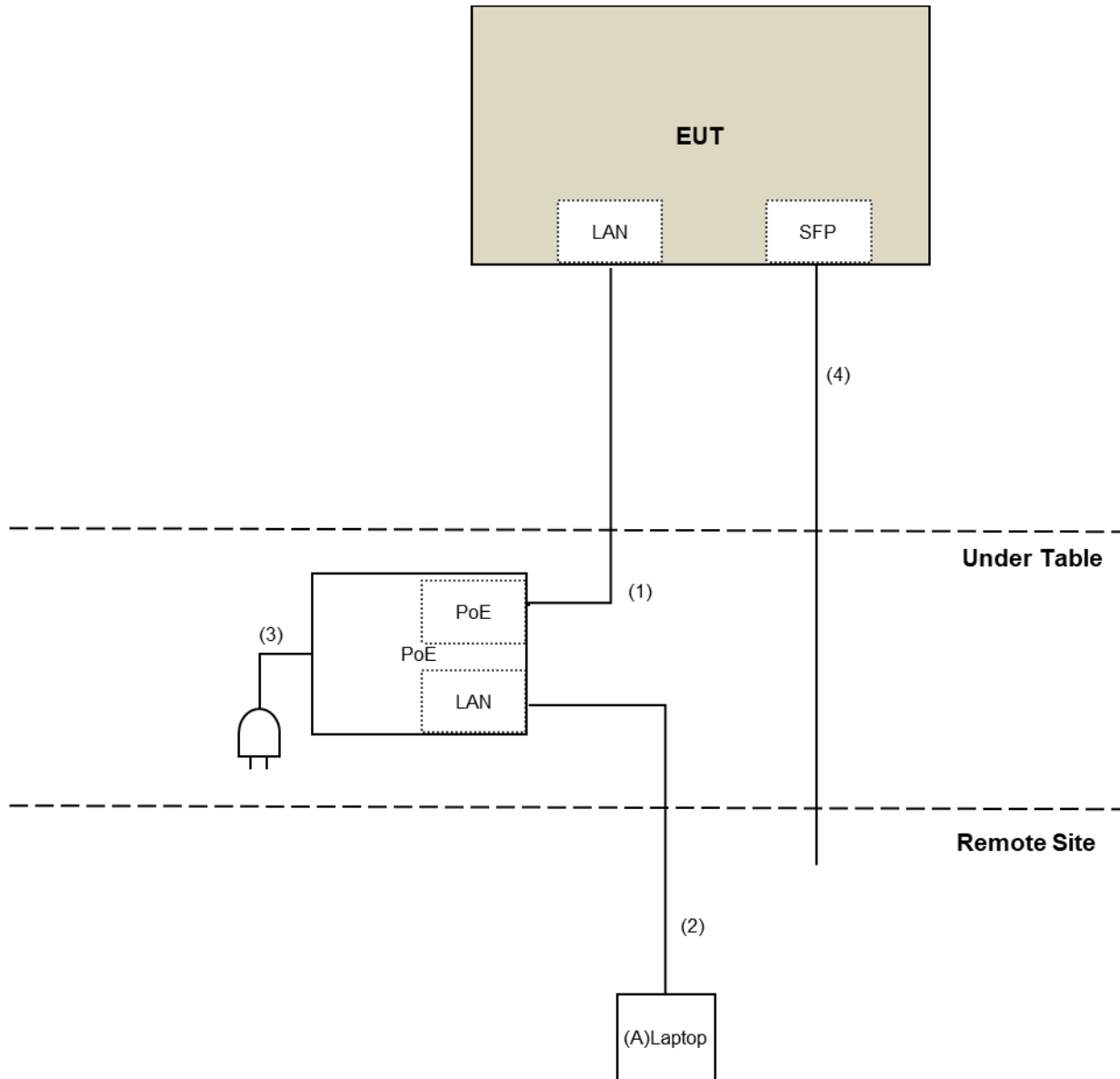

For Radiated Emission Test:

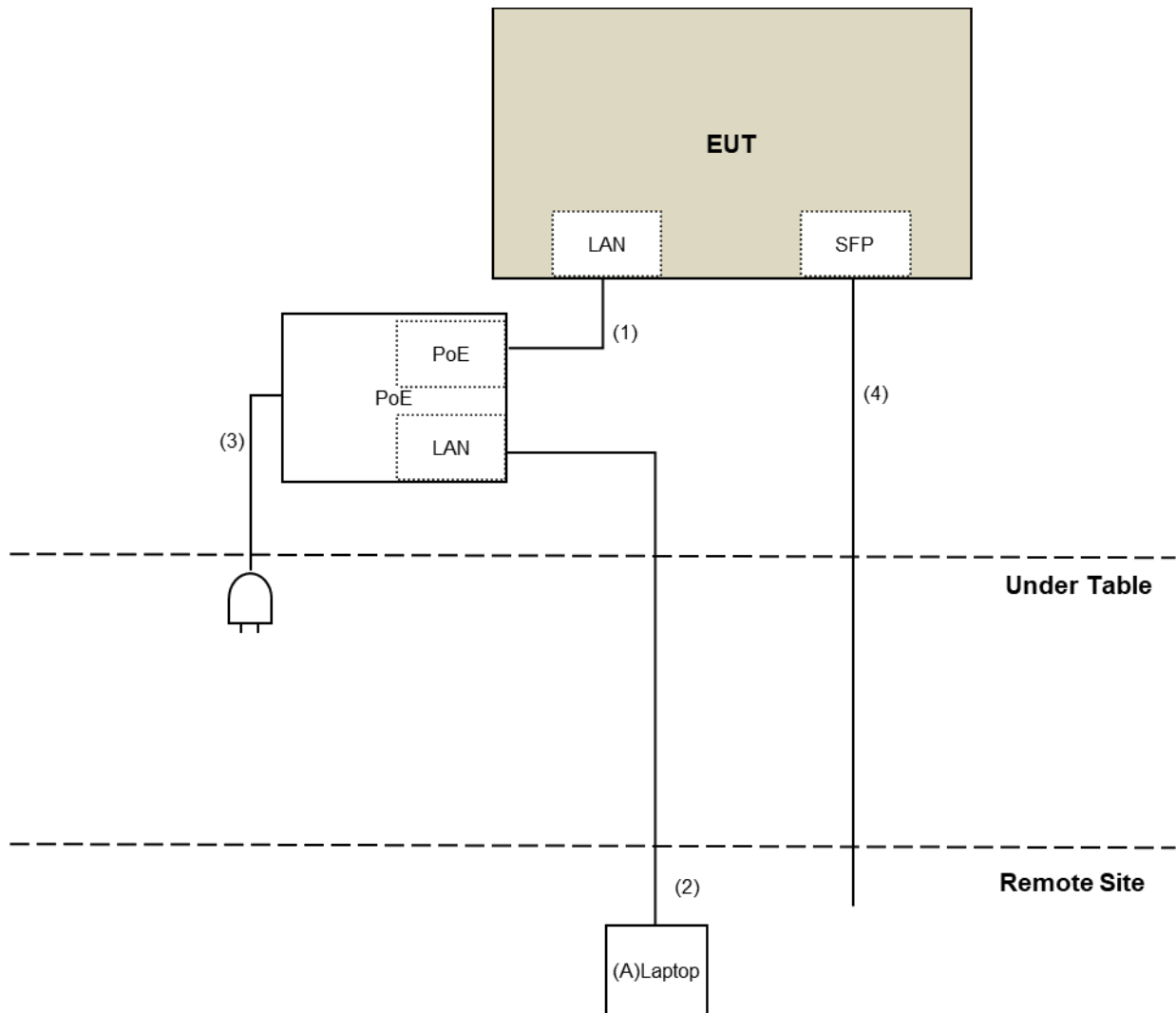

### 3.4 General Description of Applied Standards

The EUT is a RF Product. According to the specifications of the manufacturer, it must comply with the requirements of the following standards:

**FCC Part 15, Subpart C (15.255)**

**ANSI C63.10-2013**

All test items have been performed and recorded as per the above standards.

## 4 Test Types and Results

### 4.1 Radiated Emission Measurement

#### 4.1.1 Limits of Radiated Emission Measurement

| Spurious Emission              |                                   |
|--------------------------------|-----------------------------------|
| Frequency Range                | Limitation                        |
| Radiated emissions below 40GHz | Part 15.209                       |
| Between 40GHz and 200GHz       | 90pW/cm <sup>2</sup> (at 3 meter) |

Note:  
The levels of the spurious emissions shall not exceed the level of the fundamental emission

Emissions radiated outside of the specified bands, shall be according to the general radiated limits in 15.209 as following:

| Frequencies (MHz) | Field strength (microvolts/meter) | Measurement distance (meters) |
|-------------------|-----------------------------------|-------------------------------|
| 0.009-0.490       | 2400/F(kHz)                       | 300                           |
| 0.490-1.705       | 24000/F(kHz)                      | 30                            |
| 1.705-30.0        | 30                                | 30                            |
| 30-88             | 100                               | 3                             |
| 88-216            | 150                               | 3                             |
| 216-960           | 200                               | 3                             |
| Above 960         | 500                               | 3                             |

**Note:**

1. The lower limit shall apply at the transition frequencies.
2. Emission level (dBuV/m) = 20 log Emission level (uV/m).
3. As shown in 15.35(b), for frequencies above 1000MHz, the field strength limits are based on average detector, however, the peak field strength of any emission shall not exceed the maximum permitted average limits, specified above by more than 20dB under any condition of modulation.
4. Section 15.205 restricted bands of operation shall compliance with the limits in Section 15.209.

## 4.1.2 Test Instruments

**For Below 40GHz:**

| DESCRIPTION & MANUFACTURER                 | MODEL NO.            | SERIAL NO.  | CALIBRATED DATE | CALIBRATED UNTIL |
|--|----------------------|-------------|-----------------|------------------|
| Test Receiver<br>Keysight                  | N9038A               | MY54450088  | July 06, 2020   | July 05, 2021    |
| Pre-Amplifier<br>EMCI                      | EMC001340            | 980142      | May 25, 2020    | May 24, 2021     |
| Loop Antenna<br>Electro-Metrics            | EM-6879              | 264         | Feb. 18, 2020   | Feb. 17, 2021    |
| RF Cable                                   | NA                   | LOOPCAB-001 | Jan. 08, 2020   | Jan. 07, 2021    |
| RF Cable                                   | NA                   | LOOPCAB-002 | Jan. 08, 2020   | Jan. 07, 2021    |
| Pre-Amplifier<br>Mini-Circuits             | ZFL-1000VH2B         | AMP-ZFL-05  | Apr. 28, 2020   | Apr. 27, 2021    |
| Trilog Broadband<br>Antenna<br>SCHWARZBECK | VULB 9168            | 9168-361    | Nov. 05, 2020   | Nov. 04, 2021    |
| RF Cable                                   | 8D                   | 966-3-1     | Mar. 17, 2020   | Mar. 16, 2021    |
| RF Cable                                   | 8D                   | 966-3-2     | Mar. 17, 2020   | Mar. 16, 2021    |
| RF Cable                                   | 8D                   | 966-3-3     | Mar. 17, 2020   | Mar. 16, 2021    |
| Fixed attenuator<br>Mini-Circuits          | UNAT-5+              | PAD-3m-3-01 | Sep. 24, 2020   | Sep. 23, 2021    |
| Horn_Antenna<br>SCHWARZBECK                | BBHA9120-D           | 9120D-406   | Nov. 22, 2020   | Nov. 21, 2021    |
| Pre-Amplifier<br>EMCI                      | EMC12630SE           | 980384      | Jan. 15, 2020   | Jan. 14, 2021    |
| RF Cable                                   | EMC104-SM-SM-1500    | 180504      | Apr. 29, 2020   | Apr. 28, 2021    |
| RF Cable                                   | EMC104-SM-SM-2000    | 180601      | June 09, 2020   | June 08, 2021    |
| RF Cable                                   | EMC104-SM-SM-6000    | 180602      | June 09, 2020   | June 08, 2021    |
| Spectrum Analyzer<br>Keysight              | N9030A               | MY54490679  | July 13, 2020   | July 12, 2021    |
| Pre-Amplifier<br>EMCI                      | EMC184045SE          | 980387      | Jan. 15, 2020   | Jan. 14, 2021    |
| Horn_Antenna<br>SCHWARZBECK                | BBHA 9170            | BBHA9170519 | Nov. 22, 2020   | Nov. 21, 2021    |
| RF Cable                                   | EMC102-KM-KM-1200    | 160924      | Jan. 15, 2020   | Jan. 14, 2021    |
| RF Cable                                   | EMC-KM-KM-4000       | 200214      | Mar. 11, 2020   | Mar. 10, 2021    |
| Software                                   | ADT_Radiated_V8.7.08 | NA          | NA              | NA               |
| Antenna Tower & Turn<br>Table<br>Max-Full  | MF-7802              | MF780208406 | NA              | NA               |
| Boresight Antenna<br>Fixture               | FBA-01               | FBA-SIP01   | NA              | NA               |

**Note:**

1. The calibration interval of the above test instruments is 12 months and the calibrations are traceable to NML/ROC and NIST/USA.
2. The test was performed in 966 Chamber No. 3.
3. Tested Date: Dec. 05, 2020



**For Above 40GHz:**

| DESCRIPTION & MANUFACTURER   | MODEL NO.          | SERIAL NO.  | CALIBRATED DATE | CALIBRATED UNTIL |
|--|--------------------|-------------|-----------------|------------------|
| Spectrum Analyzer<br>Keysight  | N9030A             | MY55330160  | Feb. 07, 2020   | Feb. 06, 2021    |
| *OXE89 Horn Antenna<br>(33~55GHz)<br>QuinStar  | QWH-UCRR00         | 924200002   | Jan. 20, 2020   | Jan. 19, 2022    |
| *Conical Horn Antenna<br>(50~75GHz)<br>Keysight  | WR15CH-Conical     | WR15CH_001  | Jan. 20, 2020   | Jan. 19, 2022    |
| *Conical Horn Antenna<br>(75~110GHz)<br>Keysight   | WR10CH-Conical     | WR10CH_001  | Jan. 20, 2020   | Jan. 19, 2022    |
| *Conical Horn Antenna<br>(110~170GHz)<br>Keysight  | WR6.5CH-Conical    | WR6.5CH_001 | Jan. 20, 2020   | Jan. 19, 2022    |
| *Conical Horn Antenna<br>(140~220GHz)<br>Keysight  | WR5.1CH-Conical    | WR5.1CH_001 | Dec. 09, 2019   | Dec. 08, 2021    |
| N9029AV15-DC9 - 50-75<br>GHz VDI Standard<br>Downconverter with 9VDC<br>supply<br>Keysight     | SA Extension WR15  | SAX 381     | CoC             | CoC              |
| N9029AV10-DC9 - 75-110<br>GHz VDI Standard<br>Downconverter with 9VDC<br>supply<br>Keysight    | SA Extension WR10  | SAX 378     | CoC             | CoC              |
| N9029AV06-DC9 -<br>110-170 GHz VDI<br>Standard Downconverter<br>with 9VDC supply<br>Keysight   | SA Extension WR6.5 | SAX 377     | CoC             | CoC              |
| *N9029AV05-DC9 -<br>140-220 GHz VDI<br>Standard Downconverter<br>with 9VDC supply<br>Keysight  | SA Extension WR5.1 | SAX 375     | Dec. 09, 2019   | Dec. 08, 2021    |
| Millimeter-Wave Signal<br>Generator Frequency<br>Extension Module (50~75<br>GHz)<br>Keysight   | E8257DV15          | SGX 050     | CoC             | CoC              |
| Millimeter-Wave Signal<br>Generator Frequency<br>Extension Module (75~110<br>GHz)<br>Keysight  | E8257DV10          | SGX 069     | CoC             | CoC              |
| Millimeter-Wave Signal<br>Generator Frequency<br>Extension Module<br>(110~170 GHz)<br>Keysight | E8257DV06-DC9      | SGX 223     | CoC             | CoC              |
| PSG analog signal<br>generator<br>Keysight   | E8257D             | MY53401987  | June 17, 2020   | June 16, 2021    |

|   |           |             |               |               |
|---|-----------|-------------|---------------|---------------|
| *Power Meter<br>VDI                                 | PM5       | 431V        | Dec. 09, 2019 | Dec. 08, 2021 |
| Boresight Antenna Tower<br>& Turn Table<br>Max-Full | MF-7802BS | MF780208530 | NA            | NA            |
| **Zero-Bias Detector<br>(50~75GHz)<br>Vdi           | WR15ZBD   | WR15R5 1-30 | CoC           | CoC           |
| 4CH Infiniivision<br>Oscilloscope<br>Keysight       | DSOX6004A | MY55190202  | July 03, 2020 | July 02, 2021 |

**Note:**

1. The calibration interval of the above test instruments is 12 months and the calibrations are traceable to NML/ROC and NIST/USA.
2. \*The calibration interval of the above test instruments is 24 months and the calibrations are traceable to NML/ROC and NIST/USA.
3. \*\*The calibration interval of the above test instruments is 36 months and the calibrations are traceable to NML/ROC and NIST/USA.
4. Certificate of Conformance (CoC) which is issued by manufacturer states that the product meets the specification.
5. The test was performed in 966 Chamber No. 3.
6. Tested Date: Dec. 05, 2020

#### 4.1.3 Test Procedures

##### **For Radiated emission below 30MHz**

- a. The EUT was placed on the top of a rotating table 0.8 meters above the ground at a 3 meter chamber room. The table was rotated 360 degrees to determine the position of the highest radiation.
- b. The EUT was set 3 meters away from the interference-receiving antenna, which was mounted on the top of a variable-height antenna tower.
- c. Parallel, perpendicular, and ground-parallel orientations of the antenna are set to make the measurement.
- d. For each suspected emission, the EUT was arranged to its worst case and the rotatable table was turned from 0 degrees to 360 degrees to find the maximum reading.
- e. The test-receiver system was set to Quasi-Peak Detect Function and Specified Bandwidth with Maximum Hold Mode.

##### **Note:**

1. The resolution bandwidth and video bandwidth of test receiver/spectrum analyzer is 9kHz at frequency below 30MHz.

##### **For Radiated emission 30MHz to 40GHz**

- a. The EUT was placed on the top of a rotating table 0.8 meters (for 30MHz ~ 1GHz) / 1.5 meters (for above 1GHz) above the ground at 3 meter chamber room for test. The table was rotated 360 degrees to determine the position of the highest radiation.
- b. The EUT was set 3 meters away from the interference-receiving antenna, which was mounted on the top of a variable-height antenna tower.
- c. The height of antenna is varied from one meter to four meters above the ground to determine the maximum value of the field strength. Both horizontal and vertical polarizations of the antenna are set to make the measurement.
- d. For each suspected emission, the EUT was arranged to its worst case and then the antenna was tuned to heights from 1 meter to 4 meters and the rotatable table was turned from 0 degrees to 360 degrees to find the maximum reading.
- e. The test-receiver system was set to quasi-peak detect function and specified bandwidth with maximum hold mode when the test frequency is below 1 GHz.
- f. The test-receiver system was set to peak and average detects function and specified bandwidth with maximum hold mode when the test frequency is above 1 GHz. If the peak reading value also meets average limit, measurement with the average detector is unnecessary.

##### **Note:**

1. The resolution bandwidth and video bandwidth of test receiver/spectrum analyzer is 120kHz for Quasi-peak detection (QP) at frequency below 1GHz.
2. The resolution bandwidth of test receiver/spectrum analyzer is 1 MHz and the video bandwidth is 3 MHz for Peak detection (PK) and Average detection (AV) at frequency above 1GHz.
3. All modes of operation were investigated and the worst-case emissions are reported.

#### For Radiated emission above 40GHz

- a. Connect the test antenna covering the appropriate frequency range to a spectrum analyzer via an external mixer to the spectrum analyzer.
- b. Set spectrum analyzer RBW = 1 MHz, VBW = 3 MHz, average detector.
- c. Calculate the distance to the far field boundary and determine the maximum measurement distance.
- d. Perform an exploratory search for emissions and determine the approximate direction at which each observed emission emanates from the EUT.
- e. Exploratory measurements be made at a closer distance than the validated maximum measurement distance.
- f. Perform a final measurement; begin with the test antenna at the approximate position where the maximum level occurred during the exploratory scan.
- g. Slowly scan the test antenna around this position, slowly vary the test antenna polarization by rotating through at least 0° to 180°, and slowly vary the orientation of the test antenna to find the final position, polarization, and orientation at which the maximum level of the emission is observed.
- h. Record the measured reading with the test antenna fixed at this maximized position, polarization, and orientation. Record the measurement distance.
- i. Calculate the maximum field strength of the emission at the measurement distance and the adjusted/corrected power at the output of the test antenna.
- j. Calculate the EIRP from the measured field strength and then convert to the linear.
- k. Calculate the power density at the distance specified by the limit from the field strength at the distance specified by the limit.
- l. Repeat the preceding sequence for every emission observed in the frequency band under investigation.

#### 4.1.4 Deviation from Test Standard

No deviation.

#### 4.1.5 Test Setup

##### For Radiated emission below 30MHz

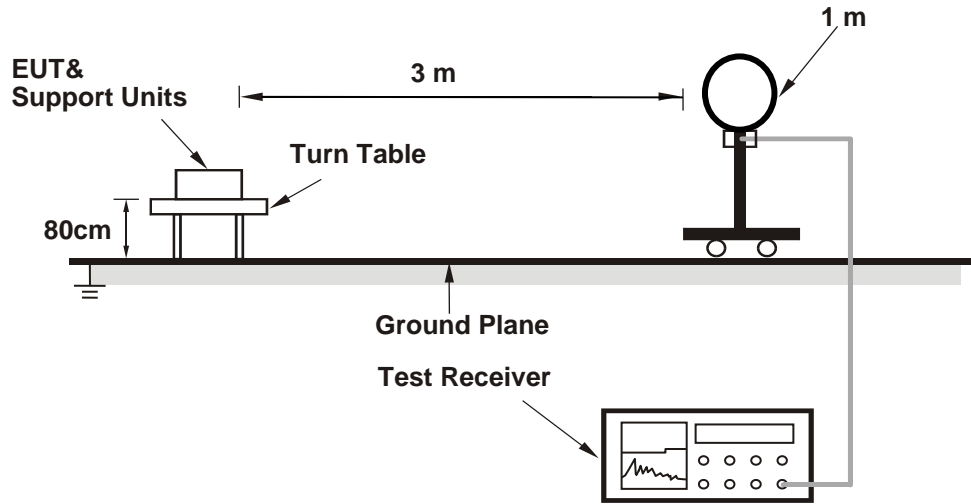

##### For Radiated emission 30MHz to 1GHz

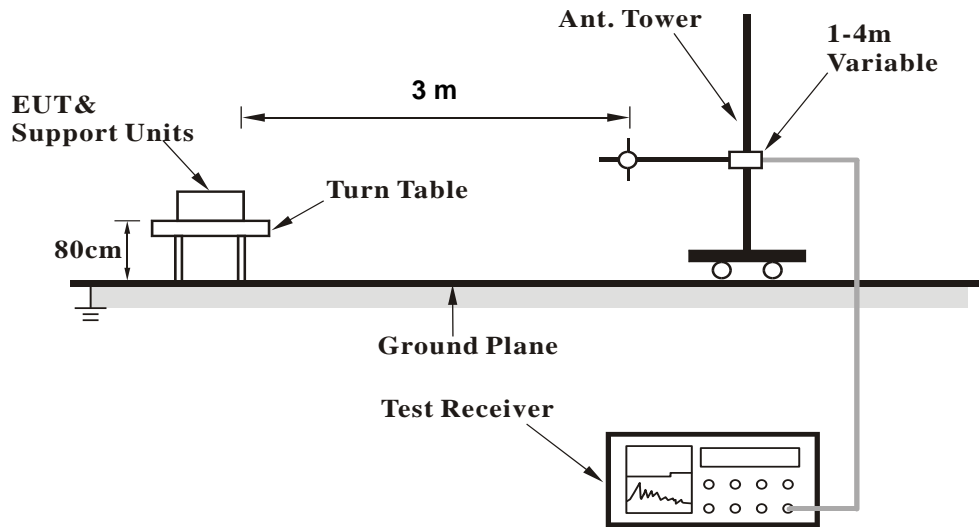

**For Radiated emission 1GHz to 50GHz**

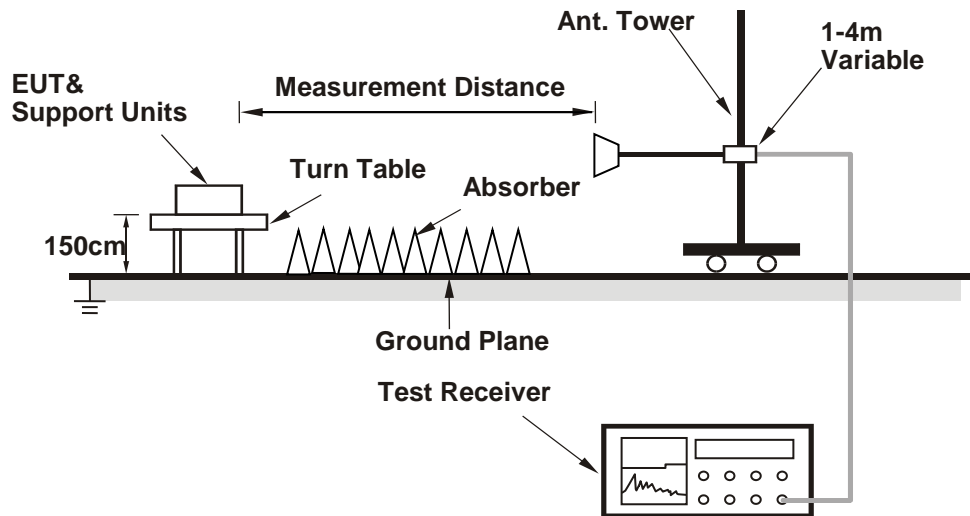

**For Radiated emission above 50GHz**

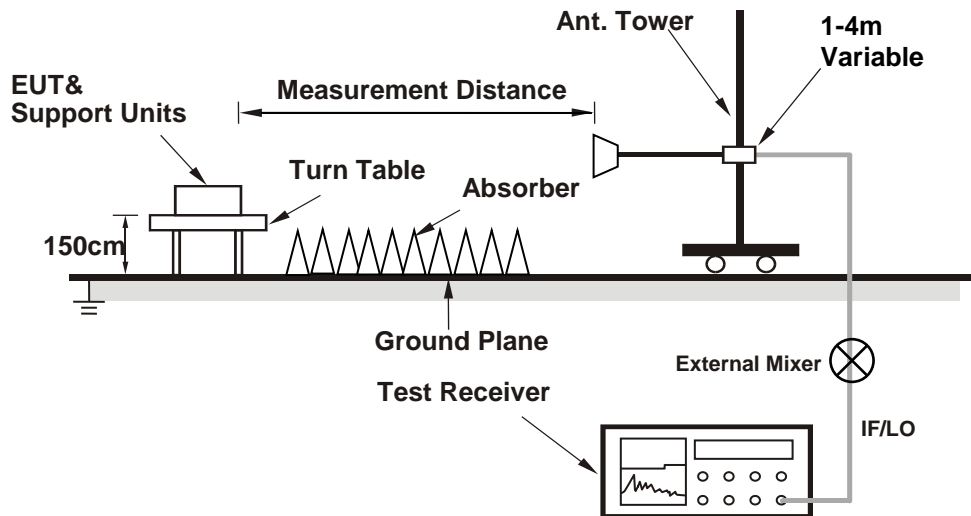

For the actual test configuration, please refer to the attached file (Test Setup Photo).

**4.1.6 EUT Operating Conditions**

- a. Placed the EUT on the testing table.
- b. Controlling software (Qualcomm Radio Control Toolkit v4.0-00158) has been activated to set the EUT under transmission condition continuously at specific channel frequency.

#### 4.1.7 Test Results

Above 1GHz Data:  
 For 1~18 GHz

|                        |                  |                          |                           |
|------------------------|------------------|--------------------------|---------------------------|
| <b>Channel</b>         | CH 1 : 58.32 GHz |                          |                           |
| <b>Frequency Range</b> | 1GHz ~ 18GHz     | <b>Detector Function</b> | Peak (PK)<br>Average (AV) |

| Antenna Polarity & Test Distance : Horizontal at 3 m |                 |                         |                |             |                    |                      |                  |                          |
|--|-----------------|-------------------------|----------------|-------------|--------------------|----------------------|------------------|--------------------------|
| No   | Frequency (MHz) | Emission Level (dBuV/m) | Limit (dBuV/m) | Margin (dB) | Antenna Height (m) | Table Angle (Degree) | Raw Value (dBuV) | Correction Factor (dB/m) |
| 1  | #2429.41        | 44.0 PK                 | 74.0           | -30.0       | 1.50 H             | 244                  | 45.5             | -1.5                     |
| 2  | #2429.41        | 34.6 AV                 | 54.0           | -19.4       | 1.50 H             | 244                  | 36.1             | -1.5                     |
| 3  | 7497.24         | 46.0 PK                 | 74.0           | -28.0       | 2.50 H             | 296                  | 36.1             | 9.9                      |
| 4  | 7497.24         | 35.7 AV                 | 54.0           | -18.3       | 2.50 H             | 296                  | 25.8             | 9.9                      |
| 5  | 17966.53        | 59.9 PK                 | 74.0           | -14.1       | 3.50 H             | 305                  | 37.0             | 22.9                     |
| 6  | 17966.53        | 50.1 AV                 | 54.0           | -3.9        | 3.50 H             | 305                  | 27.2             | 22.9                     |

#### Remarks:

1. Emission Level(dBuV/m) = Raw Value(dBuV) + Correction Factor(dB/m)
2. Correction Factor(dB/m) = Antenna Factor(dB/m) + Cable Factor(dB) – Pre-Amplifier Factor(dB)
3. Margin value = Emission Level – Limit value
4. The other emission levels were very low against the limit.
5. "#": The radiated frequency is out of the restricted band.

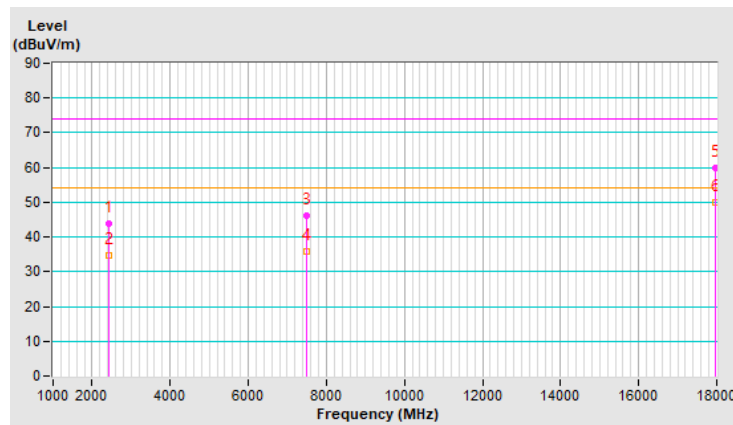

|                        |                  |                          |                           |
|------------------------|------------------|--------------------------|---------------------------|
| <b>Channel</b>         | CH 1 : 58.32 GHz |                          |                           |
| <b>Frequency Range</b> | 1GHz ~ 18GHz     | <b>Detector Function</b> | Peak (PK)<br>Average (AV) |

| Antenna Polarity & Test Distance : Vertical at 3 m |                 |                         |                |             |                    |                      |                  |                          |
|--|-----------------|-------------------------|----------------|-------------|--------------------|----------------------|------------------|--------------------------|
| No   | Frequency (MHz) | Emission Level (dBuV/m) | Limit (dBuV/m) | Margin (dB) | Antenna Height (m) | Table Angle (Degree) | Raw Value (dBuV) | Correction Factor (dB/m) |
| 1  | 2484.39         | 42.0 PK                 | 74.0           | -32.0       | 3.50 V             | 19                   | 43.4             | -1.4                     |
| 2  | 2484.39         | 32.8 AV                 | 54.0           | -21.2       | 3.50 V             | 19                   | 34.2             | -1.4                     |
| 3  | 3663.28         | 45.4 PK                 | 74.0           | -28.6       | 3.00 V             | 44                   | 44.4             | 1.0                      |
| 4  | 3663.28         | 36.6 AV                 | 54.0           | -17.4       | 3.00 V             | 44                   | 35.6             | 1.0                      |
| 5  | 17979.29        | 60.1 PK                 | 74.0           | -13.9       | 1.00 V             | 218                  | 37.2             | 22.9                     |
| 6  | 17979.29        | 49.7 AV                 | 54.0           | -4.3        | 1.00 V             | 218                  | 26.8             | 22.9                     |

**Remarks:**

1. Emission Level(dBuV/m) = Raw Value(dBuV) + Correction Factor(dB/m)
2. Correction Factor(dB/m) = Antenna Factor(dB/m) + Cable Factor(dB) – Pre-Amplifier Factor(dB)
3. Margin value = Emission Level – Limit value
4. The other emission levels were very low against the limit.

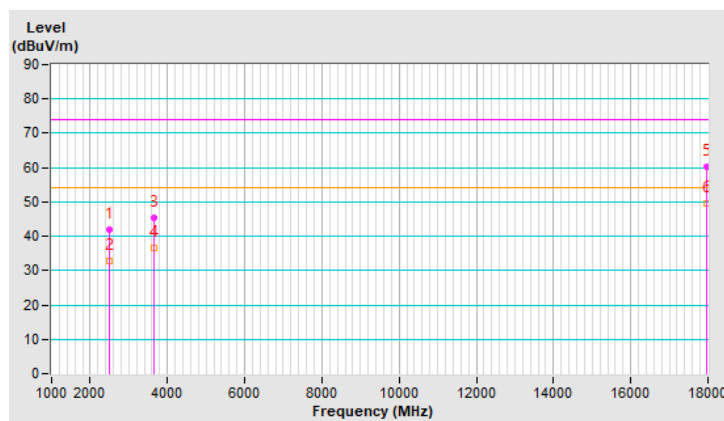



|                        |                  |                          |                           |
|------------------------|------------------|--------------------------|---------------------------|
| <b>Channel</b>         | CH 2 : 60.48 GHz |                          |                           |
| <b>Frequency Range</b> | 1GHz ~ 18GHz     | <b>Detector Function</b> | Peak (PK)<br>Average (AV) |

| Antenna Polarity & Test Distance : Horizontal at 3 m |                 |                         |                |             |                    |                      |                  |                          |
|--|-----------------|-------------------------|----------------|-------------|--------------------|----------------------|------------------|--------------------------|
| No   | Frequency (MHz) | Emission Level (dBuV/m) | Limit (dBuV/m) | Margin (dB) | Antenna Height (m) | Table Angle (Degree) | Raw Value (dBuV) | Correction Factor (dB/m) |
| 1  | #2431.35        | 44.1 PK                 | 74.0           | -29.9       | 1.50 H             | 232                  | 45.6             | -1.5                     |
| 2  | #2431.35        | 34.6 AV                 | 54.0           | -19.4       | 1.50 H             | 232                  | 36.1             | -1.5                     |
| 3  | 7503.38         | 46.0 PK                 | 74.0           | -28.0       | 2.50 H             | 316                  | 36.1             | 9.9                      |
| 4  | 7503.38         | 35.6 AV                 | 54.0           | -18.4       | 2.50 H             | 316                  | 25.7             | 9.9                      |
| 5  | 17959.38        | 59.8 PK                 | 74.0           | -14.2       | 3.50 H             | 293                  | 37.0             | 22.8                     |
| 6  | 17959.38        | 50.0 AV                 | 54.0           | -4.0        | 3.50 H             | 293                  | 27.2             | 22.8                     |

**Remarks:**

1. Emission Level(dBuV/m) = Raw Value(dBuV) + Correction Factor(dB/m)
2. Correction Factor(dB/m) = Antenna Factor(dB/m) + Cable Factor(dB) – Pre-Amplifier Factor(dB)
3. Margin value = Emission Level – Limit value
4. The other emission levels were very low against the limit.
5. " # ": The radiated frequency is out of the restricted band.

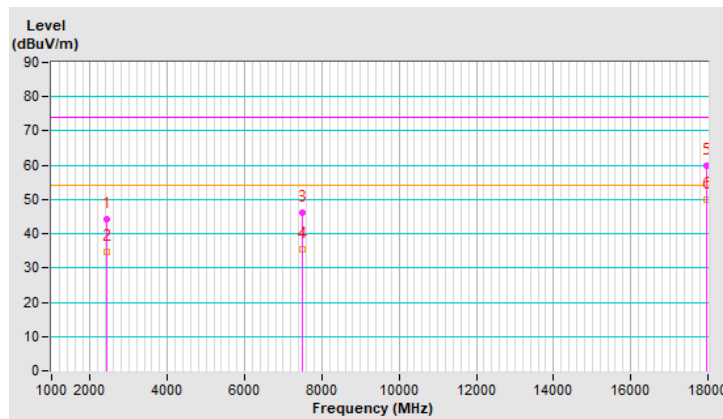

|                        |                  |                          |                           |
|------------------------|------------------|--------------------------|---------------------------|
| <b>Channel</b>         | CH 2 : 60.48 GHz |                          |                           |
| <b>Frequency Range</b> | 1GHz ~ 18GHz     | <b>Detector Function</b> | Peak (PK)<br>Average (AV) |

| Antenna Polarity & Test Distance : Vertical at 3 m |                 |                         |                |             |                    |                      |                  |                          |
|--|-----------------|-------------------------|----------------|-------------|--------------------|----------------------|------------------|--------------------------|
| No   | Frequency (MHz) | Emission Level (dBuV/m) | Limit (dBuV/m) | Margin (dB) | Antenna Height (m) | Table Angle (Degree) | Raw Value (dBuV) | Correction Factor (dB/m) |
| 1  | 2488.37         | 42.2 PK                 | 74.0           | -31.8       | 3.50 V             | 36                   | 43.6             | -1.4                     |
| 2  | 2488.37         | 32.9 AV                 | 54.0           | -21.1       | 3.50 V             | 36                   | 34.3             | -1.4                     |
| 3  | 3665.13         | 45.5 PK                 | 74.0           | -28.5       | 3.00 V             | 68                   | 44.5             | 1.0                      |
| 4  | 3665.13         | 36.7 AV                 | 54.0           | -17.3       | 3.00 V             | 68                   | 35.7             | 1.0                      |
| 5  | 17982.83        | 60.0 PK                 | 74.0           | -14.0       | 1.00 V             | 234                  | 37.1             | 22.9                     |
| 6  | 17982.83        | 49.6 AV                 | 54.0           | -4.4        | 1.00 V             | 234                  | 26.7             | 22.9                     |

**Remarks:**

1. Emission Level(dBuV/m) = Raw Value(dBuV) + Correction Factor(dB/m)
2. Correction Factor(dB/m) = Antenna Factor(dB/m) + Cable Factor(dB) – Pre-Amplifier Factor(dB)
3. Margin value = Emission Level – Limit value
4. The other emission levels were very low against the limit.

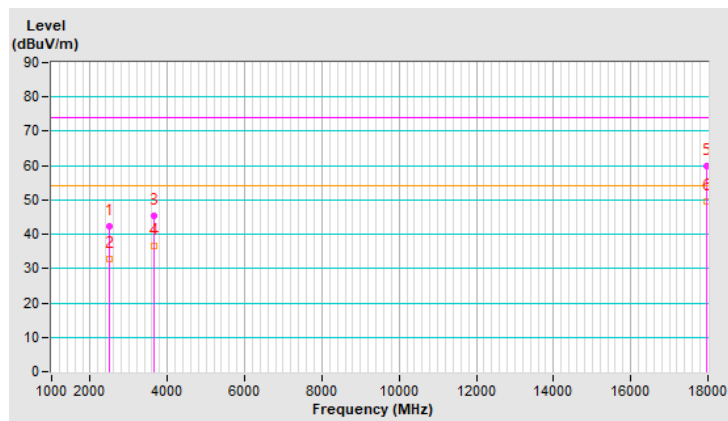

|                        |                  |                          |                           |
|------------------------|------------------|--------------------------|---------------------------|
| <b>Channel</b>         | CH 3 : 62.64 GHz |                          |                           |
| <b>Frequency Range</b> | 1GHz ~ 18GHz     | <b>Detector Function</b> | Peak (PK)<br>Average (AV) |

| Antenna Polarity & Test Distance : Horizontal at 3 m |                 |                         |                |             |                    |                      |                  |                          |
|--|-----------------|-------------------------|----------------|-------------|--------------------|----------------------|------------------|--------------------------|
| No   | Frequency (MHz) | Emission Level (dBuV/m) | Limit (dBuV/m) | Margin (dB) | Antenna Height (m) | Table Angle (Degree) | Raw Value (dBuV) | Correction Factor (dB/m) |
| 1  | #2434.29        | 44.2 PK                 | 74.0           | -29.8       | 1.50 H             | 272                  | 45.7             | -1.5                     |
| 2  | #2434.29        | 34.5 AV                 | 54.0           | -19.5       | 1.50 H             | 272                  | 36.0             | -1.5                     |
| 3  | 7507.29         | 45.9 PK                 | 74.0           | -28.1       | 2.50 H             | 276                  | 36.0             | 9.9                      |
| 4  | 7507.29         | 35.5 AV                 | 54.0           | -18.5       | 2.50 H             | 276                  | 25.6             | 9.9                      |
| 5  | 17954.68        | 59.8 PK                 | 74.0           | -14.2       | 3.50 H             | 276                  | 37.1             | 22.7                     |
| 6  | 17954.68        | 49.9 AV                 | 54.0           | -4.1        | 3.50 H             | 276                  | 27.2             | 22.7                     |

**Remarks:**

1. Emission Level(dBuV/m) = Raw Value(dBuV) + Correction Factor(dB/m)
2. Correction Factor(dB/m) = Antenna Factor(dB/m) + Cable Factor(dB) – Pre-Amplifier Factor(dB)
3. Margin value = Emission Level – Limit value
4. The other emission levels were very low against the limit.
5. " # ": The radiated frequency is out of the restricted band.

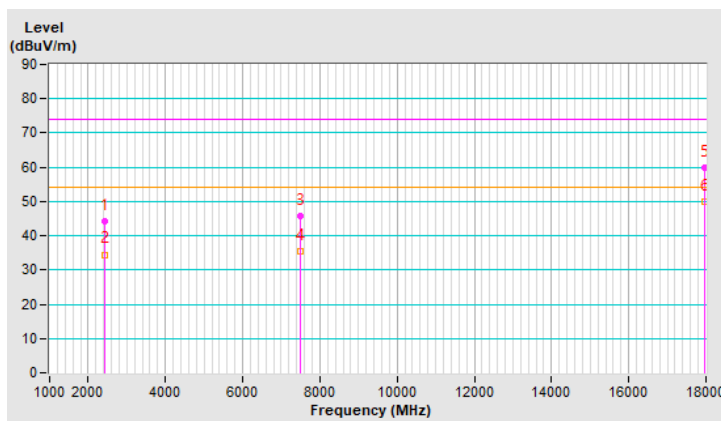

|                        |                  |                          |                           |
|------------------------|------------------|--------------------------|---------------------------|
| <b>Channel</b>         | CH 3 : 62.64 GHz |                          |                           |
| <b>Frequency Range</b> | 1GHz ~ 18GHz     | <b>Detector Function</b> | Peak (PK)<br>Average (AV) |

| Antenna Polarity & Test Distance : Vertical at 3 m |                 |                         |                |             |                    |                      |                  |                          |
|--|-----------------|-------------------------|----------------|-------------|--------------------|----------------------|------------------|--------------------------|
| No   | Frequency (MHz) | Emission Level (dBuV/m) | Limit (dBuV/m) | Margin (dB) | Antenna Height (m) | Table Angle (Degree) | Raw Value (dBuV) | Correction Factor (dB/m) |
| 1  | 2490.16         | 42.1 PK                 | 74.0           | -31.9       | 3.50 V             | 48                   | 43.5             | -1.4                     |
| 2  | 2490.16         | 32.9 AV                 | 54.0           | -21.1       | 3.50 V             | 48                   | 34.3             | -1.4                     |
| 3  | 3667.26         | 45.4 PK                 | 74.0           | -28.6       | 3.00 V             | 59                   | 44.4             | 1.0                      |
| 4  | 3667.26         | 36.5 AV                 | 54.0           | -17.5       | 3.00 V             | 59                   | 35.5             | 1.0                      |
| 5  | 17983.34        | 59.8 PK                 | 74.0           | -14.2       | 1.00 V             | 198                  | 36.9             | 22.9                     |
| 6  | 17983.34        | 49.5 AV                 | 54.0           | -4.5        | 1.00 V             | 198                  | 26.6             | 22.9                     |

**Remarks:**

1. Emission Level(dBuV/m) = Raw Value(dBuV) + Correction Factor(dB/m)
2. Correction Factor(dB/m) = Antenna Factor(dB/m) + Cable Factor(dB) – Pre-Amplifier Factor(dB)
3. Margin value = Emission Level – Limit value
4. The other emission levels were very low against the limit.

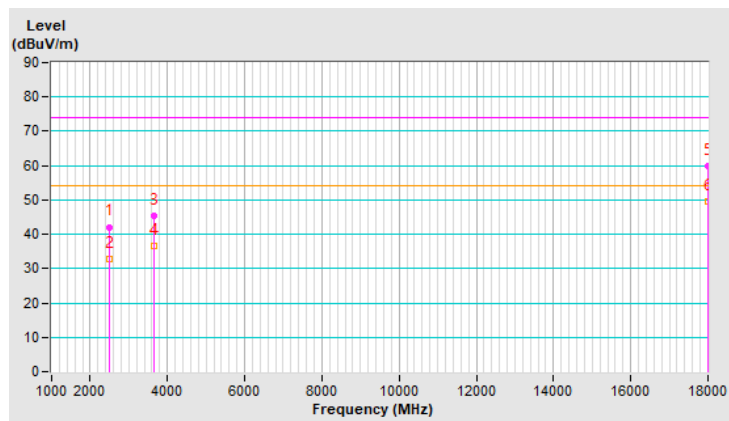

|                        |                 |                          |                           |
|------------------------|-----------------|--------------------------|---------------------------|
| <b>Channel</b>         | CH 4 : 64.8 GHz |                          |                           |
| <b>Frequency Range</b> | 1GHz ~ 18GHz    | <b>Detector Function</b> | Peak (PK)<br>Average (AV) |

| Antenna Polarity & Test Distance : Horizontal at 3 m |                 |                         |                |             |                    |                      |                  |                          |
|--|-----------------|-------------------------|----------------|-------------|--------------------|----------------------|------------------|--------------------------|
| No   | Frequency (MHz) | Emission Level (dBuV/m) | Limit (dBuV/m) | Margin (dB) | Antenna Height (m) | Table Angle (Degree) | Raw Value (dBuV) | Correction Factor (dB/m) |
| 1  | #2437.52        | 44.3 PK                 | 74.0           | -29.7       | 1.50 H             | 247                  | 45.8             | -1.5                     |
| 2  | #2437.52        | 34.6 AV                 | 54.0           | -19.4       | 1.50 H             | 247                  | 36.1             | -1.5                     |
| 3  | 7509.11         | 46.0 PK                 | 74.0           | -28.0       | 2.50 H             | 259                  | 36.1             | 9.9                      |
| 4  | 7509.11         | 35.6 AV                 | 54.0           | -18.4       | 2.50 H             | 259                  | 25.7             | 9.9                      |
| 5  | 17958.47        | 59.7 PK                 | 74.0           | -14.3       | 3.50 H             | 267                  | 36.9             | 22.8                     |
| 6  | 17958.47        | 49.8 AV                 | 54.0           | -4.2        | 3.50 H             | 267                  | 27.0             | 22.8                     |

**Remarks:**

1. Emission Level(dBuV/m) = Raw Value(dBuV) + Correction Factor(dB/m)
2. Correction Factor(dB/m) = Antenna Factor(dB/m) + Cable Factor(dB) – Pre-Amplifier Factor(dB)
3. Margin value = Emission Level – Limit value
4. The other emission levels were very low against the limit.
5. " # ": The radiated frequency is out of the restricted band.

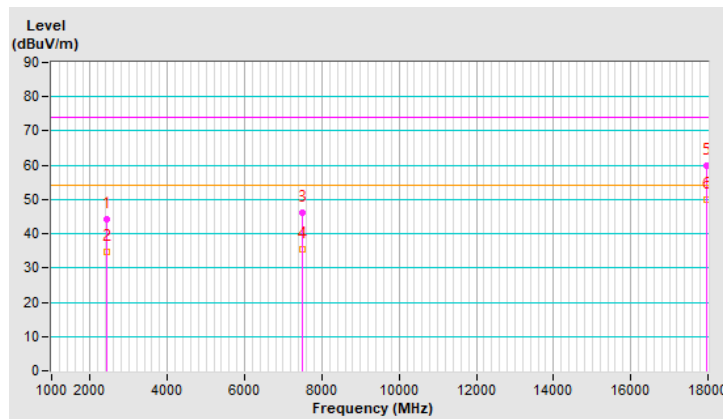

|                        |                 |                          |                           |
|------------------------|-----------------|--------------------------|---------------------------|
| <b>Channel</b>         | CH 4 : 64.8 GHz |                          |                           |
| <b>Frequency Range</b> | 1GHz ~ 18GHz    | <b>Detector Function</b> | Peak (PK)<br>Average (AV) |

| Antenna Polarity & Test Distance : Vertical at 3 m |                 |                         |                |             |                    |                      |                  |                          |
|--|-----------------|-------------------------|----------------|-------------|--------------------|----------------------|------------------|--------------------------|
| No   | Frequency (MHz) | Emission Level (dBuV/m) | Limit (dBuV/m) | Margin (dB) | Antenna Height (m) | Table Angle (Degree) | Raw Value (dBuV) | Correction Factor (dB/m) |
| 1  | 2493.22         | 42.4 PK                 | 74.0           | -31.6       | 3.50 V             | 66                   | 43.8             | -1.4                     |
| 2  | 2493.22         | 33.0 AV                 | 54.0           | -21.0       | 3.50 V             | 66                   | 34.4             | -1.4                     |
| 3  | 3669.53         | 45.5 PK                 | 74.0           | -28.5       | 3.00 V             | 31                   | 44.5             | 1.0                      |
| 4  | 3669.53         | 36.5 AV                 | 54.0           | -17.5       | 3.00 V             | 31                   | 35.5             | 1.0                      |
| 5  | 17977.72        | 59.7 PK                 | 74.0           | -14.3       | 1.00 V             | 206                  | 36.9             | 22.8                     |
| 6  | 17977.72        | 49.4 AV                 | 54.0           | -4.6        | 1.00 V             | 206                  | 26.6             | 22.8                     |

**Remarks:**

1. Emission Level(dBuV/m) = Raw Value(dBuV) + Correction Factor(dB/m)
2. Correction Factor(dB/m) = Antenna Factor(dB/m) + Cable Factor(dB) – Pre-Amplifier Factor(dB)
3. Margin value = Emission Level – Limit value
4. The other emission levels were very low against the limit.

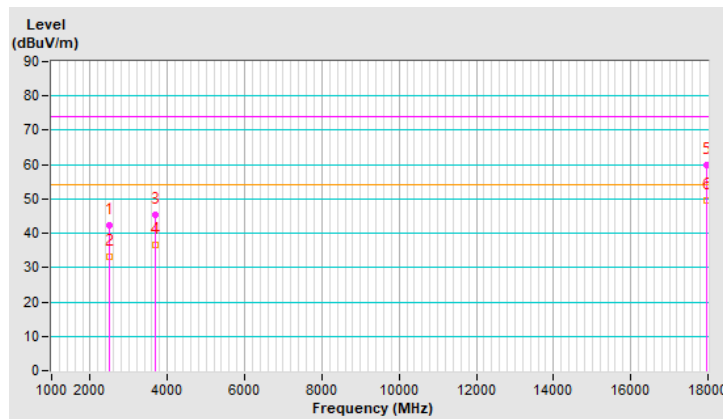

### For 18~40 GHz

|                        |                  |                          |                           |
|------------------------|------------------|--------------------------|---------------------------|
| <b>Channel</b>         | CH 1 : 58.32 GHz |                          |                           |
| <b>Frequency Range</b> | 18GHz ~ 40GHz    | <b>Detector Function</b> | Peak (PK)<br>Average (AV) |

| Antenna Polarity & Test Distance : Horizontal at 3 m |                 |                         |                |             |                    |                      |                  |                          |
|--|-----------------|-------------------------|----------------|-------------|--------------------|----------------------|------------------|--------------------------|
| No   | Frequency (MHz) | Emission Level (dBuV/m) | Limit (dBuV/m) | Margin (dB) | Antenna Height (m) | Table Angle (Degree) | Raw Value (dBuV) | Correction Factor (dB/m) |
| 1  | 19183.57        | 38.9 PK                 | 74.0           | -35.1       | 1.44 H             | 34                   | 45.6             | -6.7                     |
| 2  | 19183.57        | 34.7 AV                 | 54.0           | -19.3       | 1.44 H             | 34                   | 41.4             | -6.7                     |
| 3  | #26984.72       | 42.4 PK                 | 74.0           | -31.6       | 1.65 H             | 135                  | 43.4             | -1.0                     |
| 4  | #26984.72       | 37.5 AV                 | 54.0           | -16.5       | 1.65 H             | 135                  | 38.5             | -1.0                     |
| 5  | 39617.72        | 43.8 PK                 | 74.0           | -30.2       | 2.26 H             | 201                  | 37.0             | 6.8                      |
| 6  | 39617.72        | 38.4 AV                 | 54.0           | -15.6       | 2.26 H             | 201                  | 31.6             | 6.8                      |

#### Remarks:

1. Emission Level(dBuV/m) = Raw Value(dBuV) + Correction Factor(dB/m)
2. Correction Factor(dB/m) = Antenna Factor(dB/m) + Cable Factor(dB) – Pre-Amplifier Factor(dB)
3. Margin value = Emission Level – Limit value
4. The other emission levels were very low against the limit.
5. " # ": The radiated frequency is out of the restricted band.

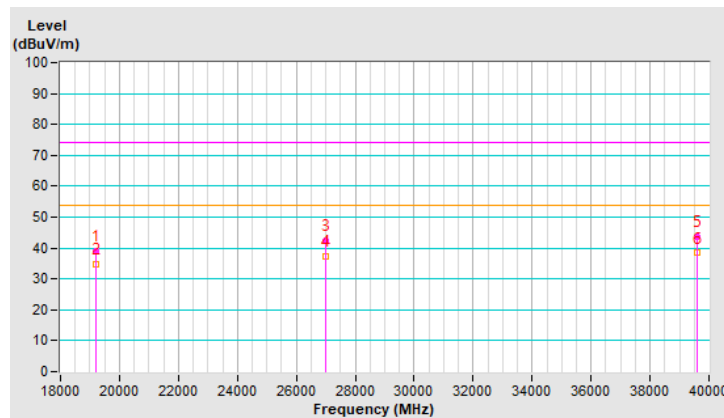

|                        |                  |                          |                           |
|------------------------|------------------|--------------------------|---------------------------|
| <b>Channel</b>         | CH 1 : 58.32 GHz |                          |                           |
| <b>Frequency Range</b> | 18GHz ~ 40GHz    | <b>Detector Function</b> | Peak (PK)<br>Average (AV) |

| Antenna Polarity & Test Distance : Vertical at 3 m |                 |                         |                |             |                    |                      |                  |                          |
|--|-----------------|-------------------------|----------------|-------------|--------------------|----------------------|------------------|--------------------------|
| No   | Frequency (MHz) | Emission Level (dBuV/m) | Limit (dBuV/m) | Margin (dB) | Antenna Height (m) | Table Angle (Degree) | Raw Value (dBuV) | Correction Factor (dB/m) |
| 1  | 18544.26        | 39.2 PK                 | 74.0           | -34.8       | 1.43 V             | 81                   | 46.2             | -7.0                     |
| 2  | 18544.26        | 34.7 AV                 | 54.0           | -19.3       | 1.43 V             | 81                   | 41.7             | -7.0                     |
| 3  | #28113.14       | 42.9 PK                 | 74.0           | -31.1       | 1.91 V             | 257                  | 44.9             | -2.0                     |
| 4  | #28113.14       | 37.5 AV                 | 54.0           | -16.5       | 1.91 V             | 257                  | 39.5             | -2.0                     |
| 5  | 38818.37        | 43.4 PK                 | 74.0           | -30.6       | 1.78 V             | 214                  | 39.0             | 4.4                      |
| 6  | 38818.37        | 36.7 AV                 | 54.0           | -17.3       | 1.78 V             | 214                  | 32.3             | 4.4                      |

**Remarks:**

1. Emission Level(dBuV/m) = Raw Value(dBuV) + Correction Factor(dB/m)
2. Correction Factor(dB/m) = Antenna Factor(dB/m) + Cable Factor(dB) – Pre-Amplifier Factor(dB)
3. Margin value = Emission Level – Limit value
4. The other emission levels were very low against the limit.
5. "#": The radiated frequency is out of the restricted band.

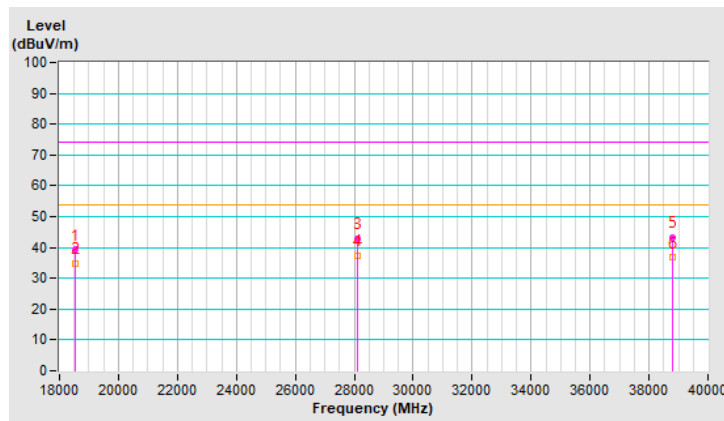



|                        |                  |                          |                           |
|------------------------|------------------|--------------------------|---------------------------|
| <b>Channel</b>         | CH 2 : 60.48 GHz |                          |                           |
| <b>Frequency Range</b> | 18GHz ~ 40GHz    | <b>Detector Function</b> | Peak (PK)<br>Average (AV) |

| Antenna Polarity & Test Distance : Horizontal at 3 m |                 |                         |                |             |                    |                      |                  |                          |
|--|-----------------|-------------------------|----------------|-------------|--------------------|----------------------|------------------|--------------------------|
| No   | Frequency (MHz) | Emission Level (dBuV/m) | Limit (dBuV/m) | Margin (dB) | Antenna Height (m) | Table Angle (Degree) | Raw Value (dBuV) | Correction Factor (dB/m) |
| 1  | 19184.72        | 39.0 PK                 | 74.0           | -35.0       | 1.38 H             | 53                   | 45.7             | -6.7                     |
| 2  | 19184.72        | 34.8 AV                 | 54.0           | -19.2       | 1.38 H             | 53                   | 41.5             | -6.7                     |
| 3  | #26988.41       | 42.5 PK                 | 74.0           | -31.5       | 1.78 H             | 156                  | 43.5             | -1.0                     |
| 4  | #26988.41       | 37.6 AV                 | 54.0           | -16.4       | 1.78 H             | 156                  | 38.6             | -1.0                     |
| 5  | 39619.34        | 43.9 PK                 | 74.0           | -30.1       | 2.41 H             | 187                  | 37.1             | 6.8                      |
| 6  | 39619.34        | 38.4 AV                 | 54.0           | -15.6       | 2.41 H             | 187                  | 31.6             | 6.8                      |

**Remarks:**

1. Emission Level(dBuV/m) = Raw Value(dBuV) + Correction Factor(dB/m)
2. Correction Factor(dB/m) = Antenna Factor(dB/m) + Cable Factor(dB) – Pre-Amplifier Factor(dB)
3. Margin value = Emission Level – Limit value
4. The other emission levels were very low against the limit.
5. "#": The radiated frequency is out of the restricted band.

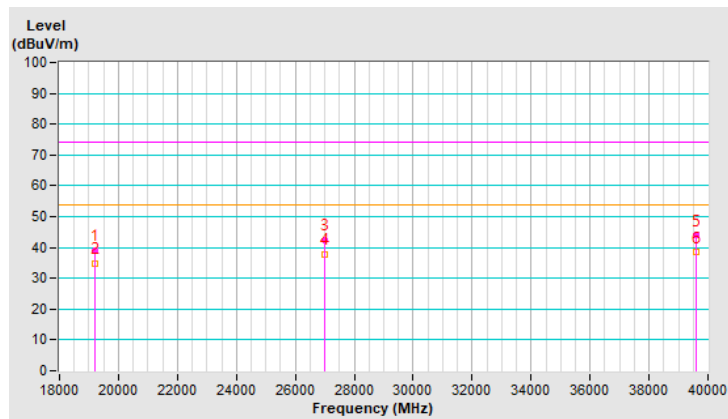

|                        |                  |                          |                           |
|------------------------|------------------|--------------------------|---------------------------|
| <b>Channel</b>         | CH 2 : 60.48 GHz |                          |                           |
| <b>Frequency Range</b> | 18GHz ~ 40GHz    | <b>Detector Function</b> | Peak (PK)<br>Average (AV) |

| Antenna Polarity & Test Distance : Vertical at 3 m |                 |                         |                |             |                    |                      |                  |                          |
|--|-----------------|-------------------------|----------------|-------------|--------------------|----------------------|------------------|--------------------------|
| No   | Frequency (MHz) | Emission Level (dBuV/m) | Limit (dBuV/m) | Margin (dB) | Antenna Height (m) | Table Angle (Degree) | Raw Value (dBuV) | Correction Factor (dB/m) |
| 1  | 18546.43        | 39.3 PK                 | 74.0           | -34.7       | 1.39 V             | 86                   | 46.3             | -7.0                     |
| 2  | 18546.43        | 34.7 AV                 | 54.0           | -19.3       | 1.39 V             | 86                   | 41.7             | -7.0                     |
| 3  | #28114.72       | 43.0 PK                 | 74.0           | -31.0       | 1.96 V             | 269                  | 45.0             | -2.0                     |
| 4  | #28114.72       | 37.5 AV                 | 54.0           | -16.5       | 1.96 V             | 269                  | 39.5             | -2.0                     |
| 5  | 38819.29        | 43.5 PK                 | 74.0           | -30.5       | 1.83 V             | 221                  | 39.1             | 4.4                      |
| 6  | 38819.29        | 36.7 AV                 | 54.0           | -17.3       | 1.83 V             | 221                  | 32.3             | 4.4                      |

**Remarks:**

1. Emission Level(dBuV/m) = Raw Value(dBuV) + Correction Factor(dB/m)
2. Correction Factor(dB/m) = Antenna Factor(dB/m) + Cable Factor(dB) – Pre-Amplifier Factor(dB)
3. Margin value = Emission Level – Limit value
4. The other emission levels were very low against the limit.
5. "#": The radiated frequency is out of the restricted band.

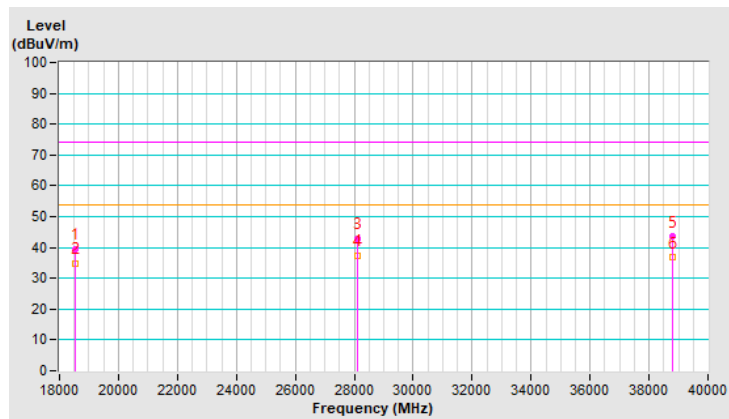

|                        |                  |                          |                           |
|------------------------|------------------|--------------------------|---------------------------|
| <b>Channel</b>         | CH 3 : 62.64 GHz |                          |                           |
| <b>Frequency Range</b> | 18GHz ~ 40GHz    | <b>Detector Function</b> | Peak (PK)<br>Average (AV) |

| Antenna Polarity & Test Distance : Horizontal at 3 m |                 |                         |                |             |                    |                      |                  |                          |
|--|-----------------|-------------------------|----------------|-------------|--------------------|----------------------|------------------|--------------------------|
| No   | Frequency (MHz) | Emission Level (dBuV/m) | Limit (dBuV/m) | Margin (dB) | Antenna Height (m) | Table Angle (Degree) | Raw Value (dBuV) | Correction Factor (dB/m) |
| 1  | 19187.35        | 39.0 PK                 | 74.0           | -35.0       | 1.26 H             | 64                   | 45.7             | -6.7                     |
| 2  | 19187.35        | 34.7 AV                 | 54.0           | -19.3       | 1.26 H             | 64                   | 41.4             | -6.7                     |
| 3  | #26986.32       | 42.6 PK                 | 74.0           | -31.4       | 1.86 H             | 134                  | 43.6             | -1.0                     |
| 4  | #26986.32       | 37.6 AV                 | 54.0           | -16.4       | 1.86 H             | 134                  | 38.6             | -1.0                     |
| 5  | 39621.87        | 44.0 PK                 | 74.0           | -30.0       | 2.62 H             | 204                  | 37.2             | 6.8                      |
| 6  | 39621.87        | 38.5 AV                 | 54.0           | -15.5       | 2.62 H             | 204                  | 31.7             | 6.8                      |

**Remarks:**

1. Emission Level(dBuV/m) = Raw Value(dBuV) + Correction Factor(dB/m)
2. Correction Factor(dB/m) = Antenna Factor(dB/m) + Cable Factor(dB) – Pre-Amplifier Factor(dB)
3. Margin value = Emission Level – Limit value
4. The other emission levels were very low against the limit.
5. "#": The radiated frequency is out of the restricted band.

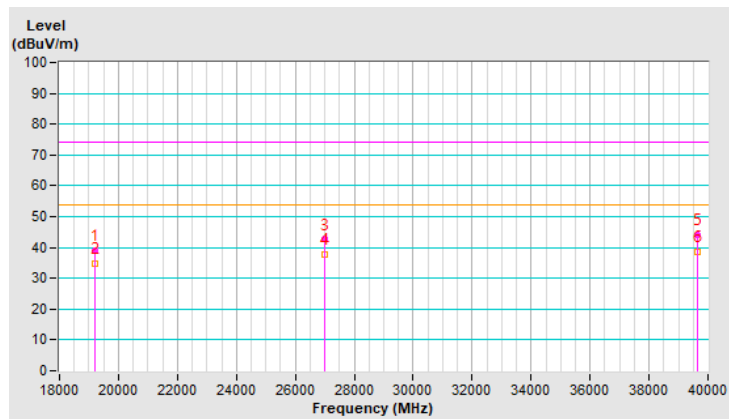

|                        |                  |                          |                           |
|------------------------|------------------|--------------------------|---------------------------|
| <b>Channel</b>         | CH 3 : 62.64 GHz |                          |                           |
| <b>Frequency Range</b> | 18GHz ~ 40GHz    | <b>Detector Function</b> | Peak (PK)<br>Average (AV) |

| Antenna Polarity & Test Distance : Vertical at 3 m |                 |                         |                |             |                    |                      |                  |                          |
|--|-----------------|-------------------------|----------------|-------------|--------------------|----------------------|------------------|--------------------------|
| No   | Frequency (MHz) | Emission Level (dBuV/m) | Limit (dBuV/m) | Margin (dB) | Antenna Height (m) | Table Angle (Degree) | Raw Value (dBuV) | Correction Factor (dB/m) |
| 1  | 18548.12        | 39.2 PK                 | 74.0           | -34.8       | 1.47 V             | 93                   | 46.2             | -7.0                     |
| 2  | 18548.12        | 34.6 AV                 | 54.0           | -19.4       | 1.47 V             | 93                   | 41.6             | -7.0                     |
| 3  | #28116.38       | 43.1 PK                 | 74.0           | -30.9       | 2.03 V             | 289                  | 45.1             | -2.0                     |
| 4  | #28116.38       | 37.6 AV                 | 54.0           | -16.4       | 2.03 V             | 289                  | 39.6             | -2.0                     |
| 5  | 38822.54        | 43.6 PK                 | 74.0           | -30.4       | 1.76 V             | 214                  | 39.2             | 4.4                      |
| 6  | 38822.54        | 36.8 AV                 | 54.0           | -17.2       | 1.76 V             | 214                  | 32.4             | 4.4                      |

**Remarks:**

1. Emission Level(dBuV/m) = Raw Value(dBuV) + Correction Factor(dB/m)
2. Correction Factor(dB/m) = Antenna Factor(dB/m) + Cable Factor(dB) – Pre-Amplifier Factor(dB)
3. Margin value = Emission Level – Limit value
4. The other emission levels were very low against the limit.
5. "#": The radiated frequency is out of the restricted band.

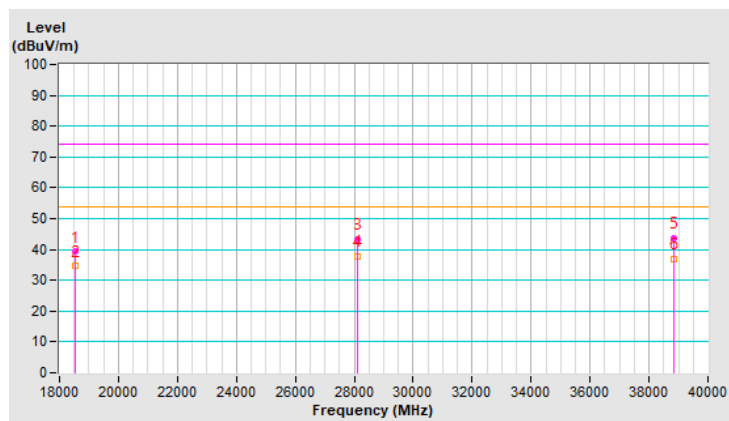

|                        |                 |                          |                           |
|------------------------|-----------------|--------------------------|---------------------------|
| <b>Channel</b>         | CH 4 : 64.8 GHz |                          |                           |
| <b>Frequency Range</b> | 18GHz ~ 40GHz   | <b>Detector Function</b> | Peak (PK)<br>Average (AV) |

| Antenna Polarity & Test Distance : Horizontal at 3 m |                 |                         |                |             |                    |                      |                  |                          |
|--|-----------------|-------------------------|----------------|-------------|--------------------|----------------------|------------------|--------------------------|
| No   | Frequency (MHz) | Emission Level (dBuV/m) | Limit (dBuV/m) | Margin (dB) | Antenna Height (m) | Table Angle (Degree) | Raw Value (dBuV) | Correction Factor (dB/m) |
| 1  | 19189.62        | 38.9 PK                 | 74.0           | -35.1       | 1.21 H             | 73                   | 45.6             | -6.7                     |
| 2  | 19189.62        | 34.6 AV                 | 54.0           | -19.4       | 1.21 H             | 73                   | 41.3             | -6.7                     |
| 3  | #26983.49       | 42.6 PK                 | 74.0           | -31.4       | 1.93 H             | 144                  | 43.6             | -1.0                     |
| 4  | #26983.49       | 37.5 AV                 | 54.0           | -16.5       | 1.93 H             | 144                  | 38.5             | -1.0                     |
| 5  | 39622.41        | 44.0 PK                 | 74.0           | -30.0       | 2.57 H             | 208                  | 37.2             | 6.8                      |
| 6  | 39622.41        | 38.4 AV                 | 54.0           | -15.6       | 2.57 H             | 208                  | 31.6             | 6.8                      |

**Remarks:**

1. Emission Level(dBuV/m) = Raw Value(dBuV) + Correction Factor(dB/m)
2. Correction Factor(dB/m) = Antenna Factor(dB/m) + Cable Factor(dB) – Pre-Amplifier Factor(dB)
3. Margin value = Emission Level – Limit value
4. The other emission levels were very low against the limit.
5. "#": The radiated frequency is out of the restricted band.

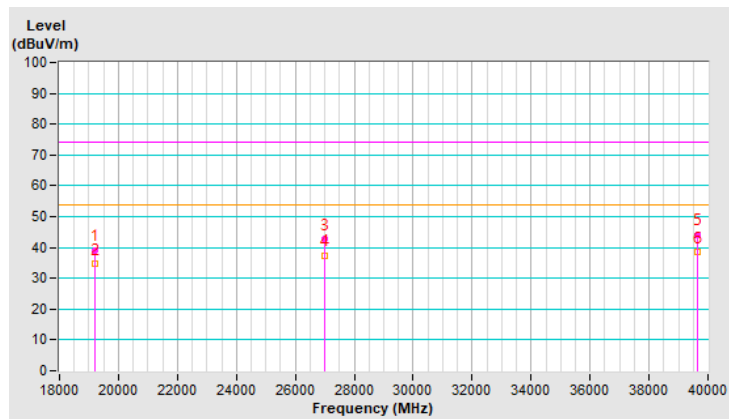

|                        |                 |                          |                           |
|------------------------|-----------------|--------------------------|---------------------------|
| <b>Channel</b>         | CH 4 : 64.8 GHz |                          |                           |
| <b>Frequency Range</b> | 18GHz ~ 40GHz   | <b>Detector Function</b> | Peak (PK)<br>Average (AV) |

| Antenna Polarity & Test Distance : Vertical at 3 m |                 |                         |                |             |                    |                      |                  |                          |
|--|-----------------|-------------------------|----------------|-------------|--------------------|----------------------|------------------|--------------------------|
| No   | Frequency (MHz) | Emission Level (dBuV/m) | Limit (dBuV/m) | Margin (dB) | Antenna Height (m) | Table Angle (Degree) | Raw Value (dBuV) | Correction Factor (dB/m) |
| 1  | 18547.74        | 39.0 PK                 | 74.0           | -35.0       | 1.53 V             | 76                   | 46.0             | -7.0                     |
| 2  | 18547.74        | 34.5 AV                 | 54.0           | -19.5       | 1.53 V             | 76                   | 41.5             | -7.0                     |
| 3  | #28115.62       | 42.9 PK                 | 74.0           | -31.1       | 1.92 V             | 294                  | 44.9             | -2.0                     |
| 4  | #28115.62       | 37.5 AV                 | 54.0           | -16.5       | 1.92 V             | 294                  | 39.5             | -2.0                     |
| 5  | 38821.22        | 43.4 PK                 | 74.0           | -30.6       | 1.63 V             | 208                  | 39.0             | 4.4                      |
| 6  | 38821.22        | 36.6 AV                 | 54.0           | -17.4       | 1.63 V             | 208                  | 32.2             | 4.4                      |

**Remarks:**

1. Emission Level(dBuV/m) = Raw Value(dBuV) + Correction Factor(dB/m)
2. Correction Factor(dB/m) = Antenna Factor(dB/m) + Cable Factor(dB) – Pre-Amplifier Factor(dB)
3. Margin value = Emission Level – Limit value
4. The other emission levels were very low against the limit.
5. "#": The radiated frequency is out of the restricted band.

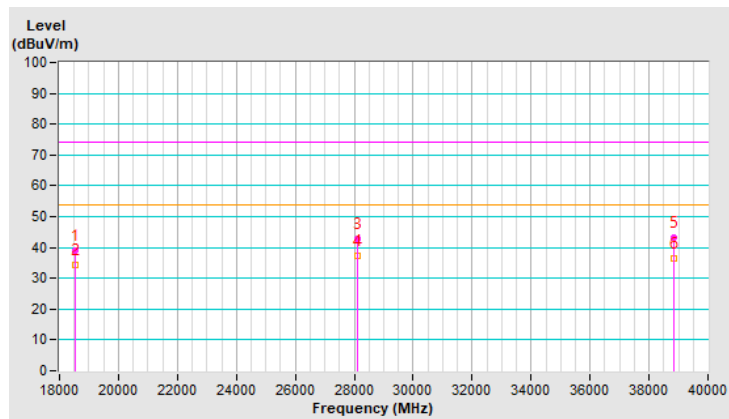

**For above 40 GHz**

|                        |                  |                          |              |
|------------------------|------------------|--------------------------|--------------|
| <b>Channel</b>         | CH 1 : 58.32 GHz |                          |              |
| <b>Frequency Range</b> | 40GHz ~ 220GHz   | <b>Detector Function</b> | Average (AV) |

| Antenna Polarity : Horizontal |                 |                            |                      |                                     |   |                              |           |
|-------------------------------|-----------------|----------------------------|----------------------|-------------------------------------|---|------------------------------|-----------|
| No.                           | Frequency (GHz) | E <sub>Meas</sub> (dBμV/m) | EIRP Level (dBm/MHz) | Power Density (pW/cm <sup>2</sup> ) | Power Density Limit (pW/cm <sup>2</sup> ) | Margin (pW/cm <sup>2</sup> ) | PASS/FAIL |
| 1                             | 42.38           | 69.05                      | -35.65               | 0.24                                | 90.00                                     | -89.76                       | PASS      |
| 2                             | 54.57           | 83.15                      | -21.55               | 6.19                                | 90.00                                     | -83.81                       | PASS      |
| 3                             | 73.71           | 85.28                      | -19.42               | 10.11                               | 90.00                                     | -79.89                       | PASS      |
| 4                             | 102.20          | 64.71                      | -39.99               | 0.09                                | 90.00                                     | -89.91                       | PASS      |
| 5                             | 116.70          | 76.97                      | -27.73               | 1.49                                | 90.00                                     | -88.51                       | PASS      |
| 6                             | 193.70          | 69.00                      | -35.70               | 0.24                                | 90.00                                     | -89.76                       | PASS      |
| Antenna Polarity : Vertical   |                 |                            |                      |                                     |   |                              |           |
| No.                           | Frequency (GHz) | E <sub>Meas</sub> (dBμV/m) | EIRP Level (dBm/MHz) | Power Density (pW/cm <sup>2</sup> ) | Power Density Limit (pW/cm <sup>2</sup> ) | Margin (pW/cm <sup>2</sup> ) | PASS/FAIL |
| 1                             | 41.45           | 69.62                      | -35.08               | 0.27                                | 90.00                                     | -89.73                       | PASS      |
| 2                             | 54.43           | 76.77                      | -27.93               | 1.42                                | 90.00                                     | -88.58                       | PASS      |
| 3                             | 73.84           | 92.28                      | -12.42               | 50.69                               | 90.00                                     | -39.31                       | PASS      |
| 4                             | 101.99          | 65.38                      | -39.32               | 0.10                                | 90.00                                     | -89.90                       | PASS      |
| 5                             | 116.58          | 77.66                      | -27.04               | 1.75                                | 90.00                                     | -88.25                       | PASS      |
| 6                             | 192.40          | 69.15                      | -35.55               | 0.25                                | 90.00                                     | -89.75                       | PASS      |

Remarks:

1. The measured power level is converted to EIRP using the equation:

Follow ANSI 63.10 section 9.4 Equations to calculate and extrapolate field strength

$$E_{Meas} \text{ (dB}\mu\text{V/m)} = 126.8 - 20\log(\lambda) + P - G$$

where:

E<sub>Meas</sub> is the field strength of the emission at the measurement distance, in dBμV/m

P is the power measured at the output of the test antenna, in dBm

λ is the wavelength of the emission under investigation [300/fMHz], in m

G is the gain of the test antenna, in dBi

Follow ANSI 63.10 section 9.5 Equations to calculate EIRP

$$\text{EIRP Level (dBm/MHz)} = E_{Meas} \text{ (dB}\mu\text{V/m)} + 20 \cdot \log(d_{Meas}) - 104.7$$

E<sub>Meas</sub> is the field strength of the emission at the measurement distance, in dBμV/m

d<sub>Meas</sub> is the measurement distance, in m

Measurements made at 1 meter distance.

2. Power density formula as follows

Follow ANSI 63.10 section 9.6 Equations to calculate power density

$$PD = \text{EIRP}_{\text{Linear}} / 4 \pi d^2$$

PD is the power density at the distance specified by the limit, in W/m<sup>2</sup>

$EIRP_{Linear}$  is the equivalent isotropically radiated power, in watts

d is the 3m distance.

3. The far-field boundary is given in ANSI 63.10 as:

$$R \text{ far field} = (2 * L^2) / \lambda$$

L is the Largest Antenna Dimension of measurement antenna, including the reflector

$\lambda$  is the wavelength

| Frequency (GHz) | L (m) | Lambda (m) | R (Far Field) (m) |
|-----------------|-------|------------|-------------------|
| 40              | 0.03  | 0.0075     | 0.240             |
| 50              | 0.03  | 0.0060     | 0.300             |

| Frequency (GHz) | L (m) | Lambda (m) | R (Far Field) (m) |
|-----------------|-------|------------|-------------------|
| 50              | 0.025 | 0.0060     | 0.208             |
| 75              | 0.025 | 0.0040     | 0.313             |

| Frequency (GHz) | L (m) | Lambda (m) | R (Far Field) (m) |
|-----------------|-------|------------|-------------------|
| 75              | 0.018 | 0.0040     | 0.162             |
| 110             | 0.018 | 0.0027     | 0.238             |

| Frequency (GHz) | L (m) | Lambda (m) | R (Far Field) (m) |
|-----------------|-------|------------|-------------------|
| 110             | 0.012 | 0.0027     | 0.106             |
| 170             | 0.012 | 0.0018     | 0.163             |

| Frequency (GHz) | L (m) | Lambda (m) | R (Far Field) (m) |
|-----------------|-------|------------|-------------------|
| 170             | 0.008 | 0.0018     | 0.073             |
| 260             | 0.008 | 0.0012     | 0.111             |



|                        |                  |                          |              |
|------------------------|------------------|--------------------------|--------------|
| <b>Channel</b>         | CH 2 : 60.48 GHz |                          |              |
| <b>Frequency Range</b> | 40GHz ~ 220GHz   | <b>Detector Function</b> | Average (AV) |

| Antenna Polarity : Horizontal |                 |                                  |                      |                                     |   |                              |           |
|-------------------------------|-----------------|----------------------------------|----------------------|-------------------------------------|---|------------------------------|-----------|
| No.                           | Frequency (GHz) | E <sub>Meas</sub> (dB $\mu$ V/m) | EIRP Level (dBm/MHz) | Power Density (pW/cm <sup>2</sup> ) | Power Density Limit (pW/cm <sup>2</sup> ) | Margin (pW/cm <sup>2</sup> ) | PASS/FAIL |
| 1                             | 42.27           | 78.80                            | -25.90               | 2.27                                | 90.00                                     | -87.73                       | PASS      |
| 2                             | 54.60           | 85.77                            | -18.93               | 11.32                               | 90.00                                     | -78.68                       | PASS      |
| 3                             | 73.63           | 84.96                            | -19.74               | 9.38                                | 90.00                                     | -80.62                       | PASS      |
| 4                             | 102.22          | 74.07                            | -30.63               | 0.77                                | 90.00                                     | -89.23                       | PASS      |
| 5                             | 116.97          | 86.39                            | -18.31               | 13.06                               | 90.00                                     | -76.94                       | PASS      |
| 6                             | 193.92          | 78.71                            | -25.99               | 2.22                                | 90.00                                     | -87.78                       | PASS      |
| Antenna Polarity : Vertical   |                 |                                  |                      |                                     |   |                              |           |
| No.                           | Frequency (GHz) | E <sub>Meas</sub> (dB $\mu$ V/m) | EIRP Level (dBm/MHz) | Power Density (pW/cm <sup>2</sup> ) | Power Density Limit (pW/cm <sup>2</sup> ) | Margin (pW/cm <sup>2</sup> ) | PASS/FAIL |
| 1                             | 41.45           | 78.78                            | -25.92               | 2.26                                | 90.00                                     | -87.74                       | PASS      |
| 2                             | 54.58           | 88.39                            | -16.31               | 20.69                               | 90.00                                     | -69.31                       | PASS      |
| 3                             | 73.70           | 93.43                            | -11.27               | 65.95                               | 90.00                                     | -24.05                       | PASS      |
| 4                             | 101.77          | 74.62                            | -30.08               | 0.87                                | 90.00                                     | -89.13                       | PASS      |
| 5                             | 115.74          | 87.34                            | -17.36               | 16.23                               | 90.00                                     | -73.77                       | PASS      |
| 6                             | 191.85          | 78.49                            | -26.21               | 2.11                                | 90.00                                     | -87.89                       | PASS      |

Remarks:

1. The measured power level is converted to EIRP using the equation:

Follow ANSI 63.10 section 9.4 Equations to calculate and extrapolate field strength

$$E_{Meas} \text{ (dB}\mu\text{V/m)} = 126.8 - 20\log(\lambda) + P - G$$

where:

E<sub>Meas</sub> is the field strength of the emission at the measurement distance, in dB $\mu$ V/m

P is the power measured at the output of the test antenna, in dBm

$\lambda$  is the wavelength of the emission under investigation [300/fMHz], in m

G is the gain of the test antenna, in dBi

Follow ANSI 63.10 section 9.5 Equations to calculate EIRP

$$\text{EIRP Level (dBm/MHz)} = E_{Meas} \text{ (dB}\mu\text{V/m)} + 20 \cdot \log(d_{Meas}) - 104.7$$

E<sub>Meas</sub> is the field strength of the emission at the measurement distance, in dB $\mu$ V/m

d<sub>Meas</sub> is the measurement distance, in m

Measurements made at 1 meter distance.

2. Power density formula as follows

Follow ANSI 63.10 section 9.6 Equations to calculate power density

$$PD = \text{EIRP}_{\text{Linear}} / 4 \pi d^2$$

PD is the power density at the distance specified by the limit, in W/m<sup>2</sup>

EIRP<sub>Linear</sub> is the equivalent isotropically radiated power, in watts

d is the 3m distance.

3. The far-field boundary is given in ANSI 63.10 as:

$$R \text{ far field} = (2 * L^2) / \lambda$$

L is the Largest Antenna Dimension of measurement antenna, including the reflector

$\lambda$  is the wavelength

| Frequency (GHz) | L (m) | Lambda (m) | R (Far Field) (m) |
|-----------------|-------|------------|-------------------|
| 40              | 0.03  | 0.0075     | 0.240             |
| 50              | 0.03  | 0.0060     | 0.300             |

| Frequency (GHz) | L (m) | Lambda (m) | R (Far Field) (m) |
|-----------------|-------|------------|-------------------|
| 50              | 0.025 | 0.0060     | 0.208             |
| 75              | 0.025 | 0.0040     | 0.313             |

| Frequency (GHz) | L (m) | Lambda (m) | R (Far Field) (m) |
|-----------------|-------|------------|-------------------|
| 75              | 0.018 | 0.0040     | 0.162             |
| 110             | 0.018 | 0.0027     | 0.238             |

| Frequency (GHz) | L (m) | Lambda (m) | R (Far Field) (m) |
|-----------------|-------|------------|-------------------|
| 110             | 0.012 | 0.0027     | 0.106             |
| 170             | 0.012 | 0.0018     | 0.163             |

| Frequency (GHz) | L (m) | Lambda (m) | R (Far Field) (m) |
|-----------------|-------|------------|-------------------|
| 170             | 0.008 | 0.0018     | 0.073             |
| 260             | 0.008 | 0.0012     | 0.111             |

|                        |                  |                          |              |
|------------------------|------------------|--------------------------|--------------|
| <b>Channel</b>         | CH 3 : 62.64 GHz |                          |              |
| <b>Frequency Range</b> | 40GHz ~ 220GHz   | <b>Detector Function</b> | Average (AV) |

| Antenna Polarity : Horizontal |                 |                            |                      |                                     |   |                              |           |
|-------------------------------|-----------------|----------------------------|----------------------|-------------------------------------|---|------------------------------|-----------|
| No.                           | Frequency (GHz) | E <sub>Meas</sub> (dBμV/m) | EIRP Level (dBm/MHz) | Power Density (pW/cm <sup>2</sup> ) | Power Density Limit (pW/cm <sup>2</sup> ) | Margin (pW/cm <sup>2</sup> ) | PASS/FAIL |
| 1                             | 41.91           | 78.45                      | -26.25               | 2.10                                | 90.00                                     | -87.90                       | PASS      |
| 2                             | 54.36           | 81.99                      | -22.71               | 4.74                                | 90.00                                     | -85.26                       | PASS      |
| 3                             | 74.18           | 84.05                      | -20.65               | 7.61                                | 90.00                                     | -82.39                       | PASS      |
| 4                             | 102.25          | 74.40                      | -30.30               | 0.83                                | 90.00                                     | -89.17                       | PASS      |
| 5                             | 116.72          | 86.50                      | -18.20               | 13.39                               | 90.00                                     | -76.61                       | PASS      |
| 6                             | 193.77          | 78.54                      | -26.16               | 2.14                                | 90.00                                     | -87.86                       | PASS      |
| Antenna Polarity : Vertical   |                 |                            |                      |                                     |   |                              |           |
| No.                           | Frequency (GHz) | E <sub>Meas</sub> (dBμV/m) | EIRP Level (dBm/MHz) | Power Density (pW/cm <sup>2</sup> ) | Power Density Limit (pW/cm <sup>2</sup> ) | Margin (pW/cm <sup>2</sup> ) | PASS/FAIL |
| 1                             | 40.79           | 78.79                      | -25.91               | 2.27                                | 90.00                                     | -87.73                       | PASS      |
| 2                             | 54.25           | 86.75                      | -17.95               | 14.17                               | 90.00                                     | -75.83                       | PASS      |
| 3                             | 74.16           | 84.45                      | -20.25               | 8.34                                | 90.00                                     | -81.66                       | PASS      |
| 4                             | 101.80          | 74.73                      | -29.97               | 0.89                                | 90.00                                     | -89.11                       | PASS      |
| 5                             | 116.10          | 87.35                      | -17.35               | 16.28                               | 90.00                                     | -73.72                       | PASS      |
| 6                             | 192.13          | 78.82                      | -25.88               | 2.28                                | 90.00                                     | -87.72                       | PASS      |

Remarks:

1. The measured power level is converted to EIRP using the equation:

Follow ANSI 63.10 section 9.4 Equations to calculate and extrapolate field strength

$$E_{Meas} \text{ (dB}\mu\text{V/m)} = 126.8 - 20\log(\lambda) + P - G$$

where:

E<sub>Meas</sub> is the field strength of the emission at the measurement distance, in dBμV/m

P is the power measured at the output of the test antenna, in dBm

λ is the wavelength of the emission under investigation [300/fMHz], in m

G is the gain of the test antenna, in dBi

Follow ANSI 63.10 section 9.5 Equations to calculate EIRP

$$\text{EIRP Level (dBm/MHz)} = E_{Meas} \text{ (dB}\mu\text{V/m)} + 20 \cdot \log(d_{Meas}) - 104.7$$

E<sub>Meas</sub> is the field strength of the emission at the measurement distance, in dBμV/m

d<sub>Meas</sub> is the measurement distance, in m

Measurements made at 1 meter distance.

2. Power density formula as follows

Follow ANSI 63.10 section 9.6 Equations to calculate power density

$$PD = \text{EIRP}_{\text{Linear}} / 4 \pi d^2$$

PD is the power density at the distance specified by the limit, in W/m<sup>2</sup>

EIRP<sub>Linear</sub> is the equivalent isotropically radiated power, in watts

d is the 3m distance.

3. The far-field boundary is given in ANSI 63.10 as:

$$R \text{ far field} = (2 * L^2) / \lambda$$

L is the Largest Antenna Dimension of measurement antenna, including the reflector

$\lambda$  is the wavelength

| Frequency (GHz) | L (m) | Lambda (m) | R (Far Field) (m) |
|-----------------|-------|------------|-------------------|
| 40              | 0.03  | 0.0075     | 0.240             |
| 50              | 0.03  | 0.0060     | 0.300             |

| Frequency (GHz) | L (m) | Lambda (m) | R (Far Field) (m) |
|-----------------|-------|------------|-------------------|
| 50              | 0.025 | 0.0060     | 0.208             |
| 75              | 0.025 | 0.0040     | 0.313             |

| Frequency (GHz) | L (m) | Lambda (m) | R (Far Field) (m) |
|-----------------|-------|------------|-------------------|
| 75              | 0.018 | 0.0040     | 0.162             |
| 110             | 0.018 | 0.0027     | 0.238             |

| Frequency (GHz) | L (m) | Lambda (m) | R (Far Field) (m) |
|-----------------|-------|------------|-------------------|
| 110             | 0.012 | 0.0027     | 0.106             |
| 170             | 0.012 | 0.0018     | 0.163             |

| Frequency (GHz) | L (m) | Lambda (m) | R (Far Field) (m) |
|-----------------|-------|------------|-------------------|
| 170             | 0.008 | 0.0018     | 0.073             |
| 260             | 0.008 | 0.0012     | 0.111             |

|                        |                 |                          |              |
|------------------------|-----------------|--------------------------|--------------|
| <b>Channel</b>         | CH 4 : 64.8 GHz |                          |              |
| <b>Frequency Range</b> | 40GHz ~ 220GHz  | <b>Detector Function</b> | Average (AV) |

| Antenna Polarity : Horizontal |                 |                            |                      |                                     |   |                              |           |
|-------------------------------|-----------------|----------------------------|----------------------|-------------------------------------|---|------------------------------|-----------|
| No.                           | Frequency (GHz) | E <sub>Meas</sub> (dBμV/m) | EIRP Level (dBm/MHz) | Power Density (pW/cm <sup>2</sup> ) | Power Density Limit (pW/cm <sup>2</sup> ) | Margin (pW/cm <sup>2</sup> ) | PASS/FAIL |
| 1                             | 42.37           | 78.79                      | -25.91               | 2.27                                | 90.00                                     | -87.73                       | PASS      |
| 2                             | 54.33           | 82.65                      | -22.05               | 5.52                                | 90.00                                     | -84.48                       | PASS      |
| 3                             | 73.58           | 85.60                      | -19.10               | 10.89                               | 90.00                                     | -79.11                       | PASS      |
| 4                             | 102.03          | 74.51                      | -30.19               | 0.85                                | 90.00                                     | -89.15                       | PASS      |
| 5                             | 116.78          | 86.40                      | -18.30               | 13.09                               | 90.00                                     | -76.91                       | PASS      |
| 6                             | 193.92          | 78.73                      | -25.97               | 2.24                                | 90.00                                     | -87.76                       | PASS      |
| Antenna Polarity : Vertical   |                 |                            |                      |                                     |   |                              |           |
| No.                           | Frequency (GHz) | E <sub>Meas</sub> (dBμV/m) | EIRP Level (dBm/MHz) | Power Density (pW/cm <sup>2</sup> ) | Power Density Limit (pW/cm <sup>2</sup> ) | Margin (pW/cm <sup>2</sup> ) | PASS/FAIL |
| 1                             | 41.65           | 78.96                      | -25.74               | 2.36                                | 90.00                                     | -87.64                       | PASS      |
| 2                             | 53.92           | 90.84                      | -13.86               | 36.38                               | 90.00                                     | -53.62                       | PASS      |
| 3                             | 74.01           | 89.36                      | -15.34               | 25.84                               | 90.00                                     | -64.16                       | PASS      |
| 4                             | 101.40          | 74.45                      | -30.25               | 0.83                                | 90.00                                     | -89.17                       | PASS      |
| 5                             | 116.32          | 87.44                      | -17.26               | 16.62                               | 90.00                                     | -73.38                       | PASS      |
| 6                             | 191.84          | 78.67                      | -26.03               | 2.21                                | 90.00                                     | -87.79                       | PASS      |

Remarks:

1. The measured power level is converted to EIRP using the equation:

Follow ANSI 63.10 section 9.4 Equations to calculate and extrapolate field strength

$$E_{Meas} \text{ (dB}\mu\text{V/m)} = 126.8 - 20\log(\lambda) + P - G$$

where:

E<sub>Meas</sub> is the field strength of the emission at the measurement distance, in dBμV/m

P is the power measured at the output of the test antenna, in dBm

λ is the wavelength of the emission under investigation [300/fMHz], in m

G is the gain of the test antenna, in dBi

Follow ANSI 63.10 section 9.5 Equations to calculate EIRP

$$\text{EIRP Level (dBm/MHz)} = E_{Meas} \text{ (dB}\mu\text{V/m)} + 20 \cdot \log(d_{Meas}) - 104.7$$

E<sub>Meas</sub> is the field strength of the emission at the measurement distance, in dBμV/m

d<sub>Meas</sub> is the measurement distance, in m

Measurements made at 1 meter distance.

2. Power density formula as follows

Follow ANSI 63.10 section 9.6 Equations to calculate power density

$$PD = \text{EIRP}_{\text{Linear}} / 4 \pi d^2$$

PD is the power density at the distance specified by the limit, in W/m<sup>2</sup>

EIRP<sub>Linear</sub> is the equivalent isotropically radiated power, in watts

d is the 3m distance.

3. The far-field boundary is given in ANSI 63.10 as:

$$R \text{ far field} = (2 * L^2) / \lambda$$

L is the Largest Antenna Dimension of measurement antenna, including the reflector

$\lambda$  is the wavelength

| Frequency (GHz) | L (m) | Lambda (m) | R (Far Field) (m) |
|-----------------|-------|------------|-------------------|
| 40              | 0.03  | 0.0075     | 0.240             |
| 50              | 0.03  | 0.0060     | 0.300             |

| Frequency (GHz) | L (m) | Lambda (m) | R (Far Field) (m) |
|-----------------|-------|------------|-------------------|
| 50              | 0.025 | 0.0060     | 0.208             |
| 75              | 0.025 | 0.0040     | 0.313             |

| Frequency (GHz) | L (m) | Lambda (m) | R (Far Field) (m) |
|-----------------|-------|------------|-------------------|
| 75              | 0.018 | 0.0040     | 0.162             |
| 110             | 0.018 | 0.0027     | 0.238             |

| Frequency (GHz) | L (m) | Lambda (m) | R (Far Field) (m) |
|-----------------|-------|------------|-------------------|
| 110             | 0.012 | 0.0027     | 0.106             |
| 170             | 0.012 | 0.0018     | 0.163             |

| Frequency (GHz) | L (m) | Lambda (m) | R (Far Field) (m) |
|-----------------|-------|------------|-------------------|
| 170             | 0.008 | 0.0018     | 0.073             |
| 260             | 0.008 | 0.0012     | 0.111             |

### Below 1GHz Data:

|                        |                  |                          |                 |
|------------------------|------------------|--------------------------|-----------------|
| <b>Channel</b>         | CH 1 : 58.32 GHz |                          |                 |
| <b>Frequency Range</b> | 9kHz ~ 1GHz      | <b>Detector Function</b> | Quasi-Peak (QP) |

| Antenna Polarity & Test Distance : Horizontal at 3 m |                 |                         |                |             |                    |                      |                  |                          |
|--|-----------------|-------------------------|----------------|-------------|--------------------|----------------------|------------------|--------------------------|
| No   | Frequency (MHz) | Emission Level (dBuV/m) | Limit (dBuV/m) | Margin (dB) | Antenna Height (m) | Table Angle (Degree) | Raw Value (dBuV) | Correction Factor (dB/m) |
| 1  | 31.92           | 29.7 QP                 | 40.0           | -10.3       | 1.00 H             | 33                   | 38.5             | -8.8                     |
| 2  | 86.75           | 33.6 QP                 | 40.0           | -6.4        | 3.00 H             | 44                   | 46.7             | -13.1                    |
| 3  | 121.28          | 30.4 QP                 | 43.5           | -13.1       | 3.00 H             | 128                  | 39.3             | -8.9                     |
| 4  | 176.72          | 35.3 QP                 | 43.5           | -8.2        | 2.00 H             | 306                  | 43.5             | -8.2                     |
| 5  | 249.99          | 31.4 QP                 | 46.0           | -14.6       | 1.00 H             | 71                   | 39.4             | -8.0                     |
| 6  | 375.01          | 33.0 QP                 | 46.0           | -13.0       | 1.00 H             | 46                   | 36.7             | -3.7                     |

### Remarks:

1. Emission Level(dBuV/m) = Raw Value(dBuV) + Correction Factor(dB/m)
2. Correction Factor(dB/m) = Antenna Factor(dB/m) + Cable Factor(dB) – Pre-Amplifier Factor(dB)
3. Margin value = Emission Level – Limit value
4. The other emission levels were very low against the limit of frequency range 30MHz~1000MHz.
5. The emission levels were very low against the limit of frequency range 9kHz~30MHz: the amplitude of spurious emissions attenuated more than 20 dB below the permissible value to be report.

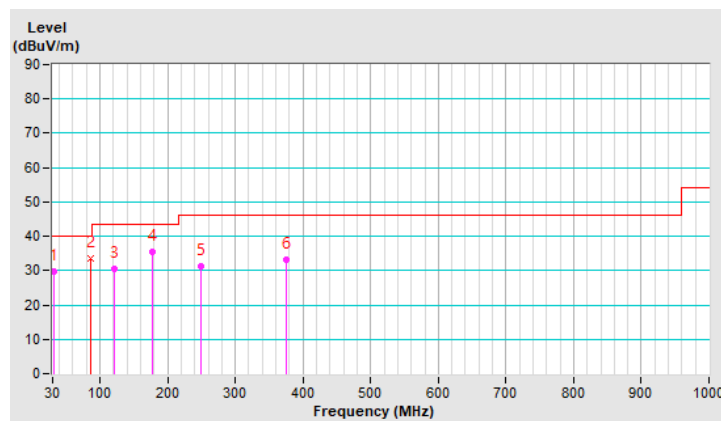

|                        |                  |                          |                 |
|------------------------|------------------|--------------------------|-----------------|
| <b>Channel</b>         | CH 1 : 58.32 GHz |                          |                 |
| <b>Frequency Range</b> | 9kHz ~ 1GHz      | <b>Detector Function</b> | Quasi-Peak (QP) |

| Antenna Polarity & Test Distance : Vertical at 3 m |                 |                         |                |             |                    |                      |                  |                          |
|--|-----------------|-------------------------|----------------|-------------|--------------------|----------------------|------------------|--------------------------|
| No   | Frequency (MHz) | Emission Level (dBuV/m) | Limit (dBuV/m) | Margin (dB) | Antenna Height (m) | Table Angle (Degree) | Raw Value (dBuV) | Correction Factor (dB/m) |
| 1  | 43.09           | 34.1 QP                 | 40.0           | -5.9        | 1.00 V             | 255                  | 42.0             | -7.9                     |
| 2  | 82.71           | 35.1 QP                 | 40.0           | -4.9        | 1.00 V             | 77                   | 48.0             | -12.9                    |
| 3  | 121.03          | 30.1 QP                 | 43.5           | -13.4       | 2.00 V             | 139                  | 39.0             | -8.9                     |
| 4  | 175.22          | 36.1 QP                 | 43.5           | -7.4        | 3.00 V             | 121                  | 44.1             | -8.0                     |
| 5  | 208.21          | 30.3 QP                 | 43.5           | -13.2       | 1.00 V             | 133                  | 40.3             | -10.0                    |
| 6  | 875.01          | 31.1 QP                 | 46.0           | -14.9       | 1.50 V             | 251                  | 24.1             | 7.0                      |

**Remarks:**

1. Emission Level(dBuV/m) = Raw Value(dBuV) + Correction Factor(dB/m)
2. Correction Factor(dB/m) = Antenna Factor(dB/m) + Cable Factor(dB) – Pre-Amplifier Factor(dB)
3. Margin value = Emission Level – Limit value
4. The other emission levels were very low against the limit of frequency range 30MHz~1000MHz.
5. The emission levels were very low against the limit of frequency range 9kHz~30MHz: the amplitude of spurious emissions attenuated more than 20 dB below the permissible value to be report.

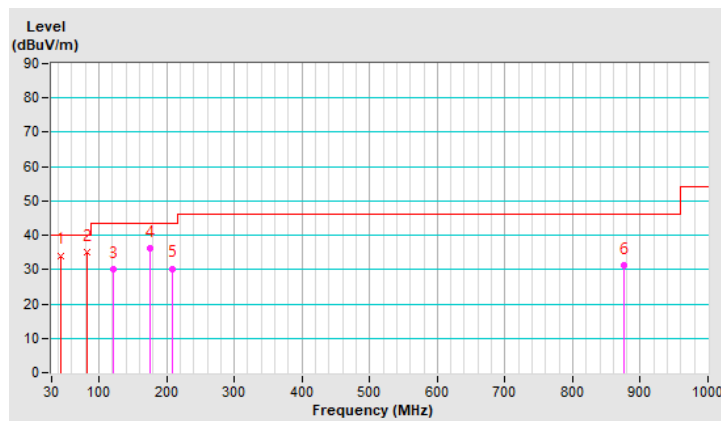



|                        |                  |                          |                 |
|------------------------|------------------|--------------------------|-----------------|
| <b>Channel</b>         | CH 2 : 60.48 GHz |                          |                 |
| <b>Frequency Range</b> | 9kHz ~ 1GHz      | <b>Detector Function</b> | Quasi-Peak (QP) |

| Antenna Polarity & Test Distance : Horizontal at 3 m |                 |                         |                |             |                    |                      |                  |                          |
|--|-----------------|-------------------------|----------------|-------------|--------------------|----------------------|------------------|--------------------------|
| No   | Frequency (MHz) | Emission Level (dBUV/m) | Limit (dBUV/m) | Margin (dB) | Antenna Height (m) | Table Angle (Degree) | Raw Value (dBUV) | Correction Factor (dB/m) |
| 1  | 31.97           | 29.9 QP                 | 40.0           | -10.1       | 1.00 H             | 45                   | 38.7             | -8.8                     |
| 2  | 86.79           | 33.8 QP                 | 40.0           | -6.2        | 3.00 H             | 68                   | 46.9             | -13.1                    |
| 3  | 121.33          | 30.5 QP                 | 43.5           | -13.0       | 3.00 H             | 134                  | 39.4             | -8.9                     |
| 4  | 176.77          | 35.5 QP                 | 43.5           | -8.0        | 2.00 H             | 228                  | 43.7             | -8.2                     |
| 5  | 250.02          | 31.5 QP                 | 46.0           | -14.5       | 1.00 H             | 43                   | 39.5             | -8.0                     |
| 6  | 375.02          | 33.1 QP                 | 46.0           | -12.9       | 1.00 H             | 32                   | 36.8             | -3.7                     |

**Remarks:**

1. Emission Level(dBUV/m) = Raw Value(dBuV) + Correction Factor(dB/m)
2. Correction Factor(dB/m) = Antenna Factor(dB/m) + Cable Factor(dB) – Pre-Amplifier Factor(dB)
3. Margin value = Emission Level – Limit value
4. The other emission levels were very low against the limit of frequency range 30MHz~1000MHz.
5. The emission levels were very low against the limit of frequency range 9kHz~30MHz: the amplitude of spurious emissions attenuated more than 20 dB below the permissible value to be report.

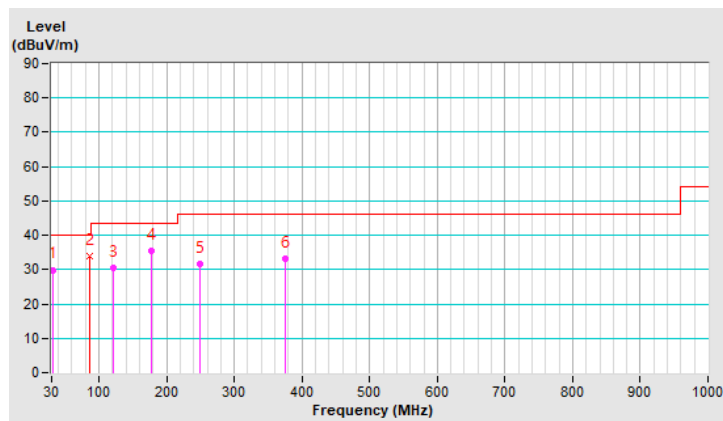

|                        |                  |                          |                 |
|------------------------|------------------|--------------------------|-----------------|
| <b>Channel</b>         | CH 2 : 60.48 GHz |                          |                 |
| <b>Frequency Range</b> | 9kHz ~ 1GHz      | <b>Detector Function</b> | Quasi-Peak (QP) |

| Antenna Polarity & Test Distance : Vertical at 3 m |                 |                         |                |             |                    |                      |                  |                          |
|--|-----------------|-------------------------|----------------|-------------|--------------------|----------------------|------------------|--------------------------|
| No   | Frequency (MHz) | Emission Level (dBUV/m) | Limit (dBUV/m) | Margin (dB) | Antenna Height (m) | Table Angle (Degree) | Raw Value (dBUV) | Correction Factor (dB/m) |
| 1  | 43.04           | 34.0 QP                 | 40.0           | -6.0        | 1.00 V             | 232                  | 41.9             | -7.9                     |
| 2  | 82.66           | 34.9 QP                 | 40.0           | -5.1        | 1.00 V             | 63                   | 47.7             | -12.8                    |
| 3  | 121.01          | 30.0 QP                 | 43.5           | -13.5       | 2.00 V             | 152                  | 38.9             | -8.9                     |
| 4  | 175.17          | 35.9 QP                 | 43.5           | -7.6        | 3.00 V             | 137                  | 43.9             | -8.0                     |
| 5  | 208.15          | 30.1 QP                 | 43.5           | -13.4       | 1.00 V             | 147                  | 40.1             | -10.0                    |
| 6  | 875.00          | 31.0 QP                 | 46.0           | -15.0       | 1.50 V             | 229                  | 24.0             | 7.0                      |

**Remarks:**

1. Emission Level(dBuV/m) = Raw Value(dBuV) + Correction Factor(dB/m)
2. Correction Factor(dB/m) = Antenna Factor(dB/m) + Cable Factor(dB) – Pre-Amplifier Factor(dB)
3. Margin value = Emission Level – Limit value
4. The other emission levels were very low against the limit of frequency range 30MHz~1000MHz.
5. The emission levels were very low against the limit of frequency range 9kHz~30MHz: the amplitude of spurious emissions attenuated more than 20 dB below the permissible value to be report.

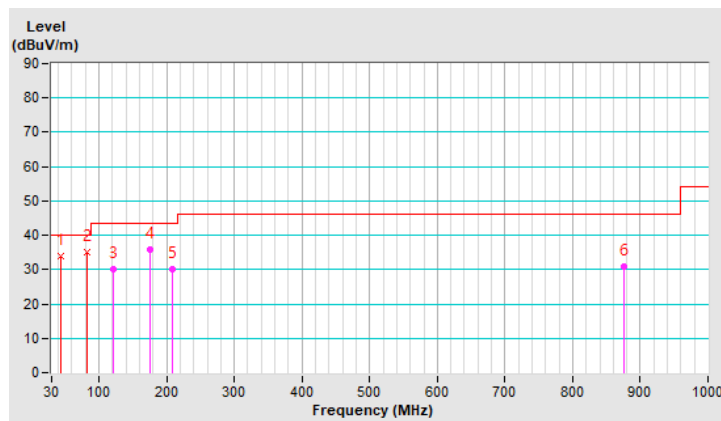

|                        |                  |                          |                 |
|------------------------|------------------|--------------------------|-----------------|
| <b>Channel</b>         | CH 3 : 62.64 GHz |                          |                 |
| <b>Frequency Range</b> | 9kHz ~ 1GHz      | <b>Detector Function</b> | Quasi-Peak (QP) |

| Antenna Polarity & Test Distance : Horizontal at 3 m |                 |                         |                |             |                    |                      |                  |                          |
|--|-----------------|-------------------------|----------------|-------------|--------------------|----------------------|------------------|--------------------------|
| No   | Frequency (MHz) | Emission Level (dBuV/m) | Limit (dBuV/m) | Margin (dB) | Antenna Height (m) | Table Angle (Degree) | Raw Value (dBuV) | Correction Factor (dB/m) |
| 1  | 31.99           | 30.0 QP                 | 40.0           | -10.0       | 1.00 H             | 63                   | 38.8             | -8.8                     |
| 2  | 86.84           | 33.7 QP                 | 40.0           | -6.3        | 3.00 H             | 77                   | 46.8             | -13.1                    |
| 3  | 121.37          | 30.3 QP                 | 43.5           | -13.2       | 3.00 H             | 142                  | 39.2             | -8.9                     |
| 4  | 176.83          | 35.4 QP                 | 43.5           | -8.1        | 2.00 H             | 209                  | 43.6             | -8.2                     |
| 5  | 250.01          | 31.4 QP                 | 46.0           | -14.6       | 1.00 H             | 37                   | 39.4             | -8.0                     |
| 6  | 374.98          | 33.0 QP                 | 46.0           | -13.0       | 1.00 H             | 41                   | 36.7             | -3.7                     |

**Remarks:**

1. Emission Level(dBuV/m) = Raw Value(dBuV) + Correction Factor(dB/m)
2. Correction Factor(dB/m) = Antenna Factor(dB/m) + Cable Factor(dB) – Pre-Amplifier Factor(dB)
3. Margin value = Emission Level – Limit value
4. The other emission levels were very low against the limit of frequency range 30MHz~1000MHz.
5. The emission levels were very low against the limit of frequency range 9kHz~30MHz: the amplitude of spurious emissions attenuated more than 20 dB below the permissible value to be report.

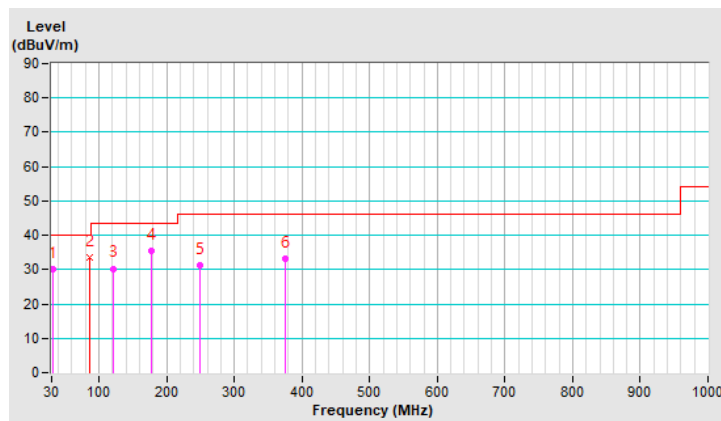

|                        |                  |                          |                 |
|------------------------|------------------|--------------------------|-----------------|
| <b>Channel</b>         | CH 3 : 62.64 GHz |                          |                 |
| <b>Frequency Range</b> | 9kHz ~ 1GHz      | <b>Detector Function</b> | Quasi-Peak (QP) |

| Antenna Polarity & Test Distance : Vertical at 3 m |                 |                         |                |             |                    |                      |                  |                          |
|--|-----------------|-------------------------|----------------|-------------|--------------------|----------------------|------------------|--------------------------|
| No   | Frequency (MHz) | Emission Level (dBuV/m) | Limit (dBuV/m) | Margin (dB) | Antenna Height (m) | Table Angle (Degree) | Raw Value (dBuV) | Correction Factor (dB/m) |
| 1  | 43.10           | 34.2 QP                 | 40.0           | -5.8        | 1.00 V             | 227                  | 42.1             | -7.9                     |
| 2  | 82.73           | 35.1 QP                 | 40.0           | -4.9        | 1.00 V             | 81                   | 48.0             | -12.9                    |
| 3  | 121.06          | 30.1 QP                 | 43.5           | -13.4       | 2.00 V             | 149                  | 39.0             | -8.9                     |
| 4  | 175.23          | 36.2 QP                 | 43.5           | -7.3        | 3.00 V             | 143                  | 44.2             | -8.0                     |
| 5  | 208.21          | 30.3 QP                 | 43.5           | -13.2       | 1.00 V             | 163                  | 40.3             | -10.0                    |
| 6  | 875.02          | 31.2 QP                 | 46.0           | -14.8       | 1.50 V             | 209                  | 24.2             | 7.0                      |

**Remarks:**

1. Emission Level(dBuV/m) = Raw Value(dBuV) + Correction Factor(dB/m)
2. Correction Factor(dB/m) = Antenna Factor(dB/m) + Cable Factor(dB) – Pre-Amplifier Factor(dB)
3. Margin value = Emission Level – Limit value
4. The other emission levels were very low against the limit of frequency range 30MHz~1000MHz.
5. The emission levels were very low against the limit of frequency range 9kHz~30MHz: the amplitude of spurious emissions attenuated more than 20 dB below the permissible value to be report.

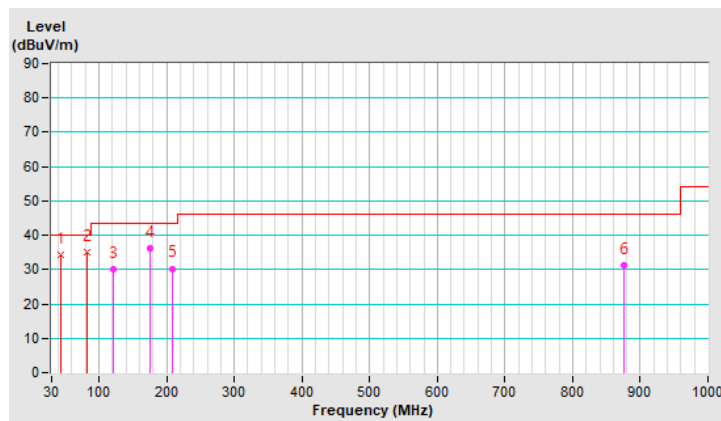

|                        |                 |                          |                 |
|------------------------|-----------------|--------------------------|-----------------|
| <b>Channel</b>         | CH 4 : 64.8 GHz |                          |                 |
| <b>Frequency Range</b> | 9kHz ~ 1GHz     | <b>Detector Function</b> | Quasi-Peak (QP) |

| Antenna Polarity & Test Distance : Horizontal at 3 m |                 |                         |                |             |                    |                      |                  |                          |
|--|-----------------|-------------------------|----------------|-------------|--------------------|----------------------|------------------|--------------------------|
| No   | Frequency (MHz) | Emission Level (dBuV/m) | Limit (dBuV/m) | Margin (dB) | Antenna Height (m) | Table Angle (Degree) | Raw Value (dBuV) | Correction Factor (dB/m) |
| 1  | 31.94           | 29.8 QP                 | 40.0           | -10.2       | 1.00 H             | 86                   | 38.6             | -8.8                     |
| 2  | 86.78           | 33.5 QP                 | 40.0           | -6.5        | 3.00 H             | 84                   | 46.6             | -13.1                    |
| 3  | 121.30          | 30.1 QP                 | 43.5           | -13.4       | 3.00 H             | 135                  | 39.0             | -8.9                     |
| 4  | 176.78          | 35.2 QP                 | 43.5           | -8.3        | 2.00 H             | 214                  | 43.4             | -8.2                     |
| 5  | 250.02          | 31.2 QP                 | 46.0           | -14.8       | 1.00 H             | 43                   | 39.2             | -8.0                     |
| 6  | 375.01          | 33.2 QP                 | 46.0           | -12.8       | 1.00 H             | 73                   | 36.9             | -3.7                     |

**Remarks:**

1. Emission Level(dBuV/m) = Raw Value(dBuV) + Correction Factor(dB/m)
2. Correction Factor(dB/m) = Antenna Factor(dB/m) + Cable Factor(dB) – Pre-Amplifier Factor(dB)
3. Margin value = Emission Level – Limit value
4. The other emission levels were very low against the limit of frequency range 30MHz~1000MHz.
5. The emission levels were very low against the limit of frequency range 9kHz~30MHz: the amplitude of spurious emissions attenuated more than 20 dB below the permissible value to be report.

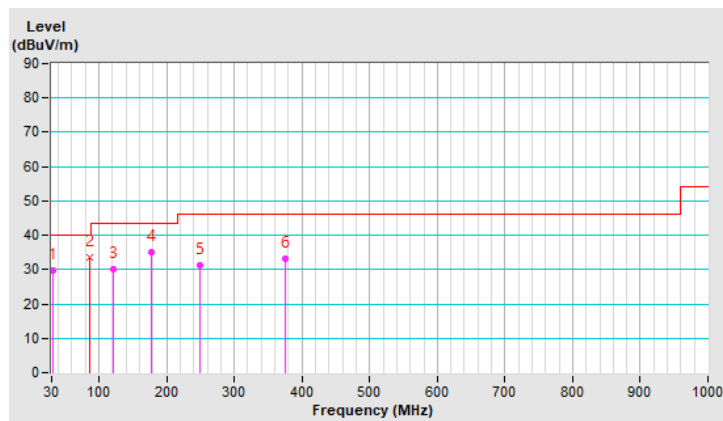

|                        |                 |                          |                 |
|------------------------|-----------------|--------------------------|-----------------|
| <b>Channel</b>         | CH 4 : 64.8 GHz |                          |                 |
| <b>Frequency Range</b> | 9kHz ~ 1GHz     | <b>Detector Function</b> | Quasi-Peak (QP) |

| Antenna Polarity & Test Distance : Vertical at 3 m |                 |                         |                |             |                    |                      |                  |                          |
|--|-----------------|-------------------------|----------------|-------------|--------------------|----------------------|------------------|--------------------------|
| No   | Frequency (MHz) | Emission Level (dBuV/m) | Limit (dBuV/m) | Margin (dB) | Antenna Height (m) | Table Angle (Degree) | Raw Value (dBuV) | Correction Factor (dB/m) |
| 1  | 43.17           | 34.3 QP                 | 40.0           | -5.7        | 1.00 V             | 258                  | 42.2             | -7.9                     |
| 2  | 82.78           | 35.3 QP                 | 40.0           | -4.7        | 1.00 V             | 76                   | 48.2             | -12.9                    |
| 3  | 121.13          | 30.3 QP                 | 43.5           | -13.2       | 2.00 V             | 135                  | 39.2             | -8.9                     |
| 4  | 175.32          | 36.4 QP                 | 43.5           | -7.1        | 3.00 V             | 158                  | 44.4             | -8.0                     |
| 5  | 208.26          | 30.5 QP                 | 43.5           | -13.0       | 1.00 V             | 176                  | 40.5             | -10.0                    |
| 6  | 874.99          | 31.4 QP                 | 46.0           | -14.6       | 1.50 V             | 224                  | 24.4             | 7.0                      |

**Remarks:**

1. Emission Level(dBuV/m) = Raw Value(dBuV) + Correction Factor(dB/m)
2. Correction Factor(dB/m) = Antenna Factor(dB/m) + Cable Factor(dB) – Pre-Amplifier Factor(dB)
3. Margin value = Emission Level – Limit value
4. The other emission levels were very low against the limit of frequency range 30MHz~1000MHz.
5. The emission levels were very low against the limit of frequency range 9kHz~30MHz: the amplitude of spurious emissions attenuated more than 20 dB below the permissible value to be report.

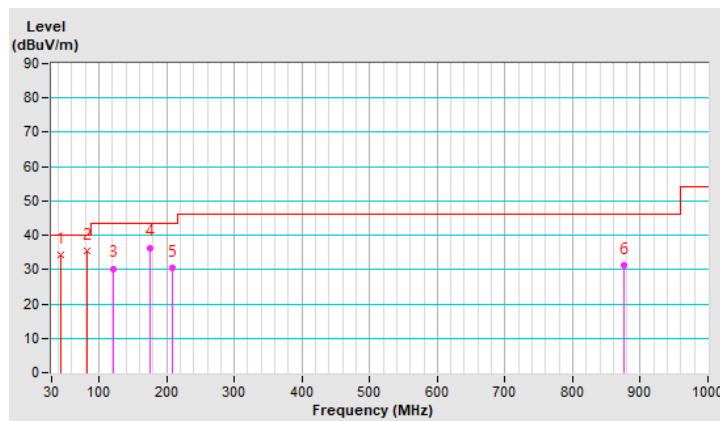

## 4.2 Conducted Emission Measurement

### 4.2.1 Limits of Conducted Emission Measurement

| Frequency (MHz) | Conducted Limit (dBuV) |         |
|-----------------|------------------------|---------|
|                 | Quasi-peak             | Average |
| 0.15 - 0.5      | 66 - 56                | 56 - 46 |
| 0.50 - 5.0      | 56                     | 46      |
| 5.0 - 30.0      | 60                     | 50      |

Note: 1. The lower limit shall apply at the transition frequencies.

2. The limit decreases in line with the logarithm of the frequency in the range of 0.15 to 0.50MHz.

### 4.2.2 Test Instruments

| DESCRIPTION & MANUFACTURER   | MODEL NO.               | SERIAL NO. | CALIBRATED DATE | CALIBRATED UNTIL |
|--|-------------------------|------------|-----------------|------------------|
| Test Receiver<br>R&S   | ESCS 30                 | 847124/029 | Oct. 20, 2020   | Oct. 19, 2021    |
| Line-Impedance<br>Stabilization Network (for<br>EUT)<br>R&S        | ESH3-Z5                 | 848773/004 | Oct. 27, 2020   | Oct. 26, 2021    |
| Line-Impedance<br>Stabilization Network<br>(for Peripheral)<br>R&S | ESH3-Z5                 | 835239/001 | Mar. 19, 2020   | Mar. 18, 2021    |
| 50 ohms Terminator   | 50                      | 3          | Oct. 26, 2020   | Oct. 25, 2021    |
| RF Cable   | 5D-FB                   | COCCAB-001 | Sep. 26, 2020   | Sep. 25, 2021    |
| Fixed attenuator<br>EMCI   | STI02-2200-10           | 005        | Aug. 29, 2020   | Aug. 28, 2021    |
| Software<br>BVADT  | BVADT_Cond_<br>V7.3.7.4 | NA         | NA              | NA               |

**Note:**

1. The calibration interval of the above test instruments are 12 months and the calibrations are traceable to NML/ROC and NIST/USA.
2. The test was performed in Conduction 1.
- 3 Tested Date: Dec. 08, 2020

#### 4.2.3 Test Procedures

- The EUT was placed 0.4 meters from the conducting wall of the shielded room with EUT being connected to the power mains through a line impedance stabilization network (LISN). Other support units were connected to the power mains through another LISN. The two LISNs provide 50 ohm/ 50uH of coupling impedance for the measuring instrument.
- Both lines of the power mains connected to the EUT were checked for maximum conducted interference.
- The frequency range from 150kHz to 30MHz was searched. Emission levels under (Limit - 20dB) was not recorded.

**Note:** The resolution bandwidth and video bandwidth of test receiver is 9kHz for quasi-peak detection (QP) and average detection (AV) at frequency 0.15MHz-30MHz.

#### 4.2.4 Deviation from Test Standard

No deviation.

#### 4.2.5 Test Setup

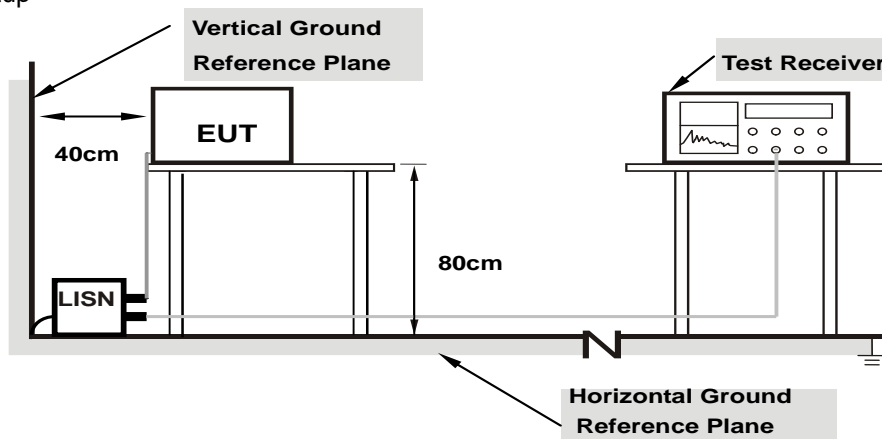

**Note:** 1.Support units were connected to second LISN.

For the actual test configuration, please refer to the attached file (Test Setup Photo).

#### 4.2.6 EUT Operating Conditions

Same as 4.1.6.



#### 4.2.7 Test Results

|                        |                  |  |                                      |
|------------------------|------------------|--|--------------------------------------|
| <b>Channel</b>         | CH 1 : 58.32 GHz |  |                                      |
| <b>Frequency Range</b> | 150kHz ~ 30MHz   | <b>Detector Function &amp; Bandwidth</b> | Quasi-Peak (QP) / Average (AV), 9kHz |

| Phase Of Power : Line (L) |                 |                        |                      |       |                       |       |              |       |             |        |
|---------------------------|-----------------|------------------------|----------------------|-------|-----------------------|-------|--------------|-------|-------------|--------|
| No                        | Frequency (MHz) | Correction Factor (dB) | Reading Value (dBuV) |       | Emission Level (dBuV) |       | Limit (dBuV) |       | Margin (dB) |        |
|                           |                 |                        | Q.P.                 | AV.   | Q.P.                  | AV.   | Q.P.         | AV.   | Q.P.        | AV.    |
| 1                         | 0.16172         | 9.95                   | 41.85                | 25.95 | 51.80                 | 35.90 | 65.38        | 55.38 | -13.58      | -19.48 |
| 2                         | 0.20859         | 9.97                   | 32.92                | 18.69 | 42.89                 | 28.66 | 63.26        | 53.26 | -20.37      | -24.60 |
| 3                         | 0.53281         | 10.00                  | 40.99                | 31.15 | 50.99                 | 41.15 | 56.00        | 46.00 | -5.01       | -4.85  |
| 4                         | 3.01563         | 10.12                  | 27.77                | 18.71 | 37.89                 | 28.83 | 56.00        | 46.00 | -18.11      | -17.17 |
| 5                         | 12.05859        | 10.65                  | 31.34                | 24.82 | 41.99                 | 35.47 | 60.00        | 50.00 | -18.01      | -14.53 |
| 6                         | 13.60156        | 10.75                  | 34.88                | 28.38 | 45.63                 | 39.13 | 60.00        | 50.00 | -14.37      | -10.87 |

**Remarks:**

1. Q.P. and AV. are abbreviations of quasi-peak and average individually.
2. The emission levels of other frequencies were very low against the limit.
3. Margin value = Emission level – Limit value
4. Correction factor = Insertion loss + Cable loss
5. Emission Level = Correction Factor + Reading Value

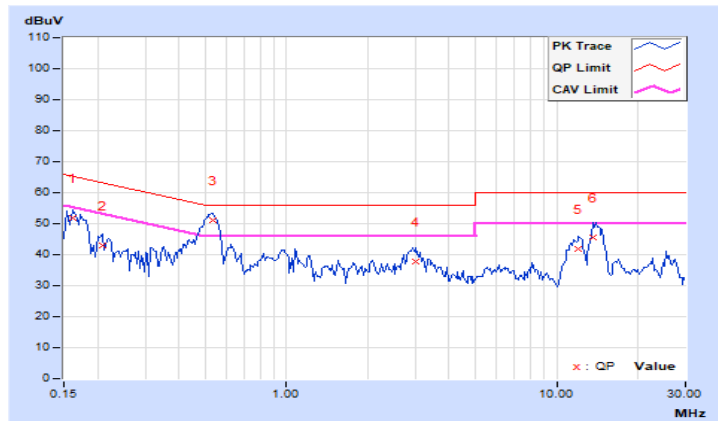

|                        |                  |  |                                      |
|------------------------|------------------|--|--------------------------------------|
| <b>Channel</b>         | CH 1 : 58.32 GHz |  |                                      |
| <b>Frequency Range</b> | 150kHz ~ 30MHz   | <b>Detector Function &amp; Bandwidth</b> | Quasi-Peak (QP) / Average (AV), 9kHz |

| Phase Of Power : Neutral (N) |                 |                        |                      |       |                       |       |              |       |             |        |
|------------------------------|-----------------|------------------------|----------------------|-------|-----------------------|-------|--------------|-------|-------------|--------|
| No                           | Frequency (MHz) | Correction Factor (dB) | Reading Value (dBuV) |       | Emission Level (dBuV) |       | Limit (dBuV) |       | Margin (dB) |        |
|                              |                 |                        | Q.P.                 | AV.   | Q.P.                  | AV.   | Q.P.         | AV.   | Q.P.        | AV.    |
| 1                            | 0.15781         | 9.92                   | 43.46                | 25.85 | 53.38                 | 35.77 | 65.58        | 55.58 | -12.20      | -19.81 |
| 2                            | 0.16953         | 9.93                   | 41.86                | 26.53 | 51.79                 | 36.46 | 64.98        | 54.98 | -13.19      | -18.52 |
| 3                            | 0.19687         | 9.95                   | 35.76                | 18.23 | 45.71                 | 28.18 | 63.74        | 53.74 | -18.03      | -25.56 |
| 4                            | 0.53281         | 9.97                   | 40.49                | 30.30 | 50.46                 | 40.27 | 56.00        | 46.00 | -5.54       | -5.73  |
| 5                            | 11.66406        | 10.48                  | 30.30                | 23.51 | 40.78                 | 33.99 | 60.00        | 50.00 | -19.22      | -16.01 |
| 6                            | 13.98047        | 10.59                  | 32.61                | 26.18 | 43.20                 | 36.77 | 60.00        | 50.00 | -16.80      | -13.23 |

**Remarks:**

1. Q.P. and AV. are abbreviations of quasi-peak and average individually.
2. The emission levels of other frequencies were very low against the limit.
3. Margin value = Emission level – Limit value
4. Correction factor = Insertion loss + Cable loss
5. Emission Level = Correction Factor + Reading Value

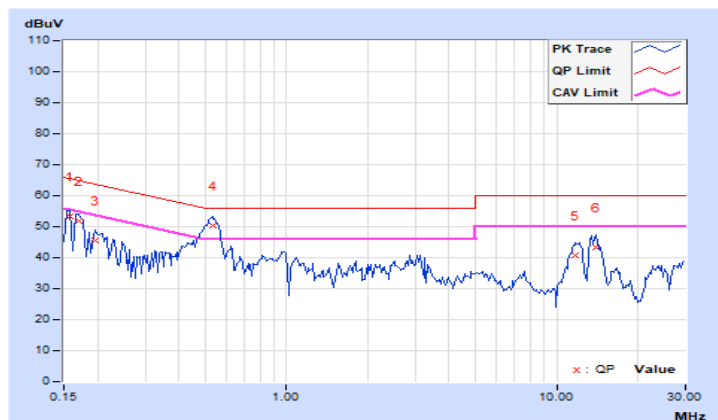

|                        |                  |  |                                      |
|------------------------|------------------|--|--------------------------------------|
| <b>Channel</b>         | CH 2 : 60.48 GHz |  |                                      |
| <b>Frequency Range</b> | 150kHz ~ 30MHz   | <b>Detector Function &amp; Bandwidth</b> | Quasi-Peak (QP) / Average (AV), 9kHz |

| Phase Of Power : Line (L) |                 |                        |                      |              |                       |              |              |              |              |              |
|---------------------------|-----------------|------------------------|----------------------|--------------|-----------------------|--------------|--------------|--------------|--------------|--------------|
| No                        | Frequency (MHz) | Correction Factor (dB) | Reading Value (dBuV) |              | Emission Level (dBuV) |              | Limit (dBuV) |              | Margin (dB)  |              |
|                           |                 |                        | Q.P.                 | AV.          | Q.P.                  | AV.          | Q.P.         | AV.          | Q.P.         | AV.          |
| 1                         | 0.15000         | 9.95                   | 33.90                | 12.31        | 43.85                 | 22.26        | 66.00        | 56.00        | -22.15       | -33.74       |
| 2                         | 0.16562         | 9.96                   | 41.15                | 26.28        | 51.11                 | 36.24        | 65.18        | 55.18        | -14.07       | -18.94       |
| <b>3</b>                  | <b>0.52891</b>  | <b>10.00</b>           | <b>40.83</b>         | <b>31.57</b> | <b>50.83</b>          | <b>41.57</b> | <b>56.00</b> | <b>46.00</b> | <b>-5.17</b> | <b>-4.43</b> |
| 4                         | 0.99375         | 10.03                  | 27.54                | 16.79        | 37.57                 | 26.82        | 56.00        | 46.00        | -18.43       | -19.18       |
| 5                         | 3.01172         | 10.12                  | 27.65                | 18.43        | 37.77                 | 28.55        | 56.00        | 46.00        | -18.23       | -17.45       |
| 6                         | 11.69141        | 10.63                  | 31.18                | 24.74        | 41.81                 | 35.37        | 60.00        | 50.00        | -18.19       | -14.63       |
| 7                         | 13.91016        | 10.76                  | 35.97                | 29.53        | 46.73                 | 40.29        | 60.00        | 50.00        | -13.27       | -9.71        |

**Remarks:**

1. Q.P. and AV. are abbreviations of quasi-peak and average individually.
2. The emission levels of other frequencies were very low against the limit.
3. Margin value = Emission level – Limit value
4. Correction factor = Insertion loss + Cable loss
5. Emission Level = Correction Factor + Reading Value

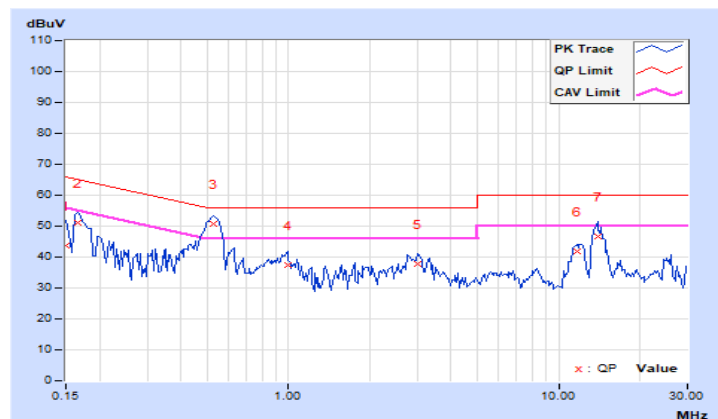

|                        |                  |  |                                      |
|------------------------|------------------|--|--------------------------------------|
| <b>Channel</b>         | CH 2 : 60.48 GHz |  |                                      |
| <b>Frequency Range</b> | 150kHz ~ 30MHz   | <b>Detector Function &amp; Bandwidth</b> | Quasi-Peak (QP) / Average (AV), 9kHz |

| Phase Of Power : Neutral (N) |                 |                        |                      |       |                       |       |              |       |             |        |
|------------------------------|-----------------|------------------------|----------------------|-------|-----------------------|-------|--------------|-------|-------------|--------|
| No                           | Frequency (MHz) | Correction Factor (dB) | Reading Value (dBuV) |       | Emission Level (dBuV) |       | Limit (dBuV) |       | Margin (dB) |        |
|                              |                 |                        | Q.P.                 | AV.   | Q.P.                  | AV.   | Q.P.         | AV.   | Q.P.        | AV.    |
| 1                            | 0.15391         | 9.92                   | 42.84                | 21.29 | 52.76                 | 31.21 | 65.79        | 55.79 | -13.03      | -24.58 |
| 2                            | 0.17344         | 9.93                   | 40.70                | 24.76 | 50.63                 | 34.69 | 64.79        | 54.79 | -14.16      | -20.10 |
| 3                            | 0.21250         | 9.95                   | 32.82                | 18.73 | 42.77                 | 28.68 | 63.11        | 53.11 | -20.34      | -24.43 |
| 4                            | 0.52500         | 9.97                   | 40.65                | 31.13 | 50.62                 | 41.10 | 56.00        | 46.00 | -5.38       | -4.90  |
| 5                            | 12.05469        | 10.50                  | 30.84                | 24.09 | 41.34                 | 34.59 | 60.00        | 50.00 | -18.66      | -15.41 |
| 6                            | 13.84766        | 10.58                  | 33.04                | 26.70 | 43.62                 | 37.28 | 60.00        | 50.00 | -16.38      | -12.72 |

**Remarks:**

1. Q.P. and AV. are abbreviations of quasi-peak and average individually.
2. The emission levels of other frequencies were very low against the limit.
3. Margin value = Emission level – Limit value
4. Correction factor = Insertion loss + Cable loss
5. Emission Level = Correction Factor + Reading Value

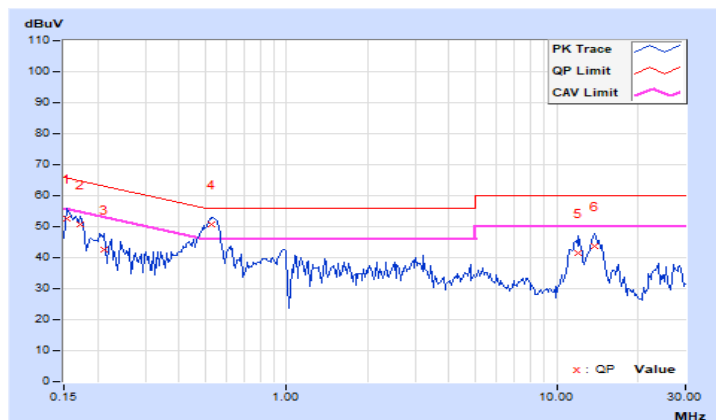

|                        |                  |  |                                      |
|------------------------|------------------|--|--------------------------------------|
| <b>Channel</b>         | CH 3 : 62.64 GHz |  |                                      |
| <b>Frequency Range</b> | 150kHz ~ 30MHz   | <b>Detector Function &amp; Bandwidth</b> | Quasi-Peak (QP) / Average (AV), 9kHz |

| Phase Of Power : Line (L) |                 |                        |                      |       |                       |       |              |       |             |        |
|---------------------------|-----------------|------------------------|----------------------|-------|-----------------------|-------|--------------|-------|-------------|--------|
| No                        | Frequency (MHz) | Correction Factor (dB) | Reading Value (dBuV) |       | Emission Level (dBuV) |       | Limit (dBuV) |       | Margin (dB) |        |
|                           |                 |                        | Q.P.                 | AV.   | Q.P.                  | AV.   | Q.P.         | AV.   | Q.P.        | AV.    |
| 1                         | 0.15781         | 9.95                   | 42.39                | 24.83 | 52.34                 | 34.78 | 65.58        | 55.58 | -13.24      | -20.80 |
| 2                         | 0.17734         | 9.96                   | 39.62                | 22.34 | 49.58                 | 32.30 | 64.61        | 54.61 | -15.03      | -22.31 |
| 3                         | 0.53281         | 10.00                  | 40.77                | 31.33 | 50.77                 | 41.33 | 56.00        | 46.00 | -5.23       | -4.67  |
| 4                         | 3.14844         | 10.13                  | 26.70                | 17.71 | 36.83                 | 27.84 | 56.00        | 46.00 | -19.17      | -18.16 |
| 5                         | 11.62891        | 10.63                  | 30.79                | 24.55 | 41.42                 | 35.18 | 60.00        | 50.00 | -18.58      | -14.82 |
| 6                         | 14.18359        | 10.78                  | 35.19                | 29.14 | 45.97                 | 39.92 | 60.00        | 50.00 | -14.03      | -10.08 |

**Remarks:**

1. Q.P. and AV. are abbreviations of quasi-peak and average individually.
2. The emission levels of other frequencies were very low against the limit.
3. Margin value = Emission level – Limit value
4. Correction factor = Insertion loss + Cable loss
5. Emission Level = Correction Factor + Reading Value

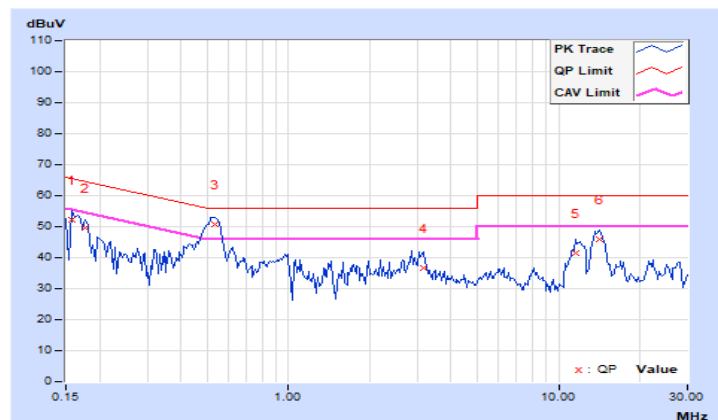

|                        |                  |  |                                      |
|------------------------|------------------|--|--------------------------------------|
| <b>Channel</b>         | CH 3 : 62.64 GHz |  |                                      |
| <b>Frequency Range</b> | 150kHz ~ 30MHz   | <b>Detector Function &amp; Bandwidth</b> | Quasi-Peak (QP) / Average (AV), 9kHz |

| Phase Of Power : Neutral (N) |                 |                        |                      |       |                       |       |              |       |             |        |
|------------------------------|-----------------|------------------------|----------------------|-------|-----------------------|-------|--------------|-------|-------------|--------|
| No                           | Frequency (MHz) | Correction Factor (dB) | Reading Value (dBuV) |       | Emission Level (dBuV) |       | Limit (dBuV) |       | Margin (dB) |        |
|                              |                 |                        | Q.P.                 | AV.   | Q.P.                  | AV.   | Q.P.         | AV.   | Q.P.        | AV.    |
| 1                            | 0.15781         | 9.92                   | 43.20                | 26.86 | 53.12                 | 36.78 | 65.58        | 55.58 | -12.46      | -18.80 |
| 2                            | 0.21641         | 9.95                   | 33.63                | 18.11 | 43.58                 | 28.06 | 62.96        | 52.96 | -19.38      | -24.90 |
| 3                            | 0.52891         | 9.97                   | 40.67                | 30.18 | 50.64                 | 40.15 | 56.00        | 46.00 | -5.36       | -5.85  |
| 4                            | 2.72266         | 10.07                  | 24.76                | 17.43 | 34.83                 | 27.50 | 56.00        | 46.00 | -21.17      | -18.50 |
| 5                            | 11.80078        | 10.49                  | 30.41                | 23.82 | 40.90                 | 34.31 | 60.00        | 50.00 | -19.10      | -15.69 |
| 6                            | 14.02344        | 10.59                  | 33.07                | 26.75 | 43.66                 | 37.34 | 60.00        | 50.00 | -16.34      | -12.66 |

**Remarks:**

1. Q.P. and AV. are abbreviations of quasi-peak and average individually.
2. The emission levels of other frequencies were very low against the limit.
3. Margin value = Emission level – Limit value
4. Correction factor = Insertion loss + Cable loss
5. Emission Level = Correction Factor + Reading Value

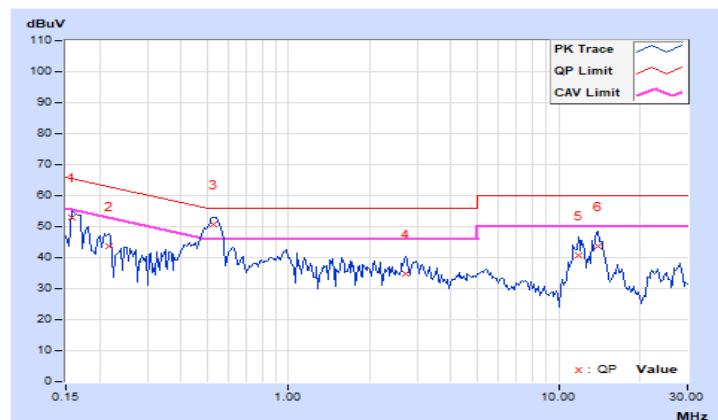

|                        |                 |  |                                      |
|------------------------|-----------------|--|--------------------------------------|
| <b>Channel</b>         | CH 4 : 64.8 GHz |  |                                      |
| <b>Frequency Range</b> | 150kHz ~ 30MHz  | <b>Detector Function &amp; Bandwidth</b> | Quasi-Peak (QP) / Average (AV), 9kHz |

| Phase Of Power : Line (L) |                 |                        |                      |       |                       |       |              |       |             |        |
|---------------------------|-----------------|------------------------|----------------------|-------|-----------------------|-------|--------------|-------|-------------|--------|
| No                        | Frequency (MHz) | Correction Factor (dB) | Reading Value (dBuV) |       | Emission Level (dBuV) |       | Limit (dBuV) |       | Margin (dB) |        |
|                           |                 |                        | Q.P.                 | AV.   | Q.P.                  | AV.   | Q.P.         | AV.   | Q.P.        | AV.    |
| 1                         | 0.16172         | 9.95                   | 41.91                | 26.50 | 51.86                 | 36.45 | 65.38        | 55.38 | -13.52      | -18.93 |
| 2                         | 0.16953         | 9.96                   | 40.88                | 25.47 | 50.84                 | 35.43 | 64.98        | 54.98 | -14.14      | -19.55 |
| 3                         | 0.53281         | 10.00                  | 40.95                | 31.15 | 50.95                 | 41.15 | 56.00        | 46.00 | -5.05       | -4.85  |
| 4                         | 0.97031         | 10.03                  | 27.31                | 16.67 | 37.34                 | 26.70 | 56.00        | 46.00 | -18.66      | -19.30 |
| 5                         | 11.91797        | 10.65                  | 31.67                | 25.36 | 42.32                 | 36.01 | 60.00        | 50.00 | -17.68      | -13.99 |
| 6                         | 13.54688        | 10.74                  | 34.10                | 27.45 | 44.84                 | 38.19 | 60.00        | 50.00 | -15.16      | -11.81 |

**Remarks:**

1. Q.P. and AV. are abbreviations of quasi-peak and average individually.
2. The emission levels of other frequencies were very low against the limit.
3. Margin value = Emission level – Limit value
4. Correction factor = Insertion loss + Cable loss
5. Emission Level = Correction Factor + Reading Value

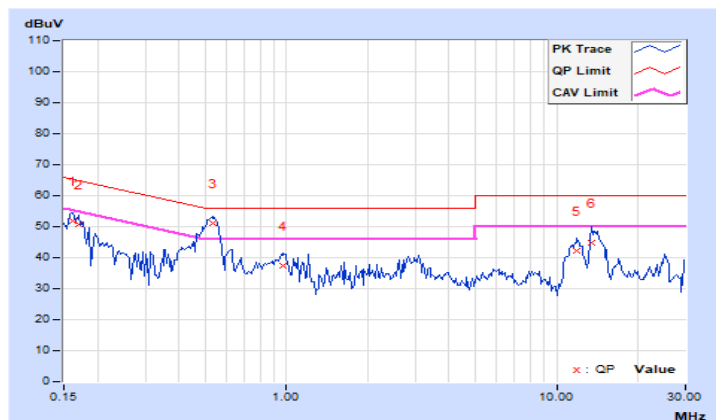

|                        |                 |  |                                      |
|------------------------|-----------------|--|--------------------------------------|
| <b>Channel</b>         | CH 4 : 64.8 GHz |  |                                      |
| <b>Frequency Range</b> | 150kHz ~ 30MHz  | <b>Detector Function &amp; Bandwidth</b> | Quasi-Peak (QP) / Average (AV), 9kHz |

| Phase Of Power : Neutral (N) |                 |                        |                      |       |                       |       |              |       |             |        |
|------------------------------|-----------------|------------------------|----------------------|-------|-----------------------|-------|--------------|-------|-------------|--------|
| No                           | Frequency (MHz) | Correction Factor (dB) | Reading Value (dBuV) |       | Emission Level (dBuV) |       | Limit (dBuV) |       | Margin (dB) |        |
|                              |                 |                        | Q.P.                 | AV.   | Q.P.                  | AV.   | Q.P.         | AV.   | Q.P.        | AV.    |
| 1                            | 0.15391         | 9.92                   | 42.09                | 22.57 | 52.01                 | 32.49 | 65.79        | 55.79 | -13.78      | -23.30 |
| 2                            | 0.16562         | 9.93                   | 41.91                | 26.68 | 51.84                 | 36.61 | 65.18        | 55.18 | -13.34      | -18.57 |
| 3                            | 0.18516         | 9.94                   | 34.15                | 12.08 | 44.09                 | 22.02 | 64.25        | 54.25 | -20.16      | -32.23 |
| 4                            | 0.53672         | 9.97                   | 40.83                | 31.49 | 50.80                 | 41.46 | 56.00        | 46.00 | -5.20       | -4.54  |
| 5                            | 12.09766        | 10.50                  | 30.44                | 23.65 | 40.94                 | 34.15 | 60.00        | 50.00 | -19.06      | -15.85 |
| 6                            | 14.10156        | 10.59                  | 33.19                | 26.73 | 43.78                 | 37.32 | 60.00        | 50.00 | -16.22      | -12.68 |

**Remarks:**

1. Q.P. and AV. are abbreviations of quasi-peak and average individually.
2. The emission levels of other frequencies were very low against the limit.
3. Margin value = Emission level – Limit value
4. Correction factor = Insertion loss + Cable loss
5. Emission Level = Correction Factor + Reading Value

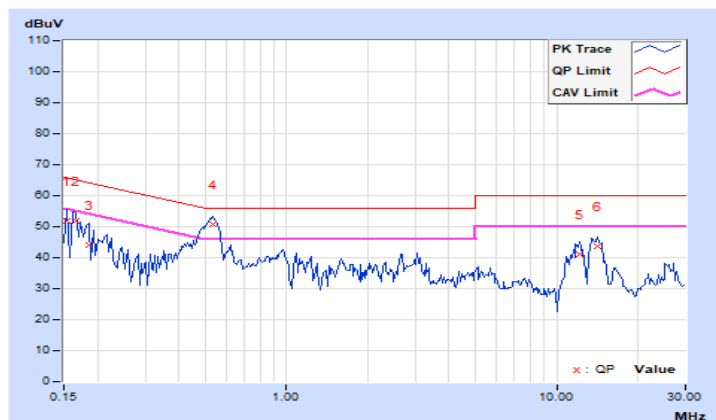



### 4.3 6dB Bandwidth Measurement

#### 4.3.1 Limits of 6dB Bandwidth Measurement

None: For reporting purposes only.

#### 4.3.2 Test Setup

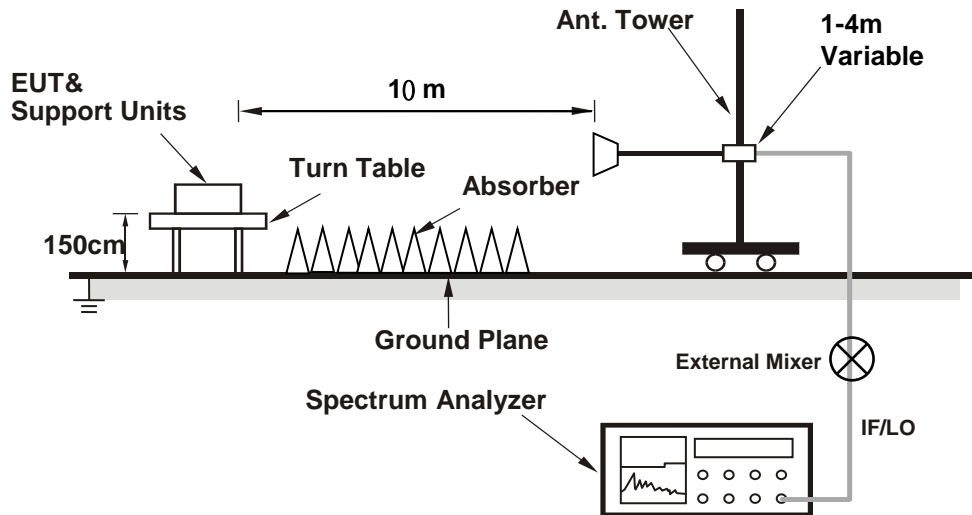

#### 4.3.3 Test Instruments

Refer to section 4.1.2 to get information of above instrument.

#### 4.3.4 Test Procedure

- Set resolution bandwidth (RBW) = 100kHz
- Set the video bandwidth (VBW)  $\geq 3 \times$  RBW, Detector = Peak.
- Trace mode = max hold.
- Sweep = auto couple.
- Measure the maximum width of the emission that is constrained by the frequencies associated with the two amplitude points (upper and lower) that are attenuated by 6 dB relative to the maximum level measured in the fundamental emission

#### 4.3.5 Deviation from Test Standard

No deviation.

#### 4.3.6 EUT Operating Conditions

The software provided by client to enable the EUT under transmission condition continuously at lowest, middle and highest channel frequencies individually.

### 4.3.7 Test Result

| Channel | Frequency (GHz) | 6dB Bandwidth (MHz) |
|---------|-----------------|---------------------|
| 1       | 58.32           | 930.00              |
| 2       | 60.48           | 768.00              |
| 3       | 62.64           | 993.20              |
| 4       | 64.8            | 853.90              |

Spectrum Plot of Worst Value

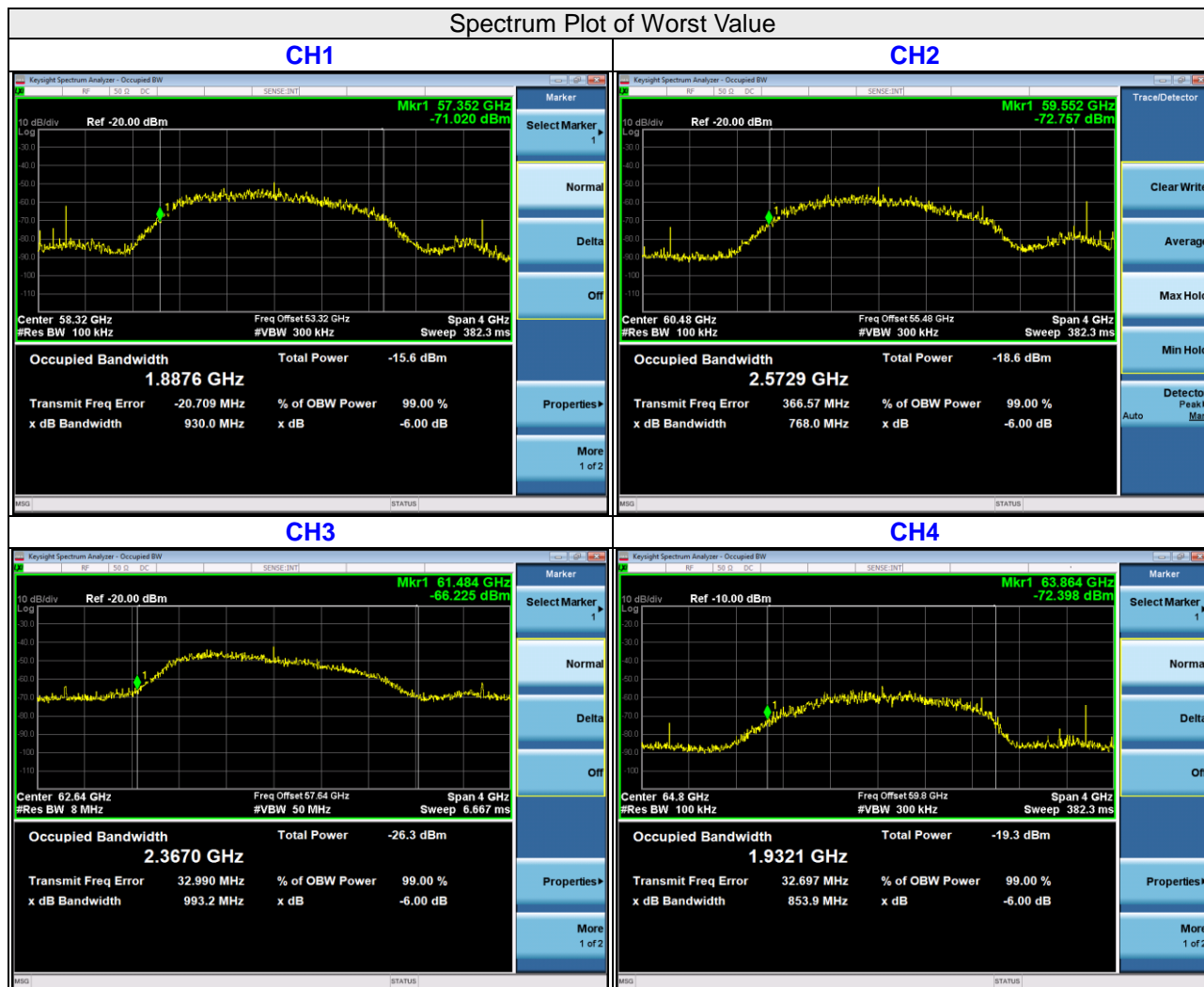

#### 4.4 Output Power Measurement

##### 4.4.1 Limits of Output Power Measurement

15.255 (c) & (e)

| Output Power (EIRP) |  |     |  |                 |                 |
|---------------------|--|-----|--|-----------------|-----------------|
| Applicable          | Type   |     | Average EIRP Power   | Peak EIRP Power |                 |
|                     | Fixed field disturbance sensors and short-range devices for interactive motion sensing                     | (a) | For fixed field disturbance sensors that occupy 500 MHz or less of bandwidth and that are contained wholly within the frequency band 61.0-61.5 GHz       | 40dBm (*Note 3) | 43dBm (*Note 3) |
|                     |  | (b) | For fixed field disturbance sensors other than those operating under the provisions of (a) above, and short-range devices for interactive motion sensing | -               | 10dBm           |
| V                   | Products other than fixed field disturbance sensors and short-range devices for interactive motion sensing | (c) | For fixed point-to-point transmitters located outdoors   | 82dBm (*Note 1) | 85dBm (*Note 2) |
|                     |  | (d) | For other devices  | 40dBm           | 43dBm           |

Note:

1. The average power of any emission shall not exceed 82 dBm, and shall be reduced by 2 dB for every dB that the antenna gain is less than 51 dBi.
2. The peak power of any emission shall not exceed 85 dBm, and shall be reduced by 2 dB for every dB that the antenna gain is less than 51 dBi.
3. In addition, the average power of any emission outside of the 61.0-61.5 GHz band, measured during the transmit interval, but still within the 57-71 GHz band, shall not exceed 10 dBm, and the peak power of any emission shall not exceed 13 dBm.

| Peak Output Power (Conducted Power) |  |                                  |                         |
|-------------------------------------|--|----------------------------------|-------------------------|
| Applicable                          | Type   | 6dB Bandwidth                    | Maximum Conducted Power |
|                                     | For fixed field disturbance sensors other than those operating under the provisions of (a) above, and short-range devices for interactive motion sensing | -                                | -10 dBm (0.1mW)         |
| V                                   | Other  | Greater than or equal to 100 MHz | 500mW                   |
|                                     |  | Less than 100MHz                 | 500mW x (B/100)         |

Note:

1. B is 6dB Bandwidth (measured with a 100kHz resolution bandwidth)
2. Peak transmitter output power shall be measured with an RF detector that has a detection bandwidth that encompasses the 57-71 GHz band and the has a video bandwidth of at least 10 MHz, or using an equivalent measurement method.
3. For purposes of demonstrating compliance with this RSS, corrections to the transmitter output power may be made due to the antenna and circuit loss.

#### 4.4.2 Test Setup

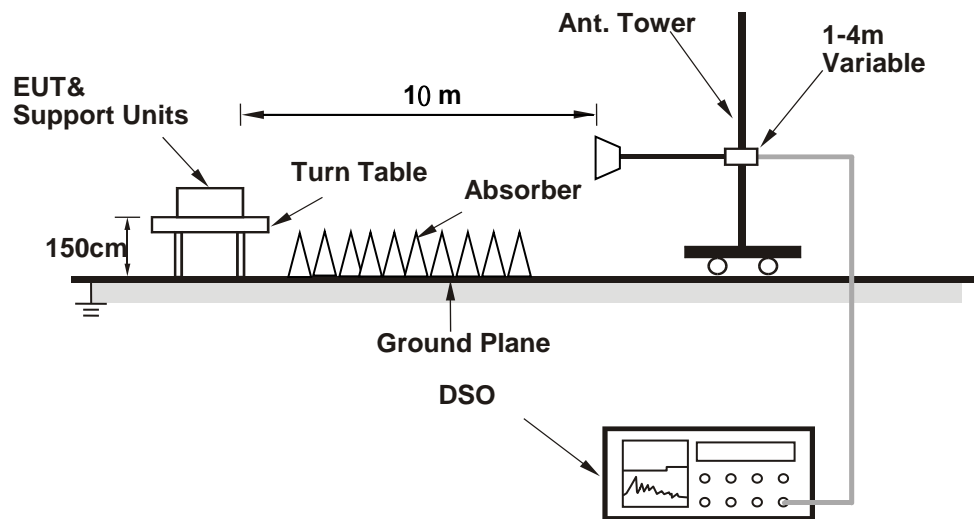

#### 4.4.3 Test Instruments

Refer to section 4.1.2 to get information of above instrument.

#### 4.4.4 Test Procedures

- a. Place the EUT in a continuous transmission mode.
- b. For radiated emission measurements, attach a test receive antenna for the fundamental frequency band to the RF input of an RF detector or a downconverter with an RF detector at the output.
- c. Connect the video output of the detector to the 50 ohm input of the DSO.
- d. Place the test receive antenna in the main beam of the EUT at a distance which will provide a signal within the operating range of the RF detector.
- e. Set the sampling rate of the DSO to the required value. Adjust the memory depth, the triggering and the sweep speed to obtain a display which is representative of the signal considering the type of modulation.
- f. For radiated emission measurements, calculate the distance to the far field boundary of the fundamental emission using following equation

$$R \text{ far field} = (2 * L^2) / \lambda$$

Where:

L is the Largest Antenna Dimension of either the EUT antenna or measurement antenna, including the reflector

$\lambda$  is the wavelength

| Frequency (GHz ) | L (m) | Lambda (m) | R (Far Field) (m) |
|------------------|-------|------------|-------------------|
| 58.32            | 0.15  | 0.00514    | 8.755             |
| 60.48            | 0.15  | 0.00496    | 9.073             |
| 62.64            | 0.15  | 0.00479    | 9.395             |
| 64.8             | 0.15  | 0.00463    | 9.719             |

\*Measurements made at 10 meter distance.

- g. Perform radiated emission measurements to keep maximize the received signal from the EUT in the far field.
- h. Record the average and peak from the DSO and the measurement distance.
- i. Disconnect the EUT from the RF input port of the instrumentation system.
- j. Connect a mm-wave source to the RF input port of the instrumentation system via a waveguide variable attenuator. The mm-wave source is unmodulated.
- k. Using substitution measurement.
- l. Measure and note the power.
- m. For conducted power measurements, calculate the conducted power using following equation

$$P_{\text{cond}} = \text{EIRP} - G_{\text{dBi}}$$

#### 4.4.5 Deviation from Test Standard

No deviation.

#### 4.4.6 EUT Operating Conditions

Same as Item 4.3.6.

#### 4.4.7 Test Results

##### For Output Power (EIRP)

| Channel | Frequency (GHz) | DSO Value (mV) | Power (dBm) | Gain of Test Antenna (dBi) | E <sub>Meas</sub> (dB $\mu$ V/m) | EIRP Level (dBm) | EIRP Limit (dBm) | Pass/Fail |
|---------|-----------------|----------------|-------------|----------------------------|----------------------------------|------------------|------------------|-----------|
| 1       | 58.32           | 540.00         | -16.89      | 20.50                      | 135.18                           | 50.48 PK         | 53.00            | Pass      |
|         |                 | 451.90         | -22.65      | 20.50                      | 129.42                           | 44.72 AV         | 50.00            | Pass      |
| 2       | 60.48           | 550.00         | -16.55      | 20.50                      | 135.84                           | 51.14 PK         | 53.00            | Pass      |
|         |                 | 479.50         | -22.45      | 20.50                      | 129.94                           | 45.24 AV         | 50.00            | Pass      |
| 3       | 62.64           | 550.00         | -15.14      | 21.40                      | 136.65                           | 51.95 PK         | 53.00            | Pass      |
|         |                 | 462.10         | -21.12      | 21.40                      | 130.67                           | 45.97 AV         | 50.00            | Pass      |
| 4       | 64.8            | 520.00         | -17.02      | 21.40                      | 135.07                           | 50.37 PK         | 53.00            | Pass      |
|         |                 | 445.20         | -23.05      | 21.40                      | 129.04                           | 44.34 AV         | 50.00            | Pass      |

Note:

1. The measured power level is converted to EIRP using the equation:

Follow ANSI 63.10 section 9.4 Equations to calculate and extrapolate field strength

$$E_{\text{Meas}} \text{ (dB}\mu\text{V/m)} = 126.8 - 20\log(\lambda) + P - G$$

where:

E<sub>Meas</sub> is the field strength of the emission at the measurement distance, in dB $\mu$ V/m

P is the power measured at the output of the test antenna, in dBm

$\lambda$  is the wavelength of the emission under investigation [300/fMHz], in m

G is the gain of the test antenna, in dBi

Follow ANSI 63.10 section 9.5 Equations to calculate EIRP

$$\text{EIRP Level (dBm/MHz)} = E_{\text{Meas}} \text{ (dB}\mu\text{V/m)} + 20 \cdot \log(d_{\text{Meas}}) - 104.7$$

where:

EIRP is the equivalent isotropically radiated power, in dBm

E<sub>Meas</sub> is the field strength of the emission at the measurement distance, in dB $\mu$ V/m

d<sub>Meas</sub> is the measurement distance, in m

Measurements made at 10 meter distance.

2. The EIRP was evaluated on vertical and horizontal polarization, the worst case is Vertical polarization.

##### For Peak Output Power (Conducted Power)

| Channel | Frequency (GHz) | EIRP (dBm) | Max. Gain (dBi) | Conducted Output Power (dBm) | Conducted Output Power (mW) | Conducted Output Power limit (mW) | Pass /Fail |
|---------|-----------------|------------|-----------------|------------------------------|-----------------------------|-----------------------------------|------------|
| 1       | 58.32           | 50.48      | 35              | 15.48                        | 35.32                       | 500                               | Pass       |
| 2       | 60.48           | 51.14      | 35              | 16.14                        | 41.11                       | 500                               | Pass       |
| 3       | 62.64           | 51.95      | 35              | 16.95                        | 49.55                       | 500                               | Pass       |
| 4       | 64.80           | 50.37      | 35              | 15.37                        | 34.43                       | 500                               | Pass       |

## 4.5 Frequency Stability Measurement

### 4.5.1 Limits of Frequency Stability Measurement

15.255(f) Fundamental emissions must be contained within the frequency bands specified in this section during all conditions of operation.

### 4.5.2 Test Setup

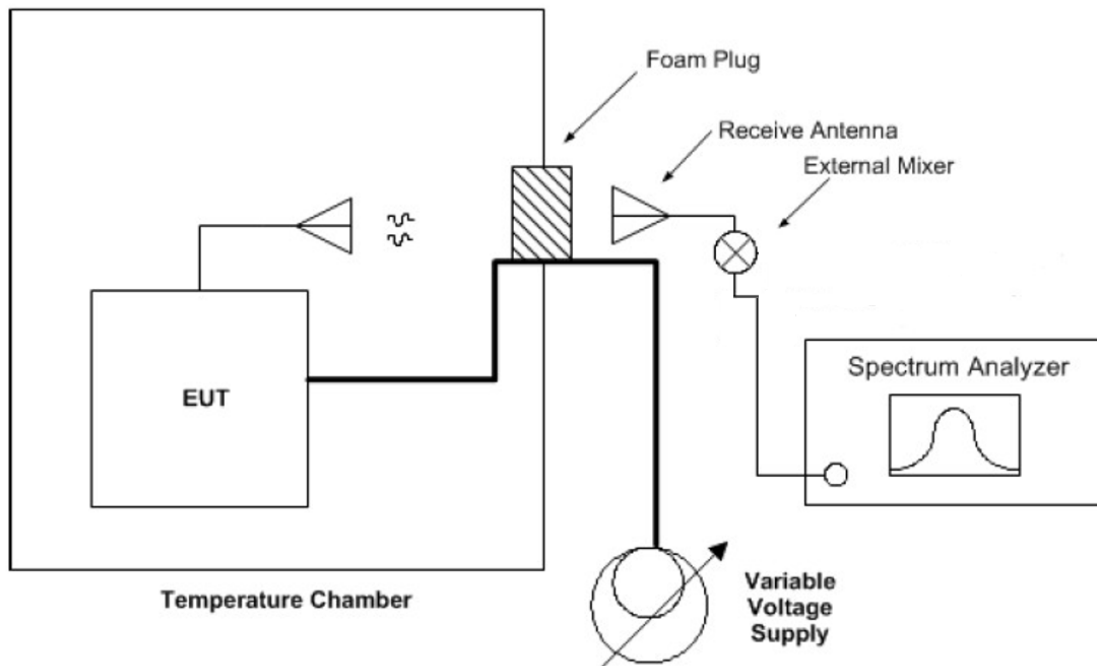

#### 4.5.3 Test Instruments

| DESCRIPTION & MANUFACTURER   | MODEL NO.         | SERIAL NO.  | CALIBRATED DATE | CALIBRATED UNTIL |
|--|-------------------|-------------|-----------------|------------------|
| N9029AV15-DC9 - 50-75 GHz VDI Standard Downconverter with 9VDC supply Keysight | SA Extension WR15 | SAX 381     | CoC             | CoC              |
| *Conical Horn Antenna (50~75GHz) Keysight                                      | WR15CH-Conical    | WR15CH_001  | Jan. 20, 2020   | Jan. 19, 2022    |
| Spectrum Analyzer Keysight   | N9030A            | MY55330160  | Feb. 07, 2020   | Feb. 06, 2021    |
| DC Power Supply Topward  | 6603D             | 795558      | NA              | NA               |
| Temperature & Humidity Chamber Giant Force                                     | GTH-150-40-SP-AR  | MAA0812-008 | Jan. 16, 2020   | Jan. 15, 2021    |
| True RMS Clamp Meter FLUKE   | 325               | 31130711WS  | June 06, 2020   | June 05, 2021    |

- NOTE:**
1. The test was performed in Oven room 2.
  2. The calibration interval of the above test instruments is 12 months and the calibrations are traceable to NML/ROC and NIST/USA.
  - 3.\*The calibration interval of the above test instruments is 24 months and the calibrations are traceable to NML/ROC and NIST/USA.
  4. Certificate of Conformance (CoC) which is issued by manufacturer states that the product meets the specification.
  5. Tested Date: Dec. 09, 2020

#### 4.5.4 Test Procedure

- a. Arrange EUT and test equipment as above setup configuration.
- b. With the EUT at ambient temperature and voltage source set to the EUT nominal operating voltage (100%), record the spectrum mask of the EUT emission on the spectrum analyzer.
- c. Vary EUT power supply between 85% and 115% of nominal, and record the frequency excursion of the EUT emission mask.
- d. Set the power supply to 100% nominal setting, and raise EUT operating temperature to 55 °C. Record the frequency excursion of the EUT emission mask.
- e. Repeat step d) at each 10 °C increment down to -40 °C

#### 4.5.5 Deviation from Test Standard

No deviation.

#### 4.5.6 EUT Operating Condition

Same as Item 4.3.6



#### 4.5.7 Test Results

| Frequency Stability Versus Temp. |                          |           |          |               |           |          |               |           |          |               |            |          |               |
|----------------------------------|--------------------------|-----------|----------|---------------|-----------|----------|---------------|-----------|----------|---------------|------------|----------|---------------|
| Operating Frequency: 58320 MHz   |                          |           |          |               |           |          |               |           |          |               |            |          |               |
| TEMP.<br>(°C)                    | Power<br>Supply<br>(Vdc) | 0 minutes |          |               | 2 minutes |          |               | 5 minutes |          |               | 10 minutes |          |               |
|                                  |                          | FL(MHz)   | FH(MHz)  | PASS/<br>FAIL | FL(MHz)   | FH(MHz)  | PASS/<br>FAIL | FL(MHz)   | FH(MHz)  | PASS/<br>FAIL | FL(MHz)    | FH(MHz)  | PASS/<br>FAIL |
| 55                               | 48                       | 57327.95  | 59240.83 | PASS          | 57327.99  | 59240.85 | PASS          | 57327.97  | 59240.84 | PASS          | 57327.95   | 59240.88 | PASS          |
| 50                               | 48                       | 57328.14  | 59240.94 | PASS          | 57328.16  | 59240.96 | PASS          | 57328.16  | 59240.93 | PASS          | 57328.17   | 59240.96 | PASS          |
| 40                               | 48                       | 57328.14  | 59241.16 | PASS          | 57328.14  | 59241.16 | PASS          | 57328.16  | 59241.18 | PASS          | 57328.14   | 59241.14 | PASS          |
| 30                               | 48                       | 57328.11  | 59241.01 | PASS          | 57328.15  | 59240.99 | PASS          | 57328.14  | 59241.02 | PASS          | 57328.15   | 59240.99 | PASS          |
| 20                               | 48                       | 57327.94  | 59241.08 | PASS          | 57327.94  | 59241.09 | PASS          | 57327.93  | 59241.09 | PASS          | 57327.90   | 59241.04 | PASS          |
| 10                               | 48                       | 57328.01  | 59240.72 | PASS          | 57328.05  | 59240.68 | PASS          | 57328.02  | 59240.73 | PASS          | 57328.04   | 59240.73 | PASS          |
| 0                                | 48                       | 57328.05  | 59240.90 | PASS          | 57328.08  | 59240.86 | PASS          | 57328.07  | 59240.89 | PASS          | 57328.04   | 59240.88 | PASS          |
| -10                              | 48                       | 57328.21  | 59241.11 | PASS          | 57328.21  | 59241.09 | PASS          | 57328.18  | 59241.11 | PASS          | 57328.20   | 59241.11 | PASS          |
| -20                              | 48                       | 57327.77  | 59240.68 | PASS          | 57327.77  | 59240.63 | PASS          | 57327.77  | 59240.67 | PASS          | 57327.81   | 59240.65 | PASS          |
| -30                              | 48                       | 57328.00  | 59240.90 | PASS          | 57327.97  | 59240.89 | PASS          | 57327.98  | 59240.89 | PASS          | 57327.98   | 59240.91 | PASS          |
| -40                              | 48                       | 57328.03  | 59240.86 | PASS          | 57328.03  | 59240.86 | PASS          | 57328.03  | 59240.83 | PASS          | 57328.03   | 59240.86 | PASS          |

| Frequency Stability Versus Voltage |                          |           |          |               |           |          |               |           |          |               |            |          |               |
|------------------------------------|--------------------------|-----------|----------|---------------|-----------|----------|---------------|-----------|----------|---------------|------------|----------|---------------|
| Operating Frequency: 58320 MHz     |                          |           |          |               |           |          |               |           |          |               |            |          |               |
| TEMP.<br>(°C)                      | Power<br>Supply<br>(Vdc) | 0 minutes |          |               | 2 minutes |          |               | 5 minutes |          |               | 10 minutes |          |               |
|                                    |                          | FL(MHz)   | FH(MHz)  | PASS/<br>FAIL | FL(MHz)   | FH(MHz)  | PASS/<br>FAIL | FL(MHz)   | FH(MHz)  | PASS/<br>FAIL | FL(MHz)    | FH(MHz)  | PASS/<br>FAIL |
| 20                                 | 55.2                     | 57327.94  | 59241.09 | PASS          | 57327.93  | 59241.10 | PASS          | 57327.93  | 59241.10 | PASS          | 57327.91   | 59241.04 | PASS          |
|                                    | 48                       | 57327.94  | 59241.08 | PASS          | 57327.94  | 59241.09 | PASS          | 57327.93  | 59241.09 | PASS          | 57327.90   | 59241.04 | PASS          |
|                                    | 40.8                     | 57327.94  | 59241.08 | PASS          | 57327.93  | 59241.09 | PASS          | 57327.93  | 59241.09 | PASS          | 57327.90   | 59241.04 | PASS          |

## 5 Pictures of Test Arrangements

Please refer to the attached file (Test Setup Photo).

## Appendix – Information of the Testing Laboratories

We, Bureau Veritas Consumer Products Services (H.K.) Ltd., Taoyuan Branch, were founded in 1988 to provide our best service in EMC, Radio, Telecom and Safety consultation. Our laboratories are FCC recognized accredited test firms and accredited according to ISO/IEC 17025.

If you have any comments, please feel free to contact us at the following:

**Lin Kou EMC/RF Lab**

Tel: 886-2-26052180

Fax: 886-2-26051924

**Hsin Chu EMC/RF/Telecom Lab**

Tel: 886-3-6668565

Fax: 886-3-6668323

**Hwa Ya EMC/RF/Safety Lab**

Tel: 886-3-3183232

Fax: 886-3-3270892

**Email:** [service.adt@tw.bureauveritas.com](mailto:service.adt@tw.bureauveritas.com)

**Web Site:** [www.bureauveritas-adt.com](http://www.bureauveritas-adt.com)

The address and road map of all our labs can be found in our web site also.

--- END ---