

FCC C2PC Test Report

FCC ID : SWX-AF60
Equipment : airFiber 60
Model No. : AF60
Brand Name : UBIQUITI
Applicant : Ubiquiti Inc.
Address : 685 Third Avenue, New York, New York 10017
USA
Standard : 47 CFR FCC Part 15.407
Received Date : Aug. 14, 2019
Tested Date : Aug. 14 ~ Oct. 24, 2019

We, International Certification Corp., would like to declare that the tested sample has been evaluated and in compliance with the requirement of the above standards. The test results contained in this report refer exclusively to the product. It may be duplicated completely for legal use with the approval of the applicant. It shall not be reproduced except in full without the written approval of our laboratory.

Reviewed by:

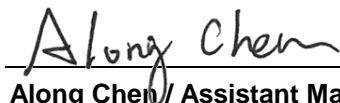

Along Chen / Assistant Manager

Approved by:



Gary Chang / Manager



Table of Contents

1	GENERAL DESCRIPTION	5
1.1	Information.....	5
1.2	Local Support Equipment List	9
1.3	Test Setup Chart	9
1.4	The Equipment List	10
1.5	Testing Applied Standards	11
1.6	Deviation from Test Standard and Measurement Procedure.....	11
1.7	Measurement Uncertainty	11
2	TEST CONFIGURATION	12
2.1	Testing Condition	12
2.2	The Worst Test Modes and Channel Details	12
3	TRANSMITTER TEST RESULTS.....	13
3.1	Conducted Emissions.....	13
3.2	Emission Bandwidth	16
3.3	RF Output Power.....	28
3.4	Peak Power Spectral Density.....	31
3.5	Transmitter Radiated and Band Edge Emissions	43
3.6	Frequency Stability.....	102
4	TEST LABORATORY INFORMATION	104

Release Record

Report No.	Version	Description	Issued Date
FR981302-01AN	Rev. 01	Initial issue	Dec. 17, 2019

Summary of Test Results

FCC Rules	Test Items	Measured	Result
15.207	Conducted Emissions	[dBuV]: 0.186MHz 56.32 (Margin -7.88dB) - QP	Pass
15.407(b) 15.209	Radiated Emissions	[dBuV/m at 3m]: 5424.00MHz 53.72 (Margin -0.28dB) - AV	Pass
15.407(a)	Emission Bandwidth	Meet the requirement of limit	Pass
15.407(a)	RF Output Power	Max Power [dBm]: 5250~5350MHz: 18.82 5470~5725MHz: 18.79	Pass
15.407(a)	Peak Power Spectral Density	Meet the requirement of limit	Pass
15.407(g)	Frequency Stability	Meet the requirement of limit	Pass
15.203	Antenna Requirement	Meet the requirement of limit	Pass

Declaration of Conformity:

The test results with all measurement uncertainty excluded are presented in accordance with the regulation limits or requirements declared by manufacturers.

Comments and Explanations:

The declared of product specification for EUT presented in the report are provided by the manufacturer, and the manufacturer takes all the responsibilities for the accuracy of product specification.

1 General Description

1.1 Information

This report is issued as a FCC Class II Permissive Change. The modification is only concerned with adding 5250~5350MHz and 5470~5725 MHz band by software setting.

1.1.1 Specification of the Equipment under Test (EUT)

RF General Information					
Frequency Range (MHz)	Proprietary protocol (BW: MHz)	Ch. Freq. (MHz)	Channel Number	Transmit Chains (N _{TX})	Data Rate / MCS
5250-5350 5470-5725	20	5260-5335 5485-5710	52-67 [16] 97-142 [46]	2	MCS 0-9
5250-5350 5470-5725	40	5270-5325 5495-5700	54-65 [12] 99-140 [42]	2	MCS 0-9
5250-5350 5470-5725	80	5290-5305 5515-5680	58-61 [4] 103-136 [34]	2	MCS 0-9

Note 1: RF output power specifies that .
Note 2: 802.11ac uses a combination of OFDM-BPSK, QPSK, 16QAM, 64QAM, 256QAM modulation.

1.1.2 Antenna Details

Ant. No.	Type	Connector	Operating Frequencies (MHz) / Antenna Gain (dBi)	
			5250~5350	5470~5725
1	internal antenna	---	11	11

Note: The antenna is Cross Polarized Antenna

1.1.3 Power Supply Type of Equipment under Test (EUT)

Power Supply Type	24Vdc from POE
--------------------------	----------------

1.1.4 Accessories

Accessories		
No.	Equipment	Description
1	Adapter	Brand: UBIQUITI Model: GP-A240-050G Power Rating: I/P: 100-240Vac, 50/60Hz, 0.3A O/P: 24Vdc, 0.5A Power Line: 0.6m non-shielded without core

1.1.5 Channel List

For Frequency band 5250-5350 MHz			
Proprietary protocol (BW: 20 MHz)		Proprietary protocol (BW: 40 MHz)	
Channel	Frequency(MHz)	Channel	Frequency(MHz)
52	5260	54	5270
53	5265	55	5275
54	5270	56	5280
55	5275	57	5285
56	5280	58	5290
57	5285	59	5295
58	5290	60	5300
59	5295	61	5305
60	5300	62	5310
61	5305	63	5315
62	5310	64	5320
63	5315	65	5325
64	5320	Proprietary protocol (BW: 80 MHz)	
65	5325	58	5290
66	5330	59	5295
67	5335	60	5300
---	---	61	5305

For Frequency band 5470-5725 MHz							
Proprietary protocol (BW: 20 MHz)				Proprietary protocol (BW: 40 MHz)			
Channel	Frequency (MHz)	Channel	Frequency (MHz)	Channel	Frequency (MHz)	Channel	Frequency (MHz)
97	5485	120	5600	99	5495	122	5610
98	5490	121	5605	100	5500	123	5615
99	5495	122	5610	101	5505	124	5620
100	5500	123	5615	102	5510	125	5625
101	5505	124	5620	103	5515	126	5630
102	5510	125	5625	104	5520	127	5635
103	5515	126	5630	105	5525	128	5640
104	5520	127	5635	106	5530	129	5645
105	5525	128	5640	107	5535	130	5650
106	5530	129	5645	108	5540	131	5655
107	5535	130	5650	109	5545	132	5660
108	5540	131	5655	110	5550	133	5665
109	5545	132	5660	111	5555	134	5670
110	5550	133	5665	112	5560	135	5675
111	5555	134	5670	113	5565	136	5680
112	5560	135	5675	114	5570	137	5685
113	5565	136	5680	115	5575	138	5690
114	5570	137	5685	116	5580	139	5695
115	5575	138	5690	117	5585	140	5700
116	5580	139	5695	118	5590	---	---
117	5585	140	5700	119	5595	---	---
118	5590	141	5705	120	5600	---	---
119	5595	142	5710	121	5605	---	---

Proprietary protocol (BW: 80 MHz)							
Channel	Frequency (MHz)	Channel	Frequency (MHz)	Channel	Frequency (MHz)	Channel	Frequency (MHz)
103	5515	112	5560	121	5605	130	5650
104	5520	113	5565	122	5610	131	5655
105	5525	114	5570	123	5615	132	5660
106	5530	115	5575	124	5620	133	5665
107	5535	116	5580	125	5625	134	5670
108	5540	117	5585	126	5630	135	5675
109	5545	118	5590	127	5635	136	5680
110	5550	119	5595	128	5640	---	---
111	5555	120	5600	129	5645	---	---

1.1.6 Test Tool and Duty Cycle

Test Tool	Putty, 0.60.0.0		
Duty Cycle and Duty Factor	Proprietary protocol (BW: MHz)	Duty cycle (%)	Duty factor (dB)
	20	89.34%	0.49
	40	80.93%	0.92
	80	85.09%	0.70

1.2 Local Support Equipment List

Support Equipment List					
No.	Equipment	Brand	Model	FCC ID	Remarks
1	Notebook	DELL	Latitude E6440	DoC	---

1.3 Test Setup Chart

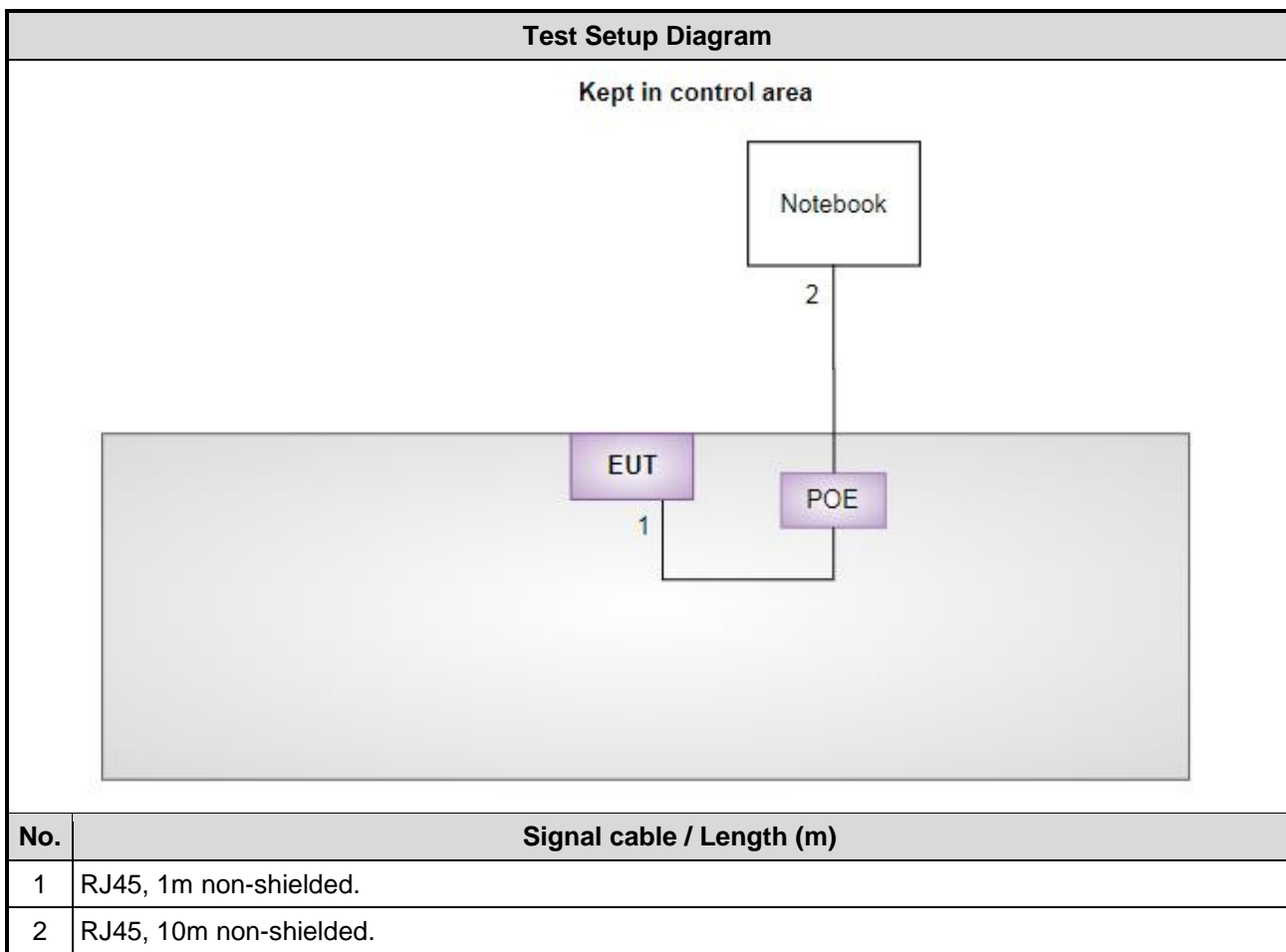

1.4 The Equipment List

Test Item	Conducted Emission				
Test Site	Conduction room 1 / (CO01-WS)				
Tested Date	Aug. 14, 2019				
Instrument	Manufacturer	Model No.	Serial No.	Calibration Date	Calibration Until
Receiver	R&S	ESR3	101657	Jan. 08, 2019	Jan. 07, 2020
LISN	R&S	ENV216	101579	Mar. 08, 2019	Mar. 07, 2020
RF Cable-CON	Woken	CFD200-NL	CFD200-NL-001	Oct. 23, 2018	Oct. 22, 2019
Measurement Software	AUDIX	e3	6.120210k	NA	NA
Note: Calibration Interval of instruments listed above is one year.					

Test Item	Radiated Emission				
Test Site	966 chamber 3 / (03CH03-WS)				
Tested Date	Oct. 08 ~ Oct. 18, 2019				
Instrument	Manufacturer	Model No.	Serial No.	Calibration Date	Calibration Until
Spectrum Analyzer	R&S	FSV40	101499	Jan. 07, 2019	Jan. 06, 2020
Receiver	R&S	ESR3	101658	Dec. 11, 2018	Dec. 10, 2019
Bilog Antenna	SCHWARZBECK	VULB9168	VULB9168-685	Apr. 17, 2019	Apr. 16, 2020
Horn Antenna 1G-18G	SCHWARZBECK	BBHA 9120 D	BBHA 9120 D 1206	Jan. 07, 2019	Jan. 06, 2020
Horn Antenna 18G-40G	SCHWARZBECK	BBHA 9170	BBHA 9170517	Nov. 15, 2018	Nov. 14, 2019
Loop Antenna	R&S	HFH2-Z2	100330	Nov. 09, 2018	Nov. 08, 2019
Loop Antenna Cable	KOAX KABEL	101354-BW	101354-BW	Oct. 07, 2019	Oct. 06, 2020
Preamplifier	EMC	EMC02325	980194	Sep. 18, 2019	Sep. 17, 2020
Preamplifier	Agilent	83017A	MY53270013	Dec. 27, 2018	Dec. 26, 2019
Preamplifier	EMC	EMC184045B	980192	Aug. 01, 2019	Jul. 31, 2020
RF cable-3M	HUBER+SUHNER	SUCOFLEX104	MY22620/4	Sep. 27, 2019	Sep. 26, 2020
RF cable-8M	EMC	EMC104-SM-SM-8000	181107	Sep. 27, 2019	Sep. 26, 2020
RF cable-1M	HUBER+SUHNER	SUCOFLEX104	MY22624/4	Sep. 27, 2019	Sep. 26, 2020
LF cable-0.8M	EMC	EMC8D-NM-NM-800	EMC8D-NM-NM-800-001	Sep. 27, 2019	Sep. 26, 2020
LF cable-3M	EMC	EMC8D-NM-NM-3000	131103	Sep. 27, 2019	Sep. 26, 2020
LF cable-13M	EMC	EMC8D-NM-NM-13000	131104	Sep. 27, 2019	Sep. 26, 2020
Measurement Software	AUDIX	e3	6.120210g	NA	NA
Note: Calibration Interval of instruments listed above is one year.					

Test Item	RF Conducted				
Test Site	(TH01-WS)				
Tested Date	Oct. 24, 2019				
Instrument	Manufacturer	Model No.	Serial No.	Calibration Date	Calibration Until
Spectrum Analyzer	R&S	FSV40	101063	Apr. 17, 2019	Apr. 16, 2020
Power Meter	Anritsu	ML2495A	1241002	Oct. 23, 2019	Oct. 22, 2020
Power Sensor	Anritsu	MA2411B	1207366	Oct. 23, 2019	Oct. 22, 2020
DC POWER SOURCE	GW INSTEK	GPC-6030D	EM892433	Oct. 25, 2018	Oct. 24, 2019
Measurement Software	Sporton	SENSE-15407_NII	V5.10	NA	NA
Note: Calibration Interval of instruments listed above is one year.					

1.5 Testing Applied Standards

According to the specification of EUT, the EUT must comply with following standards and KDB documents.

47 CFR FCC Part 15.407

ANSI C63.10-2013

FCC KDB 789033 D02 General UNII Test Procedures New Rules v02r01

FCC KDB 662911 D01 Multiple Transmitter Output v02r01

FCC KDB 412172 D01 Determining ERP and EIRP v01r01

1.6 Deviation from Test Standard and Measurement Procedure

None

1.7 Measurement Uncertainty

ISO/IEC 17025 requires that an estimate of the measurement uncertainties associated with the emissions test results be included in the report. The measurement uncertainties given below are based on a 95% confidence level (based on a coverage factor (k=2)).

Measurement Uncertainty	
Parameters	Uncertainty
Bandwidth	±34.130 Hz
Conducted power	±0.808 dB
Frequency error	±1×10 ⁻⁹
Power density	±0.583 dB
Conducted emission	±2.715 dB
AC conducted emission	±2.92 dB
Radiated emission ≤ 1GHz	±3.96 dB
Radiated emission > 1GHz	±4.51 dB
Time	±0.1%
Temperature	±0.4 °C

2 Test Configuration

2.1 Testing Condition

Test Item	Test Site	Ambient Condition	Tested By
AC Conduction	CO01-WS	23°C / 58%	Alex Tsai
Radiated Emissions	03CH03-WS	24-25°C / 65-69%	Akun Chung Roger Lu
RF Conducted	TH01-WS	21°C / 63%	Brad Wu

- FCC Designation No.: TW0009
- FCC site registration No.: 207696
- ISED#: 10807A
- CAB identifier: TW2732

2.2 The Worst Test Modes and Channel Details

For Frequency band 5250-5350 MHz, 5470-5725 MHz				
Test item	Proprietary protocol (BW: MHz)	Test Frequency (MHz)	Data Rate	Test Configuration
Conducted Emissions	20	5330	MCS 0	---
Radiated Emissions ≤1GHz	20	5330	MCS 0	---
RF Output Power	20	5260 / 5300 / 5330 / 5335 / 5485 / 5490 / 5600 / 5705 / 5710	MCS 0	---
	40	5270 / 5300 / 5320 / 5325 / 5495 / 5500 / 5600 / 5695 / 5700	MCS 0	
	80	5290 / 5295 / 5300 / 5305 / 5515 / 5520 / 5600 / 5675 / 5680	MCS 0	
Radiated Emissions >1GHz Emission Bandwidth Peak Power Spectral Density	20	5260 / 5300 / 5330 / 5335 / 5485 / 5490 / 5600 / 5705 / 5710	MCS 0	
	40	5270 / 5300 / 5320 / 5325 / 5495 / 5500 / 5600 / 5695 / 5700 /	MCS 0	
	80	5290 / 5295 / 5300 / 5305 / 5515 / 5520 / 5600 / 5675 / 5680	MCS 0	
Frequency Stability	Un-modulation	5335	---	---

3 Transmitter Test Results

3.1 Conducted Emissions

3.1.1 Limit of Conducted Emissions

Conducted Emissions Limit		
Frequency Emission (MHz)	Quasi-Peak	Average
0.15-0.5	66 - 56 *	56 - 46 *
0.5-5	56	46
5-30	60	50

Note 1: * Decreases with the logarithm of the frequency.

3.1.2 Test Procedures

1. The device is placed on a test table, raised 80 cm above the reference ground plane. The vertical conducting plane is located 40 cm to the rear of the device.
2. The device is connected to line impedance stabilization network (LISN) and other accessories are connected to other LISN. Measured levels of AC power line conducted emission are across the 50 Ω LISN port.
3. AC conducted emission measurements is made over frequency range from 150 kHz to 30 MHz.
4. This measurement was performed with AC 120V/60Hz

3.1.3 Test Setup



- Note: 1. Support units were connected to second LISN.
 2. Both of LISNs (AMN) are 80 cm from EUT and at least 80 cm from other units and other metal planes

3.1.4 Test Result of Conducted Emissions

Proprietary protocol	20 MHz	Test Freq. (MHz)	5330
Power Phase	Line		

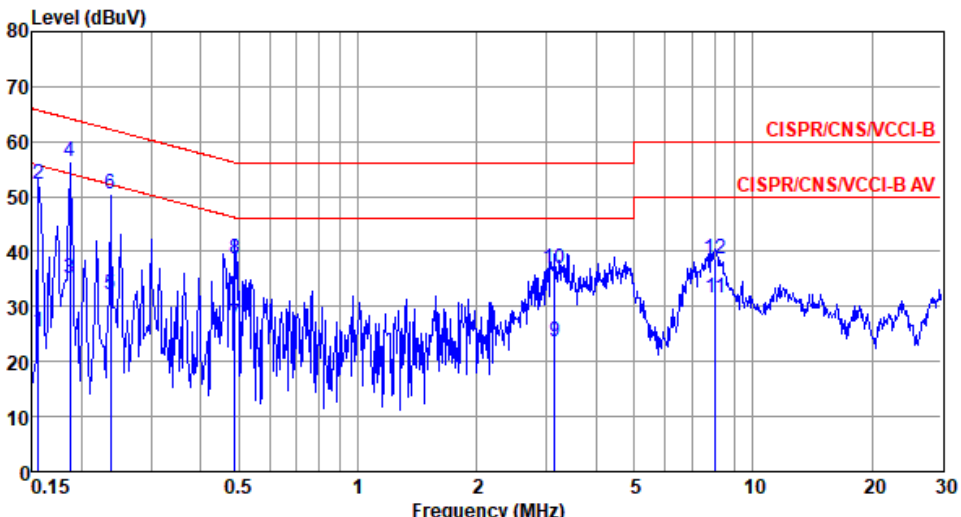

	Freq	Level	Limit	Over	Read	LISN	cable	
	MHz	dBuV	Line	Limit	Level	factor	loss	Remark
			dBuV	dB	dBuV	dB	dB	
1	0.156	25.42	55.69	-30.27	15.84	9.53	0.05	Average
2	0.156	52.21	65.69	-13.48	42.63	9.53	0.05	QP
3	0.186	35.21	54.20	-18.99	25.61	9.54	0.06	Average
4*	0.186	56.32	64.20	-7.88	46.72	9.54	0.06	QP
5	0.237	32.32	52.22	-19.90	22.71	9.55	0.06	Average
6	0.237	50.42	62.22	-11.80	40.81	9.55	0.06	QP
7	0.489	26.91	46.19	-19.28	17.24	9.58	0.09	Average
8	0.489	38.61	56.19	-17.58	28.94	9.58	0.09	QP
9	3.156	23.71	46.00	-22.29	13.85	9.61	0.25	Average
10	3.156	36.81	56.00	-19.19	26.95	9.61	0.25	QP
11	8.020	31.52	50.00	-18.48	21.51	9.64	0.37	Average
12	8.020	38.71	60.00	-21.29	28.70	9.64	0.37	QP

Note 1: Level (dBuV) = Read Level (dBuV) + LISN Factor (dB) + Cable Loss (dB).
 Note 2: Over Limit (dB) = Level (dBuV) – Limit Line (dBuV).

Proprietary protocol	20 MHz	Test Freq. (MHz)	5330
Power Phase	Neutral		

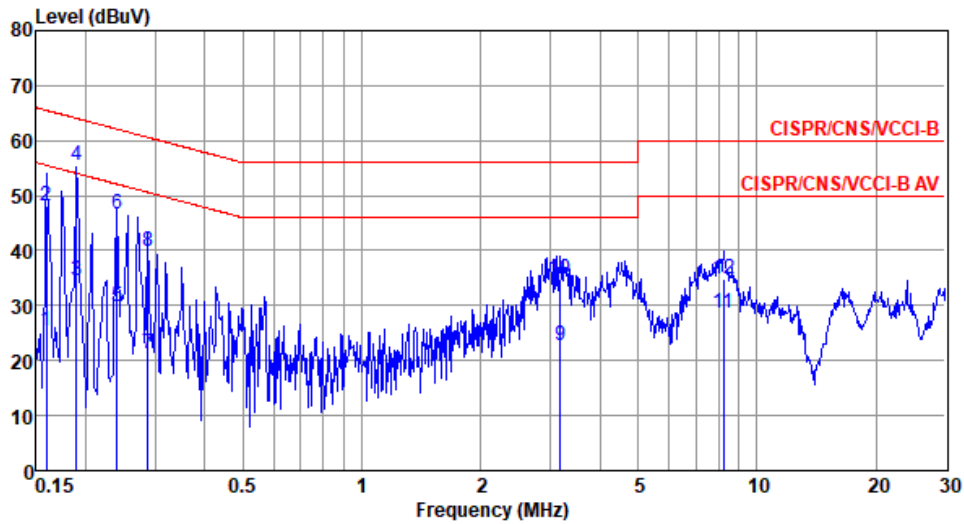

	Freq MHz	Level dBuV	Limit Line dBuV	Over Limit dB	Read Level dBuV	LISN factor dB	cable loss dB	Remark
1	0.159	25.41	55.52	-30.11	15.79	9.57	0.05	Average
2	0.159	48.14	65.52	-17.38	38.52	9.57	0.05	QP
3	0.189	34.61	54.06	-19.45	24.97	9.58	0.06	Average
4*	0.189	55.37	64.06	-8.69	45.73	9.58	0.06	QP
5	0.240	29.81	52.08	-22.27	20.15	9.59	0.07	Average
6	0.240	46.71	62.08	-15.37	37.05	9.59	0.07	QP
7	0.288	21.32	50.59	-29.27	11.65	9.60	0.07	Average
8	0.288	39.74	60.59	-20.85	30.07	9.60	0.07	QP
9	3.173	22.61	46.00	-23.39	12.70	9.66	0.25	Average
10	3.173	34.92	56.00	-21.08	25.01	9.66	0.25	QP
11	8.235	28.61	50.00	-21.39	18.54	9.70	0.37	Average
12	8.235	34.81	60.00	-25.19	24.74	9.70	0.37	QP

Note 1: Level (dBuV) = Read Level (dBuV) + LISN Factor (dB) + Cable Loss (dB).
 2: Over Limit (dB) = Level (dBuV) – Limit Line (dBuV).

3.2 Emission Bandwidth

3.2.1 Test Procedures

26dB Bandwidth

1. Set RBW = approximately 1% of the emission bandwidth.
2. Set the VBW > RBW, Detector = Peak.
3. Trace mode = max hold.
4. Measure the maximum width of the emission that is 26 dB down from the peak of the emission.

Occupied Bandwidth

1. Set RBW = 1 % to 5 % of the OBW
2. Set VBW \geq 3 RBW
3. Sample detection and single sweep mode shall be used
4. Use the 99 % power bandwidth function of the instrument

3.2.2 Test Setup

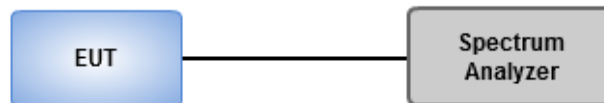

3.2.3 Test Result of Emission Bandwidth

Summary

Proprietary protocol (BW: MHz)	Max-N dB (Hz)	Max-OBW (Hz)	ITU-Code	Min-N dB (Hz)	Min-OBW (Hz)
5.25-5.35GHz	-	-	-	-	-
20_Nss1,(MCS0)_2TX	19.855M	17.583M	17M6D1D	19.565M	17.511M
40_Nss1,(MCS0)_2TX	39.565M	35.89M	35M9D1D	38.986M	35.89M
80_Nss1,(MCS0)_2TX	84.638M	76.122M	76M1D1D	83.188M	75.543M
5.47-5.725GHz	-	-	-	-	-
20_Nss1,(MCS0)_2TX	20M	17.583M	17M6D1D	19.565M	17.511M
40_Nss1,(MCS0)_2TX	39.438M	35.89M	35M9D1D	38.841M	35.836M
80_Nss1,(MCS0)_2TX	85.87M	75.977M	76M0D1D	83.768M	75.543M

Max-N dB = Maximum 6dB down bandwidth for 5.725-5.85GHz band / Maximum 26dB down bandwidth for other band;

Max-OBW = Maximum 99% occupied bandwidth;

Min-N dB = Minimum 6dB down bandwidth for 5.725-5.85GHz band / Maximum 26dB down bandwidth for other band;

Min-OBW = Minimum 99% occupied bandwidth;

Result

Proprietary protocol (BW: MHz)	Result	Limit (Hz)	Port 1-N dB (Hz)	Port 1-OBW (Hz)	Port 2-N dB (Hz)	Port 2-OBW (Hz)
20_Nss1,(MCS0)_2TX	-	-	-	-	-	-
5260MHz	Pass	Inf	19.783M	17.583M	19.855M	17.583M
5300MHz	Pass	Inf	19.638M	17.583M	19.71M	17.511M
5330MHz	Pass	Inf	19.638M	17.583M	19.638M	17.583M
5335MHz	Pass	Inf	19.71M	17.583M	19.565M	17.583M
5485MHz	Pass	Inf	19.71M	17.583M	19.71M	17.583M
5490MHz	Pass	Inf	20M	17.583M	19.855M	17.583M
5600MHz	Pass	Inf	19.783M	17.511M	19.638M	17.511M
5705MHz	Pass	Inf	19.565M	17.583M	19.728M	17.583M
5710MHz	Pass	Inf	19.71M	17.583M	19.855M	17.583M
40_Nss1,(MCS0)_2TX	-	-	-	-	-	-
5270MHz	Pass	Inf	38.986M	35.89M	39.565M	35.89M
5300MHz	Pass	Inf	39.275M	35.89M	39.275M	35.89M
5320MHz	Pass	Inf	39.565M	35.89M	39.42M	35.89M
5325MHz	Pass	Inf	38.986M	35.89M	39.42M	35.89M
5495MHz	Pass	Inf	39.42M	35.89M	39.275M	35.89M
5500MHz	Pass	Inf	39.275M	35.89M	39.42M	35.89M
5600MHz	Pass	Inf	39.42M	35.89M	38.841M	35.89M
5695MHz	Pass	Inf	39.185M	35.836M	39.438M	35.836M
5700MHz	Pass	Inf	39.275M	35.89M	39.13M	35.89M
80_Nss1,(MCS0)_2TX	-	-	-	-	-	-
5290MHz	Pass	Inf	84.638M	75.832M	83.768M	75.543M
5295MHz	Pass	Inf	83.768M	75.543M	84.058M	76.122M
5300MHz	Pass	Inf	83.188M	75.832M	84.348M	75.832M
5305MHz	Pass	Inf	84.058M	75.832M	84.348M	75.832M
5515MHz	Pass	Inf	84.348M	75.832M	85.217M	75.832M
5520MHz	Pass	Inf	83.768M	75.832M	83.768M	75.543M
5600MHz	Pass	Inf	84.058M	75.832M	84.058M	75.832M
5675MHz	Pass	Inf	84.638M	75.832M	84.638M	75.832M
5680MHz	Pass	Inf	85.87M	75.977M	84.511M	75.705M

Port X-N dB = Port X 6dB down bandwidth for 5.725-5.85GHz band / 26dB down bandwidth for other band

Port X-OBW = Port X 99% occupied bandwidth;

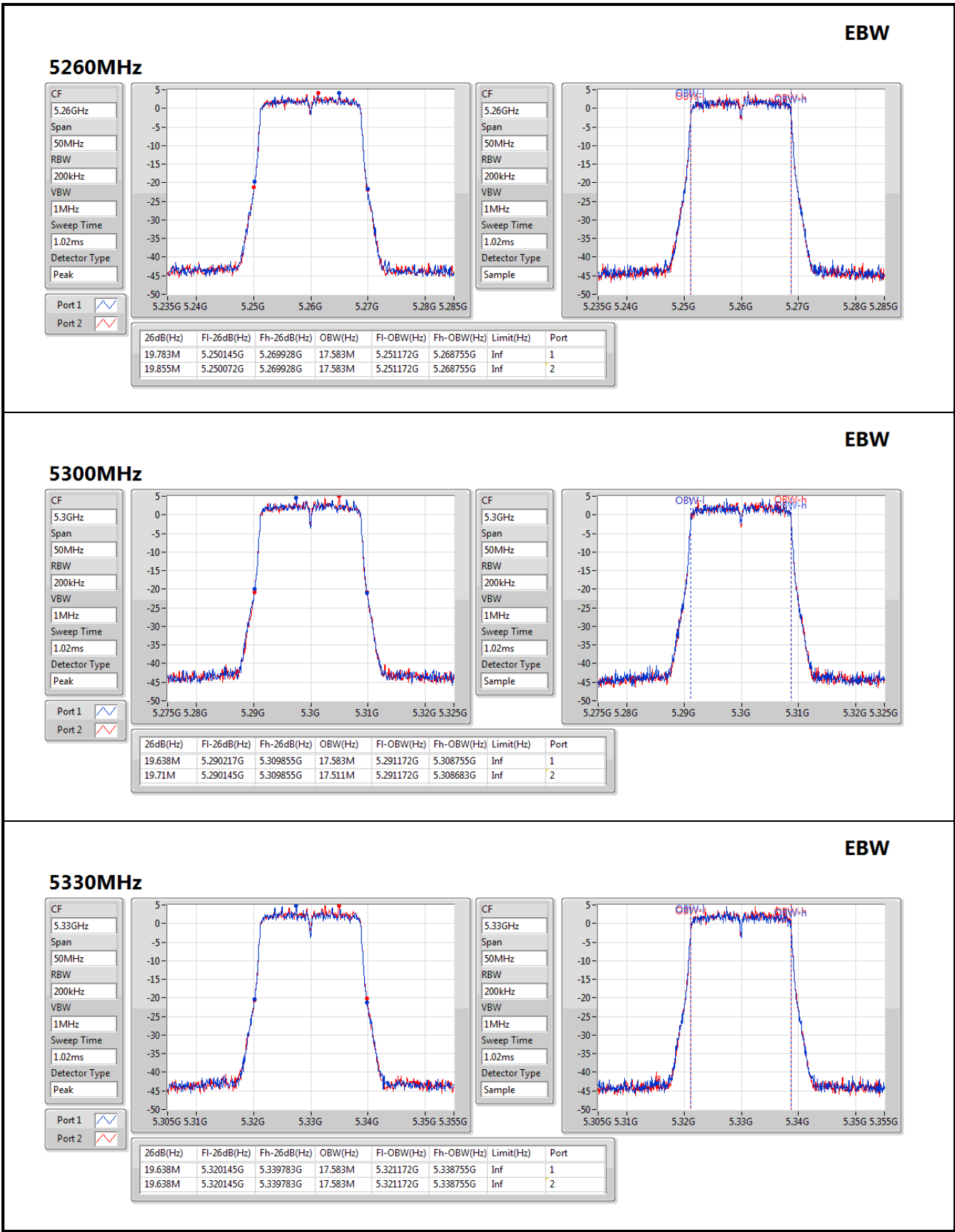

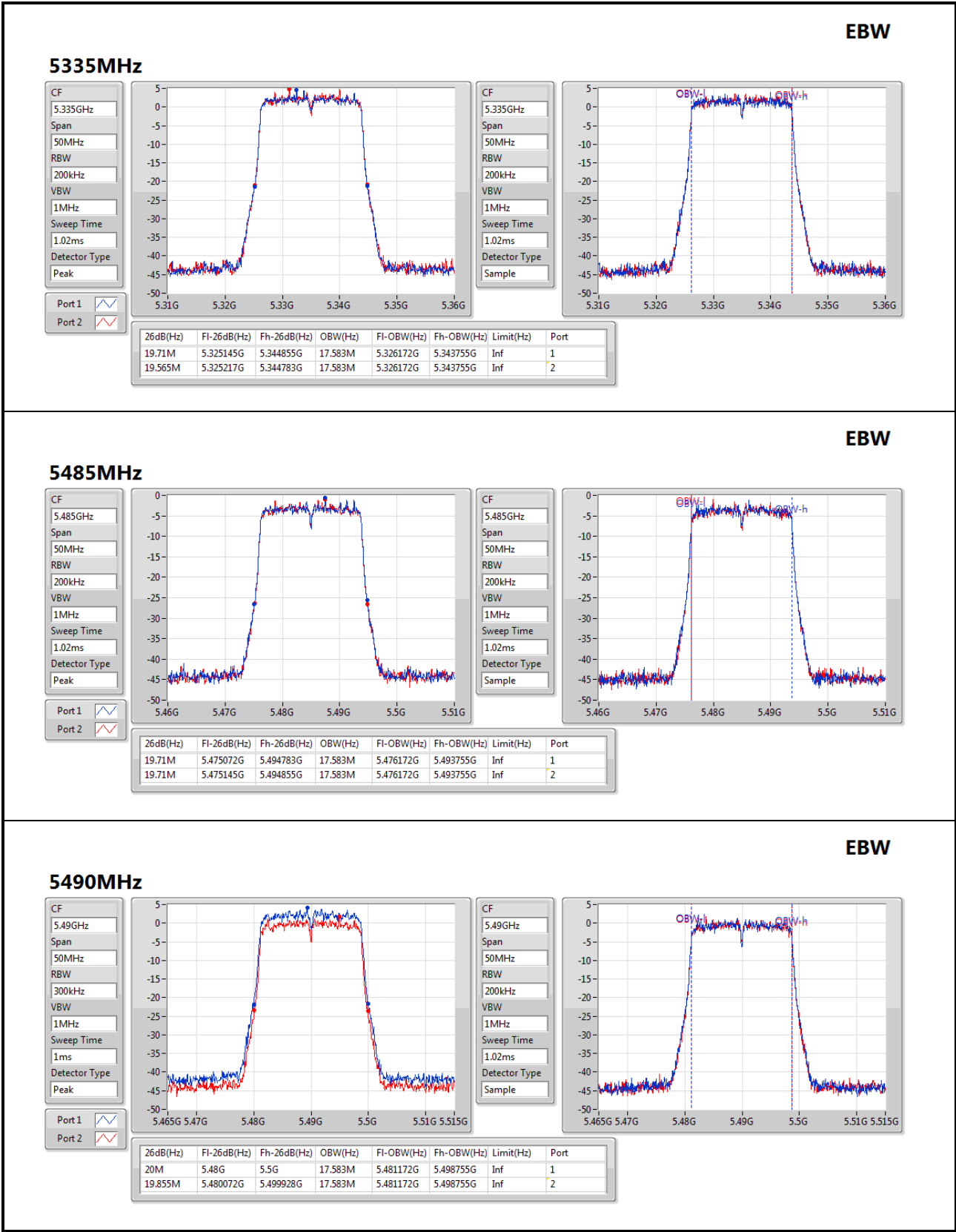

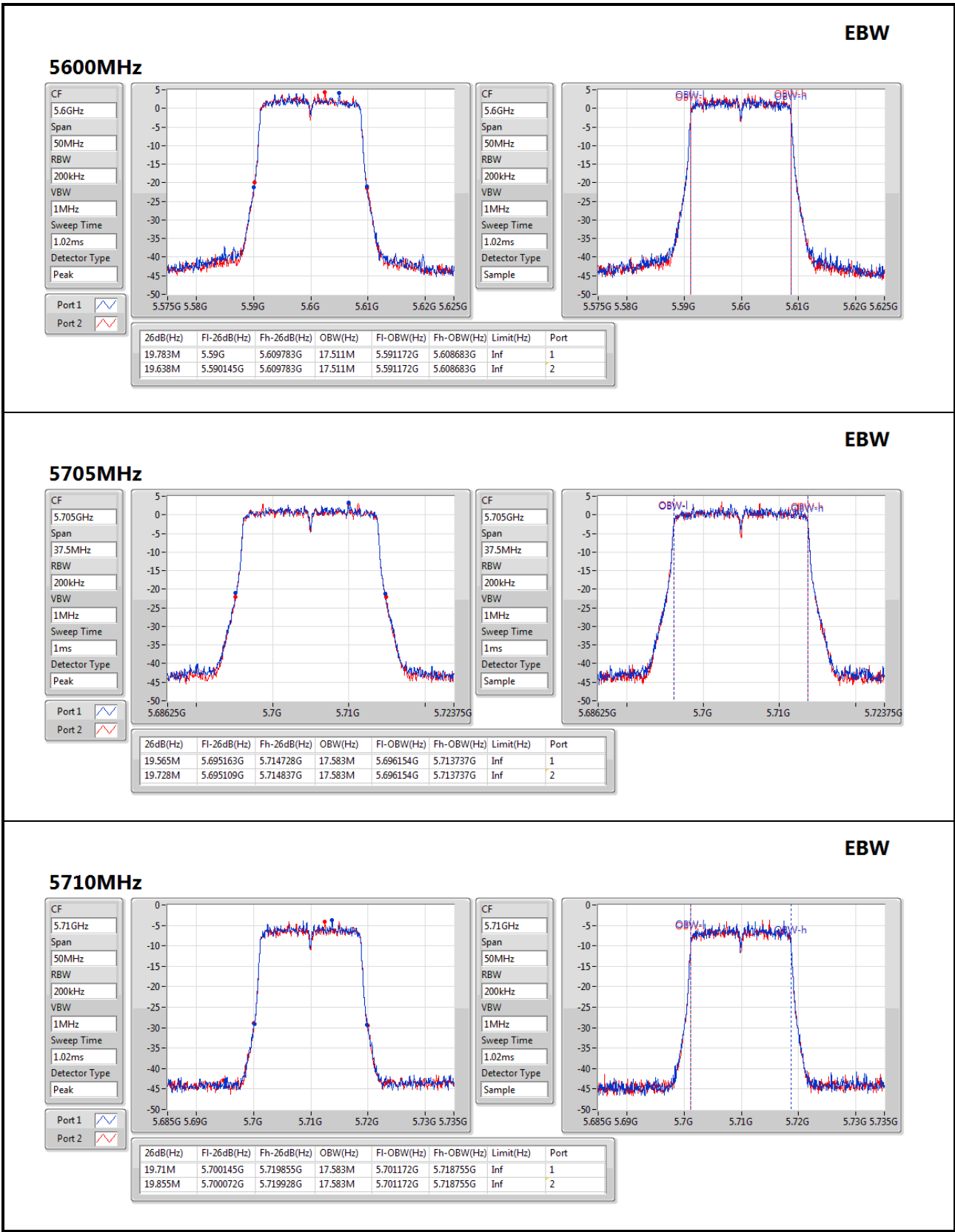

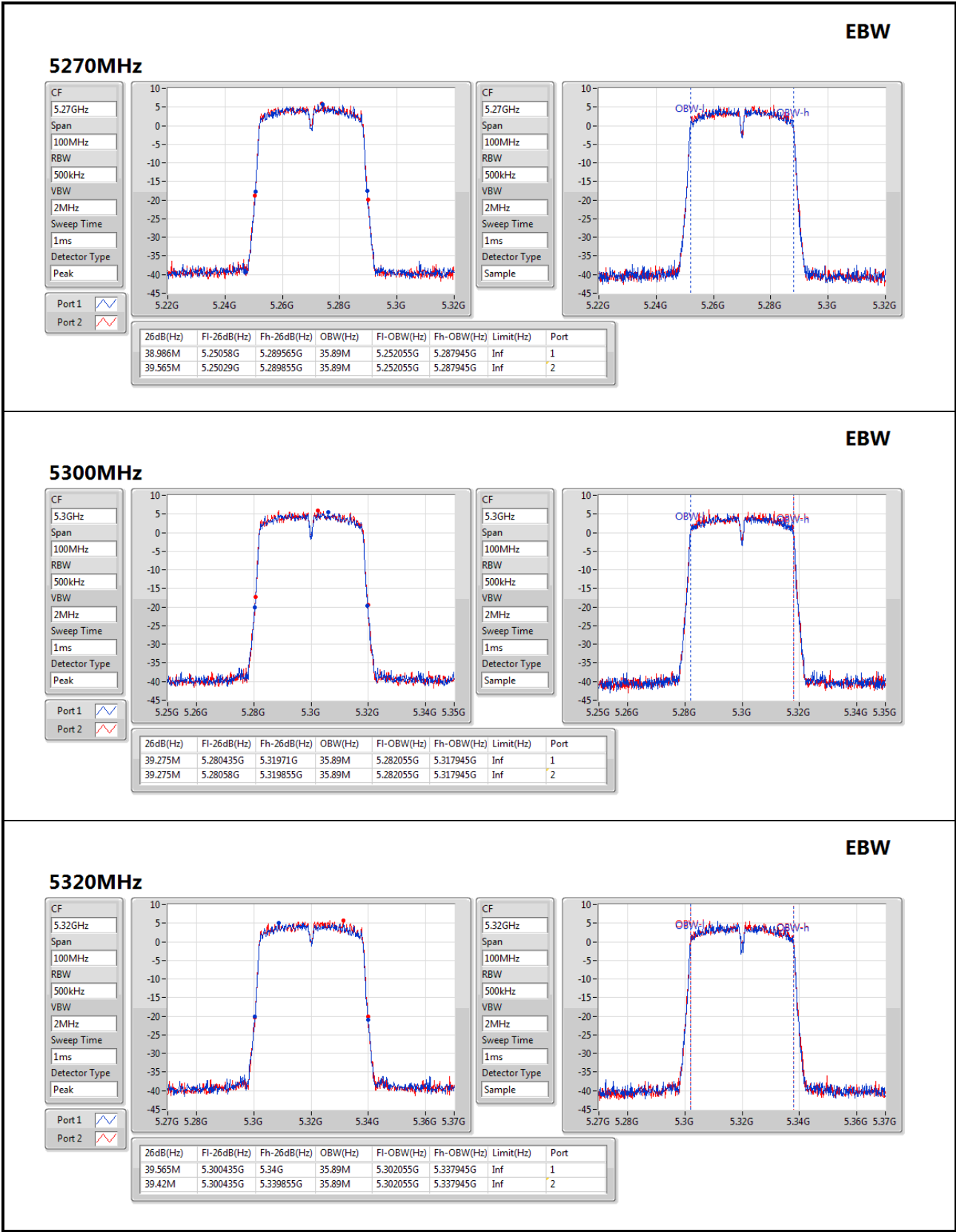

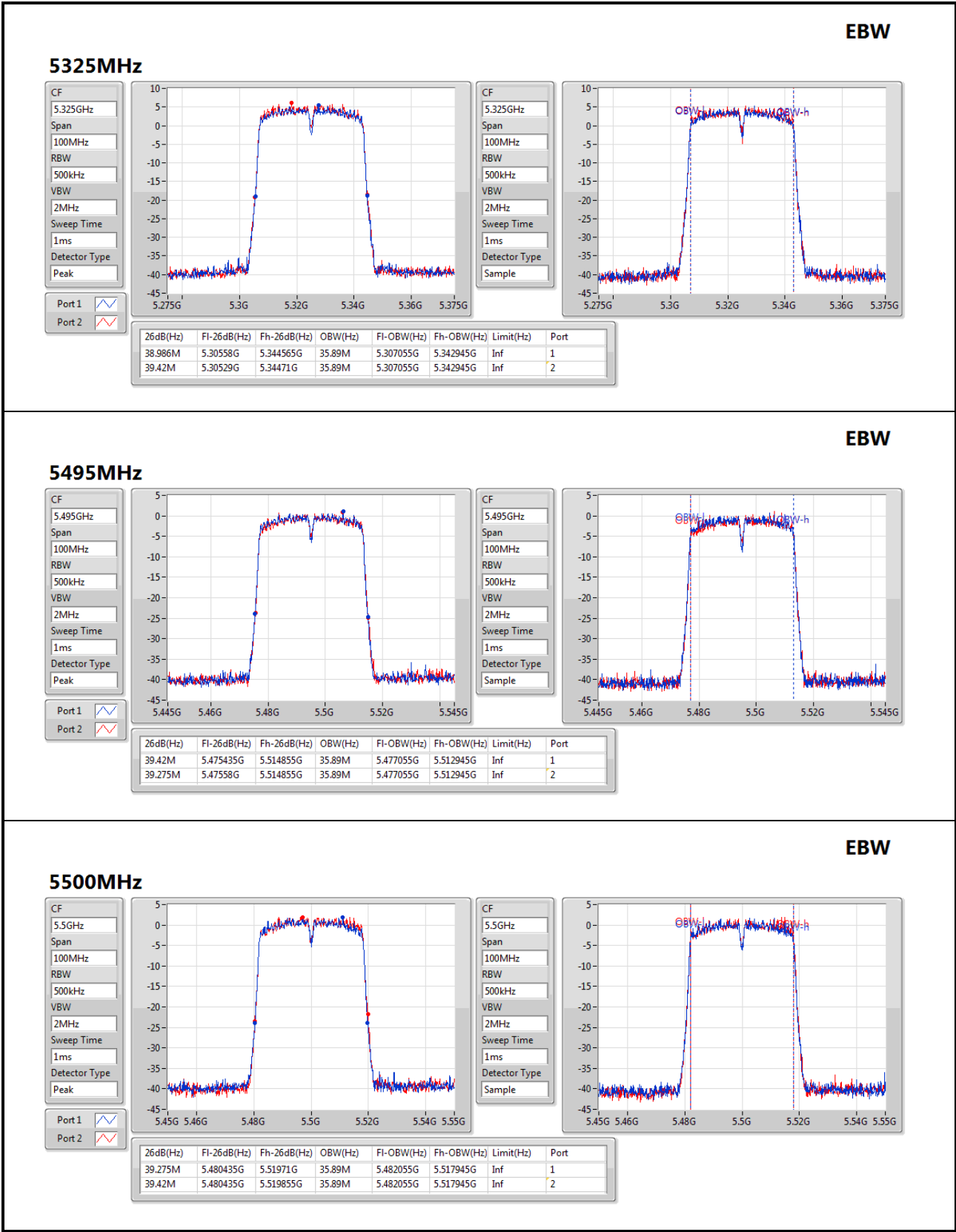

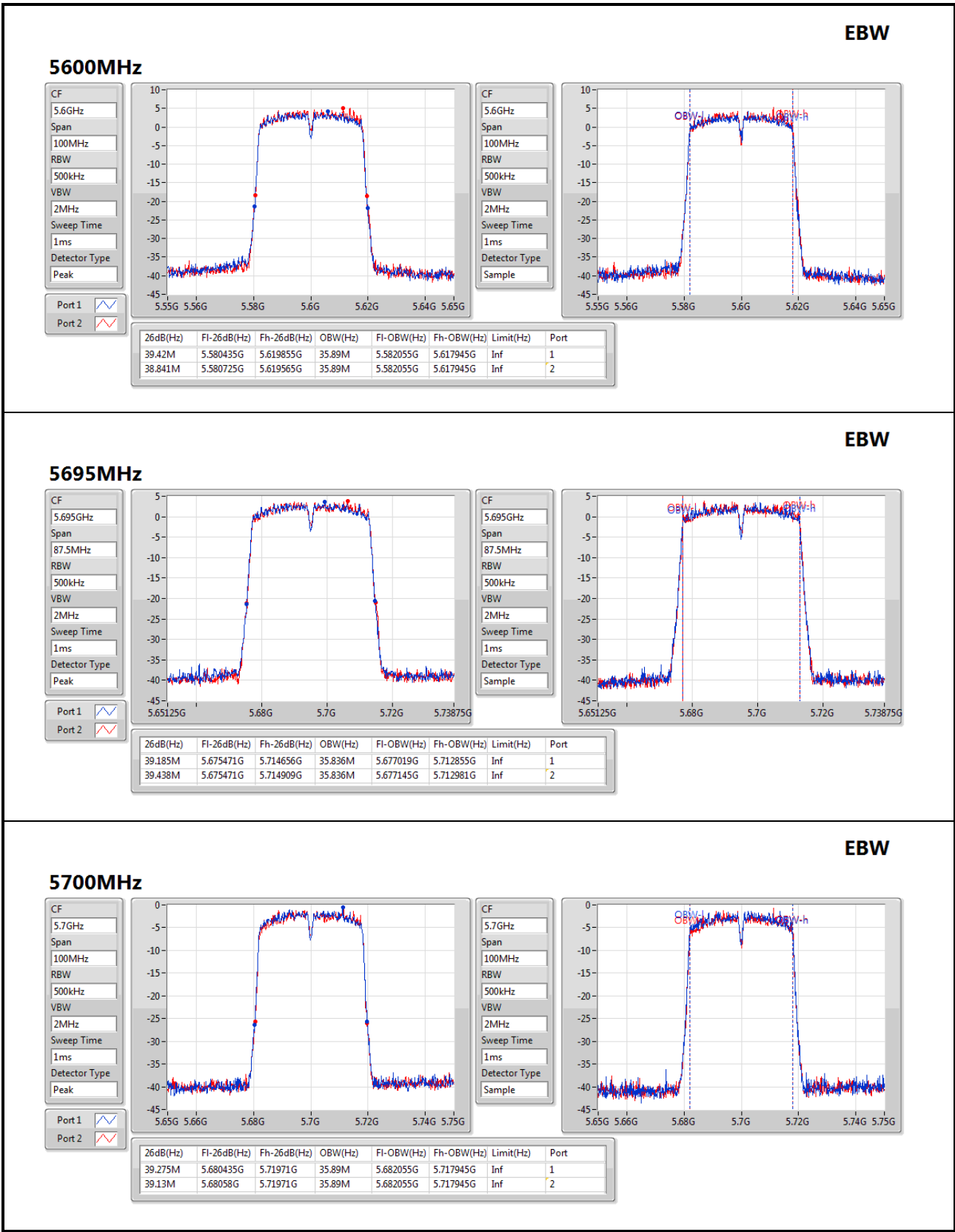

EBW

CF: 5.7GHz

Span: 100MHz

RBW: 500kHz

VBW: 2MHz

Sweep Time: 1ms

Detector Type: Peak

Port 1:

Port 2:



CF: 5.7GHz

Span: 100MHz

RBW: 500kHz

VBW: 2MHz

Sweep Time: 1ms

Detector Type: Sample



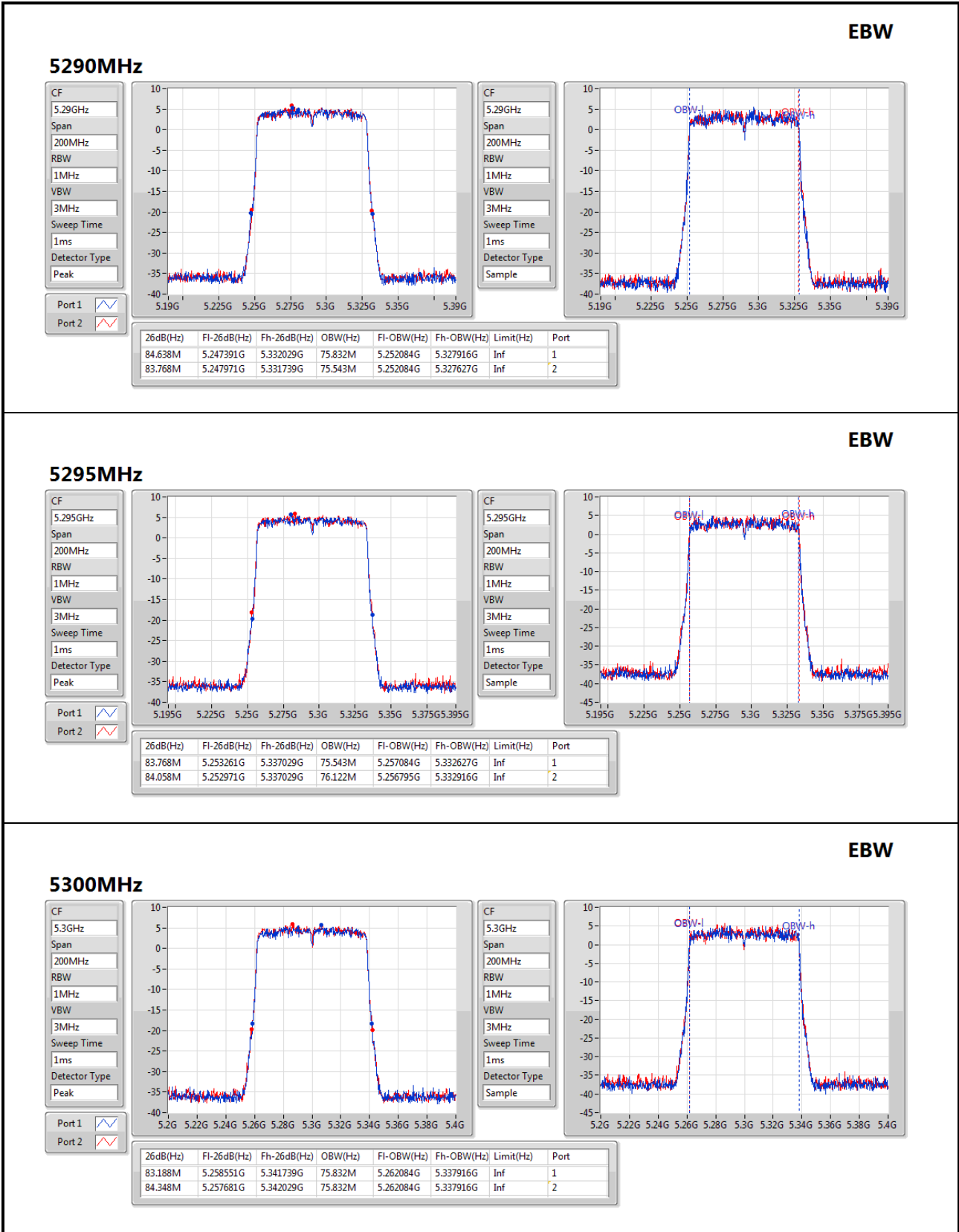

EBW

CF: 5.3GHz

Span: 200MHz

RBW: 1MHz

VBW: 3MHz

Sweep Time: 1ms

Detector Type: Peak

Port 1:

Port 2:



CF: 5.3GHz

Span: 200MHz

RBW: 1MHz

VBW: 3MHz

Sweep Time: 1ms

Detector Type: Sample



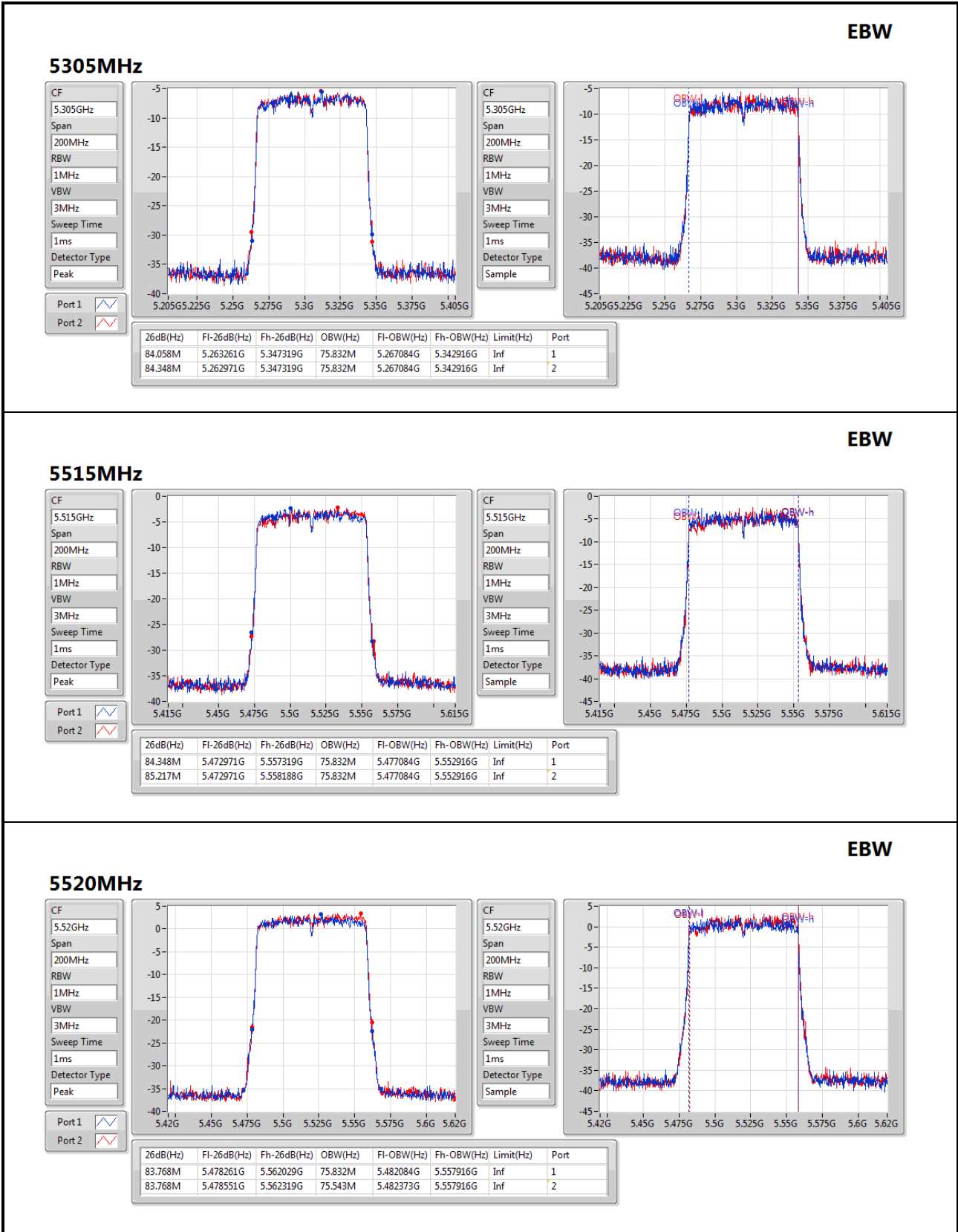

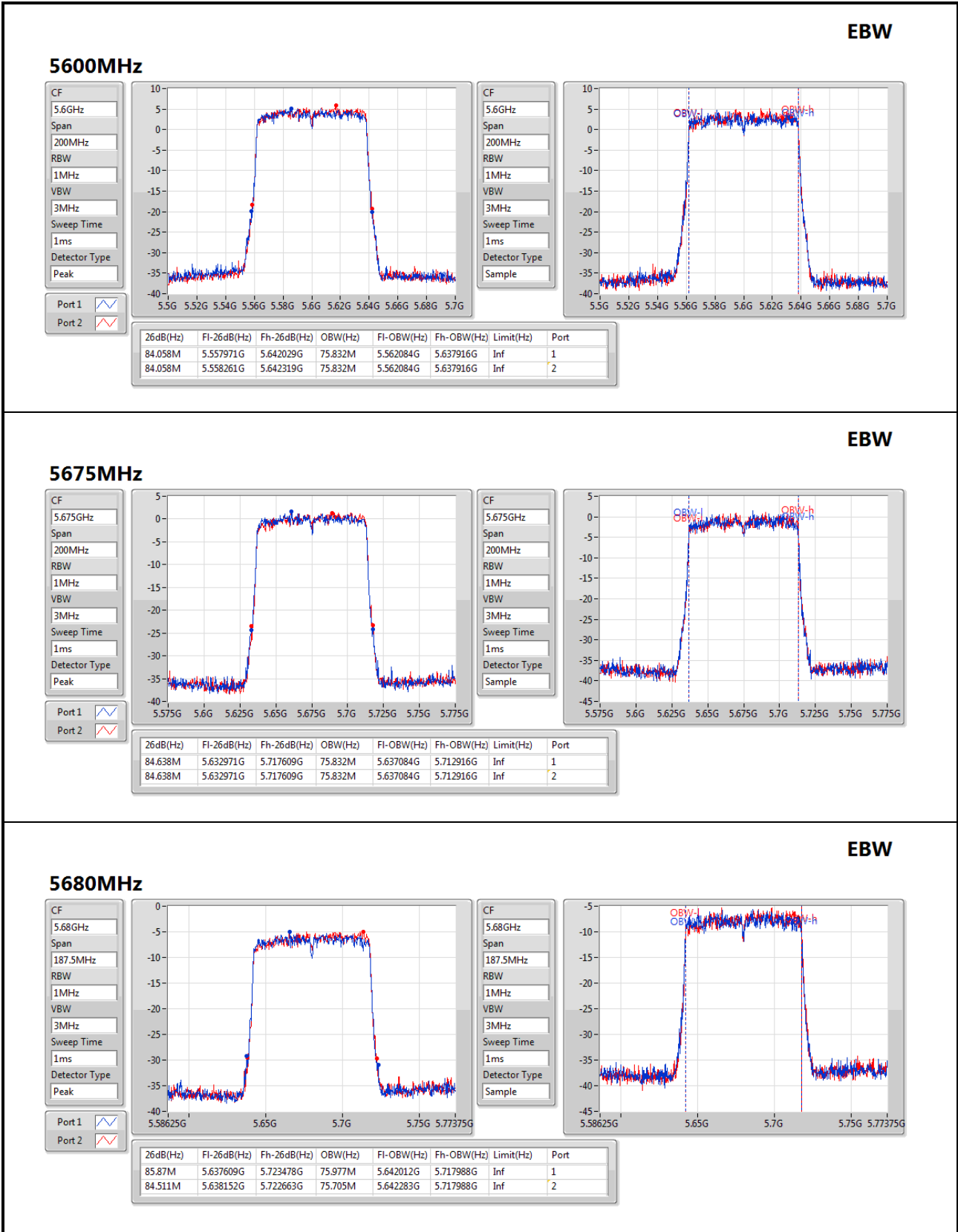

3.3 RF Output Power

3.3.1 Limit of RF Output Power

Frequency Band (MHz)	Limit
<input checked="" type="checkbox"/> 5250 ~ 5350	Conducted Power: 250mW or 11dBm+10 log B
<input checked="" type="checkbox"/> 5470 ~ 5725	Conducted Power: 250mW or 11dBm+10 log B
Note: "B" is the 26dB emission bandwidth in MHz.	

3.3.2 Test Procedures

Method PM-G (Measurement using a gated RF average power meter)

Measurements is performed using a wideband gated RF power meter provided that the gate parameters are adjusted such that the power is measured only when the EUT is transmitting at its maximum power control level. Since the measurement is made only during the ON time of the transmitter, no duty cycle correction factor is required.

Spectrum analyzer (For channel that extends across the 5.725 GHz boundary)

1. Set RBW = 1MHz, VBW = 3MHz, Sweep time = Auto, Detector = RMS.
2. Trace average at least 100 traces in power averaging mode.
3. Compute power by integrating the spectrum across the 26 dB EBW.
4. Add $10 \log(1/X)$, X:duty cycle) if duty cycle is <98%).

3.3.3 Test Setup

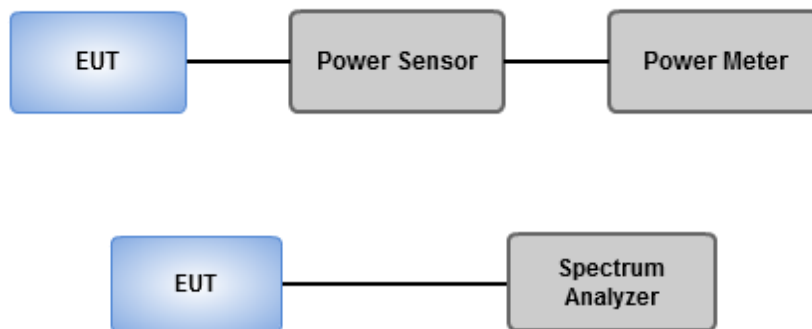

3.3.4 Test Result of Maximum Conducted Output Power

Summary

Proprietary protocol (BW: MHz)	Total Power (dBm)	Total Power (W)	EIRP (dBm)	EIRP (W)
5.25-5.35GHz	-	-	-	-
20_Nss1,(MCS0)_2TX	18.82	0.07621	29.82	0.95940
40_Nss1,(MCS0)_2TX	18.76	0.07516	29.76	0.94624
80_Nss1,(MCS0)_2TX	18.53	0.07129	29.53	0.89743
5.47-5.725GHz	-	-	-	-
20_Nss1,(MCS0)_2TX	18.79	0.07568	29.79	0.95280
40_Nss1,(MCS0)_2TX	18.58	0.07211	29.58	0.90782
80_Nss1,(MCS0)_2TX	18.51	0.07096	29.51	0.89331

Result

Proprietary protocol (BW: MHz)	Result	DG (dBi)	Port 1 (dBm)	Port 2 (dBm)	Total Power (dBm)	Power Limit (dBm)	EIRP (dBm)	EIRP Limit (dBm)
20_Nss1,(MCS0)_2TX	-	-	-	-	-	-	-	-
5260MHz	Pass	11.00	15.69	15.81	18.76	18.96	29.76	29.96
5300MHz	Pass	11.00	15.71	15.86	18.80	18.93	29.80	29.93
5330MHz	Pass	11.00	15.61	16.01	18.82	18.93	29.82	29.93
5335MHz	Pass	11.00	15.56	15.94	18.76	18.91	29.76	29.91
5485MHz	Pass	11.00	10.74	10.78	13.77	18.95	24.77	29.95
5490MHz	Pass	11.00	13.96	13.95	16.97	18.98	27.97	29.98
5600MHz	Pass	11.00	15.83	15.73	18.79	18.93	29.79	29.93
5705MHz	Pass	11.00	14.88	14.68	17.79	18.91	28.79	29.91
5710MHz	Pass	11.00	7.62	7.65	10.65	18.95	21.65	29.95
40_Nss1,(MCS0)_2TX	-	-	-	-	-	-	-	-
5270MHz	Pass	11.00	15.52	15.54	18.54	19.00	29.54	30.00
5300MHz	Pass	11.00	15.51	15.53	18.53	19.00	29.53	30.00
5320MHz	Pass	11.00	15.58	15.89	18.75	19.00	29.75	30.00
5325MHz	Pass	11.00	15.62	15.87	18.76	19.00	29.76	30.00
5495MHz	Pass	11.00	11.53	11.37	14.46	19.00	25.46	30.00
5500MHz	Pass	11.00	12.48	12.55	15.53	19.00	26.53	30.00
5600MHz	Pass	11.00	15.58	15.56	18.58	19.00	29.58	30.00
5695MHz	Pass	11.00	14.43	14.55	17.50	19.00	28.50	30.00
5700MHz	Pass	11.00	9.97	9.77	12.88	19.00	23.88	30.00
80_Nss1,(MCS0)_2TX	-	-	-	-	-	-	-	-
5290MHz	Pass	11.00	15.31	15.44	18.39	19.00	29.39	30.00
5295MHz	Pass	11.00	15.38	15.53	18.47	19.00	29.47	30.00
5300MHz	Pass	11.00	15.58	15.46	18.53	19.00	29.53	30.00
5305MHz	Pass	11.00	4.43	4.65	7.55	19.00	18.55	30.00
5515MHz	Pass	11.00	7.86	7.83	10.86	19.00	21.86	30.00
5520MHz	Pass	11.00	13.25	13.44	16.36	19.00	27.36	30.00
5600MHz	Pass	11.00	15.49	15.51	18.51	19.00	29.51	30.00
5675MHz	Pass	11.00	11.16	11.25	14.22	19.00	25.22	30.00
5680MHz	Pass	11.00	4.66	4.89	7.79	19.00	18.79	30.00

DG = Directional Gain = 11dBi > 6 dBi, Power limit shall be reduced 5 dB
Port X = Port X output power

3.4 Peak Power Spectral Density

3.4.1 Limit of Peak Power Spectral Density

Frequency Band (MHz)		Limit
<input checked="" type="checkbox"/>	5250 ~ 5350	11 dBm / MHz
<input checked="" type="checkbox"/>	5470 ~ 5725	11 dBm / MHz

3.4.2 Test Procedures

Duty cycle \geq 98 %

1. Set RBW = 1 MHz, VBW = 3 MHz, Sweep time = auto, Detector = RMS.
2. Trace average 100 traces.
3. Use the peak marker function to determine the maximum amplitude level.

Duty cycle < 98 %

1. Set RBW = 1 MHz, VBW = 3 MHz, Detector = RMS.
2. Set sweep time \geq 10 * (number of points in sweep) * (total on/off period of the transmitted signal).
3. Perform a single sweep.
4. Use the peak marker function to determine the maximum amplitude level.
5. Add $10 \log(1/x)$, where x is the duty cycle.

3.4.3 Test Setup

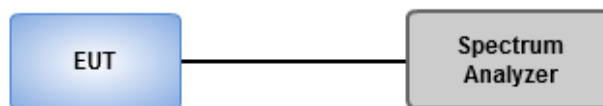

3.4.4 Test Result of Peak Power Spectral Density

Summary

Proprietary protocol (BW: MHz)	PD (dBm/RBW)	EIRP PD (dBm/RBW)
5.25-5.35GHz	-	-
20_Nss1,(MCS0)_2TX	5.27	16.27
40_Nss1,(MCS0)_2TX	2.49	13.49
80_Nss1,(MCS0)_2TX	-1.56	9.44
5.47-5.725GHz	-	-
20_Nss1,(MCS0)_2TX	4.63	15.63
40_Nss1,(MCS0)_2TX	1.36	12.36
80_Nss1,(MCS0)_2TX	-1.96	9.04

RBW = 1MHz

Result

Proprietary protocol (BW: MHz)	Result	DG (dBi)	Port 1 (dBm/R BW)	Port 2 (dBm/R BW)	PD (dBm/R BW)	PD Limit (dBm/R BW)	EIRP PD (dBm/R BW)	EIRP PD Limit (dBm/R BW)
20_Nss1,(MCS0)_2TX	-	-	-	-	-	-	-	-
5260MHz	Pass	11.00	1.75	2.13	4.95	6.00	15.95	17.00
5300MHz	Pass	11.00	2.06	2.48	5.27	6.00	16.27	17.00
5330MHz	Pass	11.00	1.78	2.39	5.09	6.00	16.09	17.00
5335MHz	Pass	11.00	1.55	2.25	4.92	6.00	15.92	17.00
5485MHz	Pass	11.00	-3.58	-3.36	-0.49	6.00	10.51	17.00
5490MHz	Pass	11.00	-0.45	-0.36	2.59	6.00	13.59	17.00
5600MHz	Pass	11.00	1.45	1.88	4.63	6.00	15.63	17.00
5705MHz	Pass	11.00	0.86	0.57	3.65	6.00	14.65	17.00
5710MHz	Pass	11.00	-6.37	-6.67	-3.58	6.00	7.42	17.00
40_Nss1,(MCS0)_2TX	-	-	-	-	-	-	-	-
5270MHz	Pass	11.00	-0.75	-0.38	2.41	6.00	13.41	17.00
5300MHz	Pass	11.00	-0.73	-0.30	2.49	6.00	13.49	17.00
5320MHz	Pass	11.00	-0.99	-0.46	2.28	6.00	13.28	17.00
5325MHz	Pass	11.00	-1.01	-0.47	2.26	6.00	13.26	17.00
5495MHz	Pass	11.00	-5.29	-5.39	-2.35	6.00	8.65	17.00
5500MHz	Pass	11.00	-4.35	-4.05	-1.19	6.00	9.81	17.00
5600MHz	Pass	11.00	-1.91	-1.37	1.36	6.00	12.36	17.00
5695MHz	Pass	11.00	-2.42	-2.37	0.57	6.00	11.57	17.00
5700MHz	Pass	11.00	-7.03	-7.22	-4.14	6.00	6.86	17.00
80_Nss1,(MCS0)_2TX	-	-	-	-	-	-	-	-
5290MHz	Pass	11.00	-4.83	-4.64	-1.73	6.00	9.27	17.00
5295MHz	Pass	11.00	-4.65	-4.54	-1.58	6.00	9.42	17.00
5300MHz	Pass	11.00	-4.64	-4.51	-1.56	6.00	9.44	17.00
5305MHz	Pass	11.00	-15.72	-15.76	-12.73	6.00	-1.73	17.00
5515MHz	Pass	11.00	-12.57	-12.42	-9.58	6.00	1.42	17.00
5520MHz	Pass	11.00	-7.16	-6.74	-4.03	6.00	6.97	17.00
5600MHz	Pass	11.00	-5.17	-4.67	-1.96	6.00	9.04	17.00
5675MHz	Pass	11.00	-8.90	-8.71	-5.85	6.00	5.15	17.00
5680MHz	Pass	11.00	-15.43	-15.11	-12.26	6.00	-1.26	17.00

DG = Directional Gain = 11dBi > 6dBi, PD limit shall be reduced to 11 dBm- (11 dBi – 6dBi)= 6dBm

RBW = 1MHz

PD = trace bin-by-bin of each transmits port summing can be performed maximum power density; **Port X** = Port Xpower density;

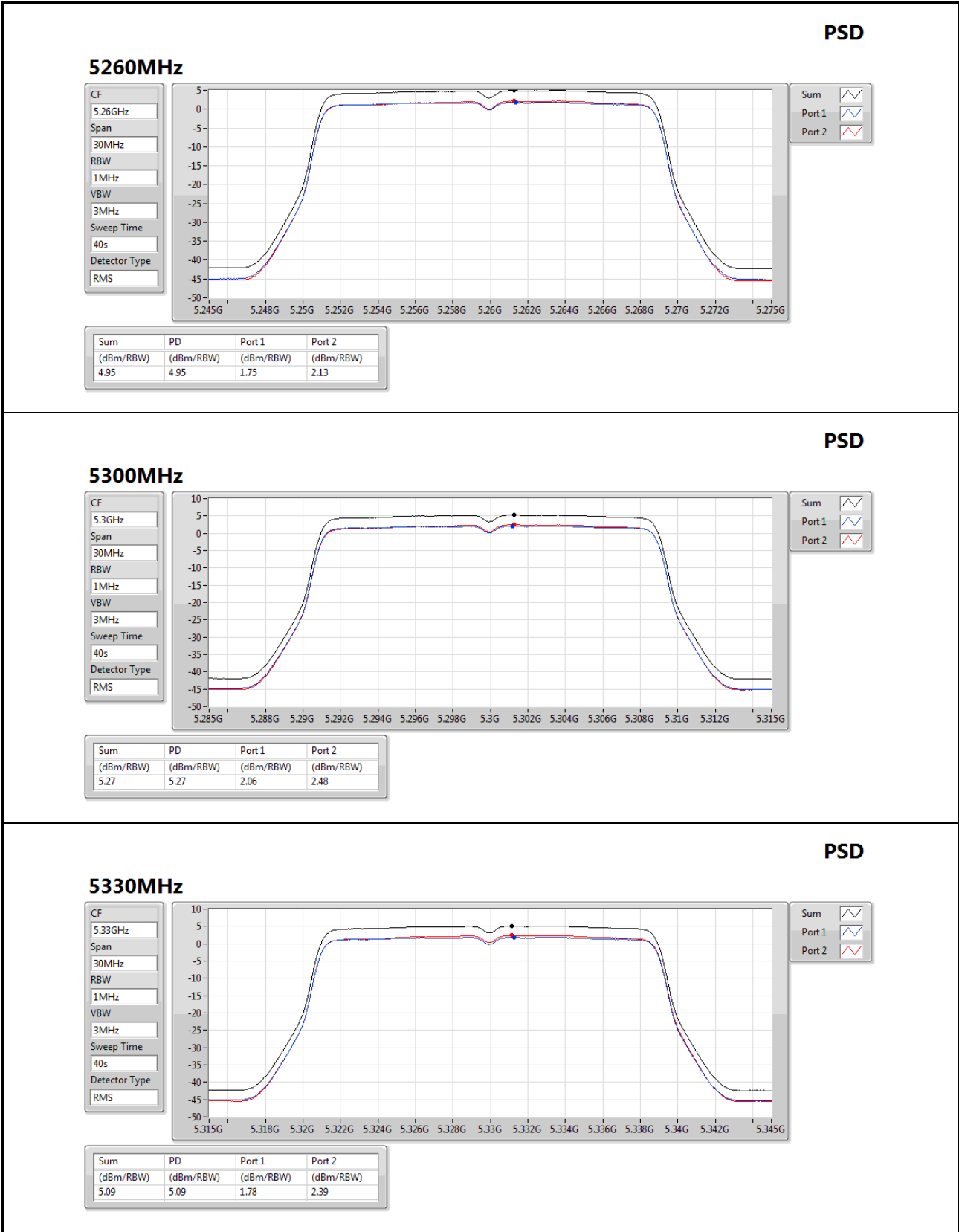

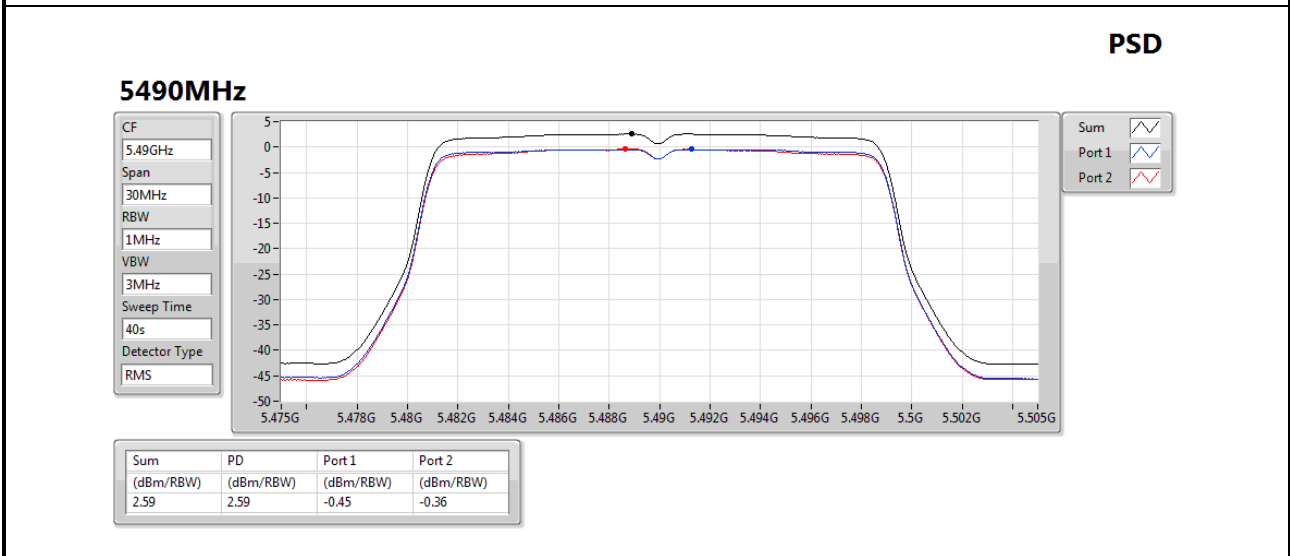
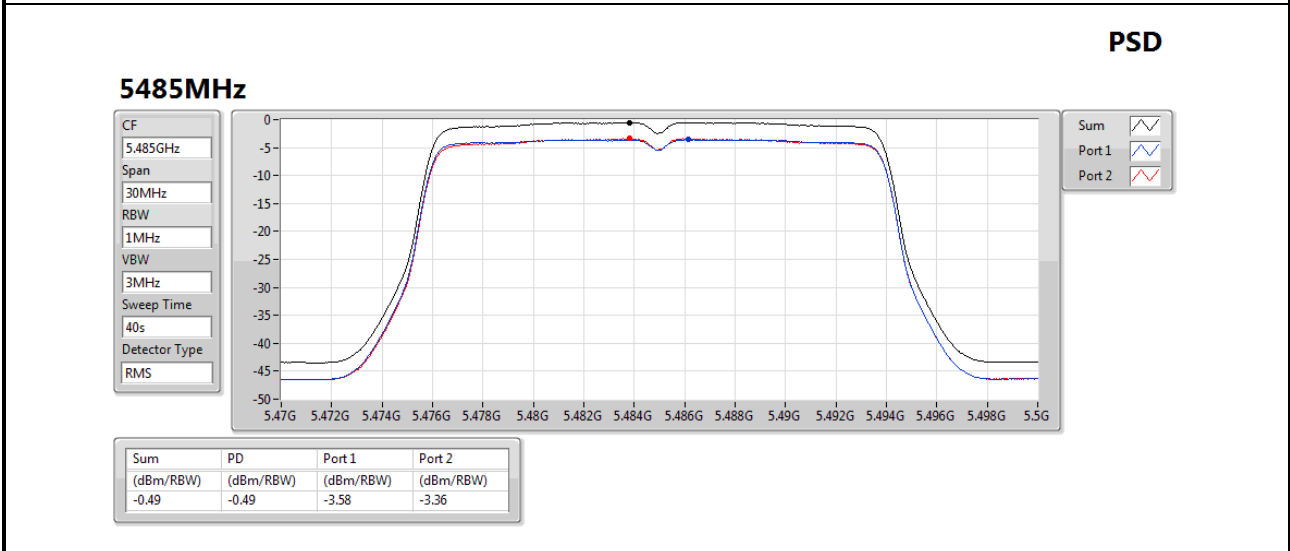
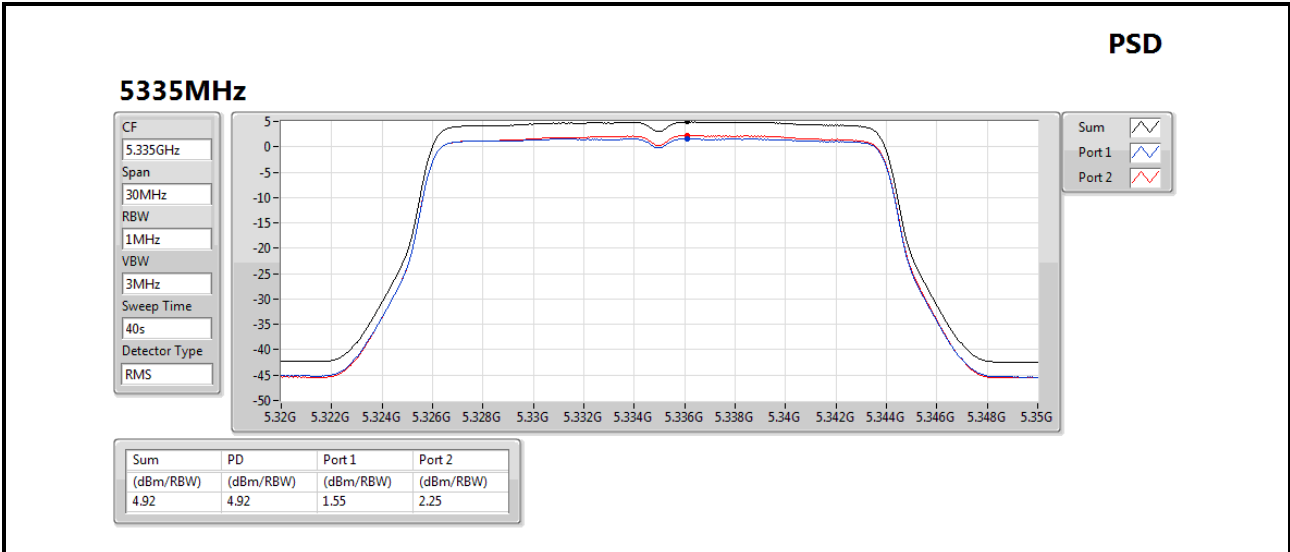

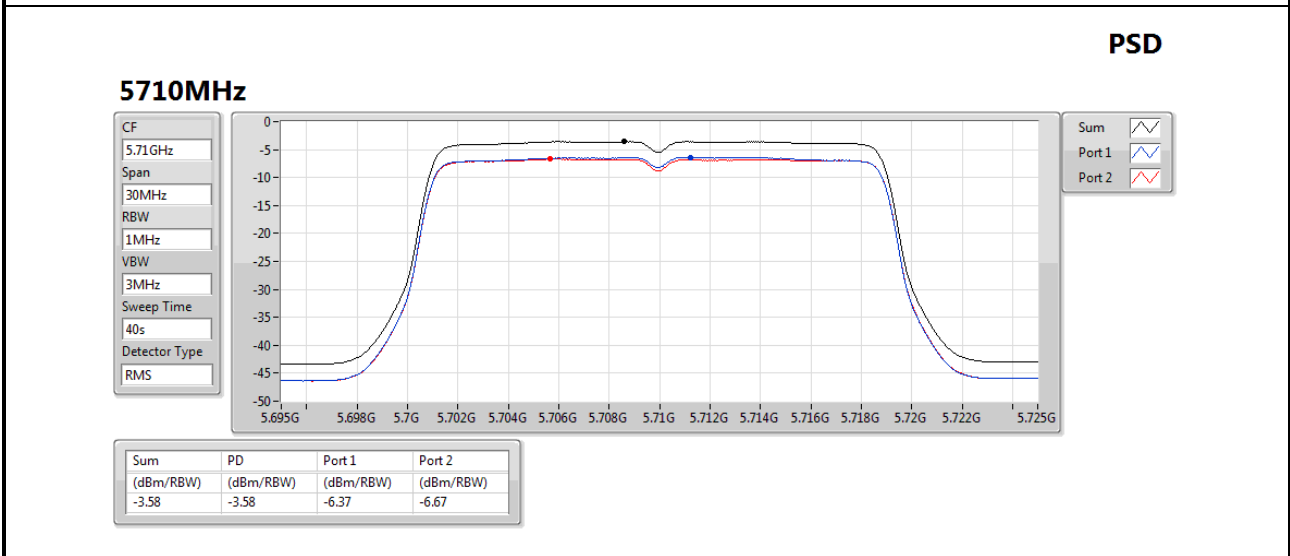
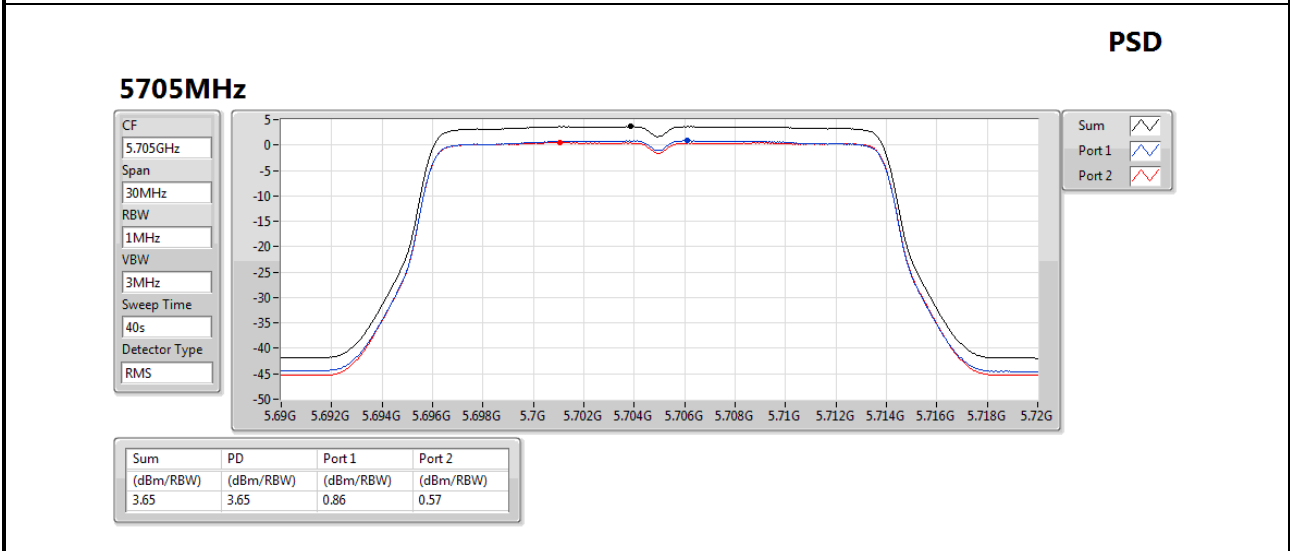
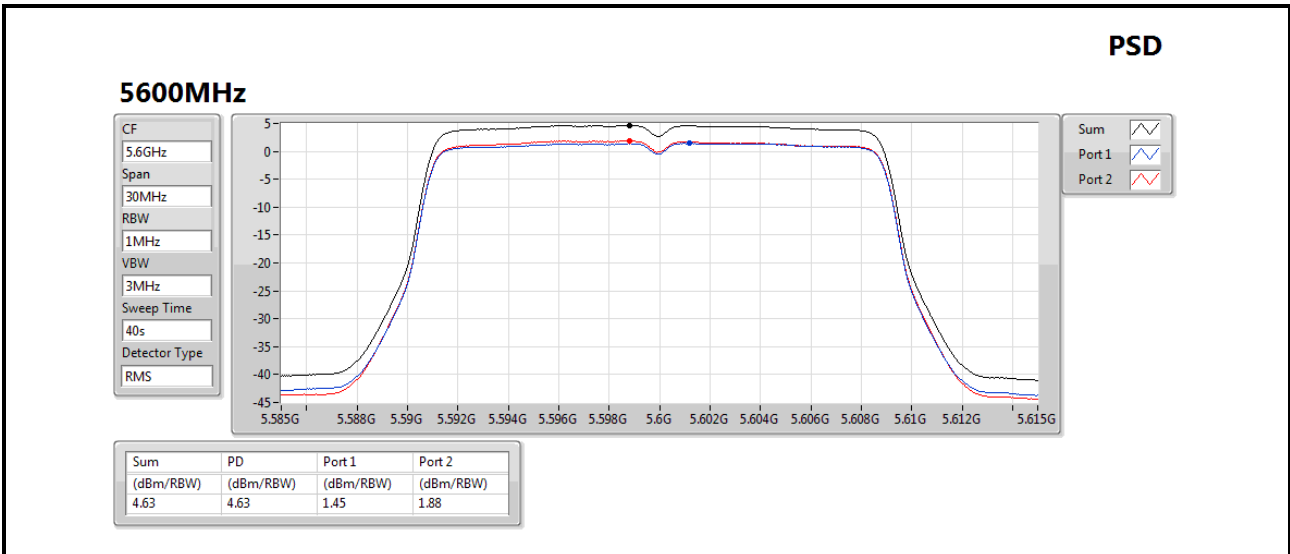

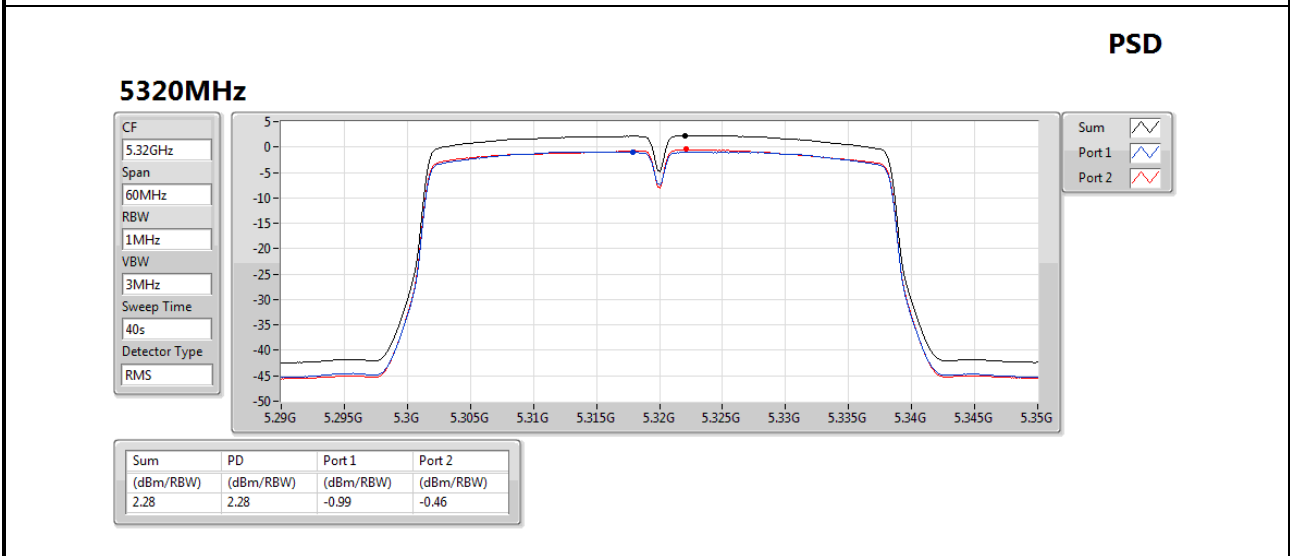
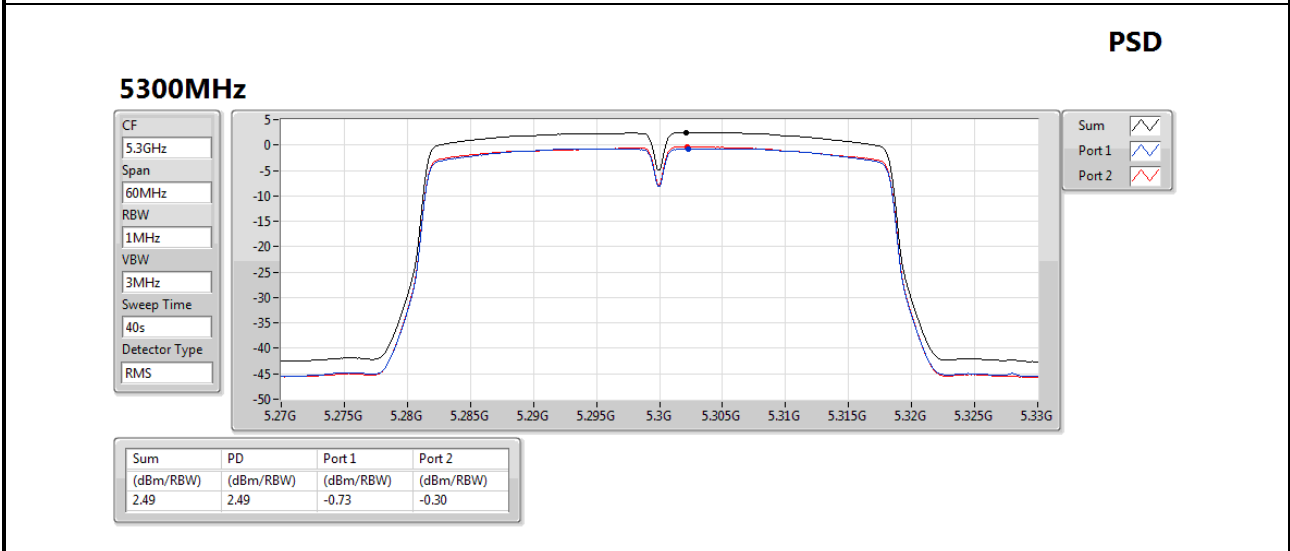
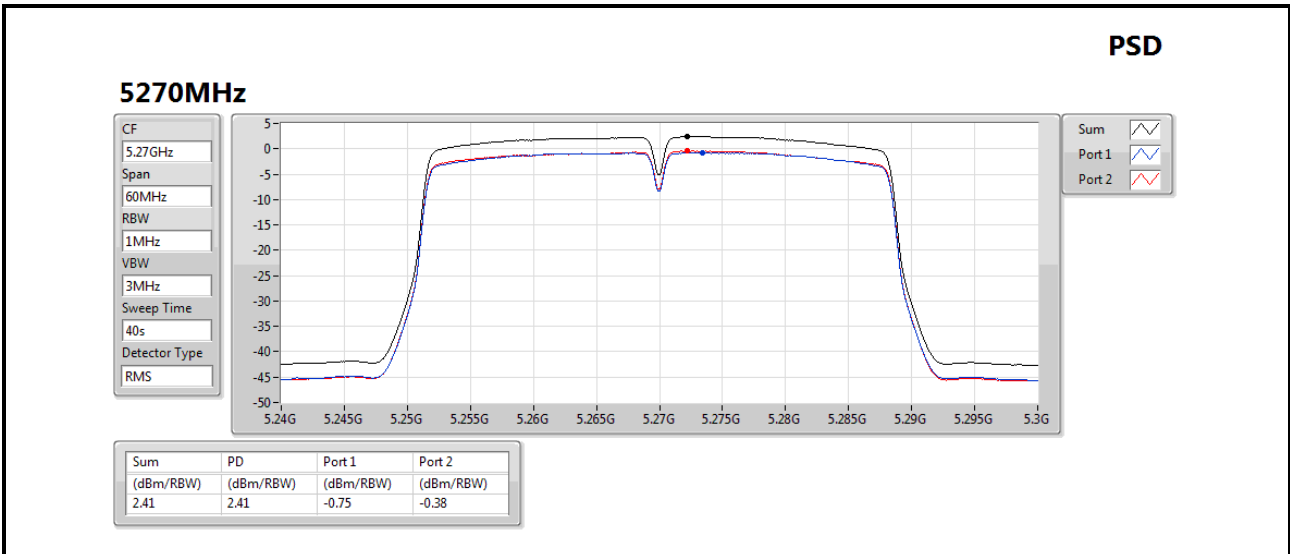

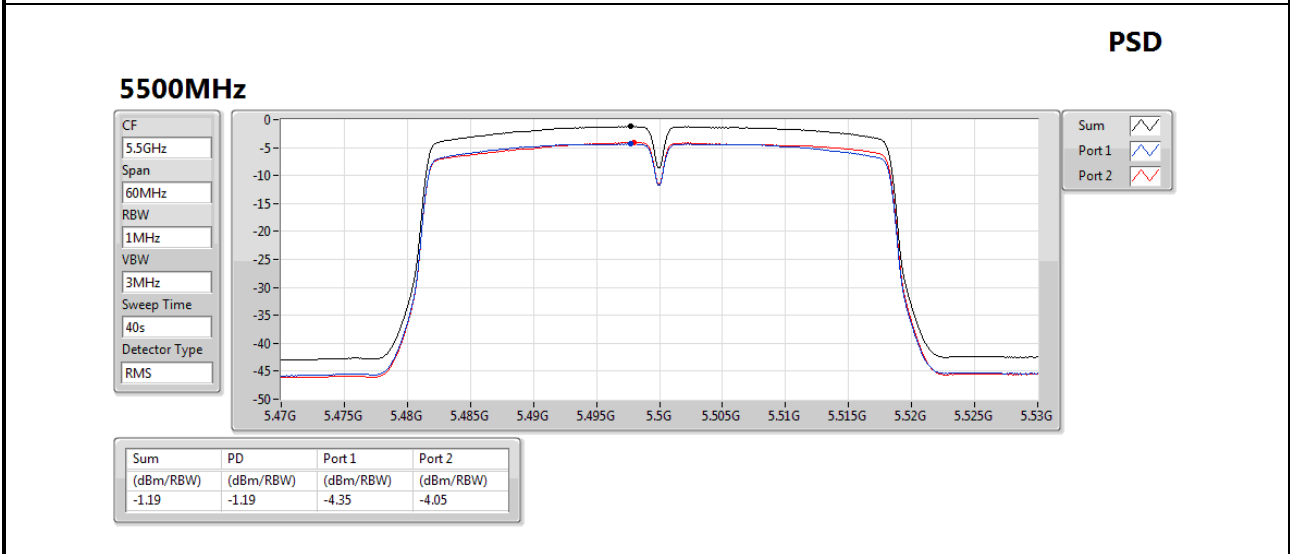
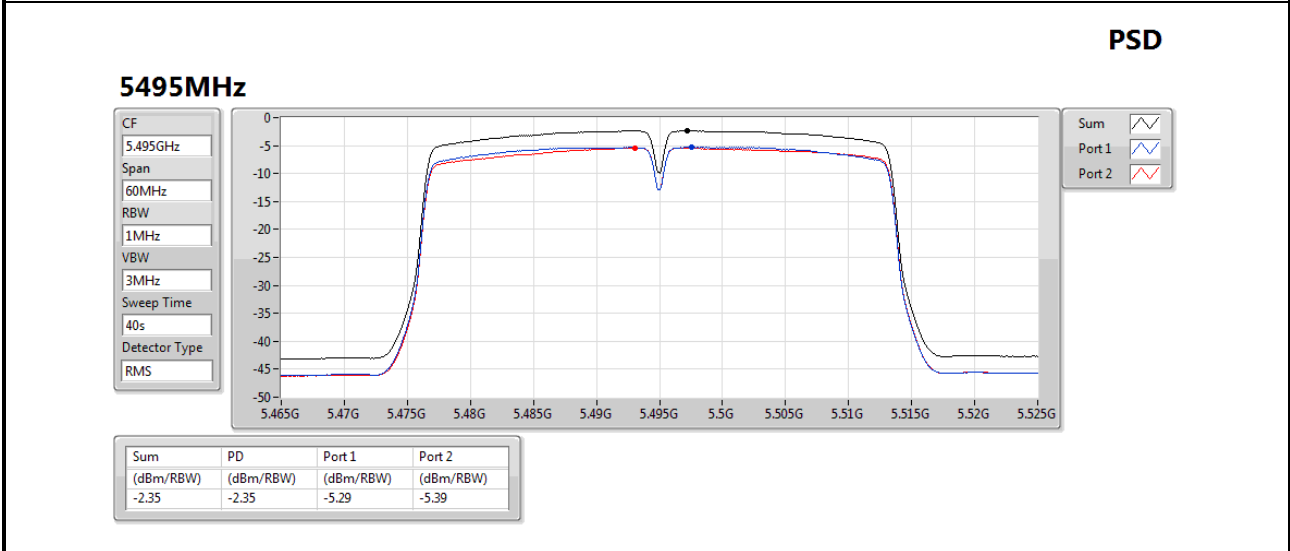
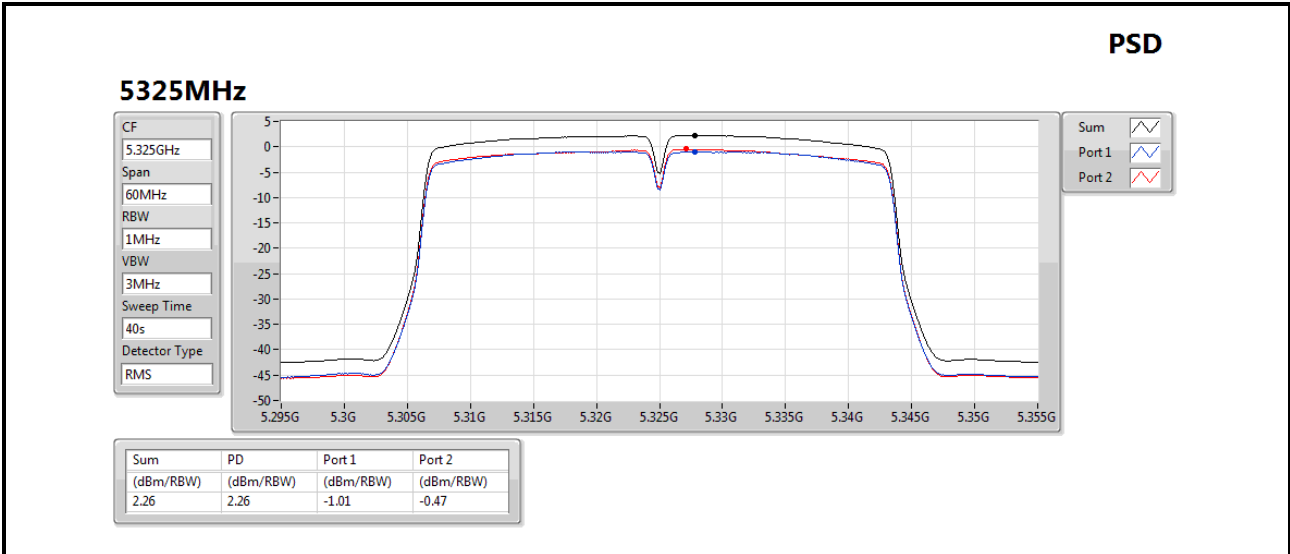

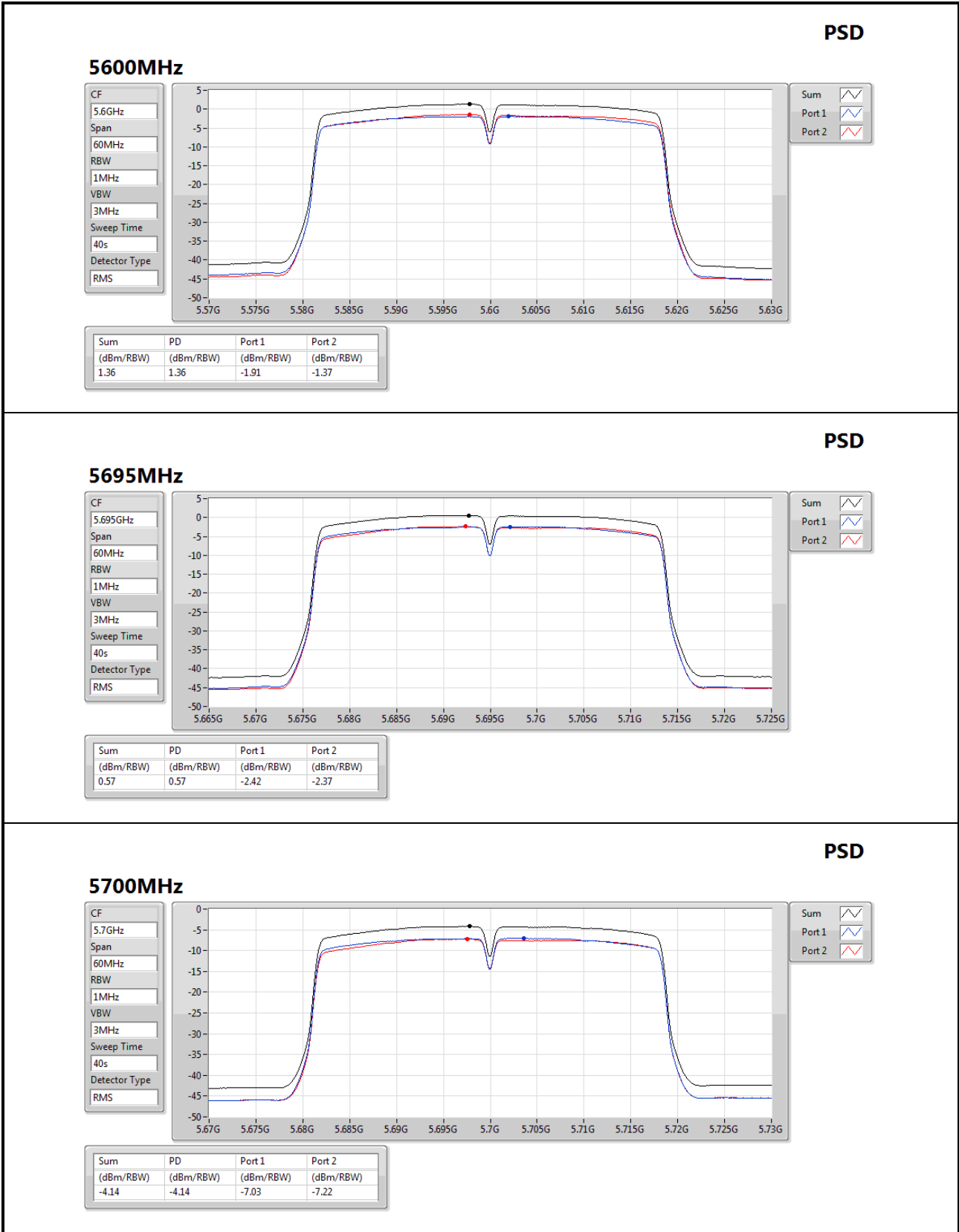

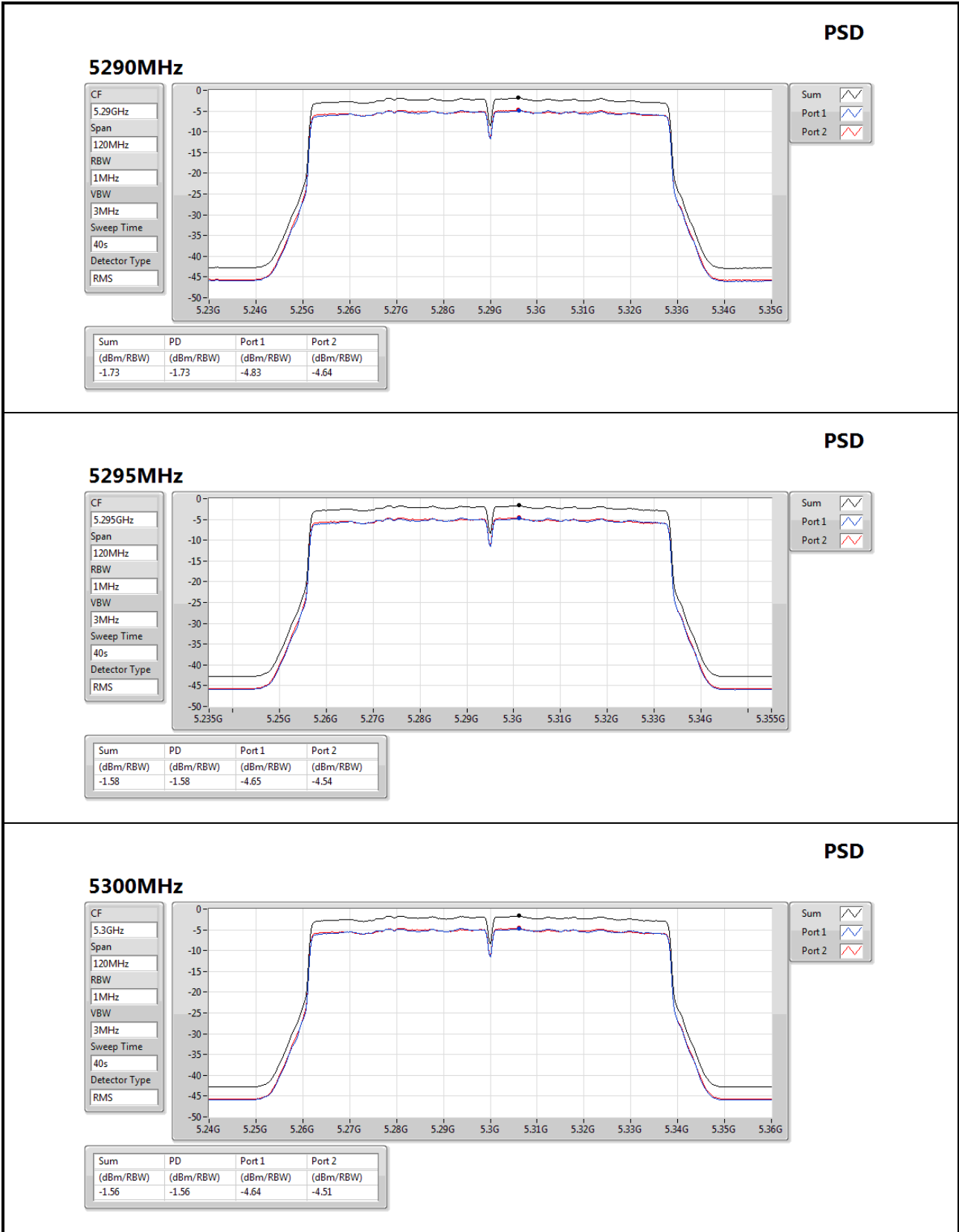
**PSD****5300MHz**

CF
5.3GHz

Span
120MHz

RBW
1MHz

VBW
3MHz

Sweep Time
40s

Detector Type
RMS



Sum 

Port 1 

Port 2 

Sum	PD	Port 1	Port 2
(dBm/RBW)	(dBm/RBW)	(dBm/RBW)	(dBm/RBW)
-1.56	-1.56	-4.64	-4.51

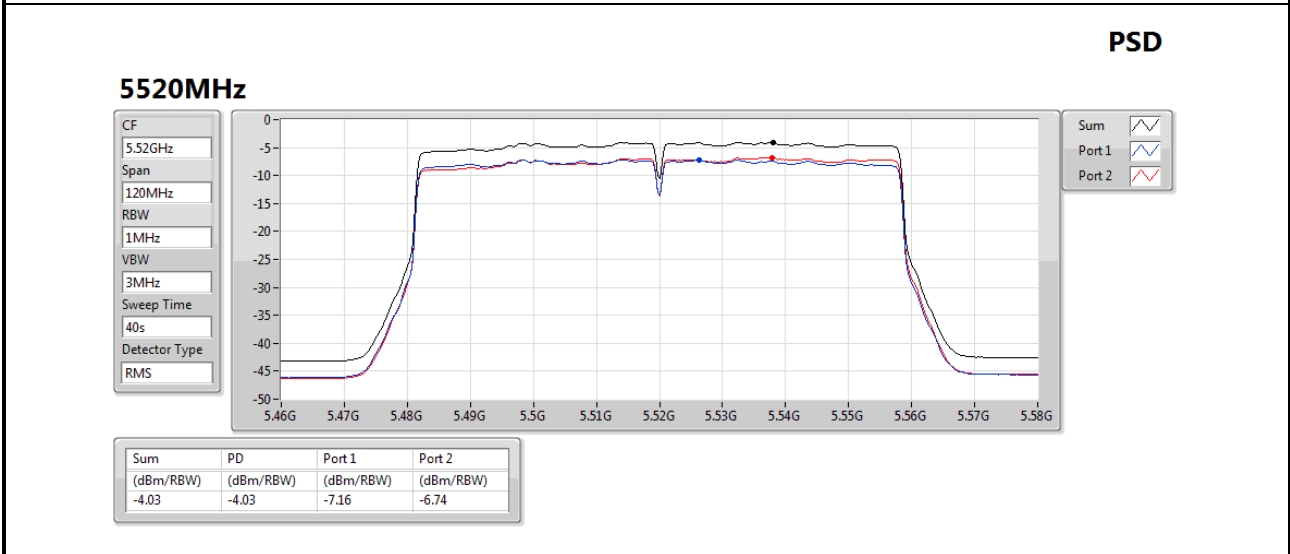
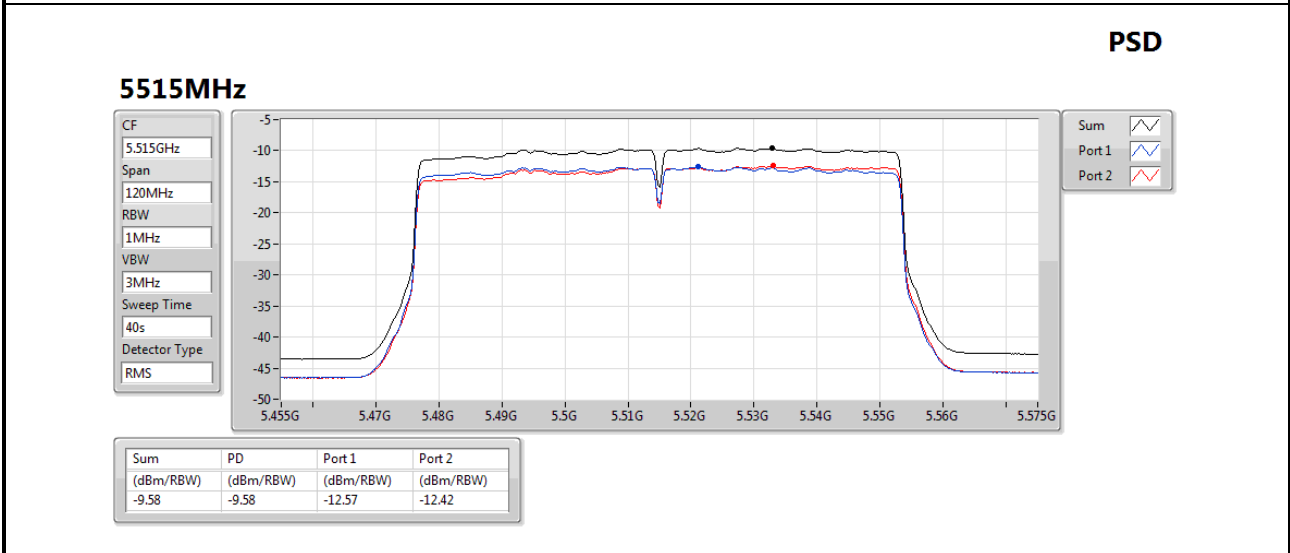
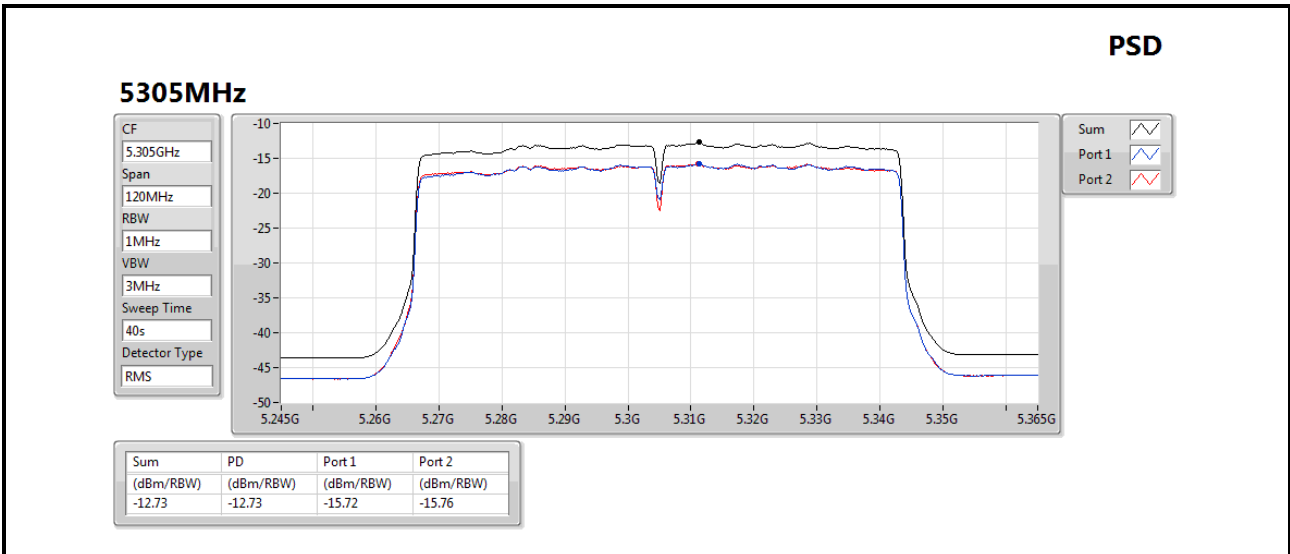

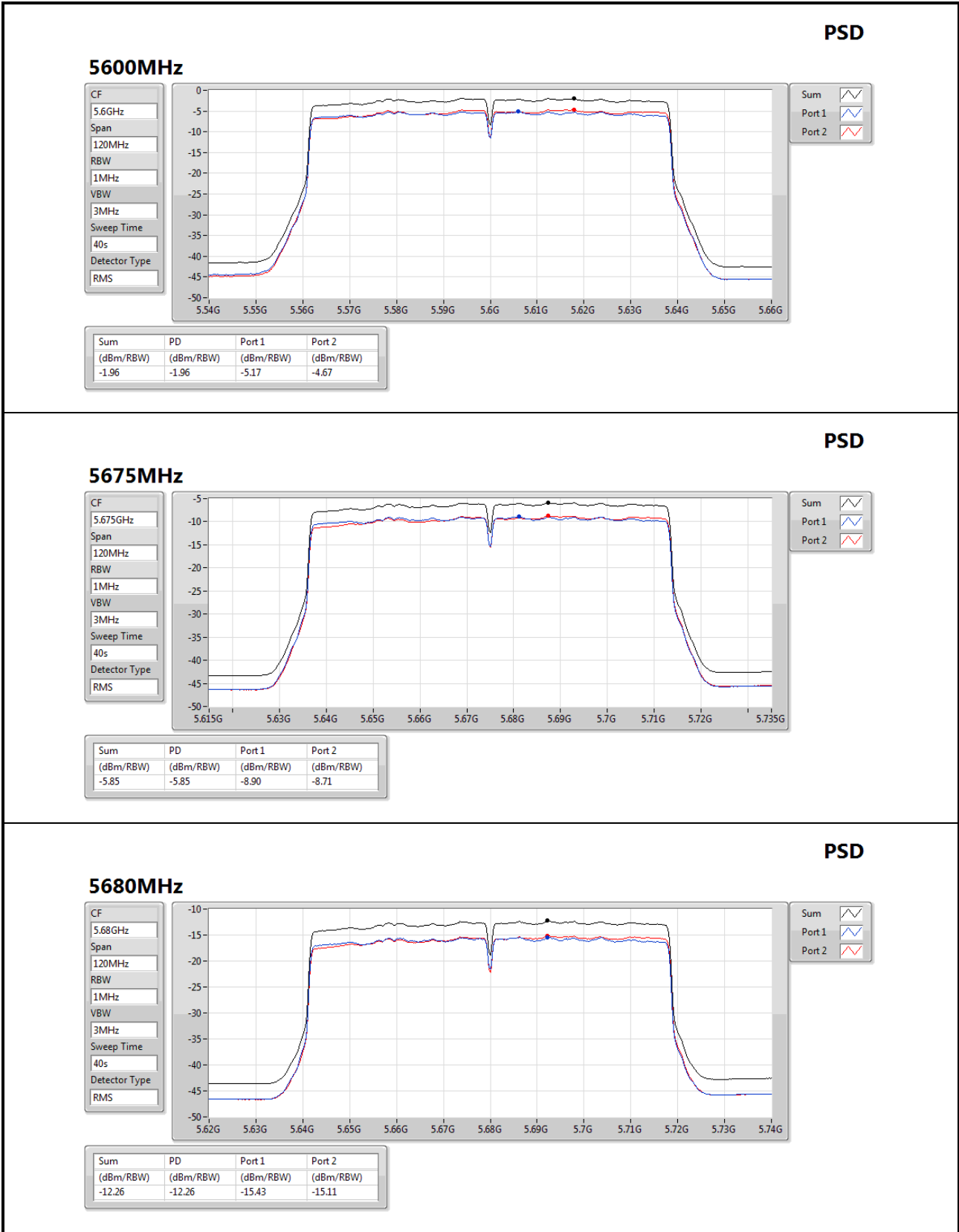

3.5 Transmitter Radiated and Band Edge Emissions

3.5.1 Limit of Transmitter Radiated and Band Edge Emissions

Restricted Band Emissions Limit			
Frequency Range (MHz)	Field Strength (uV/m)	Field Strength (dBuV/m)	Measure Distance (m)
0.009~0.490	2400/F(kHz)	48.5 - 13.8	300
0.490~1.705	24000/F(kHz)	33.8 - 23	30
1.705~30.0	30	29	30
30~88	100	40	3
88~216	150	43.5	3
216~960	200	46	3
Above 960	500	54	3

Note 1:
Qusai-Peak value is measured for frequency below 1GHz except for 9–90 kHz, 110–490 kHz frequency band. Peak and average value are measured for frequency above 1GHz. The limit on average radio frequency emission is as above table. The limit on peak radio frequency emissions is 20 dB above the maximum permitted average emission limit

Note 2:
Measurements may be performed at a distance other than what is specified provided. When performing measurements at a distance other than that specified, the results shall be extrapolated to the specified distance using an extrapolation factor as below, Frequency at or above 30 MHz: 20 dB/decade Frequency below 30 MHz: 40 dB/decade.

Un-restricted band emissions above 1GHz Limit	
Operating Band	Limit
5.25 - 5.35 GHz	e.i.r.p. -27 dBm [68.2 dBuV/m@3m]
5.47 - 5.725 GHz	e.i.r.p. -27 dBm [68.2 dBuV/m@3m]

Note 1: Measurements may be performed at a distance other than the limit distance provided they are not performed in the near field and the emissions to be measured can be detected by the measurement equipment. When performing measurements at a distance other than that specified, the results shall be extrapolated to the specified distance using an extrapolation factor of 20 dB/decade (inverse of linear distance for field-strength measurements, inverse of linear distance-squared for power-density measurements).

3.5.2 Test Procedures

1. Measurement is made at a semi-anechoic chamber that incorporates a turntable allowing a EUT rotation of 360°. A continuously-rotating, remotely-controlled turntable is installed at the test site to support the EUT and facilitate determination of the direction of maximum radiation for each EUT emission frequency. The EUT is placed at test table. For emissions testing at or below 1 GHz, the table height is 80 cm above the reference ground plane. For emission measurements above 1 GHz, the table height is 1.5 m
2. Measurement is made with the antenna positioned in both the horizontal and vertical planes of polarization. The measurement antenna is varied in height (1m ~ 4m) above the reference ground plane to obtain the maximum signal strength. Distance between EUT and antenna is 3 m.
3. This investigation is performed with the EUT rotated 360°, the antenna height scanned between 1 m and 4 m, and the antenna rotated to repeat the measurements for both the horizontal and vertical antenna polarizations.

Note:

1. 120kHz measurement bandwidth of test receiver and Quasi-peak detector is for radiated emission below 1GHz.
2. RBW=1MHz, VBW=3MHz and Peak detector is for peak measured value of radiated emission above 1GHz.
3. RBW=1MHz, VBW=1/T and Peak detector is for average measured value of radiated emission above 1GHz.

3.5.3 Test Setup

Radiated Emissions below 1 GHz

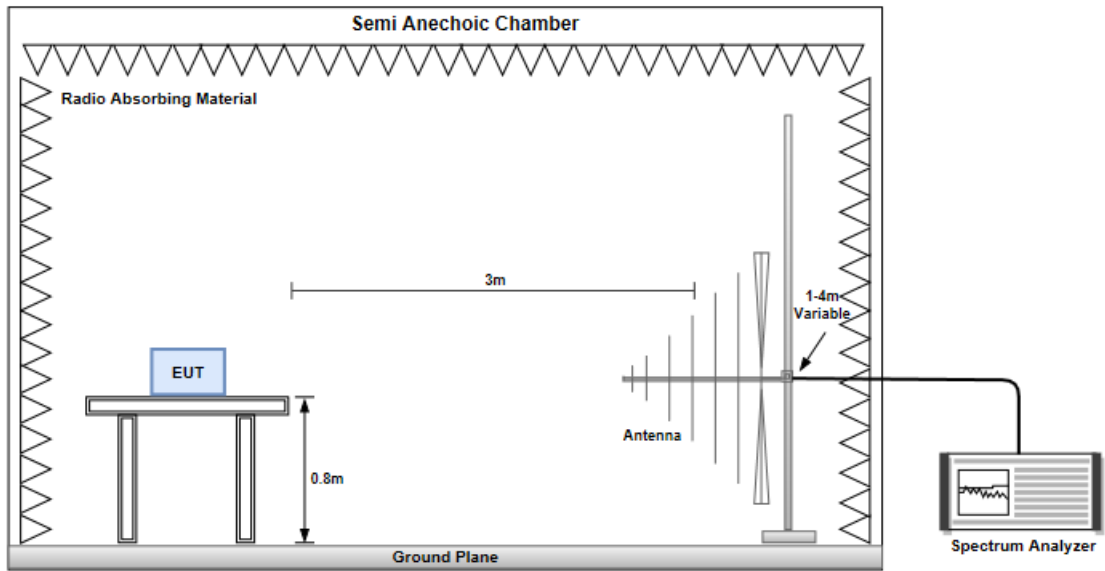

Radiated Emissions above 1 GHz

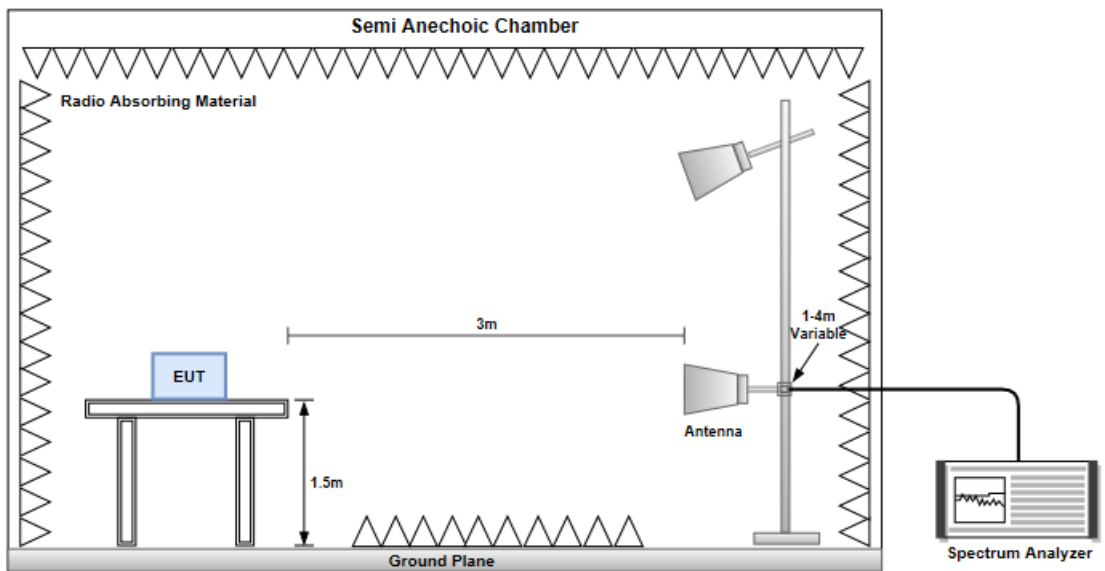

3.5.4 Transmitter Radiated Unwanted Emissions (Below 1GHz)

Proprietary protocol (MHz)	20	Test Freq. (MHz)	5330
Polarization	Horizontal		

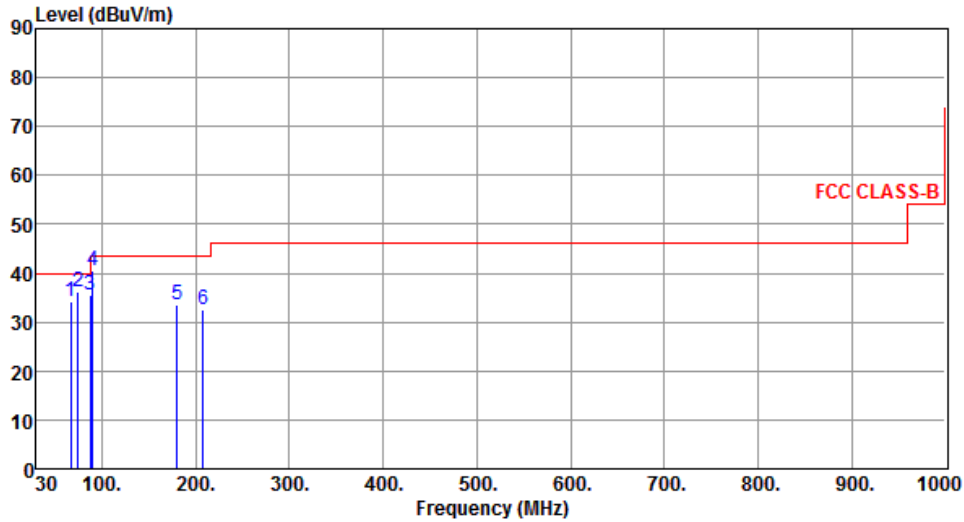

	Freq. MHz	Emission level dBuV/m	Limit dBuV/m	Margin dB	SA reading dBuV	Factor dB	Remark	ANT High cm	Turn Table deg
1	66.61	34.31	40.00	-5.69	44.65	-10.34	Peak	---	---
2	74.62	36.12	40.00	-3.88	48.00	-11.88	Peak	---	---
3	87.46	35.49	40.00	-4.51	50.17	-14.68	QP	195	76
4	90.21	40.38	43.50	-3.12	55.12	-14.74	Peak	---	---
5	180.42	33.61	43.50	-9.89	43.85	-10.24	Peak	---	---
6	207.49	32.65	43.50	-10.85	44.70	-12.05	Peak	---	---

Note 1: Emission Level (dBuV/m) = SA Reading (dBuV/m) + Factor* (dB)

*Factor includes antenna factor, cable loss and amplifier gain

Note 2: Margin (dB) = Emission level (dBuV/m) – Limit (dBuV/m).

Note 3: All spurious emissions below 30MHz are more than 20 dB below the limit.

Proprietary protocol (MHz)	20	Test Freq. (MHz)	5330
Polarization	Vertical		

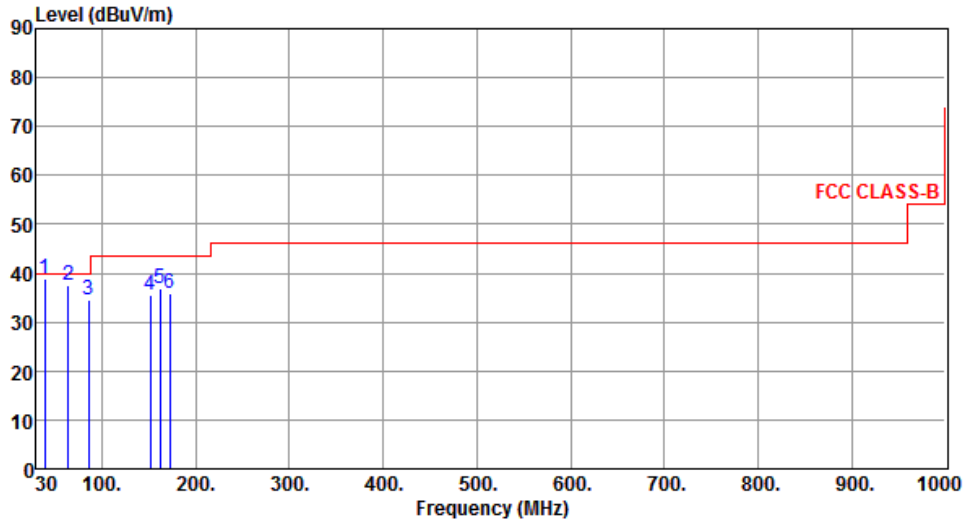

	Freq. MHz	Emission level dBuV/m	Limit dBuV/m	Margin dB	SA reading dBuV	Factor dB	Remark	ANT High cm	Turn Table deg
1	38.60	39.02	40.00	-0.98	48.36	-9.34	QP	100	66
2	63.95	37.65	40.00	-2.35	47.36	-9.71	QP	100	185
3	85.35	34.65	40.00	-5.35	49.11	-14.46	QP	100	106
4	151.31	35.62	43.50	-7.88	44.26	-8.64	Peak	---	---
5	161.92	36.87	43.50	-6.63	45.58	-8.71	Peak	---	---
6	172.61	35.74	43.50	-7.76	45.04	-9.30	Peak	---	---

Note 1: Emission Level (dBuV/m) = SA Reading (dBuV/m) + Factor* (dB)

*Factor includes antenna factor , cable loss and amplifier gain

Note 2: Margin (dB) = Emission level (dBuV/m) – Limit (dBuV/m).

Note 3: All spurious emissions below 30MHz are more than 20 dB below the limit.

3.5.5 Transmitter Radiated Unwanted Emissions (Above 1GHz) for 20 MHz

Proprietary protocol (MHz)	20	Test Freq. (MHz)	5260
Polarization	Horizontal		

The graph displays the radiated unwanted emissions. The y-axis represents the level in dBuV/m, ranging from 0 to 90. The x-axis represents the frequency in MHz, ranging from 1000 to 40000. A red line indicates the average emission level (AV), and another red line indicates the peak emission level (PK). Several peaks are identified with blue vertical lines and numbered 1 through 7.

	Freq. MHz	Emission level dBuV/m	Limit dBuV/m	Margin dB	SA reading dBuV	Factor dB	Remark	ANT High cm	Turn Table deg
1	5150.00	48.26	54.00	-5.74	40.84	7.42	Average	194	188
2	5150.00	60.26	74.00	-13.74	52.84	7.42	Peak	194	188
3	5350.00	48.73	54.00	-5.27	41.88	6.85	Average	194	188
4	5350.00	64.43	74.00	-9.57	57.58	6.85	Peak	194	188
5	10520.00	59.40	68.20	-8.80	42.84	16.56	Peak	100	105
6	15780.00	46.68	54.00	-7.32	29.94	16.74	Average	100	109
7	15780.00	59.58	74.00	-14.42	42.84	16.74	Peak	100	109

Note 1: Emission Level (dBuV/m) = SA Reading (dBuV/m) + Factor* (dB)
*Factor includes antenna factor , cable loss and amplifier gain
Note 2: Margin (dB) = Emission level (dBuV/m) – Limit (dBuV/m).

Proprietary protocol (MHz)	20	Test Freq. (MHz)	5260
Polarization	Vertical		

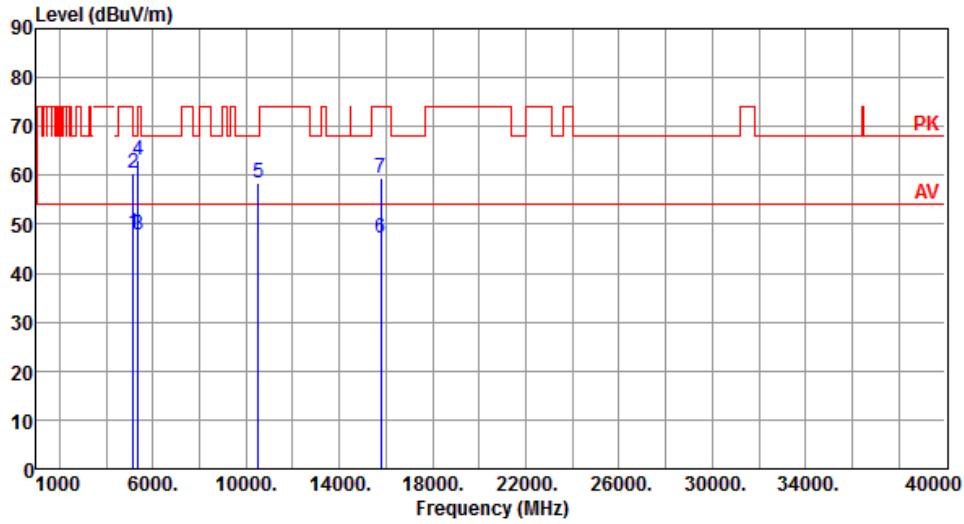

	Freq. MHz	Emission level dBuV/m	Limit dBuV/m	Margin dB	SA reading dBuV	Factor dB	Remark	ANT High cm	Turn Table deg
1	5150.00	48.15	54.00	-5.85	40.73	7.42	Average	188	175
2	5150.00	60.31	74.00	-13.69	52.89	7.42	Peak	188	175
3	5350.00	47.87	54.00	-6.13	41.02	6.85	Average	188	175
4	5350.00	63.10	74.00	-10.90	56.25	6.85	Peak	188	175
5	10520.00	58.56	68.20	-9.64	42.00	16.56	Peak	100	55
6	15780.00	47.15	54.00	-6.85	30.41	16.74	Average	100	53
7	15780.00	59.45	74.00	-14.55	42.71	16.74	Peak	100	53

Note 1: Emission Level (dBuV/m) = SA Reading (dBuV/m) + Factor* (dB)

*Factor includes antenna factor , cable loss and amplifier gain

Note 2: Margin (dB) = Emission level (dBuV/m) – Limit (dBuV/m).

Proprietary protocol (MHz)	20	Test Freq. (MHz)	5300
Polarization	Horizontal		

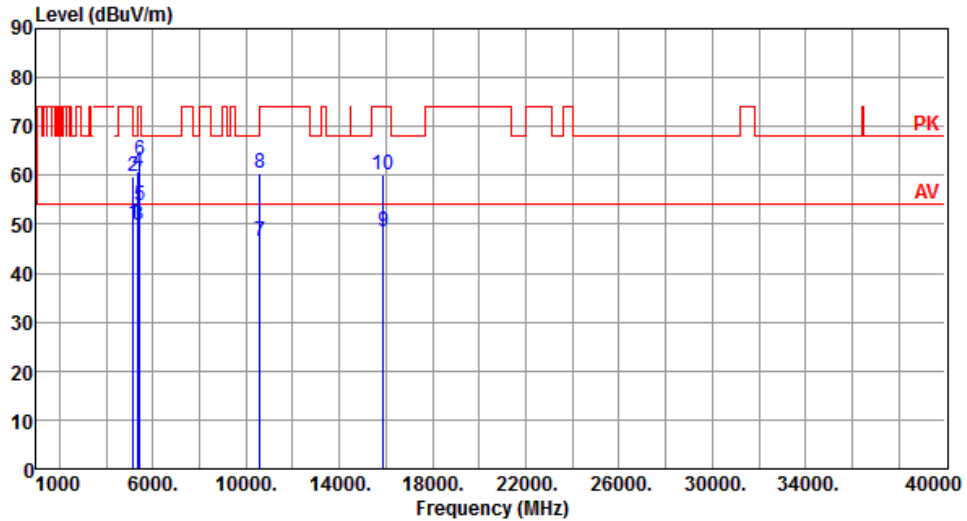

	Freq. MHz	Emission level dBuV/m	Limit dBuV/m	Margin dB	SA reading dBuV	Factor dB	Remark	ANT High cm	Turn Table deg
1	5150.00	50.12	54.00	-3.88	42.70	7.42	Average	192	185
2	5150.00	59.83	74.00	-14.17	52.41	7.42	Peak	192	185
3	5350.00	49.69	54.00	-4.31	42.84	6.85	Average	192	185
4	5350.00	60.70	74.00	-13.30	53.85	6.85	Peak	192	185
5	5424.00	53.84	54.00	-0.16	46.63	7.21	Average	148	174
6	5424.00	63.18	74.00	-10.82	55.97	7.21	Peak	148	174
7	10600.00	46.51	54.00	-7.49	29.85	16.66	Average	100	105
8	10600.00	60.52	74.00	-13.48	43.86	16.66	Peak	100	105
9	15900.00	48.53	54.00	-5.47	31.84	16.69	Average	100	101
10	15900.00	60.27	74.00	-13.73	43.58	16.69	Peak	100	101

Note 1: Emission Level (dBuV/m) = SA Reading (dBuV/m) + Factor* (dB)

*Factor includes antenna factor , cable loss and amplifier gain

Note 2: Margin (dB) = Emission level (dBuV/m) – Limit (dBuV/m).

Proprietary protocol (MHz)	20	Test Freq. (MHz)	5300
Polarization	Vertical		

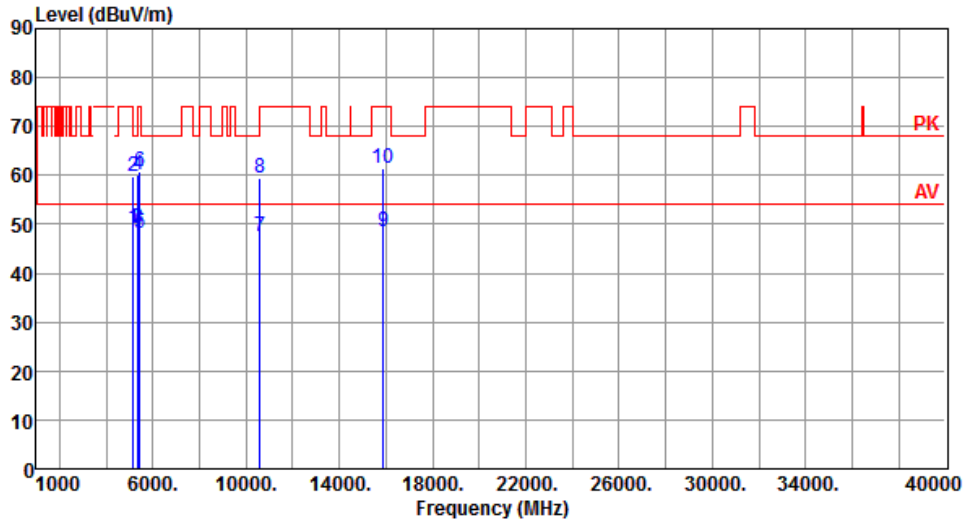

	Freq. MHz	Emission level dBuV/m	Limit dBuV/m	Margin dB	SA reading dBuV	Factor dB	Remark	ANT High cm	Turn Table deg
1	5150.00	49.29	54.00	-4.71	41.87	7.42	Average	158	175
2	5150.00	59.67	74.00	-14.33	52.25	7.42	Peak	158	175
3	5350.00	49.26	54.00	-4.74	42.41	6.85	Average	158	175
4	5350.00	60.10	74.00	-13.90	53.25	6.85	Peak	158	175
5	5424.00	48.25	54.00	-5.75	41.04	7.21	Average	100	179
6	5424.00	60.78	74.00	-13.22	53.57	7.21	Peak	100	179
7	10600.00	47.51	54.00	-6.49	30.85	16.66	Average	100	52
8	10600.00	59.52	74.00	-14.48	42.86	16.66	Peak	100	52
9	15900.00	48.64	54.00	-5.36	31.95	16.69	Average	100	59
10	15900.00	61.54	74.00	-12.46	44.85	16.69	Peak	100	59

Note 1: Emission Level (dBuV/m) = SA Reading (dBuV/m) + Factor* (dB)

*Factor includes antenna factor , cable loss and amplifier gain

Note 2: Margin (dB) = Emission level (dBuV/m) – Limit (dBuV/m).

Proprietary protocol (MHz)	20	Test Freq. (MHz)	5330
Polarization	Horizontal		

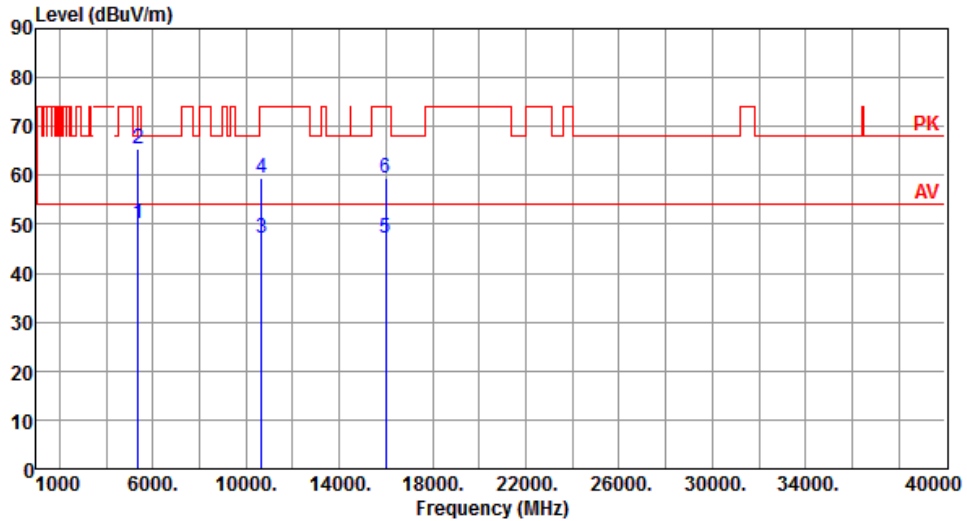

	Freq. MHz	Emission level dBuV/m	Limit dBuV/m	Margin dB	SA reading dBuV	Factor dB	Remark	ANT High cm	Turn Table deg
1	5350.00	50.27	54.00	-3.73	43.42	6.85	Average	192	190
2	5350.00	65.42	74.00	-8.58	58.57	6.85	Peak	192	190
3	10660.00	47.12	54.00	-6.88	30.51	16.61	Average	100	100
4	10660.00	59.31	74.00	-14.69	42.70	16.61	Peak	100	100
5	15990.00	47.28	54.00	-6.72	30.56	16.72	Average	100	106
6	15990.00	59.44	74.00	-14.56	42.72	16.72	Peak	100	106

Note 1: Emission Level (dBuV/m) = SA Reading (dBuV/m) + Factor* (dB)

*Factor includes antenna factor , cable loss and amplifier gain

Note 2: Margin (dB) = Emission level (dBuV/m) – Limit (dBuV/m).

Proprietary protocol (MHz)	20	Test Freq. (MHz)	5330
Polarization	Vertical		

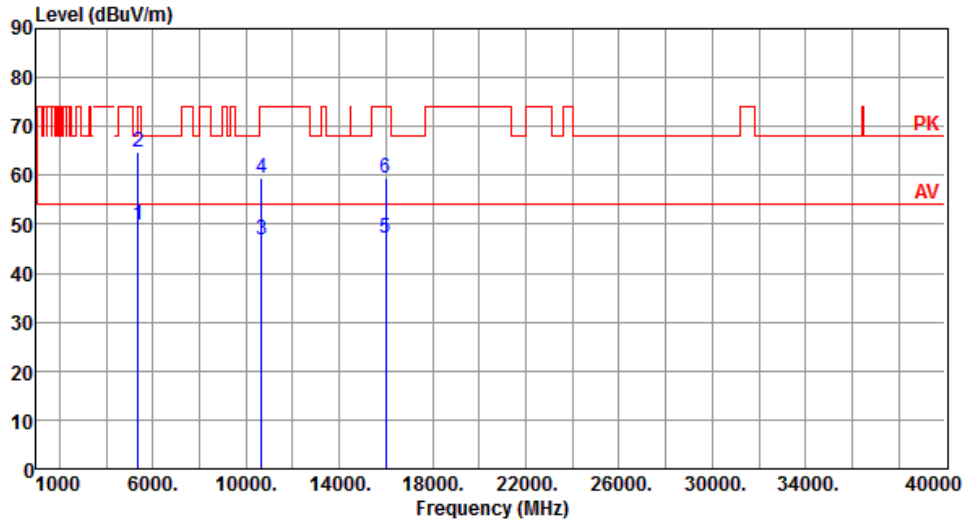

	Freq. MHz	Emission level dBuV/m	Limit dBuV/m	Margin dB	SA reading dBuV	Factor dB	Remark	ANT High cm	Turn Table deg
1	5350.00	49.69	54.00	-4.31	42.84	6.85	Average	182	184
2	5350.00	64.70	74.00	-9.30	57.85	6.85	Peak	182	184
3	10660.00	46.85	54.00	-7.15	30.24	16.61	Average	100	48
4	10660.00	59.45	74.00	-14.55	42.84	16.61	Peak	100	48
5	15990.00	47.14	54.00	-6.86	30.42	16.72	Average	100	53
6	15990.00	59.53	74.00	-14.47	42.81	16.72	Peak	100	53

Note 1: Emission Level (dBuV/m) = SA Reading (dBuV/m) + Factor* (dB)

*Factor includes antenna factor , cable loss and amplifier gain

Note 2: Margin (dB) = Emission level (dBuV/m) – Limit (dBuV/m).

Proprietary protocol (MHz)	20	Test Freq. (MHz)	5335
Polarization	Horizontal		

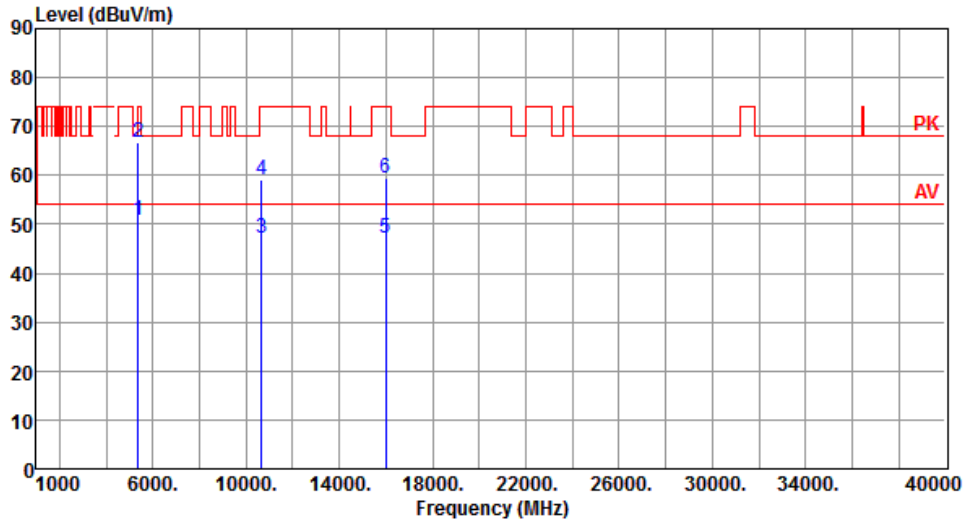

	Freq. MHz	Emission level dBUV/m	Limit dBUV/m	Margin dB	SA reading dBUV	Factor dB	Remark	ANT High cm	Turn Table deg
1	5350.00	50.81	54.00	-3.19	43.96	6.85	Average	196	189
2	5350.00	66.59	74.00	-7.41	59.74	6.85	Peak	196	189
3	10670.00	47.11	54.00	-6.89	30.50	16.61	Average	100	104
4	10670.00	59.04	74.00	-14.96	42.43	16.61	Peak	100	104
5	16005.00	47.22	54.00	-6.78	30.49	16.73	Average	100	106
6	16005.00	59.59	74.00	-14.41	42.86	16.73	Peak	100	106

Note 1: Emission Level (dBUV/m) = SA Reading (dBUV/m) + Factor* (dB)

*Factor includes antenna factor , cable loss and amplifier gain

Note 2: Margin (dB) = Emission level (dBUV/m) – Limit (dBUV/m).

Proprietary protocol (MHz)	20	Test Freq. (MHz)	5335
Polarization	Vertical		

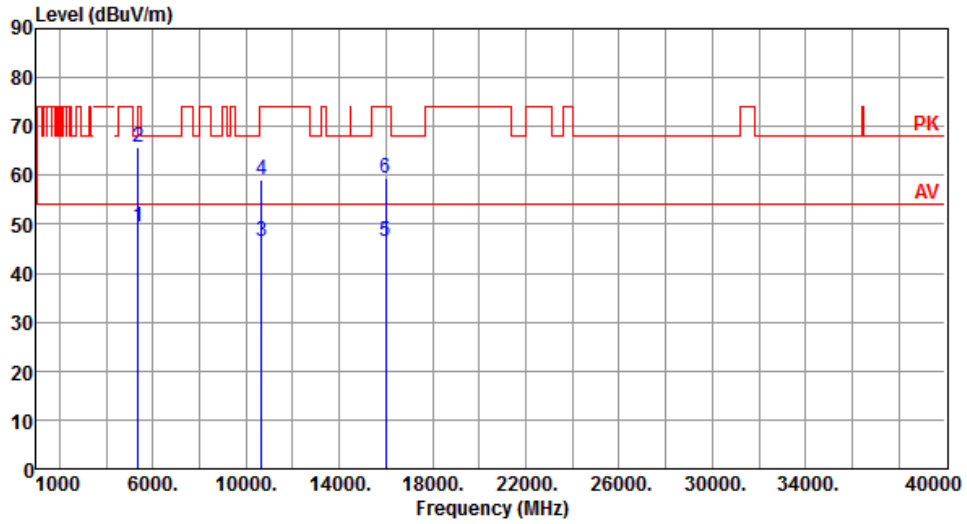

	Freq. MHz	Emission level dBuV/m	Limit dBuV/m	Margin dB	SA reading dBuV	Factor dB	Remark	ANT High cm	Turn Table deg
1	5350.00	49.35	54.00	-4.65	42.50	6.85	Average	142	178
2	5350.00	65.83	74.00	-8.17	58.98	6.85	Peak	142	178
3	10670.00	46.50	54.00	-7.50	29.89	16.61	Average	100	53
4	10670.00	59.14	74.00	-14.86	42.53	16.61	Peak	100	53
5	16005.00	46.64	54.00	-7.36	29.91	16.73	Average	100	52
6	16005.00	59.56	74.00	-14.44	42.83	16.73	Peak	100	52

Note 1: Emission Level (dBuV/m) = SA Reading (dBuV/m) + Factor* (dB)

*Factor includes antenna factor , cable loss and amplifier gain

Note 2: Margin (dB) = Emission level (dBuV/m) – Limit (dBuV/m).

Proprietary protocol (MHz)	20	Test Freq. (MHz)	5485
Polarization	Horizontal		

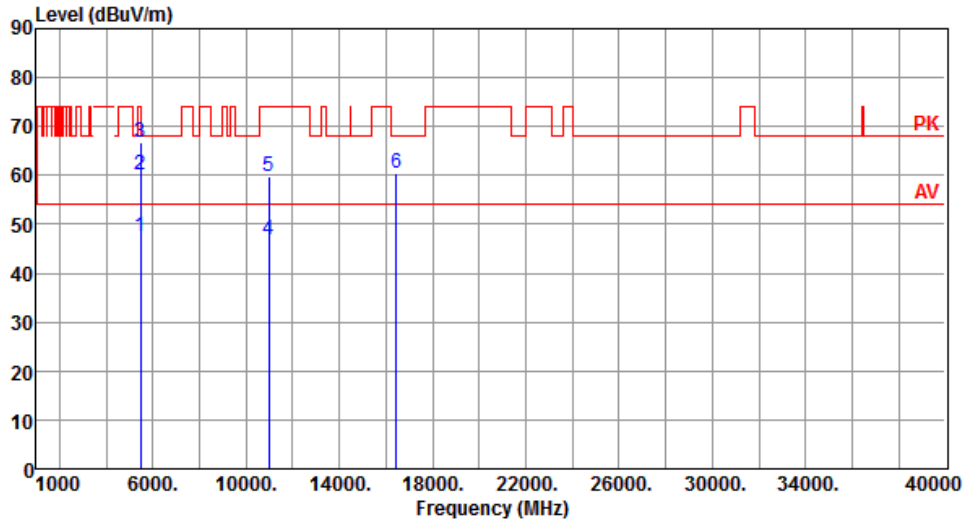

	Freq. MHz	Emission level dBuV/m	Limit dBuV/m	Margin dB	SA reading dBuV	Factor dB	Remark	ANT High cm	Turn Table deg
1	5460.00	47.36	54.00	-6.64	39.99	7.37	Average	205	186
2	5460.00	60.04	74.00	-13.96	52.67	7.37	Peak	205	186
3	5470.00	66.86	68.20	-1.34	59.44	7.42	Peak	205	186
4	10970.00	46.84	54.00	-7.16	29.94	16.90	Average	100	105
5	10970.00	59.74	74.00	-14.26	42.84	16.90	Peak	100	105
6	16455.00	60.53	68.20	-7.67	42.89	17.64	Peak	100	102

Note 1: Emission Level (dBuV/m) = SA Reading (dBuV/m) + Factor* (dB)

*Factor includes antenna factor , cable loss and amplifier gain

Note 2: Margin (dB) = Emission level (dBuV/m) – Limit (dBuV/m).

Proprietary protocol (MHz)	20	Test Freq. (MHz)	5485
Polarization	Vertical		

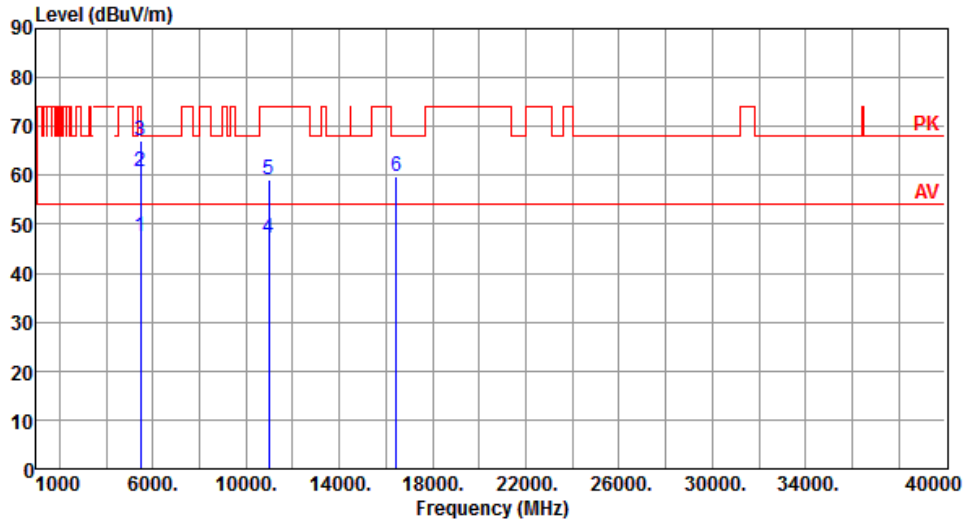

	Freq. MHz	Emission level dBuV/m	Limit dBuV/m	Margin dB	SA reading dBuV	Factor dB	Remark	ANT High cm	Turn Table deg
1	5460.00	47.63	54.00	-6.37	40.26	7.37	Average	175	188
2	5460.00	60.76	74.00	-13.24	53.39	7.37	Peak	175	188
3	5470.00	67.12	68.20	-1.08	59.70	7.42	Peak	175	188
4	10970.00	47.10	54.00	-6.90	30.20	16.90	Average	100	53
5	10970.00	59.04	74.00	-14.96	42.14	16.90	Peak	100	53
6	16455.00	59.79	68.20	-8.41	42.15	17.64	Peak	100	52

Note 1: Emission Level (dBuV/m) = SA Reading (dBuV/m) + Factor* (dB)

*Factor includes antenna factor , cable loss and amplifier gain

Note 2: Margin (dB) = Emission level (dBuV/m) – Limit (dBuV/m).

Proprietary protocol (MHz)	20	Test Freq. (MHz)	5490
Polarization	Horizontal		

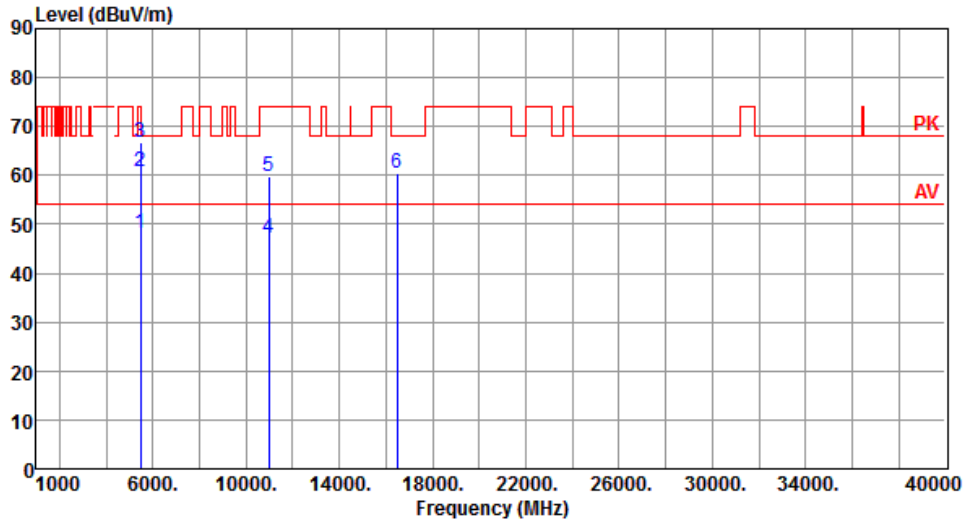

	Freq. MHz	Emission level dBuV/m	Limit dBuV/m	Margin dB	SA reading dBuV	Factor dB	Remark	ANT High cm	Turn Table deg
1	5460.00	48.21	54.00	-5.79	40.84	7.37	Average	131	172
2	5460.00	60.86	74.00	-13.14	53.49	7.37	Peak	131	172
3	5470.00	66.74	68.20	-1.46	59.32	7.42	Peak	131	172
4	10980.00	47.12	54.00	-6.88	30.20	16.92	Average	100	52
5	10980.00	59.76	74.00	-14.24	42.84	16.92	Peak	100	52
6	16470.00	60.35	68.20	-7.85	42.70	17.65	Peak	100	57

Note 1: Emission Level (dBuV/m) = SA Reading (dBuV/m) + Factor* (dB)

*Factor includes antenna factor , cable loss and amplifier gain

Note 2: Margin (dB) = Emission level (dBuV/m) – Limit (dBuV/m).

Proprietary protocol (MHz)	20	Test Freq. (MHz)	5490
Polarization	Vertical		

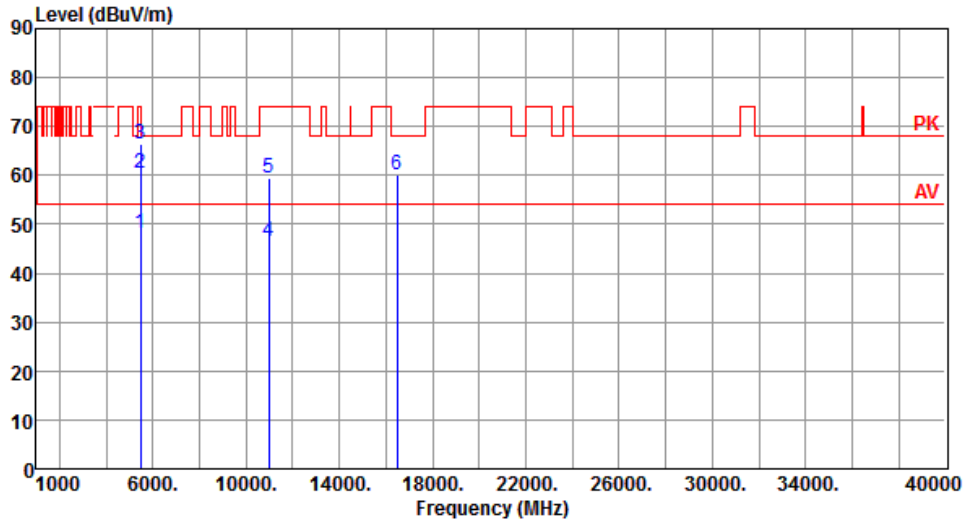

	Freq. MHz	Emission level dBuV/m	Limit dBuV/m	Margin dB	SA reading dBuV	Factor dB	Remark	ANT High cm	Turn Table deg
1	5460.00	48.19	54.00	-5.81	40.82	7.37	Average	135	176
2	5460.00	60.58	74.00	-13.42	53.21	7.37	Peak	135	176
3	5470.00	66.27	68.20	-1.93	58.85	7.42	Peak	135	176
4	10980.00	46.52	54.00	-7.48	29.60	16.92	Average	100	42
5	10980.00	59.32	74.00	-14.68	42.40	16.92	Peak	100	42
6	16470.00	60.05	68.20	-8.15	42.40	17.65	Peak	100	42

Note 1: Emission Level (dBuV/m) = SA Reading (dBuV/m) + Factor* (dB)

*Factor includes antenna factor , cable loss and amplifier gain

Note 2: Margin (dB) = Emission level (dBuV/m) – Limit (dBuV/m).

Proprietary protocol (MHz)	20	Test Freq. (MHz)	5600
Polarization	Horizontal		

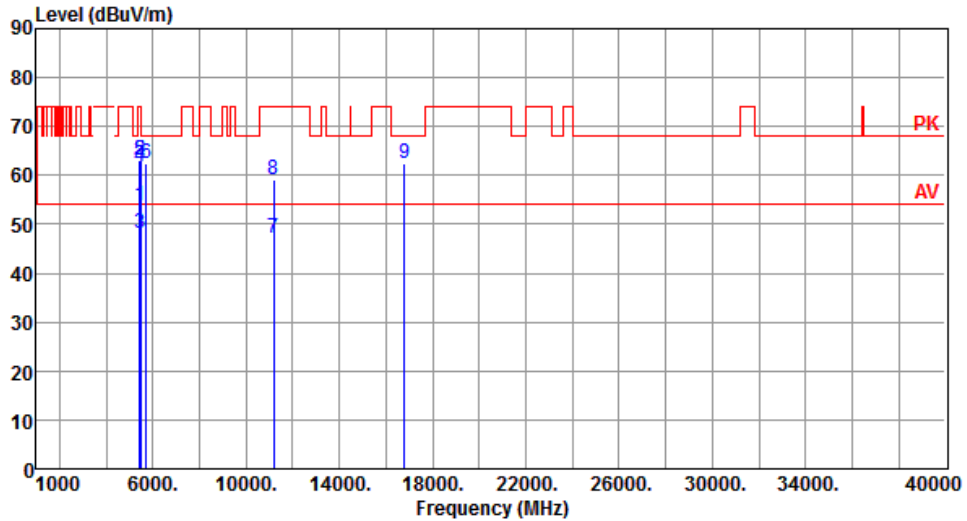

	Freq. MHz	Emission level dBuV/m	Limit dBuV/m	Margin dB	SA reading dBuV	Factor dB	Remark	ANT High cm	Turn Table deg
1	5424.00	53.72	54.00	-0.28	46.51	7.21	Average	157	176
2	5424.00	63.06	74.00	-10.94	55.85	7.21	Peak	157	176
3	5460.00	48.23	54.00	-5.77	40.86	7.37	Average	152	177
4	5460.00	61.61	74.00	-12.39	54.24	7.37	Peak	152	177
5	5470.00	63.00	68.20	-5.20	55.58	7.42	Peak	152	177
6	5725.00	62.41	68.20	-5.79	54.65	7.76	Peak	152	177
7	11200.00	47.28	54.00	-6.72	30.75	16.53	Average	100	102
8	11200.00	59.21	74.00	-14.79	42.68	16.53	Peak	100	102
9	16800.00	62.28	68.20	-5.92	43.74	18.54	Peak	100	103

Note 1: Emission Level (dBuV/m) = SA Reading (dBuV/m) + Factor* (dB)

*Factor includes antenna factor , cable loss and amplifier gain

Note 2: Margin (dB) = Emission level (dBuV/m) – Limit (dBuV/m).

Proprietary protocol (MHz)	20	Test Freq. (MHz)	5600
Polarization	Vertical		

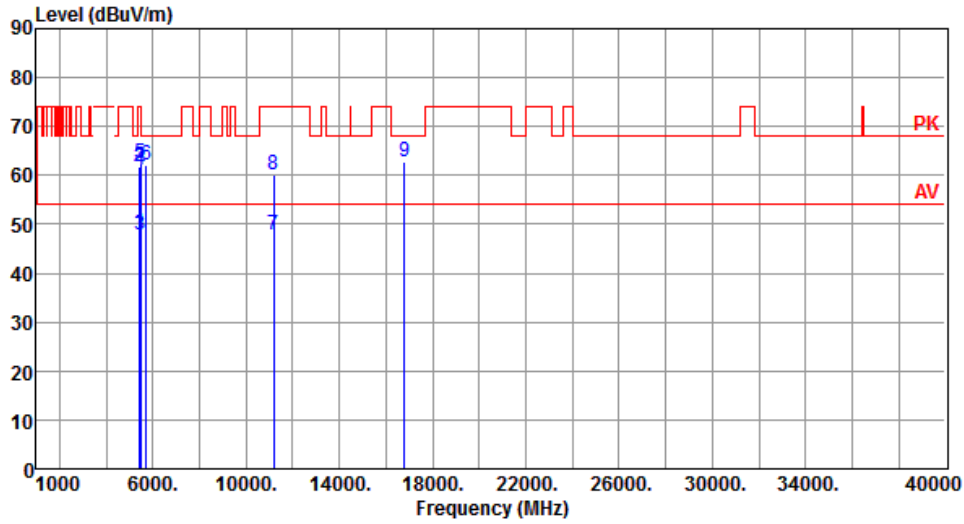

	Freq. MHz	Emission level dBuV/m	Limit dBuV/m	Margin dB	SA reading dBuV	Factor dB	Remark	ANT High cm	Turn Table deg
1	5424.00	48.23	54.00	-5.77	41.02	7.21	Average	100	176
2	5424.00	61.79	74.00	-12.21	54.58	7.21	Peak	100	176
3	5460.00	47.91	54.00	-6.09	40.54	7.37	Average	135	175
4	5460.00	60.95	74.00	-13.05	53.58	7.37	Peak	135	175
5	5470.00	62.31	68.20	-5.89	54.89	7.42	Peak	135	175
6	5725.00	62.08	68.20	-6.12	54.32	7.76	Peak	135	175
7	11200.00	47.88	54.00	-6.12	31.35	16.53	Average	100	56
8	11200.00	60.12	74.00	-13.88	43.59	16.53	Peak	100	56
9	16800.00	62.86	68.20	-5.34	44.32	18.54	Peak	100	62

Note 1: Emission Level (dBuV/m) = SA Reading (dBuV/m) + Factor* (dB)

*Factor includes antenna factor , cable loss and amplifier gain

Note 2: Margin (dB) = Emission level (dBuV/m) – Limit (dBuV/m).

Proprietary protocol (MHz)	20	Test Freq. (MHz)	5705
Polarization	Horizontal		

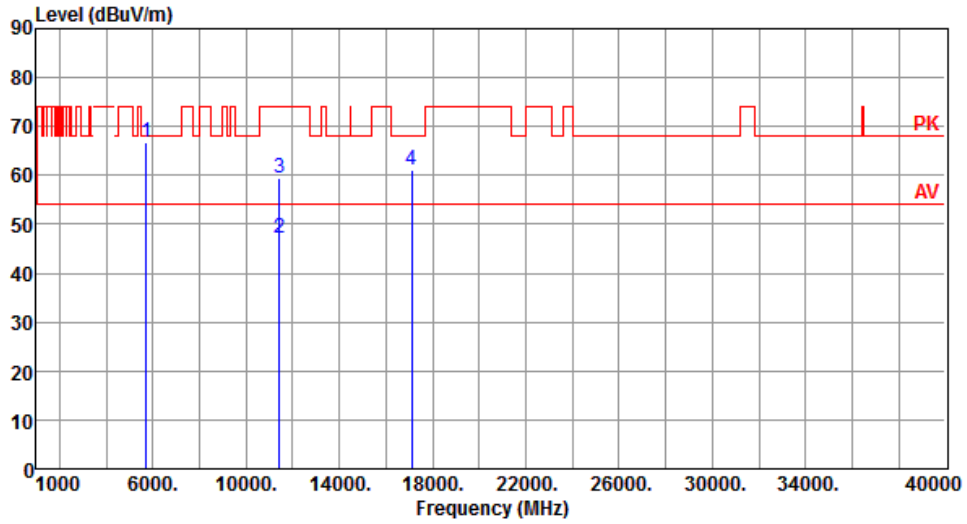

	Freq. MHz	Emission level dBuV/m	Limit dBuV/m	Margin dB	SA reading dBuV	Factor dB	Remark	ANT High cm	Turn Table deg
1	5725.00	66.71	68.20	-1.49	58.95	7.76	Peak	178	177
2	11410.00	47.28	54.00	-6.72	30.54	16.74	Average	100	109
3	11410.00	59.54	74.00	-14.46	42.80	16.74	Peak	100	109
4	17115.00	61.23	68.20	-6.97	42.71	18.52	Peak	100	105

Note 1: Emission Level (dBuV/m) = SA Reading (dBuV/m) + Factor* (dB)

*Factor includes antenna factor , cable loss and amplifier gain

Note 2: Margin (dB) = Emission level (dBuV/m) – Limit (dBuV/m).

Proprietary protocol (MHz)	20	Test Freq. (MHz)	5705
Polarization	Vertical		

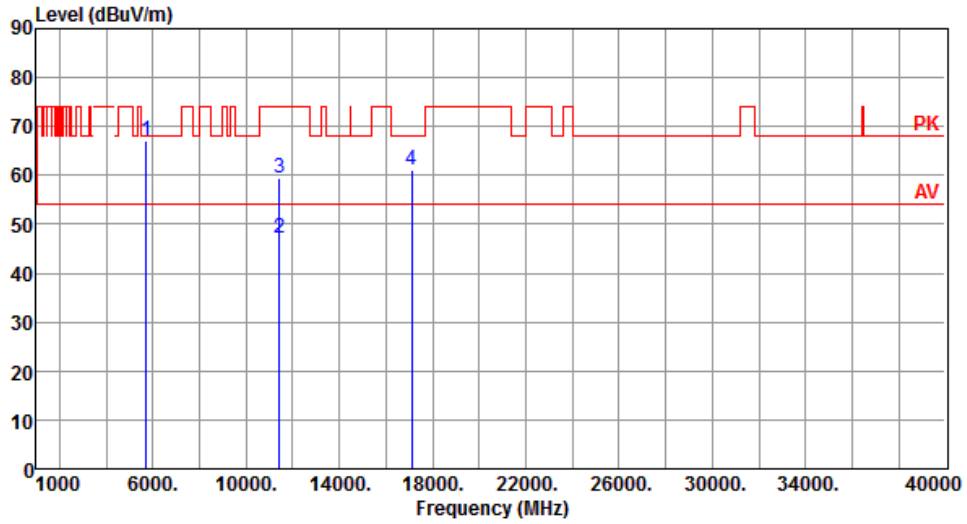

	Freq. MHz	Emission level dBuV/m	Limit dBuV/m	Margin dB	SA reading dBuV	Factor dB	Remark	ANT High cm	Turn Table deg
1	5725.00	66.98	68.20	-1.22	59.22	7.76	Peak	156	178
2	11410.00	47.14	54.00	-6.86	30.40	16.74	Average	100	56
3	11410.00	59.44	74.00	-14.56	42.70	16.74	Peak	100	56
4	17115.00	61.12	68.20	-7.08	42.60	18.52	Peak	100	56

Note 1: Emission Level (dBuV/m) = SA Reading (dBuV/m) + Factor* (dB)

*Factor includes antenna factor , cable loss and amplifier gain

Note 2: Margin (dB) = Emission level (dBuV/m) – Limit (dBuV/m).

Proprietary protocol (MHz)	20	Test Freq. (MHz)	5710
Polarization	Horizontal		

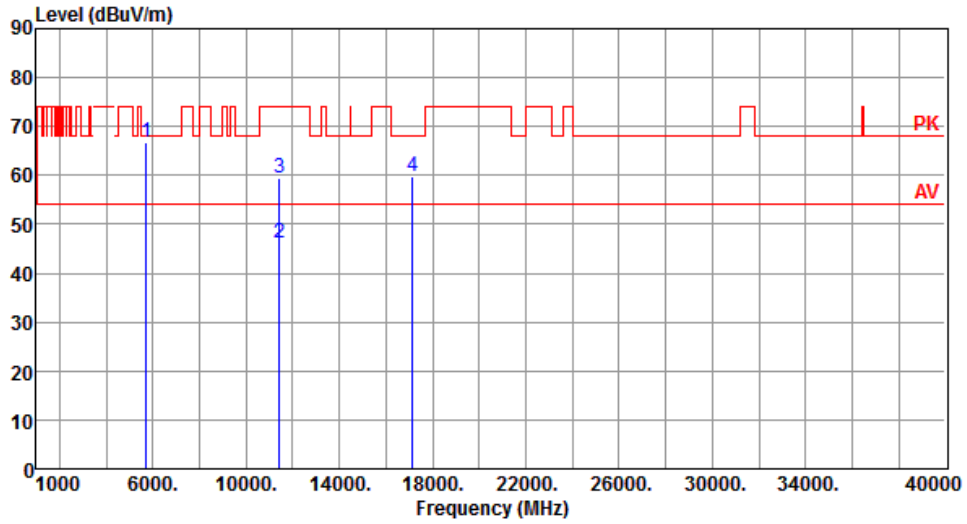

	Freq. MHz	Emission level dBuV/m	Limit dBuV/m	Margin dB	SA reading dBuV	Factor dB	Remark	ANT High cm	Turn Table deg
1	5725.00	66.76	68.20	-1.44	59.00	7.76	Peak	170	176
2	11420.00	46.15	54.00	-7.85	29.40	16.75	Average	100	106
3	11420.00	59.55	74.00	-14.45	42.80	16.75	Peak	100	106
4	17130.00	59.61	68.20	-8.59	41.10	18.51	Peak	100	105

Note 1: Emission Level (dBuV/m) = SA Reading (dBuV/m) + Factor* (dB)

*Factor includes antenna factor , cable loss and amplifier gain

Note 2: Margin (dB) = Emission level (dBuV/m) – Limit (dBuV/m).

Proprietary protocol (MHz)	20	Test Freq. (MHz)	5710
Polarization	Vertical		

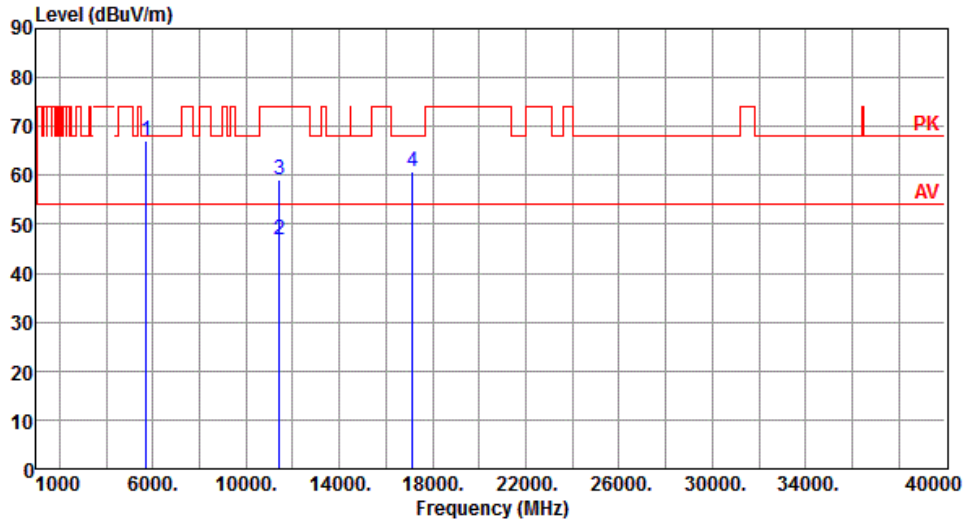

	Freq. MHz	Emission level dBuV/m	Limit dBuV/m	Margin dB	SA reading dBuV	Factor dB	Remark	ANT High cm	Turn Table deg
1	5725.00	67.19	68.20	-1.01	59.43	7.76	Peak	150	178
2	11420.00	46.95	54.00	-7.05	30.20	16.75	Average	100	52
3	11420.00	59.15	74.00	-14.85	42.40	16.75	Peak	100	52
4	17130.00	60.65	68.20	-7.55	42.14	18.51	Peak	100	52

Note 1: Emission Level (dBuV/m) = SA Reading (dBuV/m) + Factor* (dB)

*Factor includes antenna factor , cable loss and amplifier gain

Note 2: Margin (dB) = Emission level (dBuV/m) – Limit (dBuV/m).

3.5.6 Transmitter Radiated Unwanted Emissions (Above 1GHz) for 40 MHz

Proprietary protocol (MHz)	40	Test Freq. (MHz)	5270
Polarization	Horizontal		

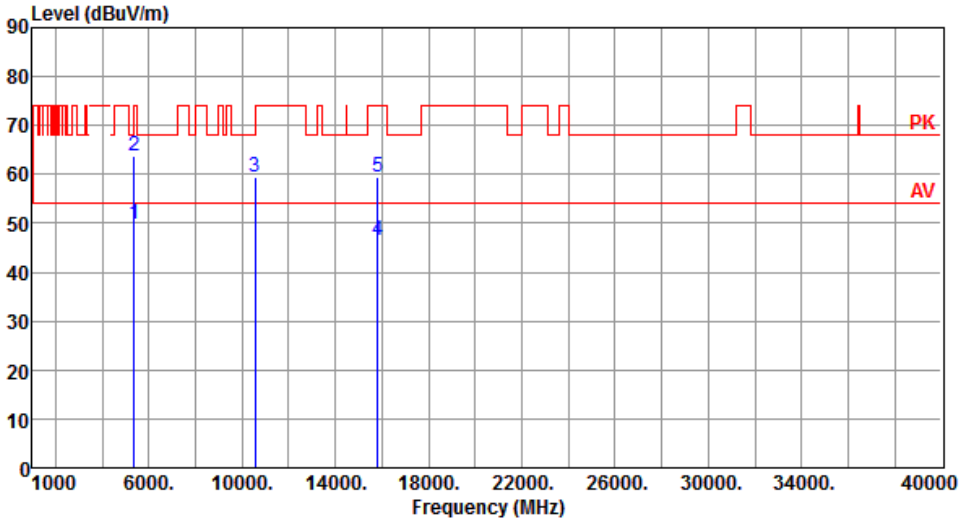

The graph plots Level (dBuV/m) on the y-axis (0 to 90) against Frequency (MHz) on the x-axis (1000 to 40000). A red line shows the emission level, which is mostly flat around 70 dBuV/m with several sharp peaks. A horizontal red line at approximately 55 dBuV/m is labeled 'AV' (Average). A horizontal red line at approximately 74 dBuV/m is labeled 'PK' (Peak). Five specific peaks are marked with blue vertical lines and numbered 1 through 5. Peak 1 is at 5350 MHz, peak 2 is at 5350 MHz, peak 3 is at 10540 MHz, peak 4 is at 15810 MHz, and peak 5 is at 15810 MHz.

	Freq. MHz	Emission level dBuV/m	Limit dBuV/m	Margin dB	SA reading dBuV	Factor dB	Remark	ANT High cm	Turn Table deg
1	5350.00	49.87	54.00	-4.13	43.02	6.85	Average	182	188
2	5350.00	63.83	74.00	-10.17	56.98	6.85	Peak	182	188
3	10540.00	59.43	68.20	-8.77	42.84	16.59	Peak	100	108
4	15810.00	46.59	54.00	-7.41	29.94	16.65	Average	100	108
5	15810.00	59.58	74.00	-14.42	42.93	16.65	Peak	100	108

Note 1: Emission Level (dBuV/m) = SA Reading (dBuV/m) + Factor* (dB)
*Factor includes antenna factor , cable loss and amplifier gain
Note 2: Margin (dB) = Emission level (dBuV/m) – Limit (dBuV/m).

Proprietary protocol (MHz)	40	Test Freq. (MHz)	5270
Polarization	Vertical		

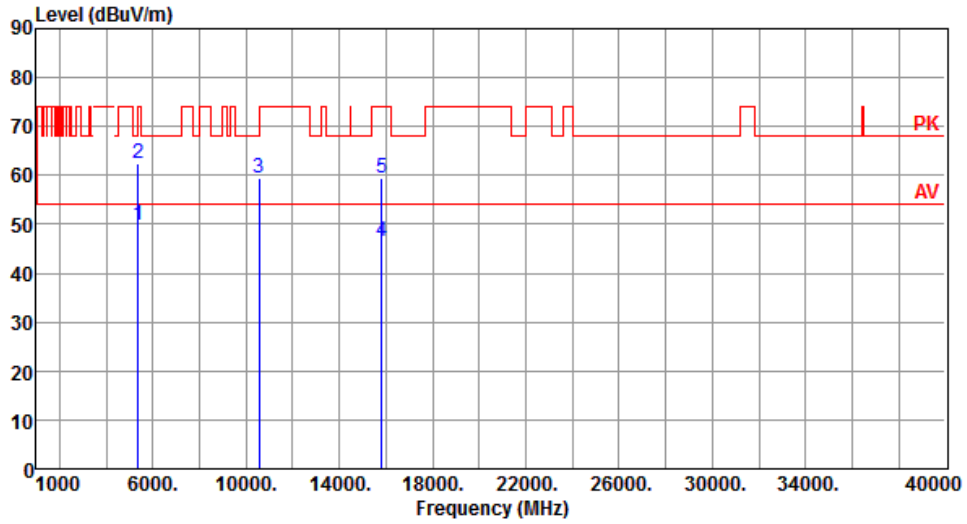

	Freq. MHz	Emission level dBuV/m	Limit dBuV/m	Margin dB	SA reading dBuV	Factor dB	Remark	ANT High cm	Turn Table deg
1	5350.00	49.69	54.00	-4.31	42.84	6.85	Average	177	181
2	5350.00	62.43	74.00	-11.57	55.58	6.85	Peak	177	181
3	10540.00	59.43	68.20	-8.77	42.84	16.59	Peak	100	52
4	15810.00	46.45	54.00	-7.55	29.80	16.65	Average	100	53
5	15810.00	59.35	74.00	-14.65	42.70	16.65	Peak	100	53

Note 1: Emission Level (dBuV/m) = SA Reading (dBuV/m) + Factor* (dB)

*Factor includes antenna factor , cable loss and amplifier gain

Note 2: Margin (dB) = Emission level (dBuV/m) – Limit (dBuV/m).

Proprietary protocol (MHz)	40	Test Freq. (MHz)	5300
Polarization	Horizontal		

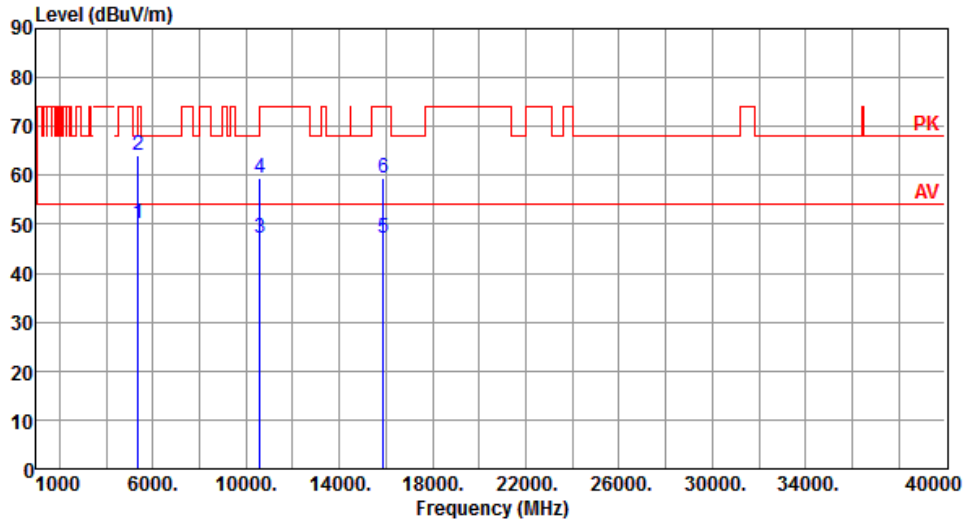

	Freq. MHz	Emission level dBUV/m	Limit dBUV/m	Margin dB	SA reading dBUV	Factor dB	Remark	ANT High cm	Turn Table deg
1	5350.00	50.05	54.00	-3.95	43.20	6.85	Average	177	185
2	5350.00	63.95	74.00	-10.05	57.10	6.85	Peak	177	185
3	10600.00	47.16	54.00	-6.84	30.50	16.66	Average	100	109
4	10600.00	59.43	74.00	-14.57	42.77	16.66	Peak	100	109
5	15900.00	47.29	54.00	-6.71	30.60	16.69	Average	100	105
6	15900.00	59.42	74.00	-14.58	42.73	16.69	Peak	100	105

Note 1: Emission Level (dBUV/m) = SA Reading (dBUV/m) + Factor* (dB)

*Factor includes antenna factor , cable loss and amplifier gain

Note 2: Margin (dB) = Emission level (dBUV/m) – Limit (dBUV/m).

Proprietary protocol (MHz)	40	Test Freq. (MHz)	5300
Polarization	Vertical		

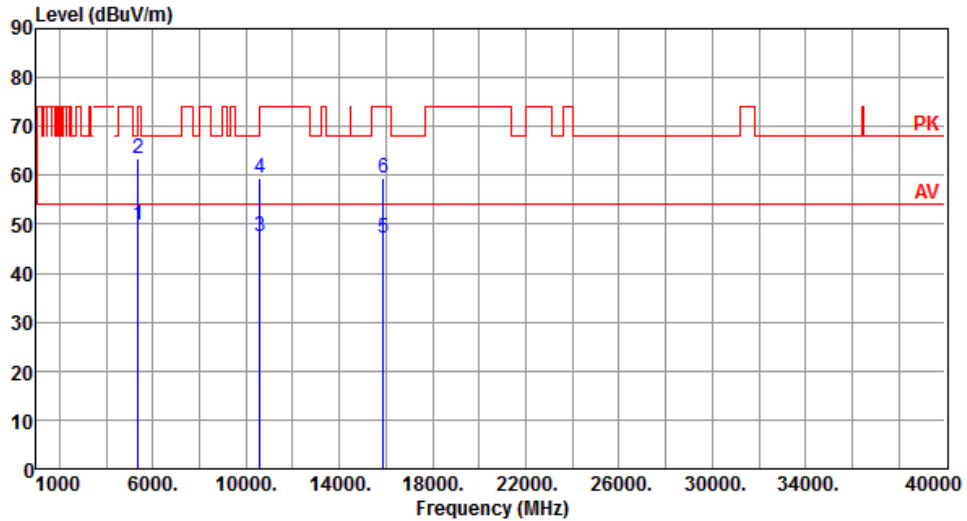

	Freq. MHz	Emission level dBuV/m	Limit dBuV/m	Margin dB	SA reading dBuV	Factor dB	Remark	ANT High cm	Turn Table deg
1	5350.00	49.65	54.00	-4.35	42.80	6.85	Average	181	175
2	5350.00	63.39	74.00	-10.61	56.54	6.85	Peak	181	175
3	10600.00	47.46	54.00	-6.54	30.80	16.66	Average	100	53
4	10600.00	59.50	74.00	-14.50	42.84	16.66	Peak	100	53
5	15900.00	47.13	54.00	-6.87	30.44	16.69	Average	100	52
6	15900.00	59.53	74.00	-14.47	42.84	16.69	Peak	100	52

Note 1: Emission Level (dBuV/m) = SA Reading (dBuV/m) + Factor* (dB)

*Factor includes antenna factor , cable loss and amplifier gain

Note 2: Margin (dB) = Emission level (dBuV/m) – Limit (dBuV/m).

Proprietary protocol (MHz)	40	Test Freq. (MHz)	5320
Polarization	Horizontal		

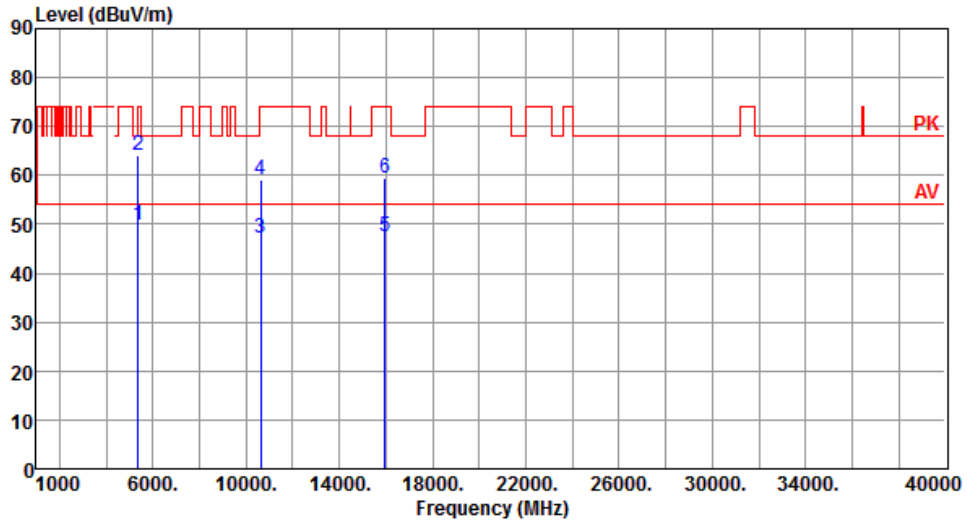

	Freq. MHz	Emission level dBuV/m	Limit dBuV/m	Margin dB	SA reading dBuV	Factor dB	Remark	ANT High cm	Turn Table deg
1	5350.00	49.89	54.00	-4.11	43.04	6.85	Average	170	191
2	5350.00	63.94	74.00	-10.06	57.09	6.85	Peak	170	191
3	10640.00	47.18	54.00	-6.82	30.55	16.63	Average	100	103
4	10640.00	59.23	74.00	-14.77	42.60	16.63	Peak	100	103
5	15960.00	47.41	54.00	-6.59	30.70	16.71	Average	100	105
6	15960.00	59.51	74.00	-14.49	42.80	16.71	Peak	100	105

Note 1: Emission Level (dBuV/m) = SA Reading (dBuV/m) + Factor* (dB)

*Factor includes antenna factor , cable loss and amplifier gain

Note 2: Margin (dB) = Emission level (dBuV/m) – Limit (dBuV/m).

Proprietary protocol (MHz)	40	Test Freq. (MHz)	5320
Polarization	Vertical		

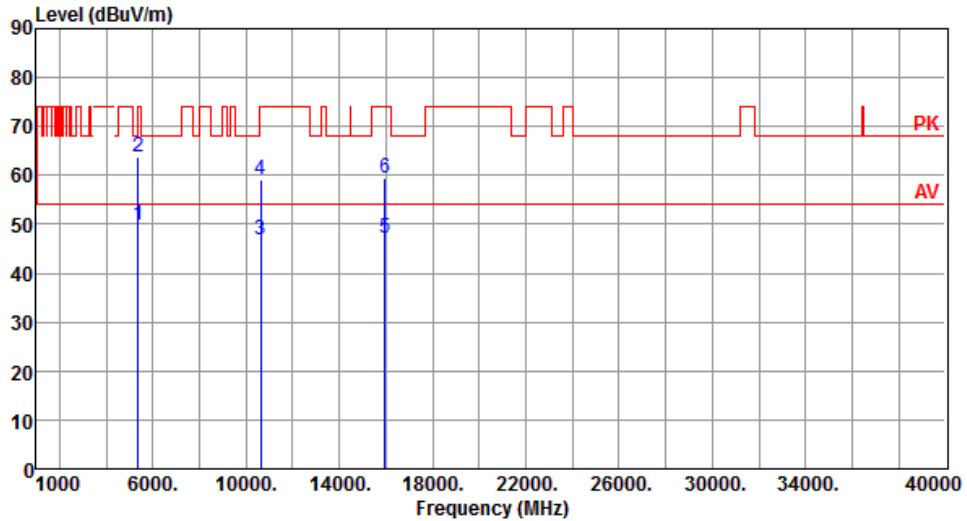

	Freq. MHz	Emission level dBuV/m	Limit dBuV/m	Margin dB	SA reading dBuV	Factor dB	Remark	ANT High cm	Turn Table deg
1	5350.00	49.70	54.00	-4.30	42.85	6.85	Average	135	175
2	5350.00	63.74	74.00	-10.26	56.89	6.85	Peak	135	175
3	10640.00	46.88	54.00	-7.12	30.25	16.63	Average	100	51
4	10640.00	59.03	74.00	-14.97	42.40	16.63	Peak	100	51
5	15960.00	47.23	54.00	-6.77	30.52	16.71	Average	100	53
6	15960.00	59.42	74.00	-14.58	42.71	16.71	Peak	100	53

Note 1: Emission Level (dBuV/m) = SA Reading (dBuV/m) + Factor* (dB)

*Factor includes antenna factor , cable loss and amplifier gain

Note 2: Margin (dB) = Emission level (dBuV/m) – Limit (dBuV/m).

Proprietary protocol (MHz)	40	Test Freq. (MHz)	5325
Polarization	Horizontal		

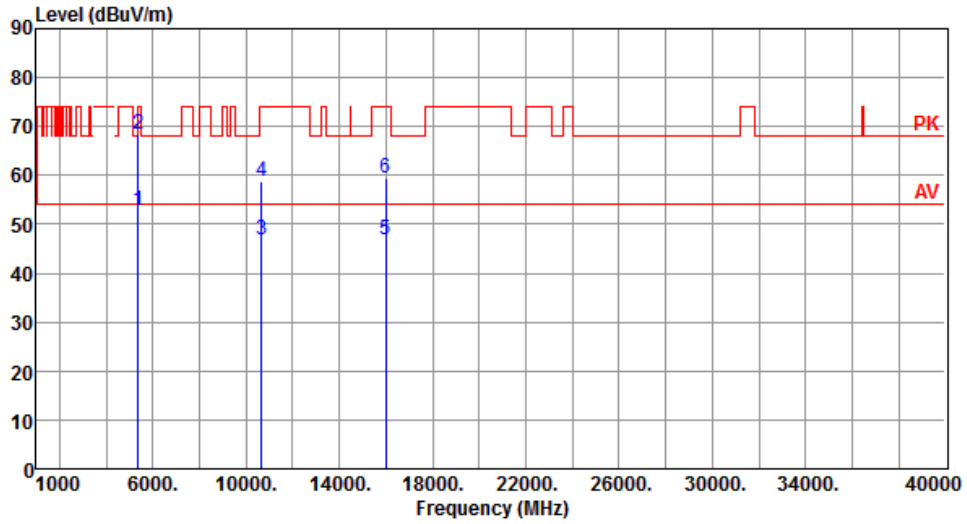

	Freq. MHz	Emission level dBuV/m	Limit dBuV/m	Margin dB	SA reading dBuV	Factor dB	Remark	ANT High cm	Turn Table deg
1	5350.00	52.72	54.00	-1.28	45.87	6.85	Average	126	174
2	5350.00	68.40	74.00	-5.60	61.55	6.85	Peak	126	174
3	10650.00	46.87	54.00	-7.13	30.25	16.62	Average	100	103
4	10650.00	58.90	74.00	-15.10	42.28	16.62	Peak	100	103
5	15975.00	46.97	54.00	-7.03	30.25	16.72	Average	100	105
6	15975.00	59.43	74.00	-14.57	42.71	16.72	Peak	100	105

Note 1: Emission Level (dBuV/m) = SA Reading (dBuV/m) + Factor* (dB)

*Factor includes antenna factor , cable loss and amplifier gain

Note 2: Margin (dB) = Emission level (dBuV/m) – Limit (dBuV/m).

Proprietary protocol (MHz)	40	Test Freq. (MHz)	5325
Polarization	Vertical		

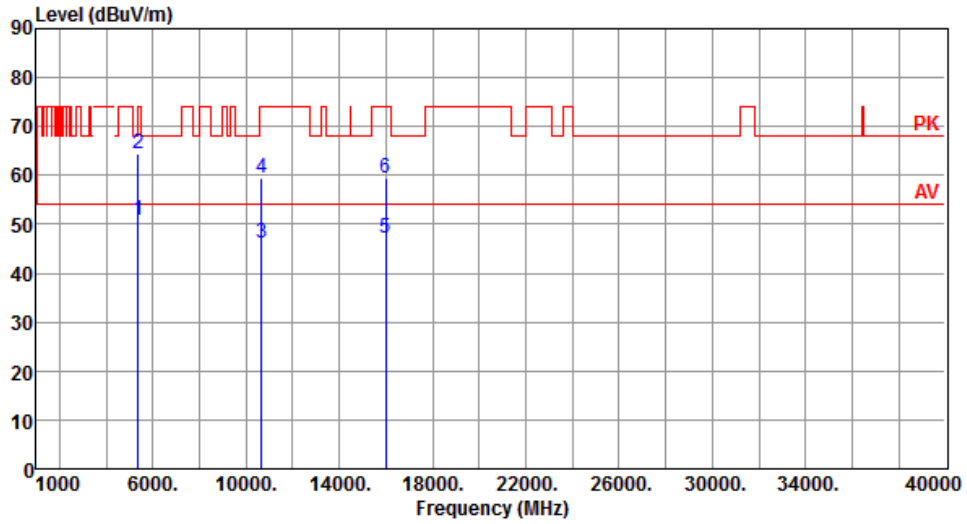

	Freq. MHz	Emission level dBuV/m	Limit dBuV/m	Margin dB	SA reading dBuV	Factor dB	Remark	ANT High cm	Turn Table deg
1	5350.00	50.81	54.00	-3.19	43.96	6.85	Average	133	176
2	5350.00	64.56	74.00	-9.44	57.71	6.85	Peak	133	176
3	10650.00	46.26	54.00	-7.74	29.64	16.62	Average	100	55
4	10650.00	59.46	74.00	-14.54	42.84	16.62	Peak	100	55
5	15975.00	47.24	54.00	-6.76	30.52	16.72	Average	100	52
6	15975.00	59.52	74.00	-14.48	42.80	16.72	Peak	100	52

Note 1: Emission Level (dBuV/m) = SA Reading (dBuV/m) + Factor* (dB)

*Factor includes antenna factor , cable loss and amplifier gain

Note 2: Margin (dB) = Emission level (dBuV/m) – Limit (dBuV/m).

Proprietary protocol (MHz)	40	Test Freq. (MHz)	5495
Polarization	Horizontal		

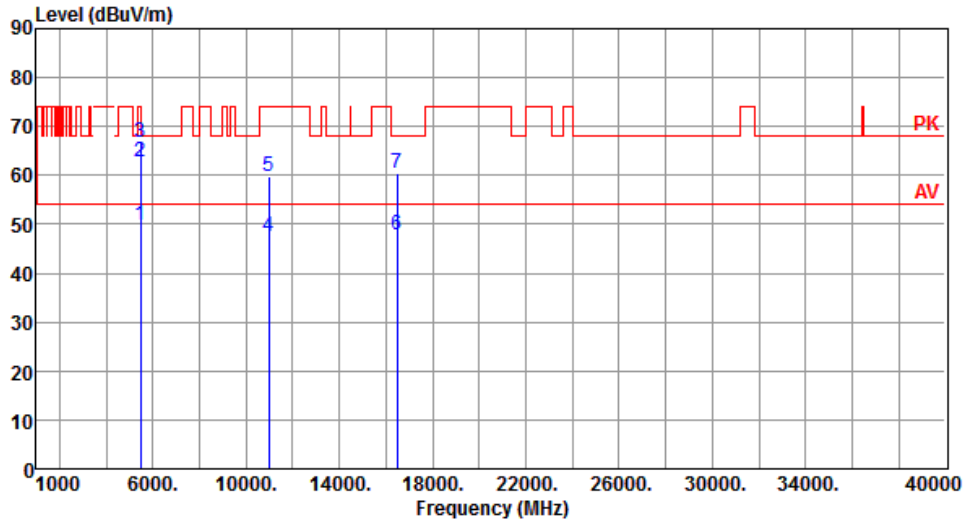

	Freq. MHz	Emission level dBuV/m	Limit dBuV/m	Margin dB	SA reading dBuV	Factor dB	Remark	ANT High cm	Turn Table deg
1	5460.00	49.77	54.00	-4.23	42.40	7.37	Average	166	184
2	5460.00	62.81	74.00	-11.19	55.44	7.37	Peak	166	184
3	5470.00	66.72	68.20	-1.48	59.30	7.42	Peak	166	184
4	10990.00	47.45	54.00	-6.55	30.53	16.92	Average	100	106
5	10990.00	59.64	74.00	-14.36	42.72	16.92	Peak	100	106
6	16485.00	47.84	54.00	-6.16	30.20	17.64	Average	100	106
7	16485.00	60.48	68.20	-7.72	42.84	17.64	Peak	100	106

Note 1: Emission Level (dBuV/m) = SA Reading (dBuV/m) + Factor* (dB)

*Factor includes antenna factor , cable loss and amplifier gain

Note 2: Margin (dB) = Emission level (dBuV/m) – Limit (dBuV/m).

Proprietary protocol (MHz)	40	Test Freq. (MHz)	5495
Polarization	Vertical		

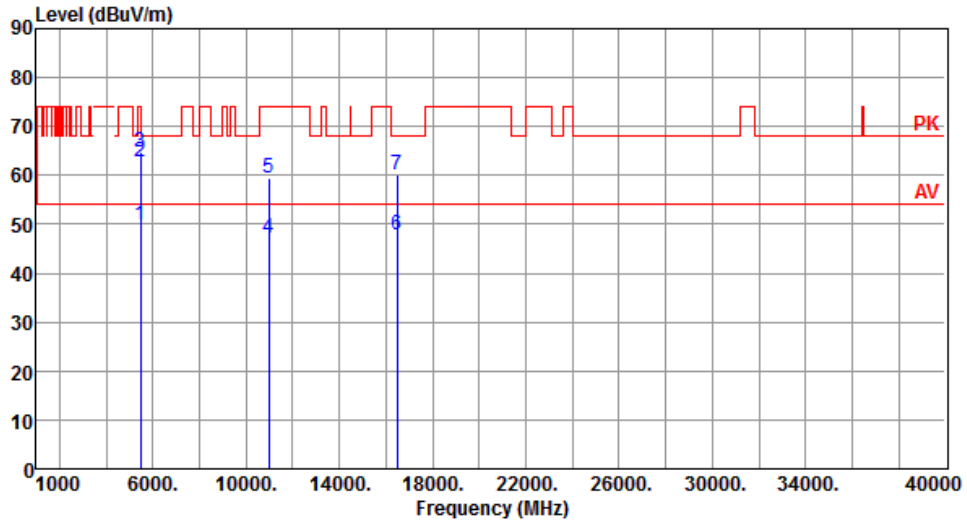

	Freq. MHz	Emission level dBuV/m	Limit dBuV/m	Margin dB	SA reading dBuV	Factor dB	Remark	ANT High cm	Turn Table deg
1	5460.00	49.69	54.00	-4.31	42.32	7.37	Average	177	188
2	5460.00	62.62	74.00	-11.38	55.25	7.37	Peak	177	188
3	5470.00	64.85	68.20	-3.35	57.43	7.42	Peak	177	188
4	10990.00	47.24	54.00	-6.76	30.32	16.92	Average	100	52
5	10990.00	59.37	74.00	-14.63	42.45	16.92	Peak	100	52
6	16485.00	47.96	54.00	-6.04	30.32	17.64	Average	100	53
7	16485.00	60.04	68.20	-8.16	42.40	17.64	Peak	100	53

Note 1: Emission Level (dBuV/m) = SA Reading (dBuV/m) + Factor* (dB)

*Factor includes antenna factor , cable loss and amplifier gain

Note 2: Margin (dB) = Emission level (dBuV/m) – Limit (dBuV/m).

Proprietary protocol (MHz)	40	Test Freq. (MHz)	5500
Polarization	Horizontal		

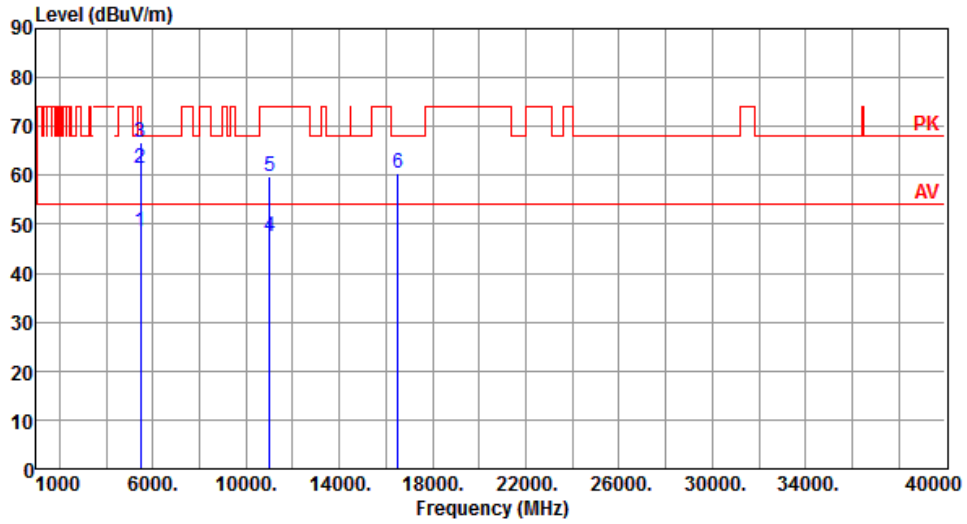

	Freq. MHz	Emission level dBuV/m	Limit dBuV/m	Margin dB	SA reading dBuV	Factor dB	Remark	ANT High cm	Turn Table deg
1	5460.00	48.54	54.00	-5.46	41.17	7.37	Average	183	182
2	5460.00	61.60	74.00	-12.40	54.23	7.37	Peak	183	182
3	5470.00	66.74	68.20	-1.46	59.32	7.42	Peak	183	182
4	11000.00	47.46	54.00	-6.54	30.52	16.94	Average	100	104
5	11000.00	59.78	74.00	-14.22	42.84	16.94	Peak	100	104
6	16500.00	60.34	68.20	-7.86	42.70	17.64	Peak	100	106

Note 1: Emission Level (dBuV/m) = SA Reading (dBuV/m) + Factor* (dB)

*Factor includes antenna factor , cable loss and amplifier gain

Note 2: Margin (dB) = Emission level (dBuV/m) – Limit (dBuV/m).

Proprietary protocol (MHz)	40	Test Freq. (MHz)	5500
Polarization	Vertical		

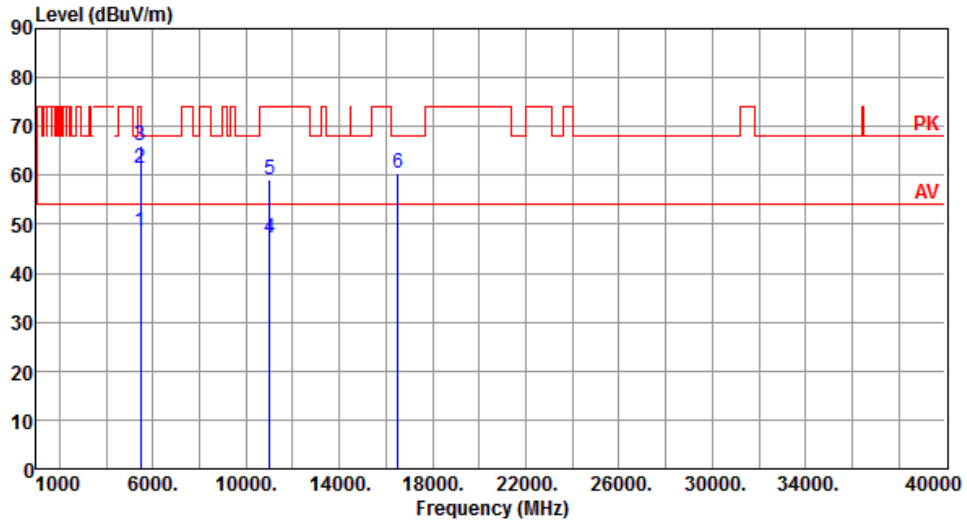

	Freq. MHz	Emission level dBuV/m	Limit dBuV/m	Margin dB	SA reading dBuV	Factor dB	Remark	ANT High cm	Turn Table deg
1	5460.00	48.57	54.00	-5.43	41.20	7.37	Average	152	175
2	5460.00	61.49	74.00	-12.51	54.12	7.37	Peak	152	175
3	5470.00	66.00	68.20	-2.20	58.58	7.42	Peak	152	175
4	11000.00	47.19	54.00	-6.81	30.25	16.94	Average	100	53
5	11000.00	59.08	74.00	-14.92	42.14	16.94	Peak	100	53
6	16500.00	60.48	68.20	-7.72	42.84	17.64	Peak	100	53

Note 1: Emission Level (dBuV/m) = SA Reading (dBuV/m) + Factor* (dB)

*Factor includes antenna factor , cable loss and amplifier gain

Note 2: Margin (dB) = Emission level (dBuV/m) – Limit (dBuV/m).

Proprietary protocol (MHz)	40	Test Freq. (MHz)	5600
Polarization	Horizontal		

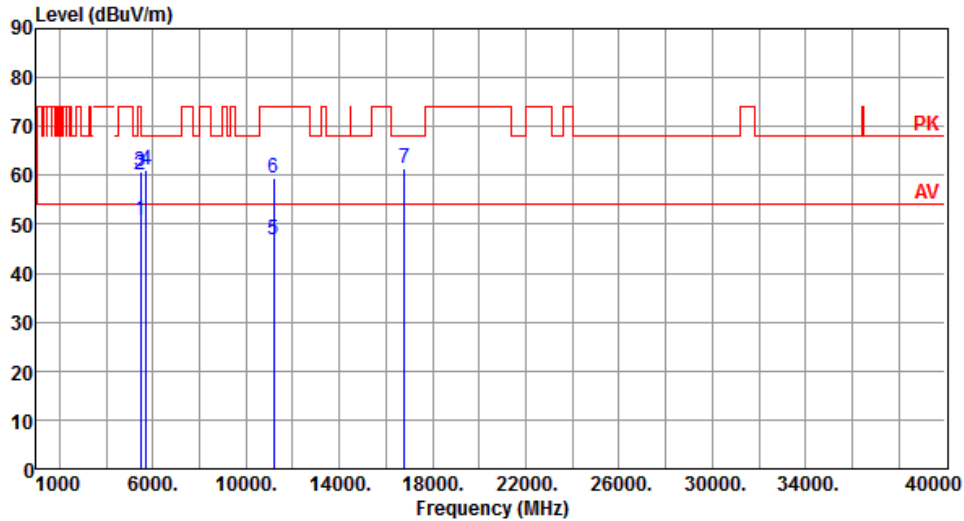

	Freq. MHz	Emission level dBuV/m	Limit dBuV/m	Margin dB	SA reading dBuV	Factor dB	Remark	ANT High cm	Turn Table deg
1	5460.00	50.95	54.00	-3.05	43.58	7.37	Average	181	186
2	5460.00	60.26	74.00	-13.74	52.89	7.37	Peak	181	186
3	5470.00	60.70	68.20	-7.50	53.28	7.42	Peak	181	186
4	5725.00	61.00	68.20	-7.20	53.24	7.76	Peak	181	186
5	11200.00	46.78	54.00	-7.22	30.25	16.53	Average	100	106
6	11200.00	59.37	74.00	-14.63	42.84	16.53	Peak	100	106
7	16800.00	61.41	68.20	-6.79	42.87	18.54	Peak	100	105

Note 1: Emission Level (dBuV/m) = SA Reading (dBuV/m) + Factor* (dB)

*Factor includes antenna factor , cable loss and amplifier gain

Note 2: Margin (dB) = Emission level (dBuV/m) – Limit (dBuV/m).

Proprietary protocol (MHz)	40	Test Freq. (MHz)	5600
Polarization	Vertical		

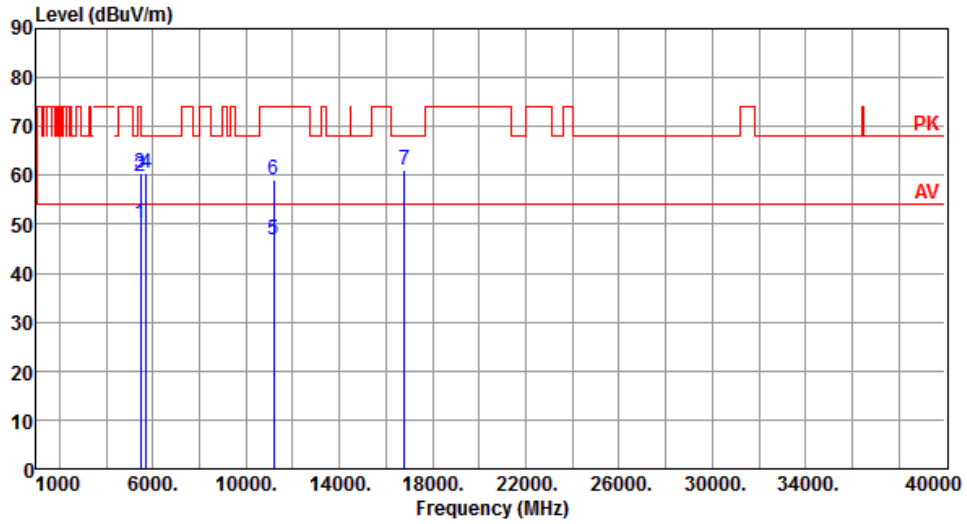

	Freq. MHz	Emission level dBuV/m	Limit dBuV/m	Margin dB	SA reading dBuV	Factor dB	Remark	ANT High cm	Turn Table deg
1	5460.00	50.21	54.00	-3.79	42.84	7.37	Average	186	179
2	5460.00	59.84	74.00	-14.16	52.47	7.37	Peak	186	179
3	5470.00	60.31	68.20	-7.89	52.89	7.42	Peak	186	179
4	5725.00	60.59	68.20	-7.61	52.83	7.76	Peak	186	179
5	11200.00	46.78	54.00	-7.22	30.25	16.53	Average	100	53
6	11200.00	59.19	74.00	-14.81	42.66	16.53	Peak	100	53
7	16800.00	61.04	68.20	-7.16	42.50	18.54	Peak	100	53

Note 1: Emission Level (dBuV/m) = SA Reading (dBuV/m) + Factor* (dB)

*Factor includes antenna factor , cable loss and amplifier gain

Note 2: Margin (dB) = Emission level (dBuV/m) – Limit (dBuV/m).

Proprietary protocol (MHz)	40	Test Freq. (MHz)	5695
Polarization	Horizontal		

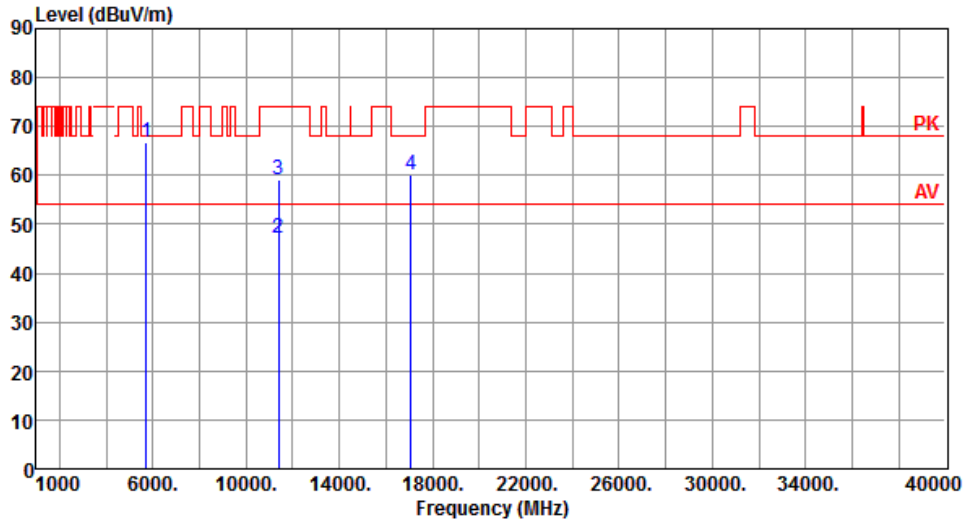

	Freq. MHz	Emission level dBuV/m	Limit dBuV/m	Margin dB	SA reading dBuV	Factor dB	Remark	ANT High cm	Turn Table deg
1	5725.00	66.73	68.20	-1.47	58.97	7.76	Peak	157	179
2	11390.00	47.24	54.00	-6.76	30.52	16.72	Average	100	102
3	11390.00	59.13	74.00	-14.87	42.41	16.72	Peak	100	102
4	17085.00	60.02	68.20	-8.18	41.44	18.58	Peak	100	105

Note 1: Emission Level (dBuV/m) = SA Reading (dBuV/m) + Factor* (dB)

*Factor includes antenna factor , cable loss and amplifier gain

Note 2: Margin (dB) = Emission level (dBuV/m) – Limit (dBuV/m).

Proprietary protocol (MHz)	40	Test Freq. (MHz)	5695
Polarization	Vertical		

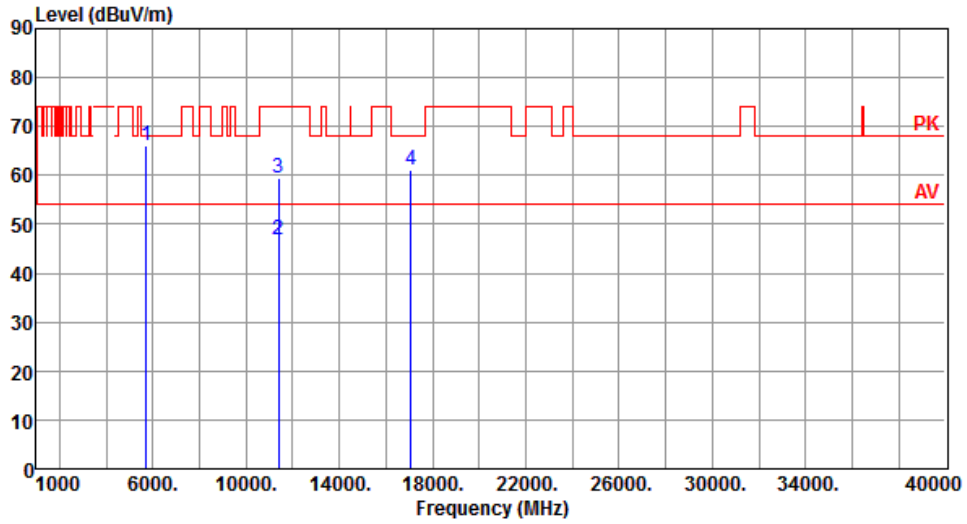

	Freq. MHz	Emission level dBuV/m	Limit dBuV/m	Margin dB	SA reading dBuV	Factor dB	Remark	ANT High cm	Turn Table deg
1	5725.00	66.25	68.20	-1.95	58.49	7.76	Peak	166	175
2	11390.00	46.93	54.00	-7.07	30.21	16.72	Average	100	52
3	11390.00	59.56	74.00	-14.44	42.84	16.72	Peak	100	52
4	17085.00	61.24	68.20	-6.96	42.66	18.58	Peak	100	53

Note 1: Emission Level (dBuV/m) = SA Reading (dBuV/m) + Factor* (dB)

*Factor includes antenna factor , cable loss and amplifier gain

Note 2: Margin (dB) = Emission level (dBuV/m) – Limit (dBuV/m).

Proprietary protocol (MHz)	40	Test Freq. (MHz)	5700
Polarization	Horizontal		

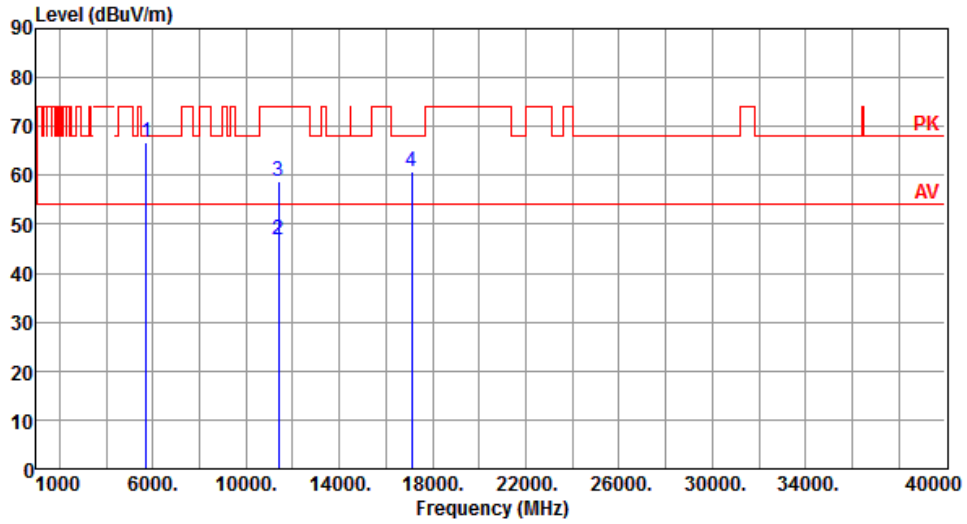

	Freq. MHz	Emission level dBuV/m	Limit dBuV/m	Margin dB	SA reading dBuV	Factor dB	Remark	ANT High cm	Turn Table deg
1	5725.00	66.74	68.20	-1.46	58.98	7.76	Peak	146	181
2	11400.00	46.92	54.00	-7.08	30.19	16.73	Average	100	101
3	11400.00	58.82	74.00	-15.18	42.09	16.73	Peak	100	101
4	17100.00	60.90	68.20	-7.30	42.36	18.54	Peak	100	103

Note 1: Emission Level (dBuV/m) = SA Reading (dBuV/m) + Factor* (dB)

*Factor includes antenna factor , cable loss and amplifier gain

Note 2: Margin (dB) = Emission level (dBuV/m) – Limit (dBuV/m).

Proprietary protocol (MHz)	40	Test Freq. (MHz)	5700
Polarization	Vertical		

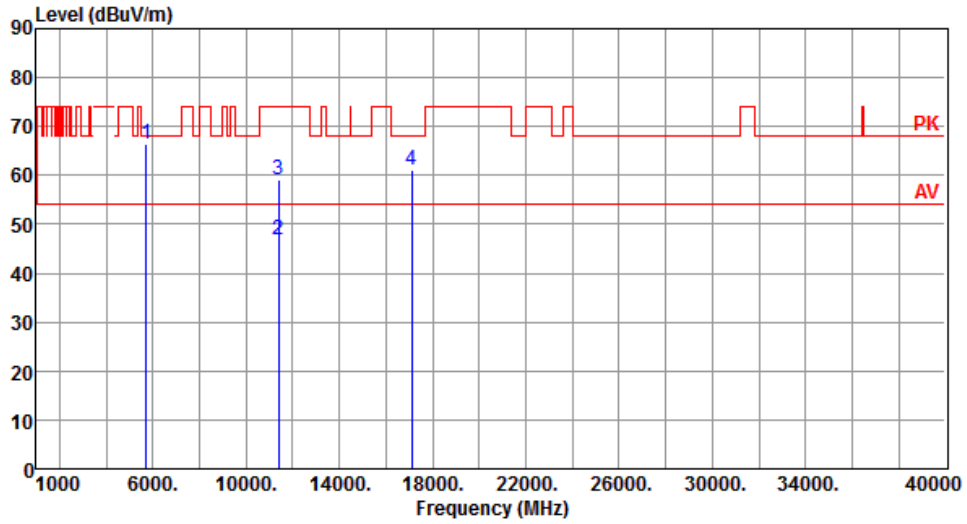

	Freq. MHz	Emission level dBuV/m	Limit dBuV/m	Margin dB	SA reading dBuV	Factor dB	Remark	ANT High cm	Turn Table deg
1	5725.00	66.27	68.20	-1.93	58.51	7.76	Peak	153	177
2	11400.00	46.97	54.00	-7.03	30.24	16.73	Average	100	51
3	11400.00	59.13	74.00	-14.87	42.40	16.73	Peak	100	51
4	17100.00	61.14	68.20	-7.06	42.60	18.54	Peak	100	53

Note 1: Emission Level (dBuV/m) = SA Reading (dBuV/m) + Factor* (dB)

*Factor includes antenna factor , cable loss and amplifier gain

Note 2: Margin (dB) = Emission level (dBuV/m) – Limit (dBuV/m).

3.5.7 Transmitter Radiated Unwanted Emissions (Above 1GHz) for 80 MHz

Proprietary protocol (MHz)	80	Test Freq. (MHz)	5290
Polarization	Horizontal		

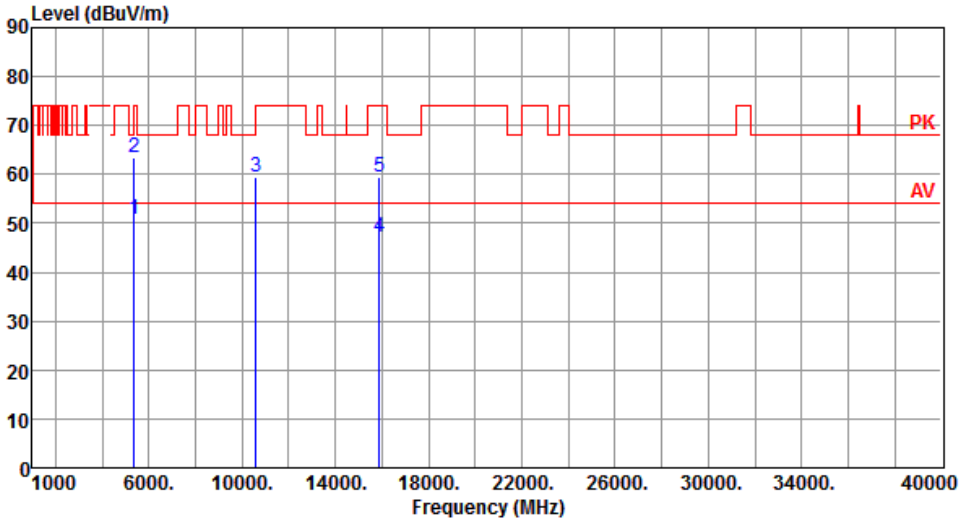

	Freq. MHz	Emission level dBuV/m	Limit dBuV/m	Margin dB	SA reading dBuV	Factor dB	Remark	ANT High cm	Turn Table deg
1	5350.00	50.65	54.00	-3.35	43.80	6.85	Average	162	170
2	5350.00	63.35	74.00	-10.65	56.50	6.85	Peak	162	170
3	10580.00	59.48	68.20	-8.72	42.85	16.63	Peak	100	106
4	15870.00	47.20	54.00	-6.80	30.53	16.67	Average	100	103
5	15870.00	59.45	74.00	-14.55	42.78	16.67	Peak	100	103

Note 1: Emission Level (dBuV/m) = SA Reading (dBuV/m) + Factor* (dB)
*Factor includes antenna factor , cable loss and amplifier gain
Note 2: Margin (dB) = Emission level (dBuV/m) – Limit (dBuV/m).

Proprietary protocol (MHz)	80	Test Freq. (MHz)	5290
Polarization	Vertical		

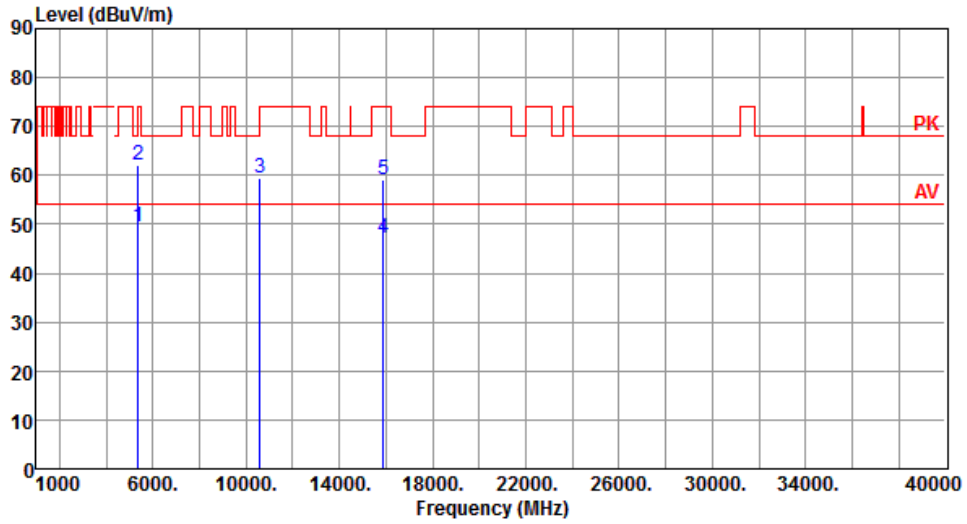

	Freq. MHz	Emission level dBuV/m	Limit dBuV/m	Margin dB	SA reading dBuV	Factor dB	Remark	ANT High cm	Turn Table deg
1	5350.00	49.41	54.00	-4.59	42.56	6.85	Average	155	179
2	5350.00	62.06	74.00	-11.94	55.21	6.85	Peak	155	179
3	10580.00	59.35	68.20	-8.85	42.72	16.63	Peak	100	59
4	15870.00	47.24	54.00	-6.76	30.57	16.67	Average	100	52
5	15870.00	59.08	74.00	-14.92	42.41	16.67	Peak	100	52

Note 1: Emission Level (dBuV/m) = SA Reading (dBuV/m) + Factor* (dB)

*Factor includes antenna factor , cable loss and amplifier gain

Note 2: Margin (dB) = Emission level (dBuV/m) – Limit (dBuV/m).

Proprietary protocol (MHz)	80	Test Freq. (MHz)	5295
Polarization	Horizontal		

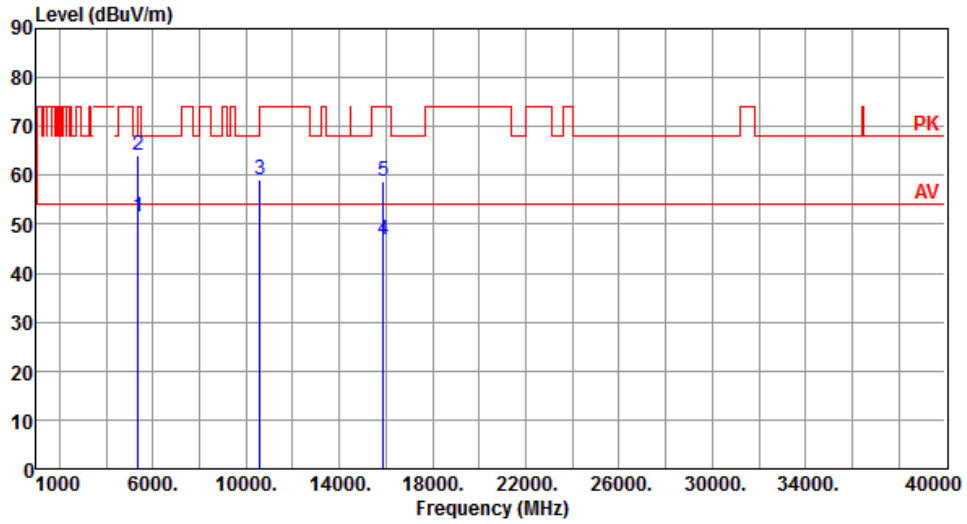

	Freq. MHz	Emission level dBuV/m	Limit dBuV/m	Margin dB	SA reading dBuV	Factor dB	Remark	ANT High cm	Turn Table deg
1	5350.00	51.52	54.00	-2.48	44.67	6.85	Average	163	171
2	5350.00	64.22	74.00	-9.78	57.37	6.85	Peak	163	171
3	10590.00	59.05	68.20	-9.15	42.40	16.65	Peak	100	105
4	15885.00	46.90	54.00	-7.10	30.22	16.68	Average	100	101
5	15885.00	58.78	74.00	-15.22	42.10	16.68	Peak	100	101

Note 1: Emission Level (dBuV/m) = SA Reading (dBuV/m) + Factor* (dB)

*Factor includes antenna factor , cable loss and amplifier gain

Note 2: Margin (dB) = Emission level (dBuV/m) – Limit (dBuV/m).

Proprietary protocol (MHz)	80	Test Freq. (MHz)	5295
Polarization	Vertical		

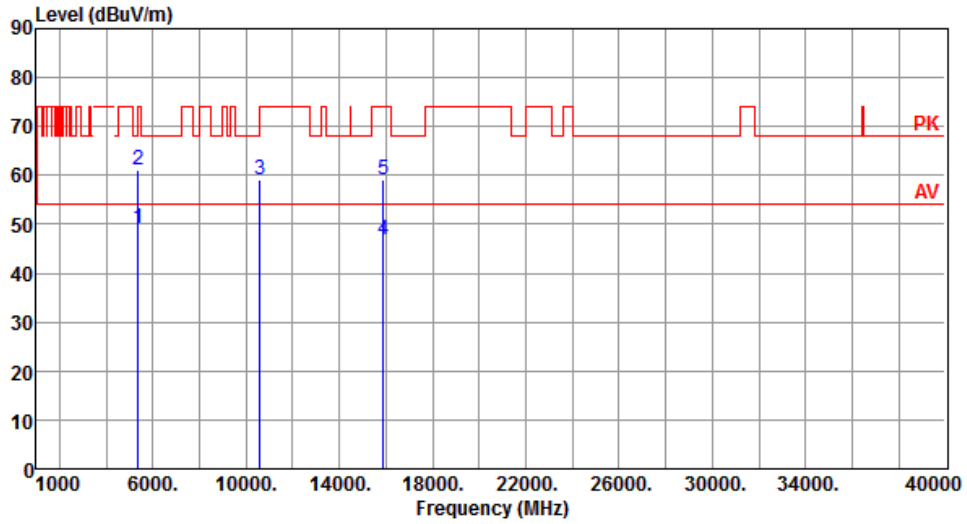

	Freq. MHz	Emission level dBuV/m	Limit dBuV/m	Margin dB	SA reading dBuV	Factor dB	Remark	ANT High cm	Turn Table deg
1	5350.00	49.10	54.00	-4.90	42.25	6.85	Average	125	177
2	5350.00	61.25	74.00	-12.75	54.40	6.85	Peak	163	171
3	10590.00	59.12	68.20	-9.08	42.47	16.65	Peak	100	42
4	15885.00	46.88	54.00	-7.12	30.20	16.68	Average	100	53
5	15885.00	59.01	74.00	-14.99	42.33	16.68	Peak	100	53

Note 1: Emission Level (dBuV/m) = SA Reading (dBuV/m) + Factor* (dB)

*Factor includes antenna factor , cable loss and amplifier gain

Note 2: Margin (dB) = Emission level (dBuV/m) – Limit (dBuV/m).

Proprietary protocol (MHz)	80	Test Freq. (MHz)	5300
Polarization	Horizontal		

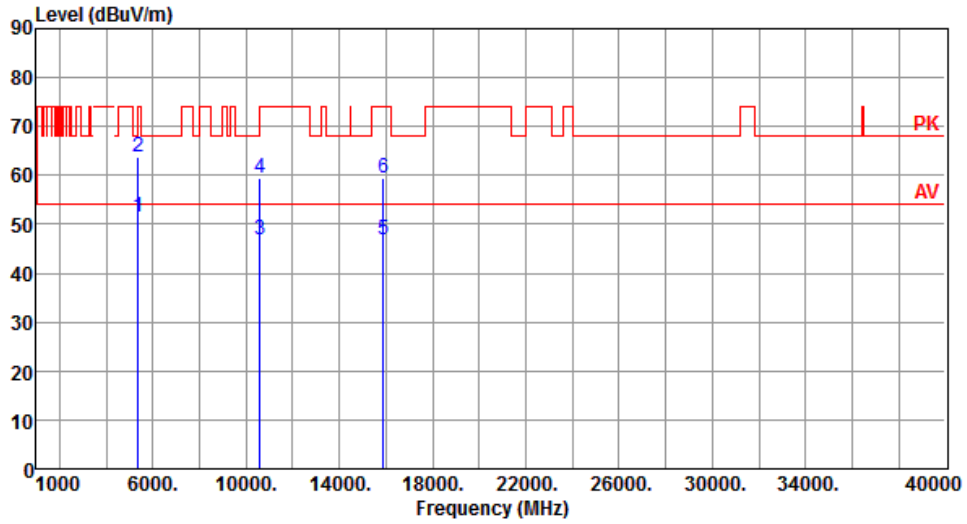

	Freq. MHz	Emission level dBuV/m	Limit dBuV/m	Margin dB	SA reading dBuV	Factor dB	Remark	ANT High cm	Turn Table deg
1	5350.00	51.53	54.00	-2.47	44.68	6.85	Average	147	169
2	5350.00	63.71	74.00	-10.29	56.86	6.85	Peak	147	169
3	10600.00	46.88	54.00	-7.12	30.22	16.66	Average	100	101
4	10600.00	59.50	74.00	-14.50	42.84	16.66	Peak	100	101
5	15900.00	46.99	54.00	-7.01	30.30	16.69	Average	100	103
6	15900.00	59.49	74.00	-14.51	42.80	16.69	Peak	100	103

Note 1: Emission Level (dBuV/m) = SA Reading (dBuV/m) + Factor* (dB)

*Factor includes antenna factor , cable loss and amplifier gain

Note 2: Margin (dB) = Emission level (dBuV/m) – Limit (dBuV/m).

Proprietary protocol (MHz)	80	Test Freq. (MHz)	5300
Polarization	Vertical		

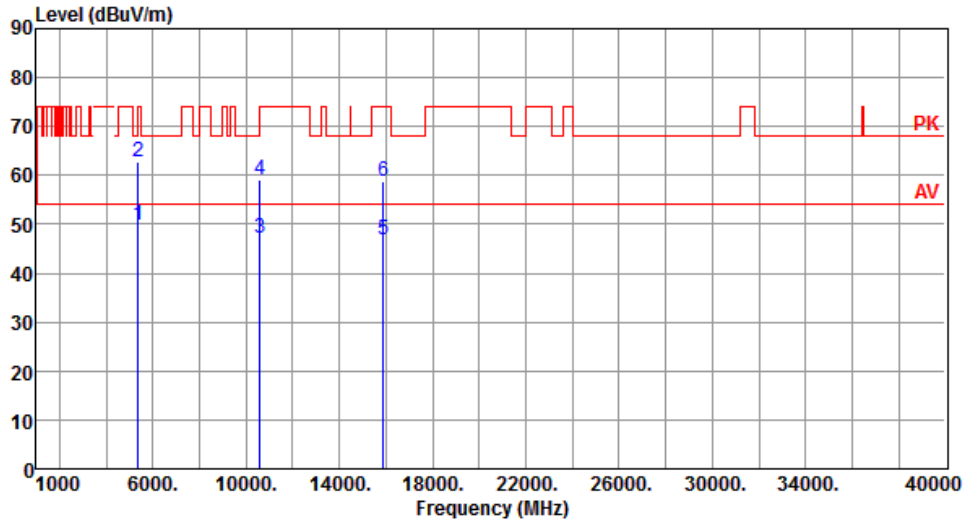

	Freq. MHz	Emission level dBuV/m	Limit dBuV/m	Margin dB	SA reading dBuV	Factor dB	Remark	ANT High cm	Turn Table deg
1	5350.00	49.69	54.00	-4.31	42.84	6.85	Average	125	174
2	5350.00	62.75	74.00	-11.25	55.90	6.85	Peak	125	174
3	10600.00	47.20	54.00	-6.80	30.54	16.66	Average	100	52
4	10600.00	59.06	74.00	-14.94	42.40	16.66	Peak	100	52
5	15900.00	46.91	54.00	-7.09	30.22	16.69	Average	100	52
6	15900.00	58.69	74.00	-15.31	42.00	16.69	Peak	100	52

Note 1: Emission Level (dBuV/m) = SA Reading (dBuV/m) + Factor* (dB)

*Factor includes antenna factor , cable loss and amplifier gain

Note 2: Margin (dB) = Emission level (dBuV/m) – Limit (dBuV/m).

Proprietary protocol (MHz)	80	Test Freq. (MHz)	5305
Polarization	Horizontal		

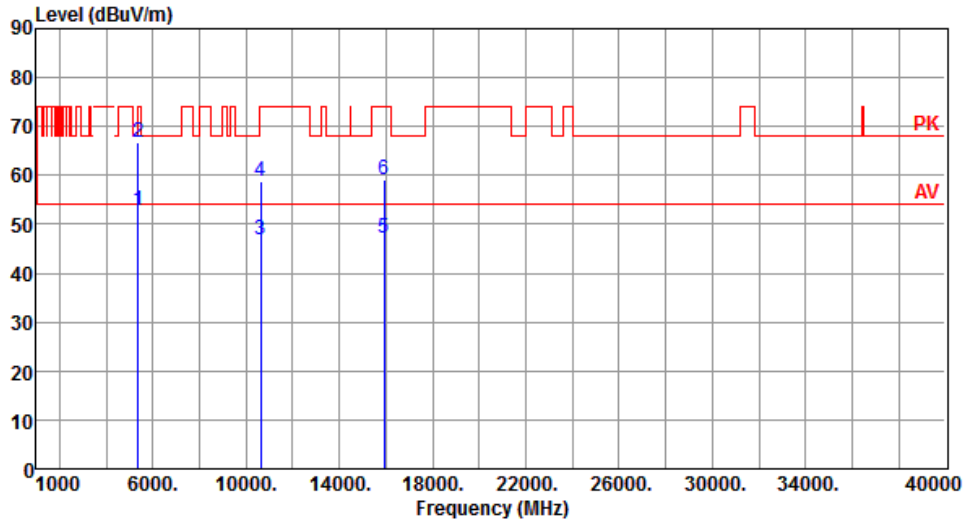

	Freq. MHz	Emission level dBuV/m	Limit dBuV/m	Margin dB	SA reading dBuV	Factor dB	Remark	ANT High cm	Turn Table deg
1	5350.00	52.67	54.00	-1.33	45.82	6.85	Average	147	173
2	5350.00	66.74	74.00	-7.26	59.89	6.85	Peak	147	173
3	10610.00	46.90	54.00	-7.10	30.25	16.65	Average	100	103
4	10610.00	58.75	74.00	-15.25	42.10	16.65	Peak	100	103
5	15915.00	47.03	54.00	-6.97	30.34	16.69	Average	100	105
6	15915.00	59.14	74.00	-14.86	42.45	16.69	Peak	100	105

Note 1: Emission Level (dBuV/m) = SA Reading (dBuV/m) + Factor* (dB)

*Factor includes antenna factor , cable loss and amplifier gain

Note 2: Margin (dB) = Emission level (dBuV/m) – Limit (dBuV/m).

Proprietary protocol (MHz)	80	Test Freq. (MHz)	5305
Polarization	Vertical		

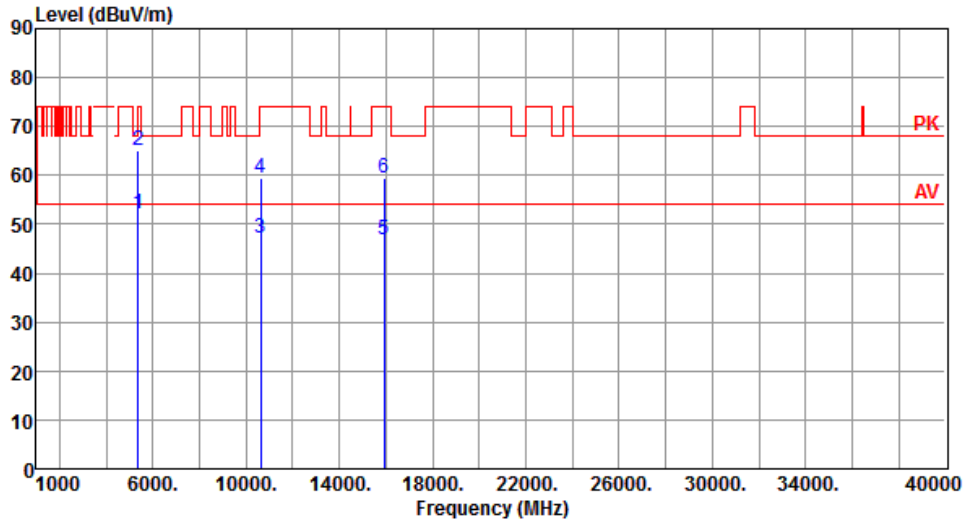

	Freq. MHz	Emission level dBuV/m	Limit dBuV/m	Margin dB	SA reading dBuV	Factor dB	Remark	ANT High cm	Turn Table deg
1	5350.00	52.16	54.00	-1.84	45.31	6.85	Average	141	168
2	5350.00	65.23	74.00	-8.77	58.38	6.85	Peak	141	168
3	10610.00	47.20	54.00	-6.80	30.55	16.65	Average	100	52
4	10610.00	59.46	74.00	-14.54	42.81	16.65	Peak	100	52
5	15915.00	46.70	54.00	-7.30	30.01	16.69	Average	100	52
6	15915.00	59.54	74.00	-14.46	42.85	16.69	Peak	100	53

Note 1: Emission Level (dBuV/m) = SA Reading (dBuV/m) + Factor* (dB)

*Factor includes antenna factor , cable loss and amplifier gain

Note 2: Margin (dB) = Emission level (dBuV/m) – Limit (dBuV/m).

Proprietary protocol (MHz)	80	Test Freq. (MHz)	5515
Polarization	Horizontal		

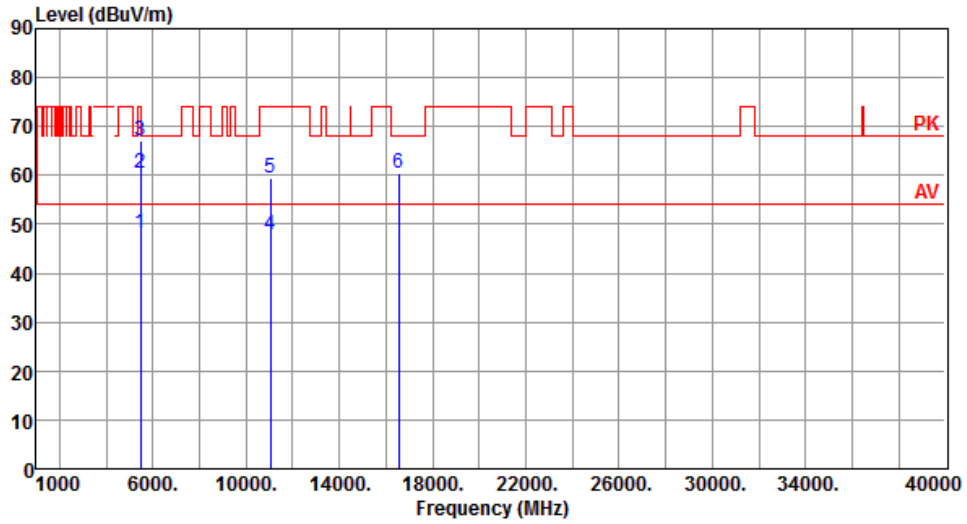

	Freq. MHz	Emission level dBuV/m	Limit dBuV/m	Margin dB	SA reading dBuV	Factor dB	Remark	ANT High cm	Turn Table deg
1	5460.00	48.28	54.00	-5.72	40.91	7.37	Average	180	184
2	5460.00	60.32	74.00	-13.68	52.95	7.37	Peak	180	184
3	5470.00	67.19	68.20	-1.01	59.77	7.42	Peak	180	184
4	11030.00	47.76	54.00	-6.24	30.86	16.90	Average	100	109
5	11030.00	59.55	74.00	-14.45	42.65	16.90	Peak	100	109
6	16545.00	60.55	68.20	-7.65	42.80	17.75	Peak	100	103

Note 1: Emission Level (dBuV/m) = SA Reading (dBuV/m) + Factor* (dB)

*Factor includes antenna factor , cable loss and amplifier gain

Note 2: Margin (dB) = Emission level (dBuV/m) – Limit (dBuV/m).

Proprietary protocol (MHz)	80	Test Freq. (MHz)	5515
Polarization	Vertical		

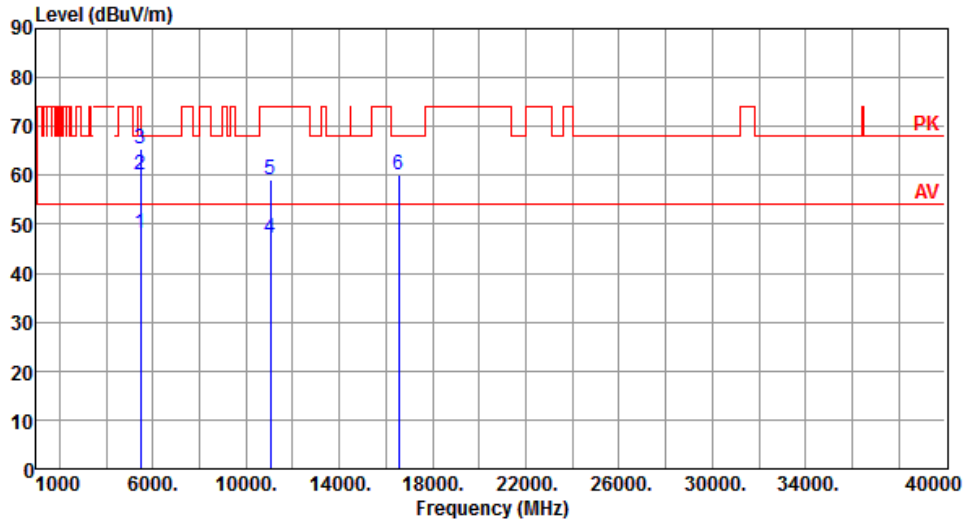

	Freq. MHz	Emission level dBuV/m	Limit dBuV/m	Margin dB	SA reading dBuV	Factor dB	Remark	ANT High cm	Turn Table deg
1	5460.00	48.25	54.00	-5.75	40.88	7.37	Average	193	172
2	5460.00	60.21	74.00	-13.79	52.84	7.37	Peak	193	172
3	5470.00	65.32	68.20	-2.88	57.90	7.42	Peak	193	172
4	11030.00	47.11	54.00	-6.89	30.21	16.90	Average	100	57
5	11030.00	59.03	74.00	-14.97	42.13	16.90	Peak	100	57
6	16545.00	59.97	68.20	-8.23	42.22	17.75	Peak	100	57

Note 1: Emission Level (dBuV/m) = SA Reading (dBuV/m) + Factor* (dB)

*Factor includes antenna factor , cable loss and amplifier gain

Note 2: Margin (dB) = Emission level (dBuV/m) – Limit (dBuV/m).

Proprietary protocol (MHz)	80	Test Freq. (MHz)	5520
Polarization	Horizontal		

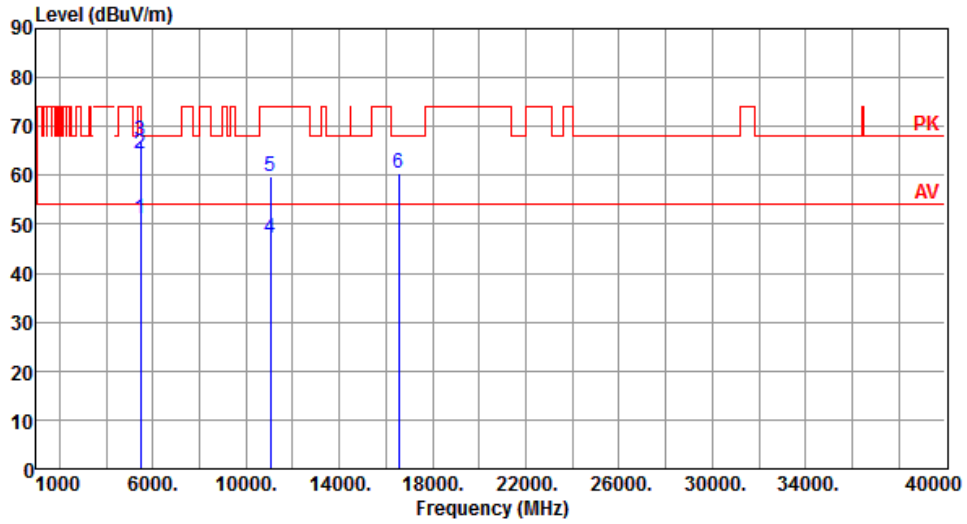

	Freq. MHz	Emission level dBuV/m	Limit dBuV/m	Margin dB	SA reading dBuV	Factor dB	Remark	ANT High cm	Turn Table deg
1	5460.00	51.12	54.00	-2.88	43.75	7.37	Average	161	186
2	5460.00	64.27	74.00	-9.73	56.90	7.37	Peak	161	186
3	5470.00	66.98	68.20	-1.22	59.56	7.42	Peak	161	186
4	11040.00	47.13	54.00	-6.87	30.25	16.88	Average	100	107
5	11040.00	59.76	74.00	-14.24	42.88	16.88	Peak	100	107
6	16560.00	60.49	68.20	-7.71	42.71	17.78	Peak	100	102

Note 1: Emission Level (dBuV/m) = SA Reading (dBuV/m) + Factor* (dB)

*Factor includes antenna factor , cable loss and amplifier gain

Note 2: Margin (dB) = Emission level (dBuV/m) – Limit (dBuV/m).

Proprietary protocol (MHz)	80	Test Freq. (MHz)	5520
Polarization	Vertical		

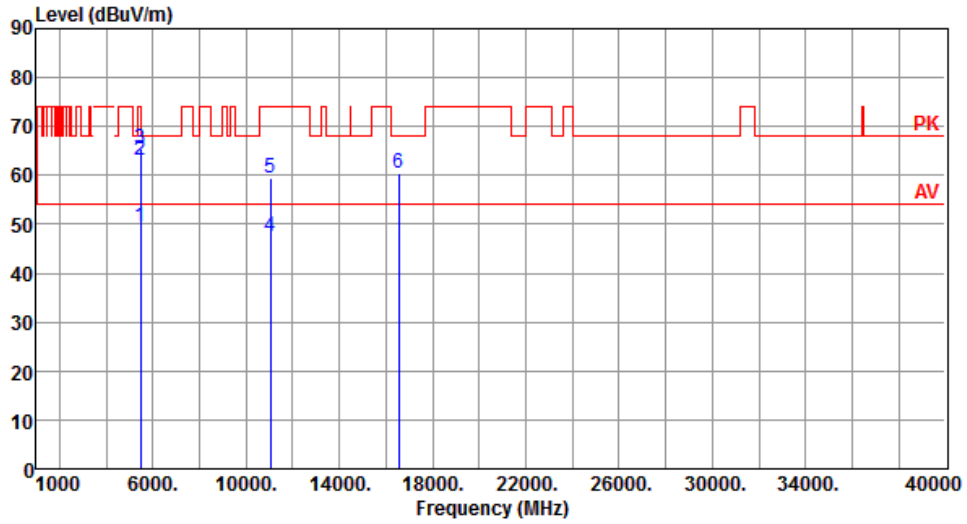

	Freq. MHz	Emission level dBuV/m	Limit dBuV/m	Margin dB	SA reading dBuV	Factor dB	Remark	ANT High cm	Turn Table deg
1	5460.00	49.51	54.00	-4.49	42.14	7.37	Average	129	172
2	5460.00	63.26	74.00	-10.74	55.89	7.37	Peak	129	172
3	5470.00	65.30	68.20	-2.90	57.88	7.42	Peak	129	172
4	11040.00	47.43	54.00	-6.57	30.55	16.88	Average	100	52
5	11040.00	59.48	74.00	-14.52	42.60	16.88	Peak	100	52
6	16560.00	60.28	68.20	-7.92	42.50	17.78	Peak	100	57

Note 1: Emission Level (dBuV/m) = SA Reading (dBuV/m) + Factor* (dB)

*Factor includes antenna factor , cable loss and amplifier gain

Note 2: Margin (dB) = Emission level (dBuV/m) – Limit (dBuV/m).

Proprietary protocol (MHz)	80	Test Freq. (MHz)	5600
Polarization	Horizontal		

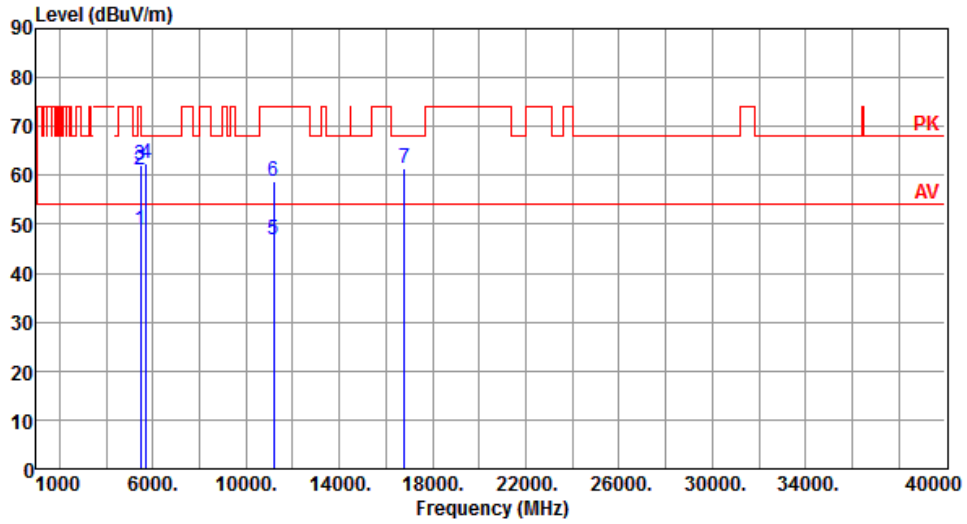

	Freq. MHz	Emission level dBuV/m	Limit dBuV/m	Margin dB	SA reading dBuV	Factor dB	Remark	ANT High cm	Turn Table deg
1	5460.00	48.94	54.00	-5.06	41.57	7.37	Average	169	185
2	5460.00	61.23	74.00	-12.77	53.86	7.37	Peak	169	185
3	5470.00	62.00	68.20	-6.20	54.58	7.42	Peak	169	185
4	5725.00	62.32	68.20	-5.88	54.56	7.76	Peak	169	185
5	11200.00	46.78	54.00	-7.22	30.25	16.53	Average	100	103
6	11200.00	58.78	74.00	-15.22	42.25	16.53	Peak	100	103
7	16800.00	61.35	68.20	-6.85	42.81	18.54	Peak	100	102

Note 1: Emission Level (dBuV/m) = SA Reading (dBuV/m) + Factor* (dB)

*Factor includes antenna factor , cable loss and amplifier gain

Note 2: Margin (dB) = Emission level (dBuV/m) – Limit (dBuV/m).

Proprietary protocol (MHz)	80	Test Freq. (MHz)	5600
Polarization	Vertical		

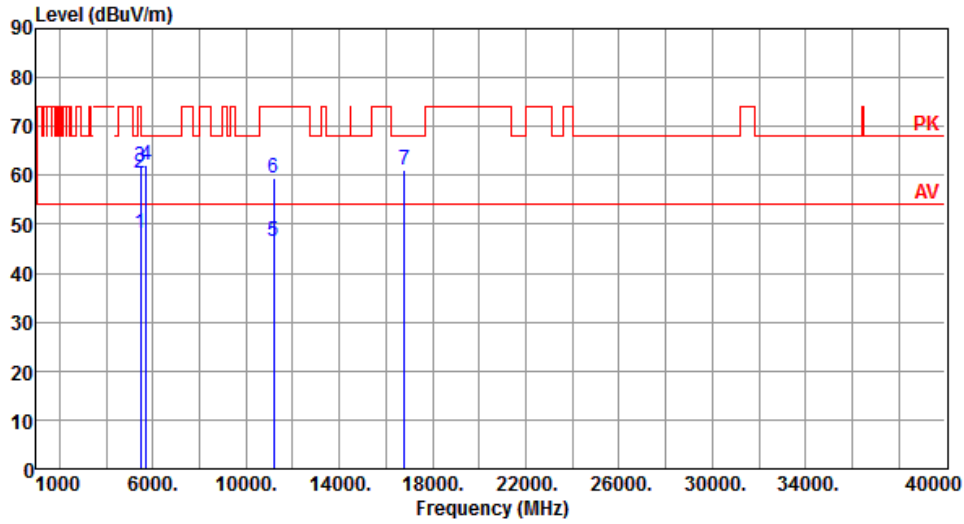

	Freq. MHz	Emission level dBuV/m	Limit dBuV/m	Margin dB	SA reading dBuV	Factor dB	Remark	ANT High cm	Turn Table deg
1	5460.00	48.25	54.00	-5.75	40.88	7.37	Average	175	181
2	5460.00	60.32	74.00	-13.68	52.95	7.37	Peak	175	181
3	5470.00	61.67	68.20	-6.53	54.25	7.42	Peak	175	181
4	5725.00	61.95	68.20	-6.25	54.19	7.76	Peak	175	181
5	11200.00	46.63	54.00	-7.37	30.10	16.53	Average	100	52
6	11200.00	59.33	74.00	-14.67	42.80	16.53	Peak	100	52
7	16800.00	61.24	68.20	-6.96	42.70	18.54	Peak	100	52

Note 1: Emission Level (dBuV/m) = SA Reading (dBuV/m) + Factor* (dB)

*Factor includes antenna factor , cable loss and amplifier gain

Note 2: Margin (dB) = Emission level (dBuV/m) – Limit (dBuV/m).

Proprietary protocol (MHz)	80	Test Freq. (MHz)	5675
Polarization	Horizontal		

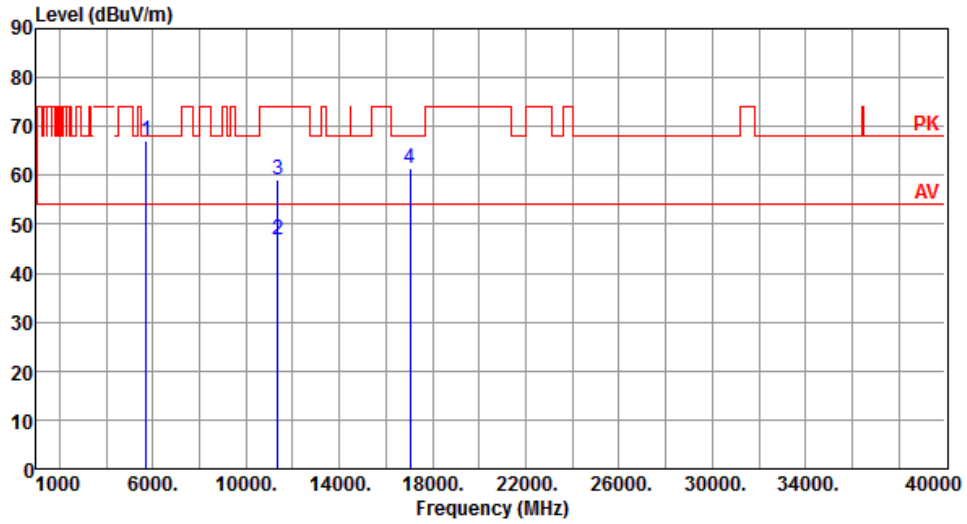

	Freq. MHz	Emission level dBuV/m	Limit dBuV/m	Margin dB	SA reading dBuV	Factor dB	Remark	ANT High cm	Turn Table deg
1	5725.00	67.19	68.20	-1.01	59.43	7.76	Peak	154	179
2	11350.00	46.91	54.00	-7.09	30.21	16.70	Average	100	103
3	11350.00	59.17	74.00	-14.83	42.47	16.70	Peak	100	103
4	17025.00	61.58	68.20	-6.62	42.84	18.74	Peak	100	106

Note 1: Emission Level (dBuV/m) = SA Reading (dBuV/m) + Factor* (dB)

*Factor includes antenna factor , cable loss and amplifier gain

Note 2: Margin (dB) = Emission level (dBuV/m) – Limit (dBuV/m).

Proprietary protocol (MHz)	80	Test Freq. (MHz)	5675
Polarization	Vertical		

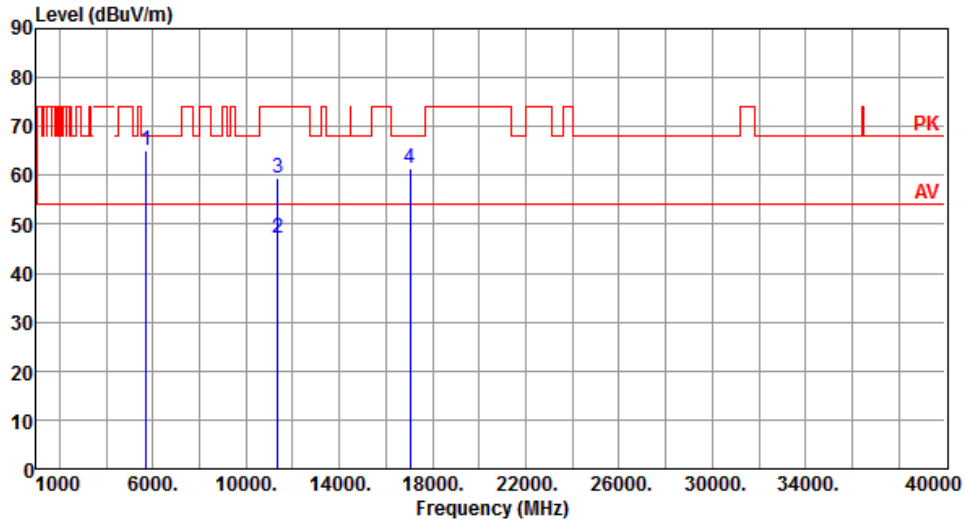

	Freq. MHz	Emission level dBuV/m	Limit dBuV/m	Margin dB	SA reading dBuV	Factor dB	Remark	ANT High cm	Turn Table deg
1	5725.00	65.05	68.20	-3.15	57.29	7.76	Peak	133	186
2	11350.00	47.29	54.00	-6.71	30.59	16.70	Average	100	52
3	11350.00	59.54	74.00	-14.46	42.84	16.70	Peak	100	52
4	17025.00	61.34	68.20	-6.86	42.60	18.74	Peak	100	53

Note 1: Emission Level (dBuV/m) = SA Reading (dBuV/m) + Factor* (dB)

*Factor includes antenna factor , cable loss and amplifier gain

Note 2: Margin (dB) = Emission level (dBuV/m) – Limit (dBuV/m).

Proprietary protocol (MHz)	80	Test Freq. (MHz)	5680
Polarization	Horizontal		

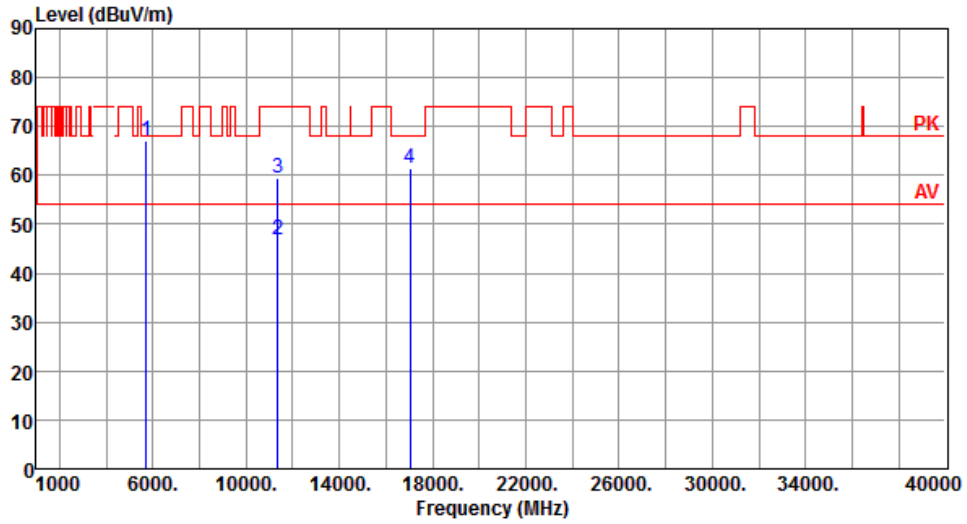

	Freq. MHz	Emission level dBuV/m	Limit dBuV/m	Margin dB	SA reading dBuV	Factor dB	Remark	ANT High cm	Turn Table deg
1	5725.00	67.10	68.20	-1.10	59.34	7.76	Peak	151	177
2	11360.00	46.94	54.00	-7.06	30.23	16.71	Average	100	105
3	11360.00	59.60	74.00	-14.40	42.89	16.71	Peak	100	105
4	17040.00	61.50	68.20	-6.70	42.80	18.70	Peak	100	105

Note 1: Emission Level (dBuV/m) = SA Reading (dBuV/m) + Factor* (dB)

*Factor includes antenna factor , cable loss and amplifier gain

Note 2: Margin (dB) = Emission level (dBuV/m) – Limit (dBuV/m).

Proprietary protocol (MHz)	80	Test Freq. (MHz)	5680
Polarization	Vertical		

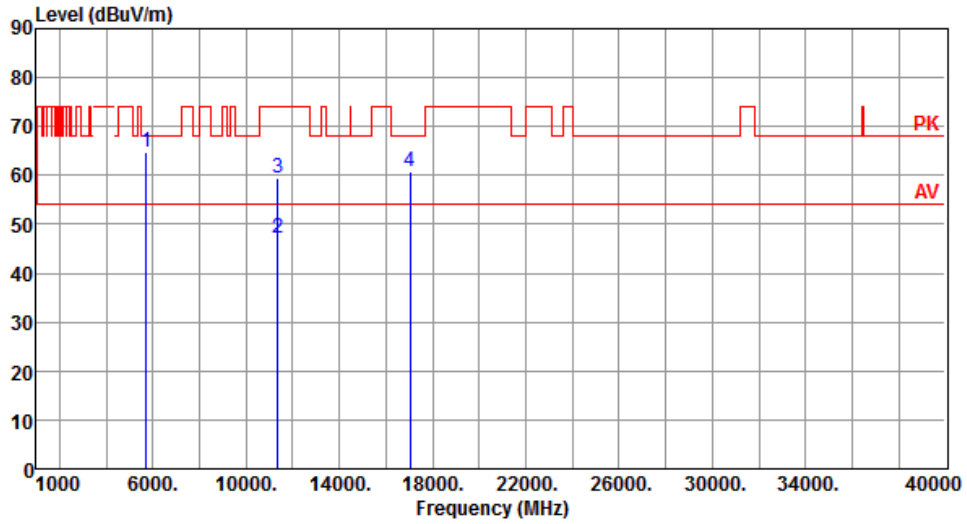

	Freq. MHz	Emission level dBuV/m	Limit dBuV/m	Margin dB	SA reading dBuV	Factor dB	Remark	ANT High cm	Turn Table deg
1	5725.00	64.89	68.20	-3.31	57.13	7.76	Peak	122	180
2	11360.00	47.26	54.00	-6.74	30.55	16.71	Average	100	52
3	11360.00	59.55	74.00	-14.45	42.84	16.71	Peak	100	52
4	17040.00	60.84	68.20	-7.36	42.14	18.70	Peak	100	53

Note 1: Emission Level (dBuV/m) = SA Reading (dBuV/m) + Factor* (dB)

*Factor includes antenna factor , cable loss and amplifier gain

Note 2: Margin (dB) = Emission level (dBuV/m) – Limit (dBuV/m).

3.6 Frequency Stability

3.6.1 Limit of Frequency Stability

Manufacturers of U-NII devices are responsible for ensuring frequency stability such that an emission is maintained within the band of operation under all conditions of normal operation as specified in the user's manual.

3.6.2 Test Procedures

1. The EUT is installed in an environment test chamber with external power source.
2. Set the chamber to operate at 20 centigrade and external power source to output at nominal voltage of EUT.
3. A sufficient stabilization period at each temperature is used prior to each frequency measurement.
4. When temperature is stabled, measure the frequency stability.
5. The test shall be performed under normal and extreme condition for temperature and voltage.

3.6.3 Test Setup

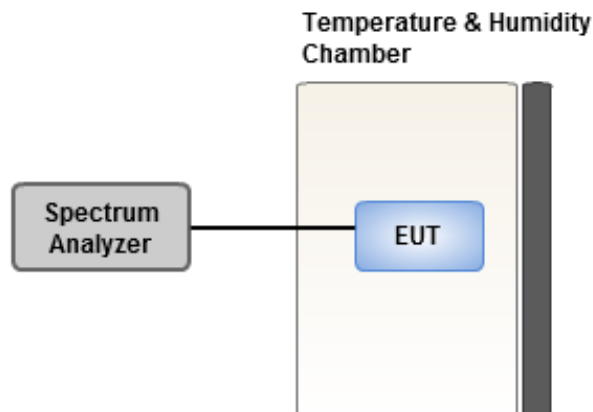

3.6.4 Test Result of Frequency Stability

Frequency: 5335 MHz	Frequency Drift (ppm)				
	Temperature (°C)	0 minute	2 minutes	5 minutes	10 minutes
T20°CVmax		-2.56	-2.35	-2.27	-2.45
T20°CVmin		-3.25	-3.06	-2.62	-2.79
T70°CVnom		-6.90	-6.50	-6.55	-6.60
T60°CVnom		-6.01	-5.89	-5.69	-5.59
T50°CVnom		-3.51	-3.73	-3.44	-3.35
T40°CVnom		-3.99	-3.63	-3.72	-3.71
T30°CVnom		-2.34	-2.64	-2.23	-2.14
T20°CVnom		-2.15	-1.95	-2.09	-2.28
T10°CVnom		-1.07	-0.42	-0.64	-1.32
T0°CVnom		2.43	2.68	2.70	2.35
T-10°CVnom		3.57	3.20	3.69	3.72
T-20°CVnom		6.73	6.78	6.68	7.22
T-30°CVnom		8.27	8.34	8.76	8.49
T-40°CVnom		8.70	9.01	9.02	9.15
Vnom [Vac]: 120		Vmax [Vac]: 138		Vmin [Vac]: 102	
Tnom [°C]: 20		Tmax [°C]: 70		Tmin [°C]: -40	

4 Test laboratory information

Established in 2012, ICC provides foremost EMC & RF Testing and advisory consultation services by our skilled engineers and technicians. Our services employ a wide variety of advanced edge test equipment and one of the widest certification extents in the business.

International Certification Corp (EMC and Wireless Communication Laboratory), it is our definitive objective is to institute long term, trust-based associations with our clients. The expectation we set up with our clients is based on outstanding service, practical expertise and devotion to a certified value structure. Our passion is to grant our clients with best EMC / RF services by oriented knowledgeable and accommodating staff.

Our Test sites are located at Linkou District and Kwei Shan District. Location map can be found on our website <http://www.icertifi.com.tw>.

Linkou

Tel: 886-2-2601-1640

No. 30-2, Ding Fwu Tsuen, Lin
Kou District, New Taipei City,
Taiwan, R.O.C.

Kwei Shan

Tel: 886-3-271-8666

No. 3-1, Lane 6, Wen San 3rd St.,
Kwei Shan District, Tao Yuan City
333, Taiwan, R.O.C.

Kwei Shan Site II

Tel: 886-3-271-8640

No. 14-1, Lane 19, Wen San 3rd
St., Kwei Shan District, Tao Yuan
City 333, Taiwan, R.O.C.

If you have any suggestion, please feel free to contact us as below information.

Tel: 886-3-271-8666

Fax: 886-3-318-0155

Email: ICC_Service@icertifi.com.tw

==END==