

EMC Test Report

Application for Grant of Equipment Authorization

Industry Canada RSS-Gen Issue 3 / RSS 210 Issue 8 FCC Part 15 Subpart C

Model: AirFiber 5GHz

IC CERTIFICATION #: 6545A-AF5U
FCC ID: SWX-AF5U

APPLICANT: Ubiquiti Networks
12F, No105, Song Ren Rd.
SinYi District, Taipei Taiwan

TEST SITE(S): National Technical Systems - Silicon Valley
41039 Boyce Road.
Fremont, CA. 94538-2435

IC SITE REGISTRATION #: 2845B-4, 2845B-7

REPORT DATE: September 12, 2013

REISSUE DATE: September 17, 2013

FINAL TEST DATES: August 1, and August 19 and 22, 2013

TOTAL NUMBER OF PAGES: 52

PROGRAM MGR /
TECHNICAL REVIEWER:

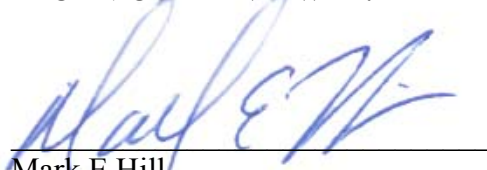

Mark E Hill
Staff Engineer

QUALITY ASSURANCE DELEGATE /
FINAL REPORT PREPARER:

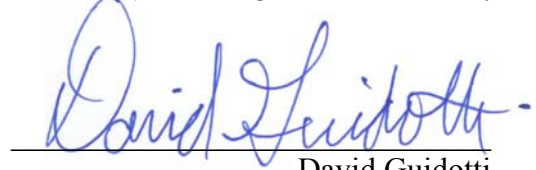

David Guidotti
Senior Technical Writer



National Technical Systems - Silicon Valley is accredited by the A2LA, certificate number 0214.26, to perform the test(s) listed in this report, except where noted otherwise. This report and the information contained herein represent the results of testing test articles identified and selected by the client performed to specifications and/or procedures selected by the client. National Technical Systems (NTS) makes no representations, expressed or implied, that such testing is adequate (or inadequate) to demonstrate efficiency, performance, reliability, or any other characteristic of the articles being tested, or similar products. This report should not be relied upon as an endorsement or certification by NTS of the equipment tested, nor does it represent any statement whatsoever as to its merchantability or fitness of the test article, or similar products, for a particular purpose. This report shall not be reproduced except in full

REVISION HISTORY

Rev#	Date	Comments	Modified By
-	09-12-2013	First release	
1	09-17-2013	Reissued to correct applicant address and correct typos in the low and high channel frequencies.	Dave Guidotti

TABLE OF CONTENTS

REVISION HISTORY	2
TABLE OF CONTENTS	3
SCOPE.....	4
OBJECTIVE	4
STATEMENT OF COMPLIANCE.....	5
DEVIATIONS FROM THE STANDARDS.....	5
TEST RESULTS SUMMARY	6
DIGITAL TRANSMISSION SYSTEMS (5725 –5850 MHZ).....	6
GENERAL REQUIREMENTS APPLICABLE TO ALL BANDS.....	6
MEASUREMENT UNCERTAINTIES.....	7
EQUIPMENT UNDER TEST (EUT) DETAILS.....	8
GENERAL.....	8
OTHER EUT DETAILS.....	8
ANTENNA SYSTEM	8
ENCLOSURE.....	8
MODIFICATIONS.....	8
SUPPORT EQUIPMENT.....	9
EUT INTERFACE PORTS	9
EUT OPERATION	9
TEST SITE.....	10
GENERAL INFORMATION.....	10
CONDUCTED EMISSIONS CONSIDERATIONS	10
RADIATED EMISSIONS CONSIDERATIONS	10
MEASUREMENT INSTRUMENTATION	11
RECEIVER SYSTEM	11
INSTRUMENT CONTROL COMPUTER	11
LINE IMPEDANCE STABILIZATION NETWORK (LISN).....	11
FILTERS/ATTENUATORS	12
ANTENNAS.....	12
ANTENNA MAST AND EQUIPMENT TURNTABLE.....	12
INSTRUMENT CALIBRATION.....	12
TEST PROCEDURES	13
EUT AND CABLE PLACEMENT	13
CONDUCTED EMISSIONS.....	13
RADIATED EMISSIONS.....	14
CONDUCTED EMISSIONS FROM ANTENNA PORT	16
BANDWIDTH MEASUREMENTS	16
SPECIFICATION LIMITS AND SAMPLE CALCULATIONS.....	17
CONDUCTED EMISSIONS SPECIFICATION LIMITS: FCC 15.207; FCC 15.107(A), RSS GEN	17
GENERAL TRANSMITTER RADIATED EMISSIONS SPECIFICATION LIMITS	18
OUTPUT POWER LIMITS – DIGITAL TRANSMISSION SYSTEMS	18
TRANSMIT MODE SPURIOUS RADIATED EMISSIONS LIMITS – FHSS AND DTS SYSTEMS.....	18
SAMPLE CALCULATIONS - CONDUCTED EMISSIONS	19
SAMPLE CALCULATIONS - RADIATED EMISSIONS.....	19
SAMPLE CALCULATIONS - FIELD STRENGTH TO EIRP CONVERSION.....	20
APPENDIX A TEST EQUIPMENT CALIBRATION DATA	21
APPENDIX B TEST DATA	22
END OF REPORT	52

SCOPE

An electromagnetic emissions test has been performed on the Ubiquiti Networks model AirFiber 5GHz, pursuant to the following rules:

Industry Canada RSS-Gen Issue 3
RSS 210 Issue 8 “Low-power Licence-exempt Radiocommunication Devices (All Frequency Bands): Category I Equipment”
FCC Part 15 Subpart C

Conducted and radiated emissions data has been collected, reduced, and analyzed within this report in accordance with measurement guidelines set forth in the following reference standards and as outlined in National Technical Systems - Silicon Valley test procedures:

ANSI C63.10-2009
FCC DTS Measurement Guidance KDB558074

The intentional radiator above has been tested in a simulated typical installation to demonstrate compliance with the relevant Industry Canada performance and procedural standards.

Final system data was gathered in a mode that tended to maximize emissions by varying orientation of EUT, orientation of power and I/O cabling, antenna search height, and antenna polarization.

Every practical effort was made to perform an impartial test using appropriate test equipment of known calibration. All pertinent factors have been applied to reach the determination of compliance.

OBJECTIVE

The primary objective of the manufacturer is compliance with the regulations outlined in the previous section.

Prior to marketing in the USA, all unlicensed transmitters and transceivers require certification. Receive-only devices operating between 30 MHz and 960 MHz are subject to either certification or a manufacturer’s declaration of conformity, with all other receive-only devices exempt from the technical requirements.

Prior to marketing in Canada, Class I transmitters, receivers and transceivers require certification. Class II devices are required to meet the appropriate technical requirements but are exempt from certification requirements.

Certification is a procedure where the manufacturer submits test data and technical information to a certification body and receives a certificate or grant of equipment authorization upon successful completion of the certification body’s review of the submitted documents. Once the equipment authorization has been obtained, the label indicating compliance must be attached to all identical units, which are subsequently manufactured.

Maintenance of compliance is the responsibility of the manufacturer. Any modification of the product which may result in increased emissions should be checked to ensure compliance has been maintained (i.e., printed circuit board layout changes, different line filter, different power supply, harnessing or I/O cable changes, etc.).

STATEMENT OF COMPLIANCE

The tested sample of Ubiquiti Networks model AirFiber 5GHz complied with the requirements of the following regulations:

Industry Canada RSS-Gen Issue 3
RSS 210 Issue 8 “Low-power Licence-exempt Radiocommunication Devices (All Frequency Bands): Category I Equipment”
FCC Part 15 Subpart C

Maintenance of compliance is the responsibility of the manufacturer. Any modifications to the product should be assessed to determine their potential impact on the compliance status of the device with respect to the standards detailed in this test report.

The test results recorded herein are based on a single type test of Ubiquiti Networks model AirFiber 5GHz and therefore apply only to the tested sample. The sample was selected and prepared by Alex Pavlos of Ubiquiti Networks.

DEVIATIONS FROM THE STANDARDS

No deviations were made from the published requirements listed in the scope of this report.

TEST RESULTS SUMMARY**DIGITAL TRANSMISSION SYSTEMS (5725 –5850 MHz)**

FCC Rule Part	RSS Rule Part	Description	Measured Value / Comments	Limit / Requirement	Result
15.247(a)	RSS 210 A8.2	Digital Modulation	Systems uses OFDM techniques	System must utilize a digital transmission technology	Complies
15.247 (a) (2)	RSS 210 A8.2 (1)	6dB Bandwidth	47.88 MHz	>500kHz	Complies
15.247 (c)	RSS 210 A8.2 (4)	Output Power (point-point systems)	29.9 dBm (0.974 Watts) EIRP = 194.2 W ^{Note 1}	1Watt, unlimited EIRP.	Complies
15.247(d)	RSS 210 A8.2 (2)	Power Spectral Density	5.4 dBm / 10kHz	Maximum permitted is 8dBm/3kHz	Complies
15.247(c)	RSS 210 A8.5	Antenna Port Spurious Emissions – 30MHz – 40 GHz	All spurious emissions < -20dBc	< -30dBc ^{Note 2}	Complies
15.247(c) / 15.209	RSS 210 A8.5 Table 2, 3	Radiated Spurious Emissions 30MHz – 40 GHz	48.7 dB μ V/m @ 6004.6 MHz (-5.3 dB)	15.207 in restricted bands, all others <-30dBc ^{Note 2}	Complies
Note 1: EIRP calculated using antenna gain of 23 dBi for a point-to-point system.					
Note 2: Limit of -30dBc used because the power was measured using the UNII test procedure (maximum power averaged over a transmission burst).					

GENERAL REQUIREMENTS APPLICABLE TO ALL BANDS

FCC Rule Part	RSS Rule part	Description	Measured Value / Comments	Limit / Requirement	Result (margin)
15.203	-	RF Connector	Antenna is integral to the device	Unique or integral antenna required	Complies
15.207	RSS GEN Table 2	AC Conducted Emissions	51.5 dB μ V @ 0.499 MHz	Refer to page 17	Complies (- 4.5 dB)
15.109	RSS GEN 7.2.3 Table 1	Receiver spurious emissions	N/A – EUT tunes above 960MHz		
15.247 (b) (5) 15.407 (f)	RSS 102	RF Exposure Requirements	Refer to MPE calculations in Exhibit 11, RSS 102 declaration and User Manual statements.	Refer to OET 65, FCC Part 1 and RSS 102	Complies
-	RSP 100 RSS GEN 7.1.5	User Manual		Statement required regarding non-interference	Complies
-	RSP 100 RSS GEN 7.1.5	User Manual		Statement for products with detachable antenna	Complies
-	RSP 100 RSS GEN 4.4.1	99% Bandwidth	48.05 MHz	Information only	N/A

MEASUREMENT UNCERTAINTIES

ISO/IEC 17025 requires that an estimate of the measurement uncertainties associated with the emissions test results be included in the report. The measurement uncertainties given below are based on a 95% confidence level and were calculated in accordance with UKAS document LAB 34.

Measurement Type	Measurement Unit	Frequency Range	Expanded Uncertainty
RF power, conducted (power meter)	dBm	25 to 7000 MHz	± 0.52 dB
RF power, conducted (Spectrum analyzer)	dBm	25 to 7000 MHz	± 0.7 dB
Conducted emission of transmitter	dBm	25 to 26500 MHz	± 0.7 dB
Conducted emission of receiver	dBm	25 to 26500 MHz	± 0.7 dB
Radiated emission (substitution method)	dBm	25 to 26500 MHz	± 2.5 dB
Radiated emission (field strength)	dB μ V/m	25 to 1000 MHz	± 3.6 dB
		1000 to 40000 MHz	± 6.0 dB
Conducted Emissions (AC Power)	dB μ V	0.15 to 30 MHz	± 2.4 dB

EQUIPMENT UNDER TEST (EUT) DETAILS**GENERAL**

The Ubiquiti Networks model AirFiber 5GHz is a 5.8GHz Point-to-Point radio that uses OFDM with a 50MHz bandwidth. The EUT would be used outdoors and pole mounted. It is powered from a POE adapter.

The sample was received on July 31, 2013 and tested on August 1, and August 19 and 22, 2013. The EUT consisted of the following component(s):

Company	Model	Description	Serial Number	FCC ID
Ubiquiti Networks	AirFiber 5U	5.8GHz PtP radio	MAC: 02:27:22:D8:5A:0D	SWX-AF5U
Ubiquiti Networks	AirFiber 5U	5.8GHz PtP radio	MAC: 02:27:22:D8:5A:03	SWX-AF5U

OTHER EUT DETAILS

1. EUT is a 2x2 MIMO system
2. EUT transmit using a 50MHz bandwidth

ANTENNA SYSTEM

The antenna is an integral 23dBi dish antenna. The transmit antenna elements are cross polarized.

ENCLOSURE

The EUT enclosure measures approximately 93.8cm by 46.8cm by 28.1cm. It is primarily constructed of aluminum alloy and plastic.

MODIFICATIONS

No modifications were made to the EUT during the time the product was at NTS Silicon Valley.

SUPPORT EQUIPMENT

The following equipment was used as support equipment for testing:

Company	Model	Description	Serial Number	FCC ID
Ubiquiti Networks	GP-C500-120G	Switching Gigabit Power Supply	NTS 2013-4479	

The following equipment was used as remote support equipment for emissions testing:

Company	Model	Description	Serial Number	FCC ID
ASUS	S550CA.DS51T	Laptop	D3NDCV33197013 4	
-	Universal Serial Bus	USB-Four Serial Converter		

EUT INTERFACE PORTS

The I/O cabling configuration during testing was as follows:

Port	Connected To	Description	Cable(s)	
			Shielded or Unshielded	Length(m)
Laptop	POE (LAN)	RJ45	Shielded	7.2
EUT	POE (POE)	RJ45	Shielded	8.2
Laptop	Universal Serial Bus	USB		1.8
Universal Serial Bus	EUT	RJ11	Unshielded	1.8

EUT OPERATION

During testing, the EUT was configured to transmit continuously on the noted channel. It was determined that the lowest data rate supported, 1x QPSK, resulted in the highest output power. Therefore, this data rate was used for all tests.

TEST SITE**GENERAL INFORMATION**

Final test measurements were taken at the test sites listed below. Pursuant to section 2.948 of the FCC's Rules and section 3.3 of RSP-100, construction, calibration, and equipment data has been filed with the Commission and with industry Canada.

Site	Registration Numbers		Location
	FCC	Canada	
Chamber 4	211948	2845B-4	41039 Boyce Road Fremont, CA 94538-2435
Chamber 7	A2LA accreditation	2845B-7	

ANSI C63.4 recommends that ambient noise at the test site be at least 6 dB below the allowable limits. Ambient levels are below this requirement. The test site(s) contain separate areas for radiated and conducted emissions testing. Considerable engineering effort has been expended to ensure that the facilities conform to all pertinent requirements of ANSI C63.4.

CONDUCTED EMISSIONS CONSIDERATIONS

Conducted emissions testing is performed in conformance with ANSI C63.10. Measurements are made with the EUT connected to the public power network through a nominal, standardized RF impedance, which is provided by a line impedance stabilization network, known as a LISN. A LISN is inserted in series with each current-carrying conductor in the EUT power cord.

RADIATED EMISSIONS CONSIDERATIONS

The FCC has determined that radiation measurements made in a shielded enclosure are not suitable for determining levels of radiated emissions. Radiated measurements are performed in an open field environment or in a semi-anechoic chamber. The test sites are maintained free of conductive objects within the CISPR defined elliptical area incorporated in ANSI C63.4 guidelines and meet the Normalized Site Attenuation (NSA) requirements of ANSI C63.4.

MEASUREMENT INSTRUMENTATION

RECEIVER SYSTEM

An EMI receiver as specified in CISPR 16-1-1 is used for emissions measurements. The receivers used can measure over the frequency range of 9 kHz up to 2000 MHz. These receivers allow both ease of measurement and high accuracy to be achieved. The receivers have Peak, Average, and CISPR (Quasi-peak) detectors built into their design so no external adapters are necessary. The receiver automatically sets the required bandwidth for the CISPR detector used during measurements. If the repetition frequency of the signal being measured is below 20Hz, peak measurements are made in lieu of Quasi-Peak measurements.

For measurements above the frequency range of the receivers, a spectrum analyzer is utilized because it provides visibility of the entire spectrum along with the precision and versatility required to support engineering analysis. Average measurements above 1000MHz are performed on the spectrum analyzer using the linear-average method with a resolution bandwidth of 1 MHz and a video bandwidth of 10 Hz, unless the signal is pulsed in which case the average (or video) bandwidth of the measuring instrument is reduced to onset of pulse desensitization and then increased.

INSTRUMENT CONTROL COMPUTER

The receivers utilize either a Rohde & Schwarz EZM Spectrum Monitor/Controller or contain an internal Spectrum Monitor/Controller to view and convert the receiver measurements to the field strength at an antenna or voltage developed at the LISN measurement port, which is then compared directly with the appropriate specification limit. This provides faster, more accurate readings by performing the conversions described under Sample Calculations within the Test Procedures section of this report. Results are printed in a graphic and/or tabular format, as appropriate. A personal computer is used to record all measurements made with the receivers.

The Spectrum Monitor provides a visual display of the signal being measured. In addition, the controller or a personal computer run automated data collection programs which control the receivers. This provides added accuracy since all site correction factors, such as cable loss and antenna factors are added automatically.

LINE IMPEDANCE STABILIZATION NETWORK (LISN)

Line conducted measurements utilize a fifty microhenry Line Impedance Stabilization Network as the monitoring point. The LISN used also contains a 250 uH CISPR adapter. This network provides for calibrated radio frequency noise measurements by the design of the internal low pass and high pass filters on the EUT and measurement ports, respectively.

FILTERS/ATTENUATORS

External filters and precision attenuators are often connected between the receiving antenna or LISN and the receiver. This eliminates saturation effects and non-linear operation due to high amplitude transient events.

ANTENNAS

A loop antenna is used below 30 MHz. For the measurement range 30 MHz to 1000 MHz either a combination of a biconical antenna and a log periodic or a bi-log antenna is used. Above 1000 MHz, horn antennas are used. The antenna calibration factors to convert the received voltage to an electric field strength are included with appropriate cable loss and amplifier gain factors to determine an overall site factor, which is then programmed into the test receivers or incorporated into the test software.

ANTENNA MAST AND EQUIPMENT TURNTABLE

The antennas used to measure the radiated electric field strength are mounted on a non-conductive antenna mast equipped with a motor-drive to vary the antenna height. Measurements below 30 MHz are made with the loop antenna at a fixed height of 1m above the ground plane.

ANSI C63.10 specifies that the test height above ground for table mounted devices shall be 80 centimeters. Floor mounted equipment shall be placed on the ground plane if the device is normally used on a conductive floor or separated from the ground plane by insulating material from 3 to 12 mm if the device is normally used on a non-conductive floor as specified in ANSI C63.4. During radiated measurements, the EUT is positioned on a motorized turntable in conformance with this requirement.

INSTRUMENT CALIBRATION

All test equipment is regularly checked to ensure that performance is maintained in accordance with the manufacturer's specifications. All antennas are calibrated at regular intervals with respect to tuned half-wave dipoles. An exhibit of this report contains the list of test equipment used and calibration information.

TEST PROCEDURES

EUT AND CABLE PLACEMENT

The regulations require that interconnecting cables be connected to the available ports of the unit and that the placement of the unit and the attached cables simulate the worst case orientation that can be expected from a typical installation, so far as practicable. To this end, the position of the unit and associated cabling is varied within the guidelines of ANSI C63.10, and the worst-case orientation is used for final measurements.

CONDUCTED EMISSIONS

Conducted emissions are measured at the plug end of the power cord supplied with the EUT. Excess power cord length is wrapped in a bundle between 30 and 40 centimeters in length near the center of the cord. Preliminary measurements are made to determine the highest amplitude emission relative to the specification limit for all the modes of operation. Placement of system components and varying of cable positions are performed in each mode. A final peak mode scan is then performed in the position and mode for which the highest emission was noted on all current carrying conductors of the power cord.

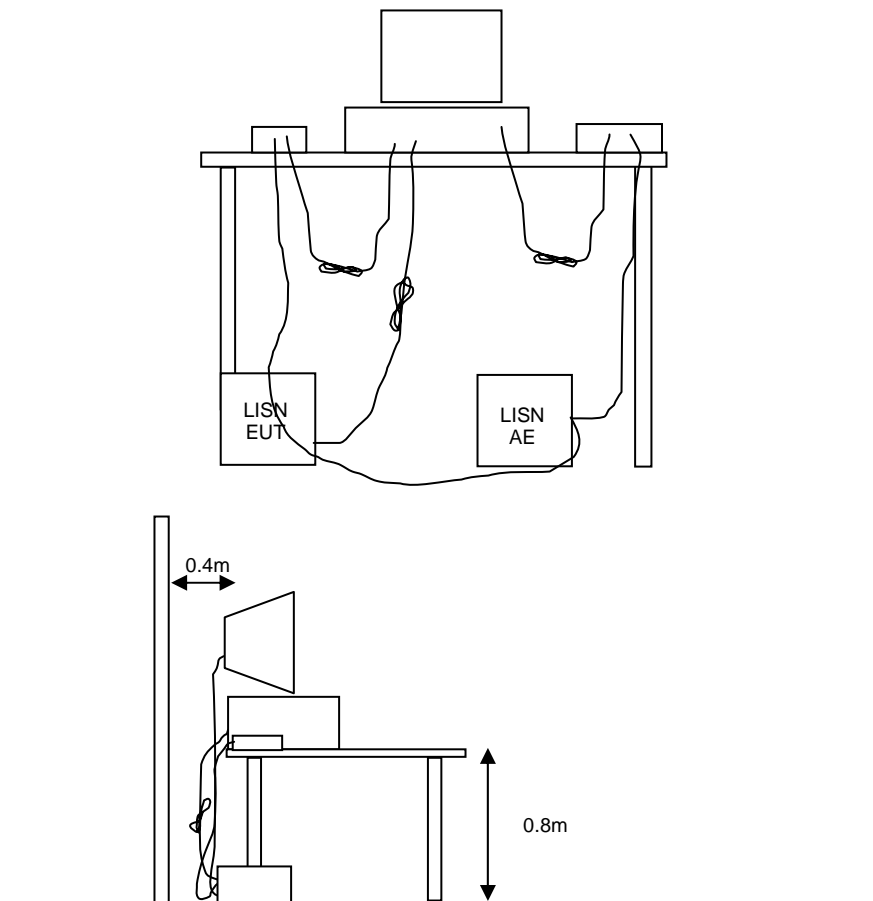

Figure 1 Typical Conducted Emissions Test Configuration

RADIATED EMISSIONS

A preliminary scan of the radiated emissions is performed in which all significant EUT frequencies are identified with the system in a nominal configuration. At least two scans are performed, one scan for each antenna polarization (horizontal and vertical; loop parallel and perpendicular to the EUT). During the preliminary scans, the EUT is rotated through 360°, the antenna height is varied (for measurements above 30 MHz) and cable positions are varied to determine the highest emission relative to the limit. Preliminary scans may be performed in a fully anechoic chamber for the purposes of identifying the frequencies of the highest emissions from the EUT.

A speaker is provided in the receiver to aid in discriminating between EUT and ambient emissions. Other methods used during the preliminary scan for EUT emissions involve scanning with near field magnetic loops, monitoring I/O cables with RF current clamps, and cycling power to the EUT.

Final maximization is a phase in which the highest amplitude emissions identified in the spectral search are viewed while the EUT azimuth angle is varied from 0 to 360 degrees relative to the receiving antenna. The azimuth, which results in the highest emission is then maintained while varying the antenna height from one to four meters (for measurements above 30 MHz, measurements below 30 MHz are made with the loop antenna at a fixed height of 1m). The result is the identification of the highest amplitude for each of the highest peaks. Each recorded level is corrected in the receiver using appropriate factors for cables, connectors, antennas, and preamplifier gain.

When testing above 18 GHz, the receive antenna is located at 1meter from the EUT and the antenna height is restricted to a maximum of 2.5 meters.

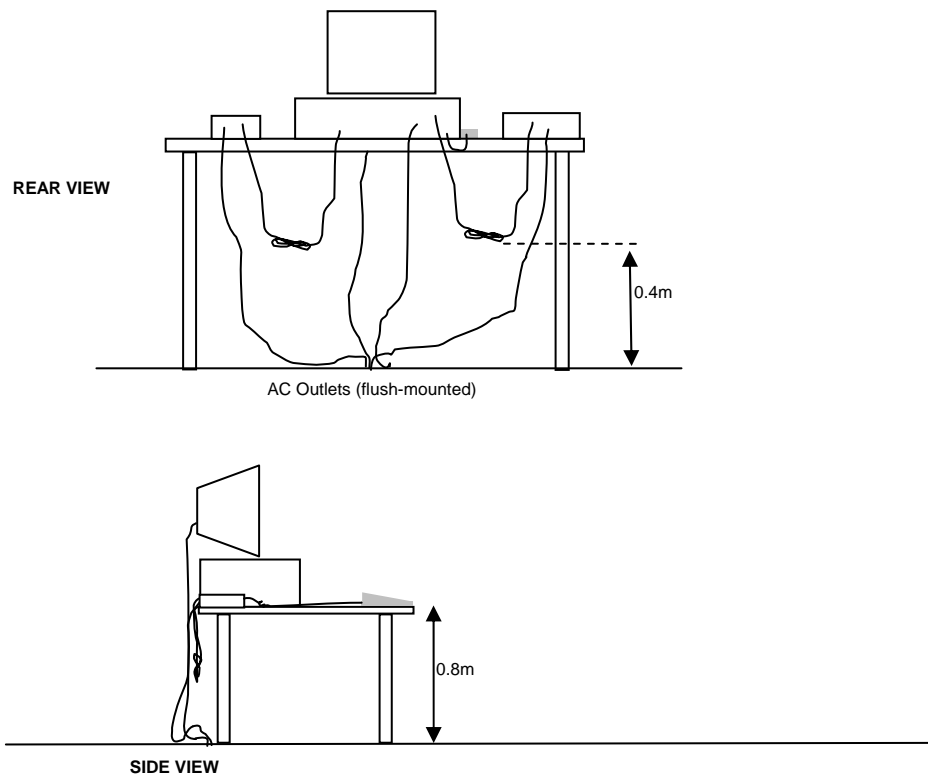

Typical Test Configuration for Radiated Field Strength Measurements

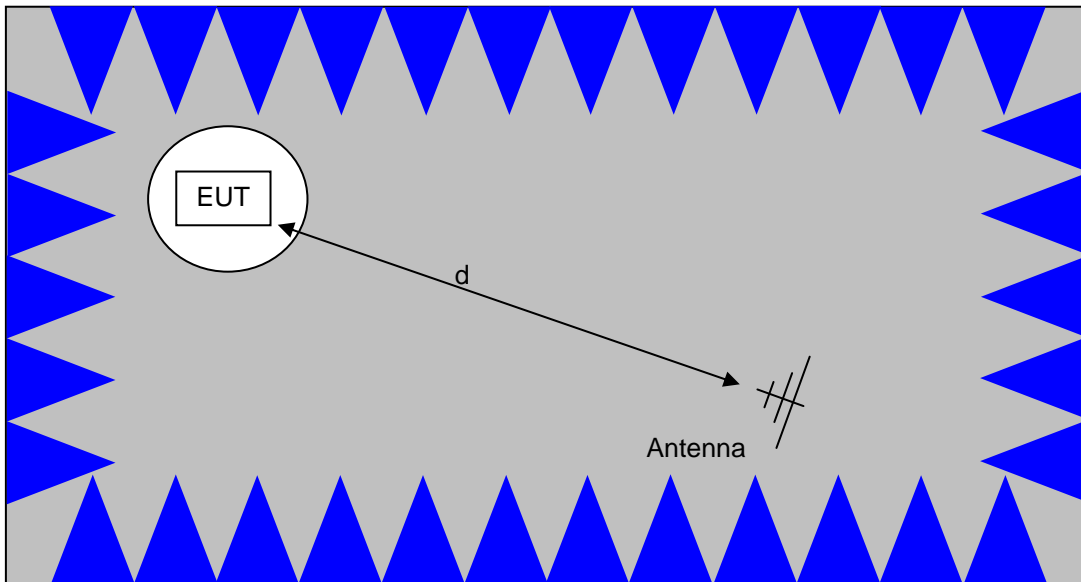

The anechoic materials on the walls and ceiling ensure compliance with the normalized site attenuation requirements of CISPR 16 / CISPR 22 / ANSI C63.4 for an alternate test site at the measurement distances used.

Floor-standing equipment is placed on the floor with insulating supports between the unit and the ground plane.

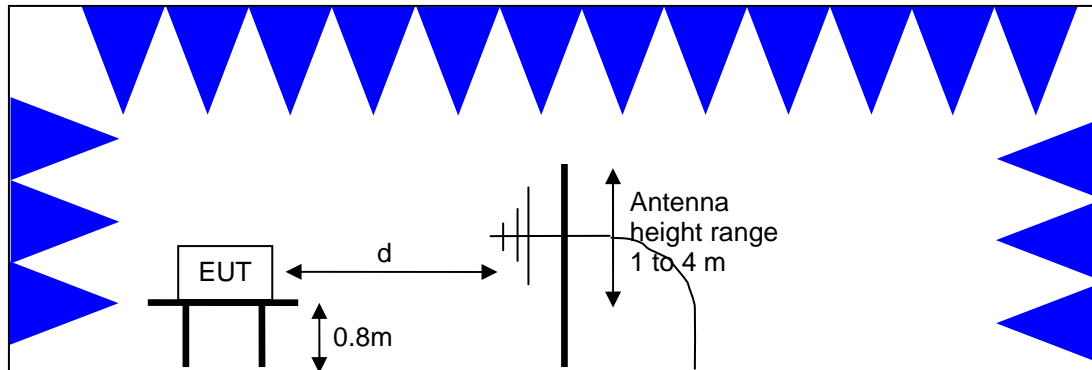

Test Configuration for Radiated Field Strength Measurements
Semi-Anechoic Chamber, Plan and Side Views

CONDUCTED EMISSIONS FROM ANTENNA PORT

Direct measurements of power, bandwidth and power spectral density are performed, where possible, with the antenna port of the EUT connected to either the power meter or spectrum analyzer via a suitable attenuator and/or filter. These are used to ensure that the front end of the measurement instrument is not overloaded by the fundamental transmission.

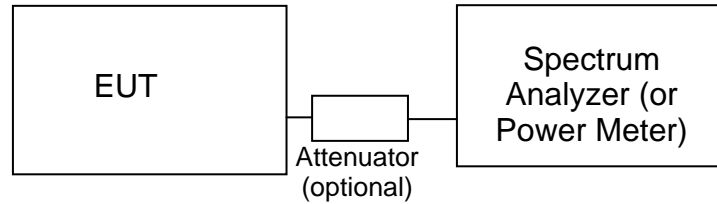
**Test Configuration for Antenna Port Measurements**

Measurement bandwidths (video and resolution) are set in accordance with the relevant standards and NTS Silicon Valley's test procedures for the type of radio being tested. When power measurements are made using a resolution bandwidth less than the signal bandwidth the power is calculated by summing the power across the signal bandwidth using either the analyzer channel power function or by capturing the trace data and calculating the power using software. In both cases the summed power is corrected to account for the equivalent noise bandwidth (ENBW) of the resolution bandwidth used.

If power averaging is used (typically for certain digital modulation techniques), the EUT is configured to transmit continuously. Power averaging is performed using either the built-in function of the analyzer or, if the analyzer does not feature power averaging, using external software. In both cases the average power is calculated over a number of sweeps (typically 100). When the EUT cannot be configured to continuously transmit then either the analyzer is configured to perform a gated sweep to ensure that the power is averaged over periods that the device is transmitting or power averaging is disabled and a max-hold feature is used.

If a power meter is used to make output power measurements the sensor head type (peak or average) is stated in the test data table.

BANDWIDTH MEASUREMENTS

The 6dB, 20dB, 26dB and/or 99% signal bandwidth are measured using the bandwidths recommended by ANSI C63.10 and RSS GEN.

SPECIFICATION LIMITS AND SAMPLE CALCULATIONS

The limits for conducted emissions are given in units of microvolts, and the limits for radiated emissions are given in units of microvolts per meter at a specified test distance. Data is measured in the logarithmic form of decibels relative to one microvolt, or dB microvolts (dBuV). For radiated emissions, the measured data is converted to the field strength at the antenna in dB microvolts per meter (dBuV/m). The results are then converted to the linear forms of uV and uV/m for comparison to published specifications.

For reference, converting the specification limits from linear to decibel form is accomplished by taking the base ten logarithm, then multiplying by 20. These limits in both linear and logarithmic form are as follows:

CONDUCTED EMISSIONS SPECIFICATION LIMITS: FCC 15.207; FCC 15.107(a), RSS GEN

The table below shows the limits for the emissions on the AC power line from an intentional radiator and a receiver.

Frequency (MHz)	Average Limit (dBuV)	Quasi Peak Limit (dBuV)
0.150 to 0.500	Linear decrease on logarithmic frequency axis between 56.0 and 46.0	Linear decrease on logarithmic frequency axis between 66.0 and 56.0
0.500 to 5.000	46.0	56.0
5.000 to 30.000	50.0	60.0

GENERAL TRANSMITTER RADIATED EMISSIONS SPECIFICATION LIMITS

The table below shows the limits for the spurious emissions from transmitters that fall in restricted bands¹ (with the exception of transmitters operating under FCC Part 15 Subpart D and RSS 210 Annex 9), the limits for all emissions from a low power device operating under the general rules of RSS 310 (tables 3 and 4), RSS 210 (table 2) and FCC Part 15 Subpart C section 15.209.

Frequency Range (MHz)	Limit (uV/m)	Limit (dBuV/m @ 3m)
0.009-0.490	2400/F _{KHz} @ 300m	67.6-20*log ₁₀ (F _{KHz}) @ 300m
0.490-1.705	24000/F _{KHz} @ 30m	87.6-20*log ₁₀ (F _{KHz}) @ 30m
1.705 to 30	30 @ 30m	29.5 @ 30m
30 to 88	100 @ 3m	40 @ 3m
88 to 216	150 @ 3m	43.5 @ 3m
216 to 960	200 @ 3m	46.0 @ 3m
Above 960	500 @ 3m	54.0 @ 3m

OUTPUT POWER LIMITS – DIGITAL TRANSMISSION SYSTEMS

The table below shows the limits for output power and output power density. Where the signal bandwidth is less than 20 MHz the maximum output power is reduced to the power spectral density limit plus 10 times the log of the bandwidth (in MHz).

Operating Frequency (MHz)	Output Power	Power Spectral Density
902 – 928	1 Watt (30 dBm)	8 dBm/3kHz
2400 – 2483.5	1 Watt (30 dBm)	8 dBm/3kHz
5725 – 5850	1 Watt (30 dBm)	8 dBm/3kHz

The maximum permitted output power is reduced by 1dB for every dB the antenna gain exceeds 6dBi. Fixed point-to-point applications using the 5725 – 5850 MHz band are not subject to this restriction.

TRANSMIT MODE SPURIOUS RADIATED EMISSIONS LIMITS – FHSS and DTS SYSTEMS

The limits for unwanted (spurious) emissions from the transmitter falling in the restricted bands are those specified in the general limits sections of FCC Part 15 and RSS 210. All other unwanted (spurious) emissions shall be at least 20dB below the level of the highest in-band signal level (30dB if the power is measured using the sample detector/power averaging method).

¹ The restricted bands are detailed in FCC 15.203, RSS 210 Table 1 and RSS 310 Table 2

SAMPLE CALCULATIONS - CONDUCTED EMISSIONS

Receiver readings are compared directly to the conducted emissions specification limit (decibel form) as follows:

$$R_r - S = M$$

where:

R_r = Receiver Reading in dBuV

S = Specification Limit in dBuV

M = Margin to Specification in +/- dB

SAMPLE CALCULATIONS - RADIATED EMISSIONS

Receiver readings are compared directly to the specification limit (decibel form). The receiver internally corrects for cable loss, preamplifier gain, and antenna factor. The calculations are in the reverse direction of the actual signal flow, thus cable loss is added and the amplifier gain is subtracted. The Antenna Factor converts the voltage at the antenna coaxial connector to the field strength at the antenna elements.

A distance factor, when used for electric field measurements above 30MHz, is calculated by using the following formula:

$$F_d = 20 * \text{LOG}_{10} (D_m/D_s)$$

where:

F_d = Distance Factor in dB

D_m = Measurement Distance in meters

D_s = Specification Distance in meters

For electric field measurements below 30MHz the extrapolation factor is either determined by making measurements at multiple distances or a theoretical value is calculated using the formula:

$$F_d = 40 * \text{LOG}_{10} (D_m/D_s)$$

Measurement Distance is the distance at which the measurements were taken and Specification Distance is the distance at which the specification limits are based. The antenna factor converts the voltage at the antenna coaxial connector to the field strength at the antenna elements.

The margin of a given emission peak relative to the limit is calculated as follows:

$$R_c = R_r + F_d$$

and

$$M = R_c - L_s$$

where:

R_r = Receiver Reading in dBuV/m

F_d = Distance Factor in dB

R_c = Corrected Reading in dBuV/m

L_S = Specification Limit in dBuV/m

M = Margin in dB Relative to Spec

SAMPLE CALCULATIONS - FIELD STRENGTH TO EIRP CONVERSION

Where the radiated electric field strength is expressed in terms of the equivalent isotropic radiated power (eirp), or where a field strength measurement of output power is made in lieu of a direct measurement, the following formula is used to convert between eirp and field strength at a distance of d (meters) from the equipment under test:

$$E = \frac{1000000 \sqrt{30 P}}{d} \quad \text{microvolts per meter}$$

where P is the eirp (Watts)

For a measurement at 3m the conversion from a logarithmic value for field strength (dBuV/m) to an eirp power (dBm) is -95.3dB.

Appendix A Test Equipment Calibration Data

T92983 (FCC_IC)

<u>Manufacturer</u>	<u>Description</u>	<u>Model</u>	<u>Asset #</u>	<u>Cal Due</u>
Radiated Emissions, 1,000 - 40,000 MHz, 19-Aug-13				
EMCO	Antenna, Horn, 1-18 GHz	3115	487	7/19/2014
Hewlett Packard	Microwave Preamplifier, 1-26.5GHz	8449B	785	11/9/2013
Hewlett Packard	Head (Inc flex cable, 1143, 2198) Red	84125C	1145	6/26/2014
Hewlett Packard	SpecAn 30 Hz -40 GHz, SV (SA40) Red	8564E (84125C)	1148	9/14/2013
Hewlett Packard	High Pass filter, 8.2 GHz (Blue System)	P/N 84300-80039 (84125C)	1392	5/14/2014
Micro-Tronics	Band Reject Filter, 5725-5875 MHz	BRC50705-02	1682	3/13/2014
A. H. Systems	Spare System Horn, 18-40GHz	SAS-574, p/n: 2581	2162	7/24/2014
Conducted Emissions - AC Power Ports, 01-Aug-13				
EMCO	LISN, 10 kHz-100 MHz	3825/2	1293	14-Feb-14
Rohde & Schwarz	Pulse Limiter	ESH3 Z2	1401	15-May-14
Rohde & Schwarz	EMI Test Receiver, 20 Hz-7 GHz	ESIB7	1538	12-Dec-13

T92983 (FCC_IC_RF Conducted)

<u>Manufacturer</u>	<u>Description</u>	<u>Model</u>	<u>Asset #</u>	<u>Cal Due</u>
Radio Antenna Port (Power and Spurious Emissions), 22-Aug-13				
Agilent Technologies	PSA, Spectrum Analyzer, (installed options, 111, 115, 123, 1DS, B7J, HYX,	E4446A	2139	3/7/2014

Appendix B Test Data

T92983 (FCC_IC) Pages 23 – 35
T92983 (FCC_IC_RF Conducted) Pages 36 – 51



EMC Test Data

Client:	Ubiquiti Networks	Job Number:	J92977
Product:	AirFiber 5GHz	T-Log Number:	T92983
		Project Manager:	Christine Krebill
Contact:	Alex Pavlos	Project Coordinator:	Irene Rademacher
Emissions Standard(s):	FCC 15.247	Class:	-
Immunity Standard(s):	-	Environment:	-

EMC Test Data

For The

Ubiquiti Networks

Product

AirFiber 5GHz

Date of Last Test: 8/19/2013



EMC Test Data

Client: Ubiquiti Networks	Job Number: J92977
Model: AirFiber 5GHz	T-Log Number: T92983
	Project Manager: Christine Krebill
Contact: Alex Pavlos	Project Coordinator: Irene Rademacher
Standard: FCC 15.247	Class: N/A

RSS 210 and FCC 15.247 (DTS) Radiated Spurious Emissions

Test Specific Details

Objective: The objective of this test session is to perform final qualification testing of the EUT with respect to the specification listed above.

General Test Configuration

The EUT and all local support equipment were located on the turntable for radiated spurious emissions testing. All remote support equipment was located approximately 30 meters from the EUT with all I/O connections running on top of the groundplane or routed in overhead in the GR-1089 test configuration.

For radiated emissions testing the measurement antenna was located 3 meters from the EUT.

Ambient Conditions:

Temperature: 20.7 °C
 Rel. Humidity: 38 %

Summary of Results - Device Operating in the 5725 - 5850 MHz Band

Run #	Mode	Channel	Power Setting	Measured Power	Test Performed	Limit	Result / Margin
1a	50MHz	5752	-	-	Radiated Emissions, 1 - 40GHz	FCC Part 15.209 / 15.247(c)	46.7 dBµV/m @ 20625.2 MHz (-7.3 dB)
1b	50MHz	5800	-	-	Radiated Emissions, 1 - 40GHz	FCC Part 15.209 / 15.247(c)	48.7 dBµV/m @ 6004.6 MHz (-5.3 dB)
1c	50MHz	5823	-	-	Radiated Emissions, 1 - 40GHz	FCC Part 15.209 / 15.247(c)	45.9 dBµV/m @ 12375.1 MHz (-8.1 dB)

Modifications Made During Testing

No modifications were made to the EUT during testing

Deviations From The Standard

No deviations were made from the requirements of the standard.



EMC Test Data

Client: Ubiquiti Networks	Job Number: J92977
Model: AirFiber 5GHz	T-Log Number: T92983
	Project Manager: Christine Krebill
Contact: Alex Pavlos	Project Coordinator: Irene Rademacher
Standard: FCC 15.247	Class: N/A

Procedure Comments:

Measurements performed in accordance with FCC KDB 558074 v03r01, dated April 9, 2013

Peak measurements performed with: RBW=1MHz, VBW=3MHz, peak detector, max hold, auto sweep time

Unless otherwise stated/noted, emission has duty cycle $\geq 98\%$ and was measured using RBW=1MHz, VBW=10Hz, peak detector, linear average mode, auto sweep time, max hold.

5.8GHz band reject filter used

Preliminary testing showed no radio related emissions below 1GHz.

Mode	Data Rate	Duty Cycle (x)	Constant DC?	T (ms)	Pwr Cor Factor*	Lin Volt Cor Factor**	Min VBW for FS (Hz)
OFDM 50MHz	1x QPSK	0.49	Yes	0.98	3.1	6.2	1020.4082

Sample Notes

MAC Address: 02:27:22:D8:5A:03

Driver: 2.0 Dev 18481

POE S/N: NTS 2013-4479

Antenna: Integral dish

Measurement Specific Notes:

Note 1:	Emission in non-restricted band, but limit of 15.209 used.
Note 2:	Emission in non-restricted band. Refer to antenna conducted measurements.
Note 3:	Emission has duty cycle $\geq 98\%$, average measurement performed: RBW=1MHz, VBW=3MHz, RMS, Power averaging, auto sweep, trace average 100 traces
Note 4:	Emission has duty cycle $< 98\%$, but constant, average measurement performed: RBW=1MHz, VBW=10Hz, peak detector, linear averaging, auto sweep, trace average 100 traces, measurement corrected by Linear Voltage correction factor
Note 5:	Emission has duty cycle $< 98\%$ and is NOT constant, average measurement performed: RBW=1MHz, VBW $> 1/T$, peak detector, linear average mode, sweep time auto, max hold. Max hold for $50 \cdot (1/DC)$ traces
Note 6:	Emission has duty cycle $< 98\%$, but constant, average measurement performed: RBW=1MHz, VBW=3MHz, RMS, Power averaging, auto sweep, trace average 100 traces, measurement corrected by Pwr correction factor
Note 7:	Plots of the average and peak bandedge do not account for any duty cycle correction. Refer to the tabluar results for final measurements.



EMC Test Data

Client: Ubiquiti Networks	Job Number: J92977
Model: AirFiber 5GHz	T-Log Number: T92983
	Project Manager: Christine Krebill
Contact: Alex Pavlos	Project Coordinator: Irene Rademacher
Standard: FCC 15.247	Class: N/A

Run #1: Radiated Spurious Emissions, 30 - 40000 MHz.

Date of Test: 8/19/2013

Test Engineer: Jack Liu / Rafael Varelas

Test Location: FT Chamber #4

Run #1a: Low Channel @ 5752MHz

Other Spurious Emissions

Frequency MHz	Level dB μ V/m	Pol v/h	15.209 / 15.247		Detector Pk/QP/Avg	Azimuth degrees	Height meters	Comments
			Limit	Margin				
20625.170	46.7	H	54.0	-7.3	AVG	140	1.8	RB 1 MHz;VB 10 Hz;Peak
12375.030	46.4	H	54.0	-7.6	AVG	175	1.1	RB 1 MHz;VB 10 Hz;Peak
1623.990	38.1	H	54.0	-15.9	AVG	186	1.0	Note 4
20625.730	56.1	H	74.0	-17.9	PK	140	1.8	RB 1 MHz;VB 3 MHz;Peak
12374.470	54.7	H	74.0	-19.3	PK	175	1.1	RB 1 MHz;VB 3 MHz;Peak
1624.330	39.8	H	74.0	-34.2	PK	186	1.0	RB 1 MHz;VB 3 MHz;Peak
6120.310	49.3	V	-	-	PK	355	1.4	Note2 RB 100 kHz;VB 300 kHz;Pk
5984.520	55.1	V	-	-	PK	0	1.5	Note2 RB 100 kHz;VB 300 kHz;Pk
5607.010	53.2	V	-	-	PK	5	1.5	Note2 RB 100 kHz;VB 300 kHz;Pk

Note: Scans made between 18 - 40 GHz with the measurement antenna moved around the EUT, 1m from the device indicated emissions in this frequency range. Final measurement test at 3m.

Client: Ubiquiti Networks	Job Number: J92977
Model: AirFiber 5GHz	T-Log Number: T92983
Contact: Alex Pavlos	Project Manager: Christine Krebill
Standard: FCC 15.247	Project Coordinator: Irene Rademacher
	Class: N/A

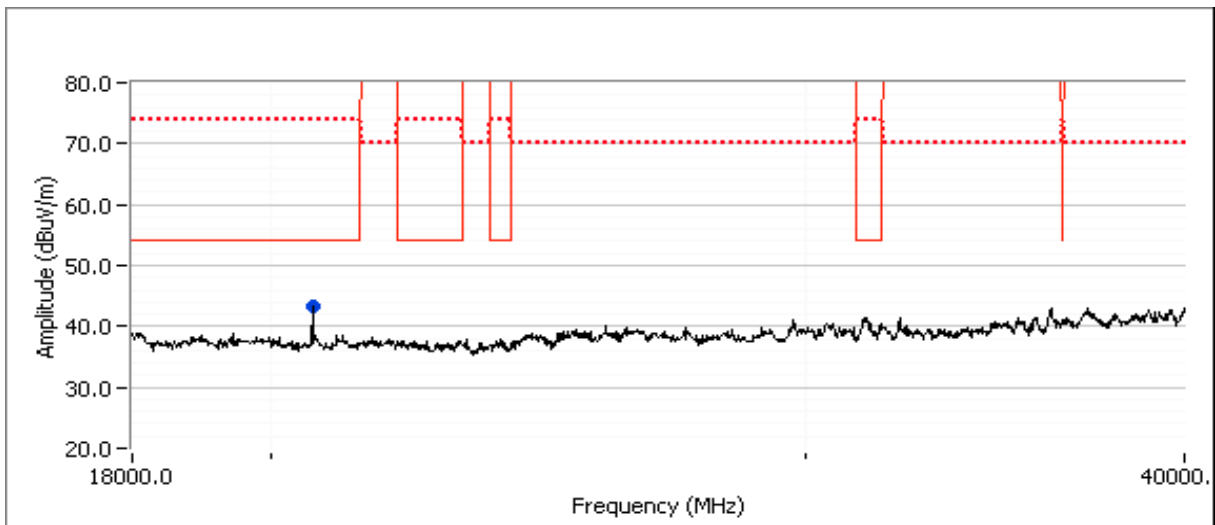
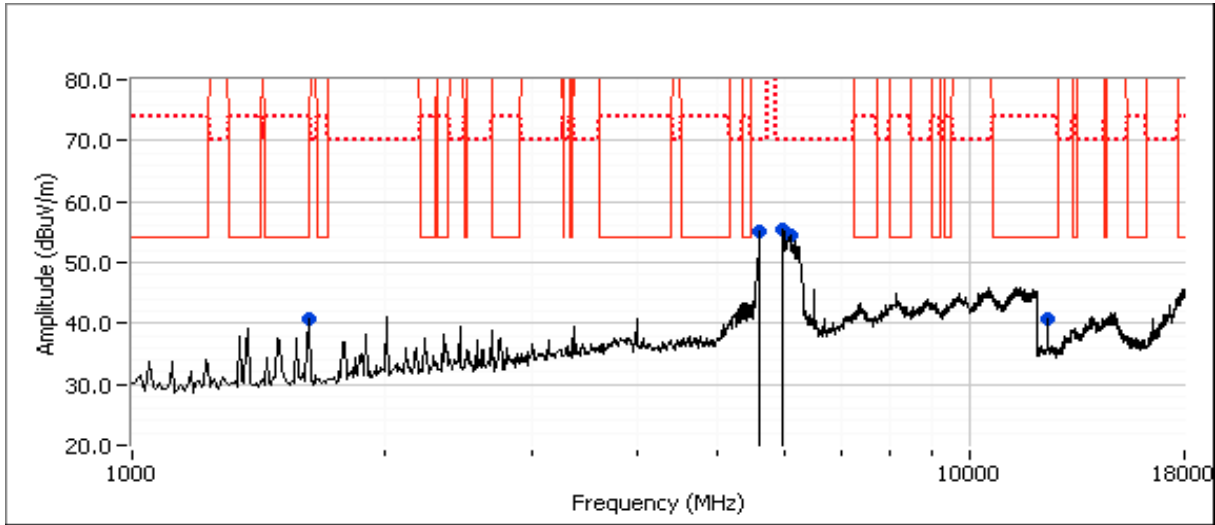



EMC Test Data

Client: Ubiquiti Networks	Job Number: J92977
Model: AirFiber 5GHz	T-Log Number: T92983
	Project Manager: Christine Krebill
Contact: Alex Pavlos	Project Coordinator: Irene Rademacher
Standard: FCC 15.247	Class: N/A

Run #1b: Center Channel @ 5800

Channel: 5800MHz
 Tx Chain: A+B
 Mode: OFDM
 Data Rate: 1xQPSK

Other Spurious Emissions

Frequency MHz	Level dB μ V/m	Pol v/h	15.209 / 15.247		Detector Pk/QP/Avg	Azimuth degrees	Height meters	Comments
			Limit	Margin				
6004.570	48.7	V	54.0	-5.3	AVG	0	1.9	Note 1 & 4
12375.010	47.2	H	54.0	-6.8	AVG	164	1.0	RB 1 MHz;VB 10 Hz;Peak
20875.100	44.3	H	54.0	-9.7	AVG	138	1.0	RB 1 MHz;VB 10 Hz;Peak
3999.950	39.2	H	54.0	-14.8	AVG	197	2.4	
1625.060	39.2	H	54.0	-14.8	AVG	204	2.2	
5999.950	55.8	V	74.0	-18.2	PK	0	1.9	Note 1
12374.900	55.5	H	74.0	-18.5	PK	164	1.0	RB 1 MHz;VB 3 MHz;Peak
20874.950	52.9	H	74.0	-21.1	PK	138	1.0	RB 1 MHz;VB 3 MHz;Peak
4000.090	47.8	H	74.0	-26.2	PK	197	2.4	
1625.060	44.8	H	74.0	-29.2	PK	204	2.2	
5592.370	53.4	H	-	-	PK	359	1.4	Note2 RB 100 kHz;VB 300 kHz;Pk
6151.370	53.6	H	-	-	PK	355	1.5	Note2 RB 100 kHz;VB 300 kHz;Pk

Note: Scans made between 18 - 40 GHz with the measurement antenna moved around the EUT, 1m from the device indicated emissions in this frequency range. Final measurement test at 3m.

Client: Ubiquiti Networks	Job Number: J92977
Model: AirFiber 5GHz	T-Log Number: T92983
Contact: Alex Pavlos	Project Manager: Christine Krebill
Standard: FCC 15.247	Project Coordinator: Irene Rademacher
	Class: N/A

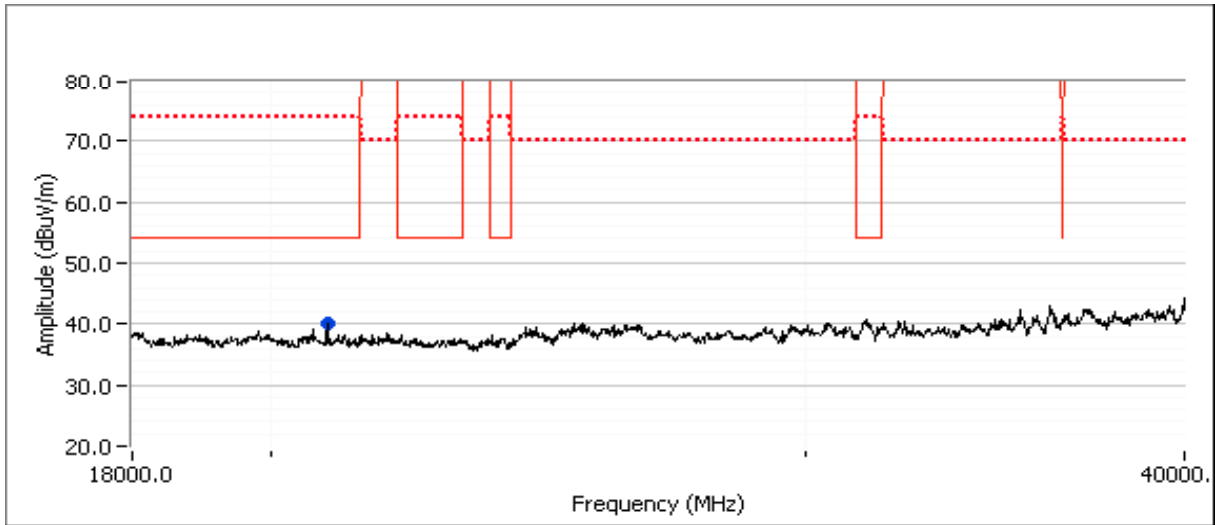
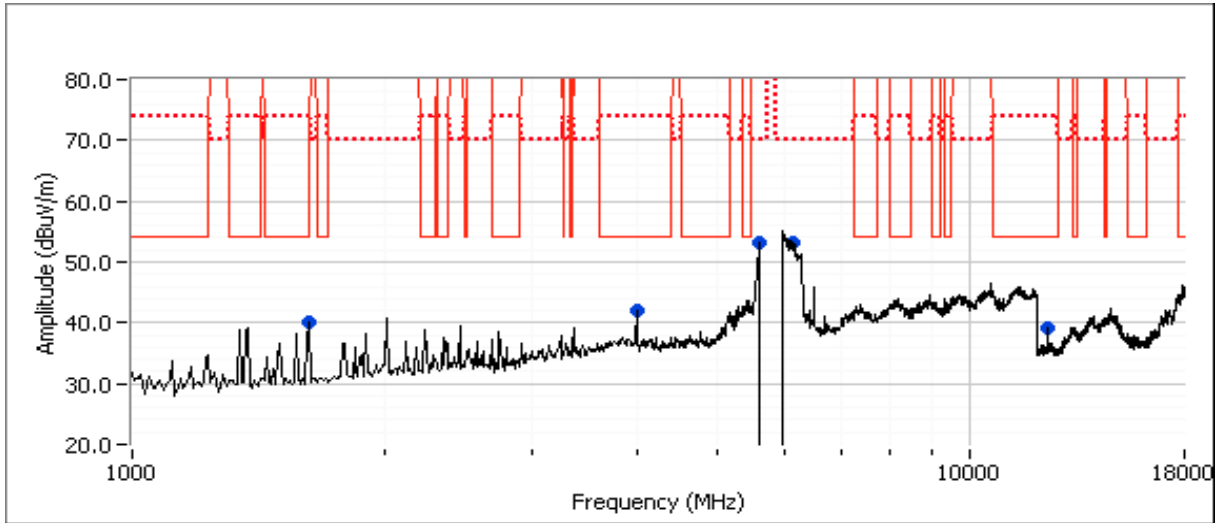



EMC Test Data

Client: Ubiquiti Networks	Job Number: J92977
Model: AirFiber 5GHz	T-Log Number: T92983
	Project Manager: Christine Krebill
Contact: Alex Pavlos	Project Coordinator: Irene Rademacher
Standard: FCC 15.247	Class: N/A

Run #1c: High Channel @ 5823

Channel: 5823MHz
 Tx Chain: A+B
 Mode: OFDM
 Data Rate: 1xQPSK

Other Spurious Emissions

Frequency MHz	Level dB μ V/m	Pol v/h	15.209 / 15.247		Detector Pk/QP/Avg	Azimuth degrees	Height meters	Comments
			Limit	Margin				
12375.130	45.9	H	54.0	-8.1	AVG	155	1.0	RB 1 MHz;VB 10 Hz;Peak
21000.100	45.5	H	54.0	-8.5	AVG	139	1.8	RB 1 MHz;VB 10 Hz;Peak
1625.020	40.0	H	54.0	-14.0	AVG	206	1.9	
12375.230	54.5	H	74.0	-19.5	PK	155	1.0	RB 1 MHz;VB 3 MHz;Peak
21000.330	54.0	H	74.0	-20.0	PK	139	1.8	RB 1 MHz;VB 3 MHz;Peak
1625.190	44.5	H	74.0	-29.5	PK	206	1.9	
6085.540	51.4	V	-	-	PK	353	1.6	Note2 RB 100 kHz;VB 300 kHz;Pk
5992.090	64.0	V	-	-	PK	353	1.5	Note2 RB 100 kHz;VB 300 kHz;Pk
5604.270	54.9	V	-	-	PK	354	1.5	Note2 RB 100 kHz;VB 300 kHz;Pk

Note: Scans made between 18 - 40 GHz with the measurement antenna moved around the EUT, 1m from the device indicated emissions in this frequency range. Final measurement test at 3m.

Client: Ubiquiti Networks	Job Number: J92977
Model: AirFiber 5GHz	T-Log Number: T92983
Contact: Alex Pavlos	Project Manager: Christine Krebill
Standard: FCC 15.247	Project Coordinator: Irene Rademacher
	Class: N/A

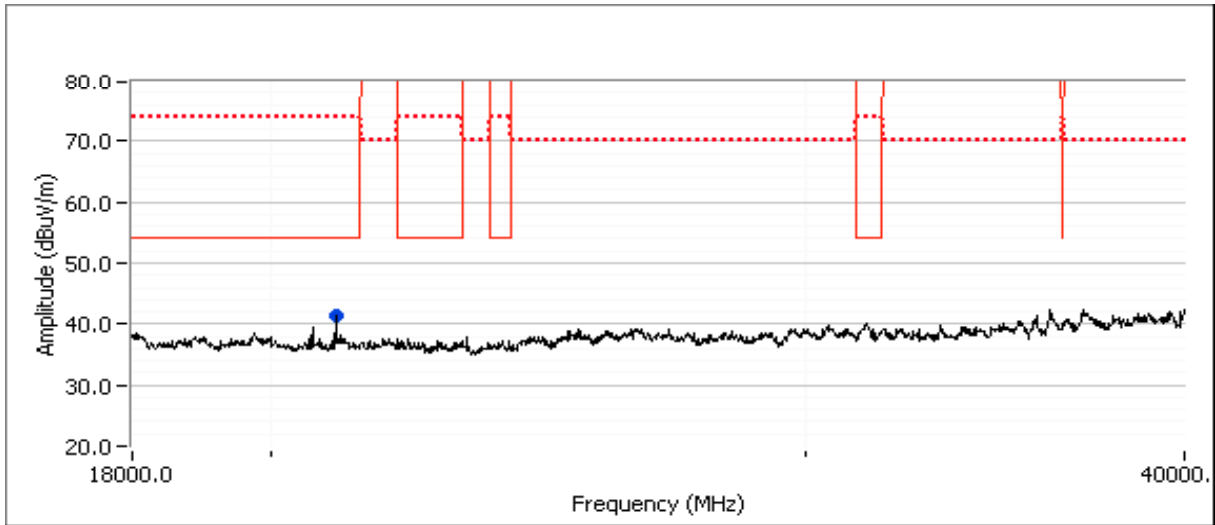
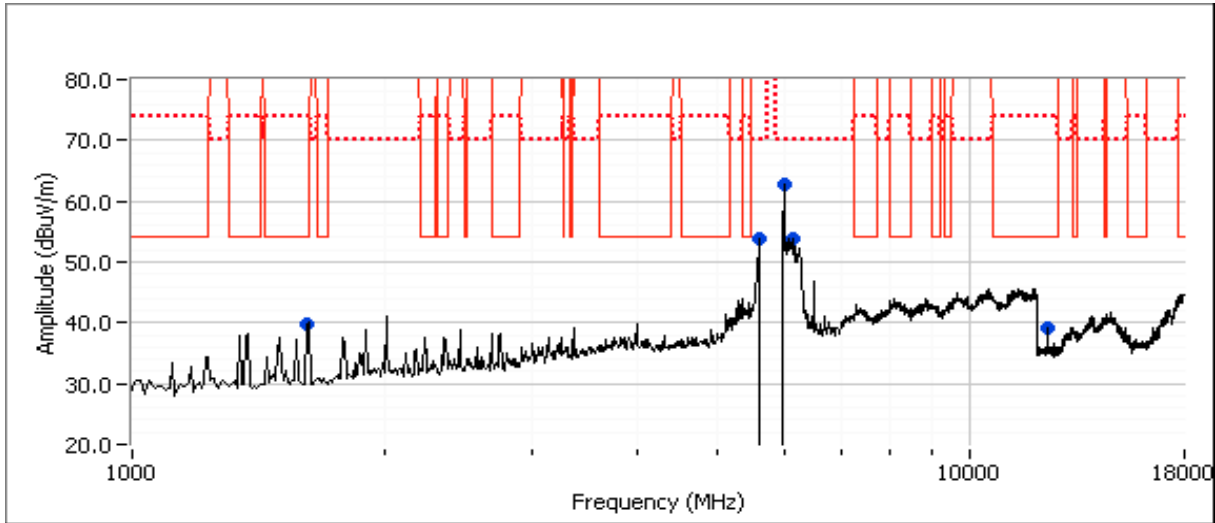



EMC Test Data

Client: Ubiquiti Networks	Job Number: J92977
Model: AirFiber 5GHz	T-Log Number: T92983
	Project Manager: Christine Krebill
Contact: Alex Pavlos	Project Coordinator: Irene Rademacher
Standard: FCC 15.247	Class: -

Conducted Emissions

(Elliott Laboratories Fremont Facility, Semi-Anechoic Chamber)

Test Specific Details

Objective: The objective of this test session is to perform final qualification testing of the EUT with respect to the specification listed above.

Date of Test: 8/1/2013	Config. Used: 3
Test Engineer: Jack Liu	Config Change: None
Test Location: FT Chamber #7	EUT Voltage: 120V/60Hz

General Test Configuration

For tabletop equipment, the EUT was located on a wooden table inside the semi-anechoic chamber, 40 cm from a vertical coupling plane and 80cm from the LISN. A second LISN was used for all local support equipment. Remote support equipment was located outside of the semi-anechoic chamber. Any cables running to remote support equipment were routed through metal conduit and when possible passed through a ferrite clamp upon exiting the chamber.

Ambient Conditions:	Temperature:	23 °C
	Rel. Humidity:	40 %

Summary of Results

Run #	Test Performed	Limit	Result	Margin
1	CE, AC Power, 120V/60Hz	FCC 15.207 (Class B)	Pass	51.5 dBµV @ 0.499 MHz (-4.5 dB)

Modifications Made During Testing

No modifications were made to the EUT during testing

Deviations From The Standard

No deviations were made from the requirements of the standard.

Sample Notes

MAC Address: 02:27:22:D8:5A:0D
 Driver: 2.0 Dev 18481
 POE S/N: NTS 2013-4479

Notes

Testing performed on the AC port of the POE injector provided.
 EUT configured to continuously transmit on center channel at maximum power.
 Transmit at 5790MHz

Client: Ubiquiti Networks	Job Number: J92977
Model: AirFiber 5GHz	T-Log Number: T92983
Contact: Alex Pavlos	Project Manager: Christine Krebill
Standard: FCC 15.247	Project Coordinator: Irene Rademacher
	Class: -

Run #2: AC Power Port Conducted Emissions, 0.15 - 30MHz, 120V/60Hz

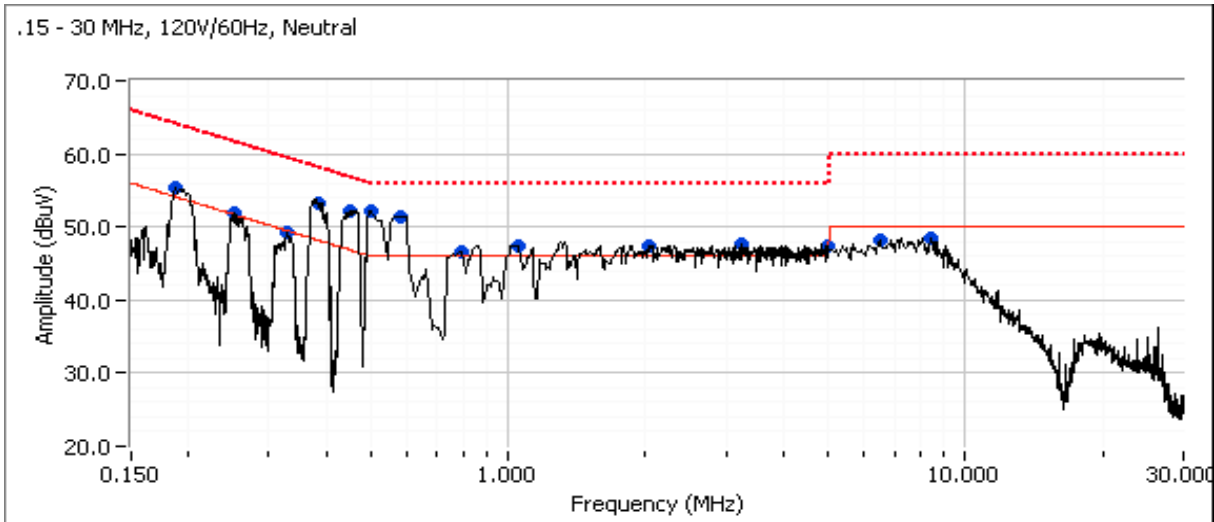
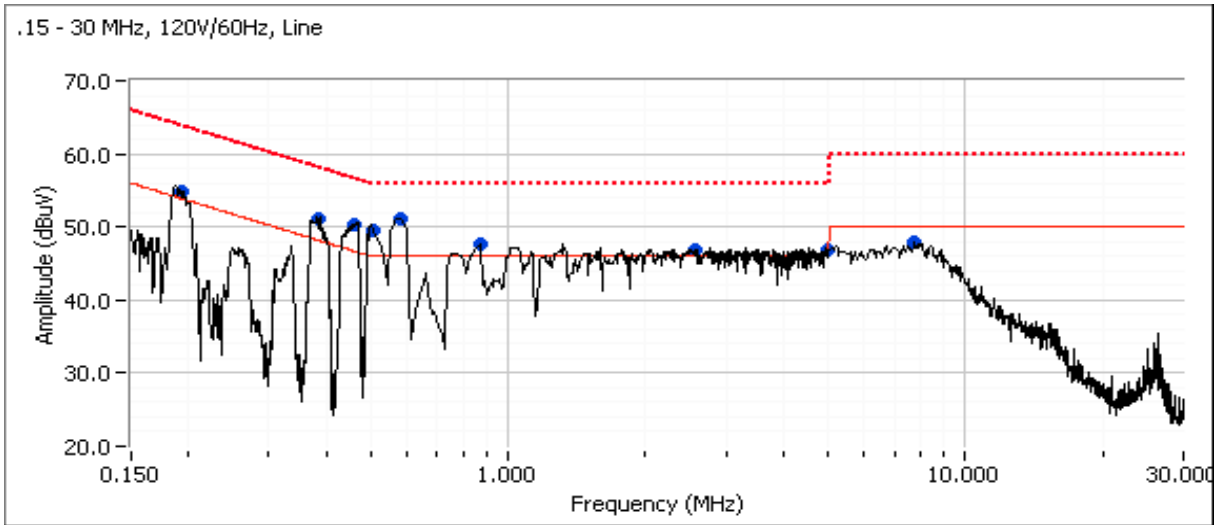



EMC Test Data

Client: Ubiquiti Networks	Job Number: J92977
Model: AirFiber 5GHz	T-Log Number: T92983
	Project Manager: Christine Krebill
Contact: Alex Pavlos	Project Coordinator: Irene Rademacher
Standard: FCC 15.247	Class: -

Preliminary peak readings captured during pre-scan (peak readings vs. average limit)

Frequency MHz	Level dB μ V	AC Line	15.207		Detector QP/Ave	Comments
			Limit	Margin		
0.193	54.8	Line	53.9	0.9	Peak	
0.386	51.2	Line	48.1	3.1	Peak	
0.461	50.4	Line	46.7	3.7	Peak	
0.507	49.6	Line	46.0	3.6	Peak	
0.588	51.0	Line	46.0	5.0	Peak	
0.862	47.7	Line	46.0	1.7	Peak	
2.583	46.9	Line	46.0	0.9	Peak	
4.968	46.9	Line	46.0	0.9	Peak	
7.751	47.9	Line	50.0	-2.1	Peak	
0.188	55.5	Neutral	54.1	1.4	Peak	
0.253	51.8	Neutral	51.7	0.1	Peak	
0.331	49.2	Neutral	49.5	-0.3	Peak	
0.383	53.3	Neutral	48.2	5.1	Peak	
0.449	52.1	Neutral	46.8	5.3	Peak	
0.499	52.3	Neutral	46.0	6.3	Peak	
0.581	51.5	Neutral	46.0	5.5	Peak	
0.778	46.7	Neutral	46.0	0.7	Peak	
1.065	47.5	Neutral	46.0	1.5	Peak	
2.052	47.5	Neutral	46.0	1.5	Peak	
3.261	47.6	Neutral	46.0	1.6	Peak	
4.988	47.4	Neutral	46.0	1.4	Peak	
6.587	48.1	Neutral	50.0	-1.9	Peak	
8.407	48.4	Neutral	50.0	-1.6	Peak	

Final quasi-peak and average readings

Frequency MHz	Level dB μ V	AC Line	15.207		Detector QP/Ave	Comments
			Limit	Margin		
0.499	51.5	Neutral	56.0	-4.5	QP	QP (1.00s)
0.449	42.2	Neutral	46.9	-4.7	AVG	AVG (0.10s)
0.581	51.1	Neutral	56.0	-4.9	QP	QP (1.00s)
0.449	51.9	Neutral	56.9	-5.0	QP	QP (1.00s)
0.382	43.1	Neutral	48.2	-5.1	AVG	AVG (0.10s)
0.587	50.3	Line	56.0	-5.7	QP	QP (1.00s)
0.499	40.0	Neutral	46.0	-6.0	AVG	AVG (0.10s)
0.581	40.0	Neutral	46.0	-6.0	AVG	AVG (0.10s)
0.382	52.1	Neutral	58.2	-6.1	QP	QP (1.00s)
0.461	50.0	Line	56.7	-6.7	QP	QP (1.00s)
0.507	48.9	Line	56.0	-7.1	QP	QP (1.00s)



EMC Test Data

Client: Ubiquiti Networks	Job Number: J92977
Model: AirFiber 5GHz	T-Log Number: T92983
	Project Manager: Christine Krebill
Contact: Alex Pavlos	Project Coordinator: Irene Rademacher
Standard: FCC 15.247	Class: -

Frequency MHz	Level dB μ V	AC Line	15.207		Detector QP/Ave	Comments
			Limit	Margin		
0.587	38.3	Line	46.0	-7.7	AVG	AVG (0.10s)
0.192	46.1	Line	53.9	-7.8	AVG	AVG (0.10s)
0.507	38.2	Line	46.0	-7.8	AVG	AVG (0.10s)
0.386	40.2	Line	48.1	-7.9	AVG	AVG (0.10s)
0.386	50.1	Line	58.1	-8.0	QP	QP (1.00s)
0.461	38.5	Line	46.7	-8.2	AVG	AVG (0.10s)
0.188	44.8	Neutral	54.1	-9.3	AVG	AVG (0.10s)
0.862	46.7	Line	56.0	-9.3	QP	QP (1.00s)
0.253	42.1	Neutral	51.7	-9.6	AVG	AVG (0.10s)
1.065	46.2	Neutral	56.0	-9.8	QP	QP (1.00s)
2.052	46.2	Neutral	56.0	-9.8	QP	QP (1.00s)
3.261	45.9	Neutral	56.0	-10.1	QP	QP (1.00s)
0.778	45.8	Neutral	56.0	-10.2	QP	QP (1.00s)
2.583	45.6	Line	56.0	-10.4	QP	QP (1.00s)
4.988	45.0	Neutral	56.0	-11.0	QP	QP (1.00s)
0.192	52.7	Line	63.9	-11.2	QP	QP (1.00s)
4.968	44.8	Line	56.0	-11.2	QP	QP (1.00s)
0.188	52.8	Neutral	64.1	-11.3	QP	QP (1.00s)
0.253	50.4	Neutral	61.7	-11.3	QP	QP (1.00s)
0.331	47.2	Neutral	59.4	-12.2	QP	QP (1.00s)
0.862	32.7	Line	46.0	-13.3	AVG	AVG (0.10s)
2.052	32.5	Neutral	46.0	-13.5	AVG	AVG (0.10s)
3.261	32.3	Neutral	46.0	-13.7	AVG	AVG (0.10s)
0.778	32.1	Neutral	46.0	-13.9	AVG	AVG (0.10s)
4.988	31.8	Neutral	46.0	-14.2	AVG	AVG (0.10s)
4.968	31.7	Line	46.0	-14.3	AVG	AVG (0.10s)
6.587	45.6	Neutral	60.0	-14.4	QP	QP (1.00s)
8.407	45.5	Neutral	60.0	-14.5	QP	QP (1.00s)
0.331	34.8	Neutral	49.4	-14.6	AVG	AVG (0.10s)
1.065	31.3	Neutral	46.0	-14.7	AVG	AVG (0.10s)
8.407	34.7	Neutral	50.0	-15.3	AVG	AVG (0.10s)
2.583	30.6	Line	46.0	-15.4	AVG	AVG (0.10s)
6.587	33.4	Neutral	50.0	-16.6	AVG	AVG (0.10s)
7.751	42.1	Line	60.0	-17.9	QP	QP (1.00s)
7.751	31.4	Line	50.0	-18.6	AVG	AVG (0.10s)



EMC Test Data

Client:	Ubiquiti Networks	Job Number:	J92977
Product:	AirFiber 5GHz	T-Log Number:	T92983
Contact:	Alex Pavlos	Project Manager:	Christine Krebill
Emissions Standard(s):	FCC 15.247	Project Coordinator:	Irene Rademacher
Immunity Standard(s):	-	Class:	-
		Environment:	-

EMC Test Data

For The

Ubiquiti Networks

Product

AirFiber 5GHz

Date of Last Test: 8/22/2013



EMC Test Data

Client: Ubiquiti Networks	Job Number: J92977
Model: AirFiber 5GHz	T-Log Number: T92983
	Project Manager: Christine Krebill
Contact: Alex Pavlos	Project Coordinator: Irene Rademacher
Standard: FCC 15.247	Class: N/A

RSS 210 and FCC 15.247 (DTS) Antenna Port Measurements Power, PSD, Bandwidth and Spurious Emissions

Test Specific Details

Objective: The objective of this test session is to perform final qualification testing of the EUT with respect to the specification listed above.

Date of Test: 8/19/2013 & 8/22/13
 Test Engineer: Jack Liu
 Test Location: FT Lab6

Config. Used: 1
 Config Change: None
 EUT Voltage: POE

General Test Configuration

All measurements were performed radiated at 11m separation distance. Correction factors were applied to adjust the radiated measurements for the power/psd.

All measurements have been corrected to allow for the external attenuators used.

Ambient Conditions:

Temperature: 23 °C
 Rel. Humidity: 40 %

Summary of Results

Run #	Pwr setting	Avg Pwr	Test Performed	Limit	Pass / Fail	Result / Margin
1	-	-	Output Power	15.247(b)	Pass	29.9 dBm (0.974W)
2	-	-	Power spectral Density (PSD)	15.247(d)	Pass	5.4 dBm/10kHz
3	-	-	Minimum 6dB Bandwidth	15.247(a)	Pass	47.88 MHz
3	-	-	99% Bandwidth	RSS GEN	-	48.05 MHz
4	-	-	Spurious emissions	15.247(b)	Pass	All emissions are 30dB below the Limit

Modifications Made During Testing

No modifications were made to the EUT during testing

Deviations From The Standard

No deviations were made from the requirements of the standard.

Client: Ubiquiti Networks	Job Number: J92977
Model: AirFiber 5GHz	T-Log Number: T92983
Contact: Alex Pavlos	Project Manager: Christine Krebill
Standard: FCC 15.247	Project Coordinator: Irene Rademacher
	Class: N/A

Procedure Comments:

Measurements performed in accordance with FCC KDB 558074 v03r01, dated April 9, 2013

Mode	Data Rate	Duty Cycle (x)	Constant DC?	T (ms)	Pwr Cor Factor*	Lin Volt Cor Factor**	Min VBW for FS (Hz)
OFDM 50MHz	1x QPSK	0.49	Yes	0.98	3.1	6.2	1020.4082

Sample Notes

MAC Address: 02:27:22:DA:5A:0D

Driver: 2.0 Dev 18725

Notes

EUT is a 2x2 MIMO system, using cross polarized antennas

Measurements performed on a second sample using a production test fixture provided by Ubiquiti.

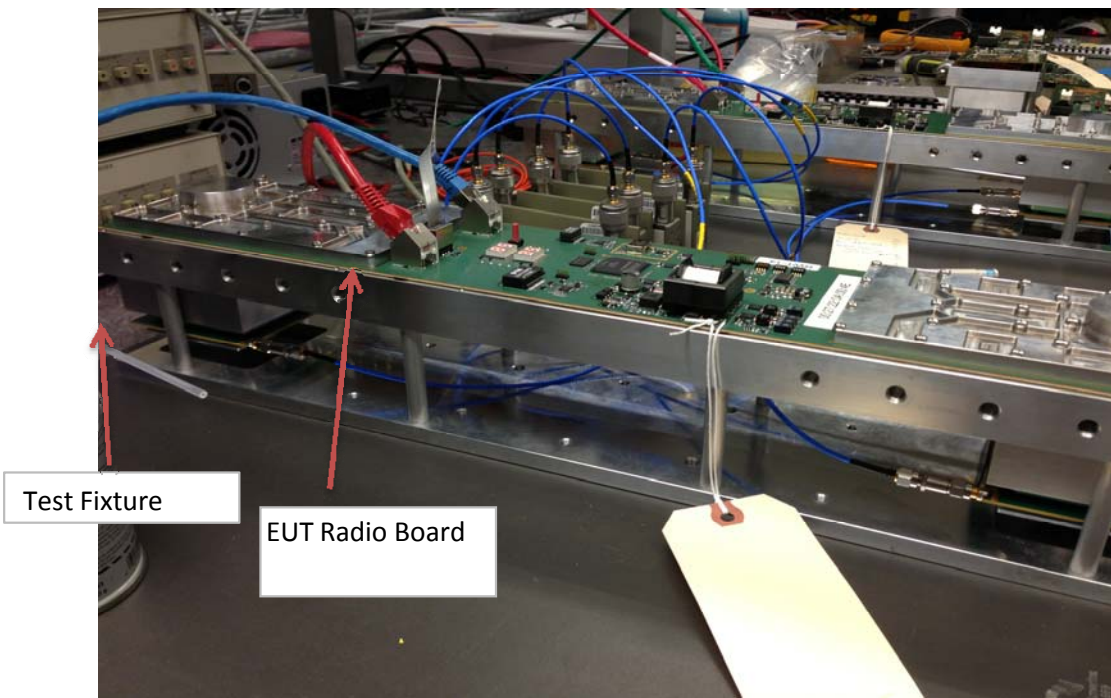

Client: Ubiquiti Networks	Job Number: J92977
Model: AirFiber 5GHz	T-Log Number: T92983
Contact: Alex Pavlos	Project Manager: Christine Krebill
Standard: FCC 15.247	Project Coordinator: Irene Rademacher
	Class: N/A

VSWR and Loss for Chain Output TxCh0

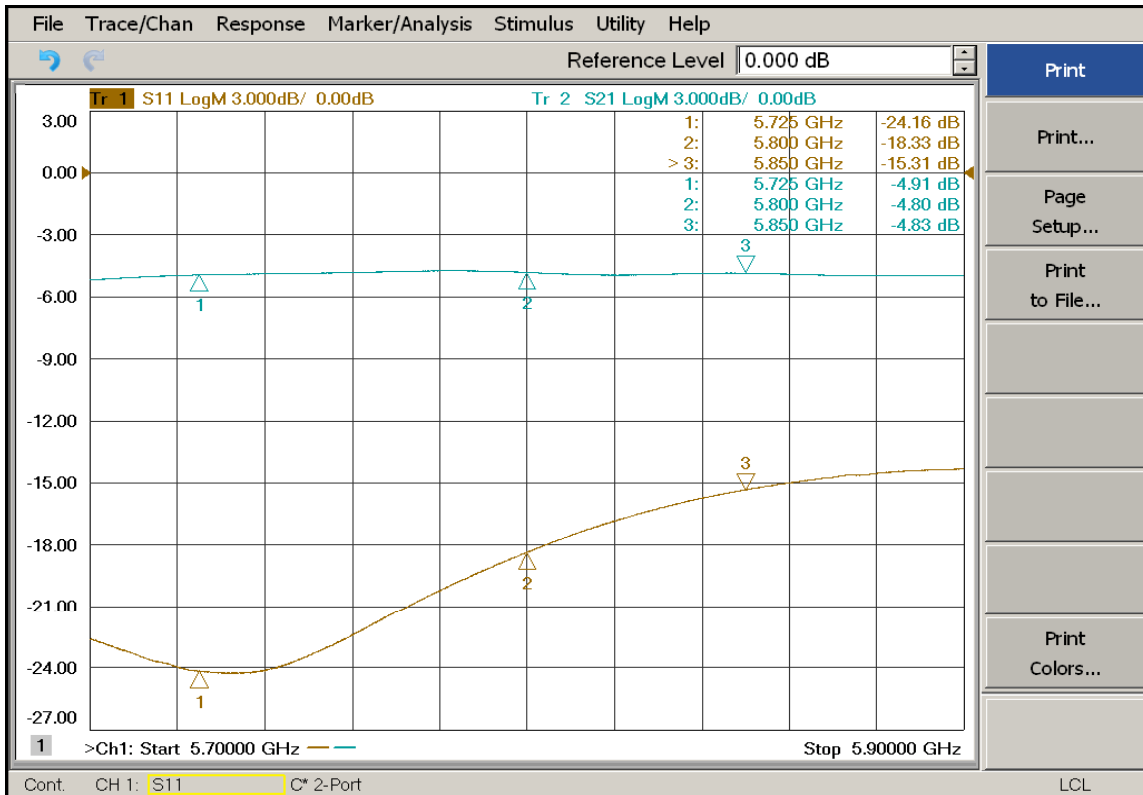

Client: Ubiquiti Networks	Job Number: J92977
Model: AirFiber 5GHz	T-Log Number: T92983
Contact: Alex Pavlos	Project Manager: Christine Krebill
Standard: FCC 15.247	Project Coordinator: Irene Rademacher
	Class: N/A

VSWR and Loss for Output TxCh1

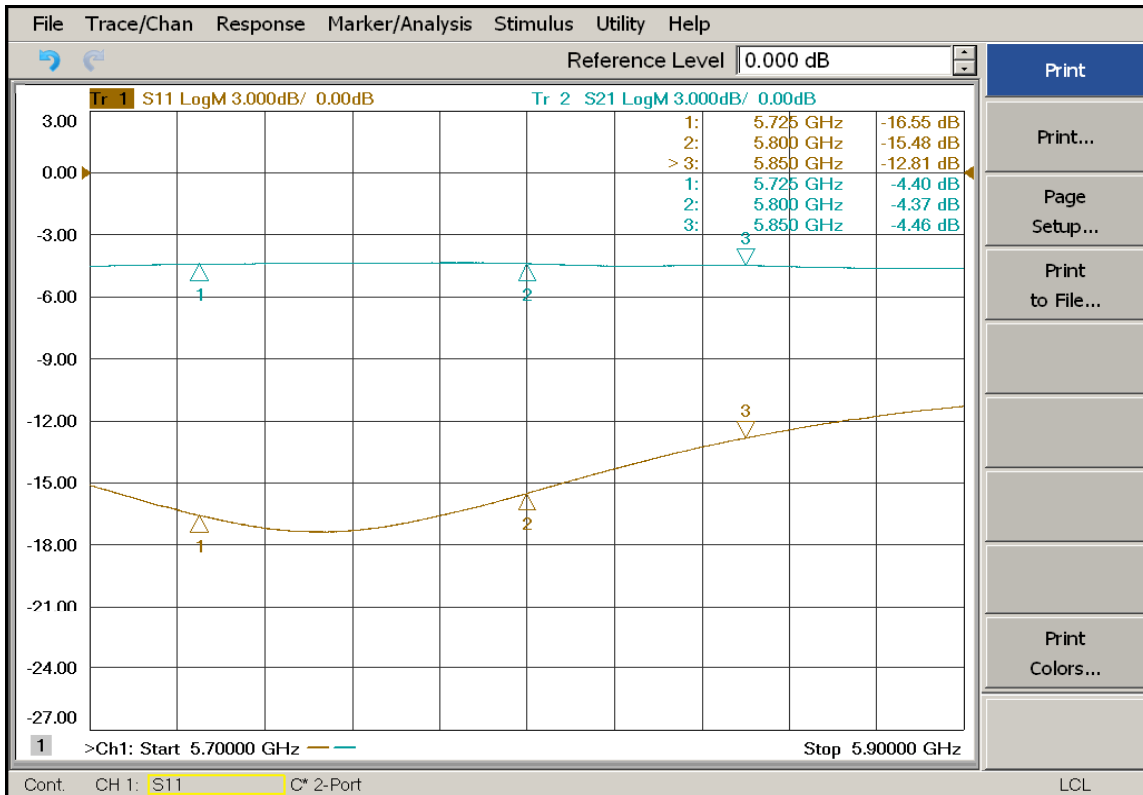



EMC Test Data

Client: Ubiquiti Networks	Job Number: J92977
Model: AirFiber 5GHz	T-Log Number: T92983
	Project Manager: Christine Krebill
Contact: Alex Pavlos	Project Coordinator: Irene Rademacher
Standard: FCC 15.247	Class: N/A

Run #1: Output Power

Power measured at the RF output of the test fixture. A correction factor of 4.6dB applied for the loss of the test fixture.

Output TxCh0

Power Setting ²	Frequency (MHz)	Conducted Power		Antenna Gain (dBi)	EIRP				
		(dBm) ¹	mW		dBm	W			
-	5752	26.7	464.5	23.0	49.7	92.683			
-	5800	27.3	537.0	23.0	50.3	107.152			
-	5823	26.1	403.6	23.0	49.1	80.538			

Output TxCh1

Power Setting ²	Frequency (MHz)	Conducted Power		Antenna Gain (dBi)	EIRP				
		(dBm) ¹	mW		dBm	W			
-	5752	26.5	441.6	23.0	49.5	88.105			
-	5800	26.4	436.5	23.0	49.4	87.096			
-	5823	26.6	455.0	23.0	49.6	90.782			

Total

Power Setting ²	Frequency (MHz)	Conducted Power (dBm)		Result	Total Conducted Pwr		Total EIRP	
		TxCh0	TxCh1		dBm	mW	dBm	W
-	5752	26.7	26.5	Pass	29.6	906.1	52.6	180.8
-	5800	27.3	26.4	Pass	29.9	973.5	52.9	194.2
-	5823	26.1	26.6	Pass	29.3	858.6	52.3	171.3

- Note 1: Duty Cycle < 98%, constant duty cycle. Output power measured using a spectrum analyzer (see plots below) with RBW= 1-5% of OBW, VB≥3* RBW, RMS detector, power averaging on, and power integration over the OBW, trace average 100 traces (option AVGSA-1, in KDB 558074). Measurement corrected by Pwr Cor Factor. Spurious limit becomes -30dBc.
- Note 2: Power setting - the software power setting used during testing, included for reference only.



EMC Test Data

Client: Ubiquiti Networks	Job Number: J92977
Model: AirFiber 5GHz	T-Log Number: T92983
	Project Manager: Christine Krebill
Contact: Alex Pavlos	Project Coordinator: Irene Rademacher
Standard: FCC 15.247	Class: N/A

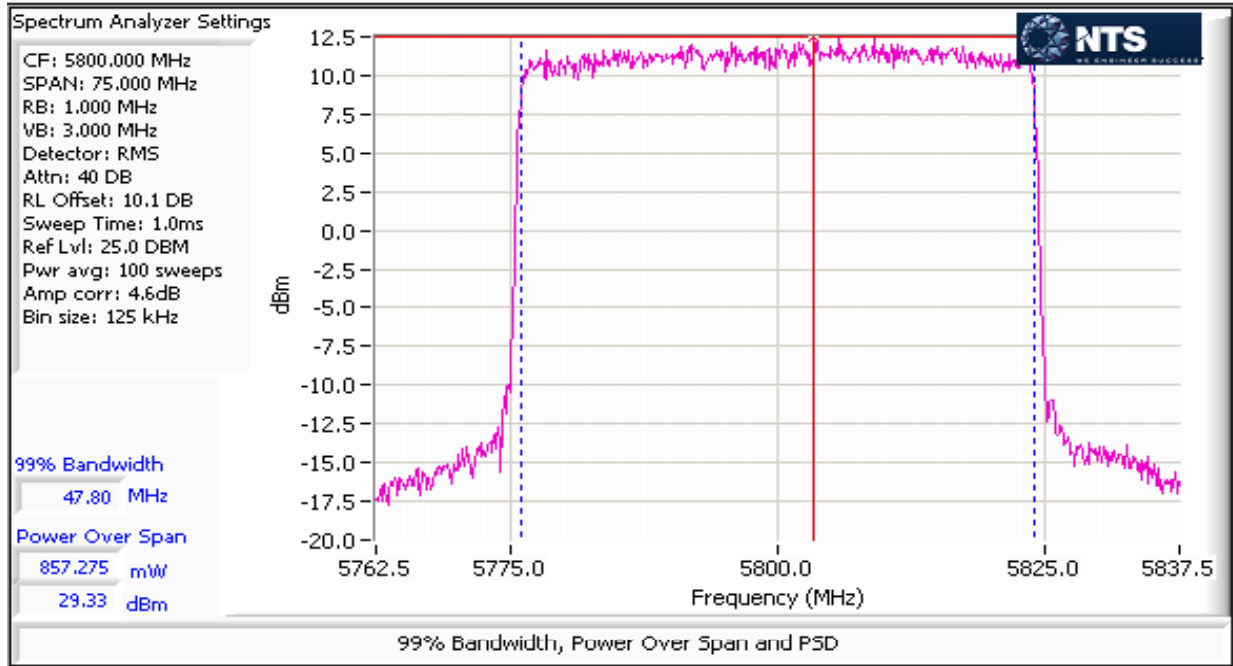



EMC Test Data

Client: Ubiquiti Networks	Job Number: J92977
Model: AirFiber 5GHz	T-Log Number: T92983
Contact: Alex Pavlos	Project Manager: Christine Krebill
Standard: FCC 15.247	Project Coordinator: Irene Rademacher
	Class: N/A

Run #2: Power spectral Density

Power measured at the RF output of the test fixture. A correction factor of 4.6dB applied for the loss of the test fixture.

Antenna Output TxCh0

Power Setting	Frequency (MHz)	RBW (kHz)	PSD (dBm/10kHz) ^{Note 1}			Limit dBm/3kHz	Result
			TxCh0	TxCh1			
-	5752	10.0	-0.48	-0.5	-0.5	8.0	Pass
-	5800	10.0	2.68	2.1	2.1	8.0	Pass
-	5823	10.0	-0.03	0.8	0.8	8.0	Pass

Antenna Output TxCh1

Power Setting	Frequency (MHz)	RBW (kHz)	PSD (dBm/10kHz) ^{Note 1}			Limit dBm/3kHz	Result
			TxCh0	TxCh1			
-	5752	10.0	-0.54	-0.5	-0.5	8.0	Pass
-	5800	10.0	2.11	2.1	2.1	8.0	Pass
-	5823	10.0	0.80	0.8	0.8	8.0	Pass

Total

Power Setting	Frequency (MHz)	RBW (kHz)	PSD			PSD (total) (dBm/10kHz) ^{Note 1}	Limit dBm/3kHz	Result
			TxCh0	TxCh1				
-	5752	10.0	-0.5	-0.5	-0.5	2.5	8.0	Pass
-	5800	10.0	2.7	2.1	2.1	5.4	8.0	Pass
-	5823	10.0	0.0	0.8	0.8	3.4	8.0	Pass

Note 1: Test performed per method PKSPD, in KDB 558074. Power spectral density measured using: 3kHz ≤ RBW ≤ 100kHz, VBW=3*RBW, peak detector, span = 1.5*DTS BW, auto sweep time, max hold.

Client: Ubiquiti Networks	Job Number: J92977
Model: AirFiber 5GHz	T-Log Number: T92983
Contact: Alex Pavlos	Project Manager: Christine Krebill
Standard: FCC 15.247	Project Coordinator: Irene Rademacher
	Class: N/A

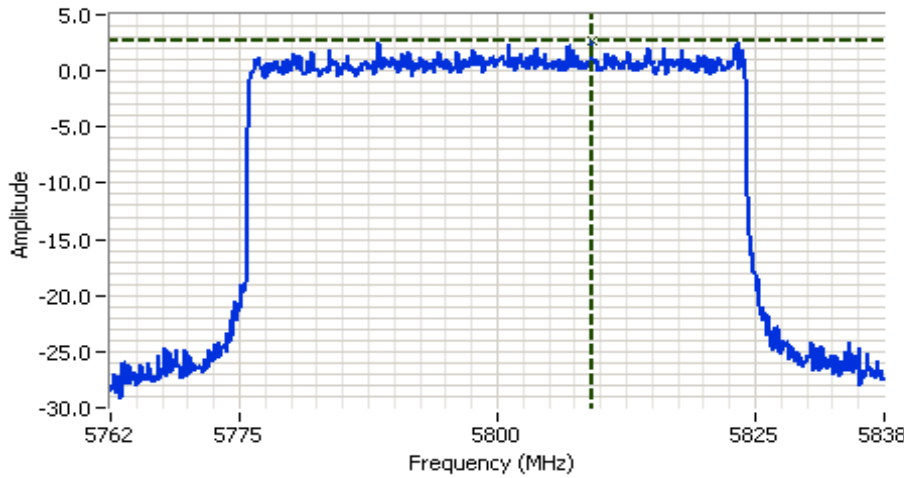

Analyzer Settings

Agilent Technologies, E4446A
 CF: 5800.000 MHz
 SPAN: 75.000 MHz
 RB: 10.0 kHz
 VB: 30.0 kHz
 Detector: POS
 Attn: 20 DB
 RL Offset: 11.6 DB
 Sweep Time: 0.7s
 Ref Lvl: 20.0 DBM

Comments

PSD: 2.68/10kHz
 CH: 5800MHz
 TxCh0

Cursor 1 5809.1250 2.68

0.0000 0.00

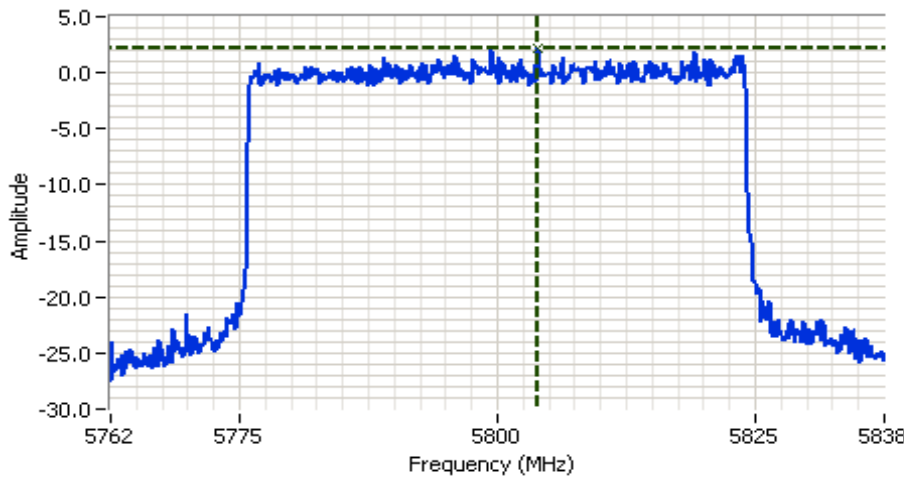

Analyzer Settings

Agilent Technologies, E4446A
 CF: 5800.000 MHz
 SPAN: 75.000 MHz
 RB: 10.0 kHz
 VB: 30.0 kHz
 Detector: POS
 Attn: 20 DB
 RL Offset: 11.6 DB
 Sweep Time: 0.7s
 Ref Lvl: 20.0 DBM

Comments

PSD: 2.11/10kHz
 CH: 5800MHz
 TxCh1

Cursor 1 5804.0000 2.11

0.0000 0.00





EMC Test Data

Client: Ubiquiti Networks	Job Number: J92977
Model: AirFiber 5GHz	T-Log Number: T92983
Contact: Alex Pavlos	Project Manager: Christine Krebill
Standard: FCC 15.247	Project Coordinator: Irene Rademacher
	Class: N/A

Run #3: Signal Bandwidth

Testing performed on the chain with highest power

Power Setting	Frequency (MHz)	Bandwidth (MHz)		RBW Setting (Hz)	
		6dB	99%	6dB	99%
-	5752	47.88	48.05	100k	1M
-	5800	48.00	48.05	100k	1M
-	5823	47.88	48.05	100k	1M

Note 1: DTS BW: RBW=100kHz, VBW ≥ 3*RBW, peak detector, max hold, auto sweep time.
 99% BW: RBW=1-5% of of 99%BW, VBW ≥ 3*RBW, peak detector, max hold, auto sweep time.

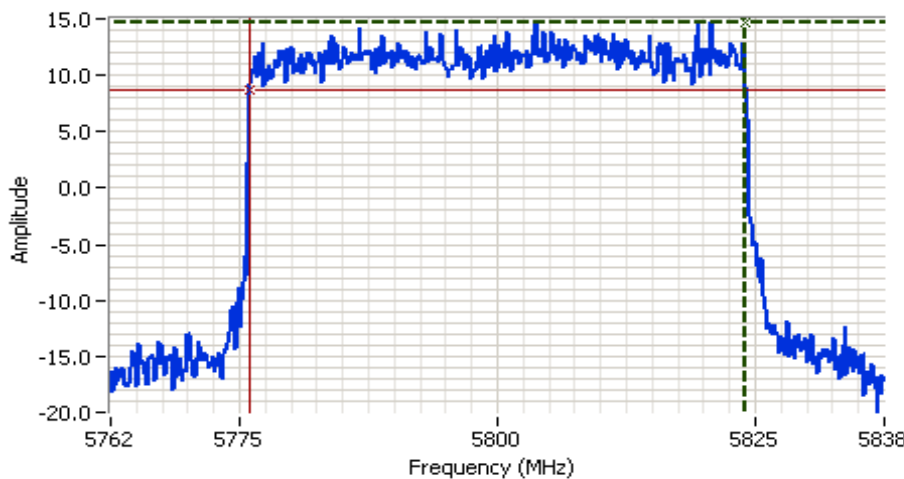

Analyzer Settings

Agilent Technologies, E4446A
 CF: 5800.000 MHz
 SPAN: 75.000 MHz
 RB: 100 kHz
 VB: 300 kHz
 Detector: POS
 Attn: 30 DB
 RL Offset: 14.7 DB
 Sweep Time: 7.2ms
 Ref Lvl: 30.0 DBM

Comments

6dB BW: 48.000 MHz
 5800MHz
 1xOPSK

Cursor 1	5824.0000	14.65	Delta Freq.	48.000
Cursor 2	5776.0000	8.65	Delta Amplitude	6.00





EMC Test Data

Client: Ubiquiti Networks	Job Number: J92977
Model: AirFiber 5GHz	T-Log Number: T92983
Contact: Alex Pavlos	Project Manager: Christine Krebill
Standard: FCC 15.247	Project Coordinator: Irene Rademacher
	Class: N/A

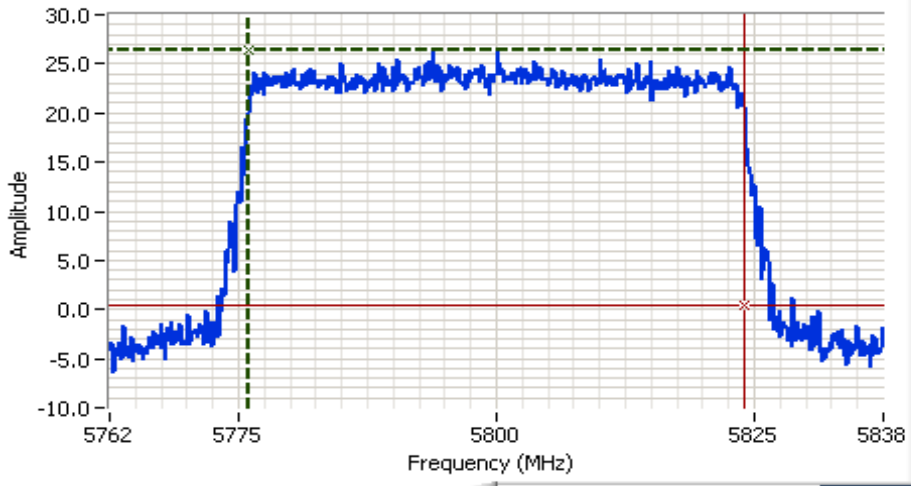

Analyzer Settings
Agilent Technologies, E4446A
CF: 5800.000 MHz
SPAN: 75.000 MHz
RB: 1.000 MHz
VB: 3.000 MHz
Detector: POS
Attn: 30 DB
RL Offset: 14.7 DB
Sweep Time: 1.0ms
Ref Lvl: 30.0 DBM

Comments
99% power BW: 48.045 MHz
5800MHz
1xQPSK

Cursor 1	5775.9775	26.39	⊕ ⊖ 🔒	Delta Freq.	48.045
Cursor 2	5824.0225	0.39	⊕ ⊖ 🔒	Delta Amplitude	26.00





EMC Test Data

Client: Ubiquiti Networks	Job Number: J92977
Model: AirFiber 5GHz	T-Log Number: T92983
	Project Manager: Christine Krebill
Contact: Alex Pavlos	Project Coordinator: Irene Rademacher
Standard: FCC 15.247	Class: N/A

Run #4: Out of Band Spurious Emissions

TxCh0

Pwr Setting	Frequency (MHz)	Limit	Result
-	5752	-30dBc	Pass
-	5800	-30dBc	Pass
-	5823	-30dBc	Pass

TxCh1

Pwr Setting	Frequency (MHz)	Limit	Result
-	5752	-30dBc	Pass
-	5800	-30dBc	Pass
-	5823	-30dBc	Pass

Client: Ubiquiti Networks	Job Number: J92977
Model: AirFiber 5GHz	T-Log Number: T92983
Contact: Alex Pavlos	Project Manager: Christine Krebill
Standard: FCC 15.247	Project Coordinator: Irene Rademacher
	Class: N/A

Plots for low channel

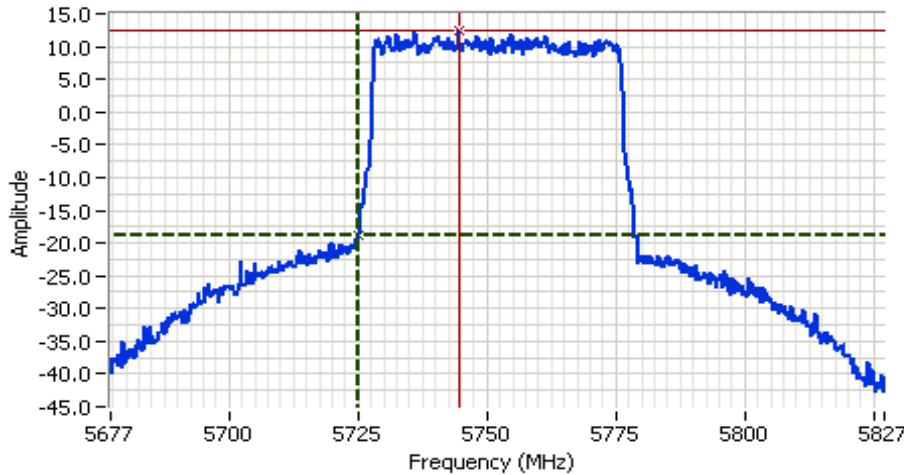

Analyzer Settings
 Agilent Technologies, E4446A
 CF: 5752.000 MHz
 SPAN: 150.000 MHz
 RB: 100 kHz
 VB: 300 kHz
 Detector: POS
 Attn: 20 DB
 RL Offset: 14.7 DB
 Sweep Time: 20.0ms
 Ref Lvl: 20.0 DBM

Comments
 -30dBc
 TxCh0

Cursor 1 5725.0000 -18.98 Delta Freq. 19.500
 Cursor 2 5744.5000 12.37 Delta Amplitude 31.35

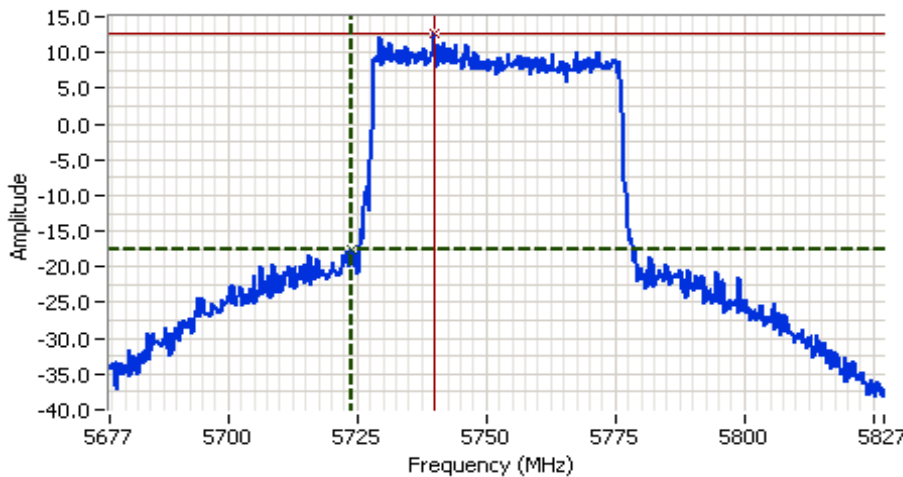

Analyzer Settings
 Agilent Technologies, E4446A
 CF: 5752.000 MHz
 SPAN: 150.000 MHz
 RB: 100 kHz
 VB: 300 kHz
 Detector: POS
 Attn: 40 DB
 RL Offset: 14.7 DB
 Sweep Time: 20.0ms
 Ref Lvl: 30.0 DBM

Comments
 -30dBc
 TxCh1

Cursor 1 5723.7500 -17.50 Delta Freq. 16.000
 Cursor 2 5739.7500 12.72 Delta Amplitude 30.22



Client: Ubiquiti Networks	Job Number: J92977
Model: AirFiber 5GHz	T-Log Number: T92983
Contact: Alex Pavlos	Project Manager: Christine Krebill
Standard: FCC 15.247	Project Coordinator: Irene Rademacher
	Class: N/A

Plots for Middle channel

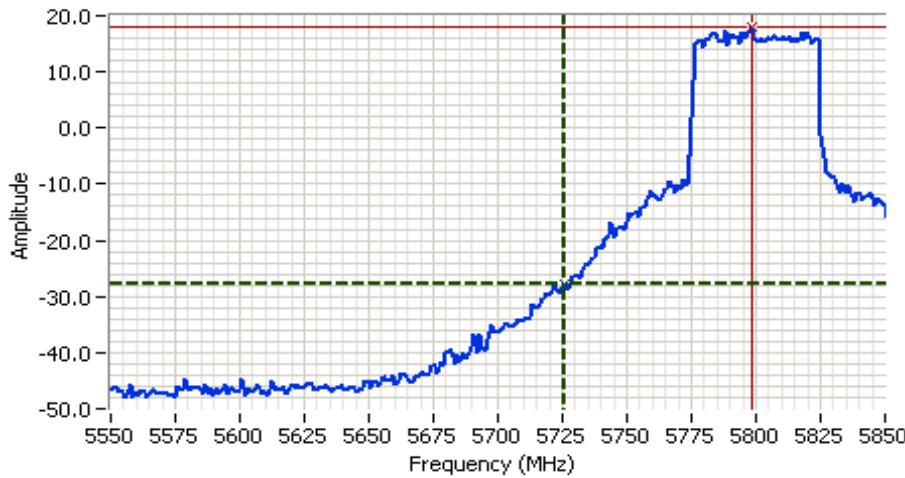

Analyzer Settings
 Agilent Technologies, E4446A
 CF: 5875.000 MHz
 SPAN: 650.000 MHz
 RB: 100 kHz
 VB: 300 kHz
 Detector: POS
 Attn: 30 DB
 RL Offset: 14.7 DB
 Sweep Time: 62.1ms
 Ref Lvl: 25.0 DBM

Comments
 5800MHz
 TxCh0

Cursor 1 5725.5000 -27.72  Delta Freq. 72.583
 Cursor 2 5798.0835 17.95  Delta Amplitude 45.67

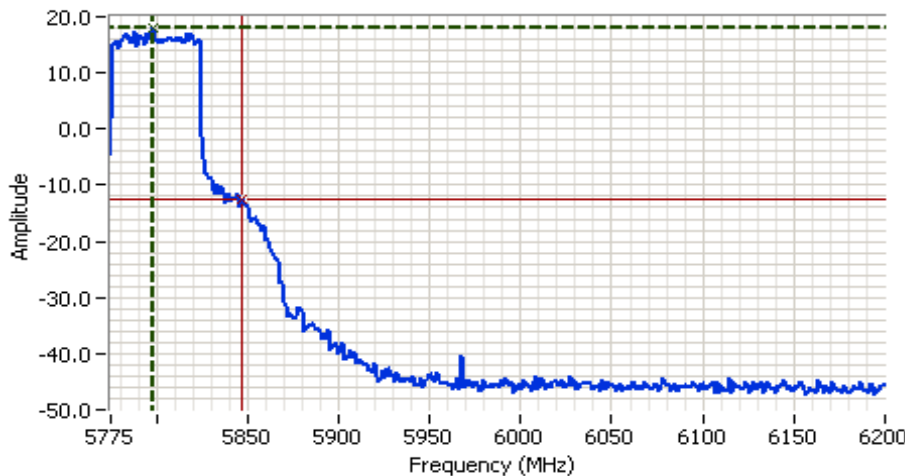

Analyzer Settings
 Agilent Technologies, E4446A
 CF: 5875.000 MHz
 SPAN: 650.000 MHz
 RB: 100 kHz
 VB: 300 kHz
 Detector: POS
 Attn: 30 DB
 RL Offset: 14.7 DB
 Sweep Time: 62.1ms
 Ref Lvl: 25.0 DBM

Comments
 5800MHz
 TxCh0

Cursor 1 5798.0835 17.95  Delta Freq. 48.750
 Cursor 2 5846.8333 -12.46  Delta Amplitude 30.41



Client: Ubiquiti Networks	Job Number: J92977
Model: AirFiber 5GHz	T-Log Number: T92983
Contact: Alex Pavlos	Project Manager: Christine Krebill
Standard: FCC 15.247	Project Coordinator: Irene Rademacher
	Class: N/A

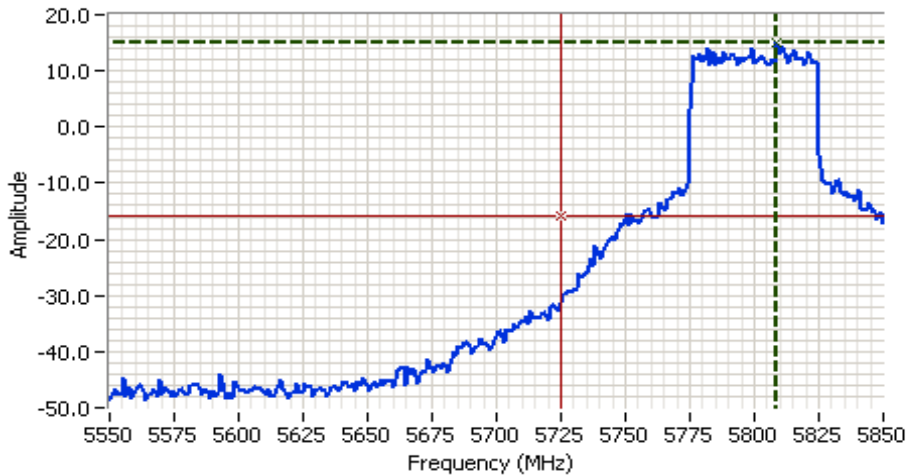

Analyzer Settings
 Agilent Technologies, E4446A
 CF: 5875.000 MHz
 SPAN: 650.000 MHz
 RB: 100 kHz
 VB: 300 kHz
 Detector: POS
 Attn: 30 DB
 RL Offset: 14.7 DB
 Sweep Time: 62.1ms
 Ref Lvl: 25.0 DBM

Comments
 5800MHz
 TxCh1

Cursor 1	5808.9165	14.99	Delta Freq.	83.917
Cursor 2	5725.0000	-15.83	Delta Amplitude	30.82

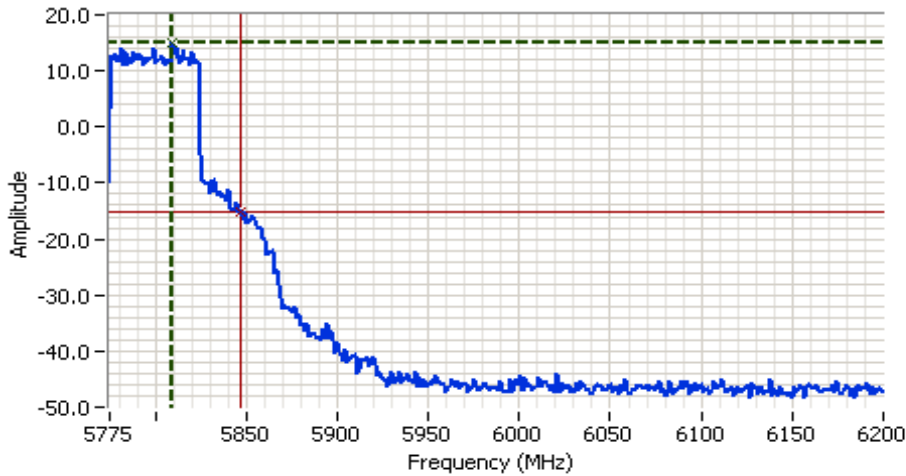

Analyzer Settings
 Agilent Technologies, E4446A
 CF: 5875.000 MHz
 SPAN: 650.000 MHz
 RB: 100 kHz
 VB: 300 kHz
 Detector: POS
 Attn: 30 DB
 RL Offset: 14.7 DB
 Sweep Time: 62.1ms
 Ref Lvl: 25.0 DBM

Comments
 5800MHz
 TxCh1

Cursor 1	5808.9165	14.99	Delta Freq.	37.917
Cursor 2	5846.8333	-15.09	Delta Amplitude	30.09



Client: Ubiquiti Networks	Job Number: J92977
Model: AirFiber 5GHz	T-Log Number: T92983
Contact: Alex Pavlos	Project Manager: Christine Krebill
Standard: FCC 15.247	Project Coordinator: Irene Rademacher
	Class: N/A

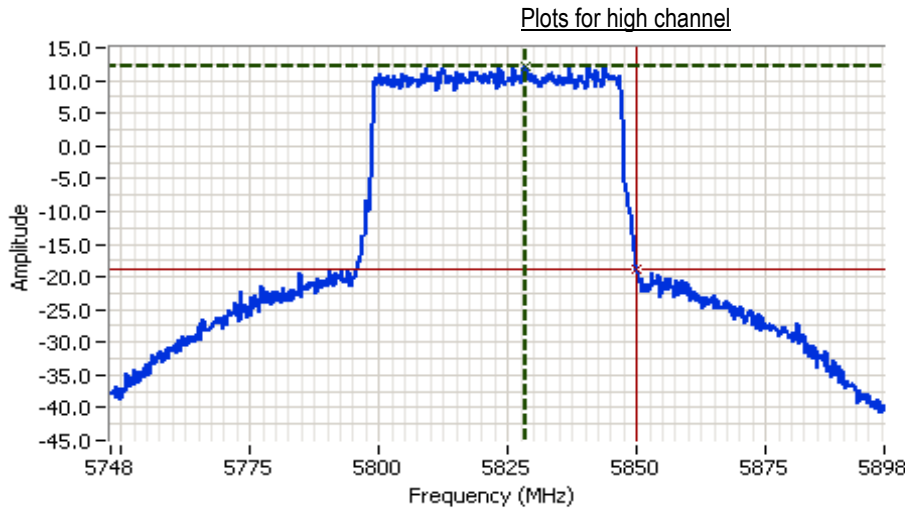

Analyzer Settings
 Agilent Technologies, E4446A
 CF: 5823.000 MHz
 SPAN: 150.000 MHz
 RB: 100 kHz
 VB: 300 kHz
 Detector: POS
 Attn: 20 DB
 RL Offset: 14.7 DB
 Sweep Time: 20.0ms
 Ref Lvl: 20.0 DBM

Comments
 -30dBc
 TxCh0

Cursor 1	5828.5000	12.08		Delta Freq.	21.500
Cursor 2	5850.0000	-18.87		Delta Amplitude	30.96

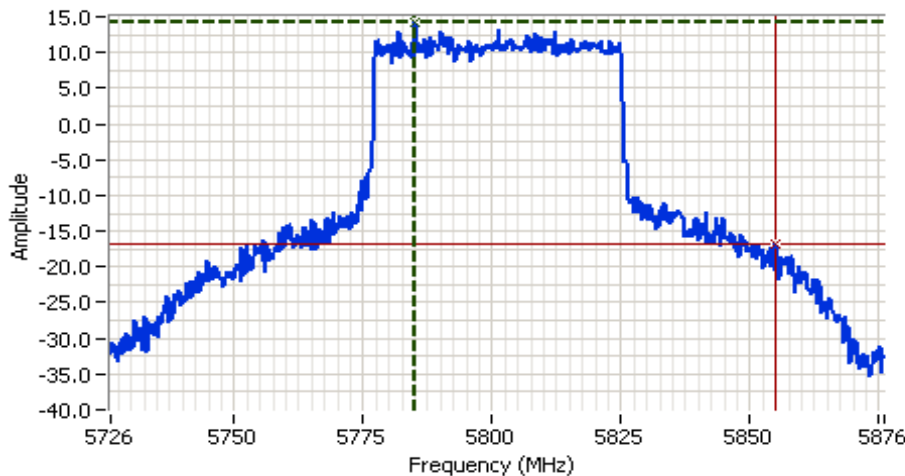

Analyzer Settings
 Agilent Technologies, E4446A
 CF: 5801.000 MHz
 SPAN: 150.000 MHz
 RB: 100 kHz
 VB: 300 kHz
 Detector: POS
 Attn: 40 DB
 RL Offset: 14.7 DB
 Sweep Time: 20.0ms
 Ref Lvl: 30.0 DBM

Comments
 -30dBc
 TxCh1

Cursor 1	5785.0000	14.17		Delta Freq.	70.000
Cursor 2	5855.0000	-16.77		Delta Amplitude	30.94



End of Report

This page is intentionally blank and marks the last page of this test report.