



**MET Laboratories, Inc.** *Safety Certification - EMI - Telecom Environmental Simulation*

914 WEST PATAPSCO AVENUE BALTIMORE, MARYLAND 21230-3432 PHONE (410) 354-3300 FAX (410) 354-3313  
33439 WESTERN AVENUE UNION CITY, CALIFORNIA 94587 PHONE (510) 489-6300 FAX (510) 489-6372  
3162 BELICK STREET SANTA CLARA, CA 95054 PHONE (408) 748-3585 FAX (510) 489-6372  
13301 MCCALLEN PASS AUSTIN, TX 78753 PHONE (512) 287-2500 FAX (512) 287-2513

January 23, 2018

Ubiquiti Networks  
1250 S. Grove Ave. Suite 100  
Barrington, IL 60010

Dear Alex Pavlos,

Enclosed is the EMC Wireless test report for compliance testing of the Ubiquiti Networks, AF-LTU as tested to the requirements of Title 47 of the CFR, Ch. 1 (10-1-06 ed.), FCC Part 15 Subpart C for Intentional Radiators.

Thank you for using the services of MET Laboratories, Inc. If you have any questions regarding these results or if MET can be of further service to you, please feel free to contact me.

Sincerely yours,  
MET LABORATORIES, INC.

Amy Graziano  
Documentation Department

Reference: (\\Ubiquiti Networks\EMC94936-FCC247)

Certificates and reports shall not be reproduced except in full, without the written permission of MET Laboratories, Inc.

## **Electromagnetic Compatibility Criteria Test Report**

for the

**Ubiquiti Networks  
AF-LTU**

**Tested under**  
the FCC Certification Rules  
contained in  
Title 47 of the CFR, 15.247 Subpart C  
for Intentional Radiators

**MET Report: EMC94936-FCC247**

January 23, 2018

**Prepared For:**

**Ubiquiti Networks  
1250 S. Grove Ave. Suite 100  
Barrington, IL 60010**

**Prepared By:**  
**MET Laboratories, Inc.**  
914 West Patapsco Avenue, Baltimore, MD 21230

## Electromagnetic Compatibility Criteria Test Report

for the

**Ubiquiti Networks**  
**AF-LTU**

**Tested under**  
the FCC Certification Rules  
contained in  
Title 47 of the CFR, 15.247 Subpart C  
for Intentional Radiators

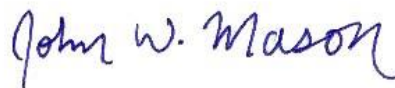


Surendra Shrestha, Project Engineer  
Electromagnetic Compatibility Lab



Amy Graziano  
Documentation Department

**Engineering Statement:** The measurements shown in this report were made in accordance with the procedures indicated, and the emissions from this equipment were found to be within the limits applicable. I assume full responsibility for the accuracy and completeness of these measurements, and for the qualifications of all persons taking them. It is further stated that upon the basis of the measurements made, the equipment tested is capable of operation in accordance with the requirements of the FCC Rules Part 15.247 under normal use and maintenance.



John Mason,  
Director, Electromagnetic Compatibility Lab

## Report Status Sheet

Revision	Report Date	Reason for Revision
Ø	January 23, 2018	Initial Issue.

## Table of Contents

<b>I.</b>	<b>Executive Summary .....</b>	<b>1</b>
	A. Purpose of Test .....	2
	B. Executive Summary .....	2
<b>II.</b>	<b>Equipment Configuration .....</b>	<b>3</b>
	A. Overview.....	4
	B. References.....	5
	C. Test Site .....	5
	D. Description of Test Sample.....	6
	E. Equipment Configuration.....	6
	F. Support Equipment .....	7
	G. Ports and Cabling Information.....	7
	H. Mode of Operation.....	7
	I. Method of Monitoring EUT Operation .....	7
	J. Modifications .....	7
	a) Modifications to EUT.....	7
	b) Modifications to Test Standard.....	7
	K. Disposition of EUT.....	7
<b>III.</b>	<b>Electromagnetic Compatibility Criteria for Intentional Radiators.....</b>	<b>8</b>
	§ 15.203 Antenna Requirement.....	9
	§ 15.207(a) Conducted Emissions Limits.....	10
	§ 15.247(a)(1) 20 dB Occupied Bandwidth.....	13
	§ 15.247(a)(1) Average Time of Occupancy (Dwell Time) .....	18
	§ 15.247(a)(1) Number of RF Channels .....	23
	§ 15.247(a)(1) RF Channel Separation .....	27
	§ 15.247(b) Peak Power Output .....	30
	§ 15.247(d) Radiated Spurious Emissions Requirements and Band Edge .....	36
	§ 15.247(d) RF Conducted Spurious Emissions Requirements and Band Edge.....	68
<b>IV.</b>	<b>Test Equipment .....</b>	<b>78</b>
<b>V.</b>	<b>Certification &amp; User’s Manual Information.....</b>	<b>80</b>
	A. Certification Information .....	81
	B. Label and User’s Manual Information .....	85

## List of Tables

Table 1. Executive Summary of EMC Part 15.247 Compliance Testing .....	2
Table 2. EUT Summary Table.....	4
Table 3. References .....	5
Table 4. Equipment Configuration .....	6
Table 5. Support Equipment.....	7
Table 6. Ports and Cabling Information .....	7
Table 7. Conducted Limits for Intentional Radiators from FCC Part 15 § 15.207(a) .....	10
Table 8. Conducted Emissions, 15.207(a), Phase Line, Test Results.....	11
Table 9. Conducted Emissions, 15.207(a), Neutral Line, Test Results .....	12
Table 10. Dwell Time Calculation .....	18
Table 11. Peak Power Output, Test Results .....	31
Table 12. Restricted Bands of Operation.....	36
Table 13. Radiated Emissions Limits Calculated from FCC Part 15, § 15.209 (a) .....	37
Table 14. Radiated Spurious Emissions, Test Results.....	38
Table 15. Test Equipment List .....	79

## List of Plots

Plot 1. Conducted Emissions, 15.207(a), Phase Line .....	11
Plot 2. Conducted Emissions, 15.207(a), Neutral Line .....	12
Plot 3. 20 dB Occupied Bandwidth, DH1, 2402 MHz .....	14
Plot 4. 20 dB Occupied Bandwidth, DH1, 2441 MHz .....	14
Plot 5. 20 dB Occupied Bandwidth, DH1, 2480 MHz .....	14
Plot 6. 20 dB Occupied Bandwidth, DH5, 2402 MHz .....	15
Plot 7. 20 dB Occupied Bandwidth, DH5, 2441 MHz .....	15
Plot 8. 20 dB Occupied Bandwidth, DH5, 2480 MHz .....	15
Plot 9. 20 dB Occupied Bandwidth, 3-DH1, 2402 MHz .....	16
Plot 10. 20 dB Occupied Bandwidth, 3-DH1, 2441 MHz .....	16
Plot 11. 20 dB Occupied Bandwidth, 3-DH1, 2480 MHz .....	16
Plot 12. 20 dB Occupied Bandwidth, 3-DH5, 2402 MHz .....	17
Plot 13. 20 dB Occupied Bandwidth, 3-DH5, 2441 MHz .....	17
Plot 14. 20 dB Occupied Bandwidth, 3-DH5, 2480 MHz .....	17
Plot 15. Dwell Time, DH1 Burst.....	19
Plot 16. Dwell Time, DH5 Burst.....	19
Plot 17. Dwell Time, 3-DH1 Burst.....	20
Plot 18. Dwell Time, 3-DH5 Burst.....	20
Plot 19. DH1 Pulse Width .....	21
Plot 20. DH5 Pulse Width .....	21
Plot 21. 3-DH1 Pulse Width.....	22
Plot 22. 3-DH5 Pulse Width.....	22
Plot 23. Number of Channels, DH1.1.....	23
Plot 24. Number of Channels, DH1.2.....	23
Plot 25. Number of Channels, DH5.1.....	24
Plot 26. Number of Channels, DH5.2.....	24
Plot 27. Number of Channels, 3-DH1.1 .....	25
Plot 28. Number of Channels, 3-DH1.2 .....	25
Plot 29. Number of Channels, 3-DH5.1 .....	26
Plot 30. Number of Channels, 3-DH5.5 .....	26
Plot 31. Channel Separation, DH1 .....	27
Plot 32. Channel Separation, DH5 .....	28

Plot 33. Channel Separation, 3-DH1 .....	28
Plot 34. Channel Separation, 3-DH5 .....	29
Plot 35. Peak Power Output, DH1, 2402MHz.....	32
Plot 36. Peak Power Output, DH1, 2441MHz.....	32
Plot 37. Peak Power Output, DH1, 2480MHz.....	32
Plot 38. Peak Power Output, DH5, 2402MHz.....	33
Plot 39. Peak Power Output, DH5, 2441MHz.....	33
Plot 40. Peak Power Output, DH5, 2480MHz.....	33
Plot 41. Peak Power Output, 3-DH1, 2402MHz .....	34
Plot 42. Peak Power Output, 3-DH1, 2441MHz .....	34
Plot 43. Peak Power Output, 3-DH1, 2480MHz .....	34
Plot 44. Peak Power Output, 3-DH5, 2402MHz .....	35
Plot 45. Peak Power Output, 3-DH5, 2441MHz .....	35
Plot 46. Peak Power Output, 3-DH5, 2480MHz .....	35
Plot 47. Radiated Spurious Emissions, Average, Nonhopping, 1G – 18G, DH1, 2402MHz .....	38
Plot 48. Radiated Spurious Emissions, Average, Nonhopping, 1G – 18G, DH1, 2441MHz .....	39
Plot 49. Radiated Spurious Emissions, Average, Nonhopping, 1G – 18G, DH1, 2480MHz .....	39
Plot 50. Radiated Spurious Emissions, Average, Nonhopping, 1G – 18G, DH5, 2402MHz .....	40
Plot 51. Radiated Spurious Emissions, Average, Nonhopping, 1G – 18G, DH5, 2441MHz .....	40
Plot 52. Radiated Spurious Emissions, Average, Nonhopping, 1G – 18G, DH5, 2480MHz .....	41
Plot 53. Radiated Spurious Emissions, Average, Nonhopping, 1G – 18G, 3-DH1, 2402MHz.....	41
Plot 54. Radiated Spurious Emissions, Average, Nonhopping, 1G – 18G, 3-DH1, 2441MHz.....	42
Plot 55. Radiated Spurious Emissions, Average, Nonhopping, 1G – 18G, 3-DH1, 2480MHz.....	42
Plot 56. Radiated Spurious Emissions, Average, Nonhopping, 1G – 18G, 3-DH5, 2402MHz.....	43
Plot 57. Radiated Spurious Emissions, Average, Nonhopping, 1G – 18G, 3-DH5, 2441MHz.....	43
Plot 58. Radiated Spurious Emissions, Average, Nonhopping, 1G – 18G, 3-DH5, 2480MHz.....	44
Plot 59. Radiated Spurious Emissions, Peak, Nonhopping, 1G – 18G, DH1, 2402MHz.....	44
Plot 60. Radiated Spurious Emissions, Peak, Nonhopping, 1G – 18G, DH1, 2441MHz.....	45
Plot 61. Radiated Spurious Emissions, Peak, Nonhopping, 1G – 18G, DH1, 2480MHz.....	45
Plot 62. Radiated Spurious Emissions, Peak, Nonhopping, 1G – 18G, DH5, 2402MHz.....	46
Plot 63. Radiated Spurious Emissions, Peak, Nonhopping, 1G – 18G, DH5, 2441MHz.....	46
Plot 64. Radiated Spurious Emissions, Peak, Nonhopping, 1G – 18G, DH5, 2480MHz.....	47
Plot 65. Radiated Spurious Emissions, Peak, Nonhopping, 1G – 18G, 3-DH1, 2402MHz.....	47
Plot 66. Radiated Spurious Emissions, Peak, Nonhopping, 1G – 18G, 3-DH1, 2441MHz.....	48
Plot 67. Radiated Spurious Emissions, Peak, Nonhopping, 1G – 18G, 3-DH1, 2480MHz.....	48
Plot 68. Radiated Spurious Emissions, Peak, Nonhopping, 1G – 18G, 3-DH5, 2402MHz.....	49
Plot 69. Radiated Spurious Emissions, Peak, Nonhopping, 1G – 18G, 3-DH5, 2441MHz.....	49
Plot 70. Radiated Spurious Emissions, Peak, Nonhopping, 1G – 18G, 3-DH5, 2480MHz.....	50
Plot 71. Radiated Restricted Band Edge, Average, 2390MHz, DH1 .....	51
Plot 72. Radiated Restricted Band Edge, Average, 2390MHz, DH5 .....	51
Plot 73. Radiated Restricted Band Edge, Average, 2390MHz, 3-DH1 .....	52
Plot 74. Radiated Restricted Band Edge, Average, 2390MHz, 3-DH5 .....	52
Plot 75. Radiated Restricted Band Edge, Average, 2483.5MHz, DH1 .....	53
Plot 76. Radiated Restricted Band Edge, Average, 2483.5MHz, DH5 .....	53
Plot 77. Radiated Restricted Band Edge, Average, 2483.5MHz, 3-DH1 .....	54
Plot 78. Radiated Restricted Band Edge, Average, 2483.5MHz, 3-DH5 .....	54
Plot 79. Radiated Restricted Band Edge, Average, Hopping, 2390MHz, DH1.....	55
Plot 80. Radiated Restricted Band Edge, Average, Hopping, 2390MHz, DH5.....	55
Plot 81. Radiated Restricted Band Edge, Average, Hopping, 2390MHz, 3-DH1 .....	56
Plot 82. Radiated Restricted Band Edge, Average, Hopping, 2390MHz, 3-DH5 .....	56
Plot 83. Radiated Restricted Band Edge, Average, Hopping, 2483.5MHz, DH1.....	57
Plot 84. Radiated Restricted Band Edge, Average, Hopping, 2483.5MHz, DH5.....	57
Plot 85. Radiated Restricted Band Edge, Average, Hopping, 2483.5MHz, 3-DH1 .....	58

Plot 86. Radiated Restricted Band Edge, Average, Hopping, 2483.5MHz, 3-DH5 .....	58
Plot 87. Radiated Restricted Band Edge, Peak, Hopping, 2390MHz, DH1 .....	59
Plot 88. Radiated Restricted Band Edge, Peak, Hopping, 2390MHz, DH5 .....	59
Plot 89. Radiated Restricted Band Edge, Peak, Hopping, 2390MHz, 3-DH1 .....	60
Plot 90. Radiated Restricted Band Edge, Peak, Hopping, 2390MHz, 3-DH5 .....	60
Plot 91. Radiated Restricted Band Edge, Peak, Hopping, 2483.5MHz, DH1 .....	61
Plot 92. Radiated Restricted Band Edge, Peak, Hopping, 2483.5MHz, DH5 .....	61
Plot 93. Radiated Restricted Band Edge, Peak, Hopping, 2483.5MHz, 3-DH1 .....	62
Plot 94. Radiated Restricted Band Edge, Peak, Hopping, 2483.5MHz, 3-DH5 .....	62
Plot 95. Radiated Restricted Band Edge, Peak, 2402MHz, DH1 .....	63
Plot 96. Radiated Restricted Band Edge, Peak, 2402MHz, DH5 .....	63
Plot 97. Radiated Restricted Band Edge, Peak, 2402MHz, 3-DH1 .....	64
Plot 98. Radiated Restricted Band Edge, Peak, 2402MHz, 3-DH5 .....	64
Plot 99. Radiated Restricted Band Edge, Peak, 2480MHz, DH1 .....	65
Plot 100. Radiated Restricted Band Edge, Peak, 2480MHz, DH5 .....	65
Plot 101. Radiated Restricted Band Edge, Peak, Nonhopping, 2480MHz, 3-DH1 .....	66
Plot 102. Radiated Restricted Band Edge, Peak, Nonhopping, 2480MHz, 3-DH5 .....	66
Plot 103. Conducted Spurious Emissions, Hopping, DH1, 1 GHz – 18 GHz .....	69
Plot 104. Conducted Spurious Emissions, Hopping, DH5, 1 GHz – 18 GHz .....	69
Plot 105. Conducted Spurious Emissions, Hopping, 3-DH1, 1 GHz – 18 GHz .....	70
Plot 106. Conducted Spurious Emissions, Hopping, 3-DH5, 1 GHz – 18 GHz .....	70
Plot 107. Conducted Spurious Emissions, Nonhopping, 2402MHz, DH1, 1 GHz – 18 GHz .....	71
Plot 108. Conducted Spurious Emissions, Nonhopping, 2402MHz, DH5, 1 GHz – 18 GHz .....	71
Plot 109. Conducted Spurious Emissions, Nonhopping, 2402MHz, 3-DH1, 1 GHz – 18 GHz .....	72
Plot 110. Conducted Spurious Emissions, Nonhopping, 2402MHz, 3-DH5, 1 GHz – 18 GHz .....	72
Plot 111. Conducted Spurious Emissions, Nonhopping, 2441MHz, DH1, 1 GHz – 18 GHz .....	73
Plot 112. Conducted Spurious Emissions, Nonhopping, 2441MHz, DH5, 1 GHz – 18 GHz .....	73
Plot 113. Conducted Spurious Emissions, Nonhopping, 2441MHz, 3-DH1, 1 GHz – 18 GHz .....	74
Plot 114. Conducted Spurious Emissions, Nonhopping, 2441MHz, 3-DH5, 1 GHz – 18 GHz .....	74
Plot 115. Conducted Spurious Emissions, Nonhopping, 2480MHz, DH1, 1 GHz – 18 GHz .....	75
Plot 116. Conducted Spurious Emissions, Nonhopping, 2480MHz, DH5, 1 GHz – 18 GHz .....	75
Plot 117. Conducted Spurious Emissions, Nonhopping, 2480MHz, 3-DH1, 1 GHz – 18 GHz .....	76
Plot 118. Conducted Spurious Emissions, Nonhopping, 2480MHz, 3-DH5, 1 GHz – 18 GHz .....	76

## List of Figures

Figure 1. Block Diagram of Test Configuration.....	6
Figure 2. Block Diagram, Occupied Bandwidth Test Setup.....	13
Figure 3. Peak Power Output Test Setup.....	30
Figure 4. Block Diagram, Conducted Spurious Emissions Test Setup.....	68



## List of Terms and Abbreviations

<b>AC</b>	<b>Alternating Current</b>
<b>ACF</b>	<b>Antenna Correction Factor</b>
<b>Cal</b>	<b>Calibration</b>
<i>d</i>	<b>Measurement Distance</b>
<b>dB</b>	<b>Decibels</b>
<b>dB<math>\mu</math>A</b>	<b>Decibels above one microamp</b>
<b>dB<math>\mu</math>V</b>	<b>Decibels above one microvolt</b>
<b>dB<math>\mu</math>A/m</b>	<b>Decibels above one microamp per meter</b>
<b>dB<math>\mu</math>V/m</b>	<b>Decibels above one microvolt per meter</b>
<b>DC</b>	<b>Direct Current</b>
<b>E</b>	<b>Electric Field</b>
<b>DSL</b>	<b>Digital Subscriber Line</b>
<b>ESD</b>	<b>Electrostatic Discharge</b>
<b>EUT</b>	<b>Equipment Under Test</b>
<i>f</i>	<b>Frequency</b>
<b>FCC</b>	<b>Federal Communications Commission</b>
<b>GRP</b>	<b>Ground Reference Plane</b>
<b>H</b>	<b>Magnetic Field</b>
<b>HCP</b>	<b>Horizontal Coupling Plane</b>
<b>Hz</b>	<b>Hertz</b>
<b>IEC</b>	<b>International Electrotechnical Commission</b>
<b>kHz</b>	<b>kilohertz</b>
<b>kPa</b>	<b>kilopascal</b>
<b>kV</b>	<b>kilovolt</b>
<b>LISN</b>	<b>Line Impedance Stabilization Network</b>
<b>MHz</b>	<b>Megahertz</b>
<b><math>\mu</math>H</b>	<b>microhenry</b>
<b><math>\mu</math></b>	<b>microfarad</b>
<b><math>\mu</math>s</b>	<b>microseconds</b>
<b>NEBS</b>	<b>Network Equipment-Building System</b>
<b>PRF</b>	<b>Pulse Repetition Frequency</b>
<b>RF</b>	<b>Radio Frequency</b>
<b>RMS</b>	<b>Root-Mean-Square</b>
<b>TWT</b>	<b>Traveling Wave Tube</b>
<b>V/m</b>	<b>Volts per meter</b>
<b>VCP</b>	<b>Vertical Coupling Plane</b>

# I. Executive Summary

## A. Purpose of Test

An EMC evaluation was performed to determine compliance of the Ubiquiti Networks AF-LTU, with the requirements of Part §15.247. All references are to the most current version of Title 47 of the Code of Federal Regulations in effect. In accordance with §2.1033, the following data is presented in support of the Certification of the AF-LTU. Ubiquiti Networks should retain a copy of this document which should be kept on file for at least two years after the manufacturing of the AF-LTU, has been **permanently** discontinued.

## B. Executive Summary

The following tests were conducted on a sample of the equipment for the purpose of demonstrating compliance with Part §15.247, in accordance with Ubiquiti Networks, purchase order number US101476. All tests were conducted using measurement procedure ANSI C63.10-2013.

FCC Reference 47 CFR Part 15.247:2005	Description	Compliance
Title 47 of the CFR, Part 15 §15.203	Antenna Requirement	Compliant
Title 47 of the CFR, Part 15 §15.207(a)	Conducted Emission Limits	Compliant
Title 47 of the CFR, Part 15 §15.247(a)(1)	20 dB Occupied Bandwidth	Compliant
	99% Occupied Bandwidth	Not Applicable
Title 47 of the CFR, Part 15 §15.247(a)(1)	Average Time of Occupancy (Dwell Time)	Compliant
Title 47 of the CFR, Part 15 §15.247(a)(1)	Number of RF Channels	Compliant
Title 47 of the CFR, Part 15 §15.247(a)(1)	RF Channel Separation	Compliant
Title 47 of the CFR, Part 15 §15.247(b)	Peak Power Output	Compliant
Title 47 of the CFR, Part 15 §15.247(d); §15.209; §15.205	Radiated Spurious Emissions	Compliant
Title 47 of the CFR, Part 15 §15.247(d)	Spurious Conducted Emissions	Compliant
Title 47 of the CFR, Part 15 §15.247(i)	Maximum Permissible Exposure (MPE)	Compliant

**Table 1. Executive Summary of EMC Part 15.247 Compliance Testing**

## II. Equipment Configuration

## A. Overview

MET Laboratories, Inc. was contracted by Ubiquiti Networks to perform testing on the AF-LTU, under Ubiquiti Networks' purchase order number US101476.

This document describes the test setups, test methods, required test equipment, and the test limit criteria used to perform compliance testing of the Ubiquiti Networks, AF-LTU.

The results obtained relate only to the item(s) tested.

<b>Model(s) Tested:</b>	AF-LTU	
<b>Model(s) Covered:</b>	AF-LTU	
<b>EUT Specifications:</b>	Primary Power: 120VAC; 60Hz	
	FCC ID: SWX-AF5LTU	
	Type of Modulations:	QPSK, GFSK
	Equipment Code:	DSS
	Peak RF Output Power:	7.43 dBm
	EUT Frequency Ranges:	2402MHz – 2480MHz
<b>Analysis:</b>	The results obtained relate only to the item(s) tested.	
<b>Environmental Test Conditions:</b>	Temperature: 15-35° C	
	Relative Humidity: 30-60%	
	Barometric Pressure: 860-1060 mbar	
<b>Evaluated by:</b>	Surendra Shrestha	
<b>Report Date(s):</b>	January 23, 2018	

**Table 2. EUT Summary Table**

## B. References

<b>CFR 47, Part 15, Subpart C</b>	Federal Communication Commission, Code of Federal Regulations, Title 47, Part 15: General Rules and Regulations, Allocation, Assignment, and Use of Radio Frequencies
<b>ANSI C63.4:2014</b>	Methods and Measurements of Radio-Noise Emissions from Low-Voltage Electrical And Electronic Equipment in the Range of 9 kHz to 40 GHz
<b>ISO/IEC 17025:2005</b>	General Requirements for the Competence of Testing and Calibration Laboratories
<b>ANSI C63.10-2013</b>	American National Standard for Testing Unlicensed Wireless Devices

**Table 3. References**

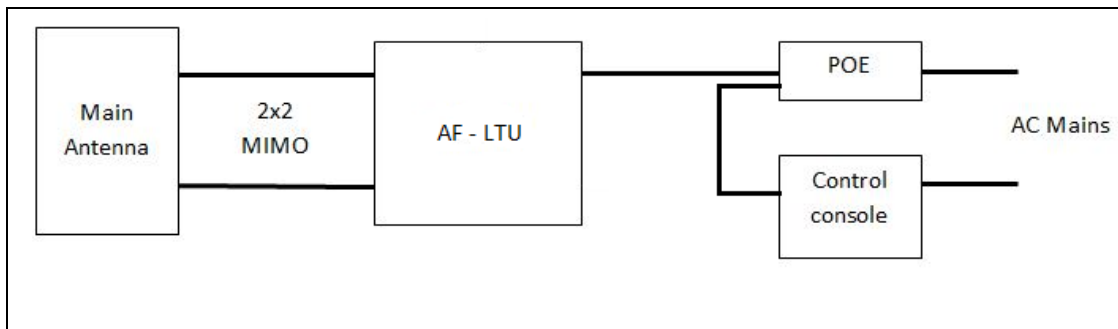
## C. Test Site

All testing was performed at MET Laboratories, Inc., 914 West Patapsco Avenue, Baltimore, Maryland 21230. All equipment used in making physical determinations is accurate and bears recent traceability to the National Institute of Standards and Technology.

Radiated Emissions measurements were performed in a 3 meter semi-anechoic chamber (equivalent to an Open Area Test Site). In accordance with §2.948(a)(3), a complete site description is contained at MET Laboratories.

## D. Description of Test Sample

The Ubiquiti Networks AF-LTU, Equipment Under Test (EUT), is a 5.150GHz – 5.850GHz, Digital Transmission radio that uses OFDM MIMO Uncorrelated Cross-Polarized communication with a 100/80/60/50MHz/40MHz/30MHz/28MHz/ 20MHz/10MHz/ 7MHz/5MHz/3.5MHz bandwidth configuration. The EUT would be used outdoors and pole mounted. It is powered from a PoE adapter. The reverse-polarized connectorized has the ability when professionally installed by a user with cross-polarized antennas. This is the only matter that would be able to create a functional link to work.



**Figure 1. Block Diagram of Test Configuration**

## E. Equipment Configuration

The EUT was set up as outlined in Figure 1, Block Diagram of Test Setup. All cards, racks, etc., incorporated as part of the EUT is included in the following list.

Ref. ID	Name / Description	Model Number	Part Number	Serial Number	Revision
1	Switching Gigabit Power Supply	GP-H240-100G-4	1514	0000936	--
	Ethernet Cables	N/A	N/A	N/A	--
	13 dBi Asymmetrical horn	PrismAP-5-90	N/A	N/A	
	19 dBi symmetrical horn	PrismAP-5-30	N/A	N/A	
	27 dBi Slant Dish	LTU-Extend	N/A	N/A	

**Table 4. Equipment Configuration**

## F. Support Equipment

Support equipment necessary for the operation and testing of the EUT is included in the following list.

Ref. ID	Name / Description	Manufacturer	Model Number	*Customer Supplied Calibration Data
1	Laptop	Apple	MacBook Pro	N/A

Table 5. Support Equipment

## G. Ports and Cabling Information

Ref. ID	Port Name on EUT	Cable Description	Qty.	Length (m)	Shielded (Y/N)	Termination Point
1	Data Port	RJ45 Ethernet	1	2	Yes	

Table 6. Ports and Cabling Information

## H. Mode of Operation

Using internal test modes only for testing purposes the radio is set up in a continuous transmit mode. This allows for frequency, power, and channel bandwidth to be adjusted for measurement purposes. Scripts and specific command line commands are used to manipulate the radio in test mode.

## I. Method of Monitoring EUT Operation

1. A blinking green “Data” LED will indicate error-free data is being transferred on the test cable.
2. Any other LED status besides the blinking green LED (i.e. LED light off, etc.) will indicate error-free data is not being transferred on the test cable.

## J. Modifications

- a) **Modifications to EUT**  
No modifications were made to the EUT.
- b) **Modifications to Test Standard**  
No modifications were made to the test standard.

## K. Disposition of EUT

The test sample including all support equipment submitted to the Electro-Magnetic Compatibility Lab for testing was returned to Ubiquiti Networks upon completion of testing.



### **III. Electromagnetic Compatibility Criteria for Intentional Radiators**

## Electromagnetic Compatibility Criteria for Intentional Radiators

### § 15.203 Antenna Requirement

**Test Requirement:** § 15.203: An intentional radiator shall be designed to ensure that no antenna other than that furnished by the responsible party shall be used with the device. The use of a permanently attached antenna or of an antenna that uses a unique coupling to the intentional radiator shall be considered sufficient to comply with the provisions of this section. The manufacturer may design the unit so that a broken antenna can be replaced by the user, but the use of a standard antenna jack or electrical connector is prohibited.

The structure and application of the EUT were analyzed to determine compliance with Section 15.203 of the Rules. Section 15.203 states that the subject device must meet at least one of the following criteria:

- a.) Antenna must be permanently attached to the unit.
- b.) Antenna must use a unique type of connector to attach to the EUT.
- c.) Unit must be professionally installed. Installer shall be responsible for verifying that the correct antenna is employed with the unit.

**Results:** The EUT as tested is compliant the criteria of §15.203. The EUT has an integral antenna.

**Test Engineer(s):** Surendra Shrestha

**Test Date(s):** 01/18/2018

## Electromagnetic Compatibility Criteria for Intentional Radiators

### § 15.207(a) Conducted Emissions Limits

**Test Requirement(s):** § 15.207 (a): For an intentional radiator that is designed to be connected to the public utility (AC) power line, the radio frequency voltage that is conducted back onto the AC power line on any frequency or frequencies, within the band 150 kHz to 30MHz, shall not exceed the limits in the following table, as measured using a 50  $\mu$ H/50  $\Sigma$  line impedance stabilization network (LISN). Compliance with the provisions of this paragraph shall be based on the measurement of the radio frequency voltage between each power line and ground at the power terminal. The lower limit applies at the boundary between the frequency ranges.

Frequency range (MHz)	§ 15.207(a), Conducted Limit (dB $\mu$ V)	
	Quasi-Peak	Average
* 0.15- 0.45	66 - 56	56 - 46
0.45 - 0.5	56	46
0.5 - 30	60	50

**Table 7. Conducted Limits for Intentional Radiators from FCC Part 15 § 15.207(a)**

**Test Procedure:** The EUT was placed on a 0.8 m-high wooden table inside a screen room. The EUT was situated such that the back of the EUT was 0.4 m from one wall of the vertical ground plane, and the remaining sides of the EUT were no closer than 0.8 m from any other conductive surface. The EUT was powered from a 50  $\Omega$ /50  $\mu$ H Line Impedance Stabilization Network (LISN). The EMC receiver scanned the frequency range from 150 kHz to 30 MHz. Conducted Emissions measurements were made in accordance with *ANSI C63.4-2014 "Methods and Measurements of Radio-Noise Emissions from Low-Voltage Electrical and Electronic Equipment in the Range of 9kHz to 40 GHz"*. The measurements were performed over the frequency range of 0.15 MHz to 30 MHz using a 50  $\Omega$ /50  $\mu$ H LISN as the input transducer to an EMC/field intensity meter. For the purpose of this testing, the transmitter was turned on. Scans were performed with the transmitter on.

**Test Results:** The EUT was compliant with this requirement. Measured emissions were below applicable limits.

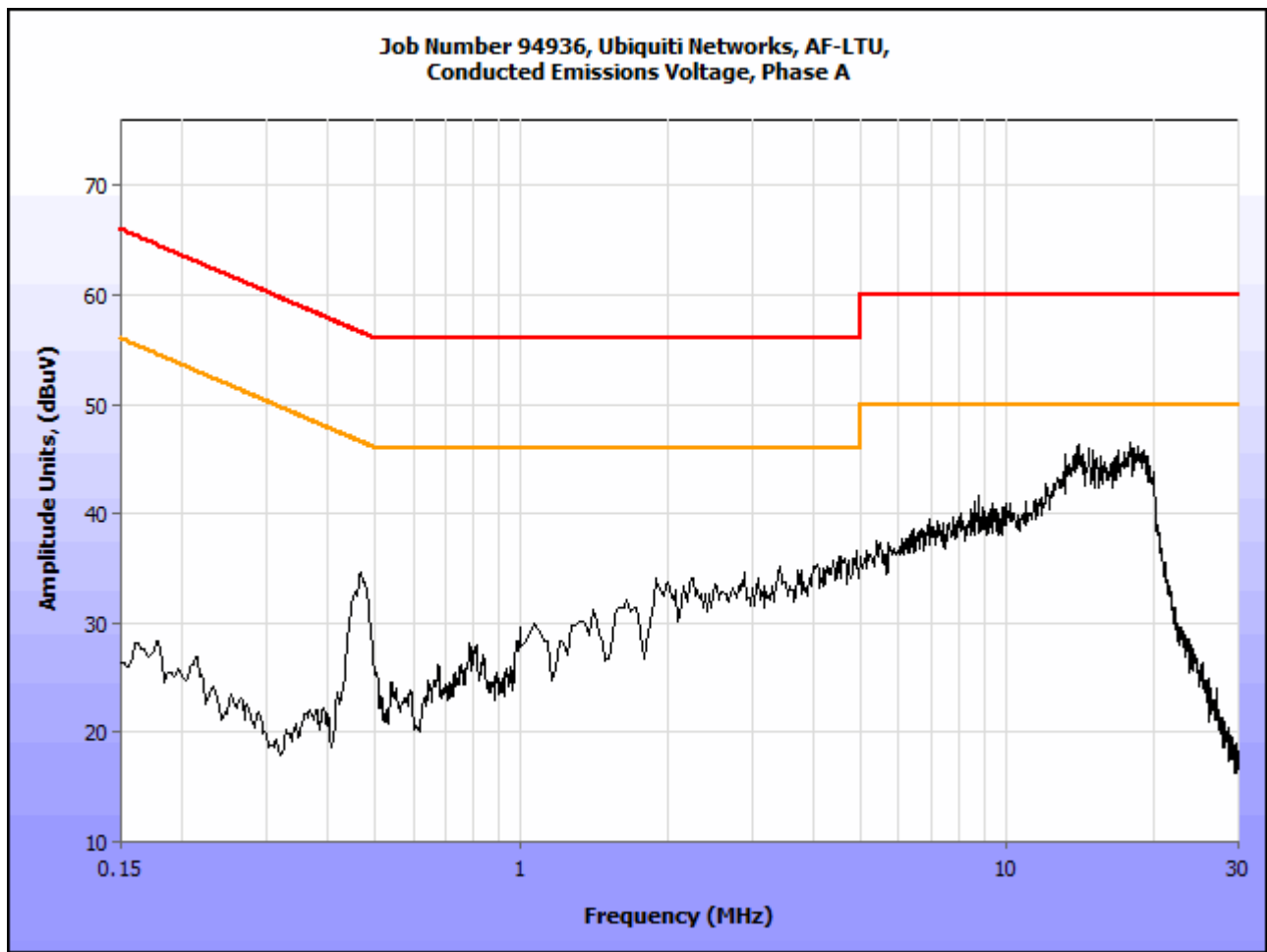
**Test Engineer(s):** Surendra Shrestha

**Test Date(s):** 01/18/2018

### 15.207(a) Conducted Emissions Test Results

Frequency (MHz)	Uncorrected Meter Reading (dBuV) QP	Cable Loss (dB)	Corrected Measurement (dBuV) QP	Limit (dBuV) QP	Margin (dB) QP	Uncorrected Meter Reading (dBuV) Avg.	Cable Loss (dB)	Corrected Measurement (dBuV) AVG	Limit (dBuV) AVG	Margin (dB) AVG
0.4619	29.96	0	29.96	56.66	-26.7	22.88	0	22.88	46.66	-23.78
13.83	40.43	0.12	40.55	60	-19.45	33.9	0.12	34.02	50	-15.98

Table 8. Conducted Emissions, 15.207(a), Phase Line, Test Results

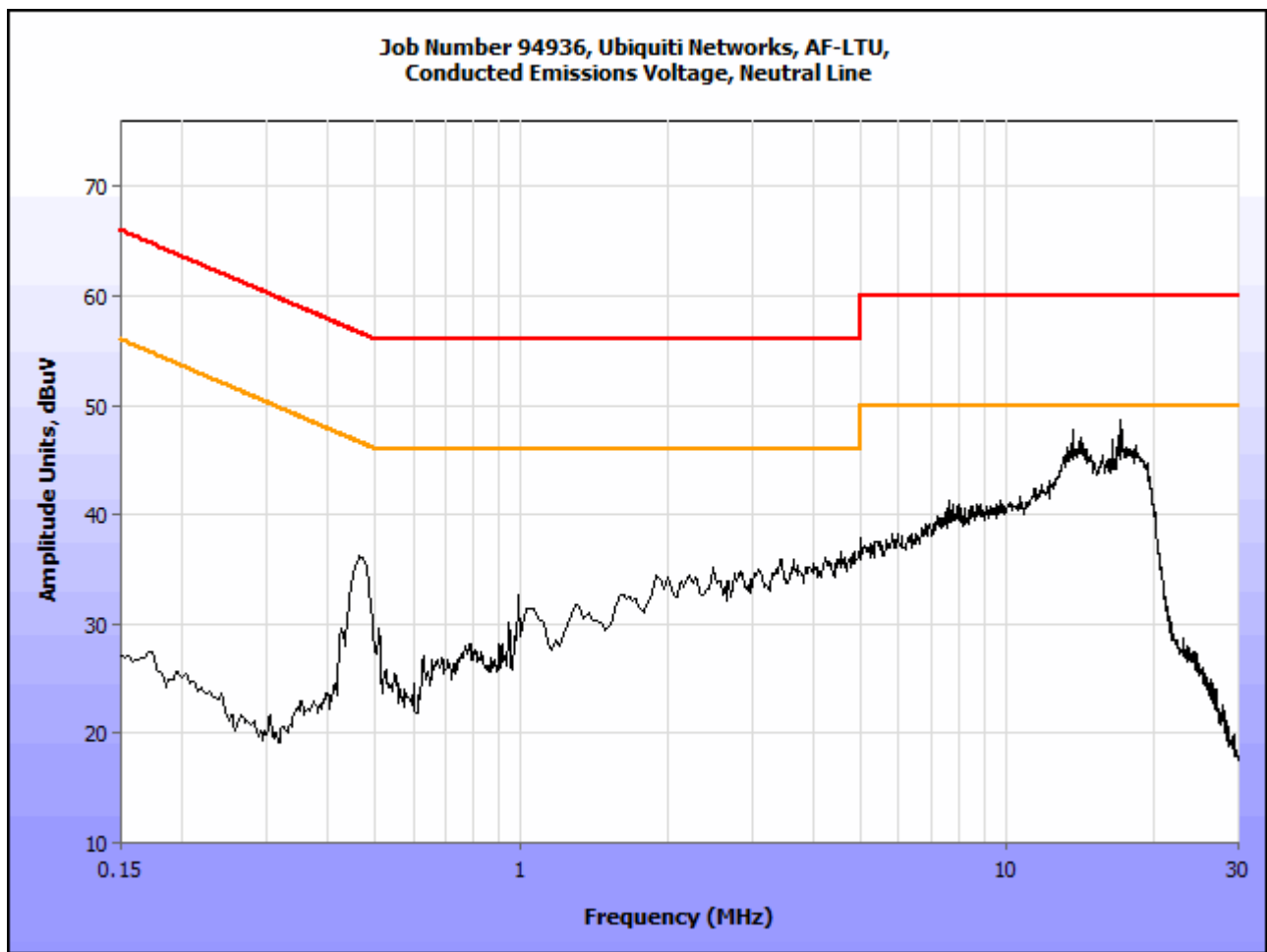


Plot 1. Conducted Emissions, 15.207(a), Phase Line

### 15.207(a) Conducted Emissions Test Results

Frequency (MHz)	Uncorrected Meter Reading (dBuV) QP	Cable Loss (dB)	Corrected Measurement (dBuV) QP	Limit (dBuV) QP	Margin (dB) QP	Uncorrected Meter Reading (dBuV) Avg.	Cable Loss (dB)	Corrected Measurement (dBuV) AVG	Limit (dBuV) AVG	Margin (dB) AVG
0.4675	34.07	0	34.07	56.56	-22.49	28.16	0	28.16	46.56	-18.4
17.47	42.8	0.14	42.94	60	-17.06	37.47	0.14	37.61	50	-12.39

Table 9. Conducted Emissions, 15.207(a), Neutral Line, Test Results



Plot 2. Conducted Emissions, 15.207(a), Neutral Line

## Electromagnetic Compatibility Criteria for Intentional Radiators

### § 15.247(a)(1) 20 dB Occupied Bandwidth

**Test Requirements:** § 15.247(a): Operation under the provisions of this section is limited to frequency hopping and digitally modulated intentional radiators that comply with the following provisions:

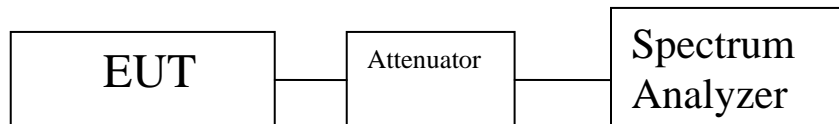
For systems using digital modulation techniques, the EUT may operate in the 902-928 MHz, 2400-2483.5 MHz and 5725-5850 MHz bands. For DTS, the minimum 6 dB bandwidth shall be at least 500 kHz. For frequency hopping systems, the EUT shall have hopping channel carrier frequencies separated by a minimum of 25 kHz or the 20 dB bandwidth of the hopping channel, whichever is greater.

**Test Procedure:** The bandwidth of the fundamental frequency was measured with the spectrum analyzer using a RBW approximately equal to 1% of the total emission bandwidth. The 20 dB bandwidth was measured and recorded.

**Test Results** The EUT was compliant with § 15.247 (a)(2).

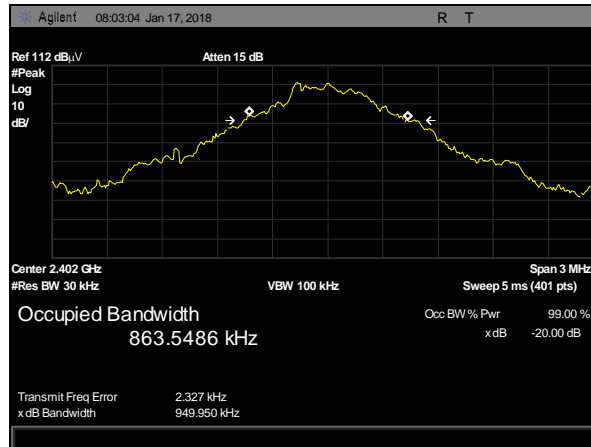
**Test Engineer(s):** Surendra Shrestha

**Test Date(s):** 01/17/2018

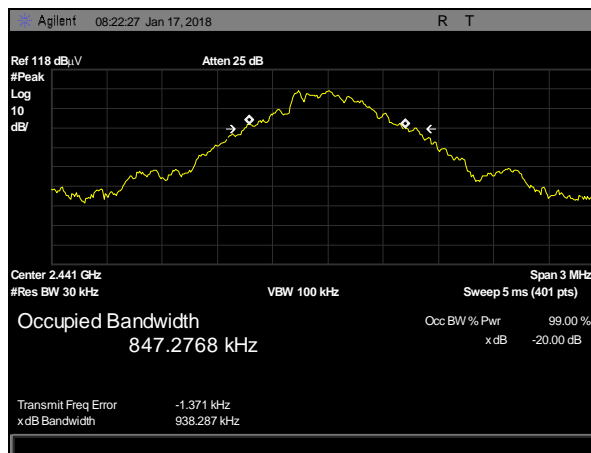


**Figure 2. Block Diagram, Occupied Bandwidth Test Setup**

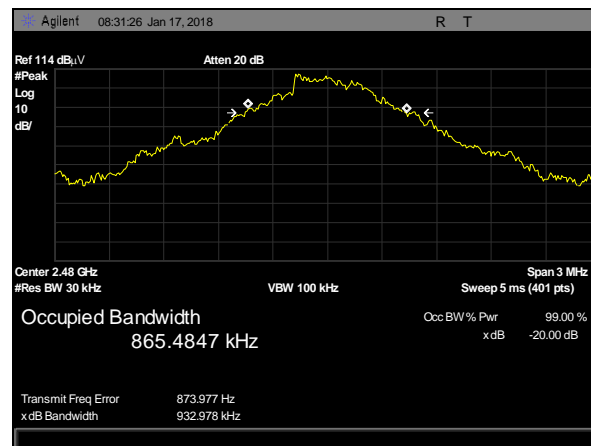
## 20 dB Occupied Bandwidth Test Results



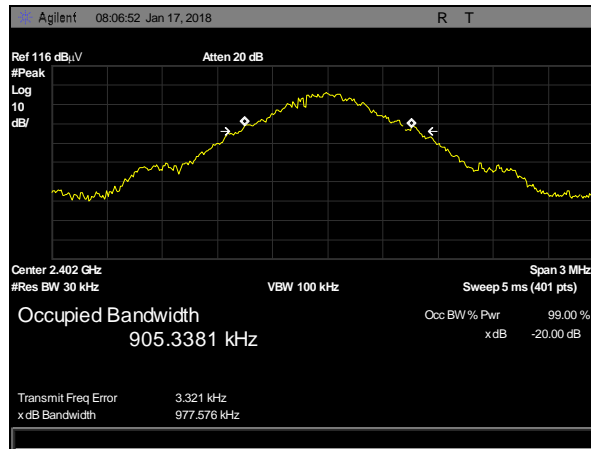
**Plot 3. 20 dB Occupied Bandwidth, DH1, 2402 MHz**



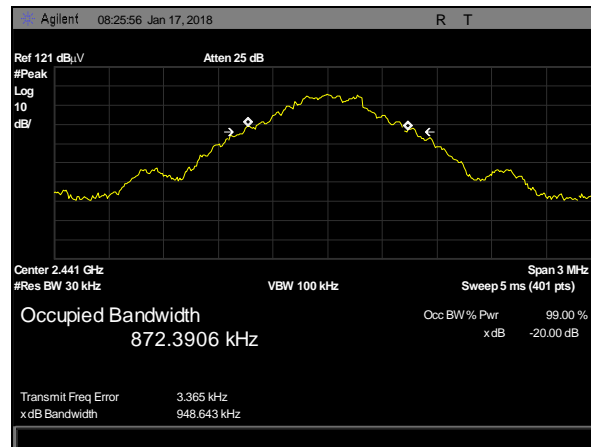
**Plot 4. 20 dB Occupied Bandwidth, DH1, 2441 MHz**



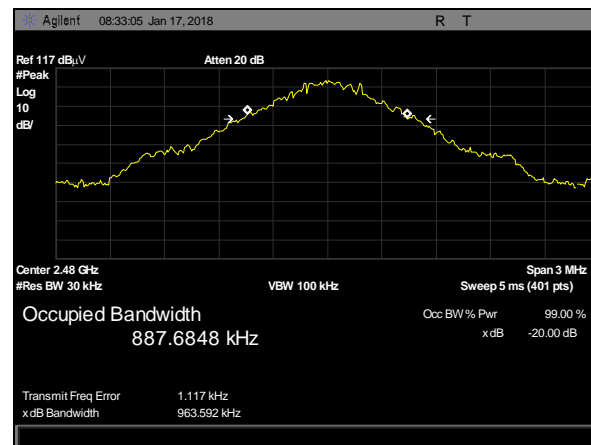
**Plot 5. 20 dB Occupied Bandwidth, DH1, 2480 MHz**



**Plot 6. 20 dB Occupied Bandwidth, DH5, 2402 MHz**

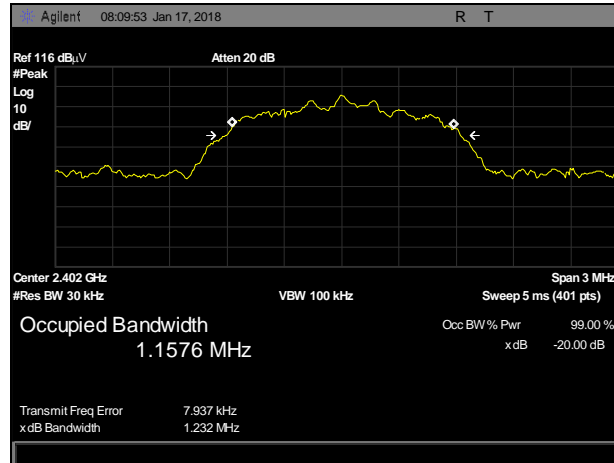


**Plot 7. 20 dB Occupied Bandwidth, DH5, 2441 MHz**

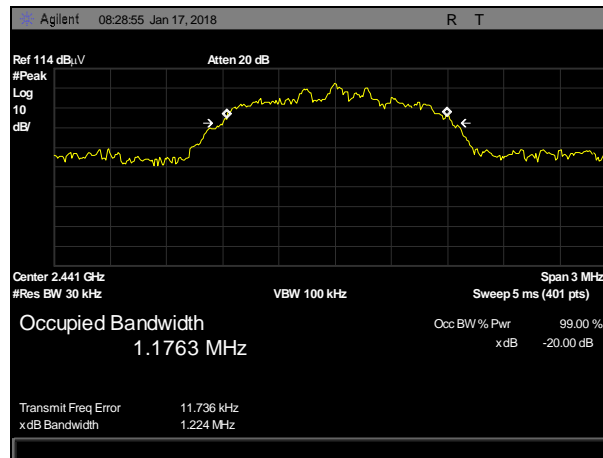


**Plot 8. 20 dB Occupied Bandwidth, DH5, 2480 MHz**

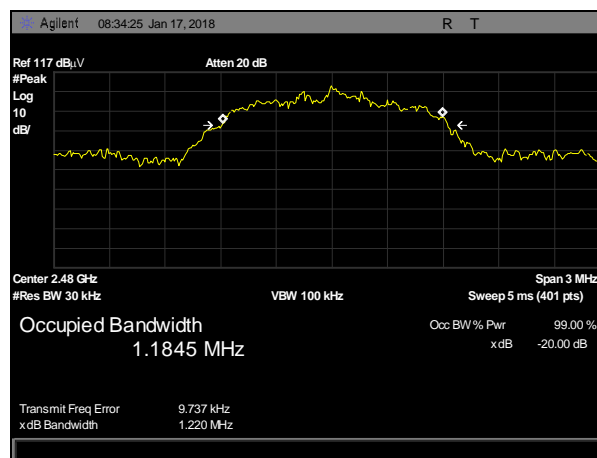




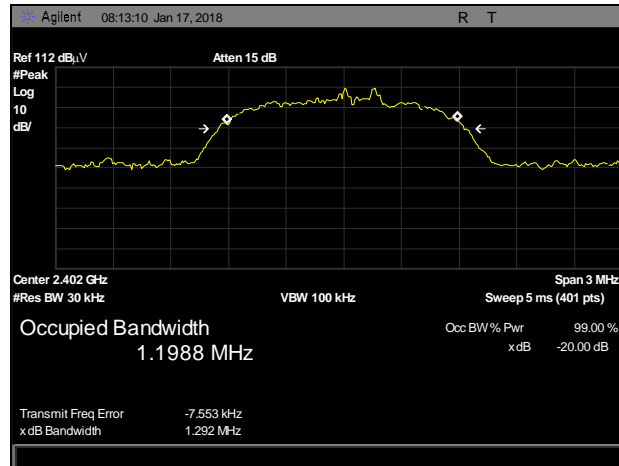
**Plot 9. 20 dB Occupied Bandwidth, 3-DH1, 2402 MHz**



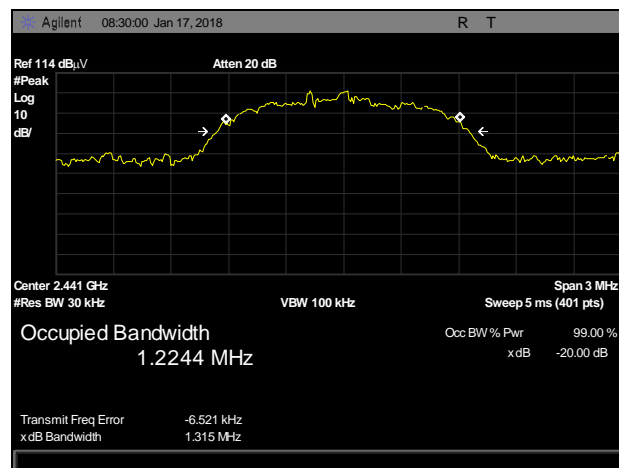
**Plot 10. 20 dB Occupied Bandwidth, 3-DH1, 2441 MHz**



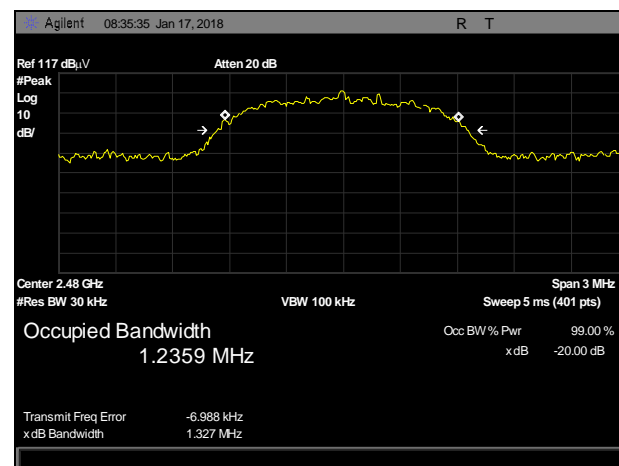
**Plot 11. 20 dB Occupied Bandwidth, 3-DH1, 2480 MHz**



**Plot 12. 20 dB Occupied Bandwidth, 3-DH5, 2402 MHz**



**Plot 13. 20 dB Occupied Bandwidth, 3-DH5, 2441 MHz**



**Plot 14. 20 dB Occupied Bandwidth, 3-DH5, 2480 MHz**

## Electromagnetic Compatibility Criteria for Intentional Radiators

### § 15.247(a)(1) Average Time of Occupancy (Dwell Time)

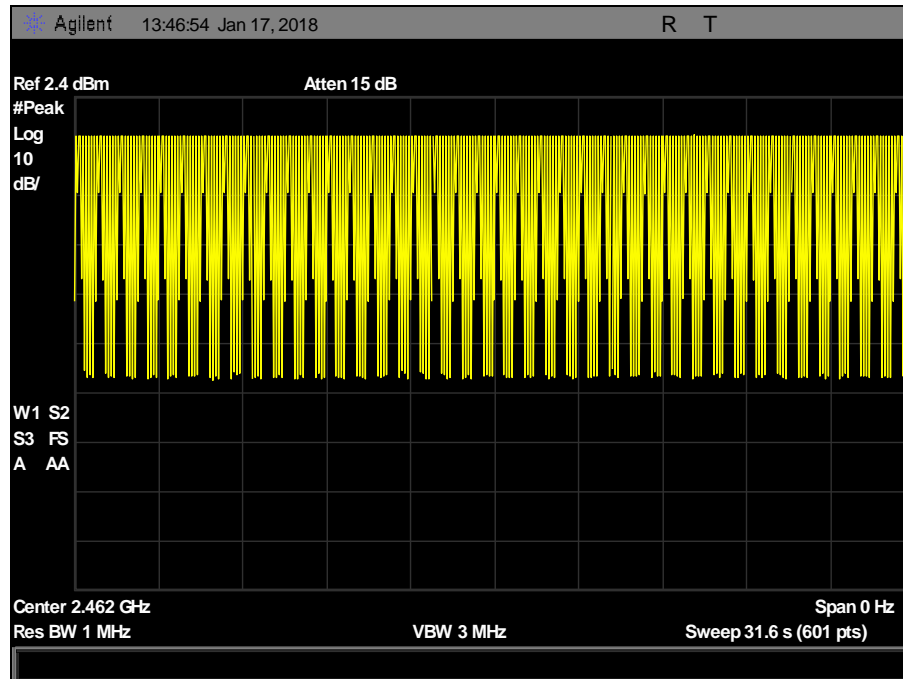
**Remarks:** The average time of occupancy on any frequency shall not be greater than 0.4 seconds within a 20 second period.

Total hopping channels is 79. The EUT meets the specifications of Section 15.247(a) (1) (iii) for Number of Hopping Channels.

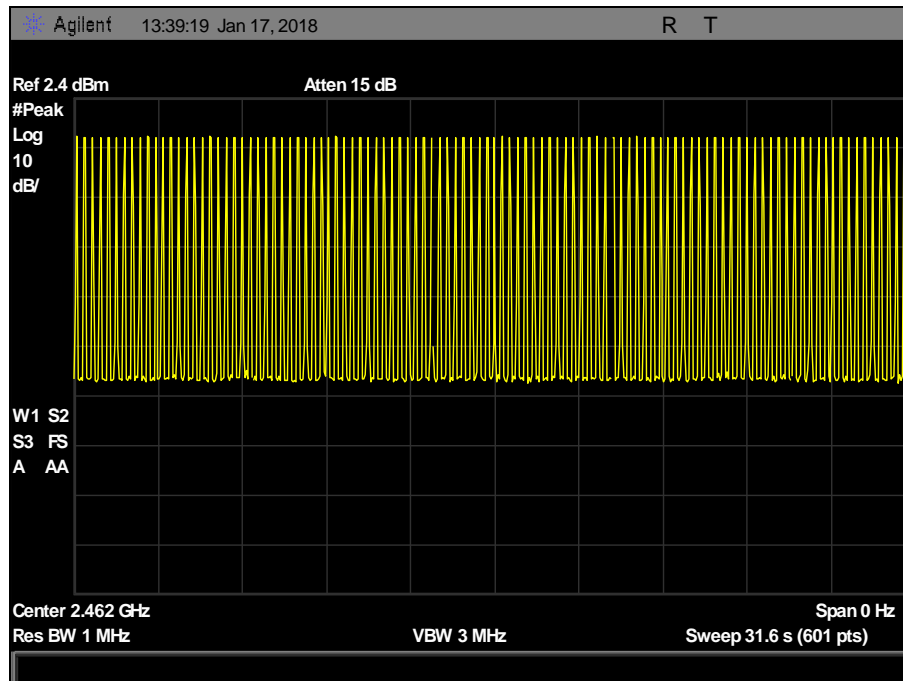
Data Rate	# of channels	hopping period (s)	# of burst per period	Burst Duration (s)	Dwell Time (s)	limit (s)	Margin
DH1	79	31.6	322	0.0003987	0.128381	0.4	-0.27162
DH5	79	31.6	107	0.00299	0.319609	0.4	-0.08039
3-DH1	79	31.6	316	0.0004091	0.129276	0.4	-0.27072
3-DH5	79	31.6	107	0.002925	0.312975	0.4	-0.08703

**Table 10. Dwell Time Calculation**

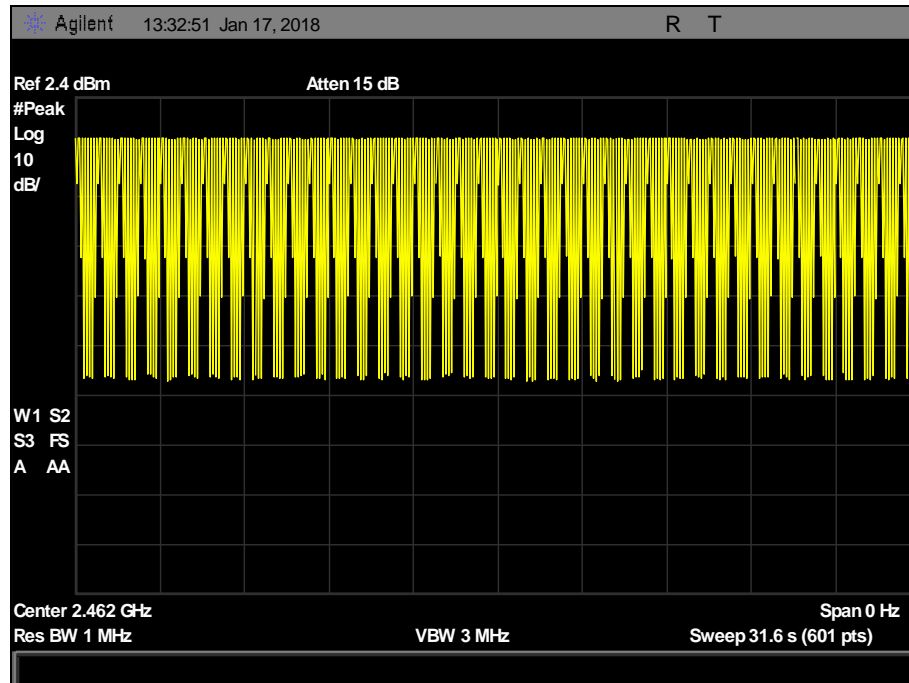
## Dwell Time



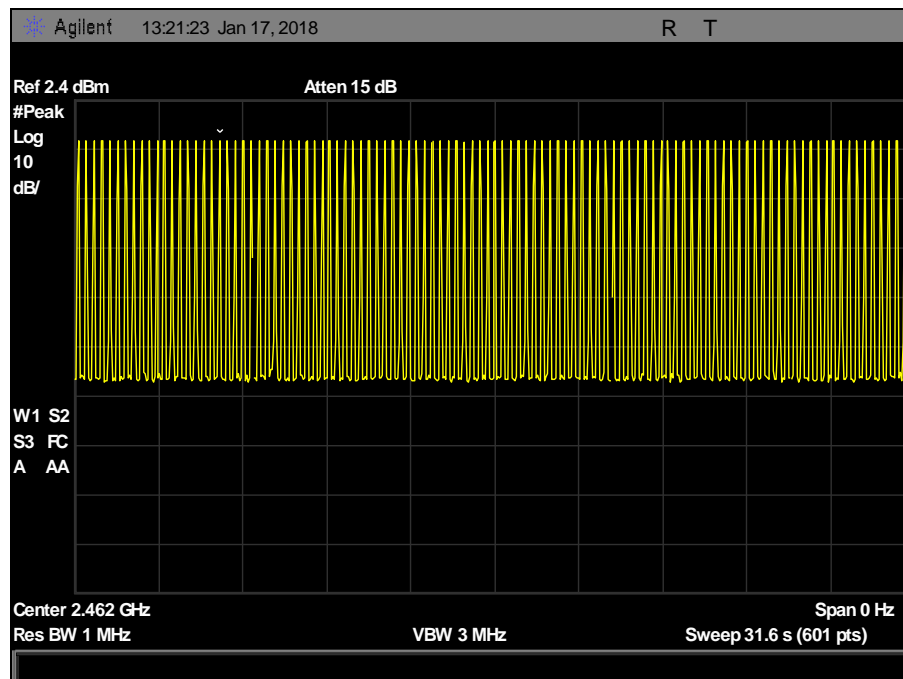
Plot 15. Dwell Time, DH1 Burst



Plot 16. Dwell Time, DH5 Burst

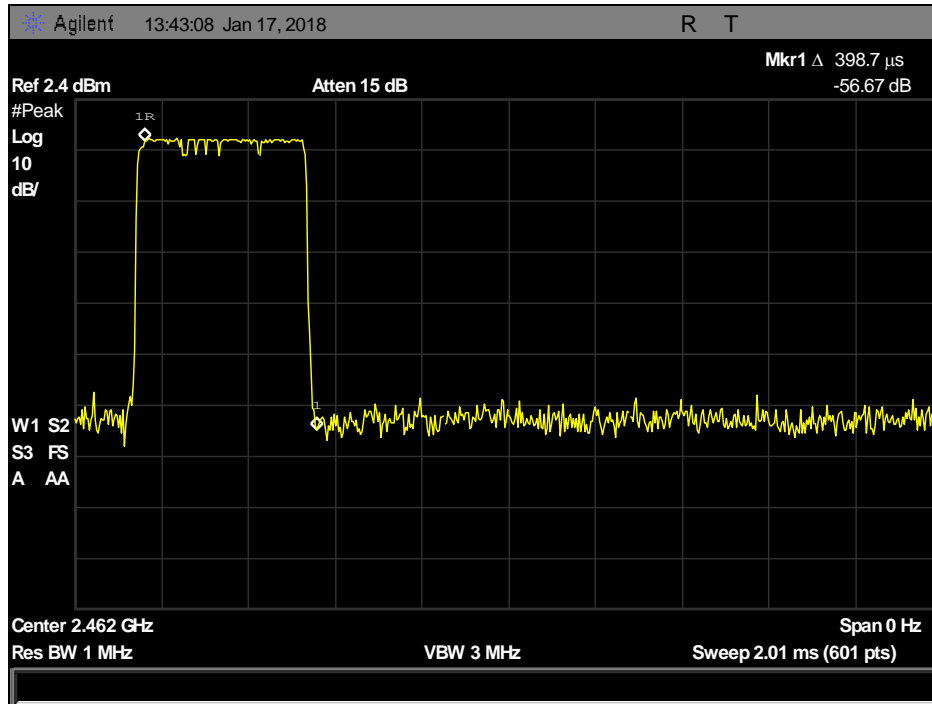


Plot 17. Dwell Time, 3-DH1 Burst

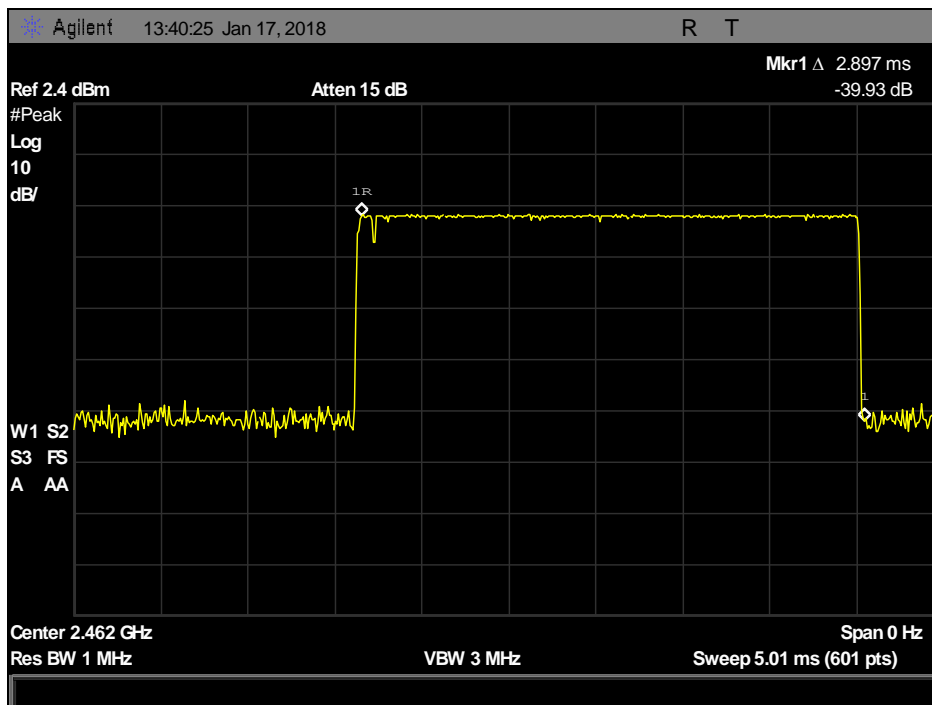


Plot 18. Dwell Time, 3-DH5 Burst

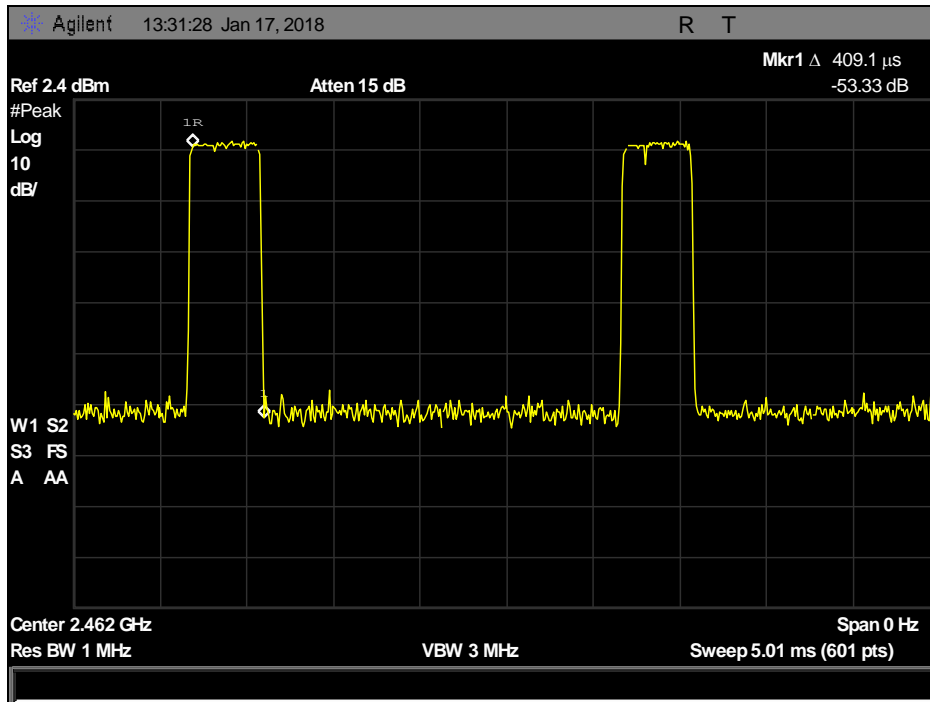
## Number of Pulses



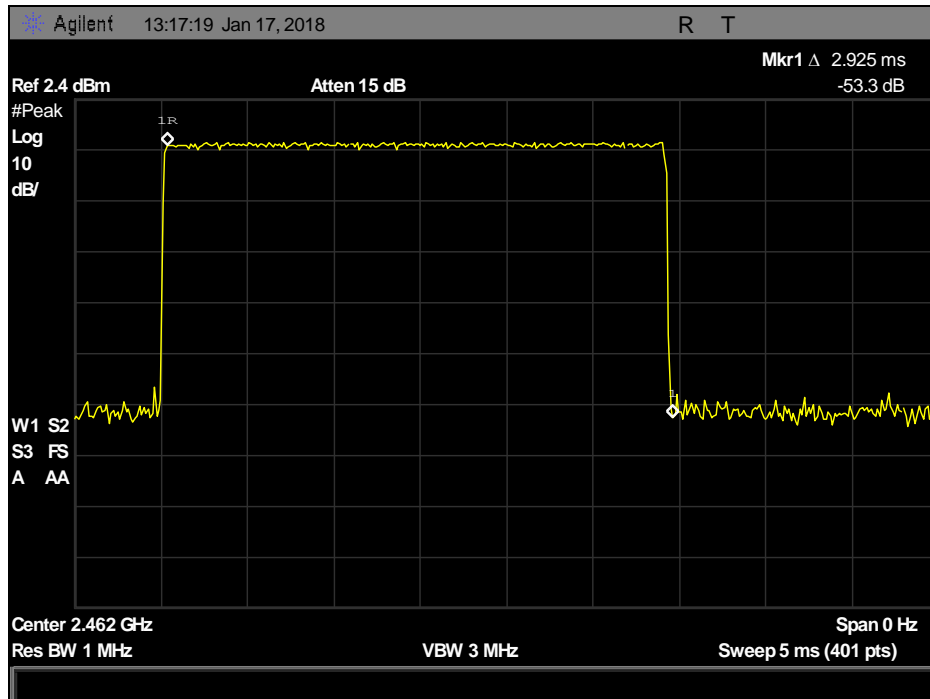
Plot 19. DH1 Pulse Width



Plot 20. DH5 Pulse Width



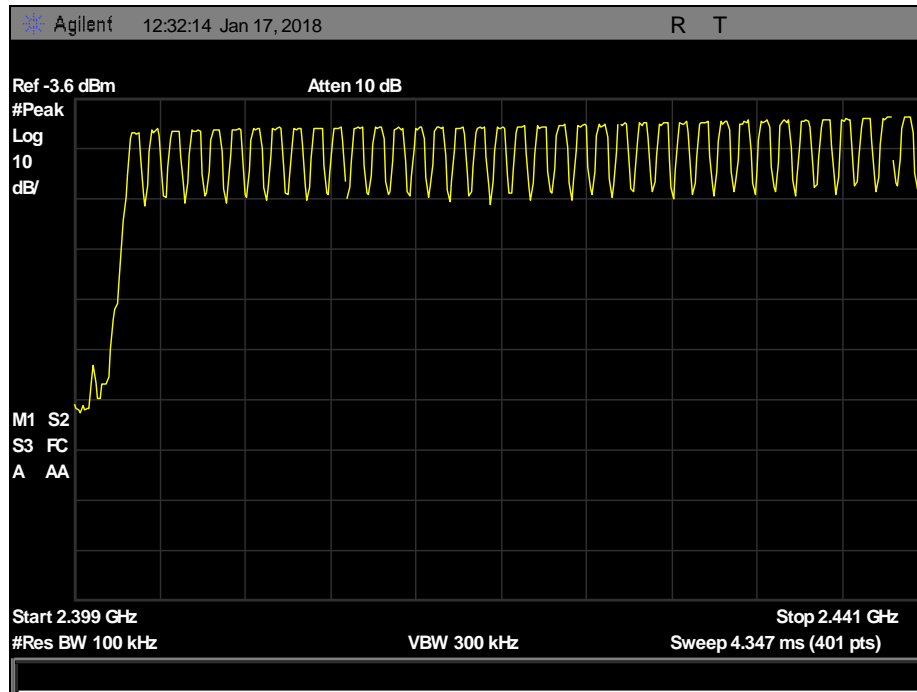
Plot 21. 3-DH1 Pulse Width



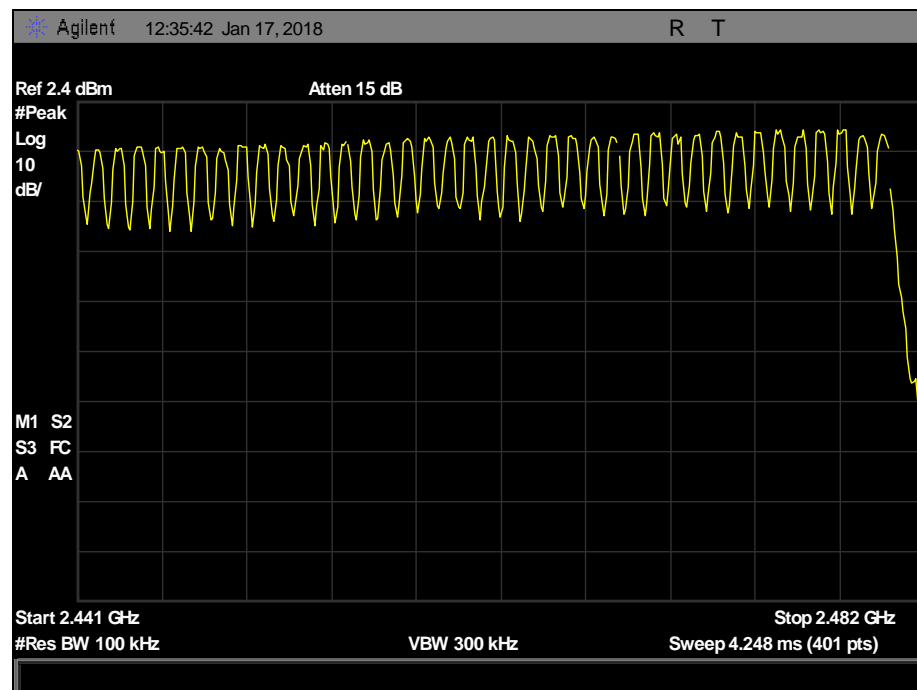
Plot 22. 3-DH5 Pulse Width

## Electromagnetic Compatibility Criteria for Intentional Radiators

### § 15.247(a)(1) Number of RF Channels

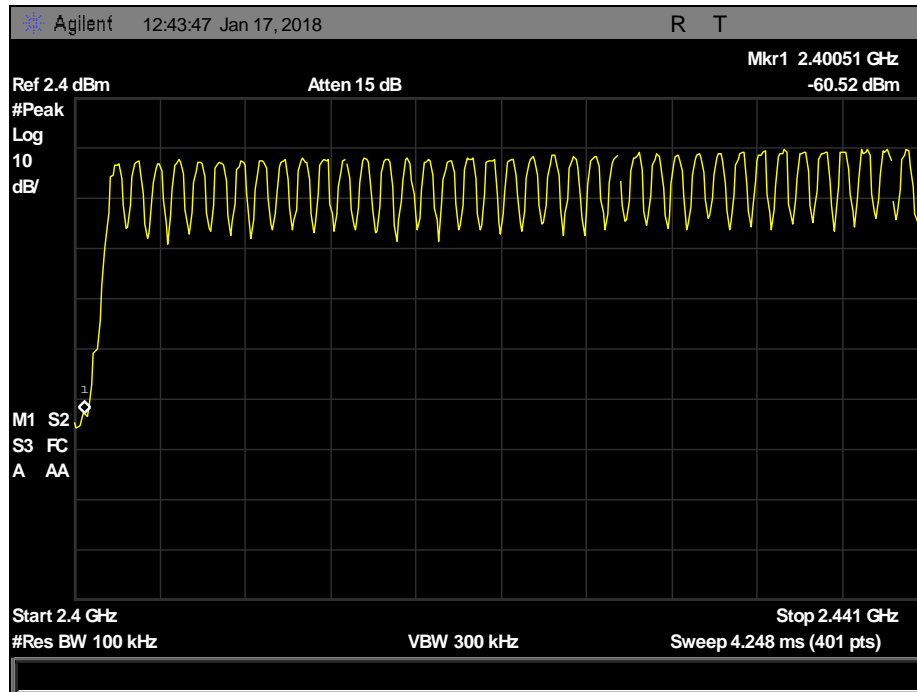


Plot 23. Number of Channels, DH1.1

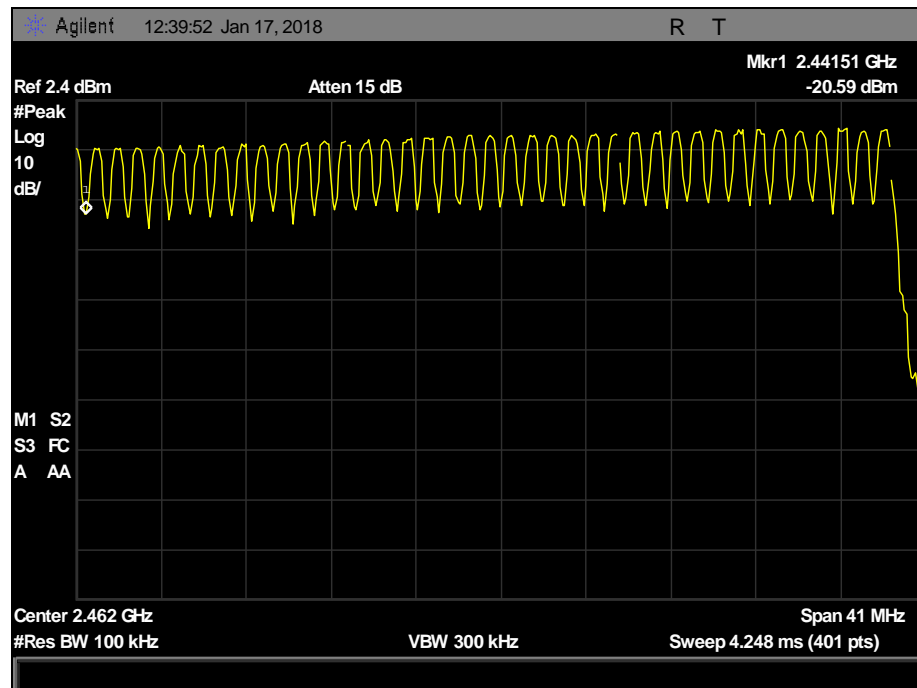


Plot 24. Number of Channels, DH1.2

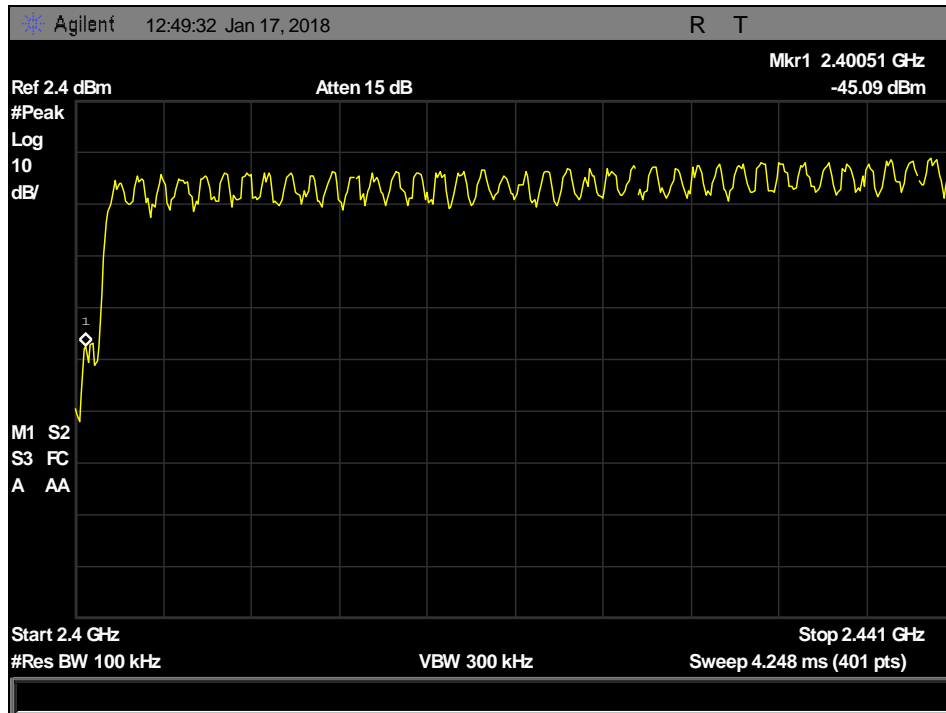




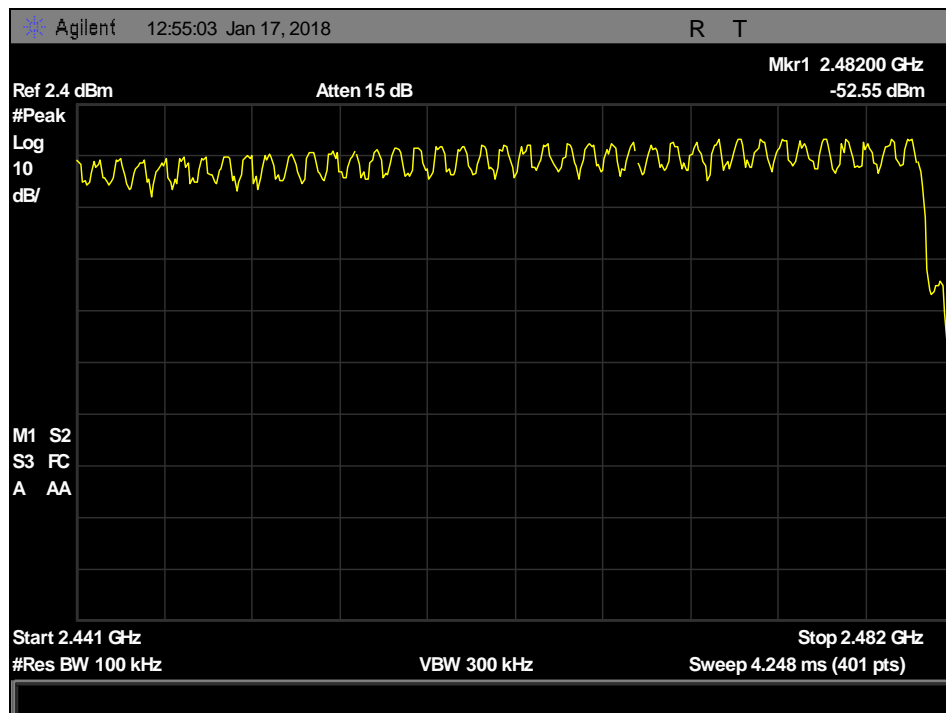
Plot 25. Number of Channels, DH5.1



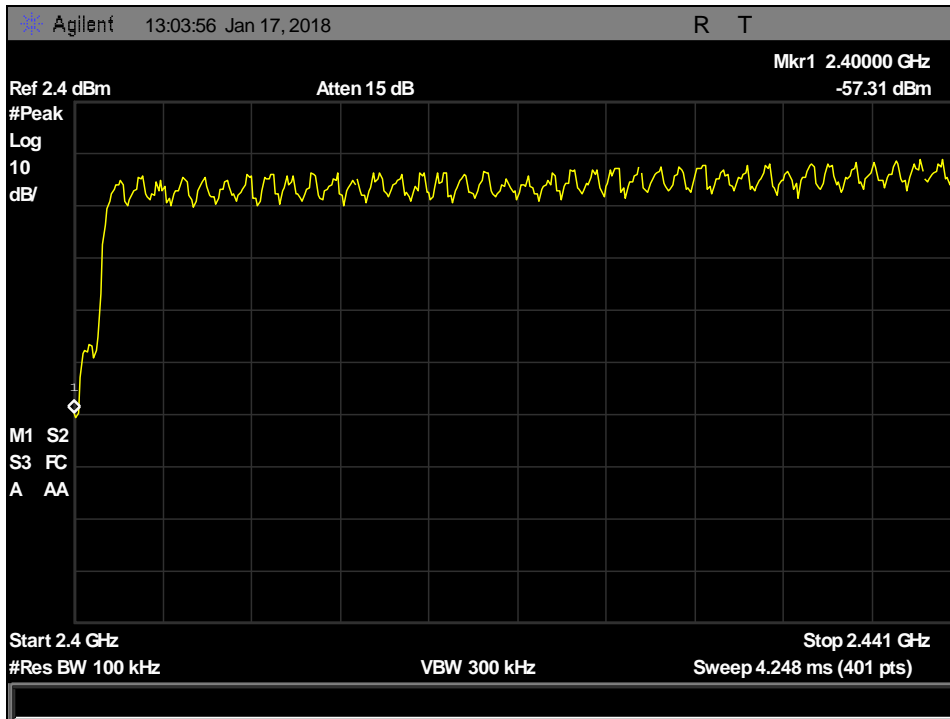
Plot 26. Number of Channels, DH5.2



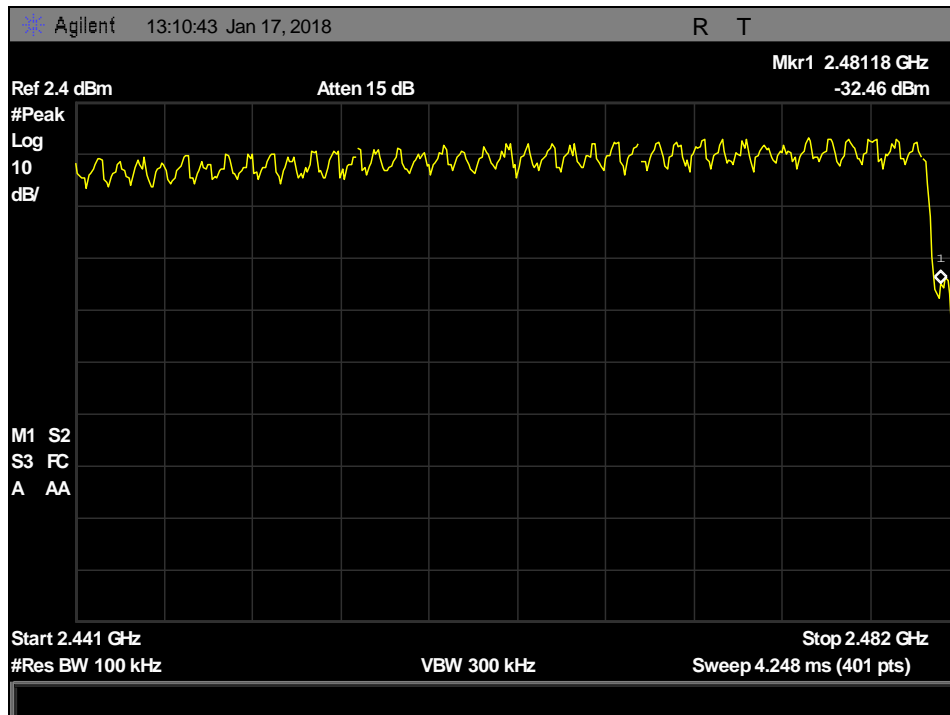
Plot 27. Number of Channels, 3-DH1.1



Plot 28. Number of Channels, 3-DH1.2



Plot 29. Number of Channels, 3-DH5.1



Plot 30. Number of Channels, 3-DH5.5

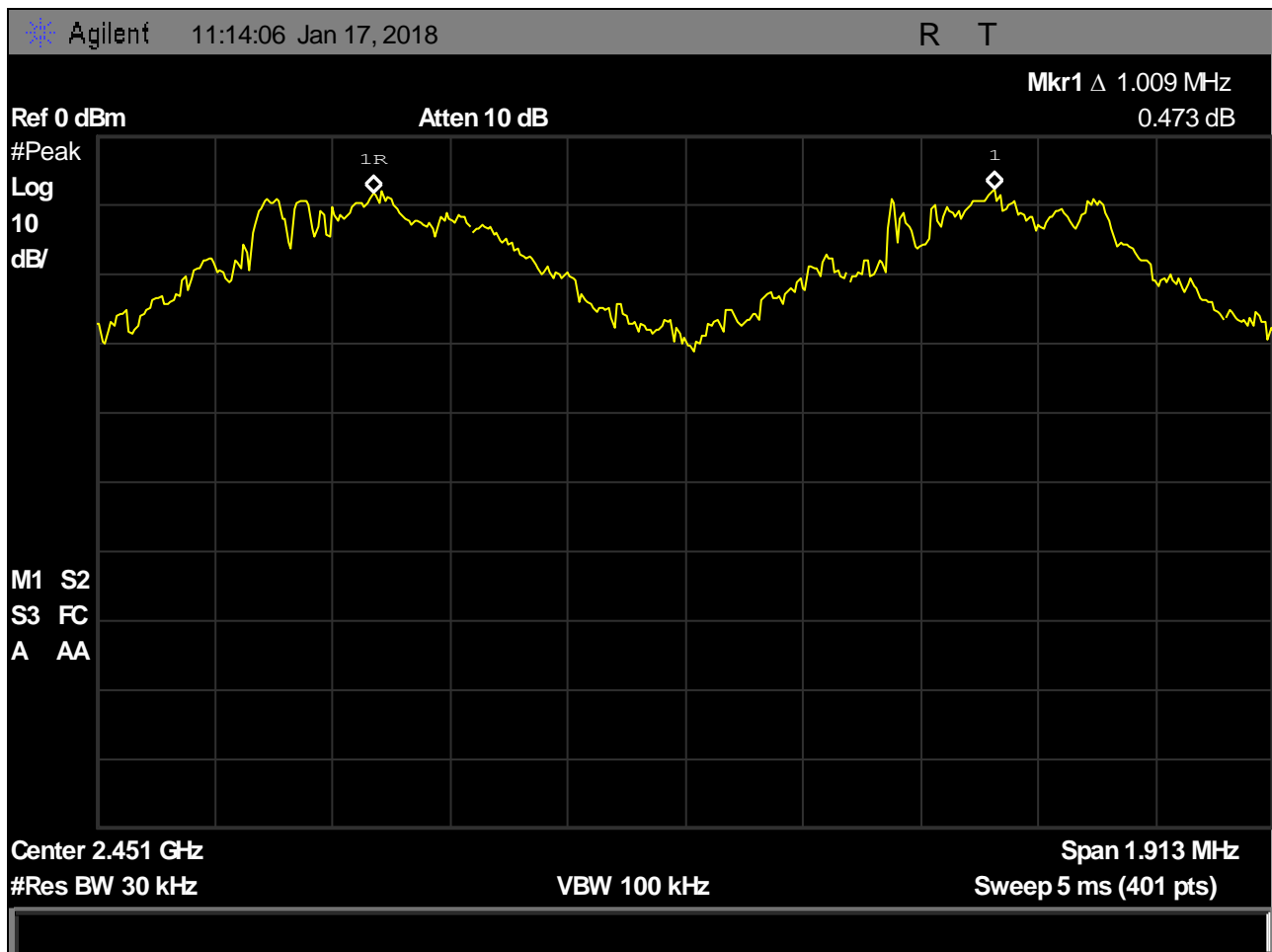
## Electromagnetic Compatibility Criteria for Intentional Radiators

### § 15.247(a)(1) RF Channel Separation

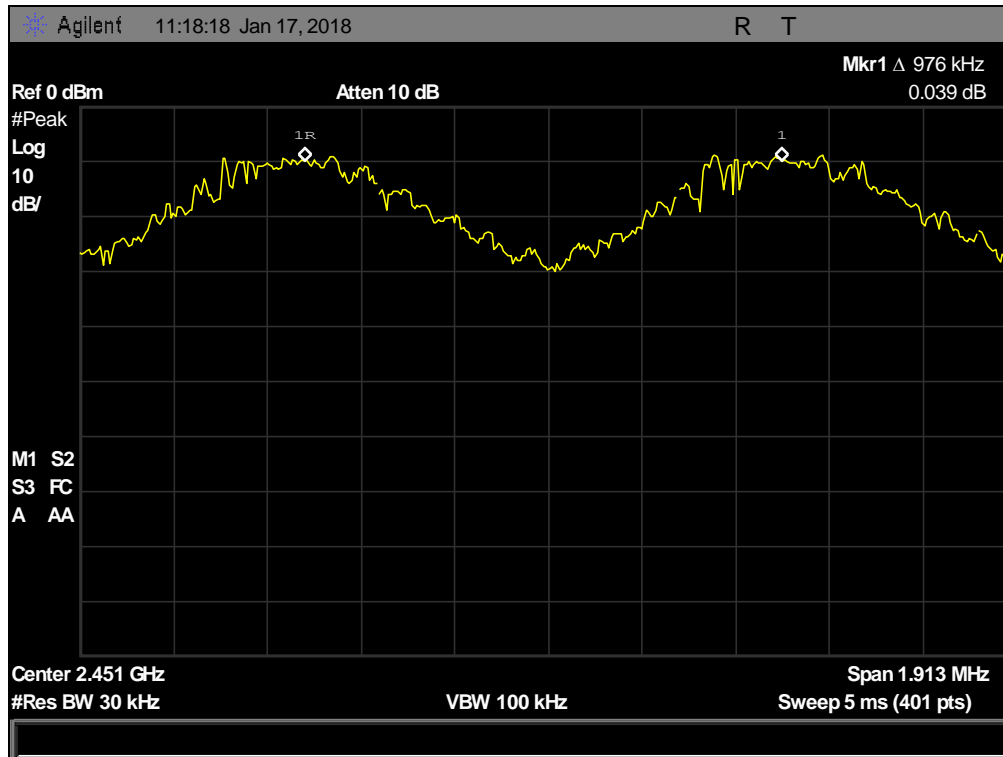
**Requirement:** Frequency hopping systems shall have hopping channel carrier frequencies separated by a minimum of 25 kHz or the 20 dB bandwidth of the hopping channel, whichever is greater. Alternatively, frequency hopping systems operating in the 2400–2483.5 MHz band may have hopping channel carrier frequencies that are separated by 25 kHz or two-thirds of the 20 dB bandwidth of the hopping channel, whichever is greater, provided the systems operate with an output power no greater than 125 mW.

**Remarks:** EUT operates below 125mW (20dBm). Channels are separated by more than two thirds of the -20dB Bandwidth.

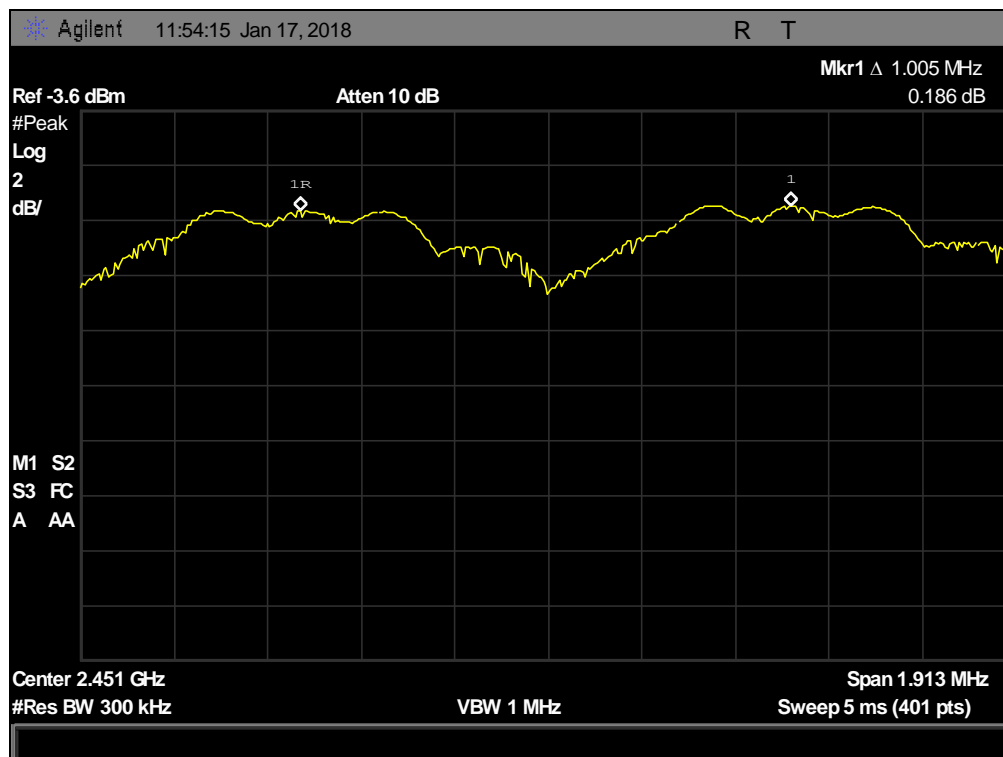
$$\text{EDR} - 2/3 * 1.393 \text{ MHz (20dB Bandwidth)} = 929 \text{ kHz Minimum Separation Distance}$$



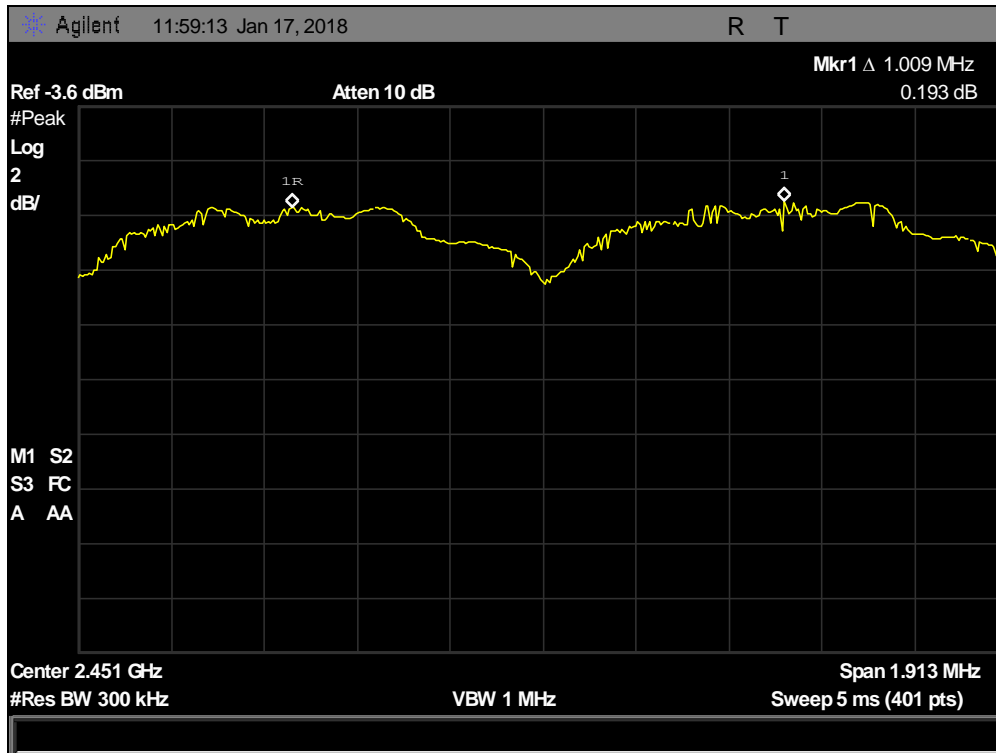
Plot 31. Channel Separation, DH1



Plot 32. Channel Separation, DH5



Plot 33. Channel Separation, 3-DH1



Plot 34. Channel Separation, 3-DH5

## Electromagnetic Compatibility Criteria for Intentional Radiators

### § 15.247(b) Peak Power Output

**Test Requirements:** §15.247(b)(1): The maximum peak output power of the intentional radiator shall not exceed 0.125 Watts for frequency hopping systems operating in the 2400-2483.5 MHz band. .

§15.247(c): if transmitting antennas of directional gain greater than 6 dBi are used the peak output power from the intentional radiator shall be reduced below the stated values, as appropriate, by the amount in dB that the directional gain of the antenna exceeds 6 dBi.

Systems operating in the 2400 – 2483.5 MHz band and using a point to point application may employ transmitting antennas with directional gain greater than 6 dBi provided the maximum peak output power of the intentional radiator is reduced by 1 dB for every 3 dB that the directional gain of the antenna exceeds 6 dBi.

Systems operating in the 5725 – 5850 MHz band that are used exclusively for fixed, point-to-point operations may employ transmitting antennas with directional gain greater than 6 dBi without any corresponding reduction in transmitter peak output power.

Fixed, point-to-point operation excludes the use of point-to-multipoint systems, omnidirectional applications, and multiple co-located intentional radiators transmitting the same information. The operator of the spread spectrum intentional radiator or, if the equipment is professionally installed, the installer is responsible for ensuring that the system is used exclusively for fixed, point-to-point operations. The instruction manual furnished with the intentional radiator shall contain language in the installation instructions informing the operator and the installer of this responsibility.

**Test Procedure:** The transmitter was connected to a calibrated spectrum analyzer. The EUT was measured at the low, mid and high channels of each band. The EUT was utilizes a 3dBi Omni Antenna, so the maximum power allowed is 30dBm.

**Test Results:** The EUT was compliant with the Peak Power Output limits of §15.247(b). No anomalies were noted during testing.

**Test Engineer(s):** Surendra Shrestha

**Test Date(s):** 01/17/2018

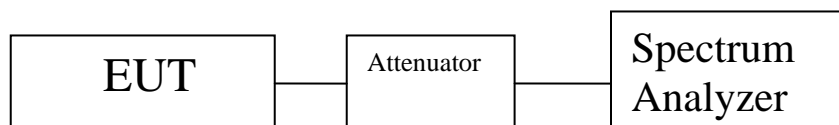


Figure 3. Peak Power Output Test Setup

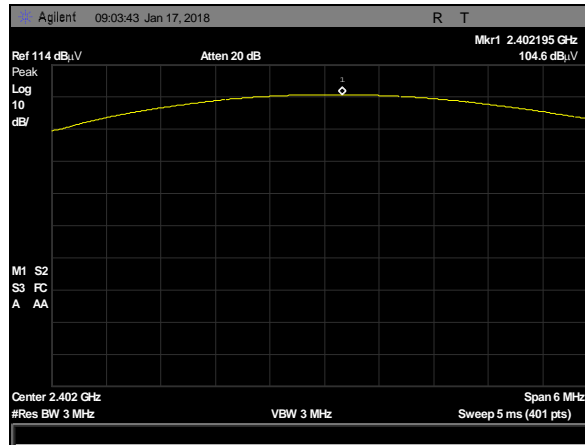
### Peak Power Output Test Results

Data type	Center Frequency (MHz)	Field Strength Measured (dBuV/m)	Measurement distance (m)	Antenna Gain (dBi)	EIRP (dBm)	Conducted Power (dBm)	Limit (dBm)	Margin (dB)	Result
DH1	2402	104.6	1	0	-0.17	-0.17	30	-30.17	Pass
	2441	106.4	1	0	1.63	1.63	30	-28.37	Pass
	2480	111.6	1	0	6.83	6.83	30	-23.17	Pass
DH5	2402	105.3	1	0	0.53	0.53	30	-29.47	Pass
	2441	108	1	0	3.23	3.23	30	-26.77	Pass
	2480	112.2	1	0	7.43	7.43	30	-22.57	Pass
3-DH1	2402	104.3	1	0	-0.47	-0.47	30	-30.47	Pass
	2441	107.3	1	0	2.53	2.53	30	-27.47	Pass
	2480	110.4	1	0	5.63	5.63	30	-24.37	Pass
3-DH5	2402	102.8	1	0	-1.97	-1.97	30	-31.97	Pass
	2441	106.4	1	0	1.63	1.63	30	-28.37	Pass
	2480	110.9	1	0	6.13	6.13	30	-23.87	Pass

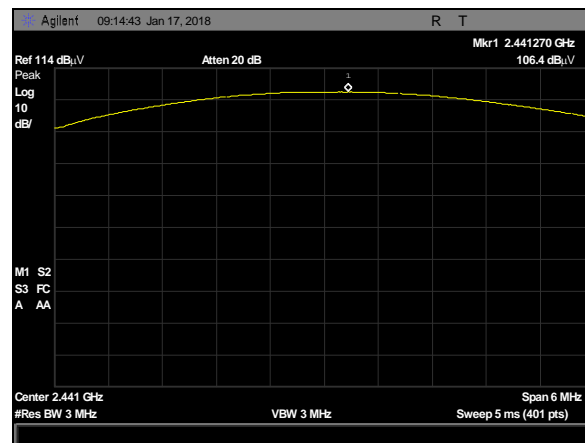
**Table 11. Peak Power Output, Test Results**



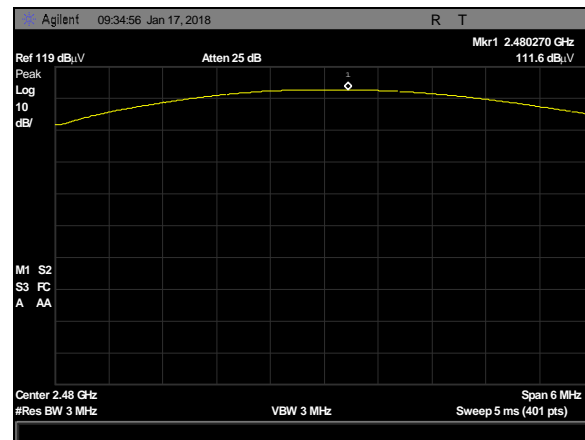
## Peak Power Output Test Results



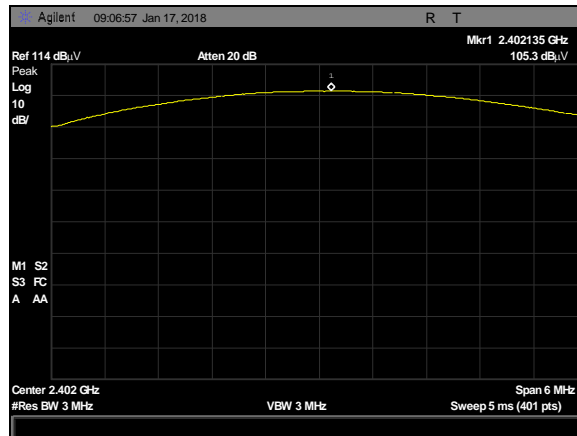
Plot 35. Peak Power Output, DH1, 2402MHz



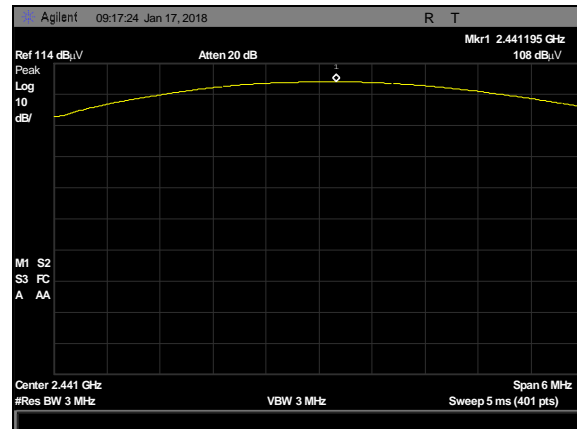
Plot 36. Peak Power Output, DH1, 2441MHz



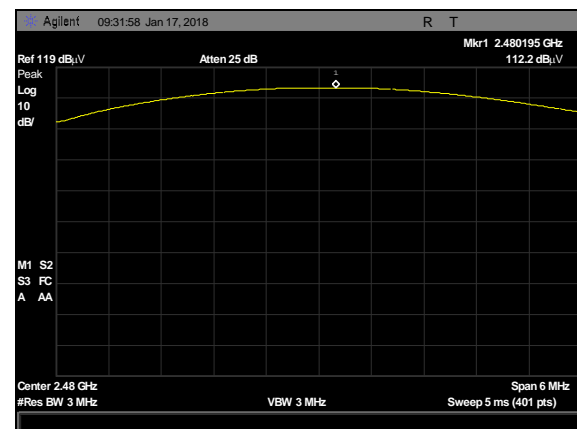
Plot 37. Peak Power Output, DH1, 2480MHz



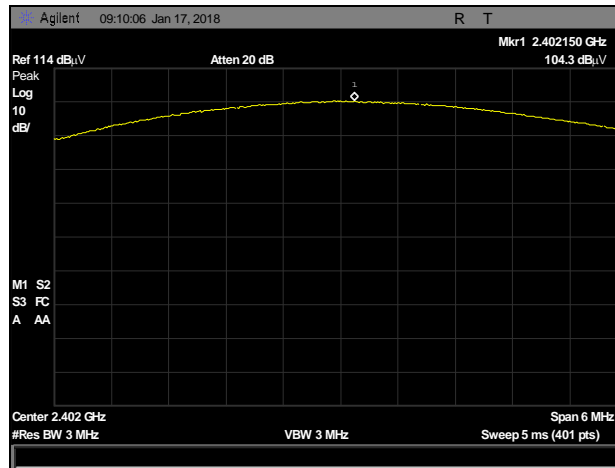
**Plot 38. Peak Power Output, DH5, 2402MHz**



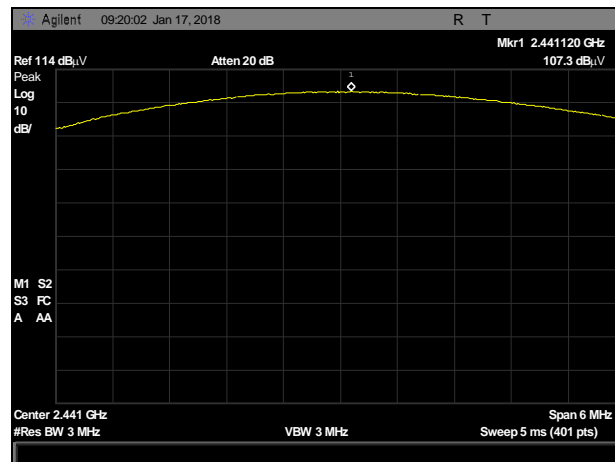
**Plot 39. Peak Power Output, DH5, 2441MHz**



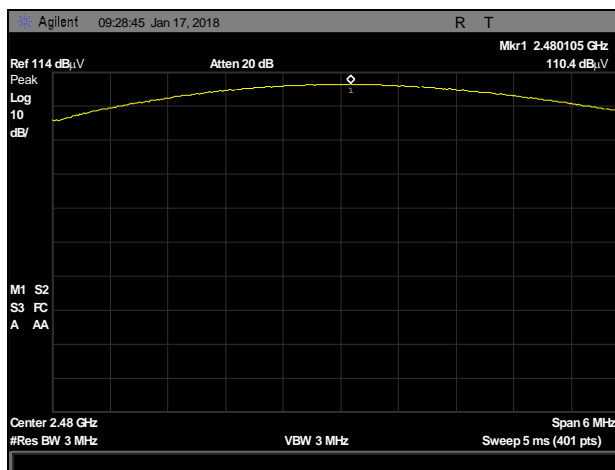
**Plot 40. Peak Power Output, DH5, 2480MHz**



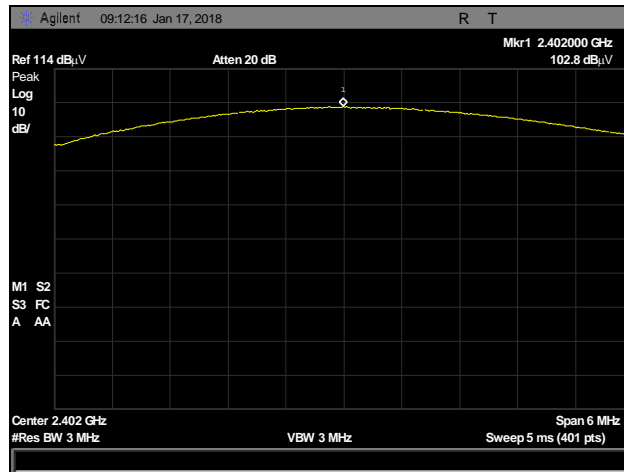
**Plot 41. Peak Power Output, 3-DH1, 2402MHz**



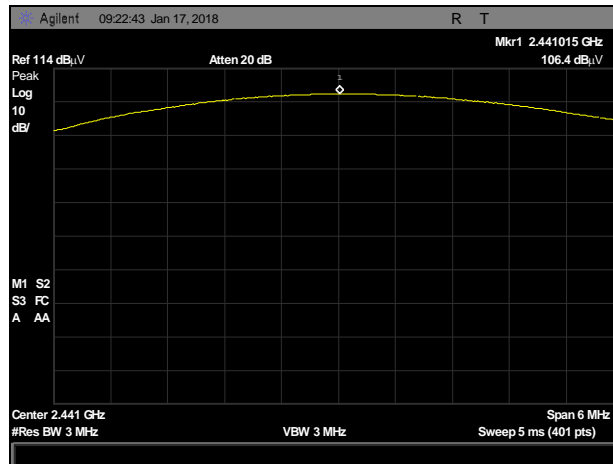
**Plot 42. Peak Power Output, 3-DH1, 2441MHz**



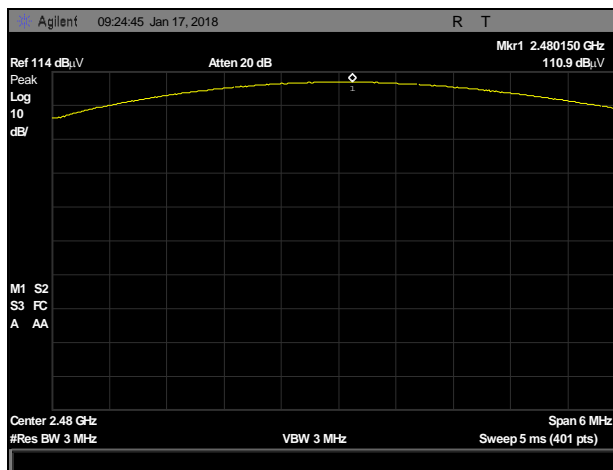
**Plot 43. Peak Power Output, 3-DH1, 2480MHz**



**Plot 44. Peak Power Output, 3-DH5, 2402MHz**



**Plot 45. Peak Power Output, 3-DH5, 2441MHz**



**Plot 46. Peak Power Output, 3-DH5, 2480MHz**

## Electromagnetic Compatibility Criteria for Intentional Radiators

### § 15.247(d) Radiated Spurious Emissions Requirements and Band Edge

**Test Requirements:** §15.247(d); §15.205: Emissions outside the frequency band.

**§15.247(d):** In any 100 kHz bandwidth outside the frequency band in which the spread spectrum or digitally modulated intentional radiator is operating, the radio frequency power that is produced by the intentional radiator shall be at least 20 dB below that in the 100 kHz bandwidth within the band that contains the highest level of the desired power, based on either an RF conducted or a radiated measurement. Attenuation below the general limits specified in § 15.209(a) is not required. In addition, radiated emissions which fall in the restricted bands, as defined in § 15.205(a), must also comply with the radiated emission limits specified in § 15.209(a).

**§15.205(a):** Except as shown in paragraph (d) of this section, only spurious emissions are permitted in any of the frequency bands listed below:

MHz	MHz	MHz	GHz
0.090–0.110-----	16.42–16.423	399.9–410	4.5–5.15
<sup>1</sup> 0.495–0.505-----	16.69475–16.69525	608–614	5.35–5.46
2.1735–2.1905-----	16.80425–16.80475	960–1240	7.25–7.75
4.125–4.128-----	25.5–25.67	1300–1427	8.025–8.5
4.17725–4.17775-----	37.5–38.25	1435–1626.5	9.0–9.2
4.20725–4.20775-----	73–74.6	1645.5–1646.5	9.3–9.5
6.215–6.218-----	74.8–75.2	1660–1710	10.6–12.7
6.26775–6.26825-----	108–121.94	1718.8–1722.2	13.25–13.4
6.31175–6.31225-----	123–138	2200–2300	14.47–14.5
8.291–8.294-----	149.9–150.05	2310–2390	15.35–16.2
8.362–8.366-----	156.52475–156.52525	2483.5–2500	17.7–21.4
8.37625–8.38675-----	156.7–156.9	2655–2900	22.01–23.12
8.41425–8.41475-----	162.0125–167.17	3260–3267	23.6–24.0
12.29–12.293-----	167.72–173.2	3332–3339	31.2–31.8
12.51975–12.52025-----	240–285	3345.8–3358.36	43–36.5
12.57675–12.57725-----	322–335.4	3600–4400	( <sup>2</sup> )

**Table 12. Restricted Bands of Operation**

<sup>1</sup> Until February 1, 1999, this restricted band shall be 0.490 – 0.510 MHz.

<sup>2</sup> Above 38.6

**Test Requirement(s):** § 15.209 (a): Except as provided elsewhere in this subpart, the emissions from an intentional radiator shall not exceed the field strength levels specified in Table 13.

Frequency (MHz)	§ 15.209(a), Radiated Emission Limits (dBµV) @ 3m
30 - 88	40.00
88 - 216	43.50
216 - 960	46.00
Above 960	54.00

**Table 13. Radiated Emissions Limits Calculated from FCC Part 15, § 15.209 (a)**

**Test Procedure:** The transmitter was set to the mid channel at the highest output power and placed on a 0.8 m high wooden table inside in a semi-anechoic chamber. Measurements were performed with the EUT rotated 360 degrees and varying the adjustable antenna mast with 1 m to 4 m height to determine worst case orientation for maximum emissions. Measurement were repeated the measurement at the low and highest channels.

For frequencies from 30 MHz to 1 GHz, measurements were made using a quasi-peak detector with a 120 kHz bandwidth.

For intentional radiators with a digital device portion which operates below 10 GHz, the spectrum was investigated as per §15.33(a)(1) and §15.33(a)(4); i.e., the lowest RF signal generated or used in the device up to the 10th harmonic of the highest fundamental frequency or to 40 GHz, whichever is lower.

In accordance with §15.35(b) the limit on the radio frequency emissions as measured using instrumentation with a peak detector function shall be 20 dB above the maximum permitted average limit for the frequency being investigated unless a different peak emission limit is otherwise specified in the rules.

EUT Field Strength Final Amplitude = Raw Amplitude – Preamp gain + Antenna Factor + Cable Loss – Distance Correction Factor

**Test Results:** The EUT was compliant with the Radiated Spurious Emission limits of §15.247(d). Measured emissions were below applicable limits. Emissions from 18 GHz to 26 GHz were investigated, and only noise floor was measured.

Emissions from 30 MHz to 1 GHz were investigated for all modes and all channels. Only the worst case is reported.

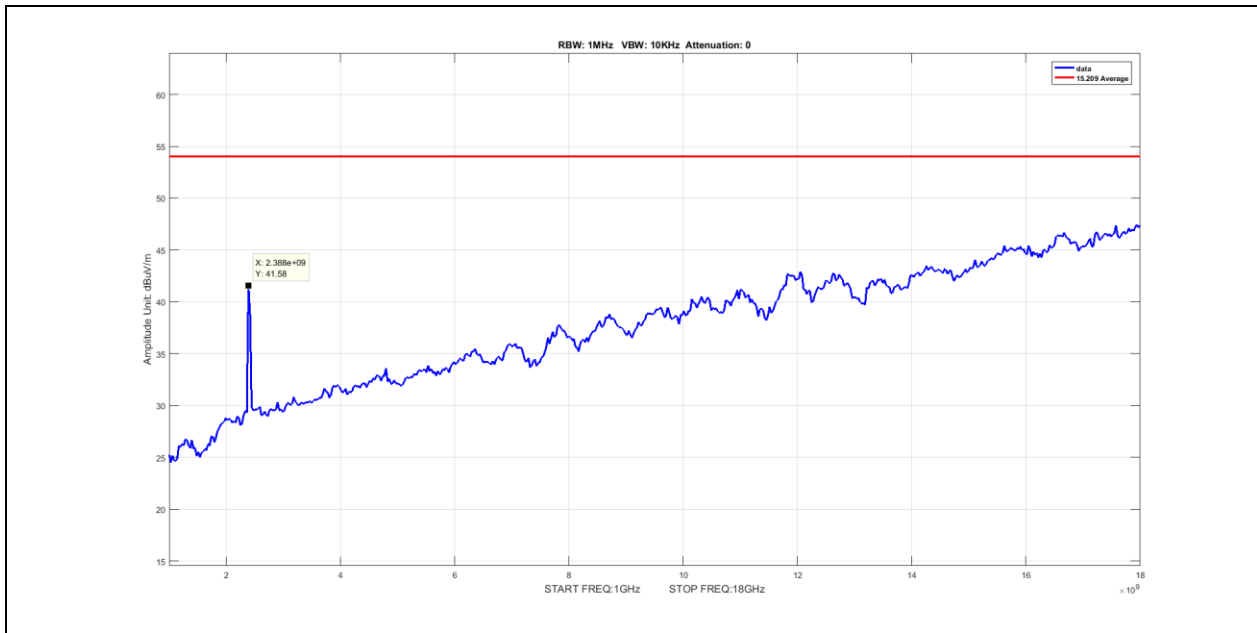
**Test Engineer(s):** Surendra Shrestha

**Test Date(s):** 01/18/2018

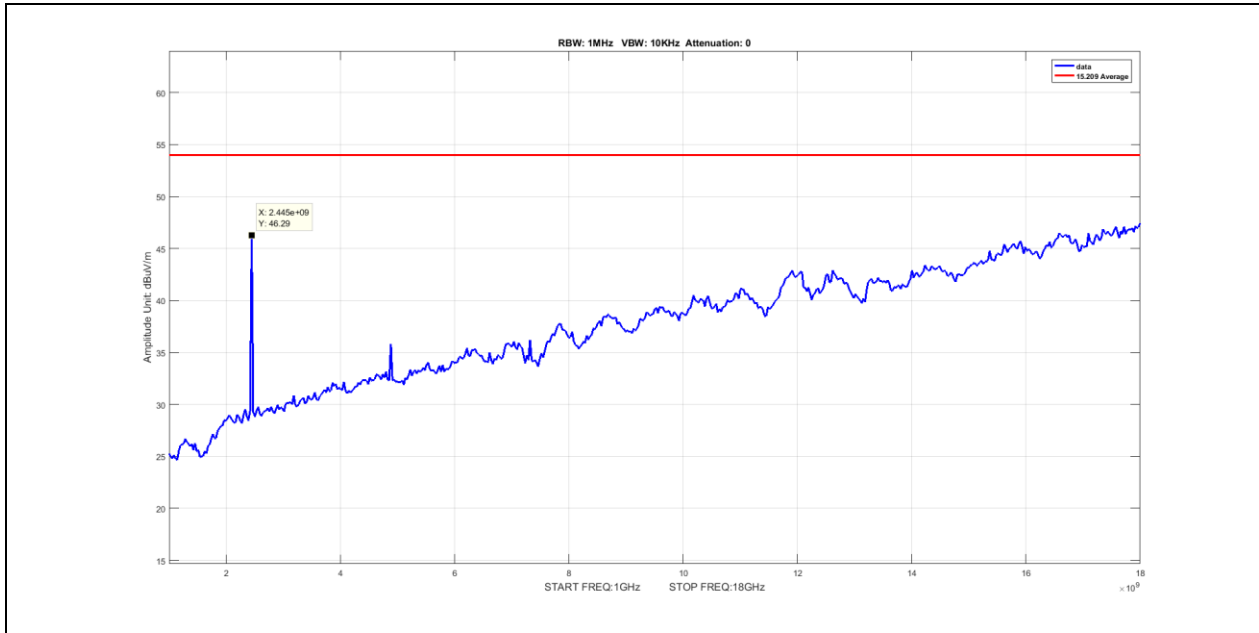
## Radiated Spurious Emissions Test Results

Frequency (MHz)	EUT Azimuth (Degrees)	Antenna Polarity (H/V)	Antenna HEIGHT (m)	Uncorrected EMI Meter Reading (dBuV)	Antenna Correction Factor (dB/m) (+)	Cable Loss (dB) (+)	Distance Correction Factor (dB) (-)	Corrected Amplitude (dBuV/m)	Limit (dBuV/m)	Margin (dB)
73.850087	56	H	1	6.85	8.70	1.44	0	16.99	40	-23.01
73.850087	100	V	1	19.5	8.70	1.44	0	29.64	40	-10.36
289.72219	272	H	1	24.2	14.10	2.44	0	40.74	46	-5.26
289.72219	117	V	1.6034	14.32	14.10	2.44	0	30.86	46	-15.14
799.99562	28	H	1.0647	12.63	22.10	4.19	0	38.92	46	-7.08
799.99562	225	V	1.1395	13.7	22.10	4.19	0	39.99	46	-6.01

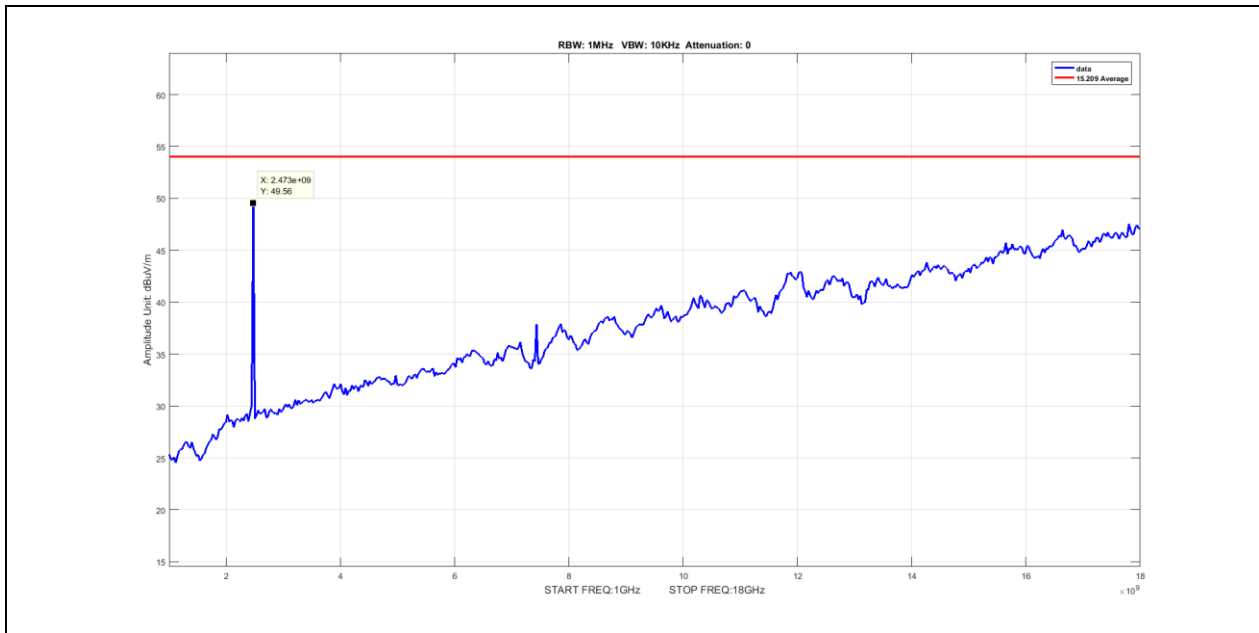
Table 14. Radiated Spurious Emissions, Test Results



Plot 47. Radiated Spurious Emissions, Average, Nonhopping, 1G – 18G, DH1, 2402MHz

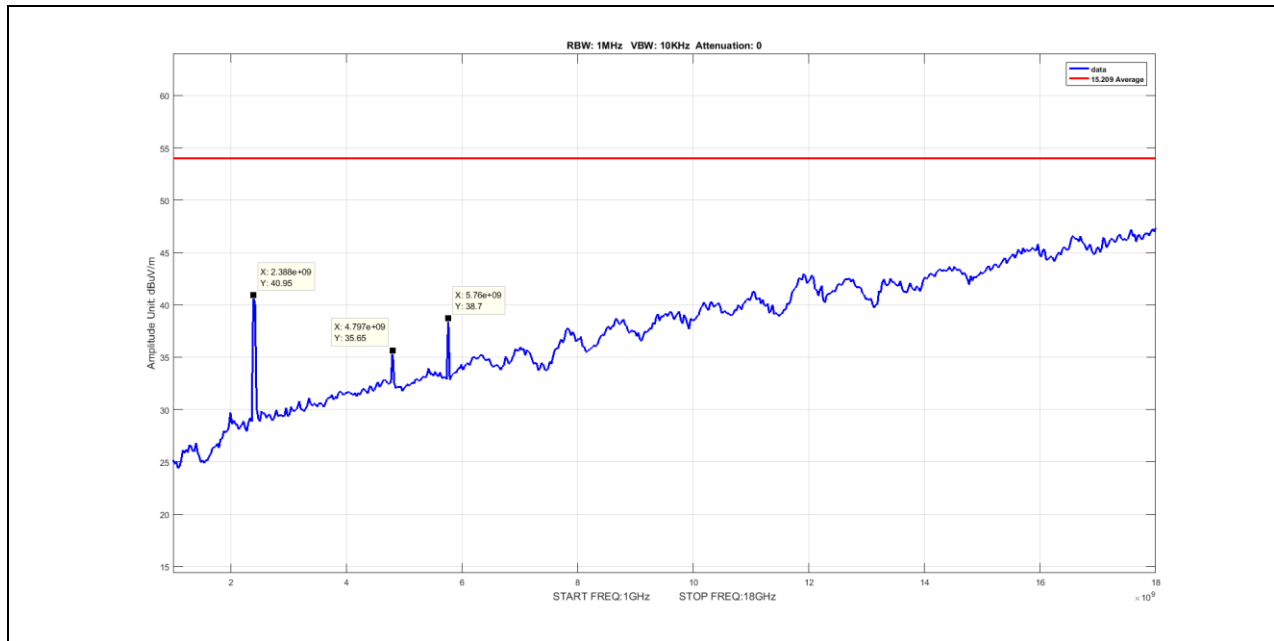


**Plot 48. Radiated Spurious Emissions, Average, Nonhopping, 1G – 18G, DH1, 2441MHz**

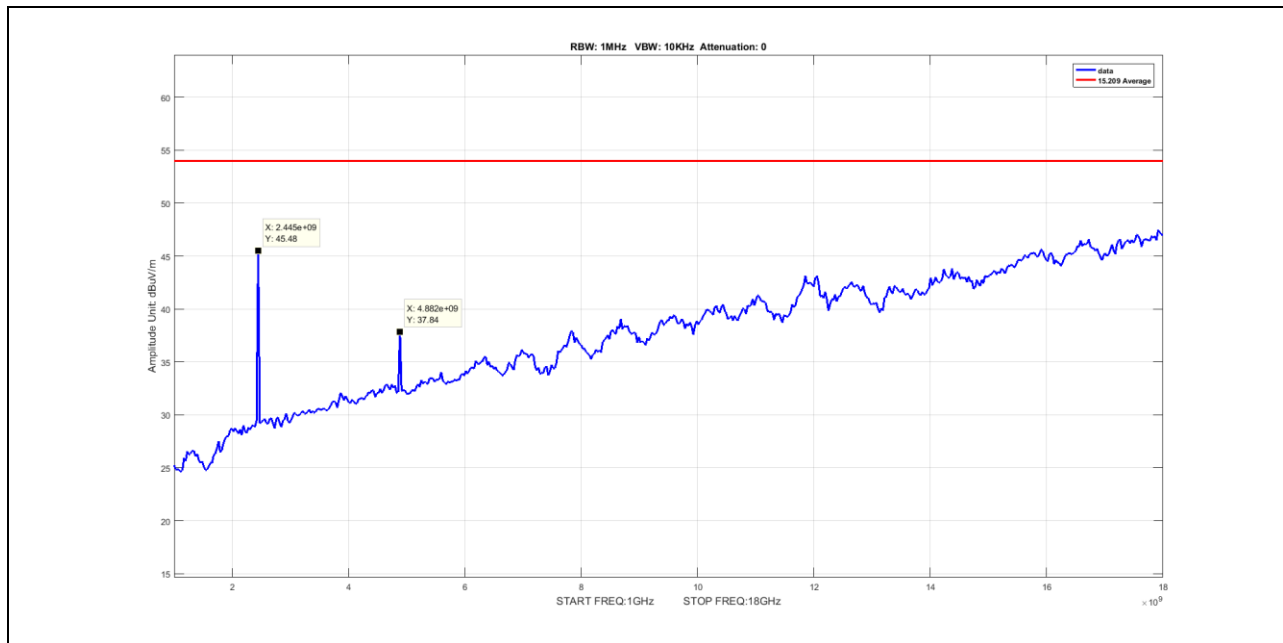


**Plot 49. Radiated Spurious Emissions, Average, Nonhopping, 1G – 18G, DH1, 2480MHz**

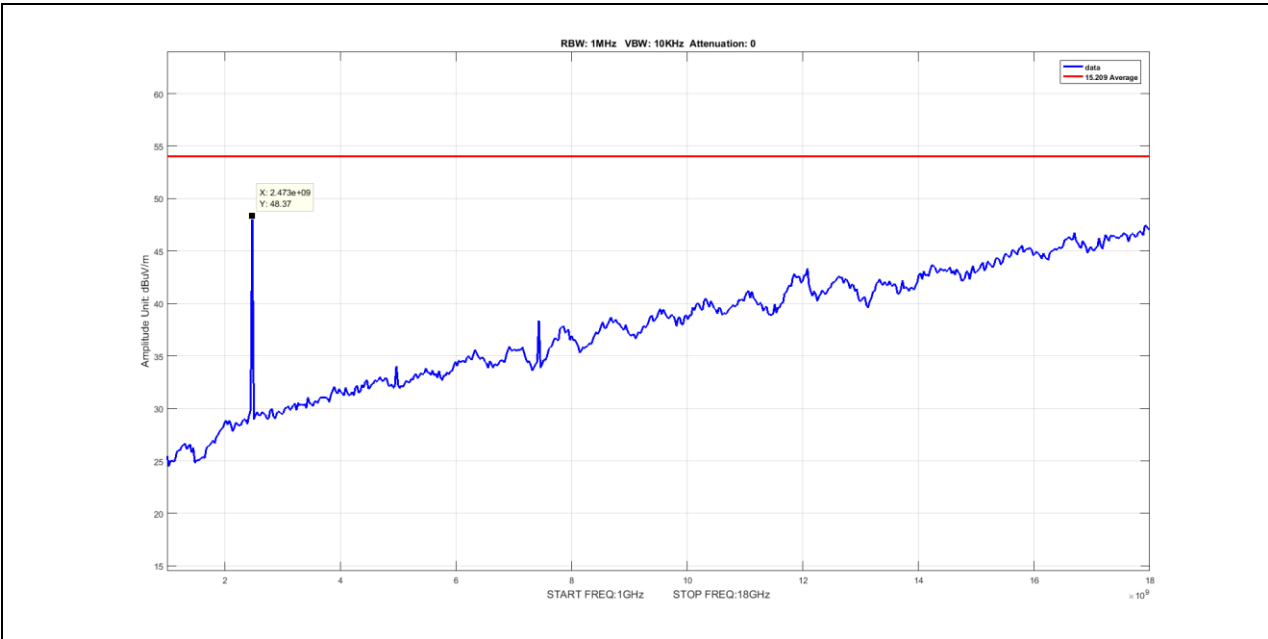




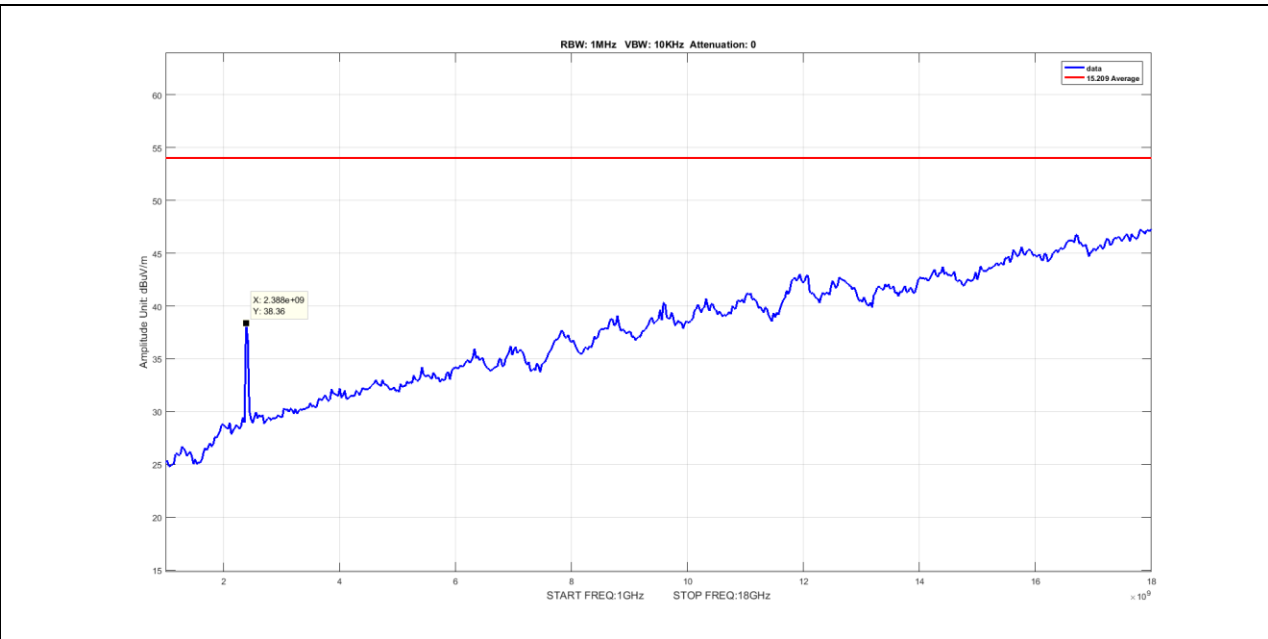
**Plot 50. Radiated Spurious Emissions, Average, Nonhopping, 1G – 18G, DH5, 2402MHz**



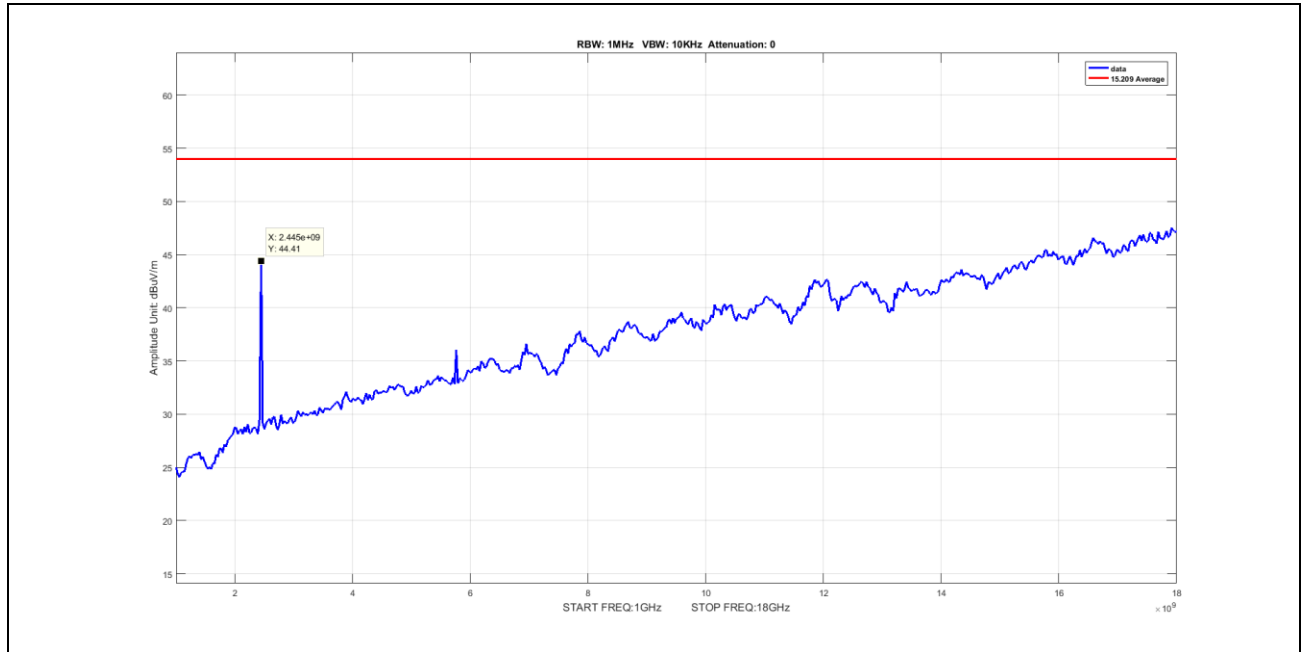
**Plot 51. Radiated Spurious Emissions, Average, Nonhopping, 1G – 18G, DH5, 2441MHz**



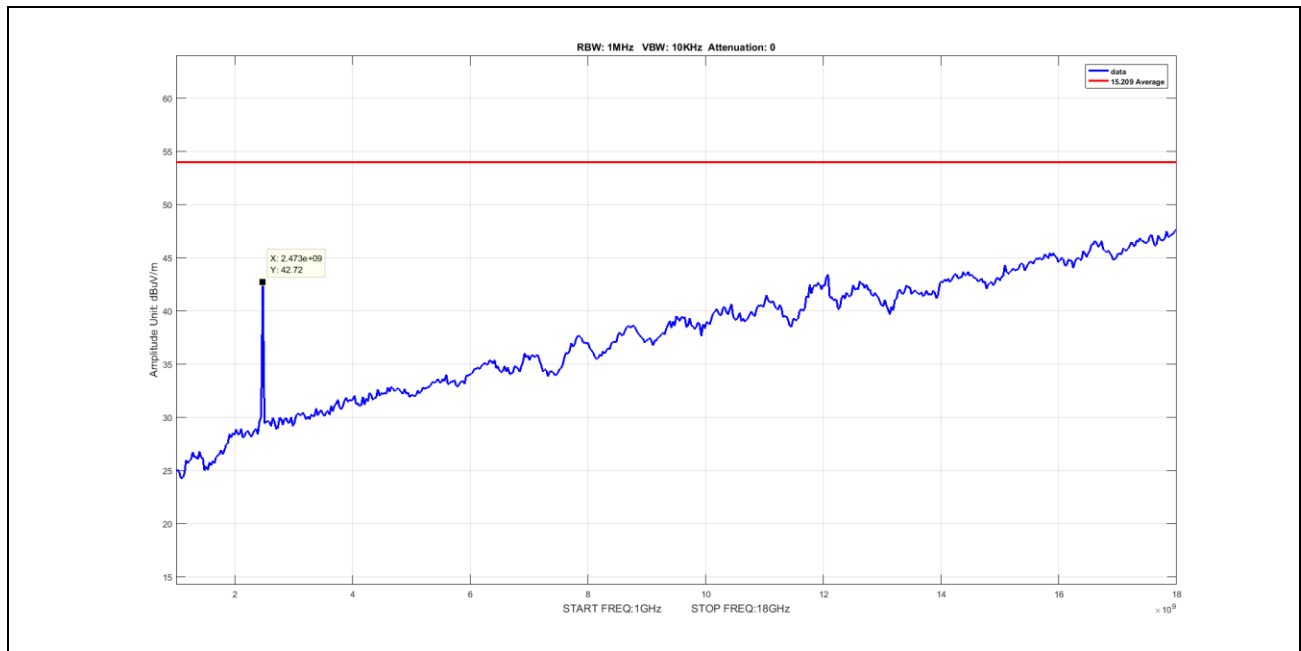
**Plot 52. Radiated Spurious Emissions, Average, Nonhopping, 1G – 18G, DH5, 2480MHz**



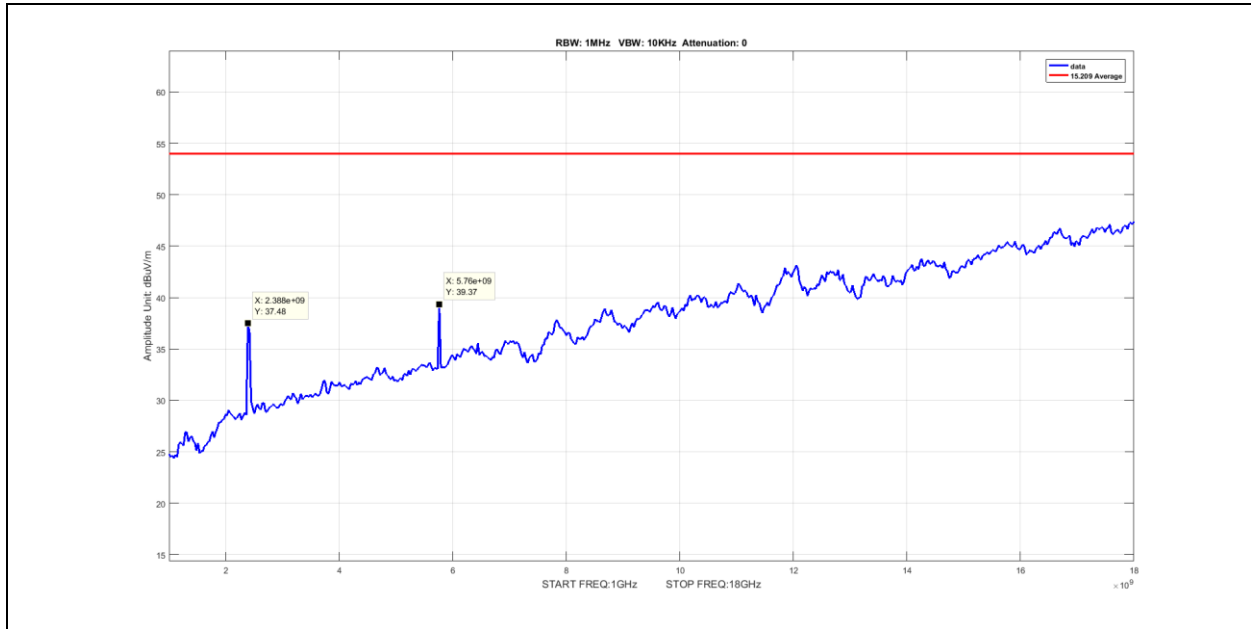
**Plot 53. Radiated Spurious Emissions, Average, Nonhopping, 1G – 18G, 3-DH1, 2402MHz**



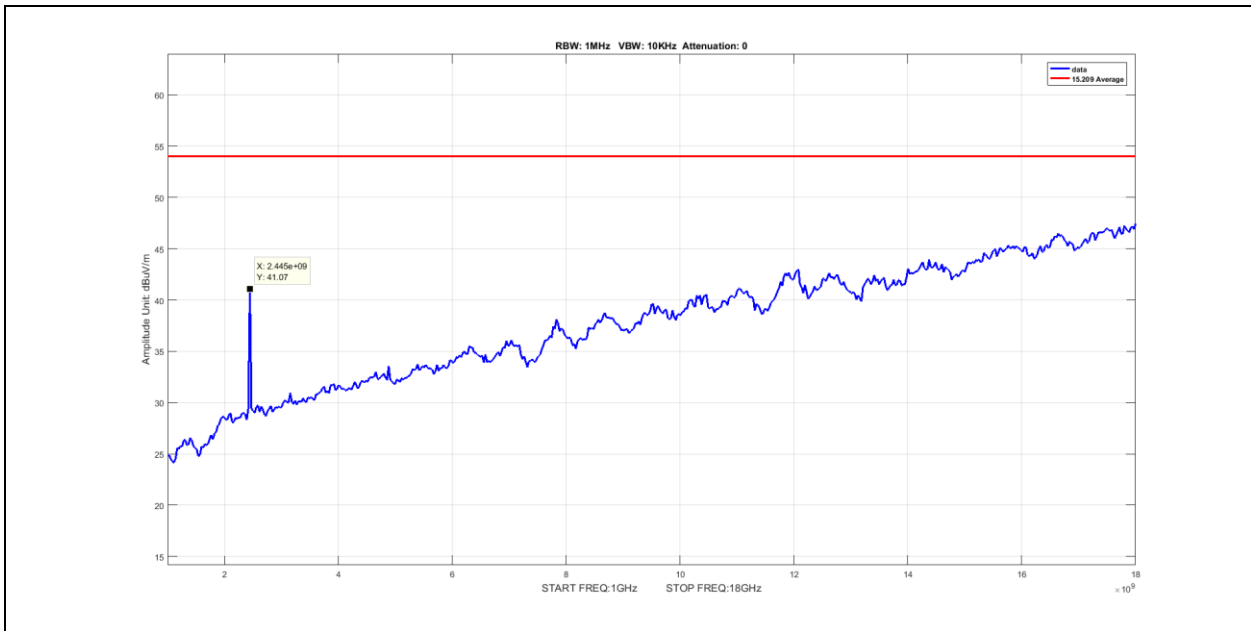
**Plot 54. Radiated Spurious Emissions, Average, Nonhopping, 1G – 18G, 3-DH1, 2441MHz**



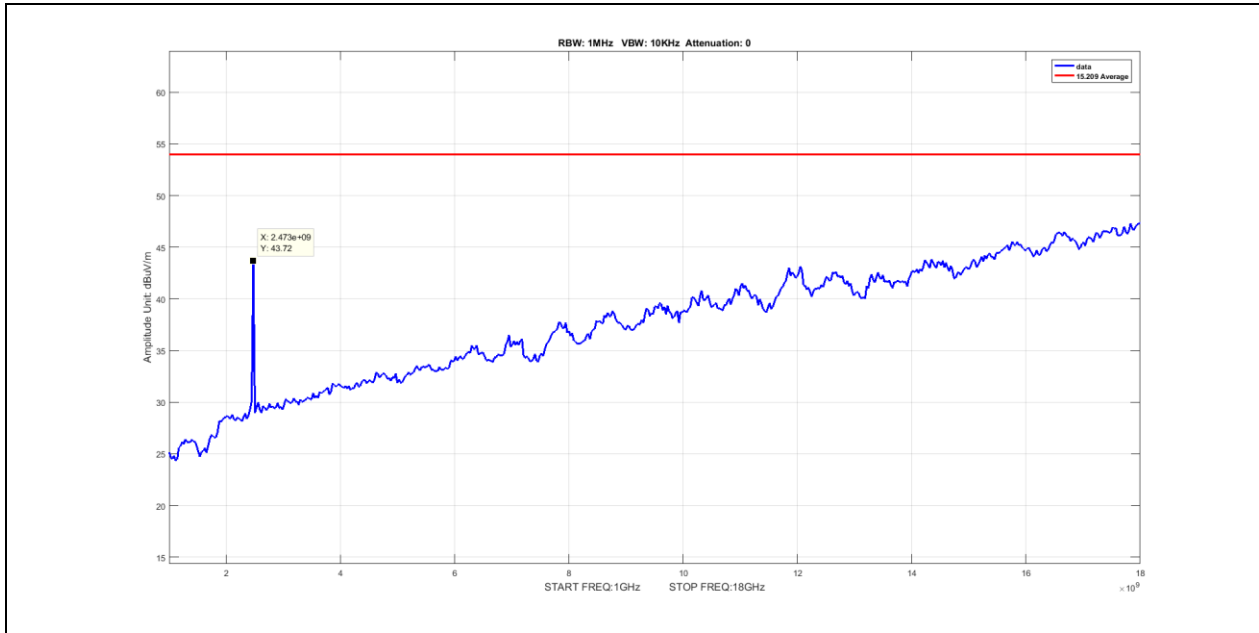
**Plot 55. Radiated Spurious Emissions, Average, Nonhopping, 1G – 18G, 3-DH1, 2480MHz**



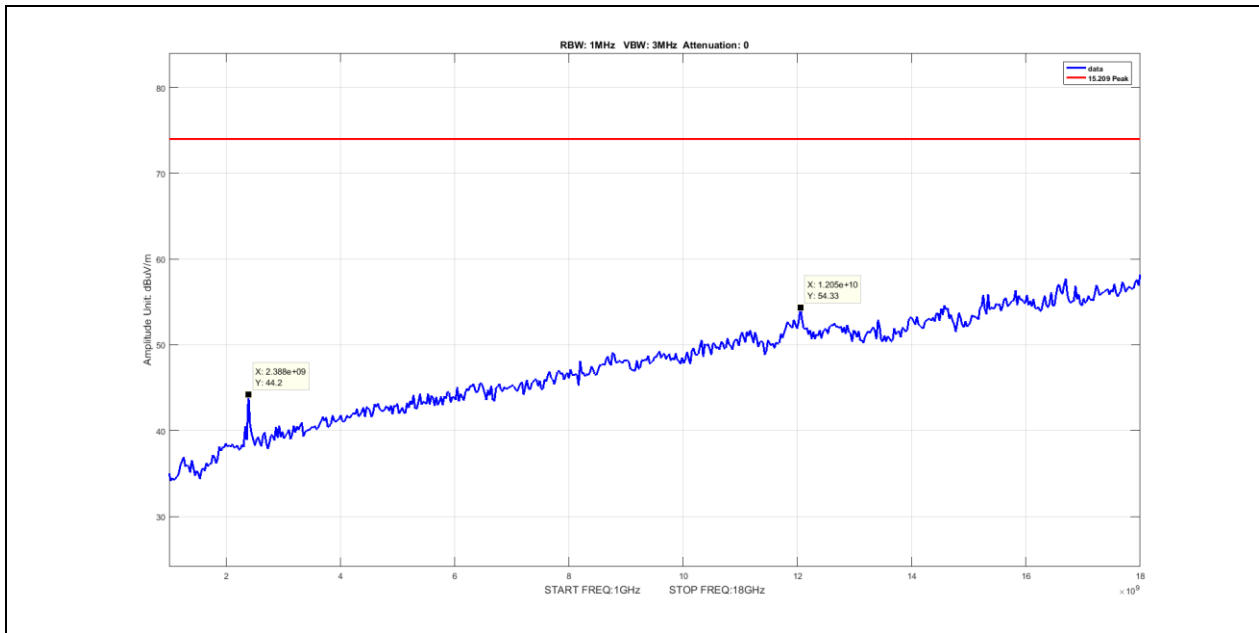
**Plot 56. Radiated Spurious Emissions, Average, Nonhopping, 1G – 18G, 3-DH5, 2402MHz**



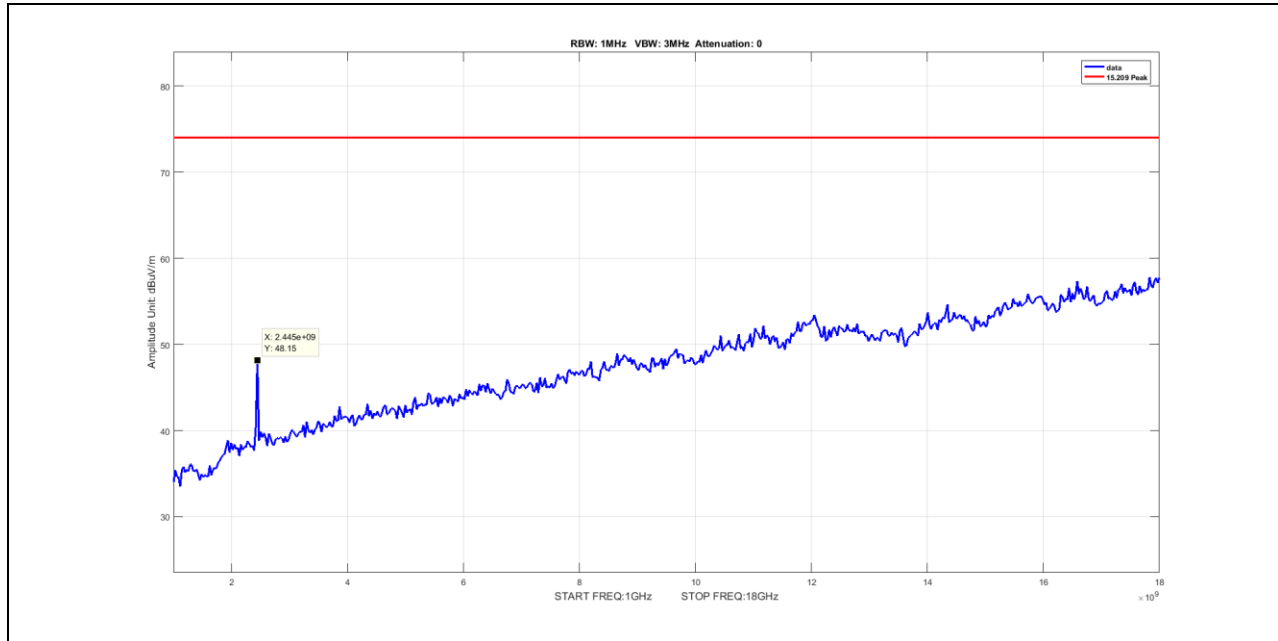
**Plot 57. Radiated Spurious Emissions, Average, Nonhopping, 1G – 18G, 3-DH5, 2441MHz**



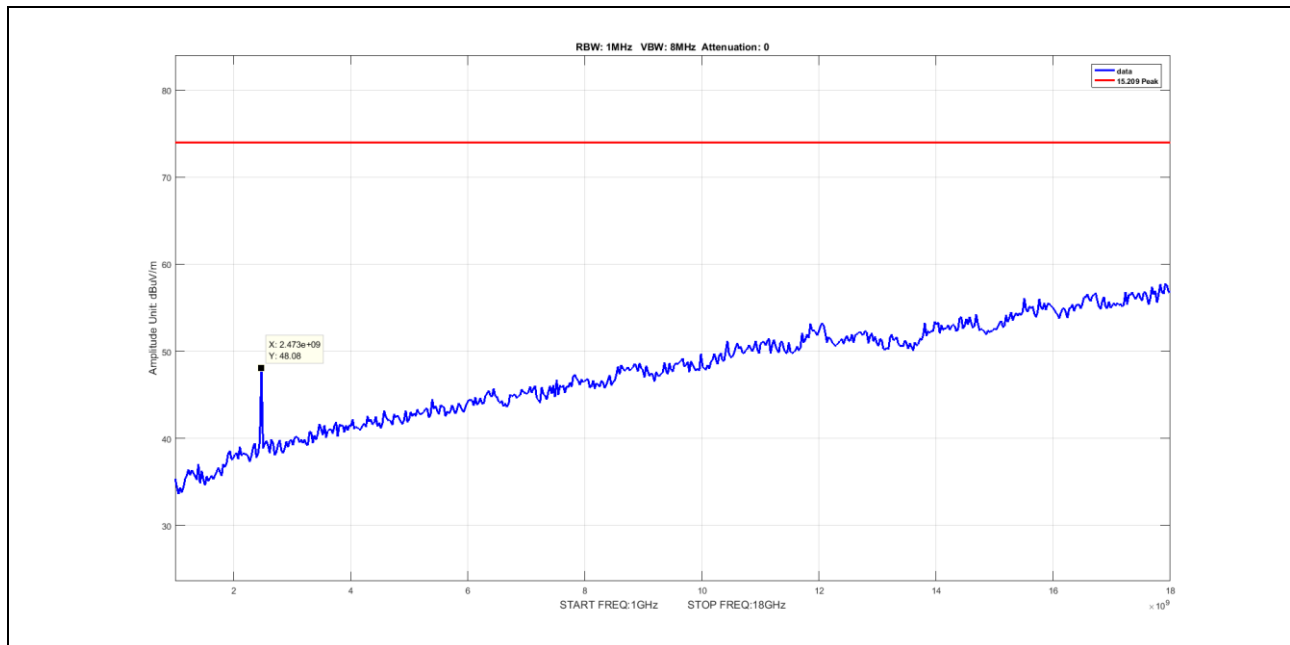
**Plot 58. Radiated Spurious Emissions, Average, Nonhopping, 1G – 18G, 3-DH5, 2480MHz**



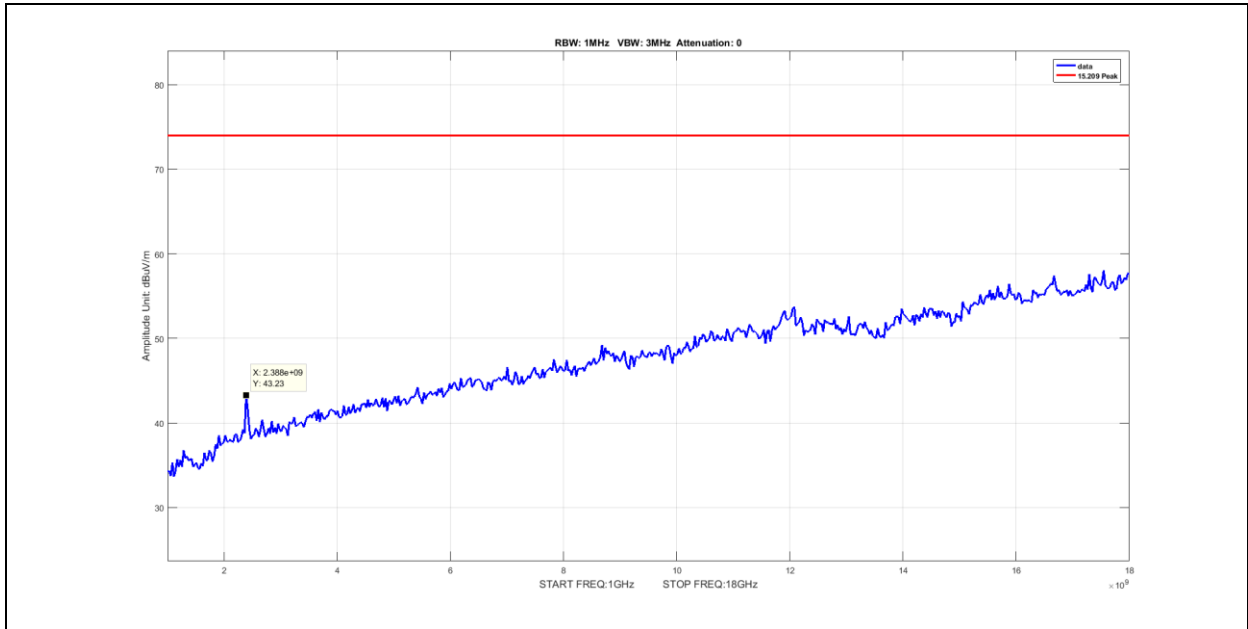
**Plot 59. Radiated Spurious Emissions, Peak, Nonhopping, 1G – 18G, DH1, 2402MHz**



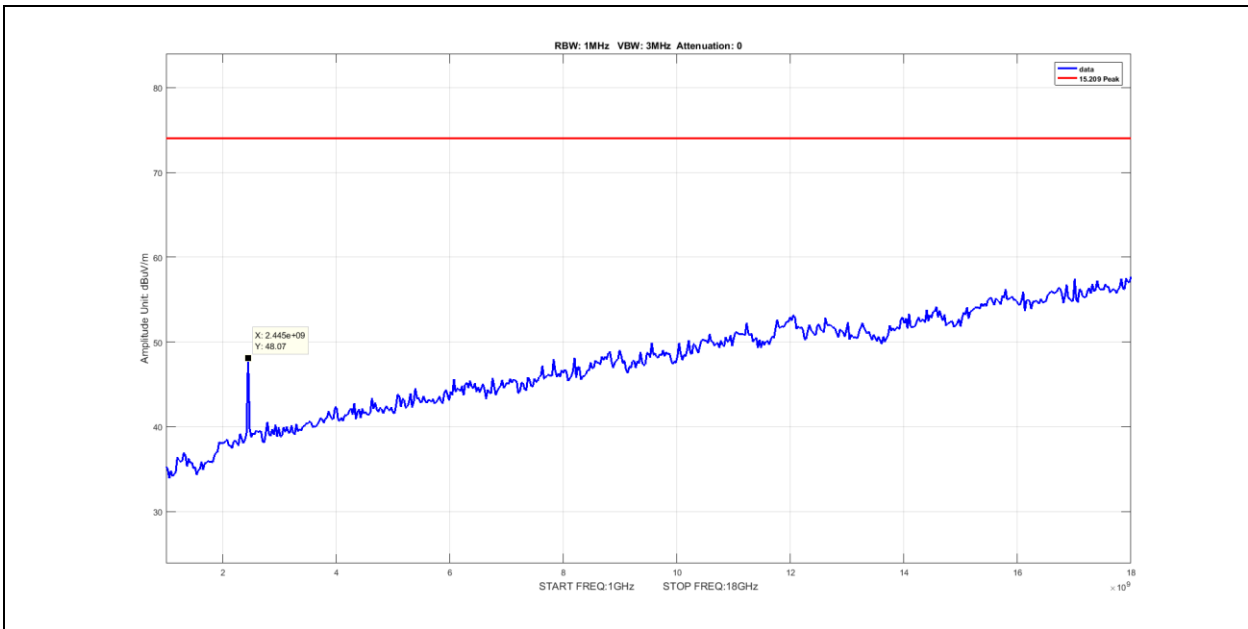
**Plot 60. Radiated Spurious Emissions, Peak, Nonhopping, 1G – 18G, DH1, 2441MHz**



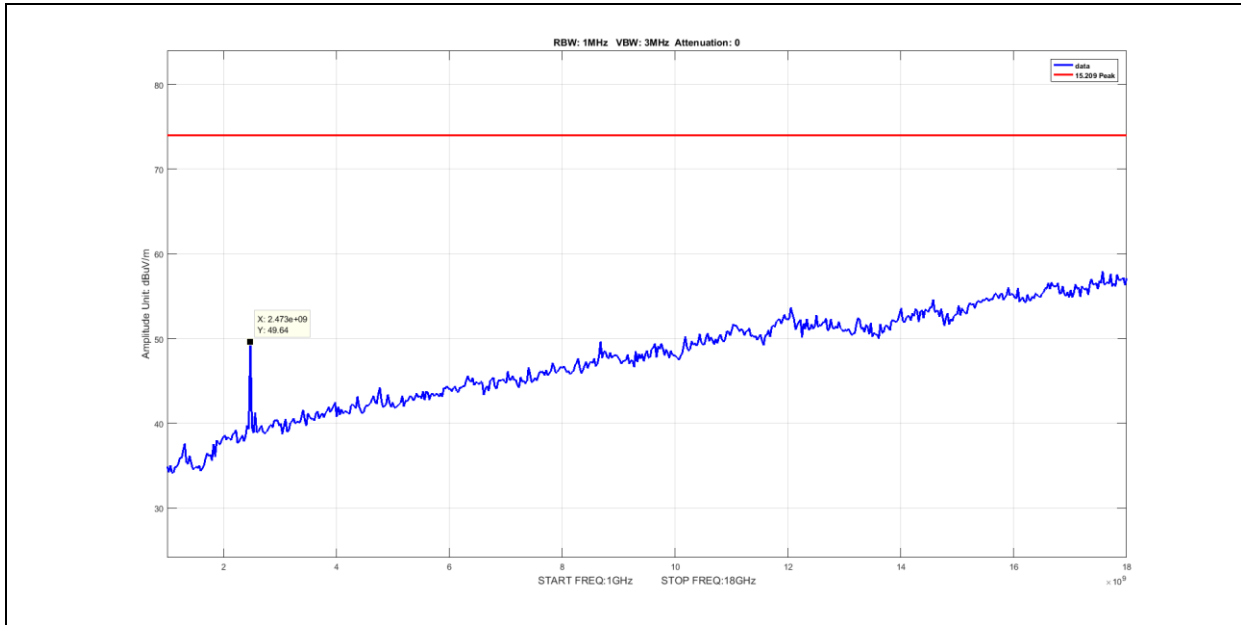
**Plot 61. Radiated Spurious Emissions, Peak, Nonhopping, 1G – 18G, DH1, 2480MHz**



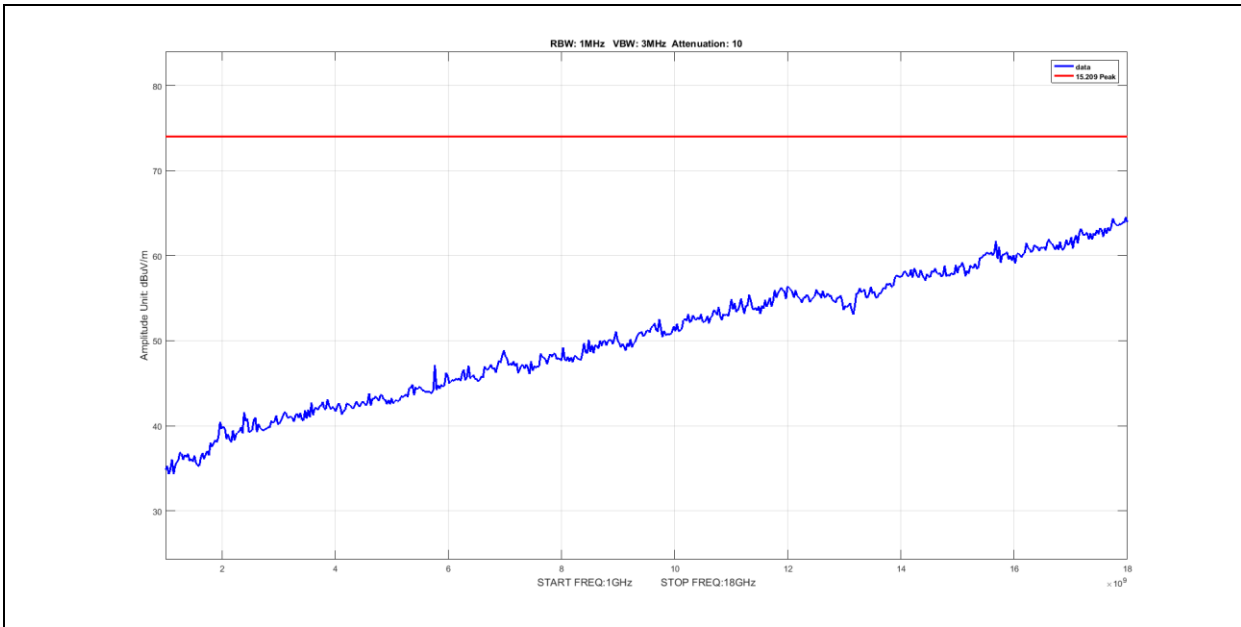
**Plot 62. Radiated Spurious Emissions, Peak, Nonhopping, 1G – 18G, DH5, 2402MHz**



**Plot 63. Radiated Spurious Emissions, Peak, Nonhopping, 1G – 18G, DH5, 2441MHz**

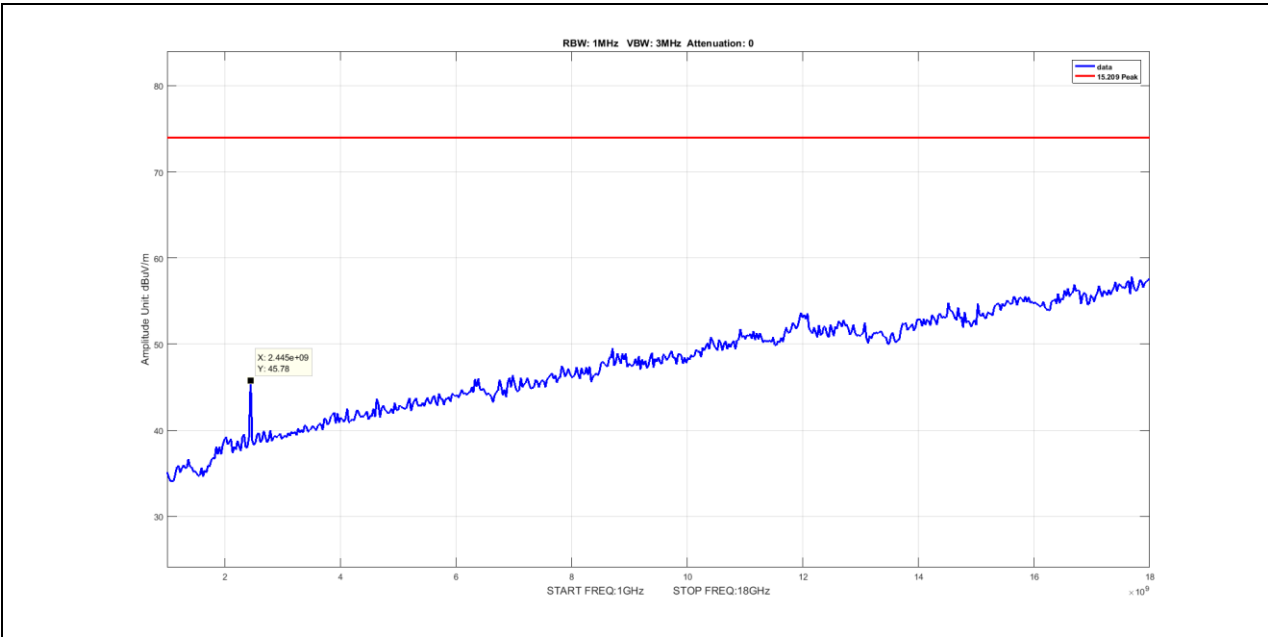


**Plot 64. Radiated Spurious Emissions, Peak, Nonhopping, 1G – 18G, DH5, 2480MHz**

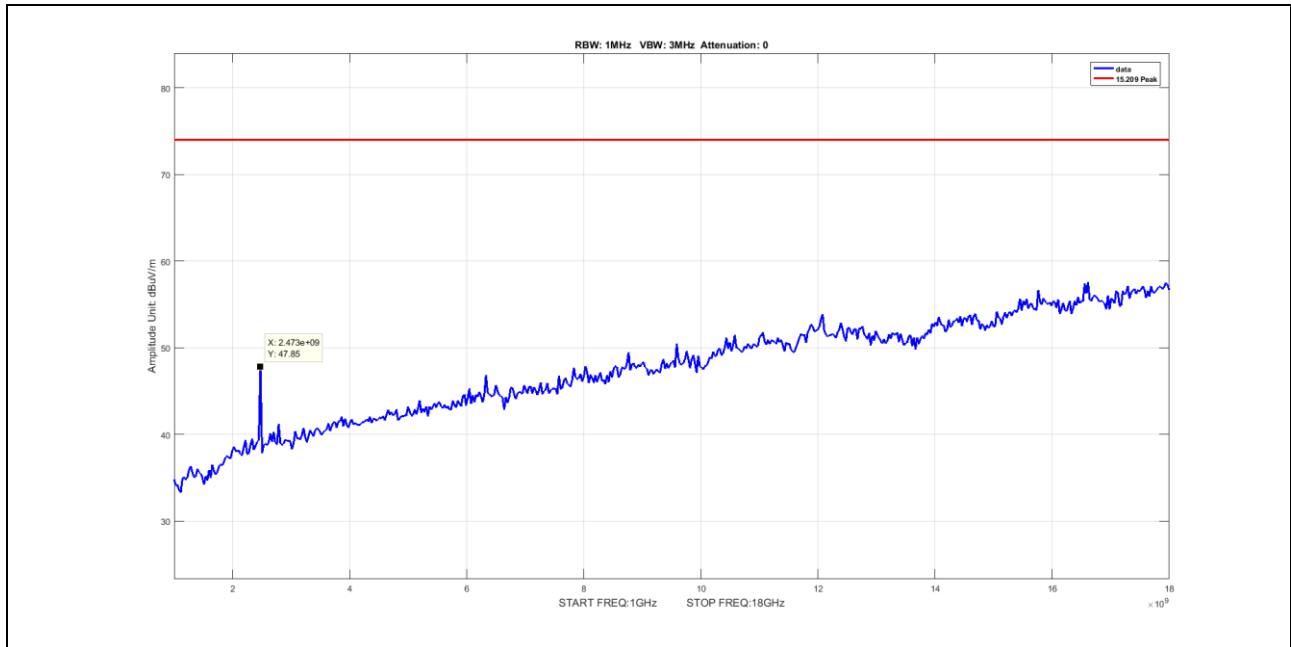


**Plot 65. Radiated Spurious Emissions, Peak, Nonhopping, 1G – 18G, 3-DH1, 2402MHz**

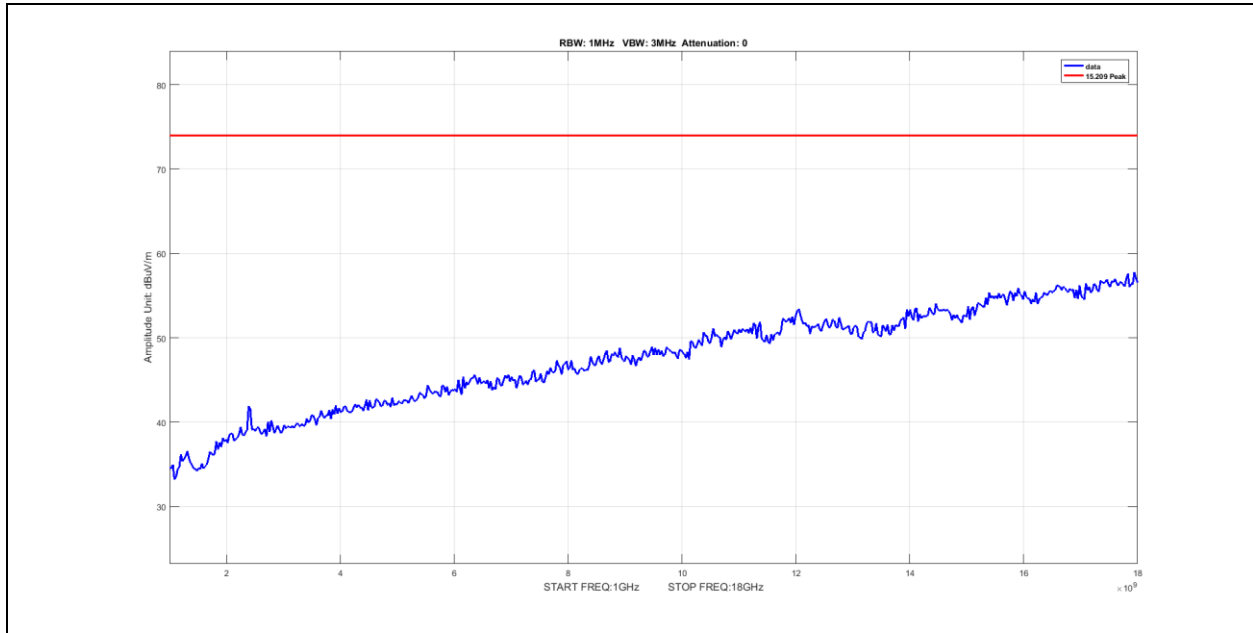




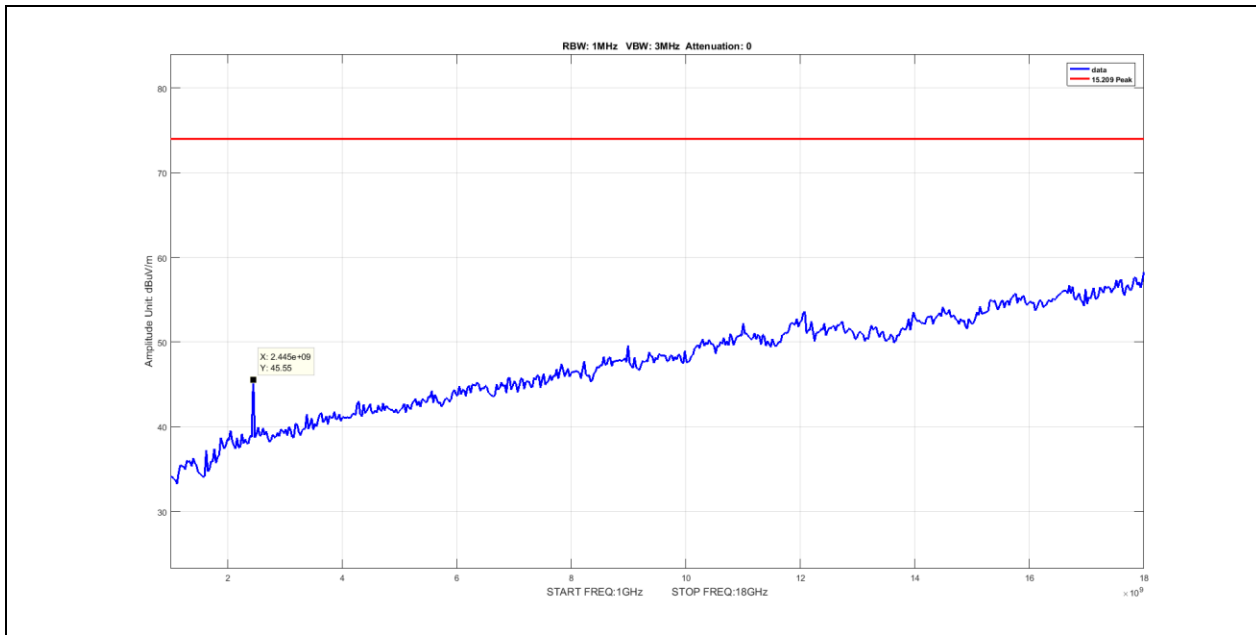
**Plot 66. Radiated Spurious Emissions, Peak, Nonhopping, 1G – 18G, 3-DH1, 2441MHz**



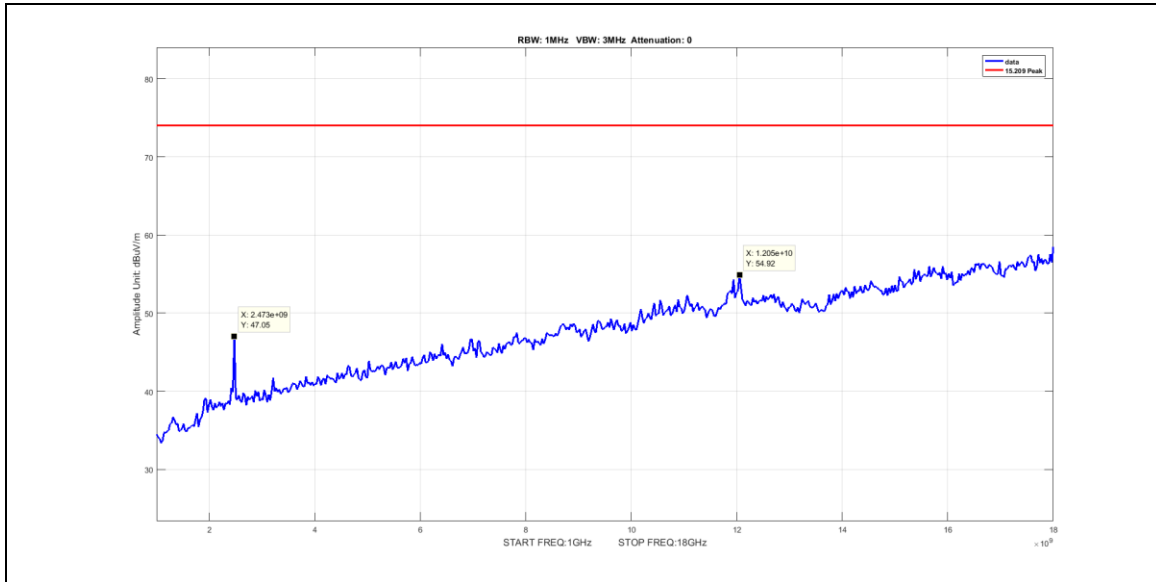
**Plot 67. Radiated Spurious Emissions, Peak, Nonhopping, 1G – 18G, 3-DH1, 2480MHz**



**Plot 68. Radiated Spurious Emissions, Peak, Nonhopping, 1G – 18G, 3-DH5, 2402MHz**



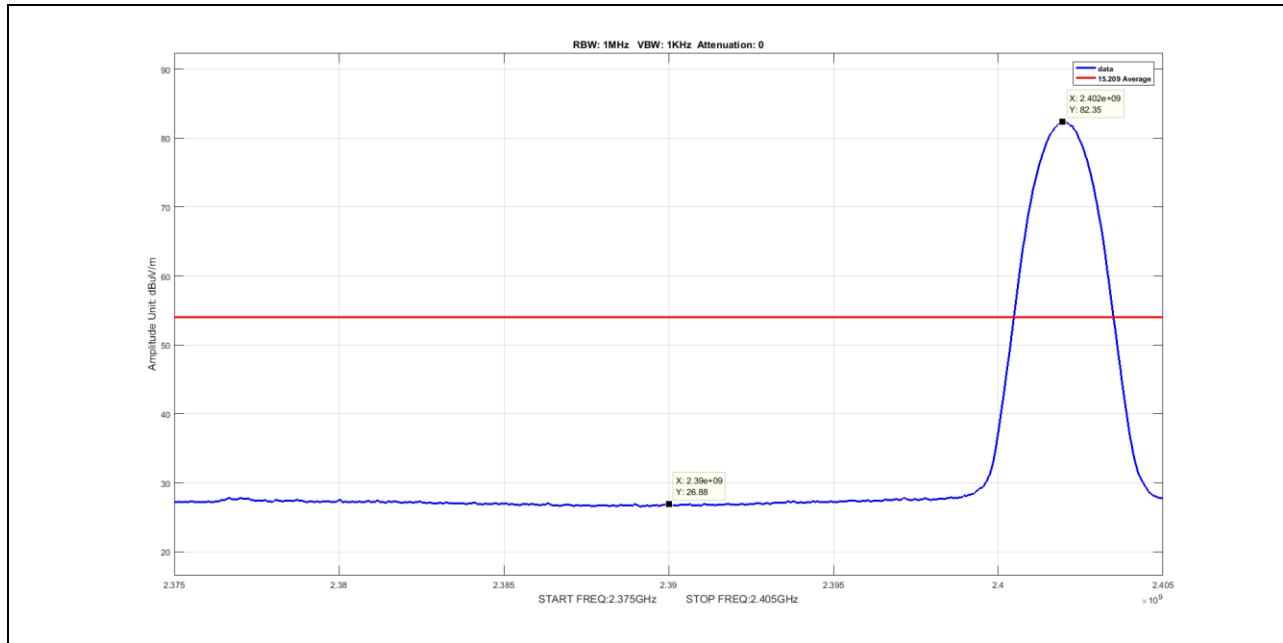
**Plot 69. Radiated Spurious Emissions, Peak, Nonhopping, 1G – 18G, 3-DH5, 2441MHz**



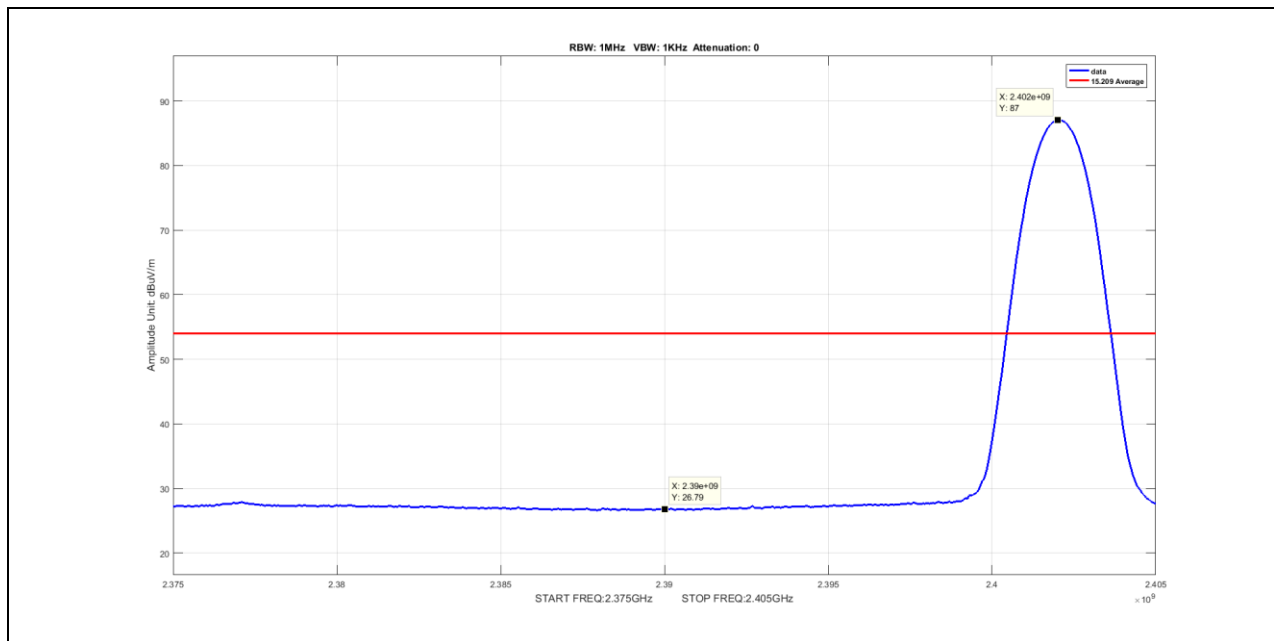
**Plot 70. Radiated Spurious Emissions, Peak, Nonhopping, 1G – 18G, 3-DH5, 2480MHz**

## Radiated Band Edge Measurements

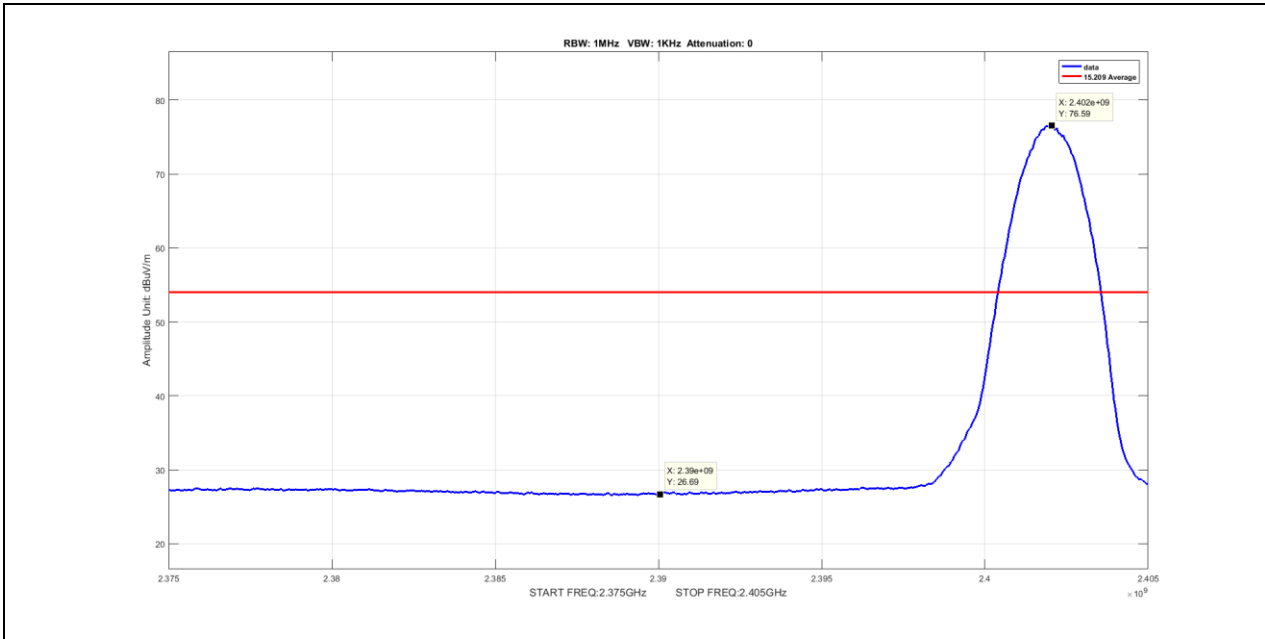
**Test Procedures:** The transmitter was turned. Measurements were performed of the low and high Channels. The EUT was rotated orthogonally through all three axes. Plots shown are corrected for both antenna correction factor and distance.



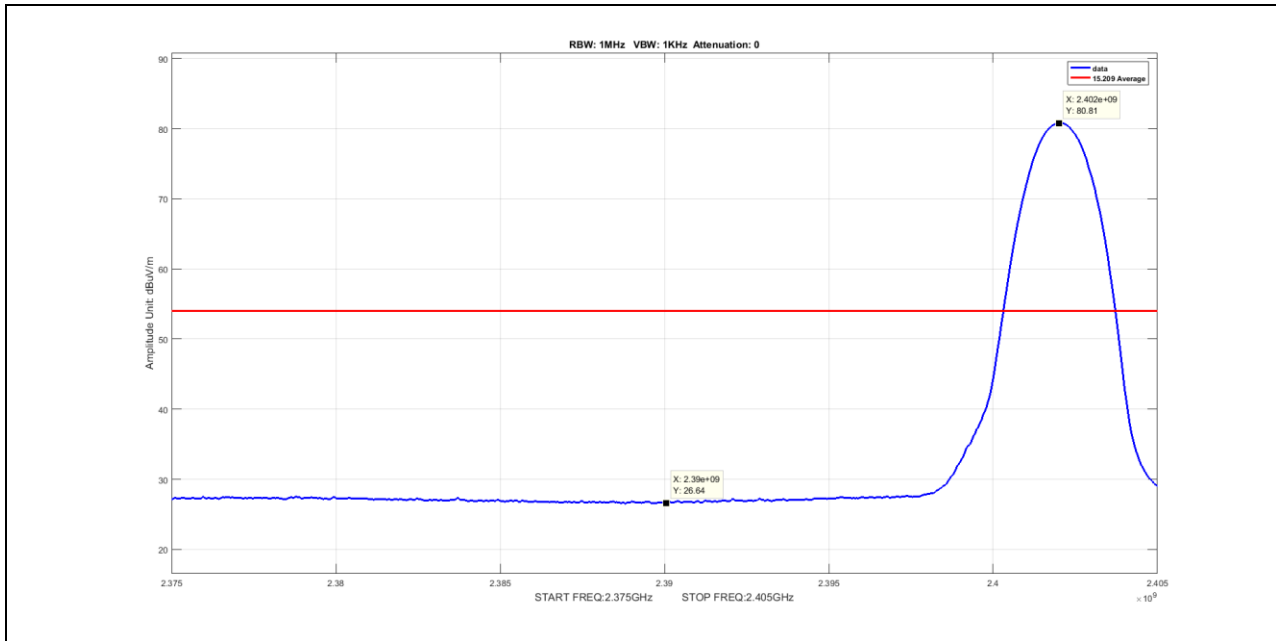
**Plot 71. Radiated Restricted Band Edge, Average, 2390MHz, DH1**



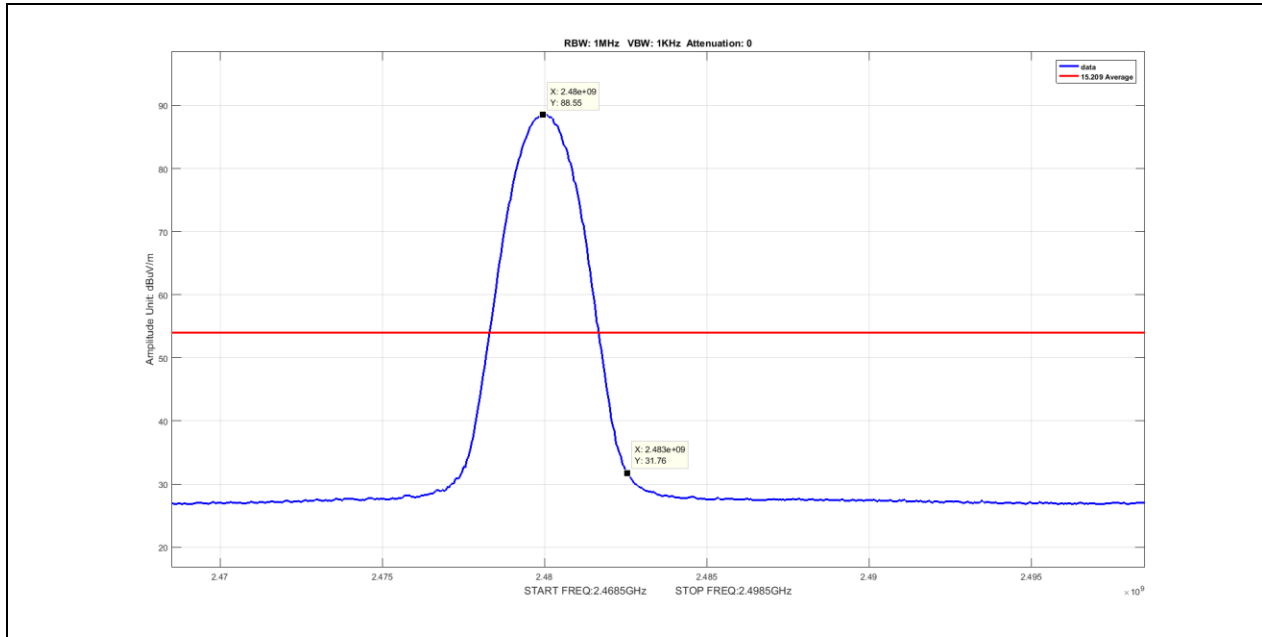
**Plot 72. Radiated Restricted Band Edge, Average, 2390MHz, DH5**



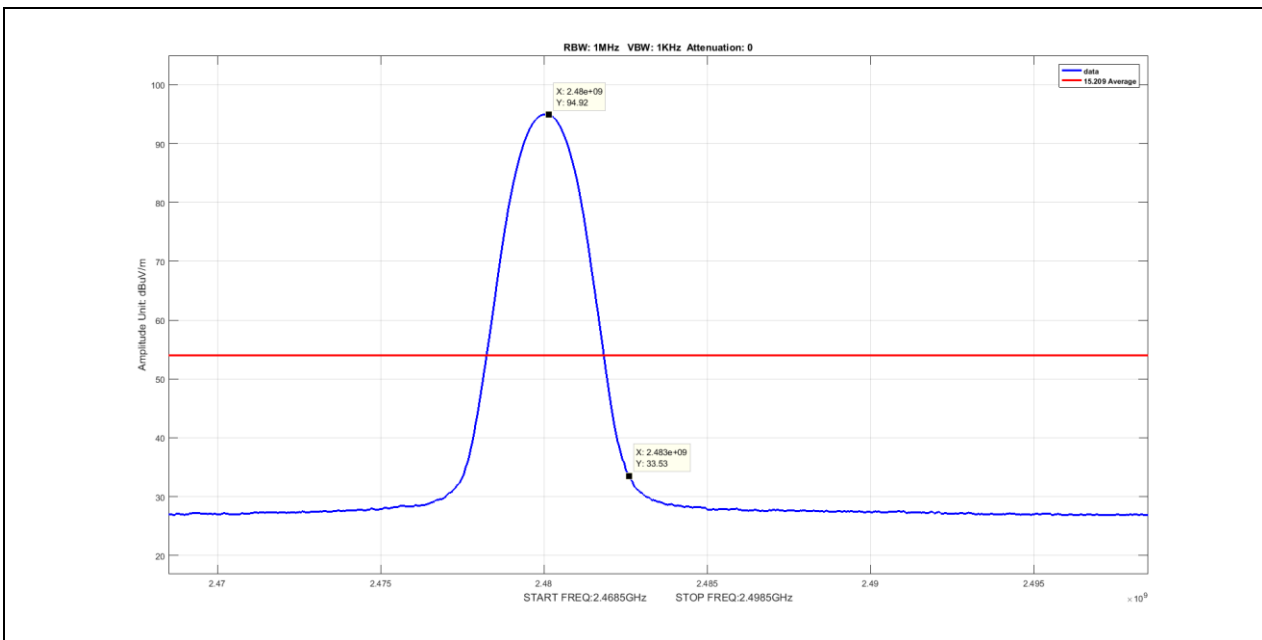
**Plot 73. Radiated Restricted Band Edge, Average, 2390MHz, 3-DH1**



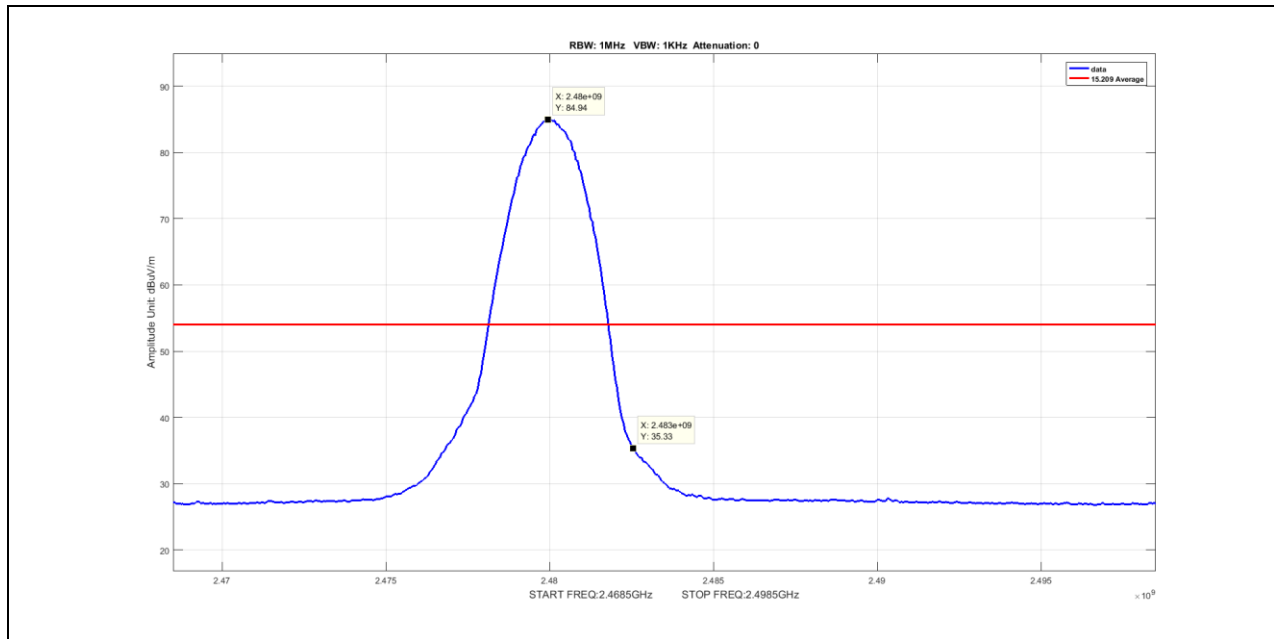
**Plot 74. Radiated Restricted Band Edge, Average, 2390MHz, 3-DH5**



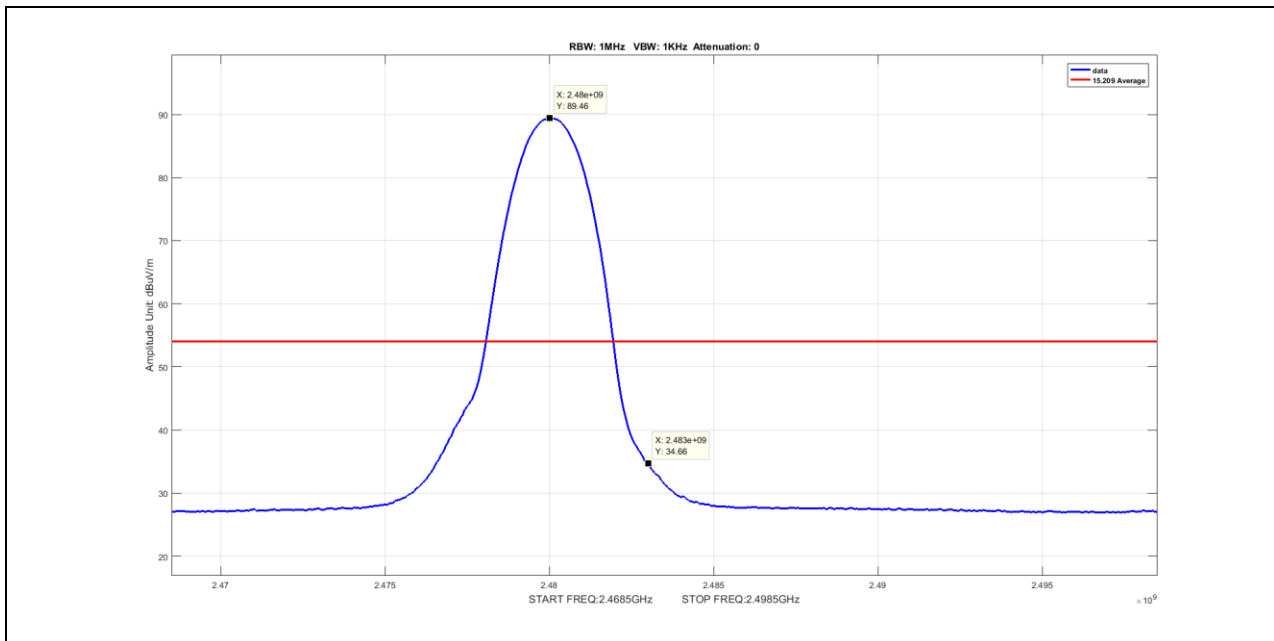
**Plot 75. Radiated Restricted Band Edge, Average, 2483.5MHz, DH1**



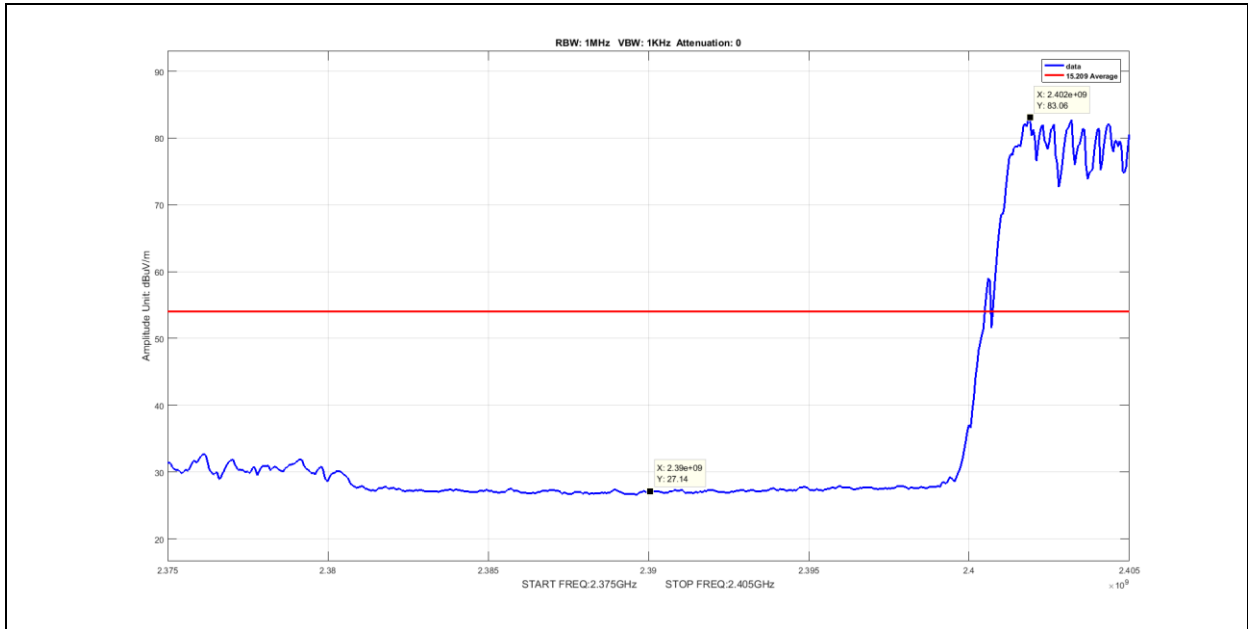
**Plot 76. Radiated Restricted Band Edge, Average, 2483.5MHz, DH5**



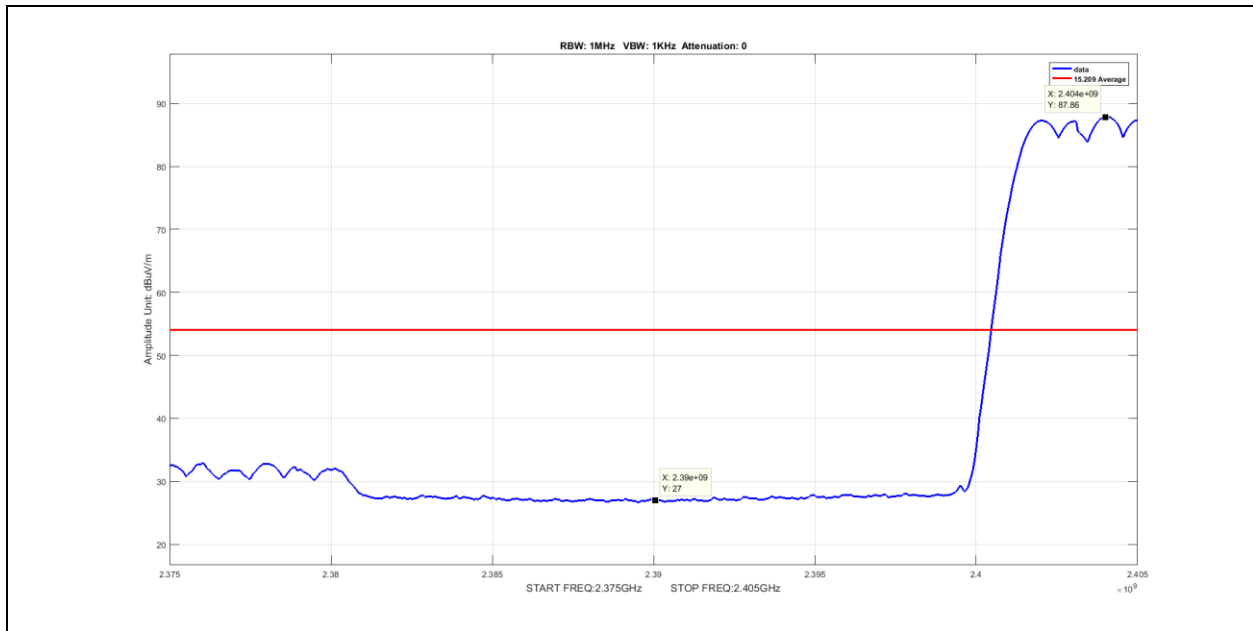
**Plot 77. Radiated Restricted Band Edge, Average, 2483.5MHz, 3-DH1**



**Plot 78. Radiated Restricted Band Edge, Average, 2483.5MHz, 3-DH5**

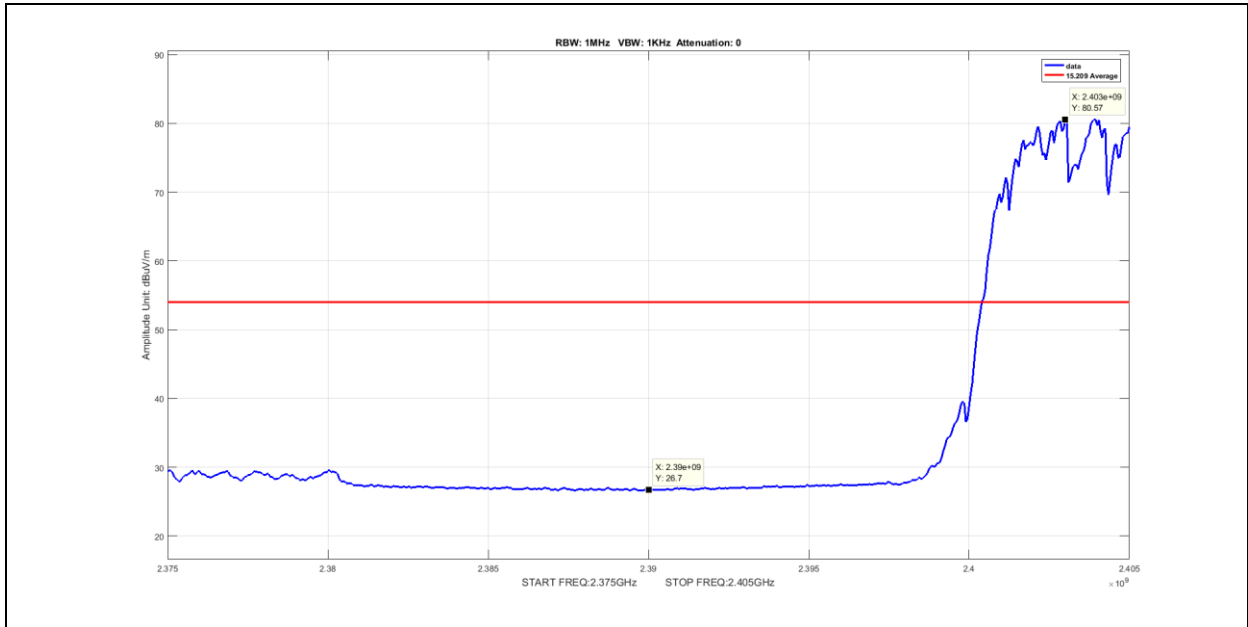


**Plot 79. Radiated Restricted Band Edge, Average, Hopping, 2390MHz, DH1**

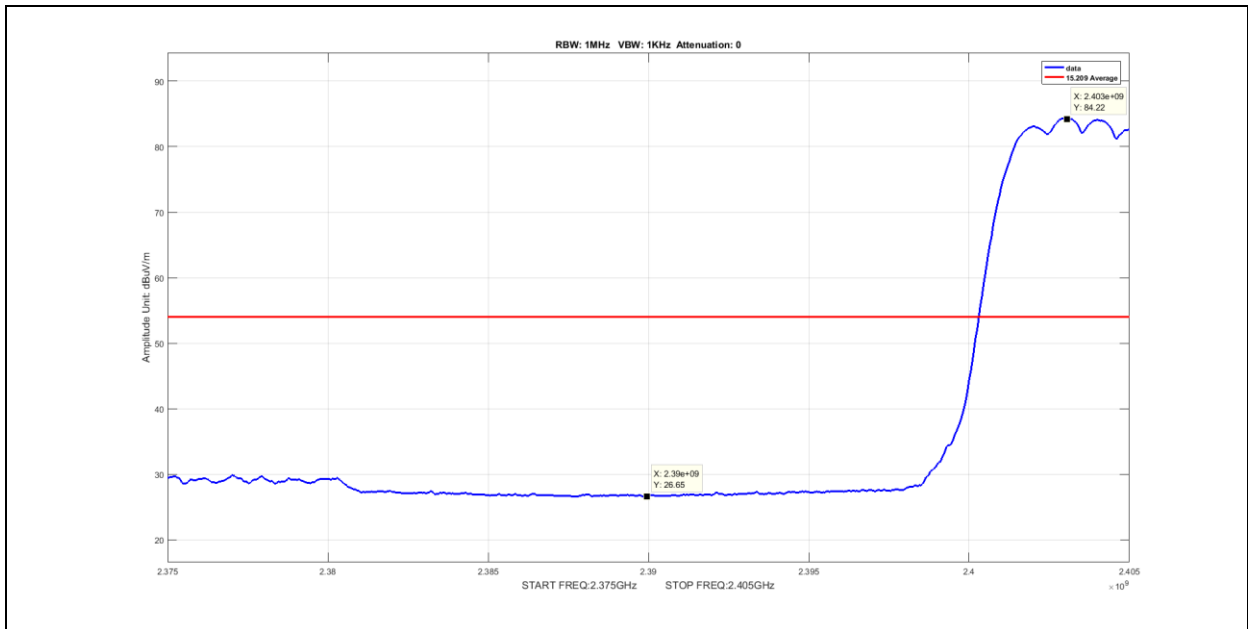


**Plot 80. Radiated Restricted Band Edge, Average, Hopping, 2390MHz, DH5**

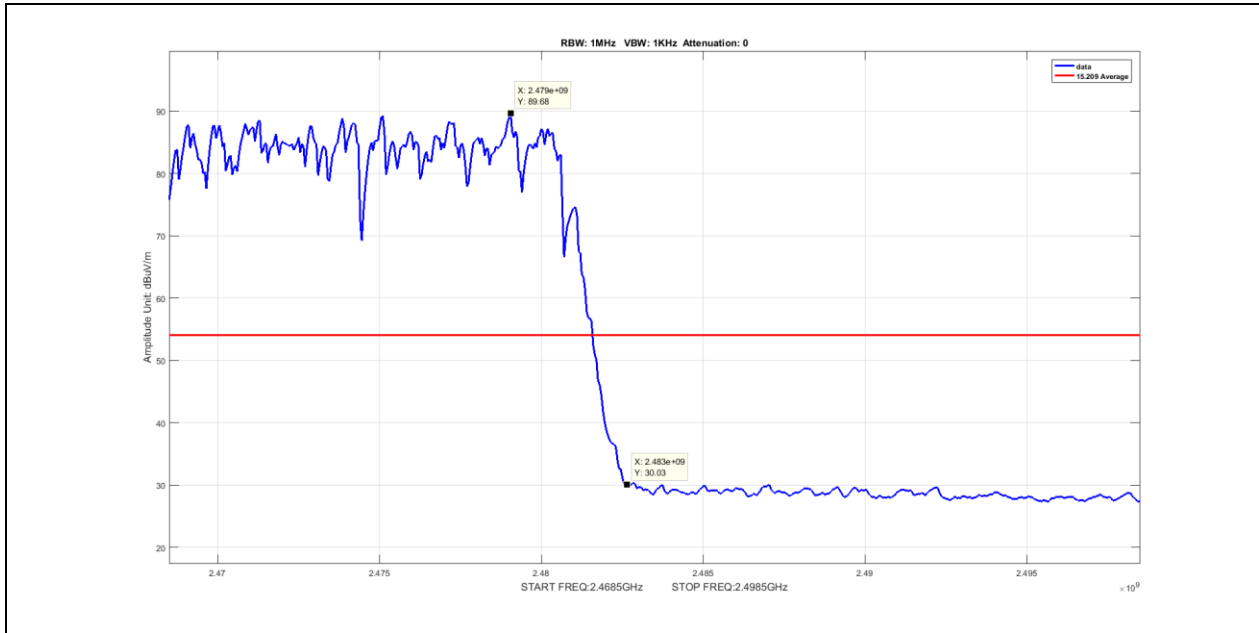




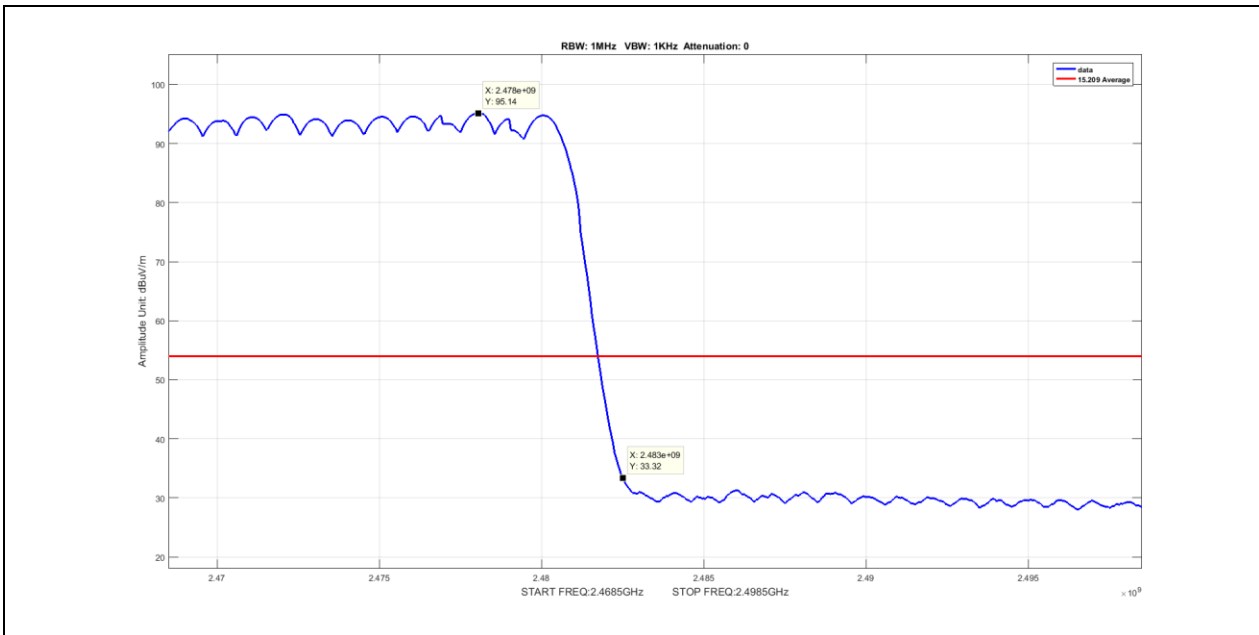
**Plot 81. Radiated Restricted Band Edge, Average, Hopping, 2390MHz, 3-DH1**



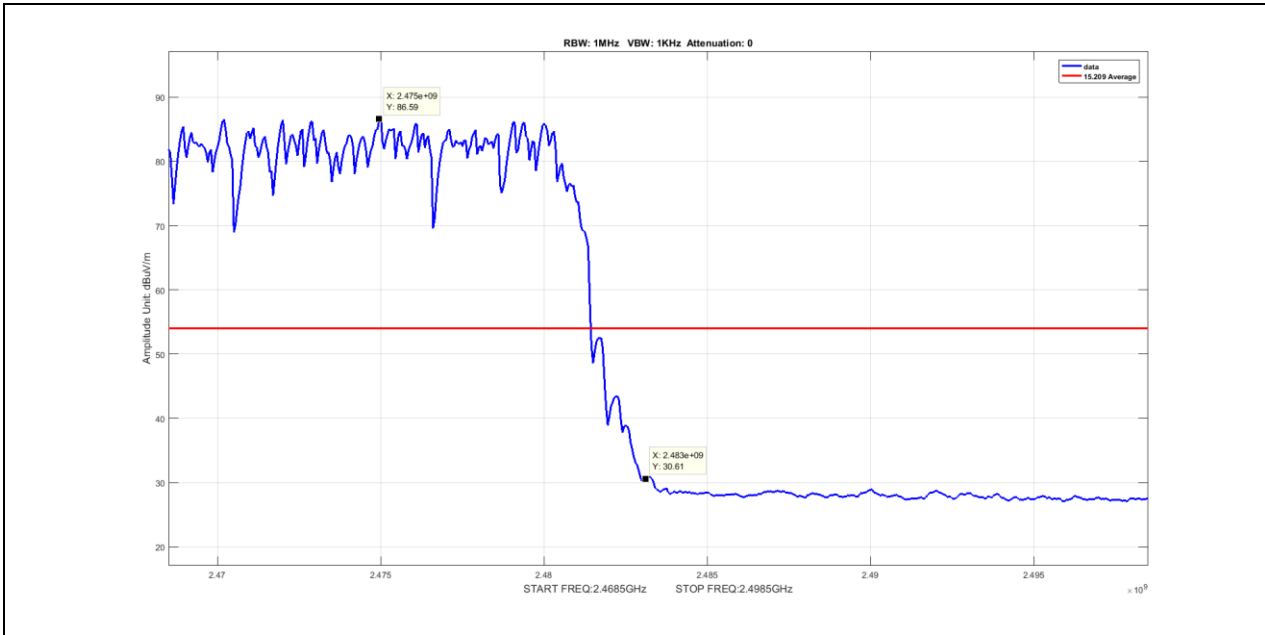
**Plot 82. Radiated Restricted Band Edge, Average, Hopping, 2390MHz, 3-DH5**



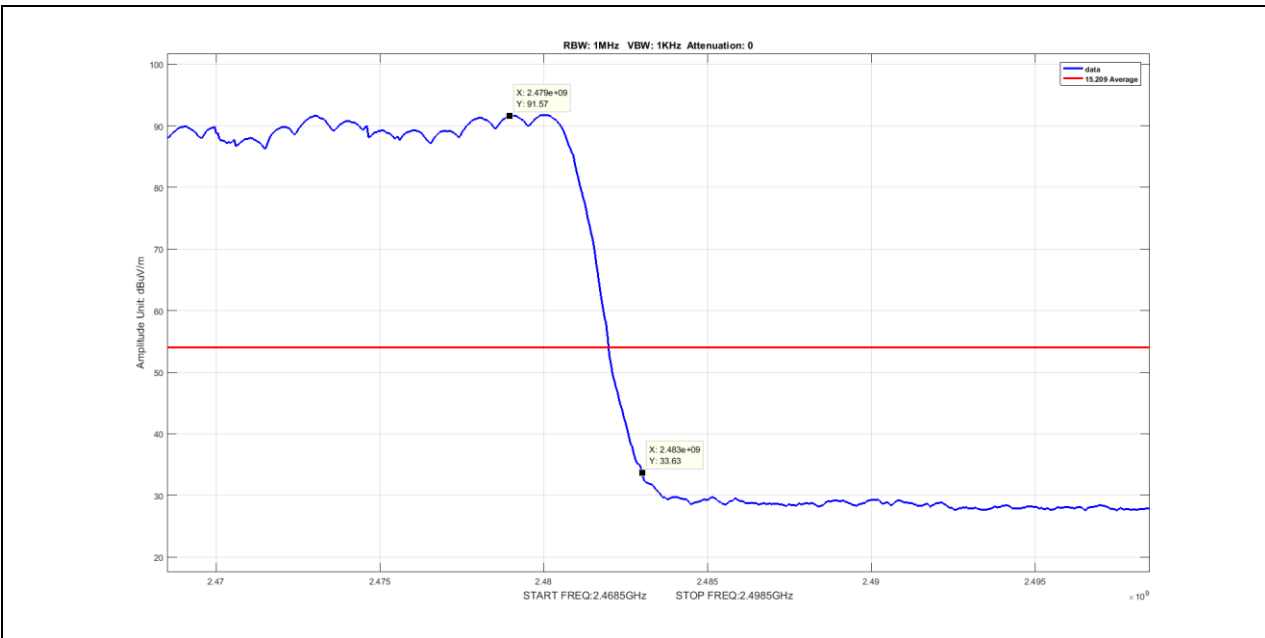
**Plot 83. Radiated Restricted Band Edge, Average, Hopping, 2483.5MHz, DH1**



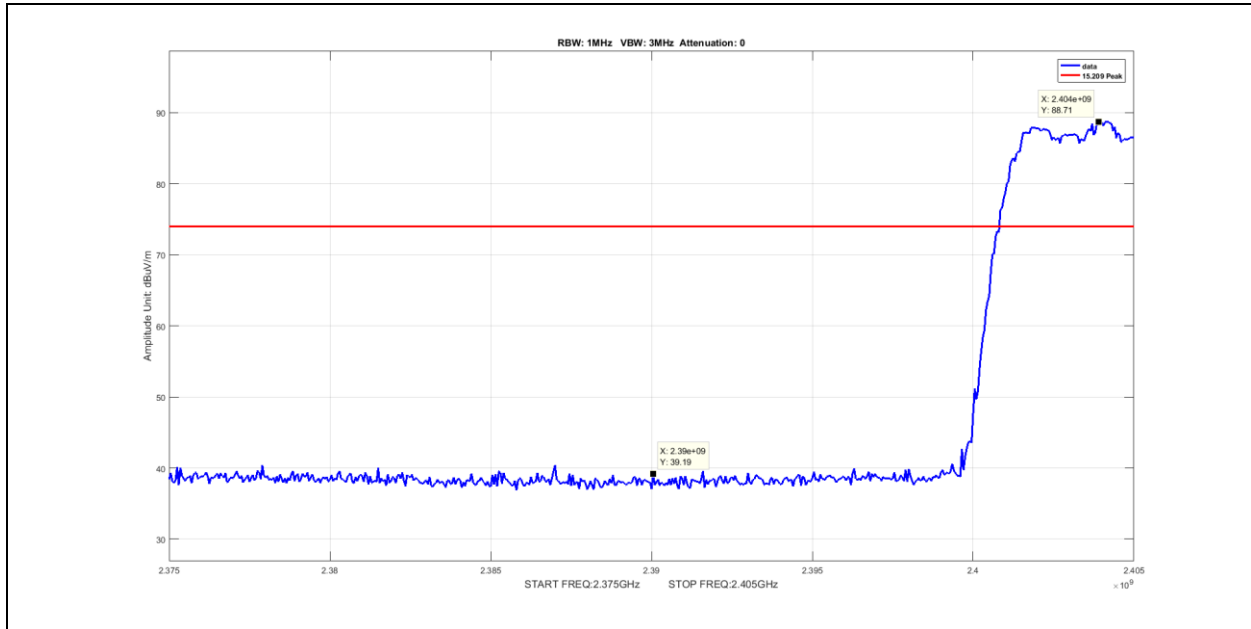
**Plot 84. Radiated Restricted Band Edge, Average, Hopping, 2483.5MHz, DH5**



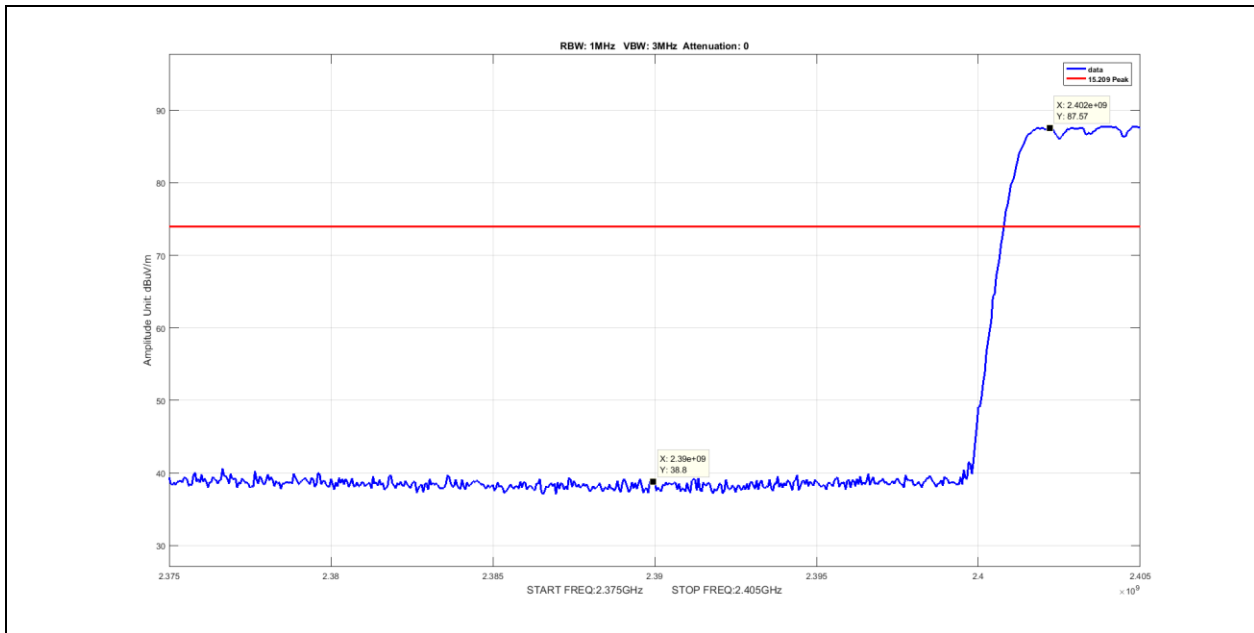
**Plot 85. Radiated Restricted Band Edge, Average, Hopping, 2483.5MHz, 3-DH1**



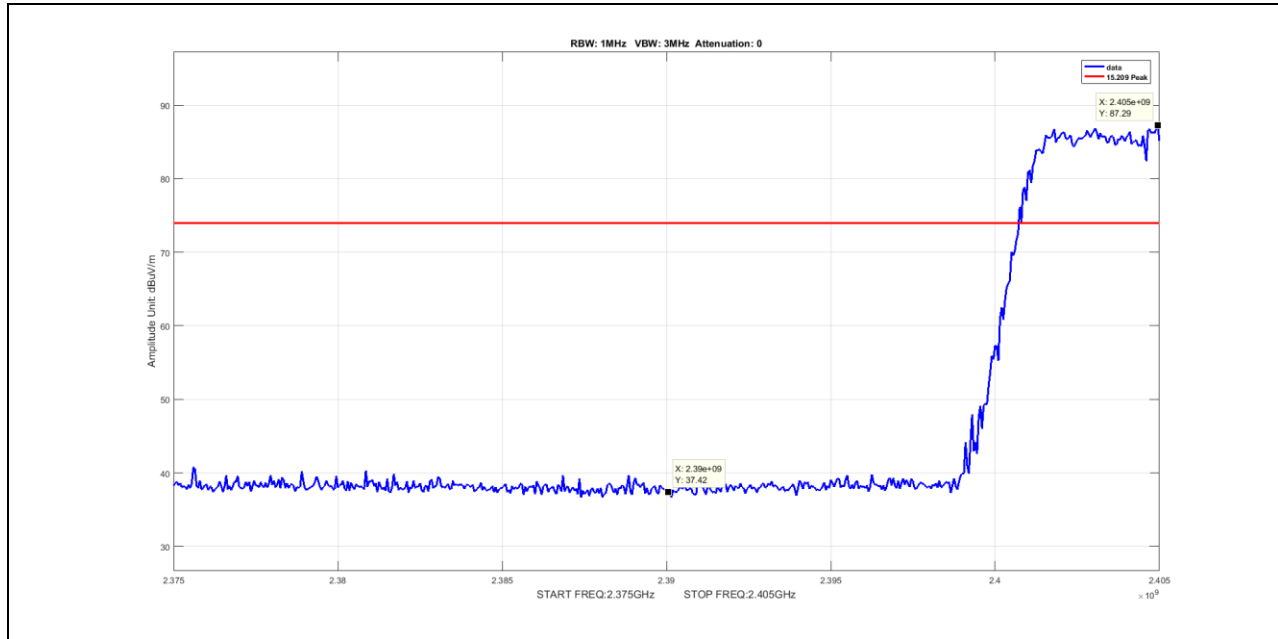
**Plot 86. Radiated Restricted Band Edge, Average, Hopping, 2483.5MHz, 3-DH5**



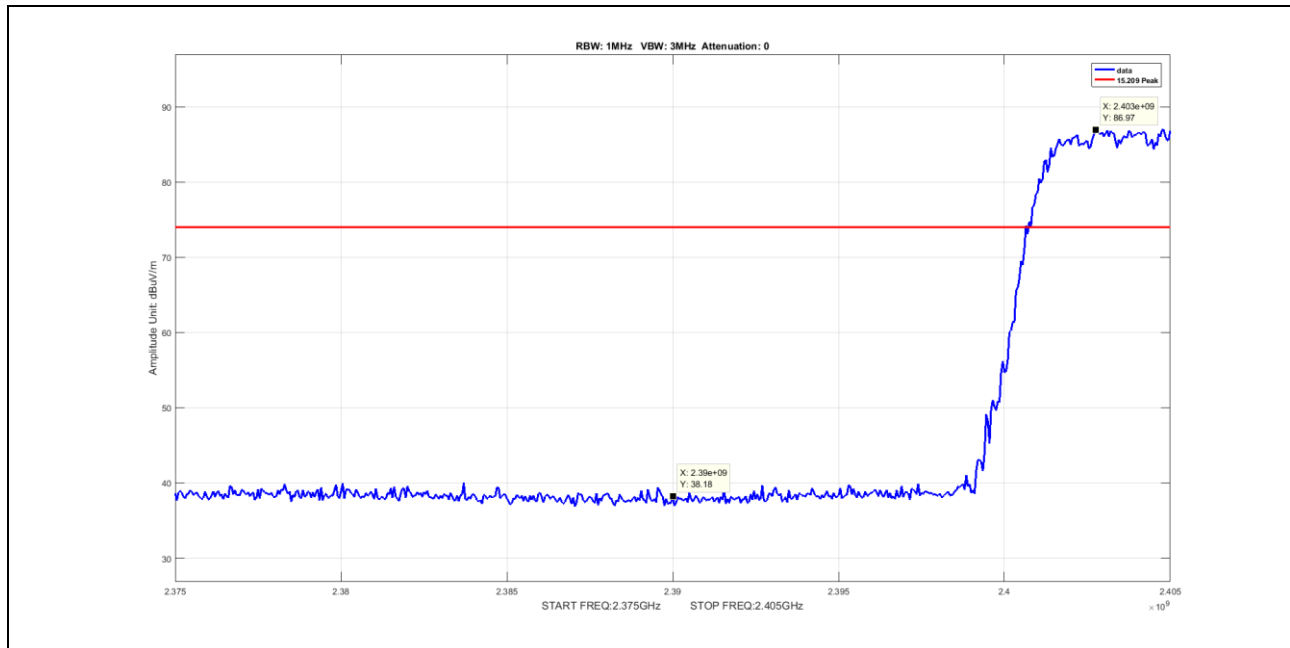
**Plot 87. Radiated Restricted Band Edge, Peak, Hopping, 2390MHz, DH1**



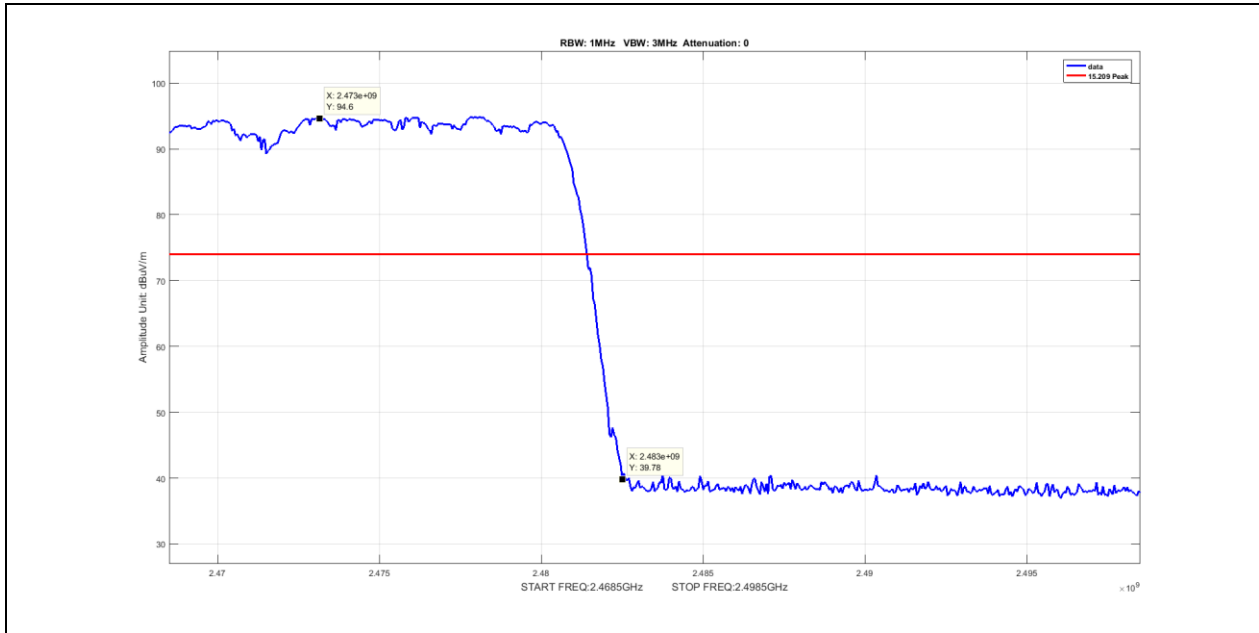
**Plot 88. Radiated Restricted Band Edge, Peak, Hopping, 2390MHz, DH5**



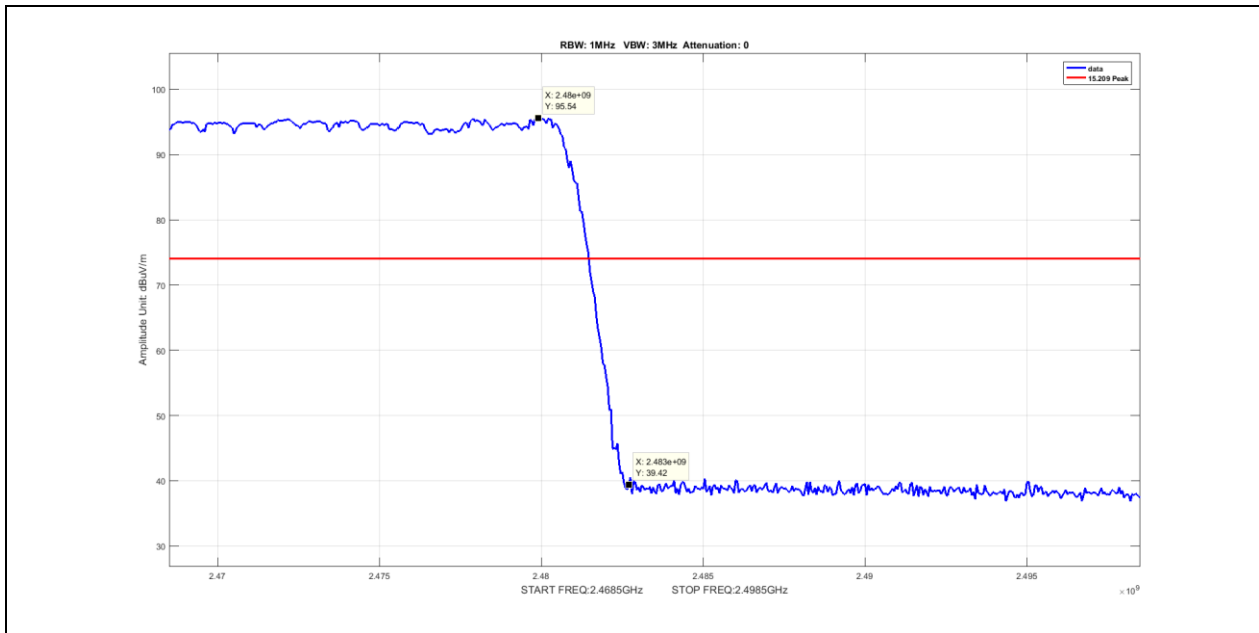
**Plot 89. Radiated Restricted Band Edge, Peak, Hopping, 2390MHz, 3-DH1**



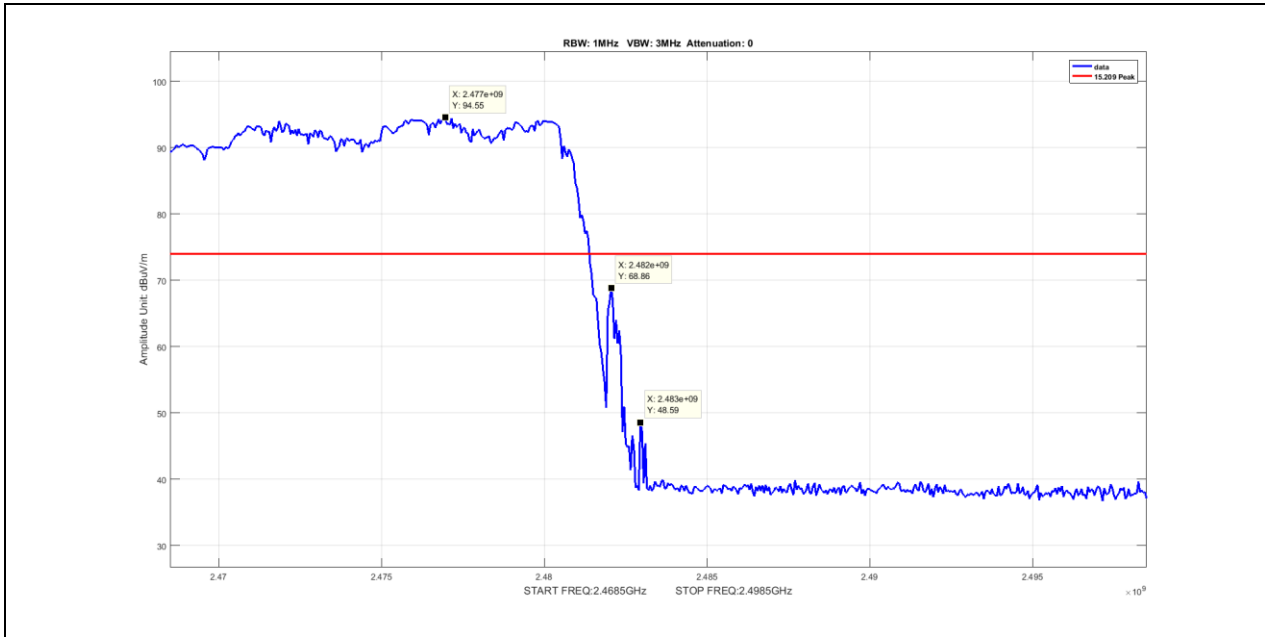
**Plot 90. Radiated Restricted Band Edge, Peak, Hopping, 2390MHz, 3-DH5**



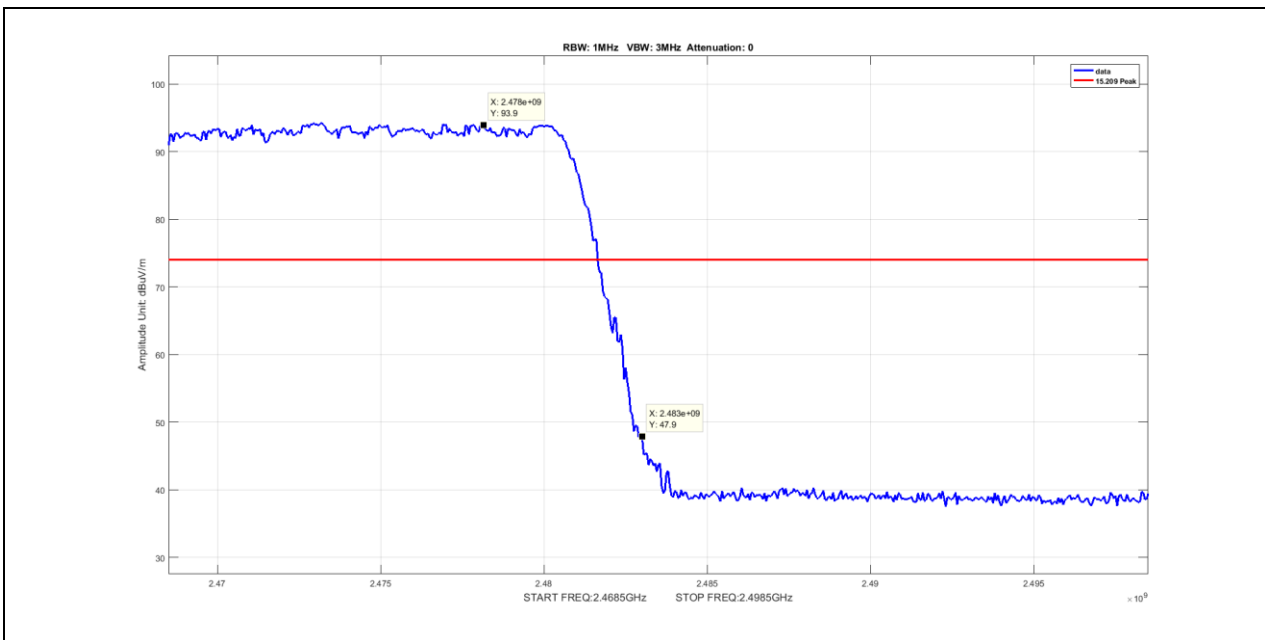
**Plot 91. Radiated Restricted Band Edge, Peak, Hopping, 2483.5MHz, DH1**



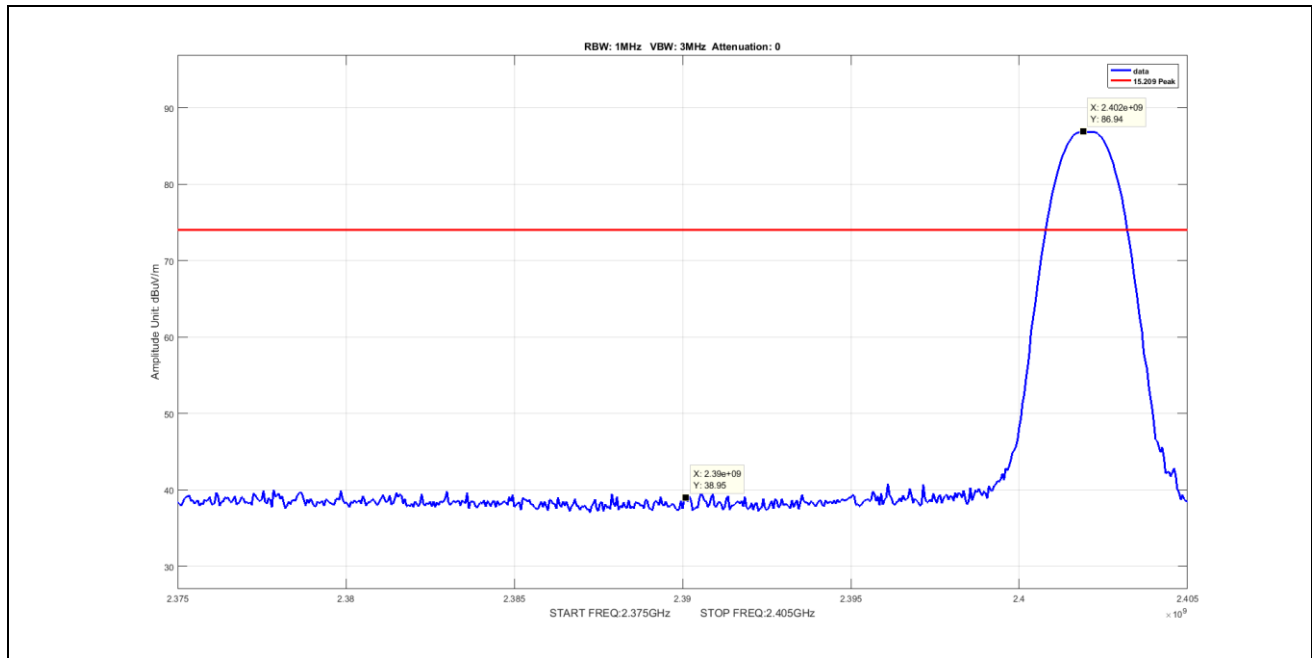
**Plot 92. Radiated Restricted Band Edge, Peak, Hopping, 2483.5MHz, DH5**



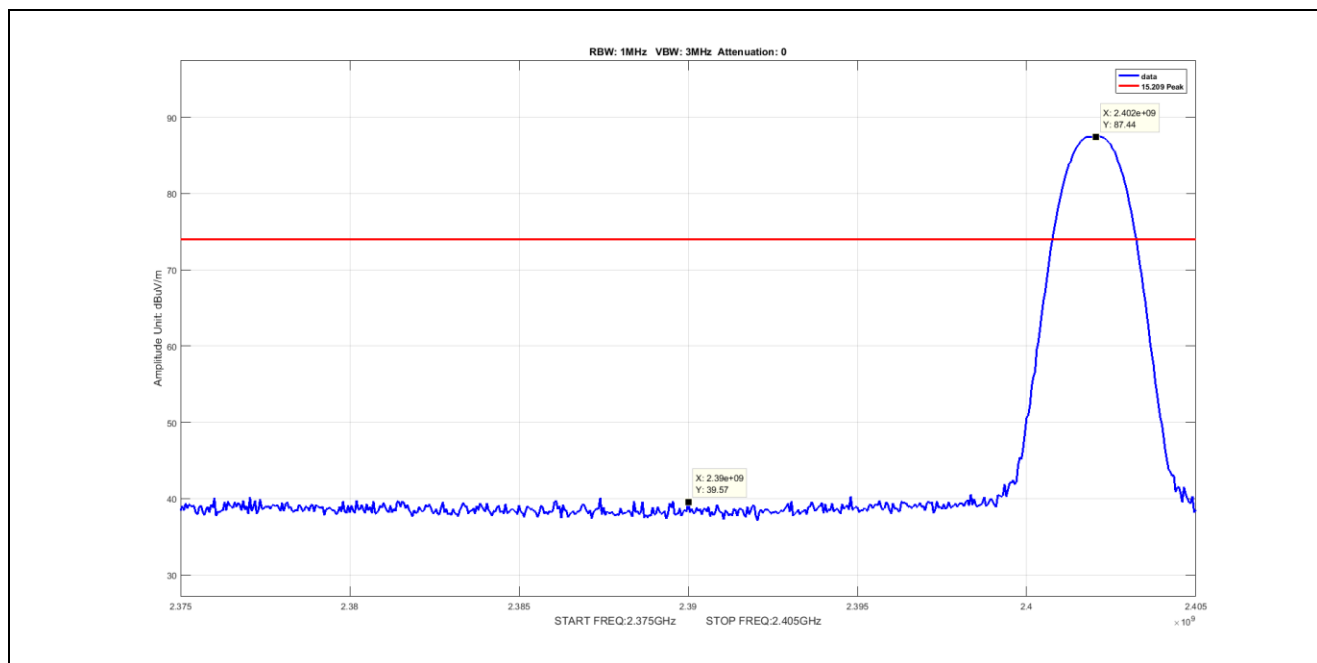
**Plot 93. Radiated Restricted Band Edge, Peak, Hopping, 2483.5MHz, 3-DH1**



**Plot 94. Radiated Restricted Band Edge, Peak, Hopping, 2483.5MHz, 3-DH5**

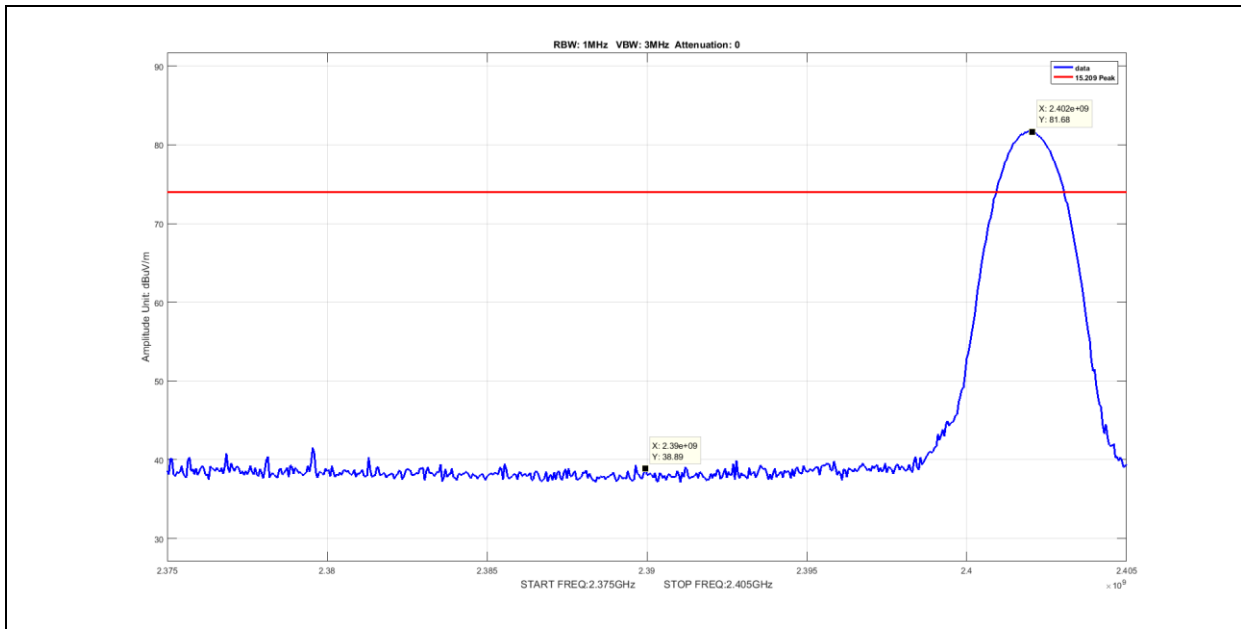


**Plot 95. Radiated Restricted Band Edge, Peak, 2402MHz, DH1**

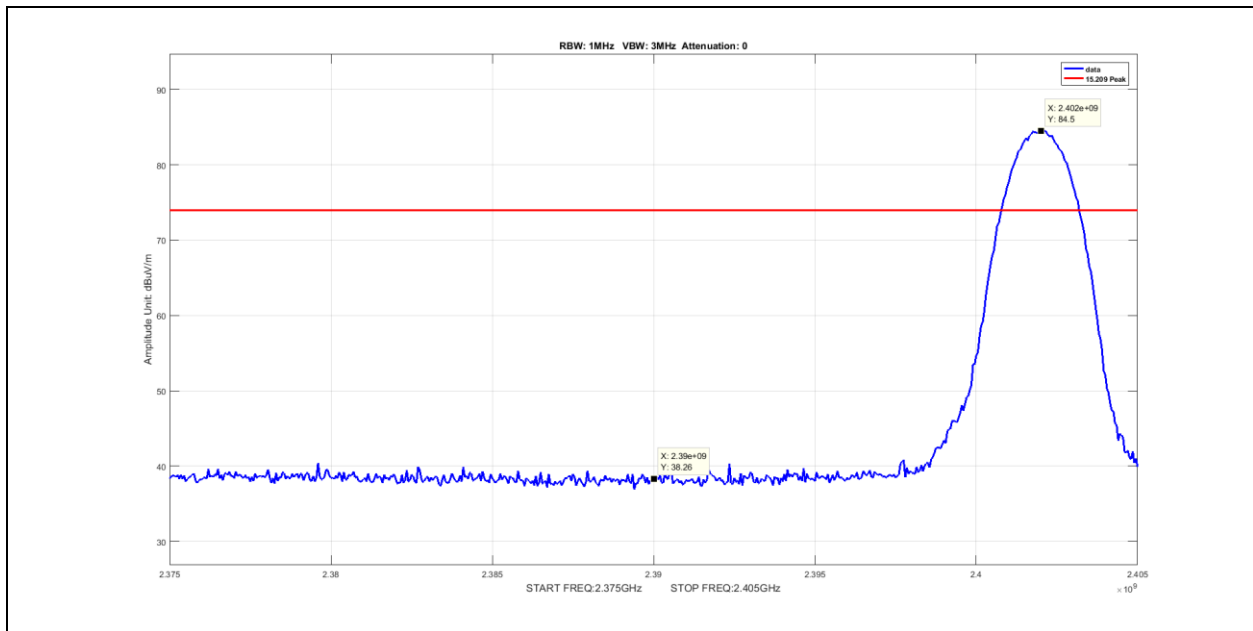


**Plot 96. Radiated Restricted Band Edge, Peak, 2402MHz, DH5**

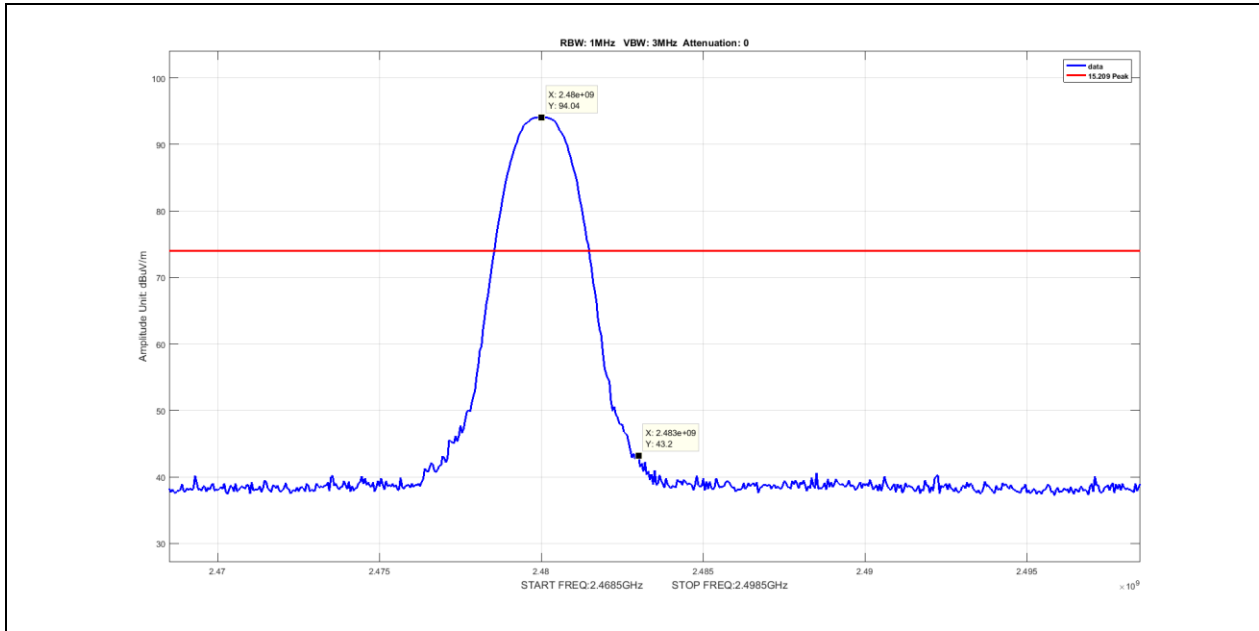




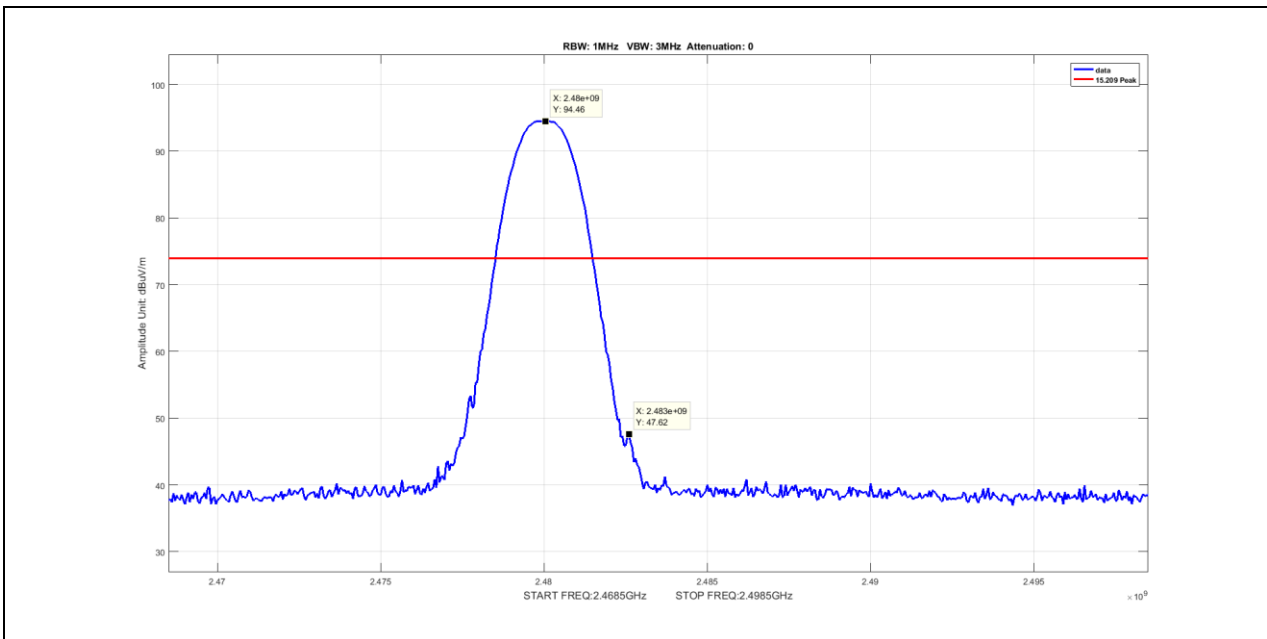
**Plot 97. Radiated Restricted Band Edge, Peak, 2402MHz, 3-DH1**



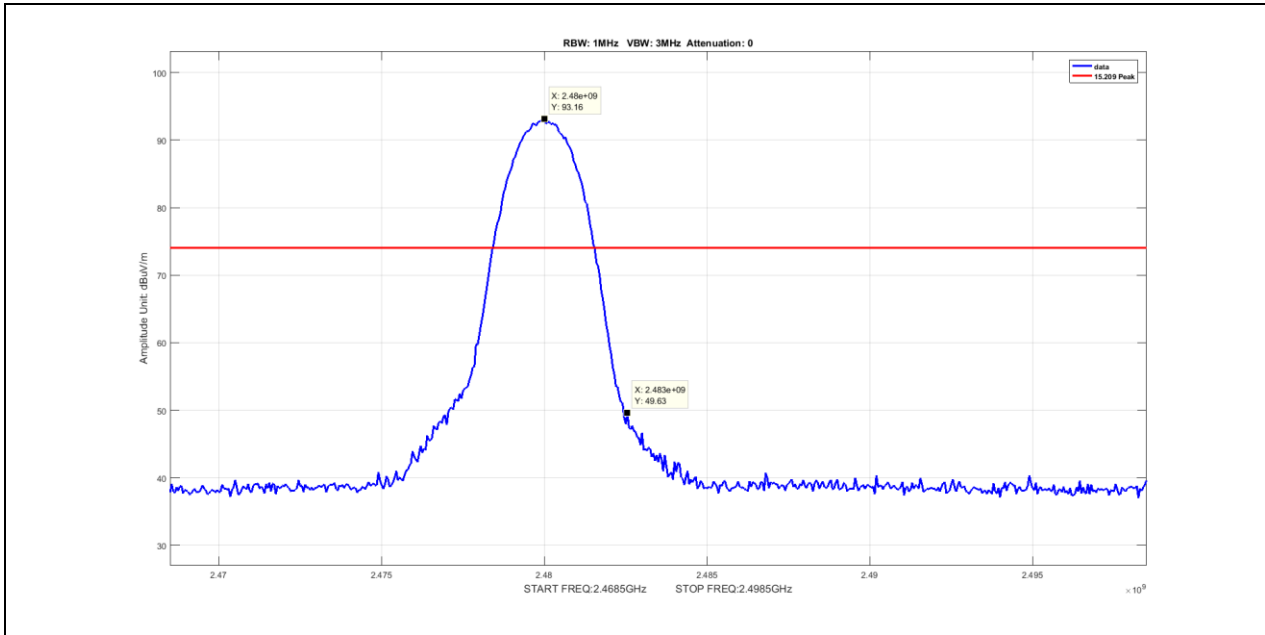
**Plot 98. Radiated Restricted Band Edge, Peak, 2402MHz, 3-DH5**



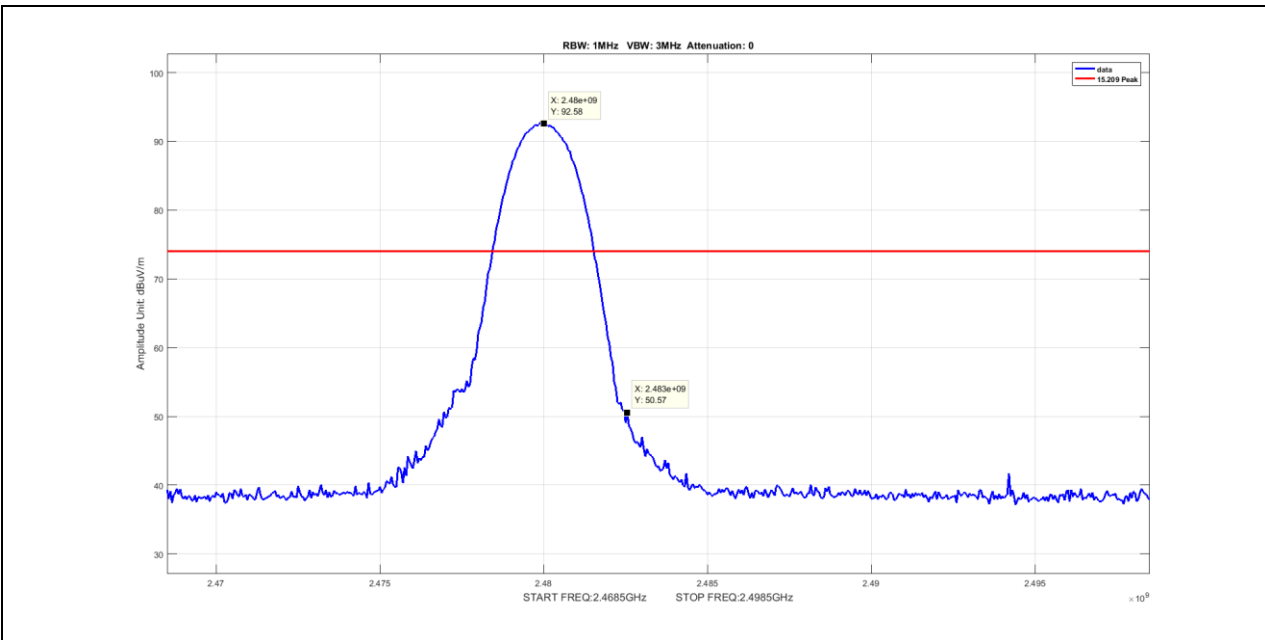
**Plot 99. Radiated Restricted Band Edge, Peak, 2480MHz, DH1**



**Plot 100. Radiated Restricted Band Edge, Peak, 2480MHz, DH5**



**Plot 101. Radiated Restricted Band Edge, Peak, Nonhopping, 2480MHz, 3-DH1**



**Plot 102. Radiated Restricted Band Edge, Peak, Nonhopping, 2480MHz, 3-DH5**

**Test Procedures for Radiated Band Edge for High Channel 2480 MHz:**

1. The field strength of the fundamental emission was measured using a 1MHz RBW and a 3MHz VBW for the peak value and a 1MHz RBW and a 10Hz VBW for the average value.
2. The spectrum analyzer was spanned to encompass both the peak of the fundamental emission and the band edge emission under investigation. The RBW was set to 1% of the span and the VBW to 3x the RBW. The delta between the peak levels of the fundamental emission at the relevant band edge emission was measured and recorded.
3. The resulting delta value was used to determine compliance.

## Electromagnetic Compatibility Criteria for Intentional Radiators

### § 15.247(d) RF Conducted Spurious Emissions Requirements and Band Edge

**Test Requirement:** **15.247(d)** In any 100 kHz bandwidth outside the frequency band in which the spread spectrum or digitally modulated intentional radiator is operating, the radio frequency power that is produced by the intentional radiator shall be at least 20 dB below that in the 100 kHz bandwidth within the band that contains the highest level of the desired power, based on either an RF conducted or a radiated measurement, provided the transmitter demonstrates compliance with the peak conducted power limits. If the transmitter complies with the conducted power limits based on the use of RMS averaging over a time interval, as permitted under paragraph (b)(3) of this section, the attenuation required under this paragraph shall be 30 dB instead of 20 dB.

**Test Procedure:** For intentional radiators with a digital device portion which operates below 10 GHz, the spectrum was investigated as per §15.33(a)(1) and §15.33(a)(4); i.e., the lowest RF signal generated or used in the device up to the 10<sup>th</sup> harmonic of the highest fundamental frequency or to 40 GHz, whichever is lower.

Since the EUT had an integral antenna, conducted measurements could not be performed. Measurements needed to be taken radiated. An antenna was located 3 m away from the EUT and plots were taken. The EUT was rotated through all three orthogonal axes. The plots were corrected for both antenna correction factor and cable loss.

See following pages for detailed test results with RF Conducted Spurious Emissions.

**Test Results:** The EUT was compliant with the Conducted Spurious Emission limits of **§15.247(d)**. Measured emissions were below applicable limits. Emissions from 18 GHz to 26.5 GHz were investigated, and only noise floor was measured.

**Test Engineer(s):** Surendra Shrestha

**Test Date(s):** 11/11/2017

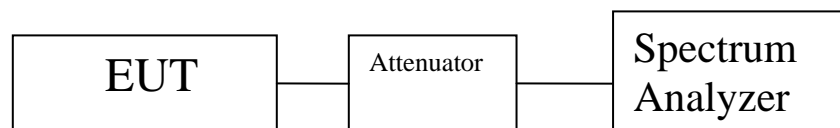


Figure 4. Block Diagram, Conducted Spurious Emissions Test Setup

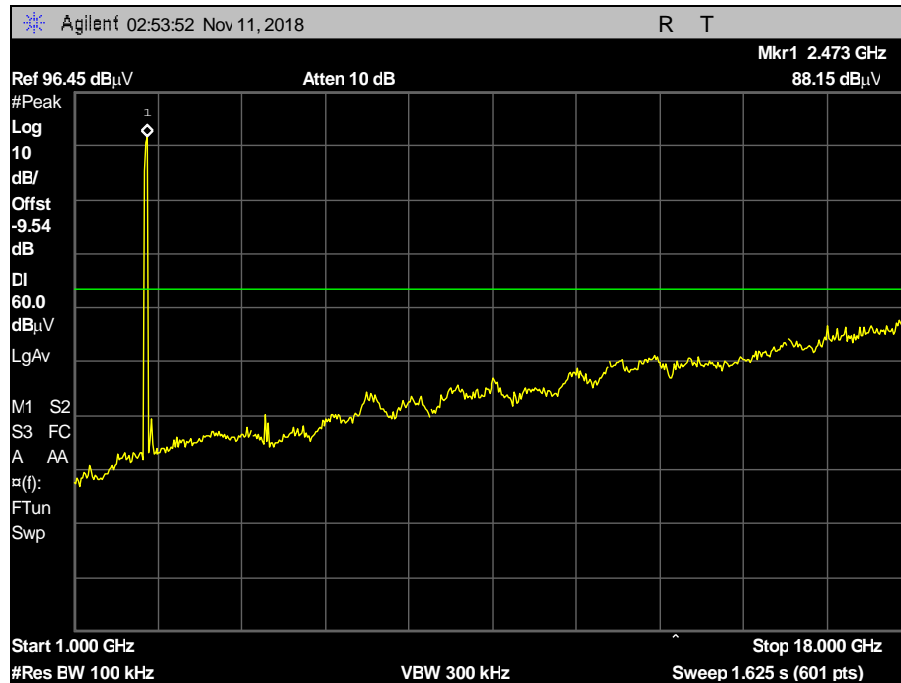
## Conducted Spurious Emissions Test Results



Plot 103. Conducted Spurious Emissions, Hopping, DH1, 1 GHz – 18 GHz



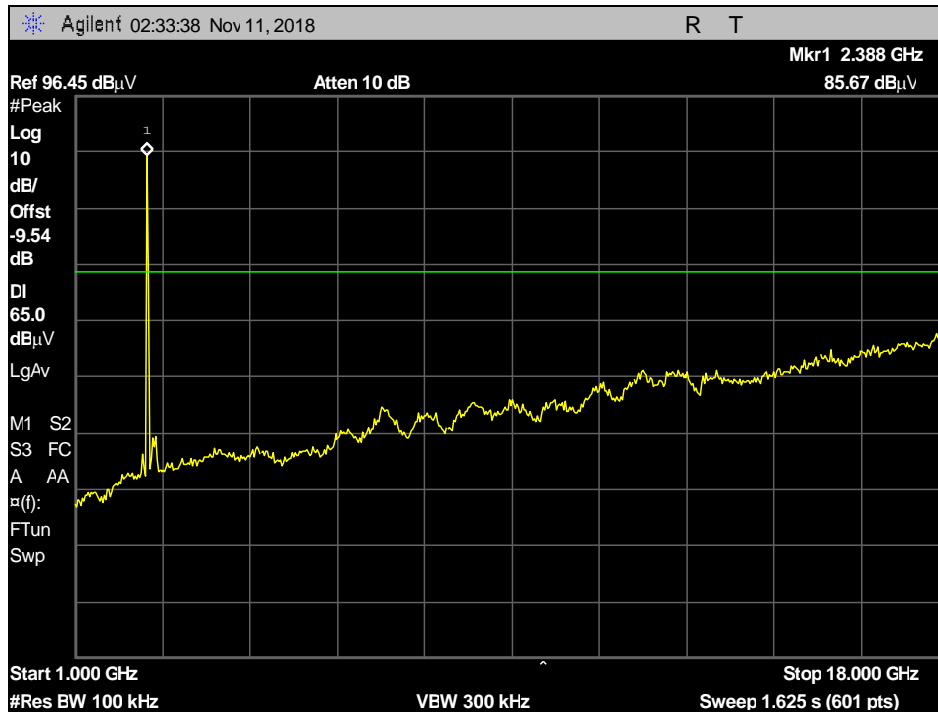
Plot 104. Conducted Spurious Emissions, Hopping, DH5, 1 GHz – 18 GHz



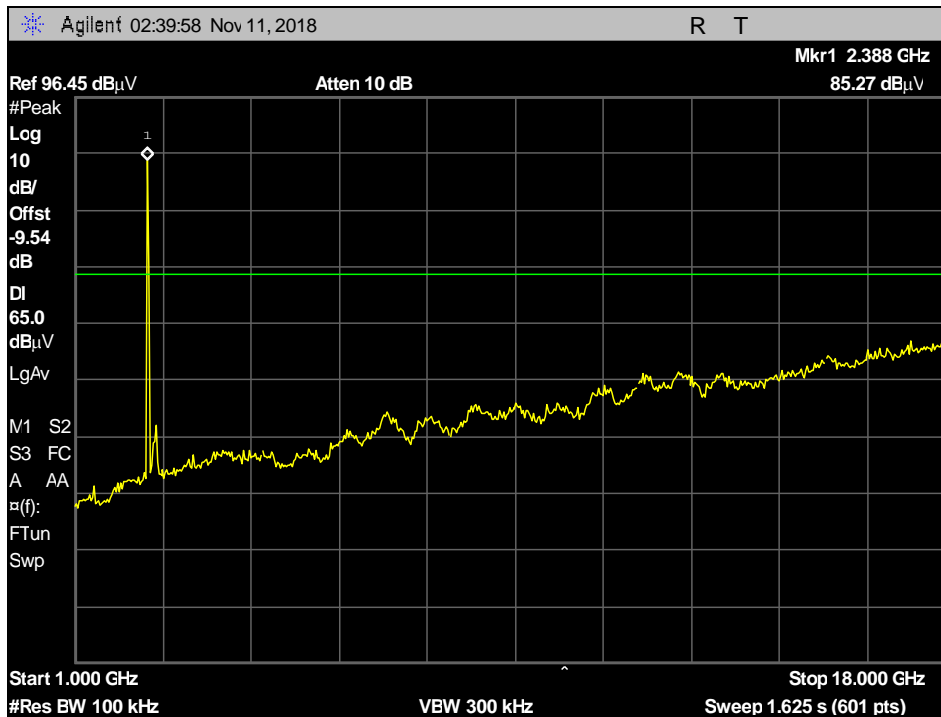
**Plot 105. Conducted Spurious Emissions, Hopping, 3-DH1, 1 GHz – 18 GHz**



**Plot 106. Conducted Spurious Emissions, Hopping, 3-DH5, 1 GHz – 18 GHz**

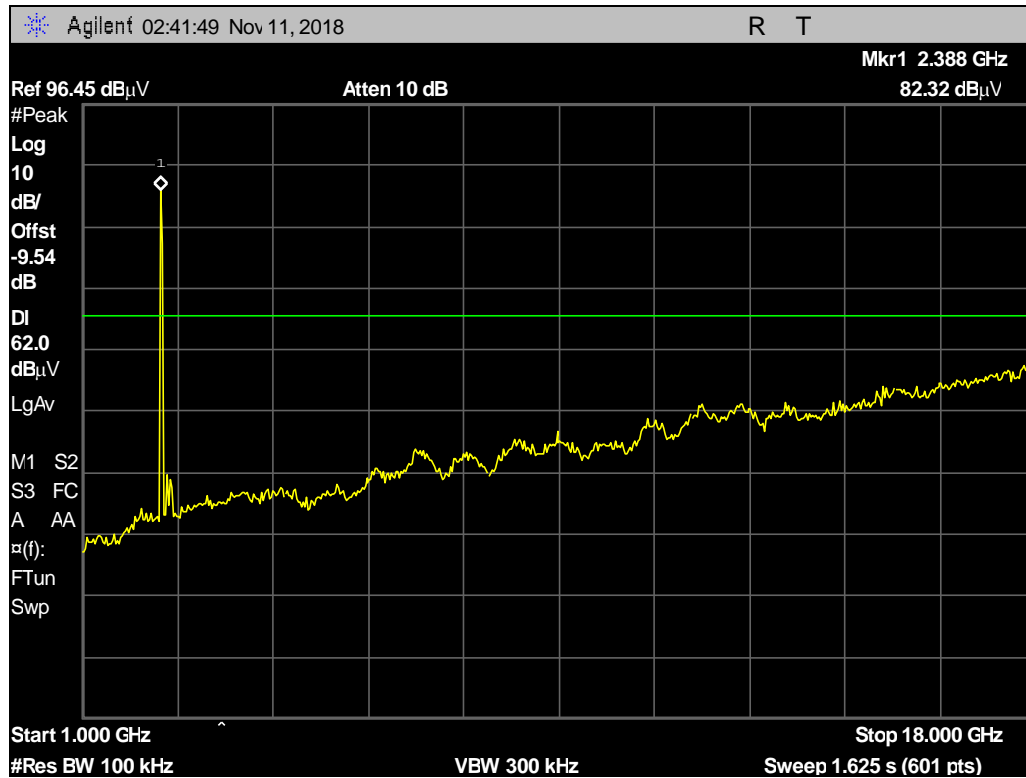


Plot 107. Conducted Spurious Emissions, Nonhopping, 2402MHz, DH1, 1 GHz – 18 GHz

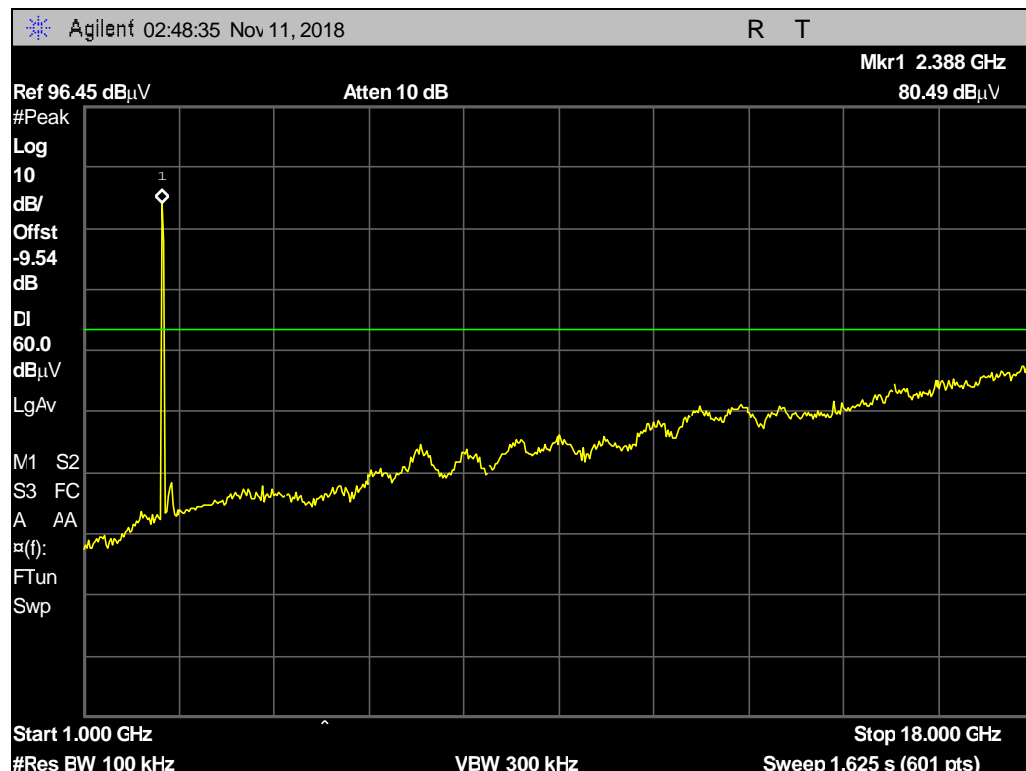


Plot 108. Conducted Spurious Emissions, Nonhopping, 2402MHz, DH5, 1 GHz – 18 GHz

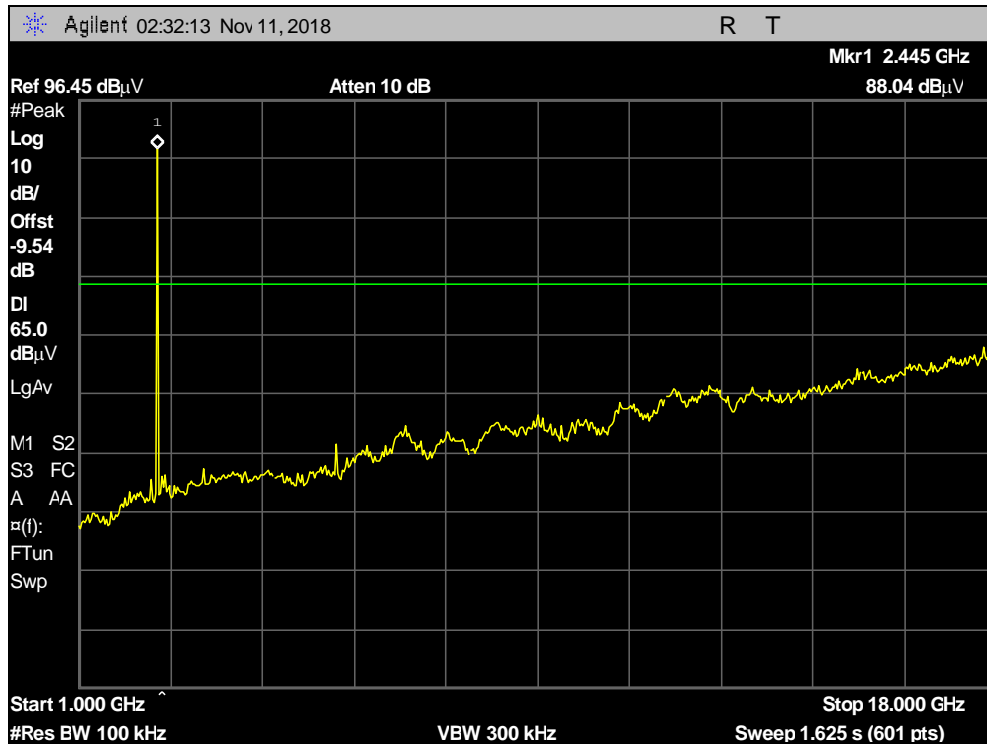




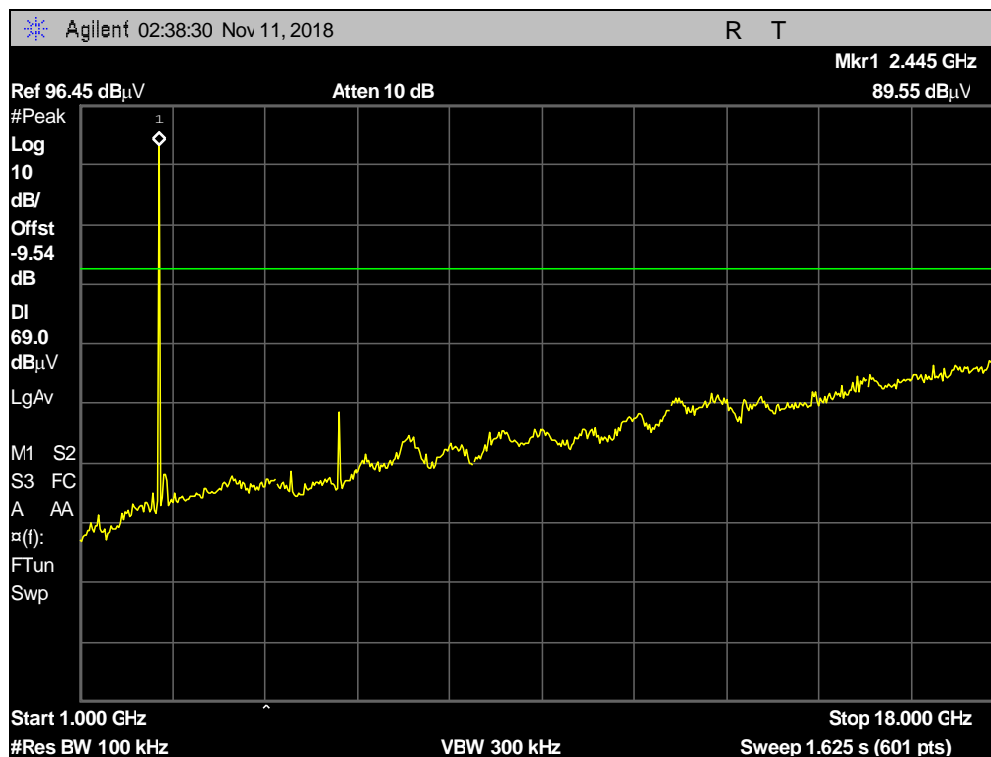
Plot 109. Conducted Spurious Emissions, Nonhopping, 2402MHz, 3-DH1, 1 GHz – 18 GHz



Plot 110. Conducted Spurious Emissions, Nonhopping, 2402MHz, 3-DH5, 1 GHz – 18 GHz



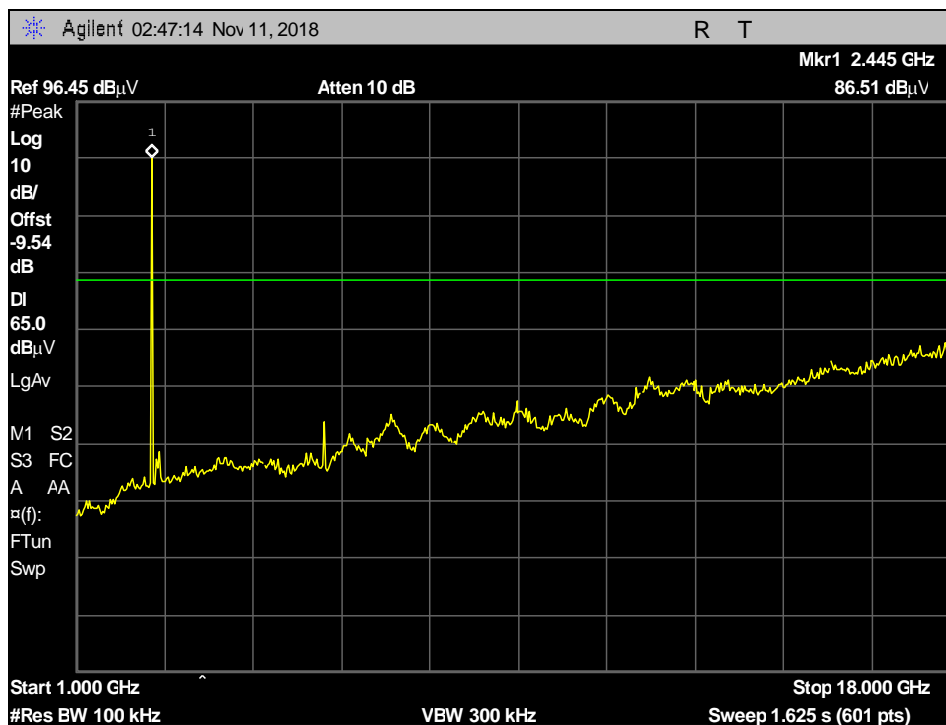
Plot 111. Conducted Spurious Emissions, Nonhopping, 2441MHz, DH1, 1 GHz – 18 GHz



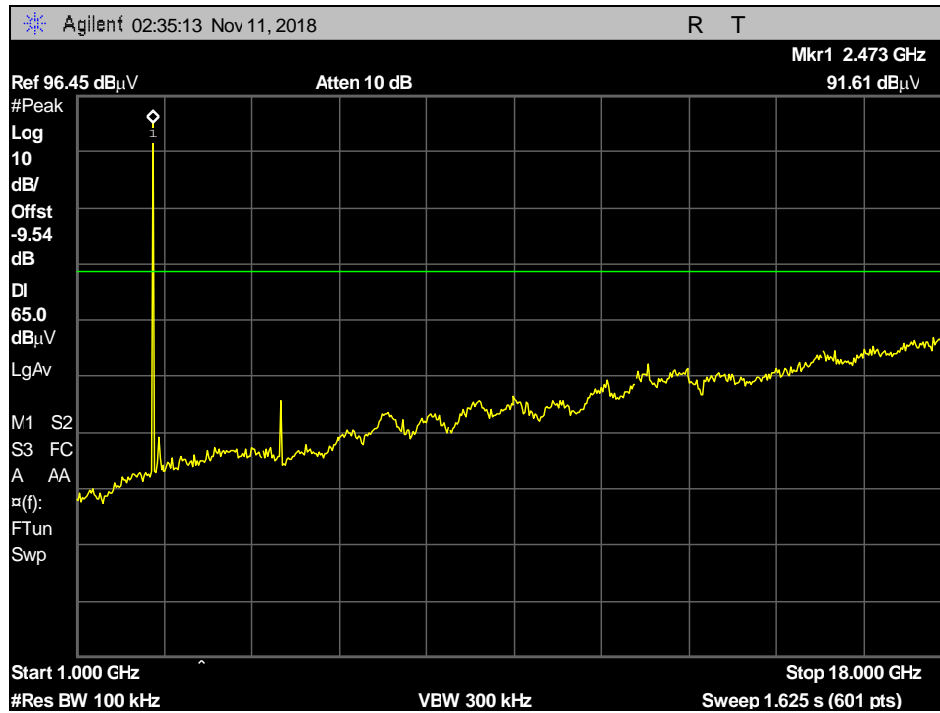
Plot 112. Conducted Spurious Emissions, Nonhopping, 2441MHz, DH5, 1 GHz – 18 GHz



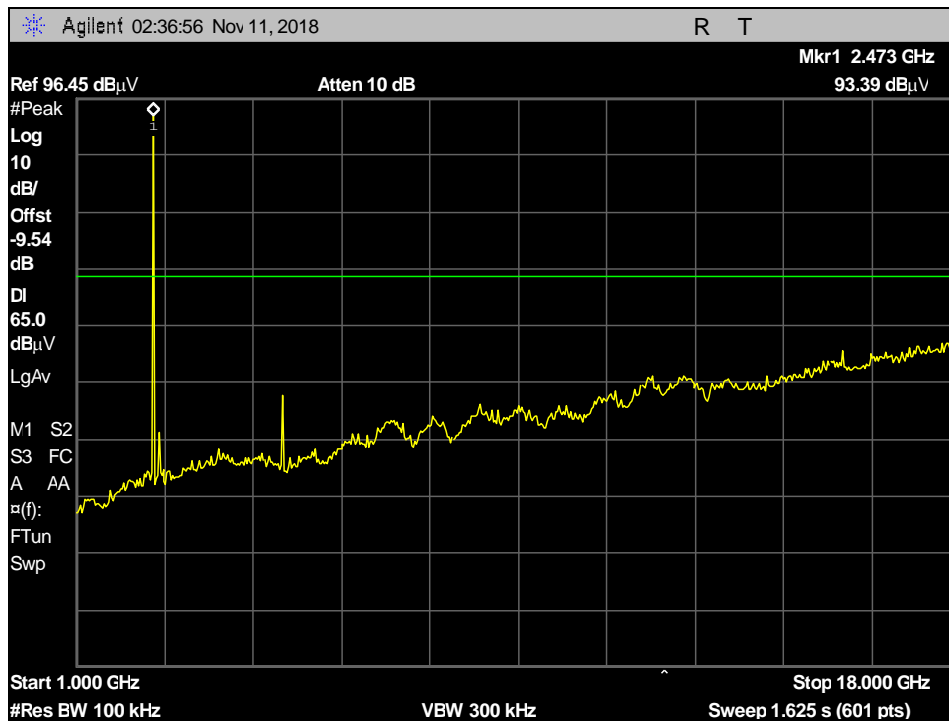
Plot 113. Conducted Spurious Emissions, Nonhopping, 2441MHz, 3-DH1, 1 GHz – 18 GHz



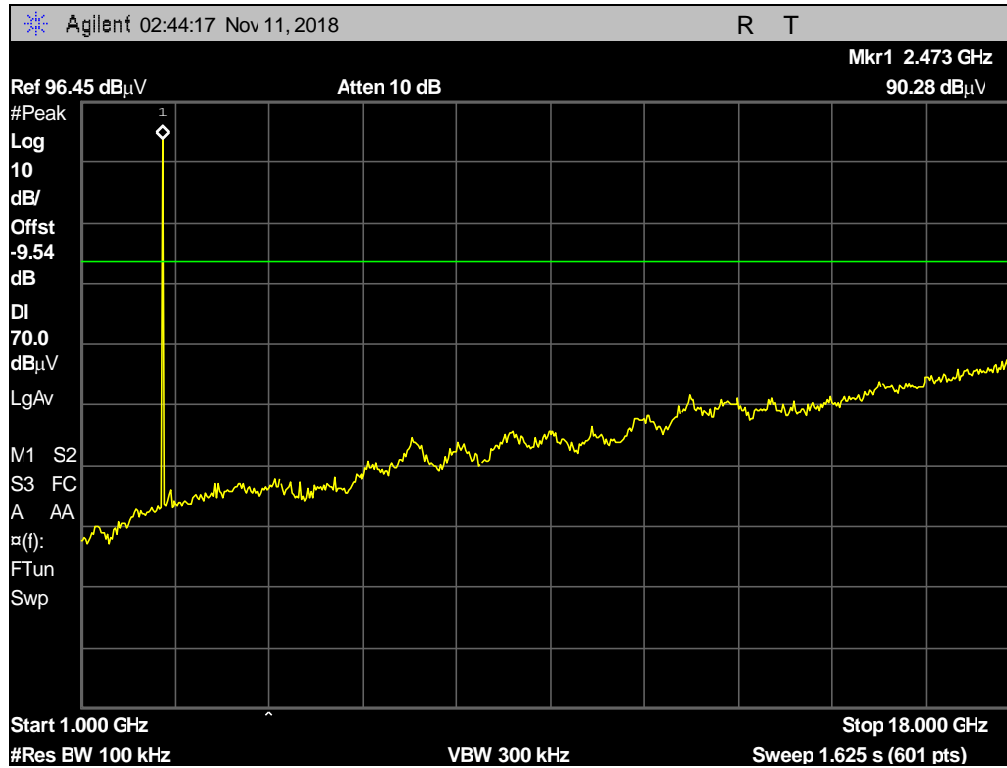
Plot 114. Conducted Spurious Emissions, Nonhopping, 2441MHz, 3-DH5, 1 GHz – 18 GHz



Plot 115. Conducted Spurious Emissions, Nonhopping, 2480MHz, DH1, 1 GHz – 18 GHz



Plot 116. Conducted Spurious Emissions, Nonhopping, 2480MHz, DH5, 1 GHz – 18 GHz



Plot 117. Conducted Spurious Emissions, Nonhopping, 2480MHz, 3-DH1, 1 GHz – 18 GHz



Plot 118. Conducted Spurious Emissions, Nonhopping, 2480MHz, 3-DH5, 1 GHz – 18 GHz

## Electromagnetic Compatibility Criteria for Intentional Radiators

### § 15.247(i) Maximum Permissible Exposure

**RF Exposure Requirements:** §1.1307(b)(1) and §1.1307(b)(2): Systems operating under the provisions of this section shall be operated in a manner that ensures that the public is not exposed to radio frequency energy levels in excess of the Commission's guidelines.

**RF Radiation Exposure Limit:** §1.1310: As specified in this section, the Maximum Permissible Exposure (MPE) Limit shall be used to evaluate the environmental impact of human exposure to radiofrequency (RF) radiation as specified in Sec. 1.1307(b), except in the case of portable devices which shall be evaluated according to the provisions of Sec. 2.1093 of this chapter.

FCC									
Frequency (MHz)	Con. Pwr. (dBm)	Con. Pwr. (mW)	Ant. Gain (dBi)	Ant. Gain numeric	Pwr. Density (mW/cm <sup>2</sup> )	Limit (mW/cm <sup>2</sup> )	Margin	Distance (cm)	Result
2480	7.46	5.572	0	1	0.00111	1	0.99889	20	Pass

## IV. Test Equipment

## Test Equipment

Calibrated test equipment utilized during testing was maintained in a current state of calibration per the requirements of ISO/IEC 17025:2005.

MET Asset #	Equipment	Manufacturer	Model	Last Cal Date	Cal Due Date
1T4612	SPECTRUM ANALYZER	AGILENT TECHNOLOGIES	E4407B	03/30/2017	09/30/2018
1T4771	PSA SPECTRUM ANALYZER	AGILENT TECHNOLOGIES	E4446A	08/10/2016	02/10/2018
1T4149	HIGH-FREQUENCY ANECHOIC CHAMBER	RAY PROOF	81	NOT REQUIRED	
1T4442	PRE-AMPLIFIER, MICROWAVE	MITEQ	AFS42-01001800-30-10P	SEE NOTE	
1T4483	ANTENNA; HORN	ETS-LINDGREN	3117	04/19/2017	10/19/2018
1T4745	ANTENNA, HORN	ETS-LINDGREN	3116	01/21/2017	07/21/2018
1T4752	PRE-AMPLIFIER	MITEQ	JS44-18004000-35-8P	SEE NOTE	
1T4300A	SEMI-ANECHOIC CHAMBER # 1 (FCC)	EMC TEST SYSTEMS	NONE	01/31/2016	01/31/2019
1T4753	ANTENNA - BILOG	SUNOL SCIENCES	JB6	10/24/2016	04/24/2018
1T4409	EMI RECEIVER	ROHDE & SCHWARZ	ESIB7	12/07/2016	12/07/2018

**Table 15. Test Equipment List**

Note: Functionally tested equipment is verified using calibrated instrumentation at the time of testing.



## **V. Certification & User's Manual Information**

## Certification & User's Manual Information

### A. Certification Information

The following is extracted from Title 47 of the Code of Federal Regulations, Part 2, Subpart I — Marketing of Radio frequency devices:

#### § 2.801 Radio-frequency device defined.

As used in this part, a radio-frequency device is any device which in its operation is capable of Emitting radio-frequency energy by radiation, conduction, or other means. Radio- frequency devices include, but are not limited to:

- (a) The various types of radio communication transmitting devices described throughout this chapter.
- (b) *The incidental, unintentional and intentional radiators defined in Part 15 of this chapter.*
- (c) The industrial, scientific, and medical equipment described in Part 18 of this chapter.
- (d) Any part or component thereof which in use emits radio-frequency energy by radiation, conduction, or other means.

#### § 2.803 Marketing of radio frequency devices prior to equipment authorization.

- (a) Except as provided elsewhere in this chapter, no person shall sell or lease, or offer for sale or lease (including advertising for sale or lease), or import, ship or distribute for the purpose of selling or leasing or offering for sale or lease, any radio frequency device unless:
  - (1) In the case of a device subject to certification, such device has been authorized by the Commission in accordance with the rules in this chapter and is properly identified and labeled as required by §2.925 and other relevant sections in this chapter; or
  - (2) In the case of a device that is not required to have a grant of equipment authorization issued by the Commission, but which must comply with the specified technical standards prior to use, such device also complies with all applicable administrative (including verification of the equipment or authorization under a Declaration of Conformity, where required), technical, labeling and identification requirements specified in this chapter.
- (d) Notwithstanding the provisions of paragraph (a) of this section, the offer for sale solely to business, commercial, industrial, scientific or medical users (but not an offer for sale to other parties or to end users located in a residential environment) of a radio frequency device that is in the conceptual, developmental, design or pre-production stage is permitted prior to equipment authorization or, for devices not subject to the equipment authorization requirements, prior to a determination of compliance with the applicable technical requirements *provided* that the prospective buyer is advised in writing at the time of the offer for sale that the equipment is subject to the FCC rules and that the equipment will comply with the appropriate rules before delivery to the buyer or to centers of distribution.

- (e)(1) Notwithstanding the provisions of paragraph (a) of this section, prior to equipment authorization or determination of compliance with the applicable technical requirements any radio frequency device may be operated, but not marketed, for the following purposes and under the following conditions:
- (i) *Compliance testing*;
  - (ii) Demonstrations at a trade show provided the notice contained in paragraph (c) of this section is displayed in a conspicuous location on, or immediately adjacent to, the device;
  - (iii) Demonstrations at an exhibition conducted at a business, commercial, industrial, scientific or medical location, but excluding locations in a residential environment, provided the notice contained in paragraphs (c) or (d) of this section, as appropriate, is displayed in a conspicuous location on, or immediately adjacent to, the device;
  - (iv) Evaluation of product performance and determination of customer acceptability, provided such operation takes place at the manufacturer's facilities during developmental, design or pre-production states; or
  - (v) Evaluation of product performance and determination of customer acceptability where customer acceptability of a radio frequency device cannot be determined at the manufacturer's facilities because of size or unique capability of the device, provided the device is operated at a business, commercial, industrial, scientific or medical user's site, but not at a residential site, during the development, design or pre-production stages.
- (e)(2) For the purpose of paragraphs (e)(1)(iv) and (e)(1)(v) of this section, the term *manufacturer's facilities* includes the facilities of the party responsible for compliance with the regulations and the manufacturer's premises, as well as the facilities of other entities working under the authorization of the responsible party in connection with the development and manufacture, but not the marketing, of the equipment.
- (f) For radio frequency devices subject to verification and sold solely to business, commercial, industrial, scientific and medical users (excluding products sold to other parties or for operation in a residential environment), parties responsible for verification of the devices shall have the option of ensuring compliance with the applicable technical specifications of this chapter at each end user's location after installation, provided that the purchase or lease agreement includes a proviso that such a determination of compliance be made and is the responsibility of the party responsible for verification of the equipment.

## Certification & User's Manual Information

The following is extracted from Title 47 of the Code of Federal Regulations, Part 2, Subpart J — Equipment Authorization Procedures:

### § 2.901 Basis and Purpose

- (a) In order to carry out its responsibilities under the Communications Act and the various treaties and international regulations, and in order to promote efficient use of the radio spectrum, the Commission has developed technical standards for radio frequency equipment and parts or components thereof. The technical standards applicable to individual types of equipment are found in that part of the rules governing the service wherein the equipment is to be operated.<sup>1</sup> *In addition to the technical standards provided, the rules governing the service may require that such equipment be verified by the manufacturer or importer, be authorized under a Declaration of Conformity, or receive an equipment authorization from the Commission by one of the following procedures: certification or registration.*
- (b) The following sections describe the verification procedure, the procedure for a Declaration of Conformity, and the procedures to be followed in obtaining certification from the Commission and the conditions attendant to such a grant.

### § 2.907 Certification.

- (a) Certification is an equipment authorization issued by the Commission, based on representation and test data submitted by the applicant.
- (b) Certification attaches to all units subsequently marketed by the grantee which are identical (see Section 2.908) to the sample tested except for permissive changes or other variations authorized by the Commission pursuant to Section 2.1043.

---

<sup>1</sup> In this case, the equipment is subject to the rules of Part 15. More specifically, the equipment falls under Subpart B (of Part 15), which deals with unintentional radiators.

## Certification & User's Manual Information

### § 2.948 Description of measurement facilities.

- (a) Each party making measurements of equipment that is subject to an equipment authorization under Part 15 or Part 18 of this chapter, regardless of whether the measurements are filed with the Commission or kept on file by the party responsible for compliance of equipment marketed within the U.S. or its possessions, shall compile a description of the measurement facilities employed.
- (1) If the measured equipment is subject to the verification procedure, the description of the measurement facilities shall be retained by the party responsible for verification of the equipment.
- (i) *If the equipment is verified through measurements performed by an independent laboratory, it is acceptable for the party responsible for verification of the equipment to rely upon the description of the measurement facilities retained by or placed on file with the Commission by that laboratory. In this situation, the party responsible for the verification of the equipment is not required to retain a duplicate copy of the description of the measurement facilities.*
- (ii) If the equipment is verified based on measurements performed at the installation site of the equipment, no specific site calibration data is required. It is acceptable to retain the description of the measurement facilities at the site at which the measurements were performed.
- (2) If the equipment is to be authorized by the Commission under the certification procedure, the description of the measurement facilities shall be filed with the Commission's Laboratory in Columbia, Maryland. The data describing the measurement facilities need only be filed once but must be updated as changes are made to the measurement facilities or as otherwise described in this section. At least every three years, the organization responsible for filing the data with the Commission shall certify that the data on file is current.

## Certification & User's Manual Information

### 1. Label and User's Manual Information

The following is extracted from Title 47 of the Code of Federal Regulations, Part 15, Subpart A — General:

#### § 15.19 Labeling requirements.

(a) *In addition to the requirements in Part 2 of this chapter, a device subject to certification or verification shall be labeled as follows:*

- (1) Receivers associated with the operation of a licensed radio service, e.g., FM broadcast under Part 73 of this chapter, land mobile operation under Part 90, etc., shall bear the following statement in a conspicuous location on the device:

This device complies with Part 15 of the FCC Rules. Operation is subject to the condition that this device does not cause harmful interference.

- (2) A stand-alone cable input selector switch, shall bear the following statement in a conspicuous location on the device:

This device is verified to comply with Part 15 of the FCC Rules for use with cable television service.

- (3) All other devices shall bear the following statement in a conspicuous location on the device:

*This device complies with Part 15 of the FCC Rules. Operation is subject to the following two conditions: (1) This device may not cause harmful interference, and (2) this device must accept any interference received, including interference that may cause undesired operation.*

- (4) Where a device is constructed in two or more sections connected by wires and marketed together, the statement specified under paragraph (a) of this section is required to be affixed only to the main control unit.

- (5) When the device is so small or for such use that it is not practicable to place the statement specified under paragraph (a) of this section on it, the information required by this paragraph shall be placed in a prominent location in the instruction manual or pamphlet supplied to the user or, alternatively, shall be placed on the container in which the device is marketed. However, the FCC identifier or the unique identifier, as appropriate, must be displayed on the device.

#### § 15.21 Information to user.

The user's manual or instruction manual for an intentional or unintentional radiator shall caution the user that changes or modifications not expressly approved by the party responsible for compliance could void the user's authority to operate the equipment.

## Verification & User's Manual Information

The following is extracted from Title 47 of the Code of Federal Regulations, Part 15, Subpart B — Unintentional Radiators:

### § 15.105 Information to the user.

- (a) For a Class A digital device or peripheral, the instructions furnished the user shall include the following or similar statement, placed in a prominent location in the text of the manual:

Note: This equipment has been tested and found to comply with the limits for a Class A digital device, pursuant to Part 15 of the FCC Rules. These limits are designed to provide reasonable protection against harmful interference when the equipment is operated in a commercial environment. This equipment generates, uses, and can radiate radio frequency energy and, if not installed and used in accordance with the instruction manual, may cause harmful interference to radio communications. Operation of this equipment in a residential area is likely to cause harmful interference in which case the user will be required to correct the interference at own expense.

- (b) For a Class B digital device or peripheral, the instructions furnished the user shall include the following or similar statement, placed in a prominent location in the text of the manual:

Note: This equipment has been tested and found to comply with the limits for a Class B digital device, pursuant to Part 15 of the FCC Rules. These limits are designed to provide reasonable protection against harmful interference when the equipment is operated in a residential environment. This equipment generates, uses, and can radiate radio frequency energy and, if not installed and used in accordance with the instruction manual, may cause harmful interference to radio communications. However, there is no guarantee that interference will not occur in a particular installation. If this equipment does cause harmful interference to radio or television reception, which can be determined by turning the equipment off and on, the user is encouraged to try to correct the interference by one or more of the following measures:

- Reorient or relocate the receiving antenna.
- Increase the separation between the equipment and receiver.
- Connect the equipment into an outlet on a circuit different from that to which the receiver is connected.
- Consult the dealer or an experienced radio/TV technician for help.

# End of Report