

---

**APPENDIX D: RELEVANT PAGES FROM DAE&  
DIPOLE VALIDATION KIT REPORT(S)**



In Collaboration with  
**s p e a g**  
CALIBRATION LABORATORY



中国认可  
国际互认  
校准  
CALIBRATION  
CNAS L0570

Add: No.51 Xueyuan Road, Haidian District, Beijing, 100191, China  
Tel: +86-10-62304633-2079 Fax: +86-10-62304633-2504  
E-mail: cttl@chinattl.com http://www.chinattl.cn

Client

**SMQ**

Certificate No:

**Z20-60037**

## CALIBRATION CERTIFICATE

Object **D750V3 - SN: 1103**

Calibration Procedure(s) **FF-Z11-003-01**  
**Calibration Procedures for dipole validation kits**

Calibration date: **January 6, 2020**

This calibration Certificate documents the traceability to national standards, which realize the physical units of measurements(SI). The measurements and the uncertainties with confidence probability are given on the following pages and are part of the certificate.

All calibrations have been conducted in the closed laboratory facility: environment temperature(22±3)°C and humidity<70%.

Calibration Equipment used (M&TE critical for calibration)

Primary Standards	ID #	Cal Date(Calibrated by, Certificate No.)	Scheduled Calibration
Power Meter NRP2	106276	11-Apr-19 (CTTL, No.J19X02605)	Apr-20
Power sensor NRP6A	101369	11-Apr-19 (CTTL, No.J19X02605)	Apr-20
Reference Probe EX3DV4	SN 3617	31-Jan-19(SPEAG,No.EX3-3617_Jan19)	Jan-20
DAE4	SN 1555	22-Aug-19(CTTL-SPEAG,No.Z19-60295)	Aug-20
Secondary Standards	ID #	Cal Date(Calibrated by, Certificate No.)	Scheduled Calibration
Signal Generator E4438C	MY49071430	23-Jan-19 (CTTL, No.J19X00336)	Jan-20
NetworkAnalyzer E5071C	MY46110673	24-Jan-19 (CTTL, No.J19X00547)	Jan-20

	Name	Function
Calibrated by:	<b>Zhao Jing</b>	SAR Test Engineer
Reviewed by:	<b>Lin Hao</b>	SAR Test Engineer
Approved by:	<b>Qi Dianyuan</b>	SAR Project Leader

Signature

Issued: January 9, 2020

This calibration certificate shall not be reproduced except in full without written approval of the laboratory.



In Collaboration with  
**s p e a g**  
CALIBRATION LABORATORY

Add: No.51 Xueyuan Road, Haidian District, Beijing, 100191, China  
Tel: +86-10-62304633-2079 Fax: +86-10-62304633-2504  
E-mail: cttl@chinattl.com http://www.chinattl.cn

#### Glossary:

TSL	tissue simulating liquid
ConvF	sensitivity in TSL / NORM <sub>x,y,z</sub>
N/A	not applicable or not measured

#### Calibration is Performed According to the Following Standards:

- IEEE Std 1528-2013, "IEEE Recommended Practice for Determining the Peak Spatial-Averaged Specific Absorption Rate (SAR) in the Human Head from Wireless Communications Devices: Measurement Techniques", June 2013
- IEC 62209-1, "Measurement procedure for assessment of specific absorption rate of human exposure to radio frequency fields from hand-held and body-mounted wireless communication devices- Part 1: Device used next to the ear (Frequency range of 300MHz to 6GHz)", July 2016
- IEC 62209-2, "Procedure to measure the Specific Absorption Rate (SAR) For wireless communication devices used in close proximity to the human body (frequency range of 30MHz to 6GHz)", March 2010
- KDB865664, SAR Measurement Requirements for 100 MHz to 6 GHz

#### Additional Documentation:

- DASY4/5 System Handbook

#### Methods Applied and Interpretation of Parameters:

- Measurement Conditions:* Further details are available from the Validation Report at the end of the certificate. All figures stated in the certificate are valid at the frequency indicated.
- Antenna Parameters with TSL:* The dipole is mounted with the spacer to position its feed point exactly below the center marking of the flat phantom section, with the arms oriented parallel to the body axis.
- Feed Point Impedance and Return Loss:* These parameters are measured with the dipole positioned under the liquid filled phantom. The impedance stated is transformed from the measurement at the SMA connector to the feed point. The Return Loss ensures low reflected power. No uncertainty required.
- Electrical Delay:* One-way delay between the SMA connector and the antenna feed point. No uncertainty required.
- SAR measured:* SAR measured at the stated antenna input power.
- SAR normalized:* SAR as measured, normalized to an input power of 1 W at the antenna connector.
- SAR for nominal TSL parameters:* The measured TSL parameters are used to calculate the nominal SAR result.

The reported uncertainty of measurement is stated as the standard uncertainty of Measurement multiplied by the coverage factor  $k=2$ , which for a normal distribution corresponds to a coverage probability of approximately 95%.



In Collaboration with  
**s p e a g**  
 CALIBRATION LABORATORY

Add: No.51 Xueyuan Road, Haidian District, Beijing, 100191, China  
 Tel: +86-10-62304633-2079 Fax: +86-10-62304633-2504  
 E-mail: cttl@chinattl.com http://www.chinattl.cn

### Measurement Conditions

DASY system configuration, as far as not given on page 1.

DASY Version	DASY52	V52.10.3
Extrapolation	Advanced Extrapolation	
Phantom	Triple Flat Phantom 5.1C	
Distance Dipole Center - TSL	15 mm	with Spacer
Zoom Scan Resolution	dx, dy, dz = 5 mm	
Frequency	750 MHz ± 1 MHz	

### Head TSL parameters

The following parameters and calculations were applied.

	Temperature	Permittivity	Conductivity
Nominal Head TSL parameters	22.0 °C	41.9	0.89 mho/m
Measured Head TSL parameters	(22.0 ± 0.2) °C	41.6 ± 6 %	0.90 mho/m ± 6 %
Head TSL temperature change during test	<1.0 °C	---	---

### SAR result with Head TSL

SAR averaged over 1 cm <sup>3</sup> (1 g) of Head TSL	Condition	
SAR measured	250 mW input power	2.19 W/kg
SAR for nominal Head TSL parameters	normalized to 1W	<b>8.66 W/kg ± 18.8 % (k=2)</b>
SAR averaged over 10 cm <sup>3</sup> (10 g) of Head TSL	Condition	
SAR measured	250 mW input power	1.47 W/kg
SAR for nominal Head TSL parameters	normalized to 1W	<b>5.83 W/kg ± 18.7 % (k=2)</b>

### Body TSL parameters

The following parameters and calculations were applied.

	Temperature	Permittivity	Conductivity
Nominal Body TSL parameters	22.0 °C	55.5	0.96 mho/m
Measured Body TSL parameters	(22.0 ± 0.2) °C	55.2 ± 6 %	0.97 mho/m ± 6 %
Body TSL temperature change during test	<1.0 °C	---	---

### SAR result with Body TSL

SAR averaged over 1 cm <sup>3</sup> (1 g) of Body TSL	Condition	
SAR measured	250 mW input power	2.17 W/kg
SAR for nominal Body TSL parameters	normalized to 1W	<b>8.64 W/kg ± 18.8 % (k=2)</b>
SAR averaged over 10 cm <sup>3</sup> (10 g) of Body TSL	Condition	
SAR measured	250 mW input power	1.46 W/kg
SAR for nominal Body TSL parameters	normalized to 1W	<b>5.82 W/kg ± 18.7 % (k=2)</b>



In Collaboration with  
**s p e a g**  
CALIBRATION LABORATORY

Add: No.51 Xueyuan Road, Haidian District, Beijing, 100191, China  
Tel: +86-10-62304633-2079 Fax: +86-10-62304633-2504  
E-mail: [ctl@chinatl.com](mailto:ctl@chinatl.com) <http://www.chinatl.cn>

## Appendix (Additional assessments outside the scope of CNAS L0570)

### Antenna Parameters with Head TSL

Impedance, transformed to feed point	53.9Ω- 2.67jΩ
Return Loss	- 26.8dB

### Antenna Parameters with Body TSL

Impedance, transformed to feed point	49.5Ω- 3.86jΩ
Return Loss	- 28.6dB

### General Antenna Parameters and Design

Electrical Delay (one direction)	0.896 ns
----------------------------------	----------

After long term use with 100W radiated power, only a slight warming of the dipole near the feedpoint can be measured.

The dipole is made of standard semirigid coaxial cable. The center conductor of the feeding line is directly connected to the second arm of the dipole. The antenna is therefore short-circuited for DC-signals. On some of the dipoles, small end caps are added to the dipole arms in order to improve matching when loaded according to the position as explained in the "Measurement Conditions" paragraph. The SAR data are not affected by this change. The overall dipole length is still according to the Standard. No excessive force must be applied to the dipole arms, because they might bend or the soldered connections near the feedpoint may be damaged.

### Additional EUT Data

Manufactured by	SPEAG
-----------------	-------



In Collaboration with  
**s p e a g**  
CALIBRATION LABORATORY

Add: No.51 Xueyuan Road, Haidian District, Beijing, 100191, China  
Tel: +86-10-62304633-2079 Fax: +86-10-62304633-2504  
E-mail: cttl@chinattl.com http://www.chinattl.cn

**DASY5 Validation Report for Head TSL**

Date: 01.06.2020

Test Laboratory: CTTL, Beijing, China

**DUT: Dipole 750 MHz; Type: D750V3; Serial: D750V3 - SN: 1103**

Communication System: UID 0, CW; Frequency: 750 MHz; Duty Cycle: 1:1

Medium parameters used:  $f = 750$  MHz;  $\sigma = 0.902$  S/m;  $\epsilon_r = 41.63$ ;  $\rho = 1000$  kg/m<sup>3</sup>

Phantom section: Right Section

DASY5 Configuration:

- Probe: EX3DV4 - SN3617; ConvF(10.03, 10.03, 10.03) @ 750 MHz; Calibrated: 1/31/2019
- Sensor-Surface: 1.4mm (Mechanical Surface Detection)
- Electronics: DAE4 Sn1555; Calibrated: 8/22/2019
- Phantom: MFP\_V5.1C ; Type: QD 000 P51CA; Serial: 1062
- Measurement SW: DASY52, Version 52.10 (3); SEMCAD X Version 14.6.13 (7474)

**Dipole Calibration/Zoom Scan (7x7x7) (7x7x7)/Cube 0:** Measurement grid: dx=5mm, dy=5mm, dz=5mm

Reference Value = 57.43 V/m; Power Drift = 0.03 dB

Peak SAR (extrapolated) = 3.16 W/kg

**SAR(1 g) = 2.19 W/kg; SAR(10 g) = 1.47 W/kg**

Smallest distance from peaks to all points 3 dB below = 23.3 mm

Ratio of SAR at M2 to SAR at M1 = 69.4%

Maximum value of SAR (measured) = 2.85 W/kg

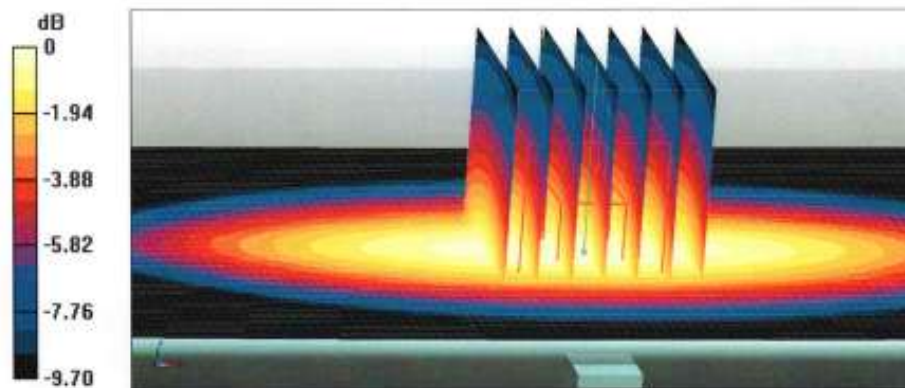

0 dB = 2.85 W/kg = 4.55 dBW/kg



In Collaboration with  
**s p e a g**  
CALIBRATION LABORATORY

Add: No.51 Xueyuan Road, Haidian District, Beijing, 100191, China  
Tel: +86-10-62304633-2079 Fax: +86-10-62304633-2504  
E-mail: cttl@chinattl.com http://www.chinattl.cn

### Impedance Measurement Plot for Head TSL

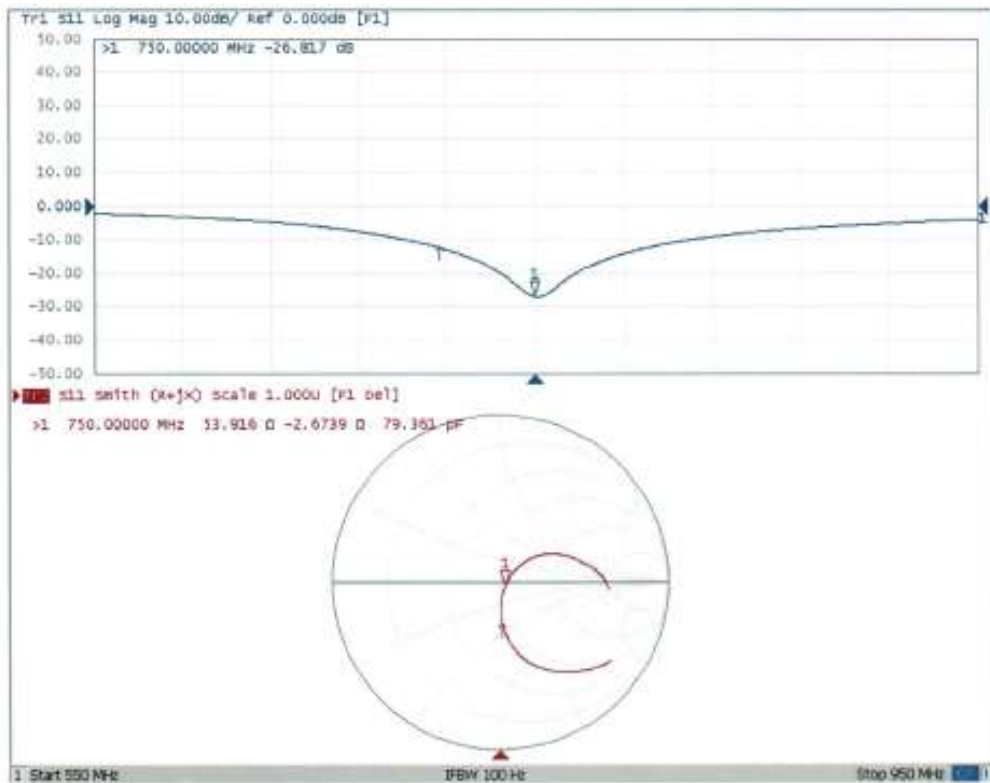



In Collaboration with  
**s p e a g**  
CALIBRATION LABORATORY

Add: No.51 Xueyuan Road, Haidian District, Beijing, 100191, China  
Tel: +86-10-62304633-2079 Fax: +86-10-62304633-2504  
E-mail: ctfl@chinatl.com http://www.chinatl.cn

**DASY5 Validation Report for Body TSL**

Date: 01.03.2020

Test Laboratory: CTTL, Beijing, China

**DUT: Dipole 750 MHz; Type: D750V3; Serial: D750V3 - SN: 1103**

Communication System: UID 0, CW; Frequency: 750 MHz; Duty Cycle: 1:1

Medium parameters used:  $f = 750$  MHz;  $\sigma = 0.965$  S/m;  $\epsilon_r = 55.21$ ;  $\rho = 1000$  kg/m<sup>3</sup>

Phantom section: Center Section

DASY5 Configuration:

- Probe: EX3DV4 - SN3617; ConvF(9.85, 9.85, 9.85) @ 750 MHz; Calibrated: 1/31/2019
- Sensor-Surface: 1.4mm (Mechanical Surface Detection)
- Electronics: DAE4 Sn1555; Calibrated: 8/22/2019
- Phantom: MFP\_V5.1C ; Type: QD 000 P51CA; Serial: 1062
- Measurement SW: DASY52, Version 52.10 (3); SEMCAD X Version 14.6.13 (7474)

**Dipole Calibration/Zoom Scan (7x7x7) (7x7x7)/Cube 0:** Measurement grid: dx=5mm, dy=5mm, dz=5mm

Reference Value = 49.46 V/m; Power Drift = 0.08 dB

Peak SAR (extrapolated) = 3.20 W/kg

**SAR(1 g) = 2.17 W/kg; SAR(10 g) = 1.46 W/kg**

Smallest distance from peaks to all points 3 dB below = 19.2 mm

Ratio of SAR at M2 to SAR at M1 = 68.3%

Maximum value of SAR (measured) = 2.86 W/kg

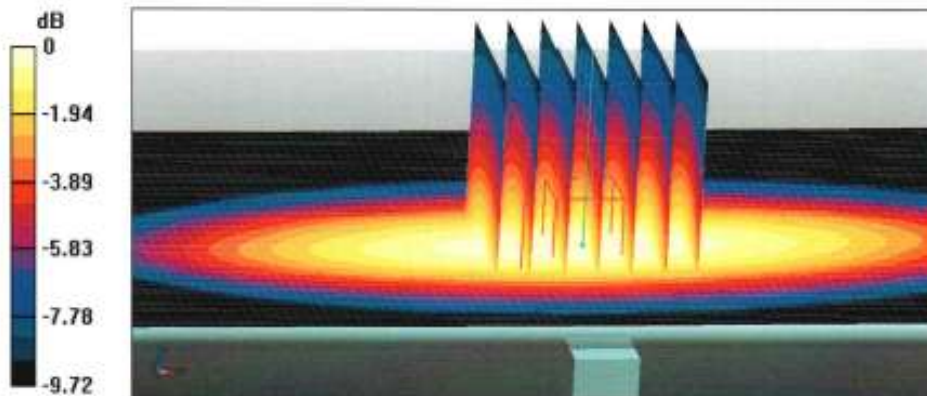

0 dB = 2.86 W/kg = 4.56 dBW/kg





In Collaboration with  
**s p e a g**  
CALIBRATION LABORATORY

Add: No.51 Xueyuan Road, Haidian District, Beijing, 100191, China  
Tel: +86-10-62304633-2079 Fax: +86-10-62304633-2504  
E-mail: cttl@chinattl.com http://www.chinattl.cn

### Impedance Measurement Plot for Body TSL

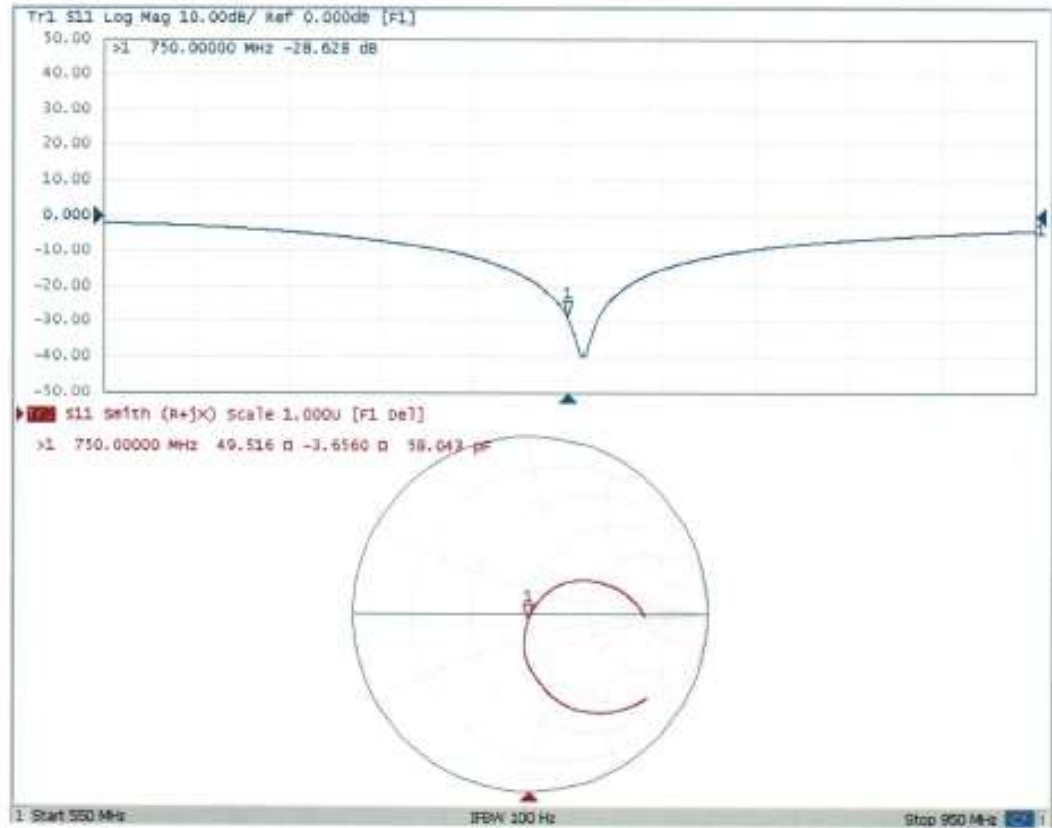



In Collaboration with  
**s p e a g**  
CALIBRATION LABORATORY



中国认可  
国际互认  
校准  
CALIBRATION  
CNAS L0570

Add: No.51 Xueyuan Road, Haidian District, Beijing, 100191, China  
Tel: +86-10-62304633-2079 Fax: +86-10-62304633-2504  
E-mail: cttl@chinattl.com http://www.chinattl.cn

Client **SMQ**

Certificate No: **Z18-60333**

## CALIBRATION CERTIFICATE

Object **D835V2 - SN: 4d141**

Calibration Procedure(s) **FF-Z11-003-01**  
**Calibration Procedures for dipole validation kits**

Calibration date: **September 6, 2018**

This calibration Certificate documents the traceability to national standards, which realize the physical units of measurements(SI). The measurements and the uncertainties with confidence probability are given on the following pages and are part of the certificate.

All calibrations have been conducted in the closed laboratory facility: environment temperature(22±3)°C and humidity<70%.

Calibration Equipment used (M&TE critical for calibration)

Primary Standards	ID #	Cal Date(Calibrated by, Certificate No.)	Scheduled Calibration
Power Meter NRVD	102083	01-Nov-17 (CTTL, No.J17X08756)	Oct-18
Power sensor NRV-Z5	100542	01-Nov-17 (CTTL, No.J17X08756)	Oct-18
Reference Probe EX3DV4	SN 7464	12-Sep-17(SPEAG,No.EX3-7464_Sep17)	Sep-18
DAE4	SN 1524	13-Sep-17(SPEAG,No.DAE4-1524_Sep17)	Sep-18
Secondary Standards	ID #	Cal Date(Calibrated by, Certificate No.)	Scheduled Calibration
Signal Generator E4438C	MY49071430	23-Jan-18 (CTTL, No.J18X00560)	Jan-19
NetworkAnalyzer E5071C	MY46110673	24-Jan-18 (CTTL, No.J18X00561)	Jan-19

	Name	Function	Signature
Calibrated by:	Zhao Jing	SAR Test Engineer	
Reviewed by:	Lin Hao	SAR Test Engineer	
Approved by:	Qi Dianyuan	SAR Project Leader	

Issued: September 9, 2018

This calibration certificate shall not be reproduced except in full without written approval of the laboratory.



In Collaboration with  
**s p e a g**  
CALIBRATION LABORATORY

Add: No.51 Xueyuan Road, Haidian District, Beijing, 100191, China  
Tel: +86-10-62304633-2079 Fax: +86-10-62304633-2504  
E-mail: cttf@chinatl.com http://www.chinatl.cn

**Glossary:**

TSL	tissue simulating liquid
ConvF	sensitivity in TSL / NORM <sub>x,y,z</sub>
N/A	not applicable or not measured

**Calibration is Performed According to the Following Standards:**

- IEEE Std 1528-2013, "IEEE Recommended Practice for Determining the Peak Spatial-Averaged Specific Absorption Rate (SAR) in the Human Head from Wireless Communications Devices: Measurement Techniques", June 2013
- IEC 62209-1, "Measurement procedure for assessment of specific absorption rate of human exposure to radio frequency fields from hand-held and body-mounted wireless communication devices- Part 1: Device used next to the ear (Frequency range of 300MHz to 6GHz)", July 2016
- IEC 62209-2, "Procedure to measure the Specific Absorption Rate (SAR) For wireless communication devices used in close proximity to the human body (frequency range of 30MHz to 6GHz)", March 2010
- KDB865664, SAR Measurement Requirements for 100 MHz to 6 GHz

**Additional Documentation:**

- DASY4/5 System Handbook

**Methods Applied and Interpretation of Parameters:**

- Measurement Conditions:** Further details are available from the Validation Report at the end of the certificate. All figures stated in the certificate are valid at the frequency indicated.
- Antenna Parameters with TSL:** The dipole is mounted with the spacer to position its feed point exactly below the center marking of the flat phantom section, with the arms oriented parallel to the body axis.
- Feed Point Impedance and Return Loss:** These parameters are measured with the dipole positioned under the liquid filled phantom. The impedance stated is transformed from the measurement at the SMA connector to the feed point. The Return Loss ensures low reflected power. No uncertainty required.
- Electrical Delay:** One-way delay between the SMA connector and the antenna feed point. No uncertainty required.
- SAR measured:** SAR measured at the stated antenna input power.
- SAR normalized:** SAR as measured, normalized to an input power of 1 W at the antenna connector.
- SAR for nominal TSL parameters:** The measured TSL parameters are used to calculate the nominal SAR result.

The reported uncertainty of measurement is stated as the standard uncertainty of Measurement multiplied by the coverage factor  $k=2$ , which for a normal distribution Corresponds to a coverage probability of approximately 95%.



In Collaboration with  
**s p e a g**  
CALIBRATION LABORATORY

Add: No.51 Xueyuan Road, Haidian District, Beijing, 100191, China  
Tel: +86-10-62304633-2079 Fax: +86-10-62304633-2504  
E-mail: cttl@chinattl.com http://www.chinattl.cn

### Measurement Conditions

DASY system configuration, as far as not given on page 1.

DASY Version	DASY52	52.10.1.1476
Extrapolation	Advanced Extrapolation	
Phantom	Triple Flat Phantom 5.1C	
Distance Dipole Center - TSL	15 mm	with Spacer
Zoom Scan Resolution	dx, dy, dz = 5 mm	
Frequency	835 MHz $\pm$ 1 MHz	

### Head TSL parameters

The following parameters and calculations were applied.

	Temperature	Permittivity	Conductivity
Nominal Head TSL parameters	22.0 °C	41.5	0.90 mho/m
Measured Head TSL parameters	(22.0 $\pm$ 0.2) °C	42.7 $\pm$ 6 %	0.90 mho/m $\pm$ 6 %
Head TSL temperature change during test	<1.0 °C	----	----

### SAR result with Head TSL

SAR averaged over 1 cm <sup>3</sup> (1 g) of Head TSL	Condition	
SAR measured	250 mW input power	2.32 mW / g
SAR for nominal Head TSL parameters	normalized to 1W	9.31 mW / g $\pm$ 18.8 % (k=2)
SAR averaged over 10 cm <sup>3</sup> (10 g) of Head TSL	Condition	
SAR measured	250 mW input power	1.53 mW / g
SAR for nominal Head TSL parameters	normalized to 1W	6.13 mW / g $\pm$ 18.7 % (k=2)

### Body TSL parameters

The following parameters and calculations were applied.

	Temperature	Permittivity	Conductivity
Nominal Body TSL parameters	22.0 °C	55.2	0.97 mho/m
Measured Body TSL parameters	(22.0 $\pm$ 0.2) °C	56.0 $\pm$ 6 %	1.00 mho/m $\pm$ 6 %
Body TSL temperature change during test	<1.0 °C	----	----

### SAR result with Body TSL

SAR averaged over 1 cm <sup>3</sup> (1 g) of Body TSL	Condition	
SAR measured	250 mW input power	2.48 mW / g
SAR for nominal Body TSL parameters	normalized to 1W	9.74 mW / g $\pm$ 18.8 % (k=2)
SAR averaged over 10 cm <sup>3</sup> (10 g) of Body TSL	Condition	
SAR measured	250 mW input power	1.66 mW / g
SAR for nominal Body TSL parameters	normalized to 1W	6.54 mW / g $\pm$ 18.7 % (k=2)



In Collaboration with  
**s p e a g**  
CALIBRATION LABORATORY

Add: No.51 Xueyuan Road, Haidian District, Beijing, 100191, China  
Tel: +86-10-62304633-2079 Fax: +86-10-62304633-2504  
E-mail: ettl@chinattl.com http://www.chinattl.cn

#### Appendix (Additional assessments outside the scope of CNAS L0570)

##### Antenna Parameters with Head TSL

Impedance, transformed to feed point	50.3 $\Omega$ - 5.88j $\Omega$
Return Loss	- 24.9dB

##### Antenna Parameters with Body TSL

Impedance, transformed to feed point	46.8 $\Omega$ - 7.52j $\Omega$
Return Loss	- 21.5dB

##### General Antenna Parameters and Design

Electrical Delay (one direction)	1.255 ns
----------------------------------	----------

After long term use with 100W radiated power, only a slight warming of the dipole near the feedpoint can be measured.

The dipole is made of standard semirigid coaxial cable. The center conductor of the feeding line is directly connected to the second arm of the dipole. The antenna is therefore short-circuited for DC-signals. On some of the dipoles, small end caps are added to the dipole arms in order to improve matching when loaded according to the position as explained in the "Measurement Conditions" paragraph. The SAR data are not affected by this change. The overall dipole length is still according to the Standard. No excessive force must be applied to the dipole arms, because they might bend or the soldered connections near the feedpoint may be damaged.

##### Additional EUT Data

Manufactured by	SPEAG
-----------------	-------



In Collaboration with  
**s p e a g**  
CALIBRATION LABORATORY

Add: No.51 Xueyuan Road, Haidian District, Beijing, 100191, China  
Tel: +86-10-62304633-2079 Fax: +86-10-62304633-2504  
E-mail: cttl@chinattl.com http://www.chinattl.cn

**DASY5 Validation Report for Head TSL**

Date: 09.04.2018

Test Laboratory: CTTL, Beijing, China

**DUT: Dipole 835 MHz; Type: D835V2; Serial: D835V2 - SN: 4d141**

Communication System: UID 0, CW; Frequency: 835 MHz; Duty Cycle: 1:1

Medium parameters used:  $f = 835$  MHz;  $\sigma = 0.904$  S/m;  $\epsilon_r = 42.71$ ;  $\rho = 1000$  kg/m<sup>3</sup>

Phantom section: Right Section

DASY5 Configuration:

- Probc: EX3DV4 - SN7464; ConvF(10.28, 10.28, 10.28) @ 835 MHz; Calibrated: 9/12/2017
- Sensor-Surface: 1.4mm (Mechanical Surface Detection)
- Electronics: DAE4 Sn1524; Calibrated: 9/13/2017
- Phantom: MFP\_V5.1C ; Type: QD 000 P51CA; Serial: 1062
- Measurement SW: DASY52, Version 52.10 (1); SEMCAD X Version 14.6.11 (7439)

**Dipole Calibration/Zoom Scan (7x7x7) (7x7x7)/Cube 0: Measurement grid: dx=5mm, dy=5mm, dz=5mm**

Reference Value = 57.01 V/m; Power Drift = -0.08 dB

Peak SAR (extrapolated) = 3.49 W/kg

**SAR(1 g) = 2.32 W/kg; SAR(10 g) = 1.53 W/kg**

Maximum value of SAR (measured) = 3.10 W/kg

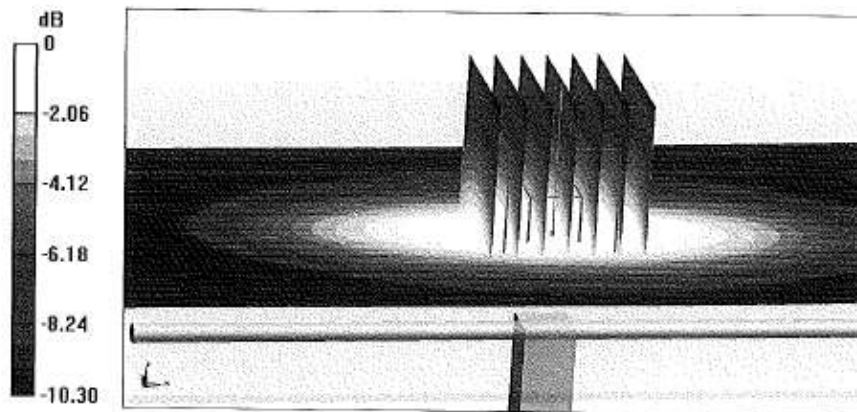

0 dB = 3.10 W/kg = 4.91 dBW/kg



In Collaboration with  
**s p e a g**  
CALIBRATION LABORATORY

Add: No.51 Xueyuan Road, Haidian District, Beijing, 100191, China  
Tel: +86-10-62304633-2079 Fax: +86-10-62304633-2504  
E-mail: cttl@chinattl.com http://www.chinattl.cn

### Impedance Measurement Plot for Head TSL

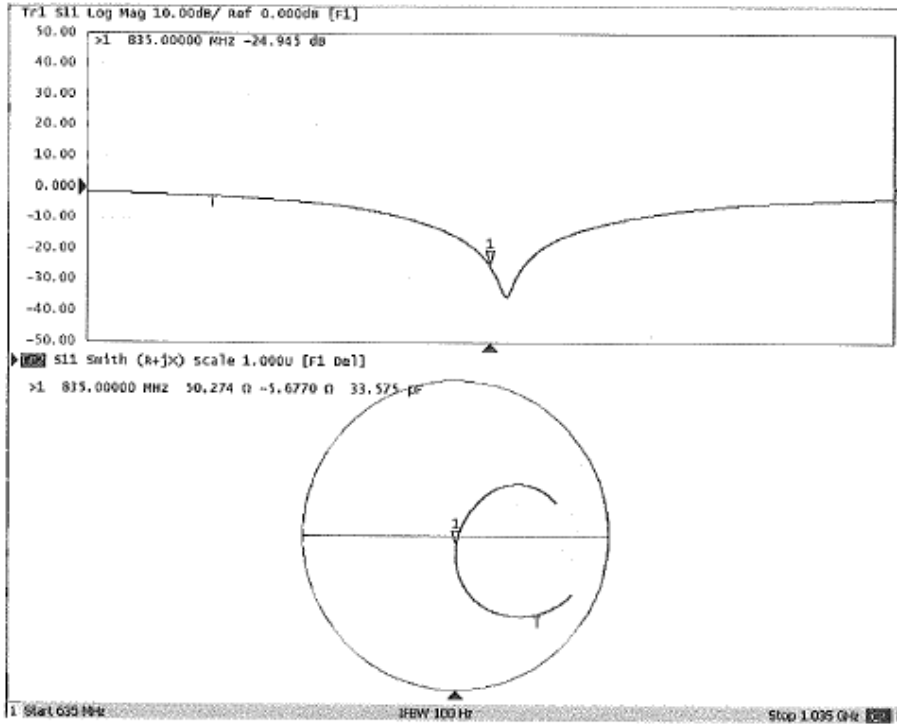



In Collaboration with  
**s p e a g**  
CALIBRATION LABORATORY

Add: No.51 Xueyuan Road, Haidian District, Beijing, 100191, China  
Tel: +86-10-62304633-2079 Fax: +86-10-62304633-2504  
E-mail: cttl@chinaattl.com http://www.chinaattl.cn

**DASY5 Validation Report for Body TSL**

Date: 09.06.2018

Test Laboratory: CTTL, Beijing, China

**DUT: Dipole 835 MHz; Type: D835V2; Serial: D835V2 - SN: 4d141**

Communication System: UID 0, CW; Frequency: 835 MHz; Duty Cycle: 1:1

Medium parameters used:  $f = 835$  MHz;  $\sigma = 0.998$  S/m;  $\epsilon_r = 56.04$ ;  $\rho = 1000$  kg/m<sup>3</sup>

Phantom section: Center Section

DASY5 Configuration:

- Probe: EX3DV4 - SN7464; ConvF(10.21, 10.21, 10.21) @ 835 MHz; Calibrated: 9/12/2017
- Sensor-Surface: 1.4mm (Mechanical Surface Detection)
- Electronics: DAE4 Sn1524; Calibrated: 9/13/2017
- Phantom: MFP\_V5.1C ; Type: QD 000 P51CA; Serial: 1062
- Measurement SW: DASY52, Version 52.10 (1); SEMCAD X Version 14.6.11 (7439)

**Dipole Calibration/Zoom Scan (7x7x7) (7x7x7)/Cube 0:** Measurement grid: dx=5mm, dy=5mm, dz=5mm

Reference Value = 55.80 V/m; Power Drift = -0.00 dB

Peak SAR (extrapolated) = 3.73 W/kg

**SAR(1 g) = 2.48 W/kg; SAR(10 g) = 1.66 W/kg**

Maximum value of SAR (measured) = 3.27 W/kg

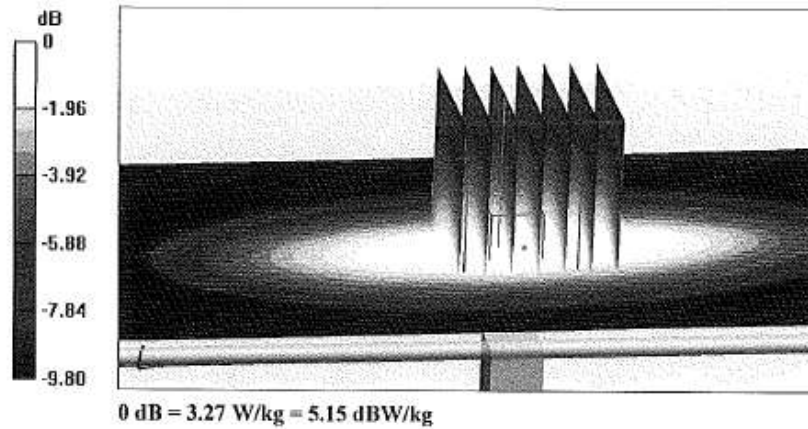





In Collaboration with  
**s p e a g**  
CALIBRATION LABORATORY

Add: No.51 Xueyuan Road, Haidian District, Beijing, 100191, China  
Tel: +86-10-62304633-2079 Fax: +86-10-62304633-2504  
E-mail: [cttl@chinattl.com](mailto:cttl@chinattl.com) <http://www.chinattl.cn>

### Impedance Measurement Plot for Body TSL

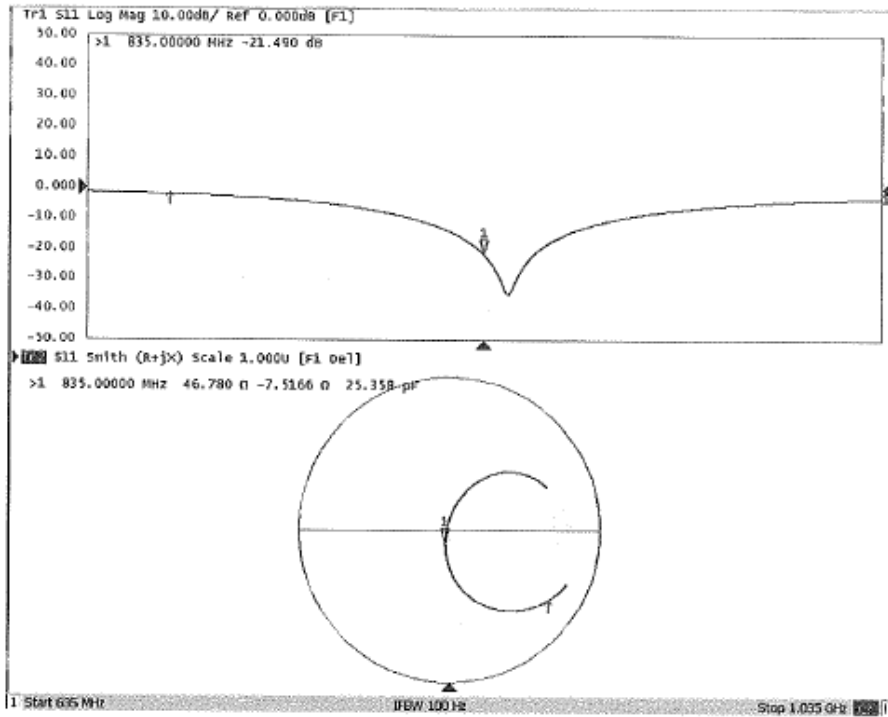



In Collaboration with  
**s p e a g**  
 CALIBRATION LABORATORY



中国认可  
 国际互认  
 校准  
 CALIBRATION  
 CNAS L0570

Add: No.51 Xueyuan Road, Haidian District, Beijing, 100191, China  
 Tel: +86-10-62304633-2079 Fax: +86-10-62304633-2504  
 E-mail: cttl@chinattl.com http://www.chinattl.cn

Client

**SMQ**

Certificate No: **Z18-60334**

## CALIBRATION CERTIFICATE

Object **D900V2 - SN:1d077**

Calibration Procedure(s) **FF-Z11-003-01**  
 Calibration Procedures for dipole validation kits

Calibration date: **September 7, 2018**

This calibration Certificate documents the traceability to national standards, which realize the physical units of measurements(SI). The measurements and the uncertainties with confidence probability are given on the following pages and are part of the certificate.

All calibrations have been conducted in the closed laboratory facility: environment temperature(22±3)°C and humidity<70%.

Calibration Equipment used (M&TE critical for calibration)

Primary Standards	ID #	Cal Date(Calibrated by, Certificate No.)	Scheduled Calibration
Power Meter NRVD	102083	01-Nov-17 (CTTL, No.J17X08756)	Oct-18
Power sensor NRV-Z5	100542	01-Nov-17 (CTTL, No.J17X08756)	Oct-18
Reference Probe EX3DV4	SN 7464	12-Sep-17(SPEAG,No.EX3-7464_Sep17)	Sep-18
DAE4	SN 1524	13-Sep-17(SPEAG,No.DAE4-1524_Sep17)	Sep-18
Secondary Standards	ID #	Cal Date(Calibrated by, Certificate No.)	Scheduled Calibration
Signal Generator E4438C	MY49071430	23-Jan-18 (CTTL, No.J18X00560)	Jan-19
NetworkAnalyzer E5071C	MY46110673	24-Jan-18 (CTTL, No.J18X00561)	Jan-19

	Name	Function	Signature
Calibrated by:	Zhao Jing	SAR Test Engineer	
Reviewed by:	Lin Hao	SAR Test Engineer	
Approved by:	Qi Dianyuan	SAR Project Leader	

Issued: September 10, 2018

This calibration certificate shall not be reproduced except in full without written approval of the laboratory.



In Collaboration with  
**s p e a g**  
CALIBRATION LABORATORY

Add: No.51 Xueyuan Road, Haidian District, Beijing, 100191, China  
Tel: +86-10-62304633-2079 Fax: +86-10-62304633-2504  
E-mail: cttl@chinattl.com http://www.chinattl.cn

**Glossary:**

TSL	tissue simulating liquid
ConvF	sensitivity in TSL / NORM <sub>x,y,z</sub>
N/A	not applicable or not measured

**Calibration is Performed According to the Following Standards:**

- a) IEEE Std 1528-2013, "IEEE Recommended Practice for Determining the Peak Spatial-Averaged Specific Absorption Rate (SAR) in the Human Head from Wireless Communications Devices: Measurement Techniques", June 2013
- b) IEC 62209-1, "Measurement procedure for assessment of specific absorption rate of human exposure to radio frequency fields from hand-held and body-mounted wireless communication devices- Part 1: Device used next to the ear (Frequency range of 300MHz to 6GHz)", July 2016
- c) IEC 62209-2, "Procedure to measure the Specific Absorption Rate (SAR) For wireless communication devices used in close proximity to the human body (frequency range of 30MHz to 6GHz)", March 2010
- d) KDB865664, SAR Measurement Requirements for 100 MHz to 6 GHz

**Additional Documentation:**

- e) DASY4/5 System Handbook

**Methods Applied and Interpretation of Parameters:**

- *Measurement Conditions:* Further details are available from the Validation Report at the end of the certificate. All figures stated in the certificate are valid at the frequency indicated.
- *Antenna Parameters with TSL:* The dipole is mounted with the spacer to position its feed point exactly below the center marking of the flat phantom section, with the arms oriented parallel to the body axis.
- *Feed Point Impedance and Return Loss:* These parameters are measured with the dipole positioned under the liquid filled phantom. The impedance stated is transformed from the measurement at the SMA connector to the feed point. The Return Loss ensures low reflected power. No uncertainty required.
- *Electrical Delay:* One-way delay between the SMA connector and the antenna feed point. No uncertainty required.
- *SAR measured:* SAR measured at the stated antenna input power.
- *SAR normalized:* SAR as measured, normalized to an input power of 1 W at the antenna connector.
- *SAR for nominal TSL parameters:* The measured TSL parameters are used to calculate the nominal SAR result.

The reported uncertainty of measurement is stated as the standard uncertainty of Measurement multiplied by the coverage factor  $k=2$ , which for a normal distribution Corresponds to a coverage probability of approximately 95%.



In Collaboration with  
**s p e a g**  
 CALIBRATION LABORATORY

Add: No.51 Xueyuan Road, Haidian District, Beijing, 100191, China  
 Tel: +86-10-62304633-2079 Fax: +86-10-62304633-2504  
 E-mail: cttl@chinattl.com http://www.chinattl.cn

### Measurement Conditions

DASY system configuration, as far as not given on page 1.

DASY Version	DASY52	52.10.1.1446
Extrapolation	Advanced Extrapolation	
Phantom	Triple Flat Phantom 5.1C	
Distance Dipole Center - TSL	15 mm	with Spacer
Zoom Scan Resolution	dx, dy, dz = 5 mm	
Frequency	900 MHz $\pm$ 1 MHz	

### Head TSL parameters

The following parameters and calculations were applied.

	Temperature	Permittivity	Conductivity
Nominal Head TSL parameters	22.0 °C	41.5	0.97 mho/m
Measured Head TSL parameters	(22.0 $\pm$ 0.2) °C	42.7 $\pm$ 6 %	0.97 mho/m $\pm$ 6 %
Head TSL temperature change during test	<1.0 °C	----	----

### SAR result with Head TSL

SAR averaged over 1 cm <sup>3</sup> (1 g) of Head TSL	Condition	
SAR measured	250 mW input power	2.69 mW / g
SAR for nominal Head TSL parameters	normalized to 1W	10.9 mW /g $\pm$ 18.8 % (k=2)
SAR averaged over 10 cm <sup>3</sup> (10 g) of Head TSL	Condition	
SAR measured	250 mW input power	1.74 mW / g
SAR for nominal Head TSL parameters	normalized to 1W	7.01 mW /g $\pm$ 18.7 % (k=2)

### Body TSL parameters

The following parameters and calculations were applied.

	Temperature	Permittivity	Conductivity
Nominal Body TSL parameters	22.0 °C	55.0	1.05 mho/m
Measured Body TSL parameters	(22.0 $\pm$ 0.2) °C	55.5 $\pm$ 6 %	1.07 mho/m $\pm$ 6 %
Body TSL temperature change during test	<1.0 °C	----	----

### SAR result with Body TSL

SAR averaged over 1 cm <sup>3</sup> (1 g) of Body TSL	Condition	
SAR measured	250 mW input power	2.85 mW / g
SAR for nominal Body TSL parameters	normalized to 1W	11.3 mW /g $\pm$ 18.8 % (k=2)
SAR averaged over 10 cm <sup>3</sup> (10 g) of Body TSL	Condition	
SAR measured	250 mW input power	1.87 mW / g
SAR for nominal Body TSL parameters	normalized to 1W	7.40 mW /g $\pm$ 18.7 % (k=2)



In Collaboration with  
**s p e a g**  
CALIBRATION LABORATORY

Add: No.51 Xueyuan Road, Haidian District, Beijing, 100191, China  
Tel: +86-10-62304633-2079 Fax: +86-10-62304633-2504  
E-mail: cttl@chinattl.com http://www.chinattl.cn

## Appendix (Additional assessments outside the scope of CNAS L0570)

### Antenna Parameters with Head TSL

Impedance, transformed to feed point	48.6 $\Omega$ - 5.66j $\Omega$
Return Loss	- 24.8dB

### Antenna Parameters with Body TSL

Impedance, transformed to feed point	45.5 $\Omega$ - 7.00j $\Omega$
Return Loss	- 21.2dB

### General Antenna Parameters and Design

Electrical Delay (one direction)	1.274 ns
----------------------------------	----------

After long term use with 100W radiated power, only a slight warming of the dipole near the feedpoint can be measured.

The dipole is made of standard semirigid coaxial cable. The center conductor of the feeding line is directly connected to the second arm of the dipole. The antenna is therefore short-circuited for DC-signals. On some of the dipoles, small end caps are added to the dipole arms in order to improve matching when loaded according to the position as explained in the "Measurement Conditions" paragraph. The SAR data are not affected by this change. The overall dipole length is still according to the Standard. No excessive force must be applied to the dipole arms, because they might bend or the soldered connections near the feedpoint may be damaged.

### Additional EUT Data

Manufactured by	SPEAG
-----------------	-------



In Collaboration with  
**s p e a g**  
CALIBRATION LABORATORY

Add: No.51 Xueyuan Road, Haidian District, Beijing, 100191, China  
Tel: +86-10-62304633-2079 Fax: +86-10-62304633-2504  
E-mail: cttl@chinattl.com http://www.chinattl.cn

**DASY5 Validation Report for Head TSL**

Date: 09.07.2018

Test Laboratory: CTTL, Beijing, China

**DUT: Dipole 900 MHz; Type: D900V2; Serial: D900V2 - SN: 1d077**

Communication System: UID 0, CW; Frequency: 900 MHz; Duty Cycle: 1:1

Medium parameters used:  $f = 900$  MHz;  $\sigma = 0.966$  S/m;  $\epsilon_r = 42.67$ ;  $\rho = 1000$  kg/m<sup>3</sup>

Phantom section: Right Section

DASY5 Configuration:

- Probe: EX3DV4 - SN7464; ConvF(10.03, 10.03, 10.03) @ 900 MHz; Calibrated: 9/12/2017
- Sensor-Surface: 1.4mm (Mechanical Surface Detection)
- Electronics: DAE4 Sn1524; Calibrated: 9/13/2017
- Phantom: MFP\_V5.1C ; Type: QD 000 P51CA; Serial: 1062
- Measurement SW: DASY52, Version 52.10 (1); SEMCAD X Version 14.6.11 (7439)

**Dipole Calibration/Zoom Scan (7x7x7) (7x7x7)/Cube 0: Measurement grid: dx=5mm, dy=5mm, dz=5mm**

Reference Value = 59.93 V/m; Power Drift = -0.07 dB

Peak SAR (extrapolated) = 4.14 W/kg

**SAR(1 g) = 2.69 W/kg; SAR(10 g) = 1.74 W/kg**

Maximum value of SAR (measured) = 3.65 W/kg

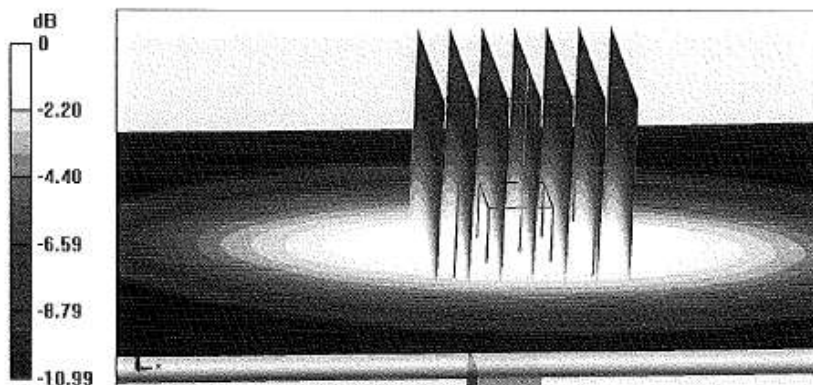



In Collaboration with  
**s p e a g**  
CALIBRATION LABORATORY

Add: No.51 Xueyuan Road, Haidian District, Beijing, 100191, China  
Tel: +86-10-62304633-2079 Fax: +86-10-62304633-2504  
E-mail: cttl@chinattl.com http://www.chinattl.cn

### Impedance Measurement Plot for Head TSL

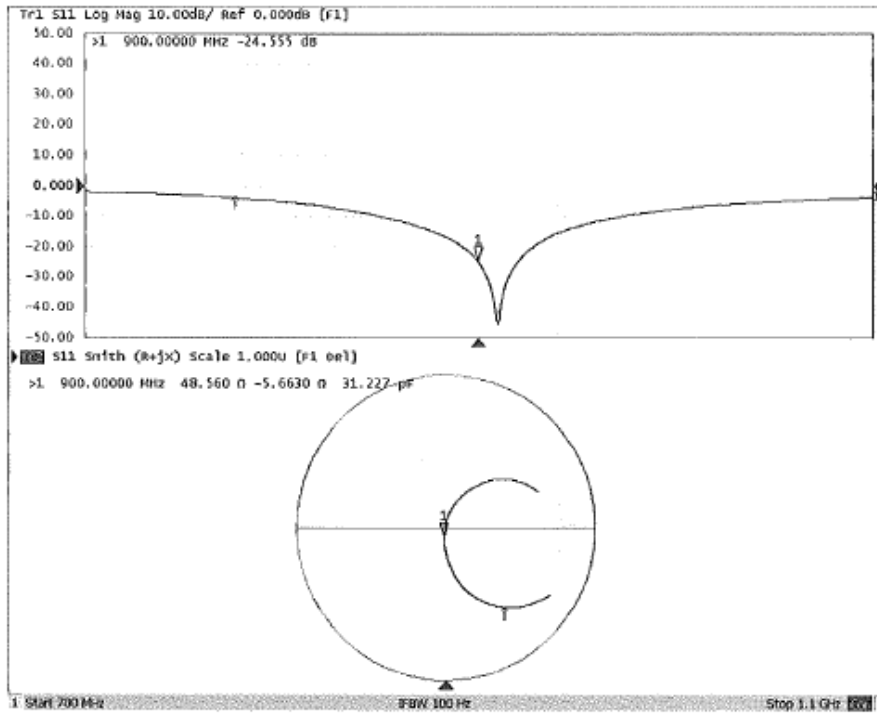



In Collaboration with  
**s p e a g**  
CALIBRATION LABORATORY

Add: No.51 Xueyuan Road, Haidian District, Beijing, 100191, China  
Tel: +86-10-62304633-2079 Fax: +86-10-62304633-2504  
E-mail: ctll@chinattl.com http://www.chinattl.cn

**DASY5 Validation Report for Body TSL**

Date: 09.06.2018

Test Laboratory: CTTL, Beijing, China

**DUT: Dipole 900 MHz; Type: D900V2; Serial: D900V2 - SN: 1d077**

Communication System: UID 0, CW; Frequency: 900 MHz; Duty Cycle: 1:1

Medium parameters used:  $f = 900$  MHz;  $\sigma = 1.071$  S/m;  $\epsilon_r = 55.51$ ;  $\rho = 1000$  kg/m<sup>3</sup>

Phantom section: Left Section

DASY5 Configuration:

- Probe: EX3DV4 - SN7464; ConvF(10.17, 10.17, 10.17) @ 900 MHz; Calibrated: 9/12/2017
- Sensor-Surface: 1.4mm (Mechanical Surface Detection)
- Electronics: DAE4 Sn1524; Calibrated: 9/13/2017
- Phantom: MFP\_V5.1C ; Type: QD 000 P51CA; Serial: 1062
- Measurement SW: DASY52, Version 52.10 (1); SEMCAD X Version 14.6.11 (7439)

**Dipole Calibration/Zoom Scan (7x7x7) (7x7x7)/Cube 0:** Measurement grid: dx=5mm, dy=5mm, dz=5mm

Reference Value = 58.25 V/m; Power Drift = -0.04 dB

Peak SAR (extrapolated) = 4.35 W/kg

**SAR(1 g) = 2.85 W/kg; SAR(10 g) = 1.87 W/kg**

Maximum value of SAR (measured) = 3.82 W/kg

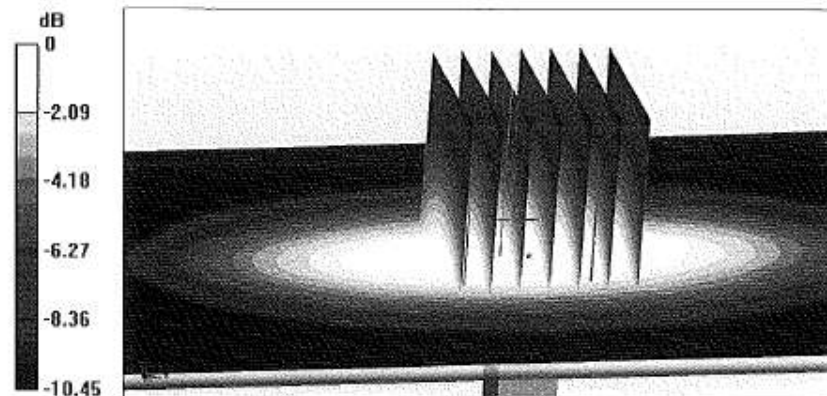

0 dB = 3.82 W/kg = 5.82 dBW/kg





In Collaboration with  
**s p e a g**  
CALIBRATION LABORATORY

Add: No.51 Xueyuan Road, Haidian District, Beijing, 100191, China  
Tel: +86-10-62304633-2079 Fax: +86-10-62304633-2504  
E-mail: cttl@chinattl.com http://www.chinattl.cn

### Impedance Measurement Plot for Body TSL

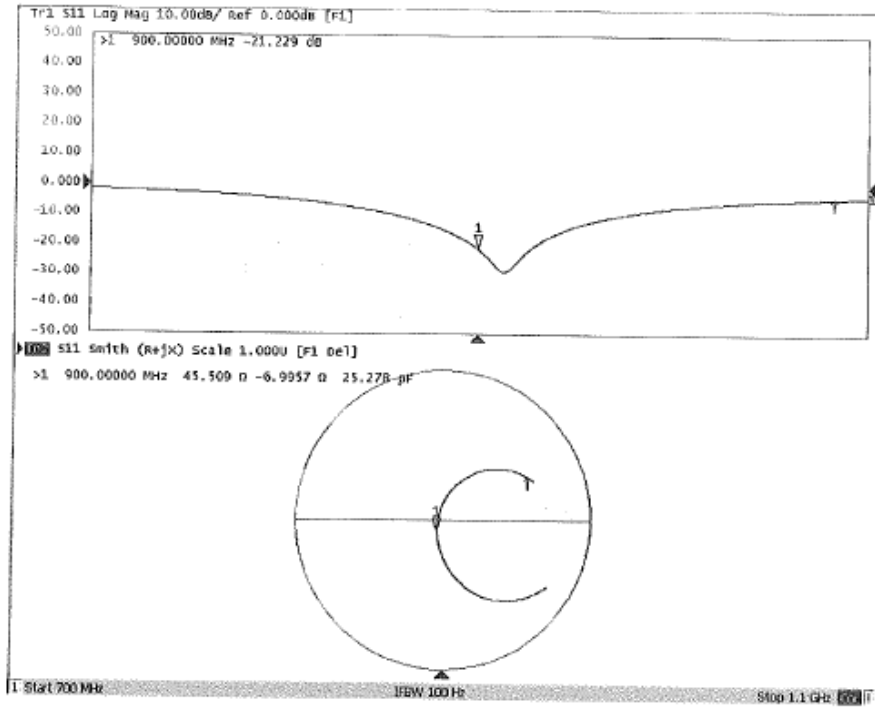



In Collaboration with  
**s p e a g**  
CALIBRATION LABORATORY



中国认可  
国际互认  
校准  
CALIBRATION  
CNAS L0570

Add: No.51 Xueyuan Road, Haidian District, Beijing, 100191, China  
Tel: +86-10-62304633-2079 Fax: +86-10-62304633-2504  
E-mail: cttl@chinantl.com http://www.chinantl.cn

Client **SMQ**

Certificate No: **Z20-60038**

## CALIBRATION CERTIFICATE

Object: **D1750V2 - SN: 1108**

Calibration Procedure(s): **FF-Z11-003-01**  
**Calibration Procedures for dipole validation kits**

Calibration date: **January 3, 2020**

This calibration Certificate documents the traceability to national standards, which realize the physical units of measurements(SI). The measurements and the uncertainties with confidence probability are given on the following pages and are part of the certificate.

All calibrations have been conducted in the closed laboratory facility; environment temperature(22±3)°C and humidity<70%.

Calibration Equipment used (M&TE critical for calibration)

Primary Standards	ID #	Cal Date(Calibrated by, Certificate No.)	Scheduled Calibration
Power Meter NRP2	106276	11-Apr-19 (CTTL, No.J19X02605)	Apr-20
Power sensor NRP6A	101369	11-Apr-19 (CTTL, No.J19X02605)	Apr-20
Reference Probe EX3DV4 DAE4	SN 3617	31-Jan-19(SPEAG,No.EX3-3617_Jan19)	Jan-20
	SN 1555	22-Aug-19(CTTL-SPEAG,No.Z19-60295)	Aug-20
Secondary Standards	ID #	Cal Date(Calibrated by, Certificate No.)	Scheduled Calibration
Signal Generator E4438C	MY49071430	23-Jan-19 (CTTL, No.J19X00336)	Jan-20
NetworkAnalyzer E5071C	MY46110673	24-Jan-19 (CTTL, No.J19X00547)	Jan-20

	Name	Function	Signature
Calibrated by:	Zhao Jing	SAR Test Engineer	
Reviewed by:	Lin Hao	SAR Test Engineer	
Approved by:	Qi Dianyuan	SAR Project Leader	

Issued: January 8, 2020

This calibration certificate shall not be reproduced except in full without written approval of the laboratory.



Add: No.51 Xueyuan Road, Haidian District, Beijing, 100191, China  
Tel: +86-10-62304633-2079 Fax: +86-10-62304633-2504  
E-mail: cttl@chinattl.com http://www.chinattl.cn

**Glossary:**

TSL	tissue simulating liquid
ConvF	sensitivity in TSL / NORM <sub>x,y,z</sub>
N/A	not applicable or not measured

**Calibration is Performed According to the Following Standards:**

- a) IEEE Std 1528-2013, "IEEE Recommended Practice for Determining the Peak Spatial-Averaged Specific Absorption Rate (SAR) in the Human Head from Wireless Communications Devices: Measurement Techniques", June 2013
- b) IEC 62209-1, "Measurement procedure for assessment of specific absorption rate of human exposure to radio frequency fields from hand-held and body-mounted wireless communication devices- Part 1: Device used next to the ear (Frequency range of 300MHz to 6GHz)", July 2016
- c) IEC 62209-2, "Procedure to measure the Specific Absorption Rate (SAR) For wireless communication devices used in close proximity to the human body (frequency range of 30MHz to 6GHz)", March 2010
- d) KDB865664, SAR Measurement Requirements for 100 MHz to 6 GHz

**Additional Documentation:**

- e) DASY4/5 System Handbook

**Methods Applied and Interpretation of Parameters:**

- *Measurement Conditions:* Further details are available from the Validation Report at the end of the certificate. All figures stated in the certificate are valid at the frequency indicated.
- *Antenna Parameters with TSL:* The dipole is mounted with the spacer to position its feed point exactly below the center marking of the flat phantom section, with the arms oriented parallel to the body axis.
- *Feed Point Impedance and Return Loss:* These parameters are measured with the dipole positioned under the liquid filled phantom. The impedance stated is transformed from the measurement at the SMA connector to the feed point. The Return Loss ensures low reflected power. No uncertainty required.
- *Electrical Delay:* One-way delay between the SMA connector and the antenna feed point. No uncertainty required.
- *SAR measured:* SAR measured at the stated antenna input power.
- *SAR normalized:* SAR as measured, normalized to an input power of 1 W at the antenna connector.
- *SAR for nominal TSL parameters:* The measured TSL parameters are used to calculate the nominal SAR result.

The reported uncertainty of measurement is stated as the standard uncertainty of Measurement multiplied by the coverage factor  $k=2$ , which for a normal distribution Corresponds to a coverage probability of approximately 95%.

### Measurement Conditions

DASY system configuration, as far as not given on page 1.

DASY Version	DASY52	V52.10.3
Extrapolation	Advanced Extrapolation	
Phantom	Triple Flat Phantom 5.1C	
Distance Dipole Center - TSL	10 mm	with Spacer
Zoom Scan Resolution	dx, dy, dz = 5 mm	
Frequency	1750 MHz $\pm$ 1 MHz	

### Head TSL parameters

The following parameters and calculations were applied.

	Temperature	Permittivity	Conductivity
Nominal Head TSL parameters	22.0 °C	40.1	1.37 mho/m
Measured Head TSL parameters	(22.0 $\pm$ 0.2) °C	40.5 $\pm$ 6 %	1.37 mho/m $\pm$ 6 %
Head TSL temperature change during test	<1.0 °C	---	---

### SAR result with Head TSL

SAR averaged over 1 $cm^3$ (1 g) of Head TSL	Condition	
SAR measured	250 mW input power	8.89 W/kg
SAR for nominal Head TSL parameters	normalized to 1W	<b>35.7 W/kg <math>\pm</math> 18.8 % (k=2)</b>
SAR averaged over 10 $cm^3$ (10 g) of Head TSL	Condition	
SAR measured	250 mW input power	4.69 W/kg
SAR for nominal Head TSL parameters	normalized to 1W	<b>18.8 W/kg <math>\pm</math> 18.7 % (k=2)</b>

### Body TSL parameters

The following parameters and calculations were applied.

	Temperature	Permittivity	Conductivity
Nominal Body TSL parameters	22.0 °C	53.4	1.49 mho/m
Measured Body TSL parameters	(22.0 $\pm$ 0.2) °C	53.6 $\pm$ 6 %	1.50 mho/m $\pm$ 6 %
Body TSL temperature change during test	<1.0 °C	---	---

### SAR result with Body TSL

SAR averaged over 1 $cm^3$ (1 g) of Body TSL	Condition	
SAR measured	250 mW input power	9.23 W/kg
SAR for nominal Body TSL parameters	normalized to 1W	<b>36.8 W/kg <math>\pm</math> 18.8 % (k=2)</b>
SAR averaged over 10 $cm^3$ (10 g) of Body TSL	Condition	
SAR measured	250 mW input power	4.89 W/kg
SAR for nominal Body TSL parameters	normalized to 1W	<b>19.5 W/kg <math>\pm</math> 18.7 % (k=2)</b>



Add: No.51 Xueyuan Road, Haidian District, Beijing, 100191, China  
 Tel: +86-10-62304633-2079 Fax: +86-10-62304633-2504  
 E-mail: cttl@chinattl.com http://www.chinattl.cn

**Appendix (Additional assessments outside the scope of CNAS L0570)**

**Antenna Parameters with Head TSL**

Impedance, transformed to feed point	49.2Ω- 0.65 jΩ
Return Loss	- 39.7 dB

**Antenna Parameters with Body TSL**

Impedance, transformed to feed point	45.8Ω- 1.02 jΩ
Return Loss	- 26.8 dB

**General Antenna Parameters and Design**

Electrical Delay (one direction)	1.084 ns
----------------------------------	----------

After long term use with 100W radiated power, only a slight warming of the dipole near the feedpoint can be measured.

The dipole is made of standard semirigid coaxial cable. The center conductor of the feeding line is directly connected to the second arm of the dipole. The antenna is therefore short-circuited for DC-signals. On some of the dipoles, small end caps are added to the dipole arms in order to improve matching when loaded according to the position as explained in the "Measurement Conditions" paragraph. The SAR data are not affected by this change. The overall dipole length is still according to the Standard. No excessive force must be applied to the dipole arms, because they might bend or the soldered connections near the feedpoint may be damaged.

**Additional EUT Data**

Manufactured by	SPEAG
-----------------	-------

**DASY5 Validation Report for Head TSL**

Date: 01.03.2020

Test Laboratory: CTTL, Beijing, China

**DUT: Dipole 1750 MHz; Type: D1750V2; Serial: D1750V2 - SN: 1108**

Communication System: UID 0, CW; Frequency: 1750 MHz; Duty Cycle: 1:1

Medium parameters used:  $f = 1750$  MHz;  $\sigma = 1.365$  S/m;  $\epsilon_r = 40.52$ ;  $\rho = 1000$  kg/m<sup>3</sup>

Phantom section: Right Section

DASY5 Configuration:

- Probe: EX3DV4 - SN3617; ConvF(8.38, 8.38, 8.38) @ 1750 MHz; Calibrated: 1/31/2019
- Sensor-Surface: 1.4mm (Mechanical Surface Detection)
- Electronics: DAE4 Sn1555; Calibrated: 8/22/2019
- Phantom: MFP\_V5.1C ; Type: QD 000 P51CA; Serial: 1062
- Measurement SW: DASY52, Version 52.10 (3); SEMCAD X Version 14.6.13 (7474)

**System Performance Check/Zoom Scan (7x7x7) (7x7x7)/Cube 0: Measurement grid:**

dx=5mm, dy=5mm, dz=5mm

Reference Value = 97.57 V/m; Power Drift = 0.00 dB

Peak SAR (extrapolated) = 16.7 W/kg

**SAR(1 g) = 8.89 W/kg; SAR(10 g) = 4.69 W/kg**

Smallest distance from peaks to all points 3 dB below = 10 mm

Ratio of SAR at M2 to SAR at M1 = 54%

Maximum value of SAR (measured) = 13.9 W/kg

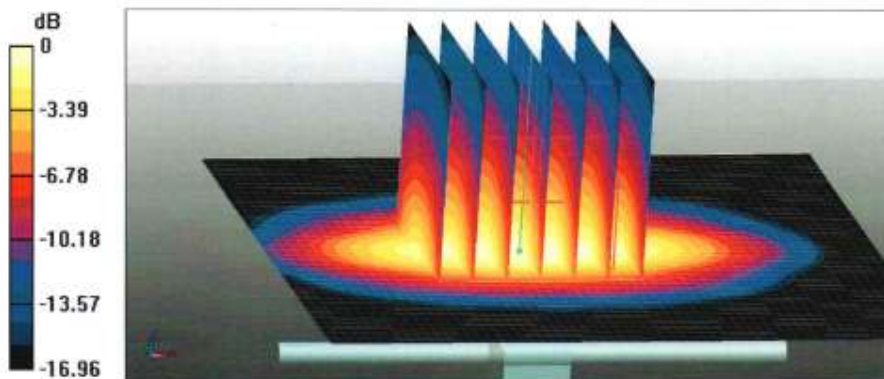

0 dB = 13.9 W/kg = 11.43 dBW/kg

**Impedance Measurement Plot for Head TSL**

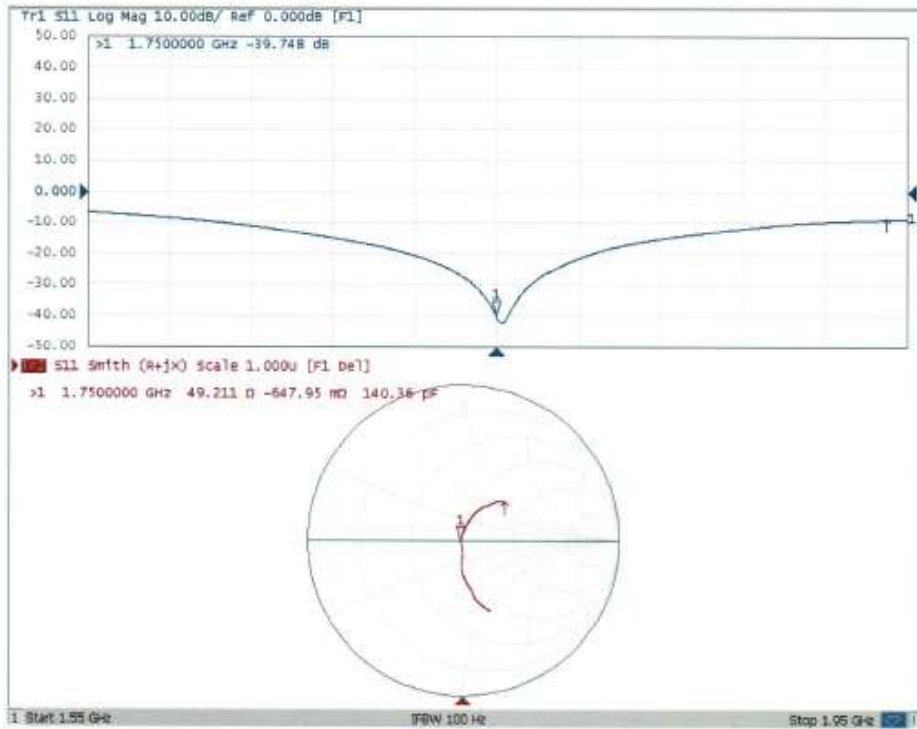

**DASY5 Validation Report for Body TSL**

Date: 01.03.2020

Test Laboratory: CTTL, Beijing, China

**DUT: Dipole 1750 MHz; Type: D1750V2; Serial: D1750V2 - SN: 1108**

Communication System: UID 0, CW; Frequency: 1750 MHz; Duty Cycle: 1:1

Medium parameters used:  $f = 1750$  MHz;  $\sigma = 1.499$  S/m;  $\epsilon_r = 53.62$ ;  $\rho = 1000$  kg/m<sup>3</sup>

Phantom section: Center Section

DASY5 Configuration:

- Probe: EX3DV4 - SN3617; ConvF(8.03, 8.03, 8.03) @ 1750 MHz; Calibrated: 1/31/2019
- Sensor-Surface: 1.4mm (Mechanical Surface Detection)
- Electronics: DAE4 Sn1555; Calibrated: 8/22/2019
- Phantom: MFP\_V5.1C ; Type: QD 000 P51CA; Serial: 1062
- Measurement SW: DASY52, Version 52.10 (3); SEMCAD X Version 14.6.13 (7474)

**System Performance Check/Zoom Scan (7x7x7) (7x7x7)/Cube 0: Measurement grid:**

$dx=5$ mm,  $dy=5$ mm,  $dz=5$ mm

Reference Value = 89.57 V/m; Power Drift = 0.03 dB

Peak SAR (extrapolated) = 16.8 W/kg

**SAR(1 g) = 9.23 W/kg; SAR(10 g) = 4.89 W/kg**

Smallest distance from peaks to all points 3 dB below = 9.2 mm

Ratio of SAR at M2 to SAR at M1 = 55.7%

Maximum value of SAR (measured) = 14.2 W/kg

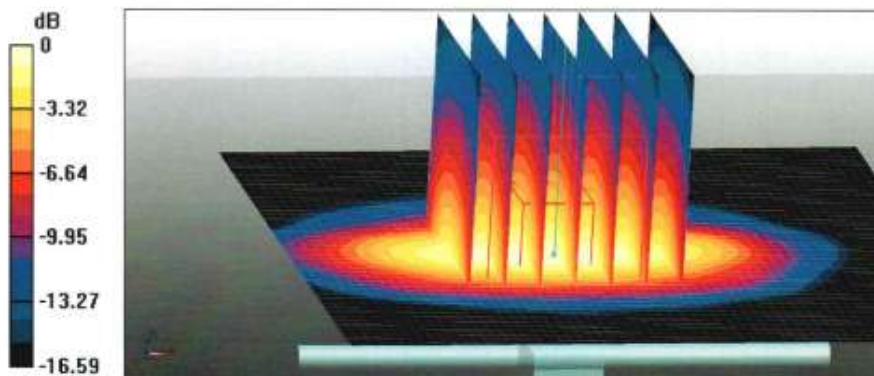

**0 dB = 14.2 W/kg = 11.52 dBW/kg**



**Impedance Measurement Plot for Body TSL**

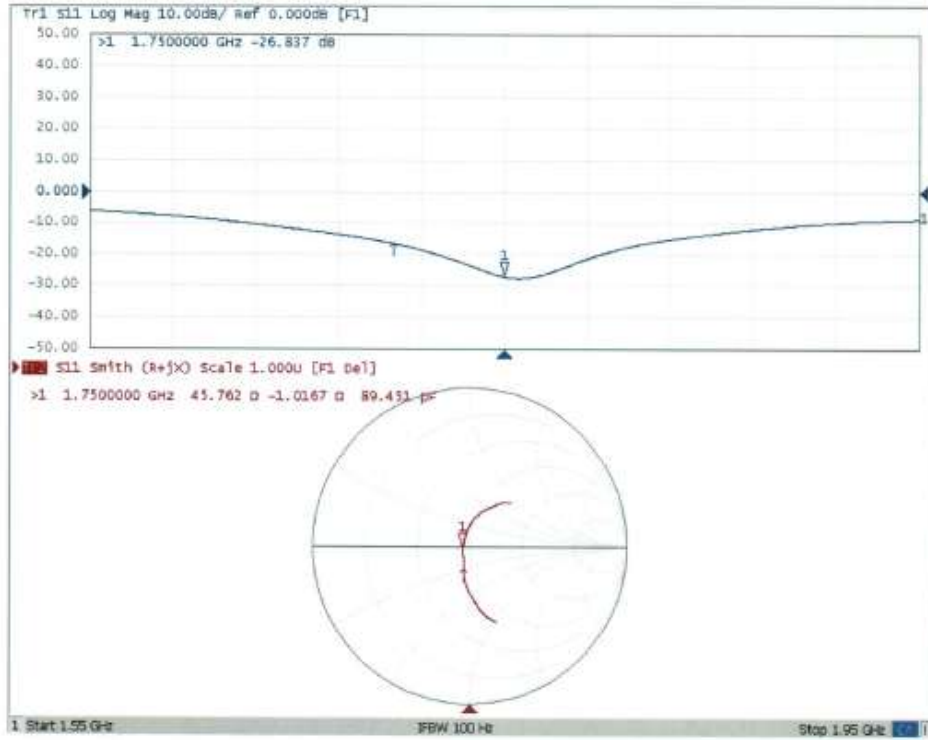



In Collaboration with  
**s p e a g**  
CALIBRATION LABORATORY



中国认可  
国际互认  
校准  
CALIBRATION  
CNAS L0570

Add: No.51 Xueyuan Road, Haidian District, Beijing, 100191, China  
Tel: +86-10-62304633-2079 Fax: +86-10-62304633-2504  
E-mail: ctf@chinatl.com http://www.chinatl.cn

Client **SMQ**

Certificate No: **Z18-60335**

## CALIBRATION CERTIFICATE

Object **D1800V2 - SN: 2d171**

Calibration Procedure(s) **FF-Z11-003-01**  
**Calibration Procedures for dipole validation kits**

Calibration date: **September 12, 2018**

This calibration Certificate documents the traceability to national standards, which realize the physical units of measurements(SI). The measurements and the uncertainties with confidence probability are given on the following pages and are part of the certificate.

All calibrations have been conducted in the closed laboratory facility: environment temperature(22±3)°C and humidity<70%.

Calibration Equipment used (M&TE critical for calibration)

Primary Standards	ID #	Cal Date(Calibrated by, Certificate No.)	Scheduled Calibration
Power Meter NRVD	102083	01-Nov-17 (CTTL, No.J17X08756)	Oct-18
Power sensor NRV-Z5	100542	01-Nov-17 (CTTL, No.J17X08756)	Oct-18
Reference Probe EX3DV4	SN 3846	25-Jan-18(SPEAG,No.EX3-3846_Jan18)	Jan-19
DAE4	SN 777	15-Dec-17(SPEAG,No.DAE4-777_Dec17)	Dec-18
Secondary Standards	ID #	Cal Date(Calibrated by, Certificate No.)	Scheduled Calibration
Signal Generator E4438C	MY49071430	23-Jan-18 (CTTL, No.J18X00560)	Jan-19
Network Analyzer E5071C	MY46110673	24-Jan-18 (CTTL, No.J18X00561)	Jan-19

	Name	Function	Signature
Calibrated by:	Zhao Jing	SAR Test Engineer	
Reviewed by:	Lin Jun	SAR Test Engineer	
Approved by:	Qi Diaryuan	SAR Project Leader	

Issued: September 16, 2018

This calibration certificate shall not be reproduced except in full without written approval of the laboratory.



In Collaboration with  
**s p e a g**  
CALIBRATION LABORATORY

Add: No.51 Xueyuan Road, Haidian District, Beijing, 100191, China  
Tel: +86-10-62304633-2079 Fax: +86-10-62304633-2504  
E-mail: cttl@chisattl.com http://www.chisattl.cn

**Glossary:**

TSL	tissue simulating liquid
ConvF	sensitivity in TSL / NORM <sub>x,y,z</sub>
N/A	not applicable or not measured

**Calibration is Performed According to the Following Standards:**

- IEEE Std 1528-2013, "IEEE Recommended Practice for Determining the Peak Spatial-Averaged Specific Absorption Rate (SAR) in the Human Head from Wireless Communications Devices: Measurement Techniques", June 2013
- IEC 62209-1, "Measurement procedure for assessment of specific absorption rate of human exposure to radio frequency fields from hand-held and body-mounted wireless communication devices- Part 1: Device used next to the ear (Frequency range of 300MHz to 6GHz)", July 2016
- IEC 62209-2, "Procedure to measure the Specific Absorption Rate (SAR) For wireless communication devices used in close proximity to the human body (frequency range of 30MHz to 6GHz)", March 2010
- KDB865664, SAR Measurement Requirements for 100 MHz to 6 GHz

**Additional Documentation:**

- DASY4/5 System Handbook

**Methods Applied and Interpretation of Parameters:**

- Measurement Conditions:** Further details are available from the Validation Report at the end of the certificate. All figures stated in the certificate are valid at the frequency indicated.
- Antenna Parameters with TSL:** The dipole is mounted with the spacer to position its feed point exactly below the center marking of the flat phantom section, with the arms oriented parallel to the body axis.
- Feed Point Impedance and Return Loss:** These parameters are measured with the dipole positioned under the liquid filled phantom. The impedance stated is transformed from the measurement at the SMA connector to the feed point. The Return Loss ensures low reflected power. No uncertainty required.
- Electrical Delay:** One-way delay between the SMA connector and the antenna feed point. No uncertainty required.
- SAR measured:** SAR measured at the stated antenna input power.
- SAR normalized:** SAR as measured, normalized to an input power of 1 W at the antenna connector.
- SAR for nominal TSL parameters:** The measured TSL parameters are used to calculate the nominal SAR result.

The reported uncertainty of measurement is stated as the standard uncertainty of Measurement multiplied by the coverage factor  $k=2$ , which for a normal distribution Corresponds to a coverage probability of approximately 95%.

### Measurement Conditions

DASY system configuration, as far as not given on page 1.

DASY Version	DASY52	52.10.1.1448
Extrapolation	Advanced Extrapolation	
Phantom	Triple Flat Phantom 5.1C	
Distance Dipole Center - TSL	10 mm	with Spacer
Zoom Scan Resolution	dx, dy, dz = 5 mm	
Frequency	1800 MHz $\pm$ 1 MHz	

### Head TSL parameters

The following parameters and calculations were applied.

	Temperature	Permittivity	Conductivity
Nominal Head TSL parameters	22.0 °C	40.0	1.40 mho/m
Measured Head TSL parameters	(22.0 $\pm$ 0.2) °C	40.6 $\pm$ 6 %	1.39 mho/m $\pm$ 6 %
Head TSL temperature change during test	<1.0 °C	----	----

### SAR result with Head TSL

SAR averaged over 1 $cm^3$ (1 g) of Head TSL	Condition	
SAR measured	250 mW input power	9.77 mW / g
SAR for nominal Head TSL parameters	normalized to 1W	39.4 mW /g $\pm$ 18.8 % (k=2)
SAR averaged over 10 $cm^3$ (10 g) of Head TSL	Condition	
SAR measured	250 mW input power	5.19 mW / g
SAR for nominal Head TSL parameters	normalized to 1W	20.9 mW /g $\pm$ 18.7 % (k=2)

### Body TSL parameters

The following parameters and calculations were applied.

	Temperature	Permittivity	Conductivity
Nominal Body TSL parameters	22.0 °C	53.3	1.52 mho/m
Measured Body TSL parameters	(22.0 $\pm$ 0.2) °C	53.2 $\pm$ 6 %	1.56 mho/m $\pm$ 6 %
Body TSL temperature change during test	<1.0 °C	----	----

### SAR result with Body TSL

SAR averaged over 1 $cm^3$ (1 g) of Body TSL	Condition	
SAR measured	250 mW input power	10.0 mW / g
SAR for nominal Body TSL parameters	normalized to 1W	39.3 mW /g $\pm$ 18.8 % (k=2)
SAR averaged over 10 $cm^3$ (10 g) of Body TSL	Condition	
SAR measured	250 mW input power	5.38 mW / g
SAR for nominal Body TSL parameters	normalized to 1W	21.3 mW /g $\pm$ 18.7 % (k=2)



Add: No.51 Xuciyuan Road, Haidian District, Beijing, 100191, China  
 Tel: +86-10-62304633-2079 Fax: +86-10-62304633-2504  
 E-mail: cttl@chinattl.com http://www.chinattl.cn

**Appendix (Additional assessments outside the scope of CNAS L0570)**

**Antenna Parameters with Head TSL**

Impedance, transformed to feed point	49.0Ω- 2.86jΩ
Return Loss	- 30.3dB

**Antenna Parameters with Body TSL**

Impedance, transformed to feed point	44.8Ω- 2.77jΩ
Return Loss	- 24.1dB

**General Antenna Parameters and Design**

Electrical Delay (one direction)	1.075 ns
----------------------------------	----------

After long term use with 100W radiated power, only a slight warming of the dipole near the feedpoint can be measured.

The dipole is made of standard semirigid coaxial cable. The center conductor of the feeding line is directly connected to the second arm of the dipole. The antenna is therefore short-circuited for DC-signals. On some of the dipoles, small end caps are added to the dipole arms in order to improve matching when loaded according to the position as explained in the "Measurement Conditions" paragraph. The SAR data are not affected by this change. The overall dipole length is still according to the Standard. No excessive force must be applied to the dipole arms, because they might bend or the soldered connections near the feedpoint may be damaged.

**Additional EUT Data**

Manufactured by	SPEAG
-----------------	-------

**DASY5 Validation Report for Head TSL**

Date: 09.12.2018

Test Laboratory: CTTL, Beijing, China

**DUT: Dipole 1800 MHz; Type: D1800V2; Serial: D1800V2 - SN: 2d171**

Communication System: UID 0, CW; Frequency: 1800 MHz; Duty Cycle: 1:1

Medium parameters used:  $f = 1800$  MHz;  $\sigma = 1.39$  S/m;  $\epsilon_r = 40.63$ ;  $\rho = 1000$  kg/m<sup>3</sup>

Phantom section: Center Section

DASY5 Configuration:

- Probe: EX3DV4 - SN3846; ConvF(8.22, 8.22, 8.22) @ 1800 MHz; Calibrated: 1/25/2018
- Sensor-Surface: 1.4mm (Mechanical Surface Detection)
- Electronics: DAE4 Sn777; Calibrated: 12/15/2017
- Phantom: MFP\_V5.1C ; Type: QD 000 P51CA; Serial: 1062
- Measurement SW: DASY52, Version 52.10 (1); SEMCAD X Version 14.6.11 (7439)

**System Performance Check/Zoom Scan (7x7x7) (7x7x7)/Cube 0: Measurement grid:**

$dx=5$ mm,  $dy=5$ mm,  $dz=5$ mm

Reference Value = 99.67 V/m; Power Drift = -0.02 dB

Peak SAR (extrapolated) = 18.2 W/kg

**SAR(1 g) = 9.77 W/kg; SAR(10 g) = 5.19 W/kg**

Maximum value of SAR (measured) = 15.1 W/kg

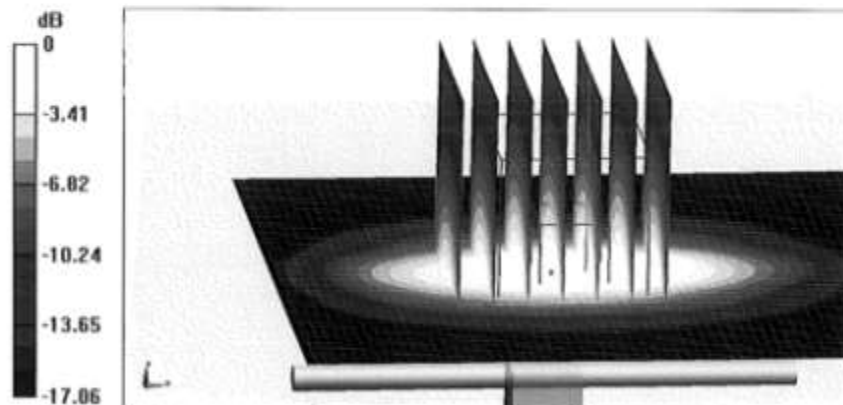

0 dB = 15.1 W/kg = 11.79 dBW/kg

**Impedance Measurement Plot for Head TSL**

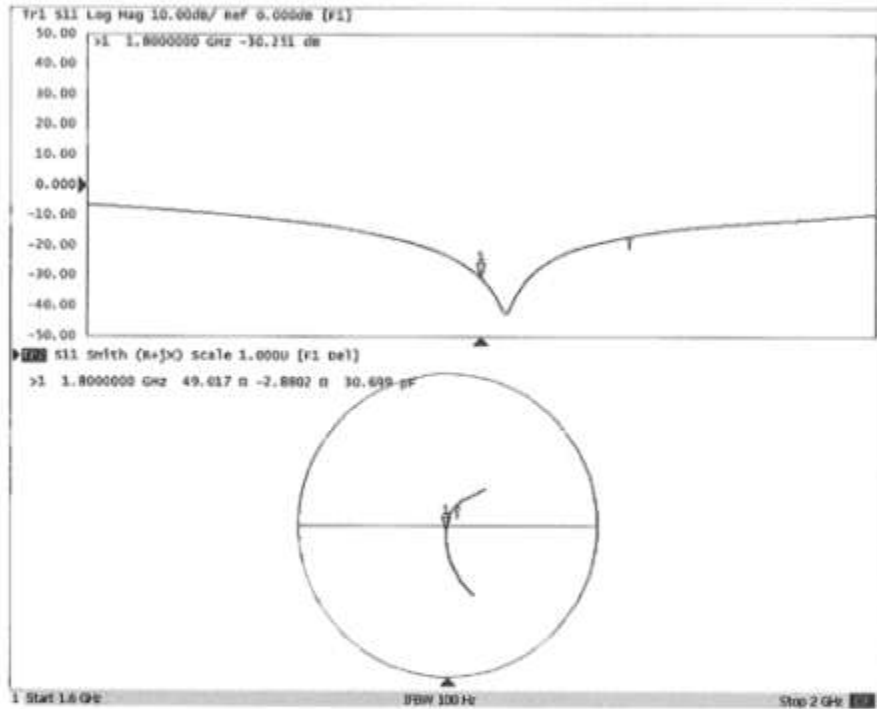

**DASY5 Validation Report for Body TSL**

Date: 09.12.2018

Test Laboratory: CTTL, Beijing, China

**DUT: Dipole 1800 MHz; Type: D1800V2; Serial: D1800V2 - SN: 2d171**

Communication System: UID 0, CW; Frequency: 1800 MHz; Duty Cycle: 1:1

Medium parameters used:  $f = 1800$  MHz;  $\sigma = 1.56$  S/m;  $\epsilon_r = 53.15$ ;  $\rho = 1000$  kg/m<sup>3</sup>

Phantom section: Right Section

DASY5 Configuration:

- Probe: EX3DV4 - SN3846; ConvF(7.73, 7.73, 7.73) @ 1800 MHz; Calibrated: 1/25/2018
- Sensor-Surface: 1.4mm (Mechanical Surface Detection)
- Electronics: DAE4 Sn777; Calibrated: 12/15/2017
- Phantom: MFP\_V5.1C ; Type: QD 000 P51CA; Serial: 1062
- Measurement SW: DASY52, Version 52.10 (1); SEMCAD X Version 14.6.11 (7439)

**System Performance Check/Zoom Scan (7x7x7) (7x7x7)/Cube 0: Measurement grid:**

$dx=5$ mm,  $dy=5$ mm,  $dz=5$ mm

Reference Value = 92.91 V/m; Power Drift = 0.07 dB

Peak SAR (extrapolated) = 17.9 W/kg

**SAR(1 g) = 10 W/kg; SAR(10 g) = 5.38 W/kg**

Maximum value of SAR (measured) = 15.2 W/kg

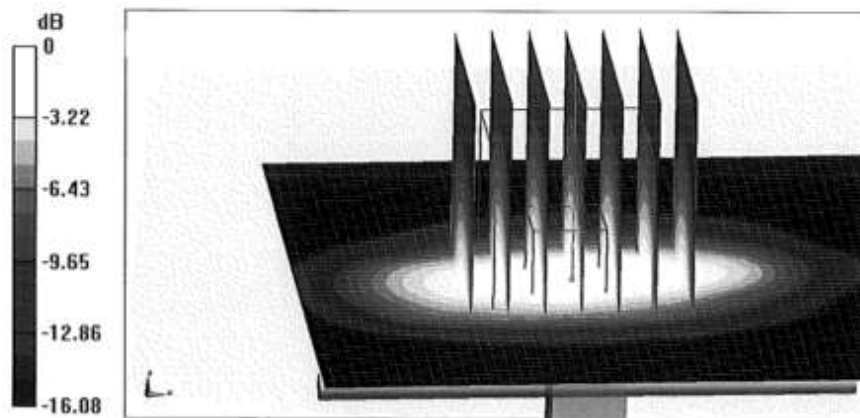

**0 dB = 15.2 W/kg = 11.82 dBW/kg**



**Impedance Measurement Plot for Body TSL**

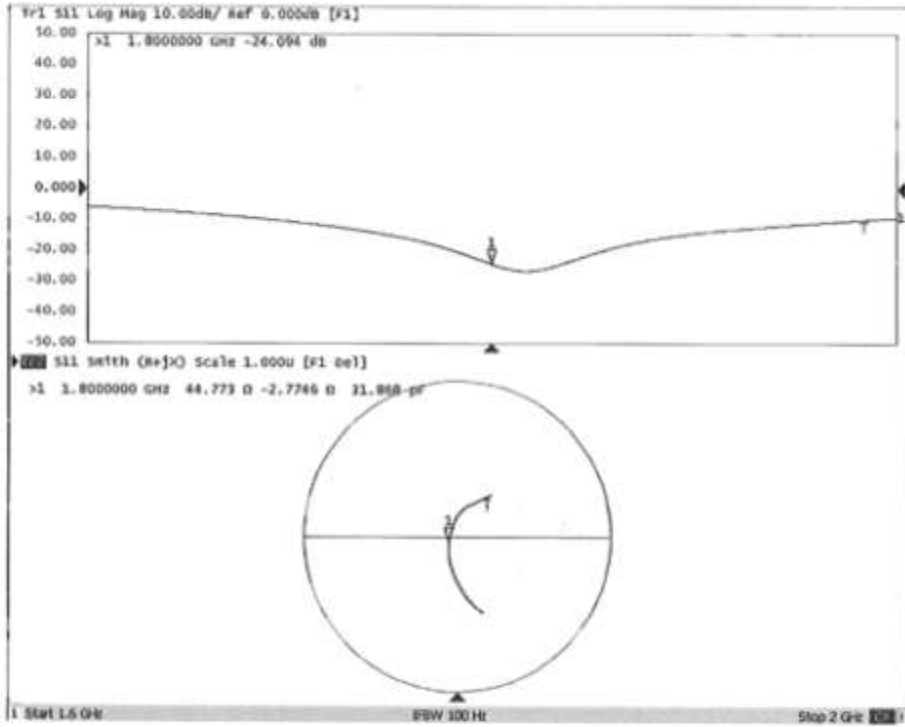



In Collaboration with  
**s p e a g**  
CALIBRATION LABORATORY



中国认可  
国际互认  
校准  
CALIBRATION  
CNAS L0570

Add: No.51 Xueyuan Road, Haidian District, Beijing, 100191, China  
Tel: +86-10-62304633-2079 Fax: +86-10-62304633-2504  
E-mail: cttl@chinattl.com http://www.chinattl.cn

Client **SMQ**

Certificate No: **Z18-60336**

## CALIBRATION CERTIFICATE

Object **D1900V2 - SN: 5d162**

Calibration Procedure(s) **FF-Z11-003-01**  
**Calibration Procedures for dipole validation kits**

Calibration date: **September 11, 2018**

This calibration Certificate documents the traceability to national standards, which realize the physical units of measurements(SI). The measurements and the uncertainties with confidence probability are given on the following pages and are part of the certificate.

All calibrations have been conducted in the closed laboratory facility: environment temperature(22±3)℃ and humidity<70%.

Calibration Equipment used (M&TE critical for calibration)

Primary Standards	ID #	Cal Date(Calibrated by, Certificate No.)	Scheduled Calibration
Power Meter NRVD	102083	01-Nov-17 (CTTL, No.J17X08756)	Oct-18
Power sensor NRV-Z5	100542	01-Nov-17 (CTTL, No.J17X08756)	Oct-18
Reference Probe EX3DV4	SN 7464	12-Sep-17(SPEAG,No.EX3-7464_Sep17)	Sep-18
DAE4	SN 1524	13-Sep-17(SPEAG,No.DAE4-1524_Sep17)	Sep-18
Secondary Standards	ID #	Cal Date(Calibrated by, Certificate No.)	Scheduled Calibration
Signal Generator E4438C	MY49071430	23-Jan-18 (CTTL, No.J18X00560)	Jan-19
NetworkAnalyzer E5071C	MY46110673	24-Jan-18 (CTTL, No.J18X00561)	Jan-19

	Name	Function	Signature
Calibrated by:	Zhao Jing	SAR Test Engineer	
Reviewed by:	Lin Jun	SAR Test Engineer	
Approved by:	Qi Dianyuan	SAR Project Leader	

Issued: September 15, 2018

This calibration certificate shall not be reproduced except in full without written approval of the laboratory.

Certificate No: Z18-60336

Page 1 of 8



Add: No.51 Xueyuan Road, Haidian District, Beijing, 100191, China  
Tel: +86-10-62304633-2079 Fax: +86-10-62304633-2504  
E-mail: cttl@chinattl.com http://www.chinattl.cn

**lossary:**

TSL	tissue simulating liquid
ConvF	sensitivity in TSL / NORMx,y,z
N/A	not applicable or not measured

**Calibration is Performed According to the Following Standards:**

- IEEE Std 1528-2013, "IEEE Recommended Practice for Determining the Peak Spatial-Averaged Specific Absorption Rate (SAR) in the Human Head from Wireless Communications Devices: Measurement Techniques", June 2013
- IEC 62209-1, "Measurement procedure for assessment of specific absorption rate of human exposure to radio frequency fields from hand-held and body-mounted wireless communication devices- Part 1: Device used next to the ear (Frequency range of 300MHz to 6GHz)", July 2016
- IEC 62209-2, "Procedure to measure the Specific Absorption Rate (SAR) For wireless communication devices used in close proximity to the human body (frequency range of 30MHz to 6GHz)", March 2010
- KDB865664, SAR Measurement Requirements for 100 MHz to 6 GHz

**Additional Documentation:**

- DASY4/5 System Handbook

**Methods Applied and Interpretation of Parameters:**

- Measurement Conditions:** Further details are available from the Validation Report at the end of the certificate. All figures stated in the certificate are valid at the frequency indicated.
- Antenna Parameters with TSL:** The dipole is mounted with the spacer to position its feed point exactly below the center marking of the flat phantom section, with the arms oriented parallel to the body axis.
- Feed Point Impedance and Return Loss:** These parameters are measured with the dipole positioned under the liquid filled phantom. The impedance stated is transformed from the measurement at the SMA connector to the feed point. The Return Loss ensures low reflected power. No uncertainty required.
- Electrical Delay:** One-way delay between the SMA connector and the antenna feed point. No uncertainty required.
- SAR measured:** SAR measured at the stated antenna input power.
- SAR normalized:** SAR as measured, normalized to an input power of 1 W at the antenna connector.
- SAR for nominal TSL parameters:** The measured TSL parameters are used to calculate the nominal SAR result.

The reported uncertainty of measurement is stated as the standard uncertainty of Measurement multiplied by the coverage factor  $k=2$ , which for a normal distribution Corresponds to a coverage probability of approximately 95%.



In Collaboration with  
**s p e a g**  
 CALIBRATION LABORATORY

Add: No.51 Xucyuan Road, Haidian District, Beijing, 100191, China  
 Tel: +86-10-62304633-2079 Fax: +86-10-62304633-2504  
 E-mail: cttl@chinattl.com http://www.chinattl.cn

**Measurement Conditions**

DASY system configuration, as far as not given on page 1.

DASY Version	DASY52	52.10.1.1476
Extrapolation	Advanced Extrapolation	
Phantom	Triple Flat Phantom 5.1C	
Distance Dipole Center - TSL	10 mm	with Spacer
Zoom Scan Resolution	dx, dy, dz = 5 mm	
Frequency	1900 MHz ± 1 MHz	

**Head TSL parameters**

The following parameters and calculations were applied.

	Temperature	Permittivity	Conductivity
Nominal Head TSL parameters	22.0 °C	40.0	1.40 mho/m
Measured Head TSL parameters	(22.0 ± 0.2) °C	40.4 ± 6 %	1.44 mho/m ± 6 %
Head TSL temperature change during test	<1.0 °C	----	----

**SAR result with Head TSL**

SAR averaged over 1 $cm^3$ (1 g) of Head TSL	Condition	
SAR measured	250 mW input power	10.1 mW / g
SAR for nominal Head TSL parameters	normalized to 1W	39.8 mW /g ± 18.8 % (k=2)
SAR averaged over 10 $cm^3$ (10 g) of Head TSL	Condition	
SAR measured	250 mW input power	5.33 mW / g
SAR for nominal Head TSL parameters	normalized to 1W	21.1 mW /g ± 18.7 % (k=2)

**Body TSL parameters**

The following parameters and calculations were applied.

	Temperature	Permittivity	Conductivity
Nominal Body TSL parameters	22.0 °C	53.3	1.52 mho/m
Measured Body TSL parameters	(22.0 ± 0.2) °C	53.3 ± 6 %	1.49 mho/m ± 6 %
Body TSL temperature change during test	<1.0 °C	----	----

**SAR result with Body TSL**

SAR averaged over 1 $cm^3$ (1 g) of Body TSL	Condition	
SAR measured	250 mW input power	9.97 mW / g
SAR for nominal Body TSL parameters	normalized to 1W	40.3 mW /g ± 18.8 % (k=2)
SAR averaged over 10 $cm^3$ (10 g) of Body TSL	Condition	
SAR measured	250 mW input power	5.38 mW / g
SAR for nominal Body TSL parameters	normalized to 1W	21.7 mW /g ± 18.7 % (k=2)



Add: No.51 Xueyuan Road, Haidian District, Beijing, 100191, China  
 Tel: +86-10-62304633-2079 Fax: +86-10-62304633-2504  
 E-mail: cttl@chinattl.com http://www.chinattl.cn

**Appendix (Additional assessments outside the scope of CNAS L0570)**

**Antenna Parameters with Head TSL**

Impedance, transformed to feed point	54.00+ 5.00jΩ
Return Loss	- 24.2dB

**Antenna Parameters with Body TSL**

Impedance, transformed to feed point	48.4Ω+ 5.03jΩ
Return Loss	- 25.4dB

**General Antenna Parameters and Design**

Electrical Delay (one direction)	1.061 ns
----------------------------------	----------

After long term use with 100W radiated power, only a slight warming of the dipole near the feedpoint can be measured.

The dipole is made of standard semirigid coaxial cable. The center conductor of the feeding line is directly connected to the second arm of the dipole. The antenna is therefore short-circuited for DC-signals. On some of the dipoles, small end caps are added to the dipole arms in order to improve matching when loaded according to the position as explained in the "Measurement Conditions" paragraph. The SAR data are not affected by this change. The overall dipole length is still according to the Standard. No excessive force must be applied to the dipole arms, because they might bend or the soldered connections near the feedpoint may be damaged.

**Additional EUT Data**

Manufactured by	SPEAG
-----------------	-------

**DASY5 Validation Report for Head TSL**

Date: 09.10.2018

Test Laboratory: CTTL, Beijing, China

**DUT: Dipole 1900 MHz; Type: D1900V2; Serial: D1900V2 - SN: 5d162**

Communication System: UID 0, CW; Frequency: 1900 MHz; Duty Cycle: 1:1

Medium parameters used:  $f = 1900$  MHz;  $\sigma = 1.438$  S/m;  $\epsilon_r = 40.37$ ;  $\rho = 1000$  kg/m<sup>3</sup>

Phantom section: Center Section

DASY5 Configuration:

- Probe: EX3DV4 - SN7464; ConvF(8.39, 8.39, 8.39) @ 1900 MHz; Calibrated: 9/12/2017
- Sensor-Surface: 1.4mm (Mechanical Surface Detection)
- Electronics: DAE4 Sn1524; Calibrated: 9/13/2017
- Phantom: MFP\_V5.1C ; Type: QD 000 P51CA; Serial: 1062
- Measurement SW: DASY52, Version 52.10 (1); SEMCAD X Version 14.6.11 (7439)

**System Performance Check/Zoom Scan (7x7x7) (7x7x7)/Cube 0: Measurement grid:**

dx=5mm, dy=5mm, dz=5mm

Reference Value = 97.60 V/m; Power Drift = -0.04 dB

Peak SAR (extrapolated) = 19.0 W/kg

**SAR(1 g) = 10.1 W/kg; SAR(10 g) = 5.33 W/kg**

Maximum value of SAR (measured) = 15.8 W/kg

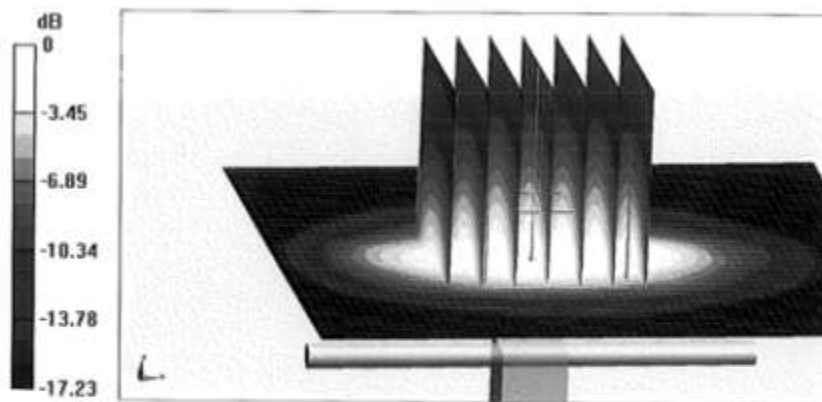

0 dB = 15.8 W/kg = 11.99 dBW/kg

**Impedance Measurement Plot for Head TSL**

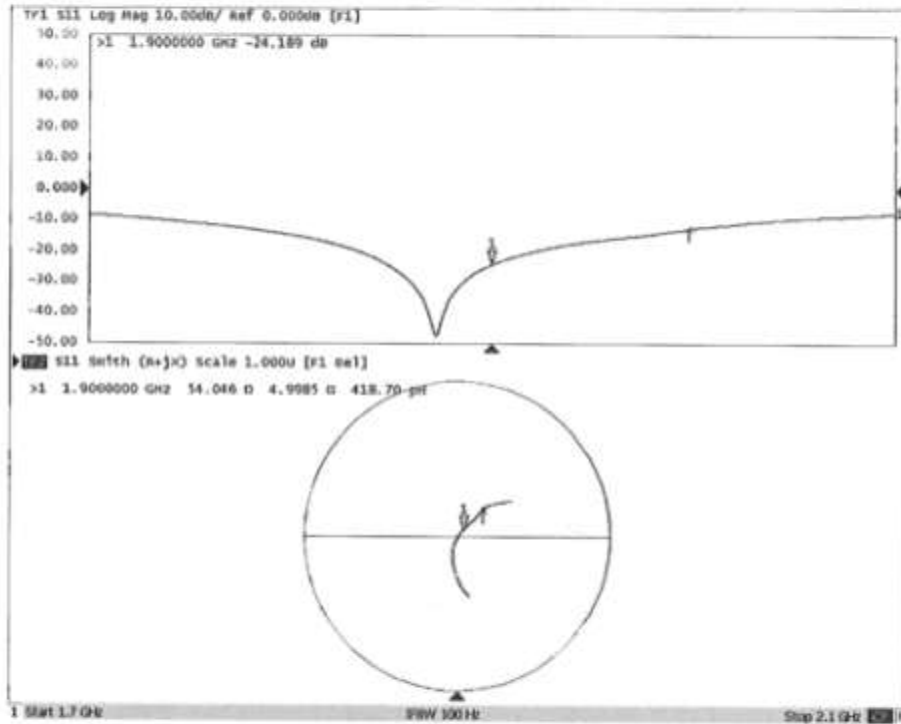

**DASY5 Validation Report for Body TSL**

Date: 09.10.2018

Test Laboratory: CTTL, Beijing, China

**DUT: Dipole 1900 MHz; Type: D1900V2; Serial: D1900V2 - SN: 5d162**

Communication System: UID 0, CW; Frequency: 1900 MHz; Duty Cycle: 1:1

Medium parameters used:  $f = 1900$  MHz;  $\sigma = 1.493$  S/m;  $\epsilon_r = 53.34$ ;  $\rho = 1000$  kg/m<sup>3</sup>

Phantom section: Right Section

DASY5 Configuration:

- Probe: EX3DV4 - SN7464; ConvF(8.32, 8.32, 8.32) @ 1900 MHz; Calibrated: 9/12/2017
- Sensor-Surface: 1.4mm (Mechanical Surface Detection)
- Electronics: DAE4 Sn1524; Calibrated: 9/13/2017
- Phantom: MFP\_V5.1C ; Type: QD 000 P51CA; Serial: 1062
- Measurement SW: DASY52, Version 52.10 (1); SEMCAD X Version 14.6.11 (7439)

**System Performance Check/Zoom Scan (7x7x7) (7x7x7)/Cube 0: Measurement grid:**

$dx=5$ mm,  $dy=5$ mm,  $dz=5$ mm

Reference Value = 94.26 V/m; Power Drift = -0.07 dB

Peak SAR (extrapolated) = 17.5 W/kg

**SAR(1 g) = 9.97 W/kg; SAR(10 g) = 5.38 W/kg**

Maximum value of SAR (measured) = 15.0 W/kg

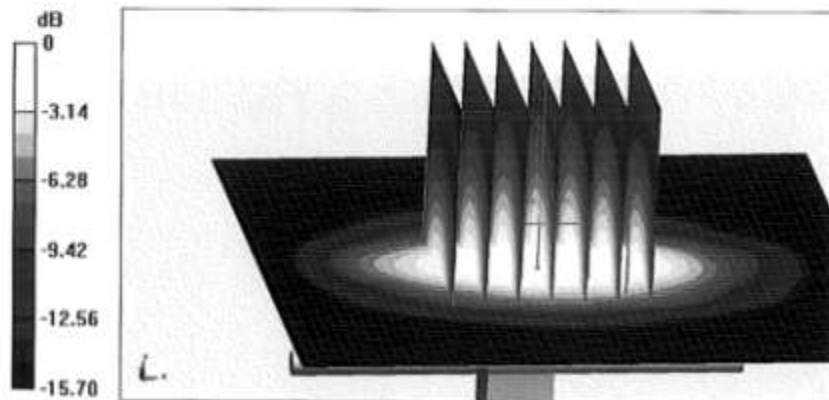

0 dB = 15.0 W/kg = 11.76 dBW/kg



**Impedance Measurement Plot for Body TSL**

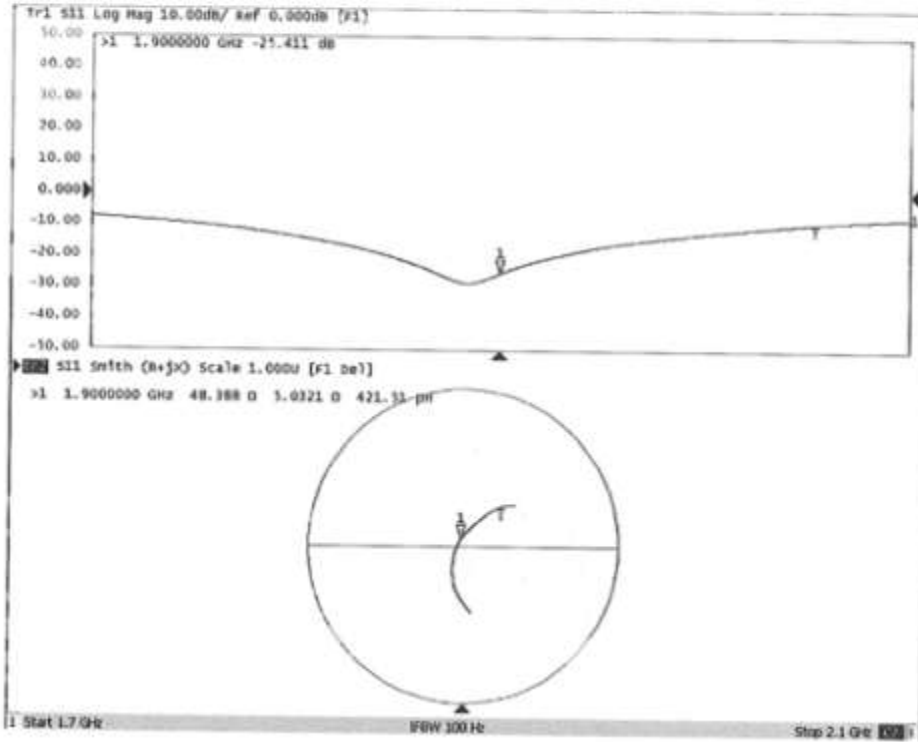



In Collaboration with  
**s p e a g**  
 CALIBRATION LABORATORY



中国认可  
 国际互认  
 校准  
 CALIBRATION  
 CNAS L0570

Add: No.51 Xueyuan Road, Haidian District, Beijing, 100191, China  
 Tel: +86-10-62304633-2079 Fax: +86-10-62304633-2504  
 E-mail: cntl@chinatl.com http://www.chinatl.cn

Client

SMQ

Certificate No: Z20-60039

## CALIBRATION CERTIFICATE

Object D2300V2 - SN: 1034

Calibration Procedure(s) FF-Z11-003-01  
 Calibration Procedures for dipole validation kits

Calibration date: January 2, 2020

This calibration Certificate documents the traceability to national standards, which realize the physical units of measurements(SI). The measurements and the uncertainties with confidence probability are given on the following pages and are part of the certificate.

All calibrations have been conducted in the closed laboratory facility: environment temperature(22±3)℃ and humidity<70%.

Calibration Equipment used (M&TE critical for calibration)

Primary Standards	ID #	Cal Date(Calibrated by, Certificate No.)	Scheduled Calibration
Power Meter NRP2	106276	11-Apr-19 (CTTL, No.J19X02605)	Apr-20
Power sensor NRP6A	101369	11-Apr-19 (CTTL, No.J19X02605)	Apr-20
Reference Probe EX3DV4	SN 3617	31-Jan-19(SPEAG, No.EX3-3617_Jan19)	Jan-20
DAE4	SN 1555	22-Aug-19(CTTL-SPEAG, No.Z19-60295)	Aug-20
Secondary Standards	ID #	Cal Date(Calibrated by, Certificate No.)	Scheduled Calibration
Signal Generator E4438C	MY49071430	23-Jan-19 (CTTL, No.J19X00336)	Jan-20
NetworkAnalyzer E5071C	MY46110673	24-Jan-19 (CTTL, No.J19X00547)	Jan-20

	Name	Function	Signature
Calibrated by:	Zhao Jing	SAR Test Engineer	
Reviewed by:	Lin Hao	SAR Test Engineer	
Approved by:	Qi Dianyuan	SAR Project Leader	

Issued: January 8, 2020

This calibration certificate shall not be reproduced except in full without written approval of the laboratory.



In Collaboration with  
**s p e a g**  
CALIBRATION LABORATORY

Add: No.51 Xueyuan Road, Haidian District, Beijing, 100191, China  
Tel: +86-10-62304633-2079 Fax: +86-10-62304633-2504  
E-mail: cntl@chinamtl.com http://www.chinamtl.cn

**Glossary:**

TSL	tissue simulating liquid
ConvF	sensitivity in TSL / NORM <sub>x,y,z</sub>
N/A	not applicable or not measured

**Calibration is Performed According to the Following Standards:**

- IEEE Std 1528-2013, "IEEE Recommended Practice for Determining the Peak Spatial-Averaged Specific Absorption Rate (SAR) in the Human Head from Wireless Communications Devices: Measurement Techniques", June 2013
- IEC 62209-1, "Measurement procedure for assessment of specific absorption rate of human exposure to radio frequency fields from hand-held and body-mounted wireless communication devices- Part 1: Device used next to the ear (Frequency range of 300MHz to 6GHz)", July 2016
- IEC 62209-2, "Procedure to measure the Specific Absorption Rate (SAR) For wireless communication devices used in close proximity to the human body (frequency range of 30MHz to 6GHz)", March 2010
- KDB865664, SAR Measurement Requirements for 100 MHz to 6 GHz

**Additional Documentation:**

- DASY4/5 System Handbook

**Methods Applied and Interpretation of Parameters:**

- Measurement Conditions:* Further details are available from the Validation Report at the end of the certificate. All figures stated in the certificate are valid at the frequency indicated.
- Antenna Parameters with TSL:* The dipole is mounted with the spacer to position its feed point exactly below the center marking of the flat phantom section, with the arms oriented parallel to the body axis.
- Feed Point Impedance and Return Loss:* These parameters are measured with the dipole positioned under the liquid filled phantom. The impedance stated is transformed from the measurement at the SMA connector to the feed point. The Return Loss ensures low reflected power. No uncertainty required.
- Electrical Delay:* One-way delay between the SMA connector and the antenna feed point. No uncertainty required.
- SAR measured:* SAR measured at the stated antenna input power.
- SAR normalized:* SAR as measured, normalized to an input power of 1 W at the antenna connector.
- SAR for nominal TSL parameters:* The measured TSL parameters are used to calculate the nominal SAR result.

The reported uncertainty of measurement is stated as the standard uncertainty of Measurement multiplied by the coverage factor  $k=2$ , which for a normal distribution corresponds to a coverage probability of approximately 95%.



In Collaboration with  
**s p e a g**  
CALIBRATION LABORATORY

Add: No.51 Xueyuan Road, Haidian District, Beijing, 100191, China  
Tel: +86-10-62304633-2079 Fax: +86-10-62304633-2504  
E-mail: ctt@chinattf.com http://www.chinattf.cn

### Measurement Conditions

DASY system configuration, as far as not given on page 1.

DASY Version	DASY52	V52.10.3
Extrapolation	Advanced Extrapolation	
Phantom	Triple Flat Phantom 5.1C	
Distance Dipole Center - TSL	10 mm	with Spacer
Zoom Scan Resolution	dx, dy, dz = 5 mm	
Frequency	2300 MHz $\pm$ 1 MHz	

### Head TSL parameters

The following parameters and calculations were applied.

	Temperature	Permittivity	Conductivity
Nominal Head TSL parameters	22.0 °C	39.5	1.67 mho/m
Measured Head TSL parameters	(22.0 $\pm$ 0.2) °C	39.3 $\pm$ 6 %	1.64 mho/m $\pm$ 6 %
Head TSL temperature change during test	<1.0 °C	---	---

### SAR result with Head TSL

SAR averaged over 1 $cm^3$ (1 g) of Head TSL	Condition	
SAR measured	250 mW input power	11.8 W/kg
SAR for nominal Head TSL parameters	normalized to 1W	47.5 W/kg $\pm$ 18.8 % (k=2)
SAR averaged over 10 $cm^3$ (10 g) of Head TSL	Condition	
SAR measured	250 mW input power	5.57 W/kg
SAR for nominal Head TSL parameters	normalized to 1W	22.4 W/kg $\pm$ 18.7 % (k=2)

### Body TSL parameters

The following parameters and calculations were applied.

	Temperature	Permittivity	Conductivity
Nominal Body TSL parameters	22.0 °C	52.9	1.81 mho/m
Measured Body TSL parameters	(22.0 $\pm$ 0.2) °C	52.3 $\pm$ 6 %	1.83 mho/m $\pm$ 6 %
Body TSL temperature change during test	<1.0 °C	---	---

### SAR result with Body TSL

SAR averaged over 1 $cm^3$ (1 g) of Body TSL	Condition	
SAR measured	250 mW input power	12.0 W/kg
SAR for nominal Body TSL parameters	normalized to 1W	47.6 W/kg $\pm$ 18.8 % (k=2)
SAR averaged over 10 $cm^3$ (10 g) of Body TSL	Condition	
SAR measured	250 mW input power	5.70 W/kg
SAR for nominal Body TSL parameters	normalized to 1W	22.7 W/kg $\pm$ 18.7 % (k=2)



In Collaboration with  
**s p e a g**  
CALIBRATION LABORATORY

Add: No.51 Xueyuan Road, Haidian District, Beijing, 100191, China  
Tel: +86-10-62304633-2079 Fax: +86-10-62304633-2504  
E-mail: cttl@chinattl.com http://www.chinattl.cn

#### Appendix (Additional assessments outside the scope of CNAS L0570)

##### Antenna Parameters with Head TSL

Impedance, transformed to feed point	48.4Ω- 3.16jΩ
Return Loss	- 28.8dB

##### Antenna Parameters with Body TSL

Impedance, transformed to feed point	45.4Ω- 2.69jΩ
Return Loss	- 25.1dB

##### General Antenna Parameters and Design

Electrical Delay (one direction)	1.033 ns
----------------------------------	----------

After long term use with 100W radiated power, only a slight warming of the dipole near the feedpoint can be measured.

The dipole is made of standard semirigid coaxial cable. The center conductor of the feeding line is directly connected to the second arm of the dipole. The antenna is therefore short-circuited for DC-signals. On some of the dipoles, small end caps are added to the dipole arms in order to improve matching when loaded according to the position as explained in the "Measurement Conditions" paragraph. The SAR data are not affected by this change. The overall dipole length is still according to the Standard. No excessive force must be applied to the dipole arms, because they might bend or the soldered connections near the feedpoint may be damaged.

##### Additional EUT Data

Manufactured by	SPEAG
-----------------	-------



In Collaboration with  
**s p e a g**  
CALIBRATION LABORATORY

Add: No.51 Xueyuan Road, Haidian District, Beijing, 100191, China.  
Tel: +86-10-62304633-2079 Fax: +86-10-62304633-2504  
E-mail: cttl@chinattl.com http://www.chinattl.cn

**DASY5 Validation Report for Head TSL**

Date: 01.02.2020

Test Laboratory: CTTL, Beijing, China

**DUT: Dipole 2300 MHz; Type: D2300V2; Serial: D2300V2 - SN: 1034**

Communication System: UID 0, CW; Frequency: 2300 MHz; Duty Cycle: 1:1

Medium parameters used:  $f = 2300$  MHz;  $\sigma = 1.644$  S/m;  $\epsilon_r = 39.26$ ;  $\rho = 1000$  kg/m<sup>3</sup>

Phantom section: Center Section

DASY5 Configuration:

- Probe: EX3DV4 - SN3617; ConvF(7.74, 7.74, 7.74) @ 2300 MHz; Calibrated: 1/31/2019
- Sensor-Surface: 1.4mm (Mechanical Surface Detection)
- Electronics: DAE4 Sn1555; Calibrated: 8/22/2019
- Phantom: MFP\_V5.1C ; Type: QD 000 P51CA; Serial: 1062
- Measurement SW: DASY52, Version 52.10 (3); SEMCAD X Version 14.6.13 (7474)

**Dipole Calibration/Zoom Scan (7x7x7) (7x7x7)/Cube 0:** Measurement grid: dx=5mm, dy=5mm, dz=5mm

Reference Value = 101.4 V/m; Power Drift = 0.04 dB

Peak SAR (extrapolated) = 24.4 W/kg

**SAR(1 g) = 11.8 W/kg; SAR(10 g) = 5.57 W/kg**

Smallest distance from peaks to all points 3 dB below = 9 mm

Ratio of SAR at M2 to SAR at M1 = 48.7%

Maximum value of SAR (measured) = 19.7 W/kg

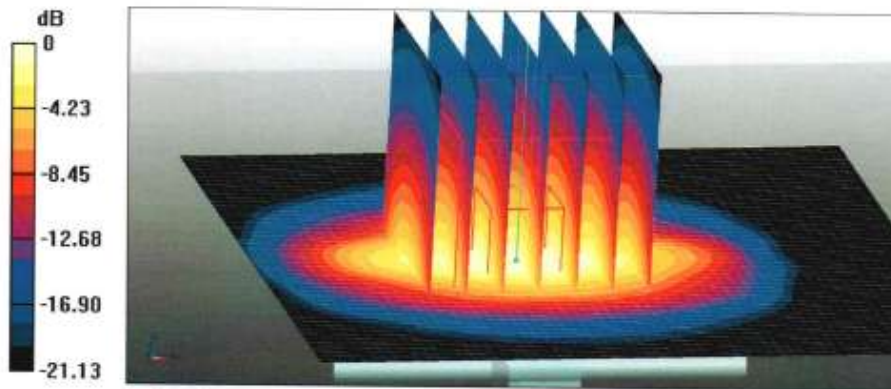

0 dB = 19.7 W/kg = 12.94 dBW/kg



In Collaboration with  
**s p e a g**  
CALIBRATION LABORATORY

Add: No.51 Xueyuan Road, Haidian District, Beijing, 100191, China  
Tel: +86-10-62304633-2079 Fax: +86-10-62304633-2504  
E-mail: cttl@chinatl.com http://www.chinatl.cn

### Impedance Measurement Plot for Head TSL

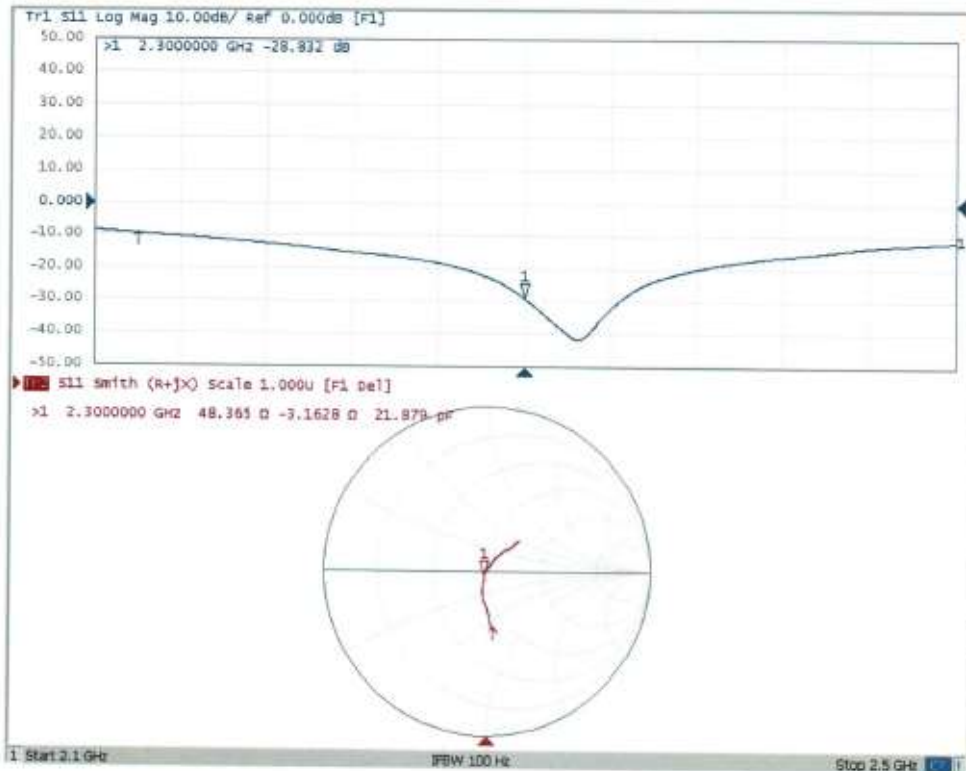



In Collaboration with  
**s p e a g**  
CALIBRATION LABORATORY

Add: No.51 Xueyuan Road, Haidian District, Beijing, 100191, China  
Tel: +86-10-62304633-2079 Fax: +86-10-62304633-2504  
E-mail: cttl@chinattl.com http://www.chinattl.cn

**DASY5 Validation Report for Body TSL**

Date: 01.02.2020

Test Laboratory: CTTL, Beijing, China

**DUT: Dipole 2300 MHz; Type: D2300V2; Serial: D2300V2 - SN: 1034**

Communication System: UID 0, CW; Frequency: 2300 MHz; Duty Cycle: 1:1

Medium parameters used:  $f = 2300$  MHz;  $\sigma = 1.828$  S/m;  $\epsilon_r = 52.26$ ;  $\rho = 1000$  kg/m<sup>3</sup>

Phantom section: Right Section

DASY5 Configuration:

- Probe: EX3DV4 - SN3617; ConvF(7.84, 7.84, 7.84) @ 2300 MHz; Calibrated: 1/31/2019
- Sensor-Surface: 1.4mm (Mechanical Surface Detection)
- Electronics: DAE4 Sn1555; Calibrated: 8/22/2019
- Phantom: MFP\_V5.1C ; Type: QD 000 P51CA; Serial: 1062
- Measurement SW: DASY52, Version 52.10 (3); SEMCAD X Version 14.6.13 (7474)

**Dipole Calibration/Zoom Scan (7x7x7) (7x7x7)/Cube 0:** Measurement grid: dx=5mm, dy=5mm, dz=5mm

Reference Value = 98.06 V/m; Power Drift = 0.00 dB

Peak SAR (extrapolated) = 23.9 W/kg

**SAR(1 g) = 12 W/kg; SAR(10 g) = 5.7 W/kg**

Smallest distance from peaks to all points 3 dB below = 8.2 mm

Ratio of SAR at M2 to SAR at M1 = 51.1%

Maximum value of SAR (measured) = 19.6 W/kg

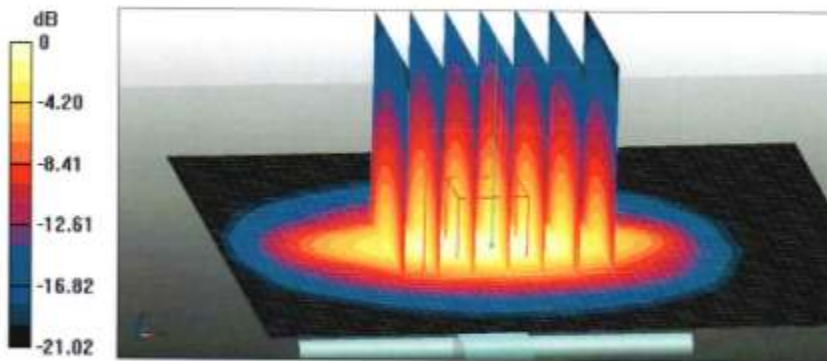

0 dB = 19.6 W/kg = 12.92 dBW/kg





In Collaboration with  
**s p e a g**  
CALIBRATION LABORATORY

Add: No.51 Xueyuan Road, Haidian District, Beijing, 100191, China  
Tel: +86-10-62304633-2079 Fax: +86-10-62304633-2504  
E-mail: cti@chinattl.com http://www.chinattl.cn

### Impedance Measurement Plot for Body TSL

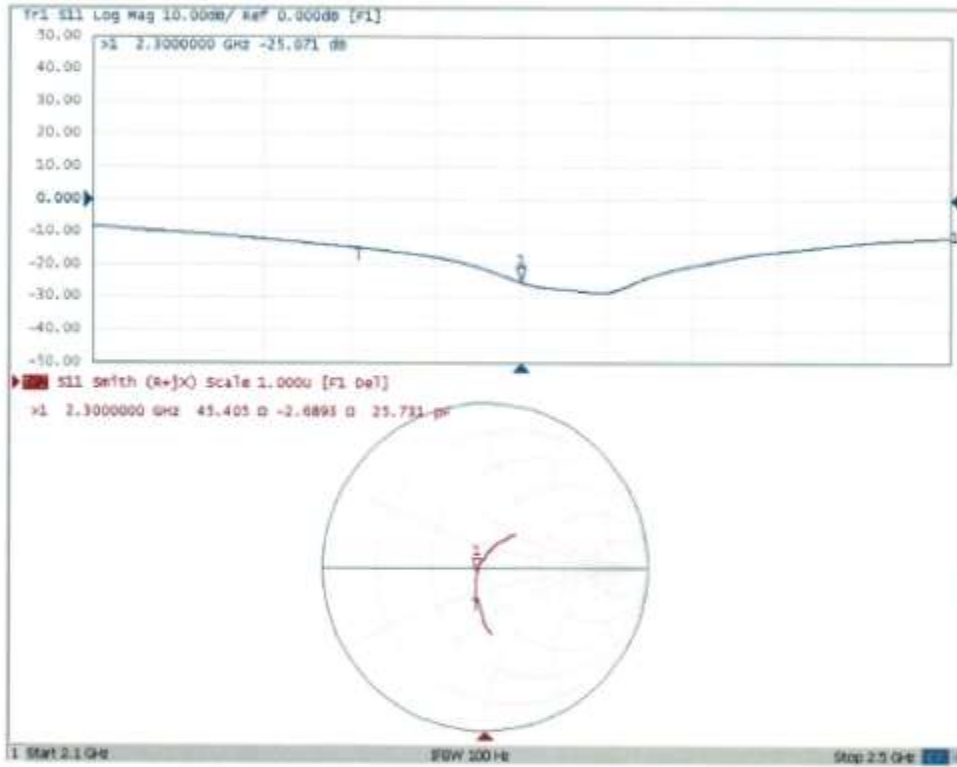



In Collaboration with  
**s p e a g**  
CALIBRATION LABORATORY



中国认可  
国际互认  
校准  
CALIBRATION  
CNAS L0570

Add: No.51 Xueyuan Road, Haidian District, Beijing, 100191, China  
Tel: +86-10-62304633-2079 Fax: +86-10-62304633-2504  
E-mail: cttl@chinattl.com http://www.chinattl.cn

Client

SMQ

Certificate No: Z18-60338

## CALIBRATION CERTIFICATE

Object D2450V2 - SN: 818

Calibration Procedure(s) FF-Z11-003-01  
Calibration Procedures for dipole validation kits

Calibration date: August 31, 2018

This calibration Certificate documents the traceability to national standards, which realize the physical units of measurements(SI). The measurements and the uncertainties with confidence probability are given on the following pages and are part of the certificate.

All calibrations have been conducted in the closed laboratory facility: environment temperature(22±3)°C and humidity<70%.

Calibration Equipment used (M&TE critical for calibration)

Primary Standards	ID #	Cal Date(Calibrated by, Certificate No.)	Scheduled Calibration
Power Meter NRVD	102083	01-Nov-17 (CTTL, No.J17X08756)	Oct-18
Power sensor NRV-Z5	100542	01-Nov-17 (CTTL, No.J17X08756)	Oct-18
Reference Probe EX3DV4	SN 7464	12-Sep-17(SPEAG,No.EX3-7464_Sep17)	Sep-18
DAE4	SN 1524	13-Sep-17(SPEAG,No.DAE4-1524_Sep17)	Sep-18
Secondary Standards	ID #	Cal Date(Calibrated by, Certificate No.)	Scheduled Calibration
Signal Generator E4438C	MY49071430	23-Jan-18 (CTTL, No.J18X00560)	Jan-19
NetworkAnalyzer E5071C	MY46110673	24-Jan-18 (CTTL, No.J18X00561)	Jan-19

	Name	Function	Signature
Calibrated by:	Zhao Jing	SAR Test Engineer	
Reviewed by:	Lin Hao	SAR Test Engineer	
Approved by:	Qi Dianyuan	SAR Project Leader	

Issued: September 3, 2018

This calibration certificate shall not be reproduced except in full without written approval of the laboratory.

Certificate No: Z18-60338

Page 1 of 8



In Collaboration with  
**s p e a g**  
CALIBRATION LABORATORY

Add: No.51 Xueyuan Road, Haidian District, Beijing, 100191, China  
Tel: +86-10-62304633-2079 Fax: +86-10-62304633-2504  
E-mail: cttl@chinattl.com http://www.chinattl.cn

**Glossary:**

TSL	tissue simulating liquid
ConvF	sensitivity in TSL / NORM <sub>x,y,z</sub>
N/A	not applicable or not measured

**Calibration is Performed According to the Following Standards:**

- IEEE Std 1528-2013, "IEEE Recommended Practice for Determining the Peak Spatial-Averaged Specific Absorption Rate (SAR) in the Human Head from Wireless Communications Devices: Measurement Techniques", June 2013
- IEC 62209-1, "Measurement procedure for assessment of specific absorption rate of human exposure to radio frequency fields from hand-held and body-mounted wireless communication devices- Part 1: Device used next to the ear (Frequency range of 300MHz to 6GHz)", July 2016
- IEC 62209-2, "Procedure to measure the Specific Absorption Rate (SAR) For wireless communication devices used in close proximity to the human body (frequency range of 30MHz to 6GHz)", March 2010
- KDB865664, SAR Measurement Requirements for 100 MHz to 6 GHz

**Additional Documentation:**

- DASY4/5 System Handbook

**Methods Applied and Interpretation of Parameters:**

- Measurement Conditions:* Further details are available from the Validation Report at the end of the certificate. All figures stated in the certificate are valid at the frequency indicated.
- Antenna Parameters with TSL:* The dipole is mounted with the spacer to position its feed point exactly below the center marking of the flat phantom section, with the arms oriented parallel to the body axis.
- Feed Point Impedance and Return Loss:* These parameters are measured with the dipole positioned under the liquid filled phantom. The impedance stated is transformed from the measurement at the SMA connector to the feed point. The Return Loss ensures low reflected power. No uncertainty required.
- Electrical Delay:* One-way delay between the SMA connector and the antenna feed point. No uncertainty required.
- SAR measured:* SAR measured at the stated antenna input power.
- SAR normalized:* SAR as measured, normalized to an input power of 1 W at the antenna connector.
- SAR for nominal TSL parameters:* The measured TSL parameters are used to calculate the nominal SAR result.

The reported uncertainty of measurement is stated as the standard uncertainty of Measurement multiplied by the coverage factor  $k=2$ , which for a normal distribution Corresponds to a coverage probability of approximately 95%.



In Collaboration with  
**s p e a g**  
 CALIBRATION LABORATORY

Add: No.51 Xueyuan Road, Haidian District, Beijing, 100191, China  
 Tel: +86-10-62304633-2079 Fax: +86-10-62304633-2504  
 E-mail: cttl@chinattl.com http://www.chinattl.cn

### Measurement Conditions

DASY system configuration, as far as not given on page 1.

DASY Version	DASY52	52.10.1.1476
Extrapolation	Advanced Extrapolation	
Phantom	Triple Flat Phantom 5.1C	
Distance Dipole Center - TSL	10 mm	with Spacer
Zoom Scan Resolution	dx, dy, dz = 5 mm	
Frequency	2450 MHz ± 1 MHz	

### Head TSL parameters

The following parameters and calculations were applied.

	Temperature	Permittivity	Conductivity
Nominal Head TSL parameters	22.0 °C	39.2	1.80 mho/m
Measured Head TSL parameters	(22.0 ± 0.2) °C	38.8 ± 6 %	1.80 mho/m ± 6 %
Head TSL temperature change during test	<1.0 °C	----	----

### SAR result with Head TSL

SAR averaged over 1 cm <sup>3</sup> (1 g) of Head TSL	Condition	
SAR measured	250 mW input power	13.3 mW / g
SAR for nominal Head TSL parameters	normalized to 1W	53.1 mW /g ± 18.8 % (k=2)
SAR averaged over 10 cm <sup>3</sup> (10 g) of Head TSL	Condition	
SAR measured	250 mW input power	6.19 mW / g
SAR for nominal Head TSL parameters	normalized to 1W	24.7 mW /g ± 18.7 % (k=2)

### Body TSL parameters

The following parameters and calculations were applied.

	Temperature	Permittivity	Conductivity
Nominal Body TSL parameters	22.0 °C	52.7	1.95 mho/m
Measured Body TSL parameters	(22.0 ± 0.2) °C	52.3 ± 6 %	1.98 mho/m ± 6 %
Body TSL temperature change during test	<1.0 °C	----	----

### SAR result with Body TSL

SAR averaged over 1 cm <sup>3</sup> (1 g) of Body TSL	Condition	
SAR measured	250 mW input power	13.0 mW / g
SAR for nominal Body TSL parameters	normalized to 1W	51.5 mW /g ± 18.8 % (k=2)
SAR averaged over 10 cm <sup>3</sup> (10 g) of Body TSL	Condition	
SAR measured	250 mW input power	6.13 mW / g
SAR for nominal Body TSL parameters	normalized to 1W	24.4 mW /g ± 18.7 % (k=2)



In Collaboration with  
**s p e a g**  
CALIBRATION LABORATORY

Add: No.51 Xueyuan Road, Haidian District, Beijing, 100191, China  
Tel: +86-10-62304633-2079 Fax: +86-10-62304633-2504  
E-mail: cttl@chinattl.com http://www.chinattl.cn

#### Appendix (Additional assessments outside the scope of CNAS L0570)

##### Antenna Parameters with Head TSL

Impedance, transformed to feed point	53.4Ω+ 3.63jΩ
Return Loss	- 26.4dB

##### Antenna Parameters with Body TSL

Impedance, transformed to feed point	49.6Ω+ 5.36jΩ
Return Loss	- 25.4dB

##### General Antenna Parameters and Design

Electrical Delay (one direction)	1.027 ns
----------------------------------	----------

After long term use with 100W radiated power, only a slight warming of the dipole near the feedpoint can be measured.

The dipole is made of standard semirigid coaxial cable. The center conductor of the feeding line is directly connected to the second arm of the dipole. The antenna is therefore short-circuited for DC-signals. On some of the dipoles, small end caps are added to the dipole arms in order to improve matching when loaded according to the position as explained in the "Measurement Conditions" paragraph. The SAR data are not affected by this change. The overall dipole length is still according to the Standard. No excessive force must be applied to the dipole arms, because they might bend or the soldered connections near the feedpoint may be damaged.

##### Additional EUT Data

Manufactured by	SPEAG
-----------------	-------



In Collaboration with  
**s p e a g**  
CALIBRATION LABORATORY

Addr: No.51 Xueyuan Road, Haidian District, Beijing, 100191, China  
Tel: +86-10-62304633-2079 Fax: +86-10-62304633-2504  
E-mail: cttl@chinattl.com http://www.chinattl.cn

**DASY5 Validation Report for Head TSL**

Date: 08.31.2018

Test Laboratory: CTTL, Beijing, China

**DUT: Dipole 2450 MHz; Type: D2450V2; Serial: D2450V2 - SN: 818**

Communication System: UID 0, CW; Frequency: 2450 MHz; Duty Cycle: 1:1

Medium parameters used:  $f = 2450$  MHz;  $\sigma = 1.802$  S/m;  $\epsilon_r = 38.84$ ;  $\rho = 1000$  kg/m<sup>3</sup>

Phantom section: Right Section

DASY5 Configuration:

- Probe: EX3DV4 - SN7464; ConvF(7.89, 7.89, 7.89) @ 2450 MHz; Calibrated: 9/12/2017
- Sensor-Surface: 1.4mm (Mechanical Surface Detection)
- Electronics: DAE4 Sn1524; Calibrated: 9/13/2017
- Phantom: MFP\_V5.1C ; Type: QD 000 P51CA; Serial: 1062
- Measurement SW: DASY52, Version 52.10 (1); SEMCAD X Version 14.6.11 (7439)

**Dipole Calibration/Zoom Scan (7x7x7) (7x7x7)/Cube 0:** Measurement grid: dx=5mm, dy=5mm, dz=5mm

Reference Value = 100.2 V/m; Power Drift = 0.04 dB

Peak SAR (extrapolated) = 27.7 W/kg

SAR(1 g) = 13.3 W/kg; SAR(10 g) = 6.19 W/kg

Maximum value of SAR (measured) = 22.4 W/kg

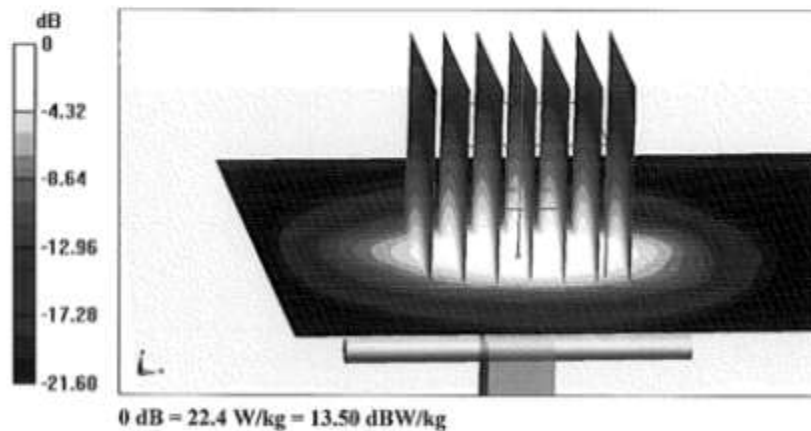



In Collaboration with  
**s p e a g**  
CALIBRATION LABORATORY

Add: No.51 Xueyuan Road, Haidian District, Beijing, 100191, China  
Tel: +86-10-62304633-2079 Fax: +86-10-62304633-2504  
E-mail: cttl@chinattl.com http://www.chinattl.cn

### Impedance Measurement Plot for Head TSL

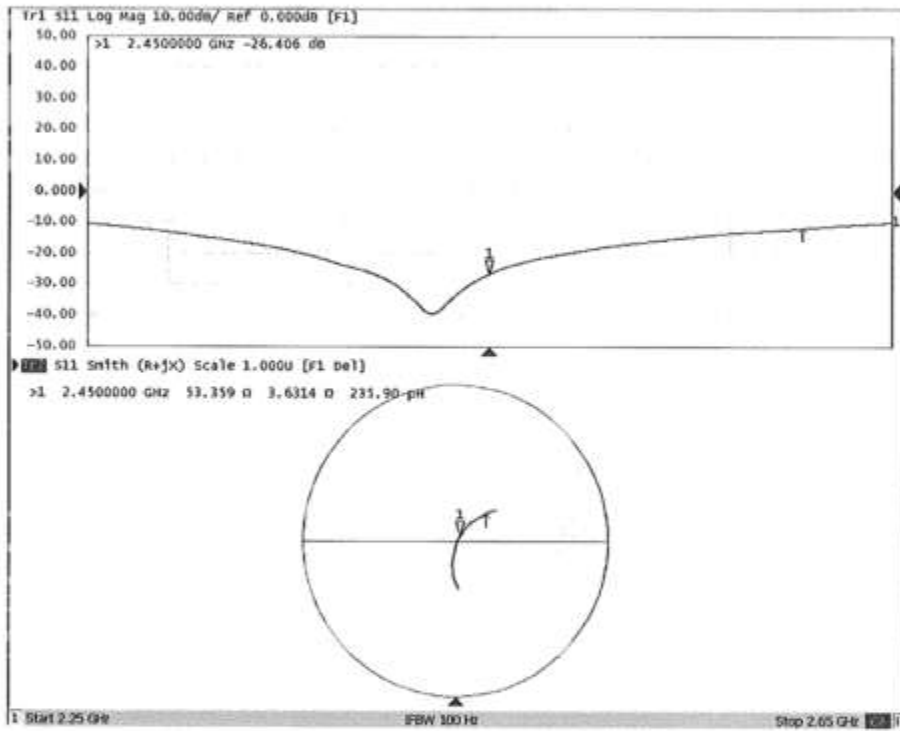



In Collaboration with  
**s p e a g**  
CALIBRATION LABORATORY

Add: No.51 Xueyuan Road, Haidian District, Beijing, 100191, China  
Tel: +86-10-62304633-2079 Fax: +86-10-62304633-2504  
E-mail: cttl@chinattl.com http://www.chinattl.cn

**DASY5 Validation Report for Body TSL**

Date: 08.30.2018

Test Laboratory: CTTL, Beijing, China

**DUT: Dipole 2450 MHz; Type: D2450V2; Serial: D2450V2 - SN: 818**

Communication System: UID 0, CW; Frequency: 2450 MHz; Duty Cycle: 1:1

Medium parameters used:  $f = 2450$  MHz;  $\sigma = 1.982$  S/m;  $\epsilon_r = 52.34$ ;  $\rho = 1000$  kg/m<sup>3</sup>

Phantom section: Center Section

DASY5 Configuration:

- Probe: EX3DV4 - SN7464; ConvF(8.09, 8.09, 8.09) @ 2450 MHz; Calibrated: 9/12/2017
- Sensor-Surface: 1.4mm (Mechanical Surface Detection)
- Electronics: DAE4 Sn1524; Calibrated: 9/13/2017
- Phantom: MFP\_V5.1C ; Type: QD 000 P51CA; Serial: 1062
- Measurement SW: DASY52, Version 52.10 (1); SEMCAD X Version 14.6.11 (7439)

**Dipole Calibration/Zoom Scan (7x7x7) (7x7x7)/Cube 0: Measurement grid: dx=5mm, dy=5mm, dz=5mm**

Reference Value = 98.69 V/m; Power Drift = -0.03 dB

Peak SAR (extrapolated) = 26.4 W/kg

**SAR(1 g) = 13 W/kg; SAR(10 g) = 6.13 W/kg**

Maximum value of SAR (measured) = 21.4 W/kg

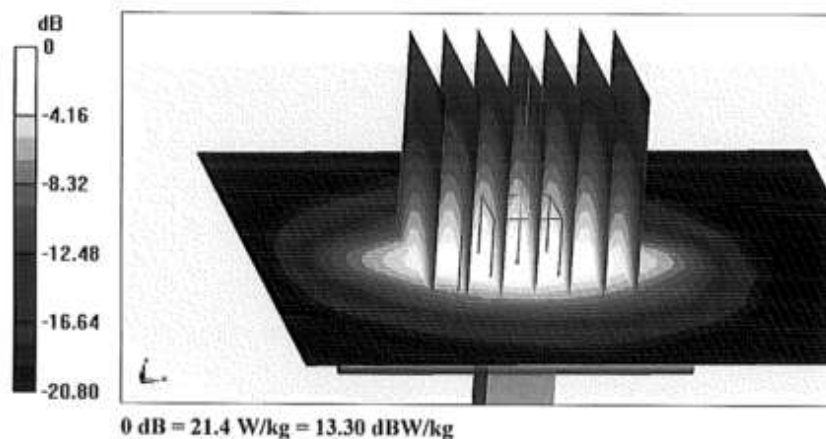





In Collaboration with  
**s p e a g**  
CALIBRATION LABORATORY

Add: No.51 Xueyuan Road, Haidian District, Beijing, 100191, China  
Tel: +86-10-62304633-2079 Fax: +86-10-62304633-2504  
E-mail: cttl@chinattl.com http://www.chinattl.cn

### Impedance Measurement Plot for Body TSL

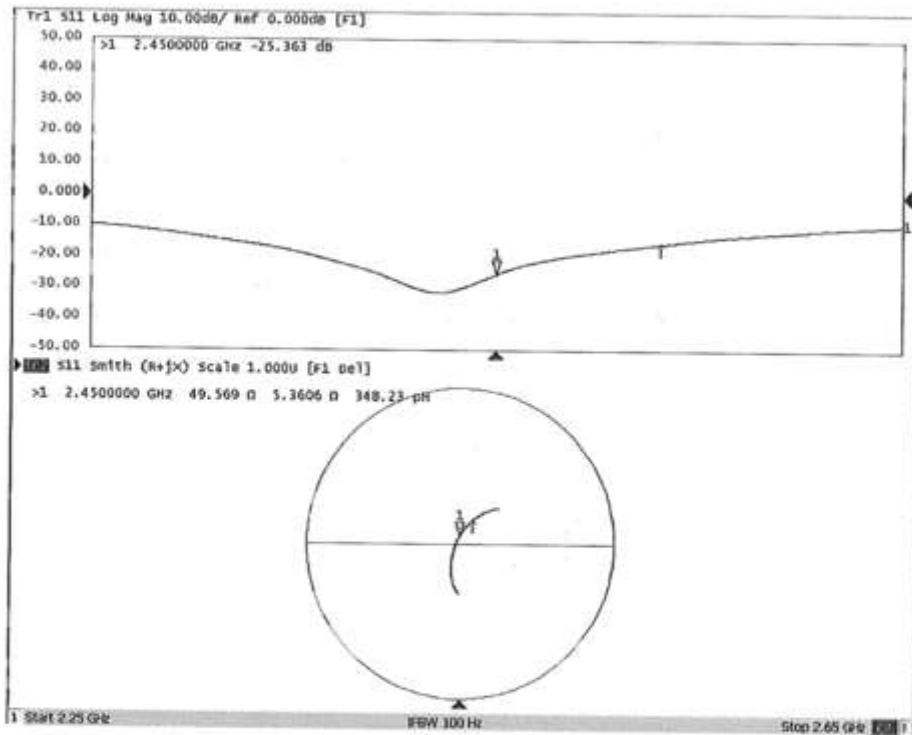



In Collaboration with  
**s p e a g**  
CALIBRATION LABORATORY



中国认可  
国际互认  
校准  
CALIBRATION  
CNAS L0570

Add: No.51 Xueyuan Road, Haidian District, Beijing, 100191, China  
Tel: +86-10-62304633-2079 Fax: +86-10-62304633-2504  
E-mail: cttl@chinattl.com http://www.chinattl.cn

Client **SMQ**

Certificate No: **Z20-60040**

## CALIBRATION CERTIFICATE

Object **D2600V2 - SN: 1074**

Calibration Procedure(s) **FF-Z11-003-01**  
**Calibration Procedures for dipole validation kits**

Calibration date: **January 2, 2020**

This calibration Certificate documents the traceability to national standards, which realize the physical units of measurements(SI). The measurements and the uncertainties with confidence probability are given on the following pages and are part of the certificate.

All calibrations have been conducted in the closed laboratory facility: environment temperature:(22±3)℃ and humidity<70%.

Calibration Equipment used (M&TE critical for calibration)

Primary Standards	ID #	Cal Date(Calibrated by, Certificate No.)	Scheduled Calibration
Power Meter NRP2	108276	11-Apr-19 (CTTL, No.J19X02605)	Apr-20
Power sensor NRP6A	101369	11-Apr-19 (CTTL, No.J19X02605)	Apr-20
Reference Probe EX3DV4	SN 3617	31-Jan-19(SPEAG,No.EX3-3617_Jan19)	Jan-20
DAE4	SN 1555	22-Aug-19(CTTL-SPEAG,No.Z19-60295)	Aug-20
Secondary Standards	ID #	Cal Date(Calibrated by, Certificate No.)	Scheduled Calibration
Signal Generator E4438C	MY49071430	23-Jan-19 (CTTL, No.J19X00336)	Jan-20
Network Analyzer E5071C	MY46110673	24-Jan-19 (CTTL, No.J19X00547)	Jan-20

	Name	Function	Signature
Calibrated by:	Zhao Jing	SAR Test Engineer	
Reviewed by:	Lin Hao	SAR Test Engineer	
Approved by:	Qi Dianyuan	SAR Project Leader	

Issued: January 8, 2020

This calibration certificate shall not be reproduced except in full without written approval of the laboratory.



In Collaboration with  
**s p e a g**  
CALIBRATION LABORATORY

Add: No.51 Xueyuan Road, Haidian District, Beijing, 100191, China  
Tel: +86-10-62304633-2079 Fax: +86-10-62304633-2504  
E-mail: cttf@chinattl.com http://www.chinattl.cn

#### Glossary:

TSL	tissue simulating liquid
ConvF	sensitivity in TSL / NORM <sub>x,y,z</sub>
N/A	not applicable or not measured

#### Calibration is Performed According to the Following Standards:

- IEEE Std 1528-2013, "IEEE Recommended Practice for Determining the Peak Spatial-Averaged Specific Absorption Rate (SAR) in the Human Head from Wireless Communications Devices; Measurement Techniques", June 2013
- IEC 62209-1, "Measurement procedure for assessment of specific absorption rate of human exposure to radio frequency fields from hand-held and body-mounted wireless communication devices- Part 1: Device used next to the ear (Frequency range of 300MHz to 6GHz)", July 2016
- IEC 62209-2, "Procedure to measure the Specific Absorption Rate (SAR) For wireless communication devices used in close proximity to the human body (frequency range of 30MHz to 6GHz)", March 2010
- KDB865664, SAR Measurement Requirements for 100 MHz to 6 GHz

#### Additional Documentation:

- DASY4/5 System Handbook

#### Methods Applied and Interpretation of Parameters:

- Measurement Conditions:** Further details are available from the Validation Report at the end of the certificate. All figures stated in the certificate are valid at the frequency indicated.
- Antenna Parameters with TSL:** The dipole is mounted with the spacer to position its feed point exactly below the center marking of the flat phantom section, with the arms oriented parallel to the body axis.
- Feed Point Impedance and Return Loss:** These parameters are measured with the dipole positioned under the liquid filled phantom. The impedance stated is transformed from the measurement at the SMA connector to the feed point. The Return Loss ensures low reflected power. No uncertainty required.
- Electrical Delay:** One-way delay between the SMA connector and the antenna feed point. No uncertainty required.
- SAR measured:** SAR measured at the stated antenna input power.
- SAR normalized:** SAR as measured, normalized to an input power of 1 W at the antenna connector.
- SAR for nominal TSL parameters:** The measured TSL parameters are used to calculate the nominal SAR result.

The reported uncertainty of measurement is stated as the standard uncertainty of Measurement multiplied by the coverage factor  $k=2$ , which for a normal distribution Corresponds to a coverage probability of approximately 95%.



In Collaboration with  
**s p e a g**  
 CALIBRATION LABORATORY

Add: No.51 Xueyuan Road, Haidian District, Beijing, 100191, China  
 Tel: +86-10-62304633-2079 Fax: +86-10-62304633-2504  
 E-mail: ctf@chinatl.com http://www.chinatl.cn

### Measurement Conditions

DASY system configuration, as far as not given on page 1.

DASY Version	DASY52	V52.10.3
Extrapolation	Advanced Extrapolation	
Phantom	Triple Flat Phantom 5.1C	
Distance Dipole Center - TSL	10 mm	with Spacer
Zoom Scan Resolution	dx, dy, dz = 5 mm	
Frequency	2600 MHz ± 1 MHz	

### Head TSL parameters

The following parameters and calculations were applied.

	Temperature	Permittivity	Conductivity
Nominal Head TSL parameters	22.0 °C	39.0	1.96 mho/m
Measured Head TSL parameters	(22.0 ± 0.2) °C	38.5 ± 6 %	1.94 mho/m ± 6 %
Head TSL temperature change during test	<1.0 °C	---	---

### SAR result with Head TSL

SAR averaged over 1 $cm^3$ (1 g) of Head TSL	Condition	
SAR measured	250 mW input power	14.2 W/kg
SAR for nominal Head TSL parameters	normalized to 1W	56.9 W/kg ± 18.8 % (k=2)
SAR averaged over 10 $cm^3$ (10 g) of Head TSL	Condition	
SAR measured	250 mW input power	6.29 W/kg
SAR for nominal Head TSL parameters	normalized to 1W	25.2 W/kg ± 18.7 % (k=2)

### Body TSL parameters

The following parameters and calculations were applied.

	Temperature	Permittivity	Conductivity
Nominal Body TSL parameters	22.0 °C	52.5	2.16 mho/m
Measured Body TSL parameters	(22.0 ± 0.2) °C	52.7 ± 6 %	2.15 mho/m ± 6 %
Body TSL temperature change during test	<1.0 °C	---	---

### SAR result with Body TSL

SAR averaged over 1 $cm^3$ (1 g) of Body TSL	Condition	
SAR measured	250 mW input power	13.6 W/kg
SAR for nominal Body TSL parameters	normalized to 1W	54.6 W/kg ± 18.8 % (k=2)
SAR averaged over 10 $cm^3$ (10 g) of Body TSL	Condition	
SAR measured	250 mW input power	6.02 W/kg
SAR for nominal Body TSL parameters	normalized to 1W	24.1 W/kg ± 18.7 % (k=2)



In Collaboration with  
**s p e a g**  
CALIBRATION LABORATORY

Add: No.51 Xueyuan Road, Haidian District, Beijing, 100191, China  
Tel: +86-10-62304633-2079 Fax: +86-10-62304633-2504  
E-mail: cttl@chinattl.com http://www.chinattl.cn

**Appendix(Additional assessments outside the scope of CNAS L0570)**

**Antenna Parameters with Head TSL**

Impedance, transformed to feed point	49.1 $\Omega$ - 6.89j $\Omega$
Return Loss	- 23.1dB

**Antenna Parameters with Body TSL**

Impedance, transformed to feed point	46.2 $\Omega$ - 5.65j $\Omega$
Return Loss	- 23.0dB

**General Antenna Parameters and Design**

Electrical Delay (one direction)	1.012 ns
----------------------------------	----------

After long term use with 100W radiated power, only a slight warming of the dipole near the feedpoint can be measured.

The dipole is made of standard semirigid coaxial cable. The center conductor of the feeding line is directly connected to the second arm of the dipole. The antenna is therefore short-circuited for DC-signals. On some of the dipoles, small end caps are added to the dipole arms in order to improve matching when loaded according to the position as explained in the "Measurement Conditions" paragraph. The SAR data are not affected by this change. The overall dipole length is still according to the Standard. No excessive force must be applied to the dipole arms, because they might bend or the soldered connections near the feedpoint may be damaged.

**Additional EUT Data**

Manufactured by	SPEAG
-----------------	-------



In Collaboration with  
**s p e a g**  
CALIBRATION LABORATORY

Add: No.51 Xueyuan Road, Haidian District, Beijing, 100191, China  
Tel: +86-10-62304633-2079 Fax: +86-10-62304633-2504  
E-mail: cttl@chinattl.com http://www.chinattl.cn

**DASY5 Validation Report for Head TSL**

Date: 01.02.2020

Test Laboratory: CTTL, Beijing, China

**DUT: Dipole 2600 MHz; Type: D2600V2; Serial: D2600V2 - SN: 1074**

Communication System: UID 0, CW; Frequency: 2600 MHz; Duty Cycle: 1:1

Medium parameters used:  $f = 2600$  MHz;  $\sigma = 1.943$  S/m;  $\epsilon_r = 38.52$ ;  $\rho = 1000$  kg/m<sup>3</sup>

Phantom section: Center Section

DASY5 Configuration:

- Probe: EX3DV4 - SN3617; ConvF(7.19, 7.19, 7.19) @ 2600 MHz; Calibrated: 1/31/2019
- Sensor-Surface: 1.4mm (Mechanical Surface Detection)
- Electronics: DAE4 Sn1555; Calibrated: 8/22/2019
- Phantom: MFP\_V5.1C ; Type: QD 000 P51CA; Serial: 1062
- Measurement SW: DASY52, Version 52.10 (3); SEMCAD X Version 14.6.13 (7474)

**Dipole Calibration/Zoom Scan (7x7x7) (7x7x7)/Cube 0: Measurement grid: dx=5mm, dy=5mm, dz=5mm**

Reference Value = 103.8 V/m; Power Drift = 0.04 dB

Peak SAR (extrapolated) = 30.9 W/kg

**SAR(1 g) = 14.2 W/kg; SAR(10 g) = 6.29 W/kg**

Smallest distance from peaks to all points 3 dB below = 9 mm

Ratio of SAR at M2 to SAR at M1 = 46.4%

Maximum value of SAR (measured) = 24.4 W/kg

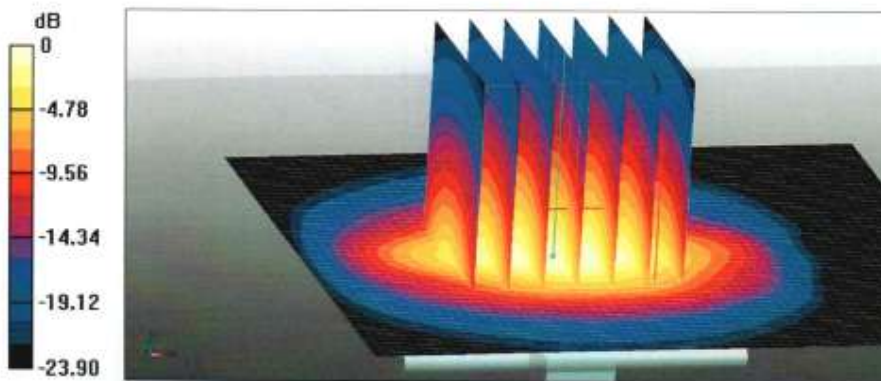

0 dB = 24.4 W/kg = 13.87 dBW/kg



In Collaboration with  
**s p e a g**  
CALIBRATION LABORATORY

Add: No.51 Xueyuan Road, Haidian District, Beijing, 100191, China  
Tel: +86-10-62304633-2079 Fax: +86-10-62304633-2504  
E-mail: cttl@chinattl.com http://www.chinattl.cn

### Impedance Measurement Plot for Head TSL

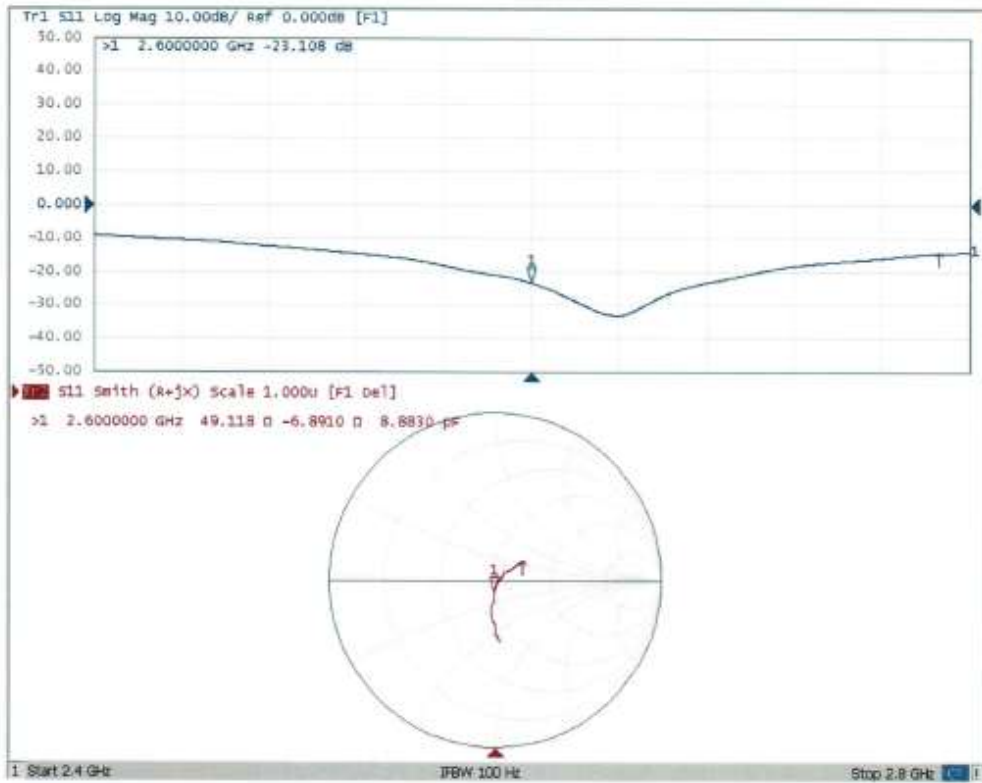



In Collaboration with  
**s p e a g**  
CALIBRATION LABORATORY

Add: No.51 Xueyuan Road, Haidian District, Beijing, 100191, China  
Tel: +86-10-62304633-2079 Fax: +86-10-62304633-2504  
E-mail: cttl@chinattl.com http://www.chinattl.cn

**DASY5 Validation Report for Body TSL**

Date: 01.02.2020

Test Laboratory: CTTL, Beijing, China

**DUT: Dipole 2600 MHz; Type: D2600V2; Serial: D2600V2 - SN: 1074**

Communication System: UID 0, CW; Frequency: 2600 MHz; Duty Cycle: 1:1

Medium parameters used:  $f = 2600$  MHz;  $\sigma = 2.145$  S/m;  $\epsilon_r = 52.74$ ;  $\rho = 1000$  kg/m<sup>3</sup>

Phantom section: Right Section

DASY5 Configuration:

- Probe: EX3DV4 - SN3617; ConvF(7.49, 7.49, 7.49) @ 2600 MHz; Calibrated: 1/31/2019
- Sensor-Surface: 1.4mm (Mechanical Surface Detection)
- Electronics: DAE4 Sn1555; Calibrated: 8/22/2019
- Phantom: MFP\_V5.1C ; Type: QD 000 P51CA; Serial: 1062
- Measurement SW: DASY52, Version 52.10 (3); SEMCAD X Version 14.6.13 (7474)

**Dipole Calibration/Zoom Scan (7x7x7) (7x7x7)/Cube 0: Measurement grid: dx=5mm, dy=5mm, dz=5mm**

Reference Value = 95.00 V/m; Power Drift = 0.05 dB

Peak SAR (extrapolated) = 29.4 W/kg

**SAR(1 g) = 13.6 W/kg; SAR(10 g) = 6.02 W/kg**

Smallest distance from peaks to all points 3 dB below = 8 mm

Ratio of SAR at M2 to SAR at M1 = 47.2%

Maximum value of SAR (measured) = 23.4 W/kg

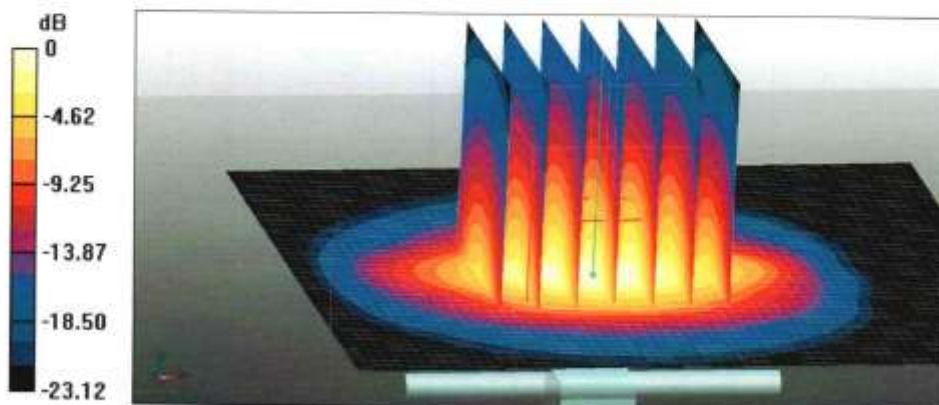

0 dB = 23.4 W/kg = 13.69 dBW/kg





In Collaboration with  
**s p e a g**  
CALIBRATION LABORATORY

Add: No.51 Xueyuan Road, Haidian District, Beijing, 100191, China  
Tel: +86-10-62304633-2079 Fax: +86-10-62304633-2504  
E-mail: [cttl@chinattl.com](mailto:cttl@chinattl.com) <http://www.chinattl.cn>

### Impedance Measurement Plot for Body TSL

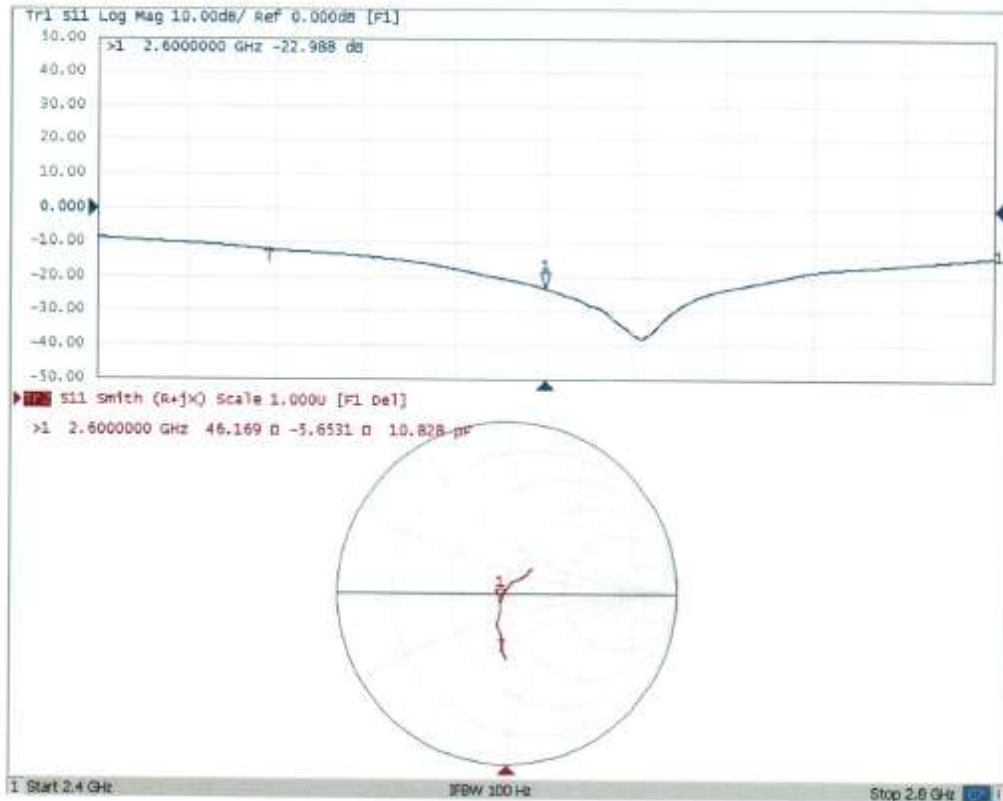



In Collaboration with  
 Add: No.51 Xueyuan Road, Haidian District, Beijing, 100191, China  
 Tel: +86-10-62304633-2512 Fax: +86-10-62304633-2504  
 E-mail: ctli@chinattl.com http://www.chinattl.cn



中国认可  
 国际互认  
 校准  
 CALIBRATION  
 CNAS L0570

Client **SMQ**

Certificate No: **Z20-60041**

### CALIBRATION CERTIFICATE

Object: D5GHzV2 - SN: 1185  
 Calibration Procedure(s): FF-Z11-003-01  
 Calibration Procedures for dipole validation kits  
 Calibration date: December 31, 2019

This calibration Certificate documents the traceability to national standards, which realize the physical units of measurements(SI). The measurements and the uncertainties with confidence probability are given on the following pages and are part of the certificate.

All calibrations have been conducted in the closed laboratory facility; environment temperature(22±3)°C and humidity<70%.

Calibration Equipment used (M&TE critical for calibration)

Primary Standards	ID #	Cal Date(Calibrated by, Certificate No.)	Scheduled Calibration
Power Meter NRP2	106276	11-Apr-19 (CTTL, No.J19X02605)	Apr-20
Power sensor NRP6A	101369	11-Apr-19 (CTTL, No.J19X02605)	Apr-20
ReferenceProbe EX3DV4	SN 3617	31-Jan-19(SPEAG,No.EX3-3617_Jan19)	Jan-20
DAE4	SN 1555	22-Aug-19(CTTL-SPEAG,No.Z19-60295)	Aug-20

Secondary Standards	ID #	Cal Date(Calibrated by, Certificate No.)	Scheduled Calibration
Signal Generator E4438C	MY49071430	23-Jan-19 (CTTL, No.J19X00336)	Jan-20
NetworkAnalyzerE5071C	MY46110673	24-Jan-19 (CTTL, No.J19X00547)	Jan-20

	Name	Function	Signature
Calibrated by:	Zhao Jing	SAR Test Engineer	
Reviewed by:	Lin Hao	SAR Test Engineer	
Approved by:	Qi Dianyuan	SAR Project Leader	

Issued: January 7, 2019

This calibration certificate shall not be reproduced except in full without written approval of the laboratory.



Add: No.51 Xueyuan Road, Haidian District, Beijing, 100191, China  
Tel: +86-10-62304633-2512 Fax: +86-10-62304633-2504  
E-mail: cntl@chinattl.com http://www.chinattl.cn

**Glossary:**

TSL	tissue simulating liquid
ConvF	sensitivity in TSL / NORM <sub>x,y,z</sub>
N/A	not applicable or not measured

**Calibration is Performed According to the Following Standards:**

- IEEE Std 1528-2013, "IEEE Recommended Practice for Determining the Peak Spatial-Averaged Specific Absorption Rate (SAR) in the Human Head from Wireless Communications Devices: Measurement Techniques", June 2013
- IEC 62209-1, "Measurement procedure for assessment of specific absorption rate of human exposure to radio frequency fields from hand-held and body-mounted wireless communication devices- Part 1: Device used next to the ear (Frequency range of 300MHz to 6GHz)", July 2016
- IEC 62209-2, "Procedure to measure the Specific Absorption Rate (SAR) For wireless communication devices used in close proximity to the human body (frequency range of 30MHz to 6GHz)", March 2010
- KDB865664, SAR Measurement Requirements for 100 MHz to 6 GHz

**Additional Documentation:**

- DASY4/5 System Handbook

**Methods Applied and Interpretation of Parameters:**

- Measurement Conditions:* Further details are available from the Validation Report at the end of the certificate. All figures stated in the certificate are valid at the frequency indicated.
- Antenna Parameters with TSL:* The dipole is mounted with the spacer to position its feed point exactly below the center marking of the flat phantom section, with the arms oriented parallel to the body axis.
- Feed Point Impedance and Return Loss:* These parameters are measured with the dipole positioned under the liquid filled phantom. The impedance stated is transformed from the measurement at the SMA connector to the feed point. The Return Loss ensures low reflected power. No uncertainty required.
- Electrical Delay:* One-way delay between the SMA connector and the antenna feed point. No uncertainty required.
- SAR measured:* SAR measured at the stated antenna input power.
- SAR normalized:* SAR as measured, normalized to an input power of 1 W at the antenna connector.
- SAR for nominal TSL parameters:* The measured TSL parameters are used to calculate the nominal SAR result.

The reported uncertainty of measurement is stated as the standard uncertainty of Measurement multiplied by the coverage factor  $k=2$ , which for a normal distribution Corresponds to a coverage probability of approximately 95%.

### Measurement Conditions

DASY system configuration, as far as not given on page 1.

<b>DASY Version</b>	DASY52	V52.10.3
<b>Extrapolation</b>	Advanced Extrapolation	
<b>Phantom</b>	Triple Flat Phantom 5.1C	
<b>Distance Dipole Center - TSL</b>	10 mm	with Spacer
<b>Zoom Scan Resolution</b>	dx, dy = 4 mm, dz = 1.4 mm	Graded Ratio = 1.4 (Z direction)
<b>Frequency</b>	5250 MHz ± 1 MHz 5600 MHz ± 1 MHz 5750 MHz ± 1 MHz	

### Head TSL parameters at 5250 MHz

The following parameters and calculations were applied.

	Temperature	Permittivity	Conductivity
<b>Nominal Head TSL parameters</b>	22.0 °C	35.9	4.71 mho/m
<b>Measured Head TSL parameters</b>	(22.0 ± 0.2) °C	36.8 ± 6 %	4.65 mho/m ± 6 %
<b>Head TSL temperature change during test</b>	<1.0 °C	---	---

### SAR result with Head TSL at 5250 MHz

<b>SAR averaged over 1 cm<sup>3</sup> (1 g) of Head TSL</b>	Condition	
SAR measured	100 mW input power	7.61 W/kg
SAR for nominal Head TSL parameters	normalized to 1W	<b>76.5 W/kg ± 24.4 % (k=2)</b>
<b>SAR averaged over 10 cm<sup>3</sup> (10 g) of Head TSL</b>	Condition	
SAR measured	100 mW input power	2.17 W/kg
SAR for nominal Head TSL parameters	normalized to 1W	<b>21.8 W/kg ± 24.2 % (k=2)</b>

### Head TSL parameters at 5600 MHz

The following parameters and calculations were applied.

	Temperature	Permittivity	Conductivity
Nominal Head TSL parameters	22.0 °C	35.5	5.07 mho/m
Measured Head TSL parameters	(22.0 ± 0.2) °C	36.2 ± 6 %	5.03 mho/m ± 6 %
Head TSL temperature change during test	<1.0 °C	----	----

### SAR result with Head TSL at 5600 MHz

SAR averaged over 1 cm <sup>3</sup> (1 g) of Head TSL	Condition	
SAR measured	100 mW input power	7.99 W/kg
SAR for nominal Head TSL parameters	normalized to 1W	80.2 W/kg ± 24.4 % (k=2)
SAR averaged over 10 cm <sup>3</sup> (10 g) of Head TSL	Condition	
SAR measured	100 mW input power	2.27 W/kg
SAR for nominal Head TSL parameters	normalized to 1W	22.8 W/kg ± 24.2 % (k=2)

### Head TSL parameters at 5750 MHz

The following parameters and calculations were applied.

	Temperature	Permittivity	Conductivity
Nominal Head TSL parameters	22.0 °C	35.4	5.22 mho/m
Measured Head TSL parameters	(22.0 ± 0.2) °C	36.0 ± 6 %	5.19 mho/m ± 6 %
Head TSL temperature change during test	<1.0 °C	----	----

### SAR result with Head TSL at 5750 MHz

SAR averaged over 1 cm <sup>3</sup> (1 g) of Head TSL	Condition	
SAR measured	100 mW input power	7.80 W/kg
SAR for nominal Head TSL parameters	normalized to 1W	78.2 W/kg ± 24.4 % (k=2)
SAR averaged over 10 cm <sup>3</sup> (10 g) of Head TSL	Condition	
SAR measured	100 mW input power	2.21 W/kg
SAR for nominal Head TSL parameters	normalized to 1W	22.2 W/kg ± 24.2 % (k=2)

### Body TSL parameters at 5250 MHz

The following parameters and calculations were applied.

	Temperature	Permittivity	Conductivity
Nominal Body TSL parameters	22.0 °C	48.9	5.36 mho/m
Measured Body TSL parameters	(22.0 ± 0.2) °C	48.7 ± 6 %	5.32 mho/m ± 6 %
Body TSL temperature change during test	<1.0 °C	----	----

### SAR result with Body TSL at 5250 MHz

SAR averaged over 1 $cm^3$ (1 g) of Body TSL	Condition	
SAR measured	100 mW input power	7.43 W/kg
SAR for nominal Body TSL parameters	normalized to 1W	74.2 W/kg ± 24.4 % (k=2)
SAR averaged over 10 $cm^3$ (10 g) of Body TSL	Condition	
SAR measured	100 mW input power	2.08 W/kg
SAR for nominal Body TSL parameters	normalized to 1W	20.8 W/kg ± 24.2 % (k=2)

### Body TSL parameters at 5600 MHz

The following parameters and calculations were applied.

	Temperature	Permittivity	Conductivity
Nominal Body TSL parameters	22.0 °C	48.5	5.77 mho/m
Measured Body TSL parameters	(22.0 ± 0.2) °C	48.0 ± 6 %	5.79 mho/m ± 6 %
Body TSL temperature change during test	<1.0 °C	----	----

### SAR result with Body TSL at 5600 MHz

SAR averaged over 1 $cm^3$ (1 g) of Body TSL	Condition	
SAR measured	100 mW input power	7.70 W/kg
SAR for nominal Body TSL parameters	normalized to 1W	76.9 W/kg ± 24.4 % (k=2)
SAR averaged over 10 $cm^3$ (10 g) of Body TSL	Condition	
SAR measured	100 mW input power	2.17 W/kg
SAR for nominal Body TSL parameters	normalized to 1W	21.7 W/kg ± 24.2 % (k=2)



In Collaboration with  
**s p e a g**  
CALIBRATION LABORATORY

Add: No.51 Xueyuan Road, Haidian District, Beijing, 100191, China.  
Tel: +86-10-62304633-2512 Fax: +86-10-62304633-2504  
E-mail: cttl@chinattl.com http://www.chinattl.cn

### Body TSL parameters at 5750 MHz

The following parameters and calculations were applied.

	Temperature	Permittivity	Conductivity
<b>Nominal Body TSL parameters</b>	22.0 °C	48.3	5.94 mho/m
<b>Measured Body TSL parameters</b>	(22.0 ± 0.2) °C	47.7 ± 6 %	6.02 mho/m ± 6 %
<b>Body TSL temperature change during test</b>	<1.0 °C	---	---

### SAR result with Body TSL at 5750 MHz

<b>SAR averaged over 1 cm<sup>3</sup> (1 g) of Body TSL</b>	Condition	
SAR measured	100 mW input power	7.30 W/kg
SAR for nominal Body TSL parameters	normalized to 1W	<b>72.9 W/kg ± 24.4 % (k=2)</b>
<b>SAR averaged over 10 cm<sup>3</sup> (10 g) of Body TSL</b>	Condition	
SAR measured	100 mW input power	2.03 W/kg
SAR for nominal Body TSL parameters	normalized to 1W	<b>20.2 W/kg ± 24.2 % (k=2)</b>



In Collaboration with  
**s p e a g**  
CALIBRATION LABORATORY

Add: No.51 Xueyuan Road, Haidian District, Beijing, 100191, China  
Tel: +86-10-62304633-2512 Fax: +86-10-62304633-2504  
E-mail: cttl@chinattl.com http://www.chinattl.cn

### Appendix (Additional assessments outside the scope of CNAS L0570)

#### Antenna Parameters with Head TSL at 5250 MHz

Impedance, transformed to feed point	49.3Ω - 5.08jΩ
Return Loss	- 25.8dB

#### Antenna Parameters with Head TSL at 5600 MHz

Impedance, transformed to feed point	55.2Ω - 2.17jΩ
Return Loss	- 25.5dB

#### Antenna Parameters with Head TSL at 5750 MHz

Impedance, transformed to feed point	55.6Ω - 0.52jΩ
Return Loss	- 25.5dB

#### Antenna Parameters with Body TSL at 5250 MHz

Impedance, transformed to feed point	49.3Ω - 3.89jΩ
Return Loss	- 26.0dB

#### Antenna Parameters with Body TSL at 5600 MHz

Impedance, transformed to feed point	53.9Ω - 2.71jΩ
Return Loss	- 26.7dB

#### Antenna Parameters with Body TSL at 5750 MHz

Impedance, transformed to feed point	55.8Ω - 2.17jΩ
Return Loss	- 24.7dB





Add: No.51 Xueyuan Road, Haidian District, Beijing, 100191, China  
Tel: +86-10-62304633-2512 Fax: +86-10-62304633-2504  
E-mail: cntl@chinattl.com http://www.chinattl.cn

### General Antenna Parameters and Design

Electrical Delay (one direction)	1.066 ns
----------------------------------	----------

After long term use with 100W radiated power, only a slight warming of the dipole near the feedpoint can be measured.

The dipole is made of standard semirigid coaxial cable. The center conductor of the feeding line is directly connected to the second arm of the dipole. The antenna is therefore short-circuited for DC-signals. On some of the dipoles, small end caps are added to the dipole arms in order to improve matching when loaded according to the position as explained in the "Measurement Conditions" paragraph. The SAR data are not affected by this change. The overall dipole length is still according to the Standard. No excessive force must be applied to the dipole arms, because they might bend or the soldered connections near the feedpoint may be damaged.

### Additional EUT Data

Manufactured by	SPEAG
-----------------	-------



In Collaboration with  
**s p e a g**  
**CALIBRATION LABORATORY**

Add: No.51 Xueyuan Road, Haidian District, Beijing, 100191, China  
Tel: +86-10-62304633-2512 Fax: +86-10-62304633-2504  
E-mail: cttl@chinattl.com http://www.chinattl.cn

**DASY5 Validation Report for Head TSL**

Date: 12.31.2019

Test Laboratory: CTTL, Beijing, China

**DUT: Dipole 5GHz; Type: D5GHzV2; Serial: D5GHzV2 - SN: 1185**

Communication System: CW; Frequency: 5250 MHz, Frequency: 5600 MHz,  
Frequency: 5750 MHz,

Medium parameters used:  $f = 5250$  MHz;  $\sigma = 4.652$  S/m;  $\epsilon_r = 36.81$ ;  $\rho = 1000$  kg/m<sup>3</sup>,  
Medium parameters used:  $f = 5600$  MHz;  $\sigma = 5.027$  S/m;  $\epsilon_r = 36.19$ ;  $\rho = 1000$  kg/m<sup>3</sup>,  
Medium parameters used:  $f = 5750$  MHz;  $\sigma = 5.19$  S/m;  $\epsilon_r = 35.96$ ;  $\rho = 1000$  kg/m<sup>3</sup>,

Phantom section: Center Section

**DASY5 Configuration:**

- Probe: EX3DV4 - SN3617; ConvF(5.39, 5.39, 5.39) @ 5250 MHz; ConvF(5.06, 5.06, 5.06) @ 5600 MHz; ConvF(5.07, 5.07, 5.07) @ 5750 MHz; Calibrated: 1/31/2019
- Sensor-Surface: 1.4mm (Mechanical Surface Detection)
- Electronics: DAE4 Sn1555; Calibrated: 8/22/2019
- Phantom: MFP\_V5.1C ; Type: QD 000 P51CA; Serial: 1062
- Measurement SW: DASY52, Version 52.10 (3); SEMCAD X Version 14.6.13 (7474)

**Dipole Calibration /Pin=100mW, d=10mm, f=5250 MHz/Zoom Scan,**

**dist=1.4mm (8x8x7)/Cube 0:** Measurement grid: dx=4mm, dy=4mm, dz=1.4mm

Reference Value = 64.41 V/m; Power Drift = -0.02 dB

Peak SAR (extrapolated) = 31.5 W/kg

**SAR(1 g) = 7.61 W/kg; SAR(10 g) = 2.17 W/kg**

Smallest distance from peaks to all points 3 dB below = 7.2 mm

Ratio of SAR at M2 to SAR at M1 = 65.3%

Maximum value of SAR (measured) = 18.1 W/kg

**Dipole Calibration /Pin=100mW, d=10mm, f=5600 MHz/Zoom Scan,**

**dist=1.4mm (8x8x7)/Cube 0:** Measurement grid: dx=4mm, dy=4mm, dz=1.4mm

Reference Value = 64.02 V/m; Power Drift = -0.01 dB

Peak SAR (extrapolated) = 36.2 W/kg

**SAR(1 g) = 7.99 W/kg; SAR(10 g) = 2.27 W/kg**

Smallest distance from peaks to all points 3 dB below = 7.4 mm

Ratio of SAR at M2 to SAR at M1 = 62.7%

Maximum value of SAR (measured) = 19.5 W/kg



In Collaboration with  
**s p e a k**  
CALIBRATION LABORATORY

Add: No.51 Xueyuan Road, Haidian District, Beijing, 100191, China  
Tel: +86-10-62304633-2512 Fax: +86-10-62304633-2504  
E-mail: cttl@chinattf.com http://www.chinattf.cn

**Dipole Calibration /Pin=100mW, d=10mm, f=5750 MHz/Zoom Scan,  
dist=1.4mm (8x8x7)/Cube 0: Measurement grid: dx=4mm, dy=4mm, dz=1.4mm  
Reference Value = 63.14 V/m; Power Drift = 0.01 dB  
Peak SAR (extrapolated) = 36.9 W/kg  
SAR(1 g) = 7.8 W/kg; SAR(10 g) = 2.21 W/kg  
Smallest distance from peaks to all points 3 dB below = 7.5 mm  
Ratio of SAR at M2 to SAR at M1 = 59.5%  
Maximum value of SAR (measured) = 19.3 W/kg**

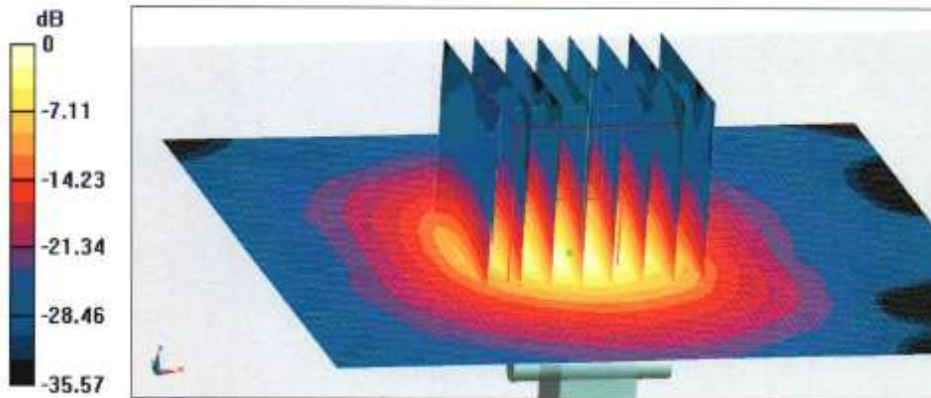

0 dB = 19.3 W/kg = 12.86 dBW/kg



In Collaboration with  
**s p e a g**  
CALIBRATION LABORATORY

Add: No.51 Xueyuan Road, Haidian District, Beijing, 100191, China  
Tel: +86-10-62304633-2512 Fax: +86-10-62304633-2504  
E-mail: cttl@chinatl.com http://www.chinatl.cn

### Impedance Measurement Plot for Head TSL

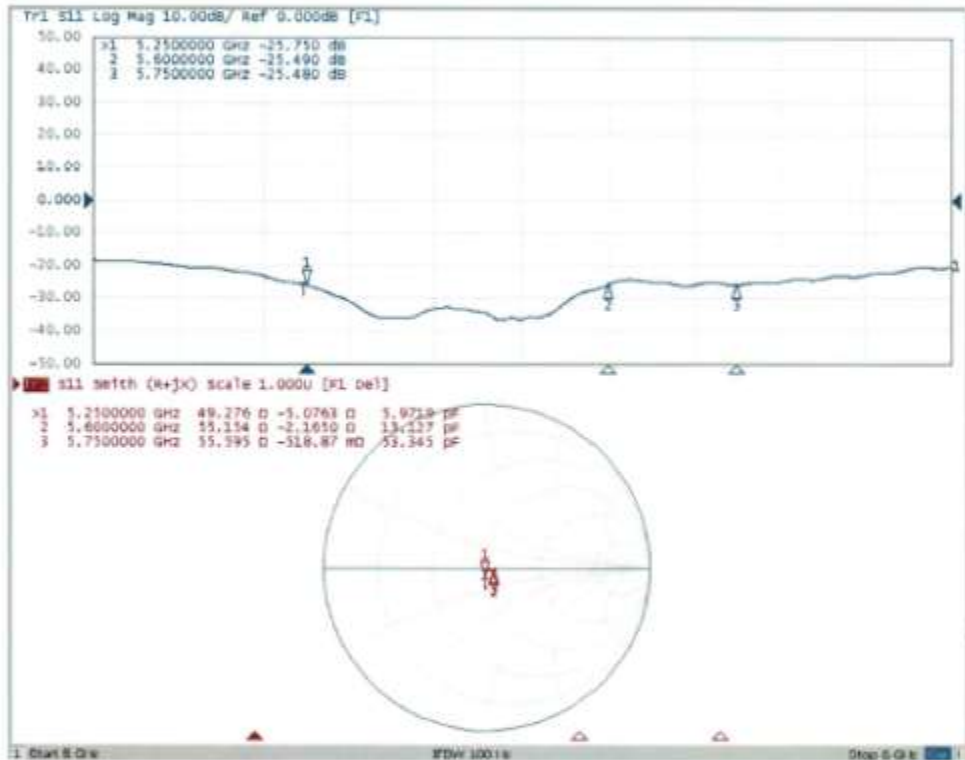



In Collaboration with  
**s p e a g**  
CALIBRATION LABORATORY

Add: No.51 Xueyuan Road, Haidian District, Beijing, 100191, China  
Tel: +86-10-62304633-2512 Fax: +86-10-62304633-2504  
E-mail: cttl@chinattl.com http://www.chinattl.cn

## DASY5 Validation Report for Body TSL

Date: 12.30.2019

Test Laboratory: CTTL, Beijing, China

**DUT: Dipole 5GHz; Type: D5GHzV2; Serial: D5GHzV2 - SN: 1185**

Communication System: CW; Frequency: 5250 MHz, Frequency: 5600 MHz,  
Frequency: 5750 MHz,

Medium parameters used:  $f = 5250$  MHz;  $\sigma = 5.317$  S/m;  $\epsilon_r = 48.69$ ;  $\rho = 1000$  kg/m<sup>3</sup>,  
Medium parameters used:  $f = 5600$  MHz;  $\sigma = 5.79$  S/m;  $\epsilon_r = 48.02$ ;  $\rho = 1000$  kg/m<sup>3</sup>,  
Medium parameters used:  $f = 5750$  MHz;  $\sigma = 6.019$  S/m;  $\epsilon_r = 47.69$ ;  $\rho = 1000$  kg/m<sup>3</sup>,

Phantom section: Right Section

### DASY5 Configuration:

- Probe: SN3617; ConvF(4.76, 4.76, 4.76) @ 5250 MHz; ConvF(4.23, 4.23, 4.23) @ 5600 MHz; ConvF(4.36, 4.36, 4.36) @ 5750 MHz; Calibrated: 1/31/2019,
- Sensor-Surface: 1.4mm (Mechanical Surface Detection)
- Electronics: DAE4 Sn1555; Calibrated: 8/22/2019
- Phantom: MFP\_V5.1C ; Type: QD 000 P51CA; Serial: 1062
- Measurement SW: DASY52, Version 52.10 (3); SEMCAD X Version 14.6.13 (7474)

### Dipole Calibration /Pin=100mW, d=10mm, f=5250 MHz/Zoom Scan,

dist=1.4mm (8x8x7)/Cube 0: Measurement grid: dx=4mm, dy=4mm, dz=1.4mm

Reference Value = 66.27 V/m; Power Drift = -0.04 dB

Peak SAR (extrapolated) = 29.5 W/kg

**SAR(1 g) = 7.43 W/kg; SAR(10 g) = 2.08 W/kg**

Smallest distance from peaks to all points 3 dB below = 7.2 mm

Ratio of SAR at M2 to SAR at M1 = 65.1%

Maximum value of SAR (measured) = 17.5 W/kg

### Dipole Calibration /Pin=100mW, d=10mm, f=5600 MHz/Zoom Scan,

dist=1.4mm (8x8x7)/Cube 0: Measurement grid: dx=4mm, dy=4mm, dz=1.4mm

Reference Value = 66.02 V/m; Power Drift = -0.01 dB

Peak SAR (extrapolated) = 34.0 W/kg

**SAR(1 g) = 7.7 W/kg; SAR(10 g) = 2.17 W/kg**

Smallest distance from peaks to all points 3 dB below = 7.2 mm

Ratio of SAR at M2 to SAR at M1 = 61.7%

Maximum value of SAR (measured) = 18.8 W/kg



In Collaboration with  
**s p e a g**  
CALIBRATION LABORATORY

Add: No.51 Xueyuan Road, Haidian District, Beijing, 100191, China  
Tel: +86-10-62304633-2512 Fax: +86-10-62304633-2504  
E-mail: cttl@chinattl.com http://www.chinattl.cn

**Dipole Calibration /Pin=100mW, d=10mm, f=5750 MHz/Zoom Scan,**  
**dist=1.4mm (8x8x7)/Cube 0:** Measurement grid: dx=4mm, dy=4mm, dz=1.4mm  
Reference Value = 63.40 V/m; Power Drift = -0.01 dB  
Peak SAR (extrapolated) = 34.0 W/kg  
**SAR(1 g) = 7.3 W/kg; SAR(10 g) = 2.03 W/kg**  
Smallest distance from peaks to all points 3 dB below = 7.4 mm  
Ratio of SAR at M2 to SAR at M1 = 59.9%  
Maximum value of SAR (measured) = 18.1 W/kg

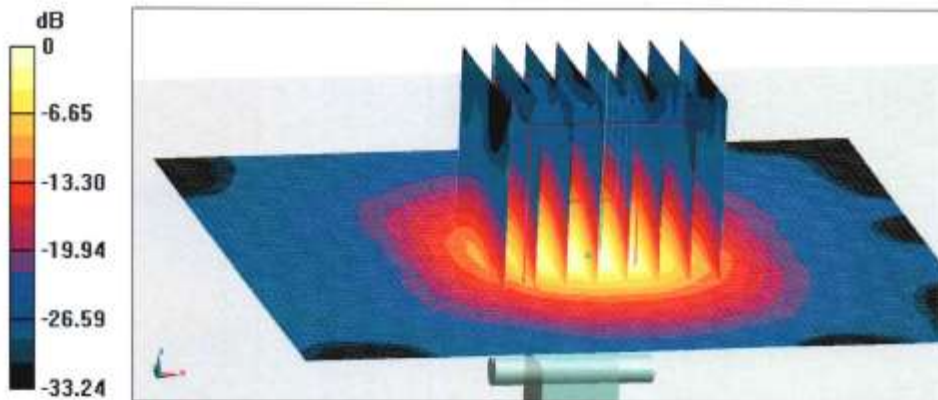

0 dB = 18.1 W/kg = 12.58 dBW/kg

**Impedance Measurement Plot for Body TSL**

