



RF TEST REPORT

Report No.: SET2018-05467

Product: Smart POS Payment Terminal

FCC ID: SWSI9000S

Model No.: i9000S

Applicant: Shenzhen Urovo Technology Co., Ltd

Address: A7, Zondy Cyber Building, Nanshan, Shenzhen, China

Dates of Testing: 05/09/2018 — 05/23/2018

Issued by: CCIC Southern Electronic Product Testing (Shenzhen) Co., Ltd.

Lab Location: Building 28/29, East of Shigu, Xili Industrial Zone, Xili Road, Nanshan District, Shenzhen, Guangdong, China

Tel: 86 755 26627338 **Fax:** 86 755 26627238

This test report consists of 69 pages in total. It may be duplicated completely for legal use with the approval of the applicant. It should not be reproduced except in full, without the written approval of our laboratory. The client should not use it to claim product endorsement by CCIC-SET. The test results in the report only apply to the tested sample. The test report shall be invalid without all the signatures of testing engineers, reviewer and approver. Any objections must be raised to CCIC-SET within 15 days since the date when the report is received. It will not be taken into consideration beyond this limit.



Test Report

Product.....: Smartphone

Brand Name.....: UROVO

Trade Name.....: N.A

Applicant.....: Shenzhen Urovo Technology Co., Ltd

Applicant Address.....: A7, Zondy Cyber Building, Nanshan, Shenzhen, China

Manufacturer.....: Shenzhen Urovo Technology Co., Ltd

Manufacturer Address.....: A7, Zondy Cyber Building, Nanshan, Shenzhen, China

Test Standards.....: 47 CFR FCC Part 2: Frequency Allocations and Radio Treaty
Matters; General Rules and Regulations
47 CFR FCC Part 22(H): Cellular Radiotelephone Service
47 CFR FCC Part 24(E): Personal Communications Services

Test Result.....: PASS

Tested by.....: 
2018.05.23
Shallwe Yang, Test Engineer

Reviewed by.....: 
2018.05.23
Zhu Qi, Senior EGINEER

Approved by.....: 
2018.05.23
Smart Li, Manager



Table of Contents

- 1. GENERAL INFORMATION4**
- 1.1 EUT Description4**
- 1.2 Maximum ERP/EIRP Power, Frequency Tolerance, and Emission Designator5**
- 1.3 Test Standards and Results6**
- 1.4 Test Configuration of Equipment under Test.....7**
- 1.5 Measurement Results Explanation Example8**
- 1.6 Facilities and Accreditations8**
- 2. 47 CFR PART 2, PART 22H & 24E REQUIREMENTS9**
- 2.1 Conducted RF Output Power9**
- 2.2 Peak to Average Ratio.....12**
- 2.3 99% Occupied Bandwidth and 26dB Bandwidth Measurement14**
- 2.4 Frequency Stability25**
- 2.5 Conducted Out of Band Emissions29**
- 2.6 Bandedge49**
- 2.7 Transmitter Radiated Power (EIRP/ERP)57**
- 2.8 Radiated Spurious Emissions61**
- 3. LIST OF MEASURING EQUIPMENT69**

Change History		
Issue	Date	Reason for change
1.0	2018.05.23	First edition



1. GENERAL INFORMATION

1.1 EUT Description

EUT Type	Smart POS Payment Terminal
Hardware Version	SQ27TW_MB_V01
Software Version	3.10.49
EUT supports Radios application	GPRS/EDGE/WCDMA/HSPA
Multi Slot Class	GPRS: Multi slot Class12, EGPRS: Multi slot Class12
Frequency Range	GSM 850MHz: Tx: 824.2 - 848.8MHz (at intervals of 200kHz); Rx: 869.2 - 893.8MHz (at intervals of 200kHz) GSM 1900MHz: Tx: 1850.2 - 1909.8MHz (at intervals of 200kHz); Rx: 1930.2 - 1989.8MHz (at intervals of 200kHz) WCDMA 850MHz Tx: 826.4 - 846.6MHz (at intervals of 200kHz); Rx: 871.4 - 891.6MHz (at intervals of 200kHz) WCDMA 1900MHz Tx: 1852.4 - 1907.6MHz (at intervals of 200kHz); Rx: 1932.4 - 1987.6MHz (at intervals of 200kHz)
Maximum Output Power to Antenna	GSM 850: 33.10dBm GSM 1900: 29.71dBm EDGE 850: 26.41dBm EDGE 1900: 26.33dBm WCDMA 850: 23.01dBm WCDMA 1900: 23.01dBm
Type of Modulation	GSM / GPRS:GMSK EDGE:GMSK / 8PSK WCDMA: QPSK(Uplink) HSDPA:QPSK(Downlink) HSUPA:QPSK(Uplink)
Antenna Type	Internal Antenna
Antenna Gain	GSM 850/ WCDMA 850: -1.60dBi GSM 1900/ WCDMA 1900: -0.8dBi



1.2 Maximum ERP/EIRP Power, Frequency Tolerance, and Emission Designator

System	Type of Modulation	Emission Designator	Frequency Tolerance (ppm)	Maximum ERP/EIRP(W)
GSM 850	GMSK	246KGXW	0.003	1.72
GSM 1900	GMSK	247KGXW	0.003	1.08
EDGE 850	8PSK	248KG7W	0.003	0.48
EDGE 1900	8PSK	254KG7W	0.003	0.43
WCDMA 850 RMC 12.2Kbps	QPSK	4M20F9W	0.003	0.18
WCDMA 1900 RMC 12.2Kbps	QPSK	4M23F9W	0.003	0.17



1.3 Test Standards and Results

1. 47 CFR Part 2, 22(H), 24(E)
2. ANSI / TIA / EIA-603-D-2010
3. FCC KDB 971168 D01 Power Meas. License Digital Systems v03r01

Remark:

1. All test items were verified and recorded according to the standards and without any deviation during the test.
2. This EUT has also been tested and complied with the requirements of FCC Part 15, Subpart B, recorded in a separate test report.

Test detailed items/section required by FCC rules and results are as below:

No.	Section	Description	Limit	Result
	FCC			
1	2.1046	Conducted Output Power	Reporting Only	PASS
2	24.232(d)	Peak to Average Ratio	< 13dBm	PASS
3	2.1049 22.917(b) 24.238(b)	Occupied Bandwidth	Reporting Only	PASS
4	2.1055 22.355 24.235	Frequency Stability	$\leq \pm 2.5\text{ppm}$	PASS
5	2.1051 22.917 24.238	Conducted Out of Band Emissions	$< 43+10\log_{10}$ (P[Watts])	PASS
6	2.1051 22.917 24.238	Band GPRS	$< 43+10\log_{10}$ (P[Watts])	PASS
7	22.913	Effective Radiated Power	< 7Watts	PASS
	24.232	Equivalent Isotropic Radiated Power	< 2Watts	PASS
8	2.1053 22.917 24.238	Radiated Spurious Emissions	$< 43+10\log_{10}$ (P[Watts])	PASS

1.4 Test Configuration of Equipment under Test

Antenna port conducted and radiated test items were performed according to KDB 971168 D01 Power Meas. License Digital Systems v03r01 with maximum output power.

Radiated measurements were performed with rotating EUT in different three orthogonal test planes to find the maximum emission.

Radiated emissions were investigated as following frequency range:

1. 30 MHz to 9000 MHz for GSM850 and WCDMA Band V.
2. 30 MHz to 20000 MHz for GSM1900 and WCDMA Band II.

All modes and data rates and positions were investigated.

Test modes are chosen to be reported as the worst case configuration below:

Test Modes		
Band	Radiated TCs	Conducted TCs
GSM 850	GPRS Link	GPRS Link
	GPRS Link	GPRS Link
GSM 1900	GPRS Link	GPRS Link
	GPRS Link	GPRS Link
WCDMA Band V	RMC 12.2Kbps Link	RMC 12.2Kbps Link
WCDMA Band II	RMC 12.2Kbps Link	RMC 12.2Kbps Link

Note: The maximum power levels are chosen to test as the worst case configuration as follows:

GSM mode for GMSK modulation,

EDGE multi-slot class 8 mode for 8PSK modulation,

RMC 12.2Kbps mode for WCDMA band V,

RMC 12.2Kbps mode for WCDMA band II, only these modes were used for all tests.



1.5 Measurement Results Explanation Example

For all conducted test items:

The offset level is set in the spectrum analyzer to compensate the RF cable loss and attenuator factor between EUT conducted output port and spectrum analyzer. With the offset compensation, the spectrum analyzer reading level is exactly the EUT RF output level.

The spectrum analyzer offset is derived from RF cable loss and attenuator factor.

Offset = RF cable loss + attenuator factor.

Following shows an offset computation example with cable loss 6B and 10dB attenuator.

Example:

$$\begin{aligned}\text{Offset (dB)} &= \text{RF cable loss(dB)} + \text{attenuator factor(dB)} \\ &= 6 + 10 = 16(\text{dB})\end{aligned}$$

1.6 Facilities and Accreditations

1.6.1 Test Facilities

NVLAP Lab Code: 201008-0

CCIC-SET is a third party testing organization accredited by NVLAP according to ISO/IEC 17025. The accreditation certificate number is 201008-0.

FCC- Designation Number: CN5031

CCIC Southern Electronic Product Testing (Shenzhen) Co., Ltd. EMC Laboratory has been registered and fully described in a report filed with the FCC (Federal Communications Commission). The acceptance letter from the FCC is maintained in our files. Designation Number: CN5031, valid time is until December 31, 2018.

ISED Registration: 11185A-1

CCIC Southern Electronic Product Testing (Shenzhen) Co., Ltd. EMC Laboratory has been registered by Certification and Engineering Bureau of Industry Canada for the performance of radiated measurements with Registration No. 11185A-1 on Aug. 04, 2016, valid time is until Aug. 03, 2019

1.6.2 Test Environment Conditions

During the measurement, the environmental conditions were within the listed ranges:

Temperature (°C):	15°C - 35°C
Relative Humidity (%):	30% -60%
Atmospheric Pressure (kPa):	86KPa-106KPa

2. 47 CFR PART 2, PART 22H & 24E REQUIREMENTS

2.1 Conducted RF Output Power

2.1.1 Definition

A system simulator was used to establish communication with the EUT. Its parameters were set to enforce EUT transmitting at the maximum power. The measured power in the radio frequency on the transmitter output terminals shall be reported.

2.1.2 Measuring Instruments

The measuring equipment is listed in the section 3 of this test report.

2.1.3 Test Procedures

1. The transmitter output port was connected to the system simulator.
2. Set EUT at maximum power through system simulator.
3. Select lowest, middle, and highest channels for each band and different modulation.
4. Measure and record the power level from the system simulator.

2.1.4 Test Setup

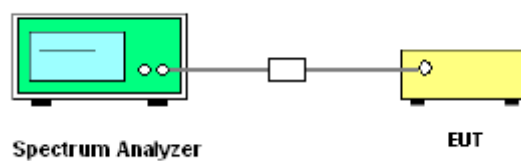



2.1.5 Test Results of Conducted Output Power

1. Test Verdict:

Band	Channel	Frequency (MHz)	Measured Output Power dBm	Verdict
GSM 850MHz	128	824.2	33.10	PASS
	190	836.6	32.80	PASS
	251	848.8	33.10	PASS
GSM 1900MHz	512	1850.2	29.70	PASS
	661	1880.0	29.70	PASS
	810	1909.8	29.71	PASS
GPRS 850MHz	128	824.2	32.71	PASS
	190	836.6	32.60	PASS
	251	848.8	32.77	PASS
GPRS 1900MHz	512	1850.2	29.68	PASS
	661	1880.0	29.67	PASS
	810	1909.8	29.70	PASS
EDGE 850MHz	128	824.2	26.41	PASS
	190	836.6	26.25	PASS
	251	848.8	26.19	PASS
EDGE 1900MHz	512	1850.2	26.33	PASS
	661	1880.0	26.12	PASS
	810	1909.8	26.09	PASS

Note 1: For the GPRS model, all the slots were tested and just the worst data was record in this report.



2. WCDMA Model Test Verdict:

Item	band	WCDMA 850			WCDMA 1900		
	Frequency	4132	4183	4233	9262	9400	9538
	Subtest	dBm			dBm		
WCDMA	RMC 12.2Kbps	23.01	22.93	22.94	22.91	23.01	22.92
HSDPA	1	22.78	22.62	22.71	22.72	22.84	22.69
	2	21.98	21.86	21.89	21.97	21.95	21.98
	3	21.54	21.65	21.38	21.58	21.78	21.69
	4	21.24	21.28	21.41	21.35	21.26	21.55
HSUPA	1	22.54	22.53	22.49	22.37	21.55	21.62
	2	21.85	21.68	21.59	21.75	21.77	21.76
	3	21.54	21.57	21.74	21.36	21.46	21.38
	4	21.33	21.32	21.35	21.28	21.30	21.24
	5	21.29	21.30	21.34	21.19	21.24	21.18

2.2 Peak to Average Ratio

2.2.1 Definition

Power Complementary Cumulative Distribution Function (CCDF) curves provide a means for characterizing the power peaks of a digitally modulated signal on a statistical basis. A CCDF curve depicts the probability of the peak signal amplitude exceeding the average power level. Most contemporary measurement instrumentation include the capability to produce CCDF curves for an input signal provided that the instrument's resolution bandwidth can be set wide enough to accommodate the entire input signal bandwidth. In measuring transmissions in this band using an average power technique, the peak-to-average ratio (PAR) of the transmission may not exceed 13 dB.

2.2.2 Measuring Instruments

The measuring equipment is listed in the section 3 of this test report.

2.2.3 Test Procedures

1. The testing follows FCC KDB 971168 D01 v03r01 Section 5.7.1.
2. The EUT was connected to the spectrum analyzer and system simulator via a power divider.
3. For GSM/EGPRS operating modes:
 - a. Set EUT in maximum power output.
 - b. Set the RBW = 1MHz, VBW = 3MHz, Peak detector on spectrum analyzer for first trace.
 - c. Set the RBW = 1MHz, VBW = 3MHz, RMS detector on spectrum analyzer for second trace.
 - d. The wanted burst signal is triggered by spectrum analyzer, and measured respectively the peak level and Mean level without burst-off time, after system simulator has synchronized with the spectrum analyzer.
4. For UMTS operating modes:
 - a. Set the CCDF (Complementary Cumulative Distribution Function) option on the spectrum analyzer.
 - b. The highest RF powers were measured and recorded the maximum PAPR level associated with a probability of 0.1 %.
5. Record the deviation as Peak to Average Ratio.

2.2.4 Test Setup

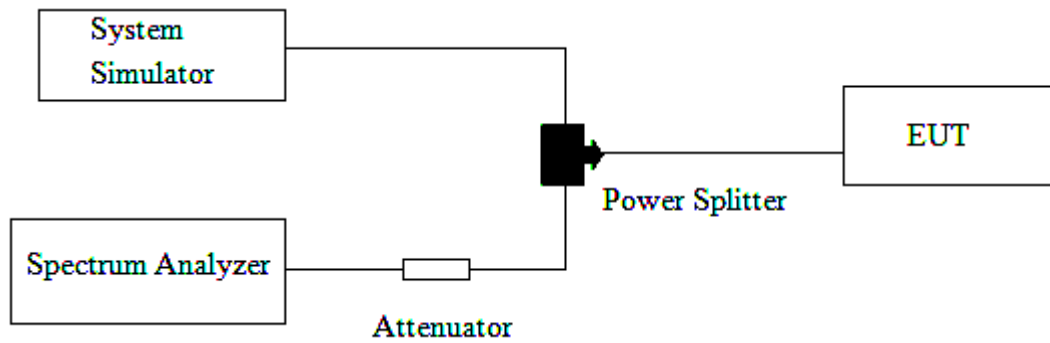

2.2.5 Test Results of Peak-to-Average Ratio

Band	Channel	Frequency (MHz)	Peak to Average ratio	Limit	Verdict
			dB	dB	
GSM 1900MHz	512	1850.2	0.30	13	PASS
	661	1880.0	0.30		PASS
	810	1909.8	0.40		PASS
EDGE 1900MHz	512	1850.2	3.20	13	PASS
	661	1880.0	3.10		PASS
	810	1909.8	3.60		PASS
WCDMA 1900MHz	9262	1852.4	3.01	13	PASS
	9400	1880.0	3.10		PASS
	9538	1907.6	3.01		PASS

2.3 99% Occupied Bandwidth and 26dB Bandwidth Measurement

2.3.1 Definition

The 99% occupied bandwidth is the width of a frequency band such that, below the lower and above the upper frequency limits, the mean powers emitted are each equal to a specified percentage 0.5% of the total mean transmitted power.

The emission bandwidth is defined as the width of the signal between two points, located at the 2 sides of the carrier frequency, outside of which all emissions are attenuated at least 26 dB below the transmitter power.

2.3.2 Measuring Instruments

The measuring equipment is listed in the section 3 of this test report.

2.3.3 Test Procedures

1. The testing follows FCC KDB 971168 D01 v03r01 Section 4.2.
2. The EUT was connected to the spectrum analyzer and system simulator via a power divider.
3. The RF output of the EUT was connected to the spectrum analyzer by RF cable and attenuator.
- The path loss was compensated to the results for each measurement.
4. The 99% occupied bandwidth were measured, set RBW= 1% of span, VBW= 3*RBW, sample detector, trace maximum hold.
5. The 26dB bandwidth were measured, set RBW= 1% of EBW, VBW= 3*RBW, peak detector, trace maximum hold.

2.3.4 Test Setup

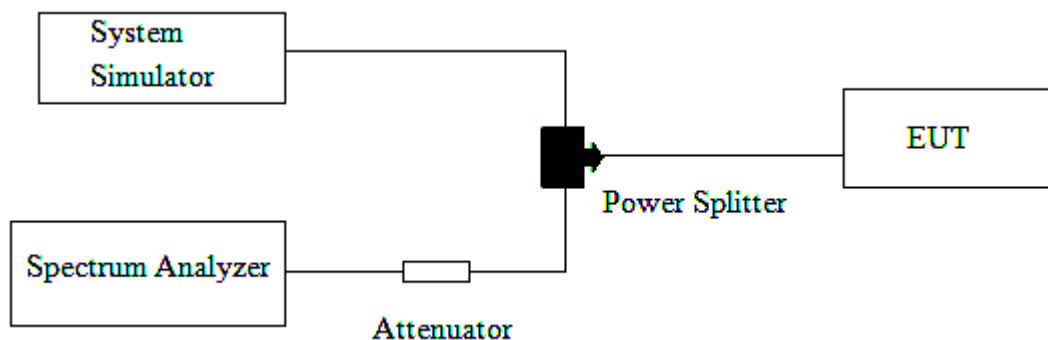

**2.3.5 Test Results of 99% Occupied Bandwidth and 26dB Bandwidth**

Band	Channel	Frequency (MHz)	26dB bandwidth	99% Occupied Bandwidth	Refer to Plot
GSM 850MHz	128	824.2	309.4 KHz	244.90 KHz	Plot A1
	190	836.6	311.1 KHz	245.15 KHz	Plot A2
	251	848.8	310.4 KHz	245.96 KHz	Plot A3
GSM 1900MHz	512	1850.2	312.3 KHz	244.14 KHz	Plot B1
	661	1880.0	315.4 KHz	246.62 KHz	Plot B2
	810	1909.8	311.2 KHz	246.22 KHz	Plot B3
EDGE 850MHz	128	824.2	321.7 KHz	248.08 KHz	Plot C1
	190	836.6	291.0 KHz	248.17 KHz	Plot C2
	251	848.8	316.4 KHz	246.79 KHz	Plot C3
EDGE 1900MHz	512	1850.2	317.8 KHz	253.66 KHz	Plot D1
	661	1880.0	327.7 KHz	254.18 KHz	Plot D2
	810	1909.8	312.7 KHz	254.18 KHz	Plot D3
WCDMA 850MHz	4132	826.4	4.846 MHz	4.202 MHz	Plot E1
	4183	836.6	4.835 MHz	4.203 MHz	Plot E2
	4233	846.6	4.833 MHz	4.194 MHz	Plot E3
WCDMA 1900MHz	9262	1852.4	4.944 MHz	4.229 MHz	Plot F1
	9400	1880	4.860 MHz	4.202 MHz	Plot F2
	9538	1907.6	4.838 MHz	4.200 MHz	Plot F3



2.3.6 Test Results (Plots) of 99% Occupied Bandwidth and 26dB Bandwidth

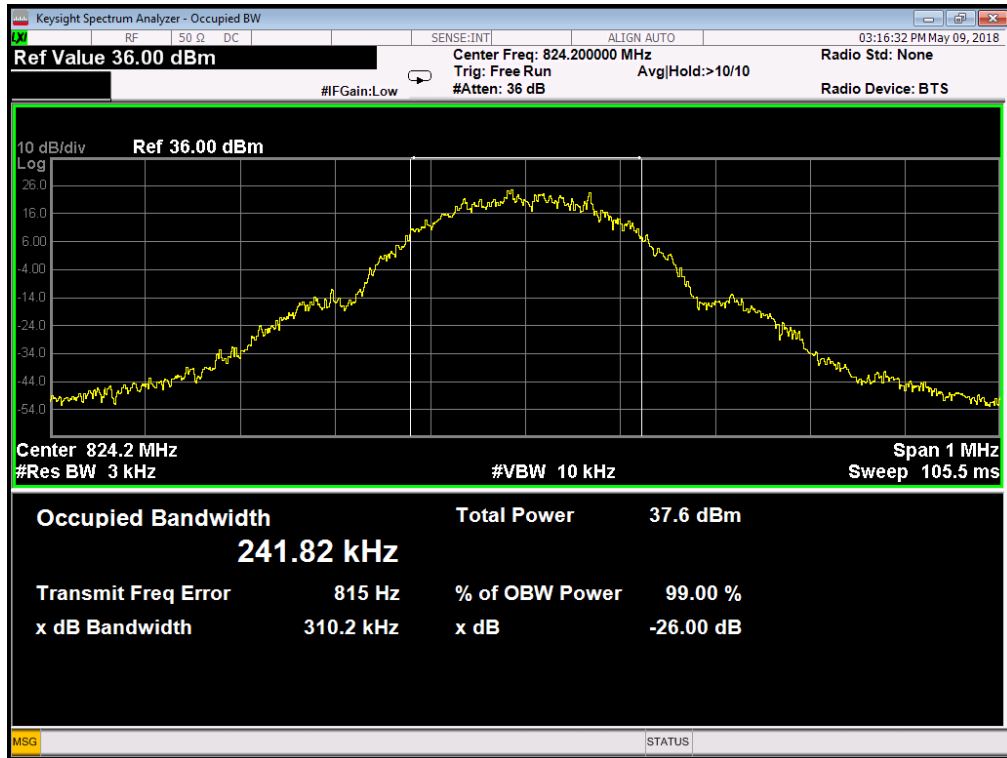

(Plot A1: GSM 850MHz Channel = 128 Occupied bandwidth)

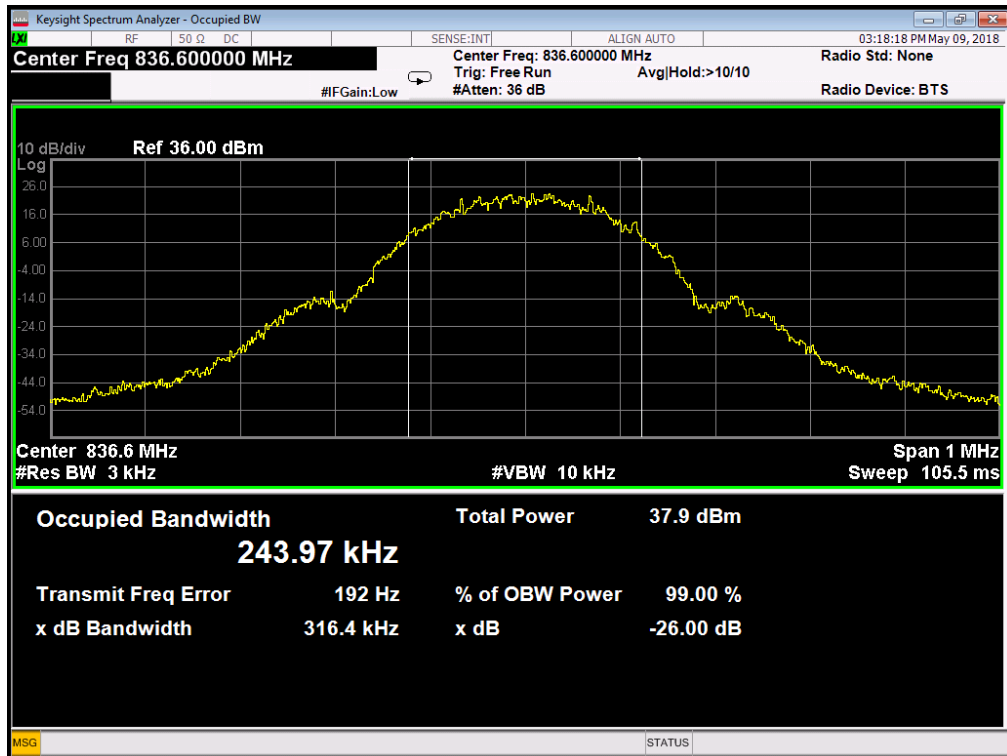

(Plot A2: GSM 850MHz Channel = 190 Occupied bandwidth)

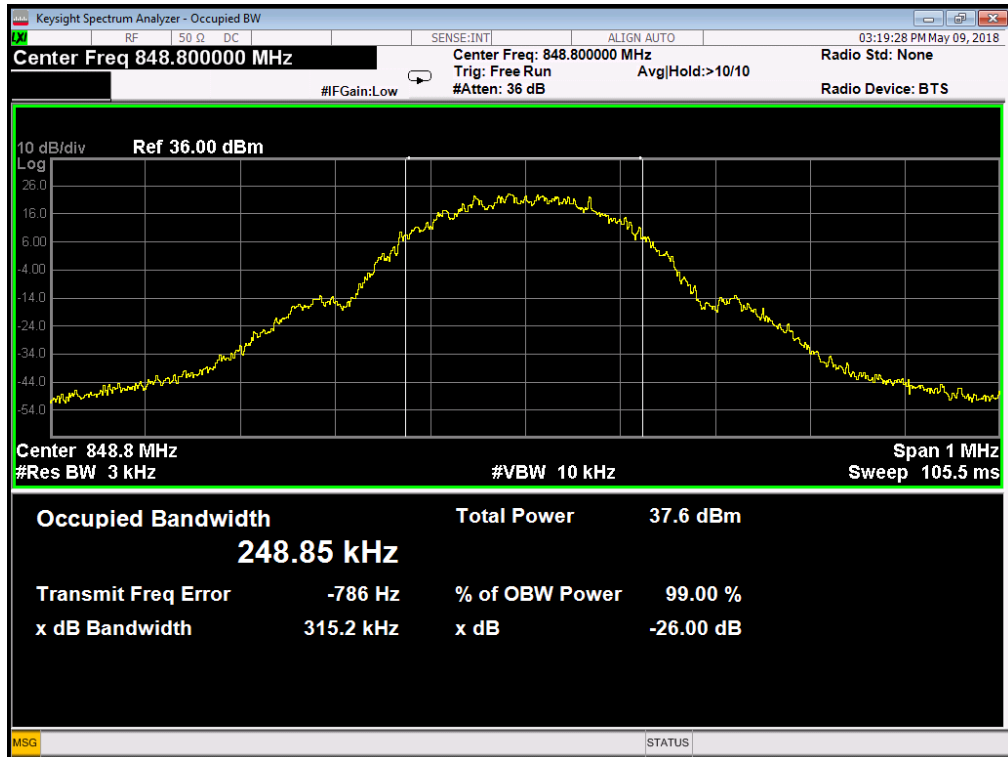

(Plot A3: GSM 850MHz Channel = 251 Occupied bandwidth)

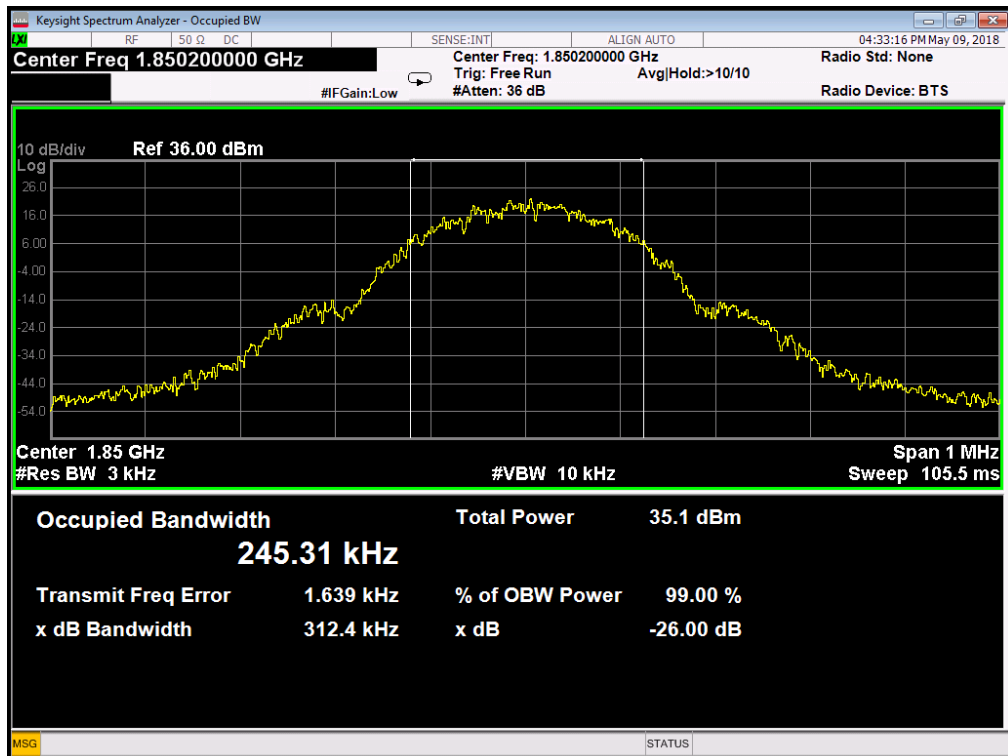

(Plot B1: GSM 1900MHz Channel = 512 Occupied bandwidth)

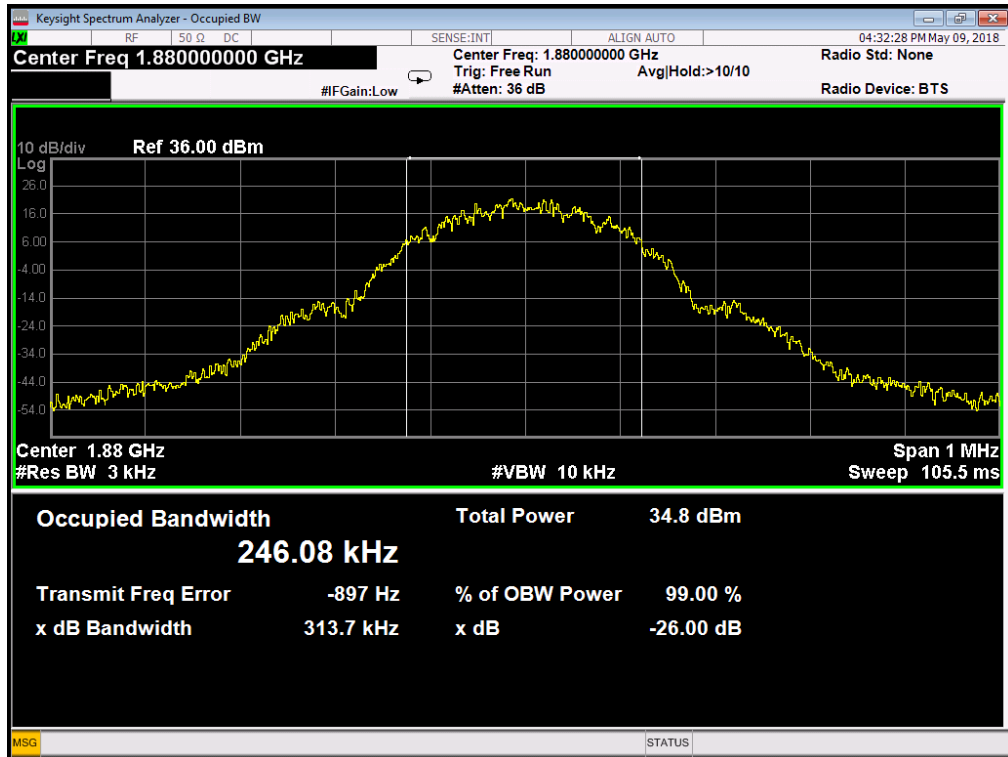

(Plot B2: GSM 1900MHz Channel = 661 Occupied bandwidth)

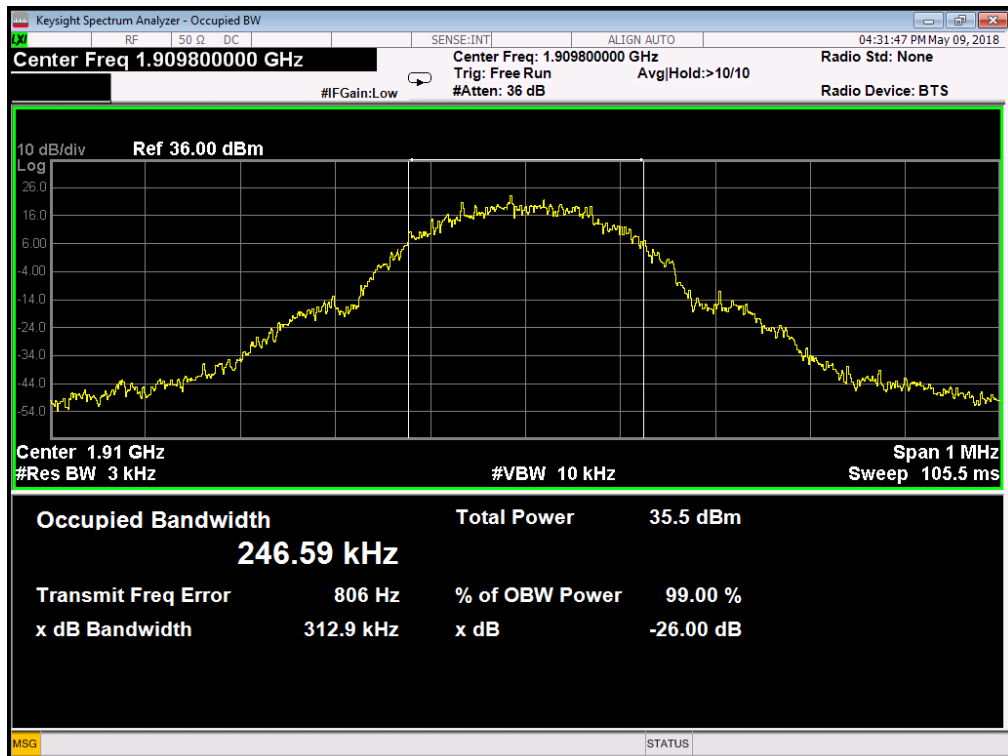

(Plot B3: GSM 1900MHz Channel = 810 Occupied bandwidth)

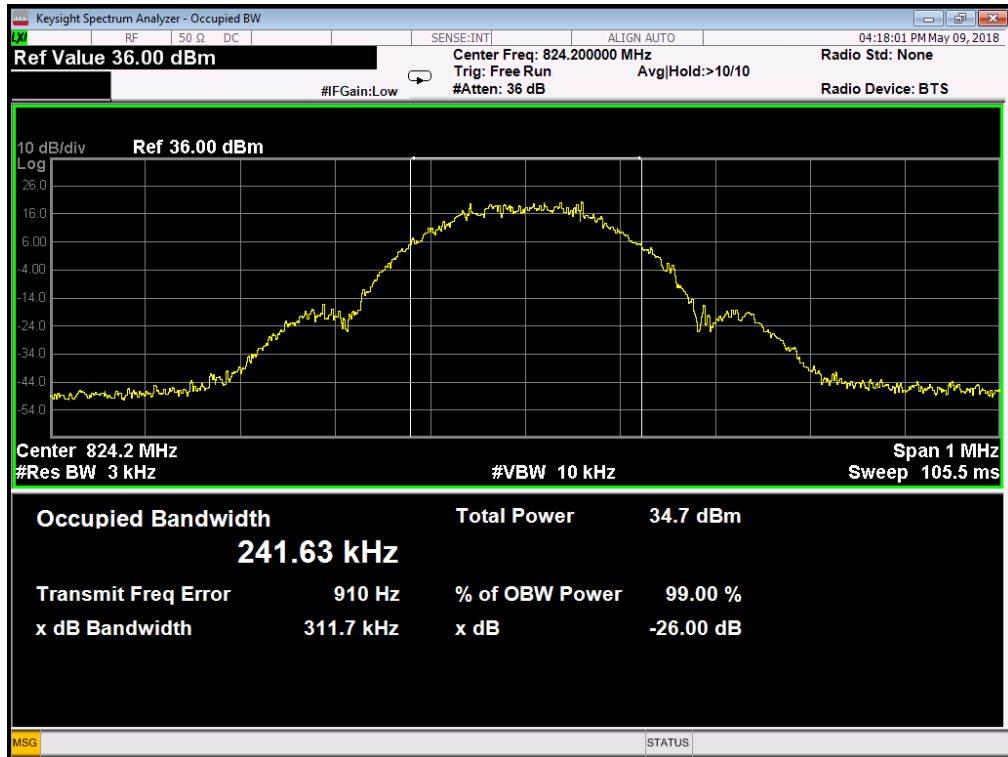

(Plot C1: EDGE 850MHz Channel = 128 Occupied bandwidth)

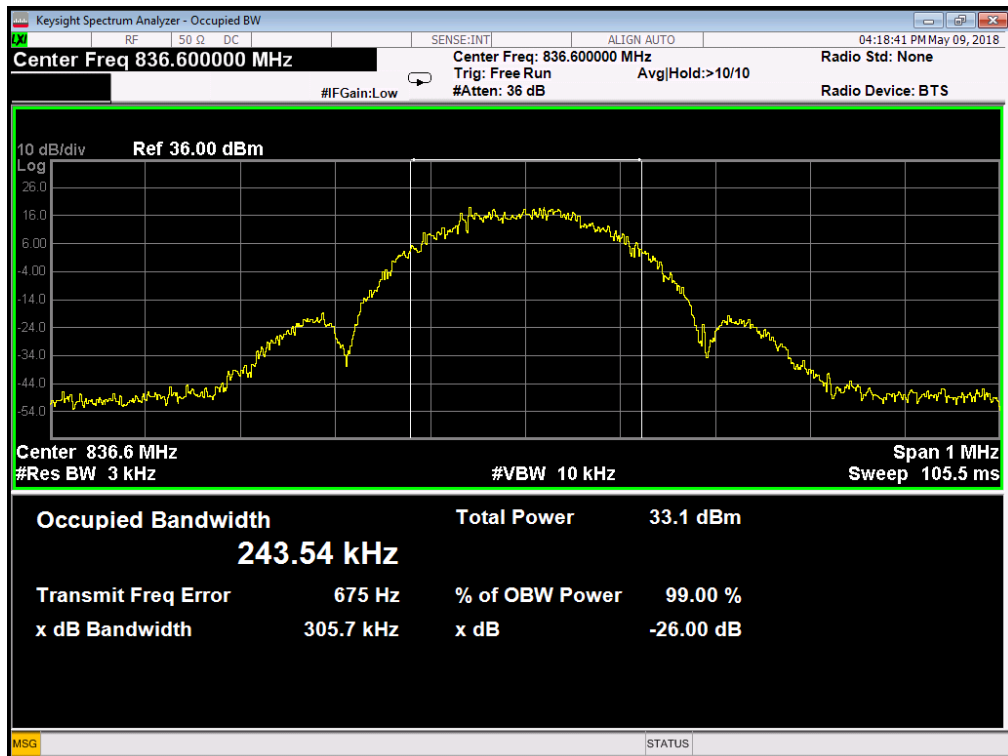

(Plot C2: EDGE 850MHz Channel = 190 Occupied bandwidth)

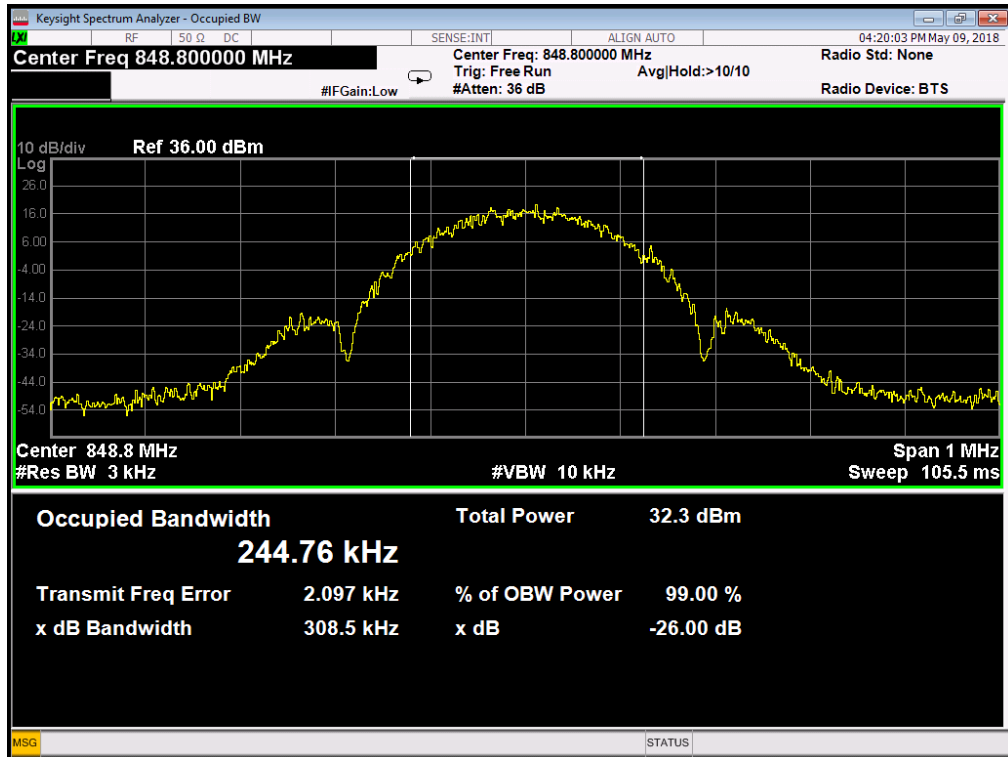

(Plot C3: EDGE 850MHz Channel = 251 Occupied bandwidth)

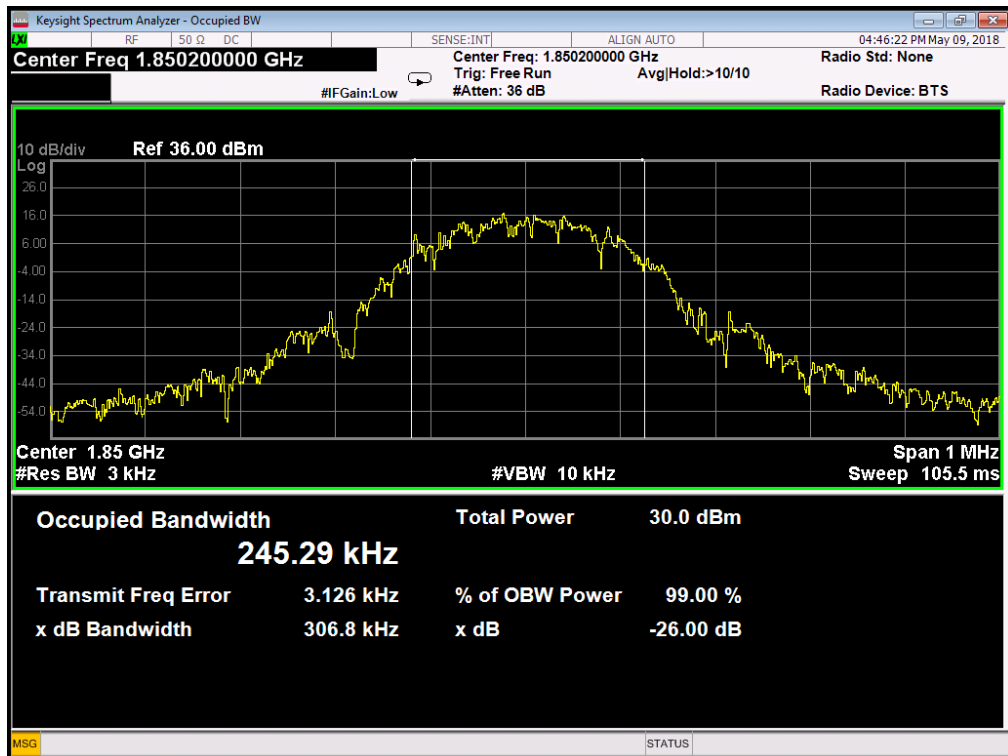

(Plot D1: EDGE 1900MHz Channel = 512 Occupied bandwidth)

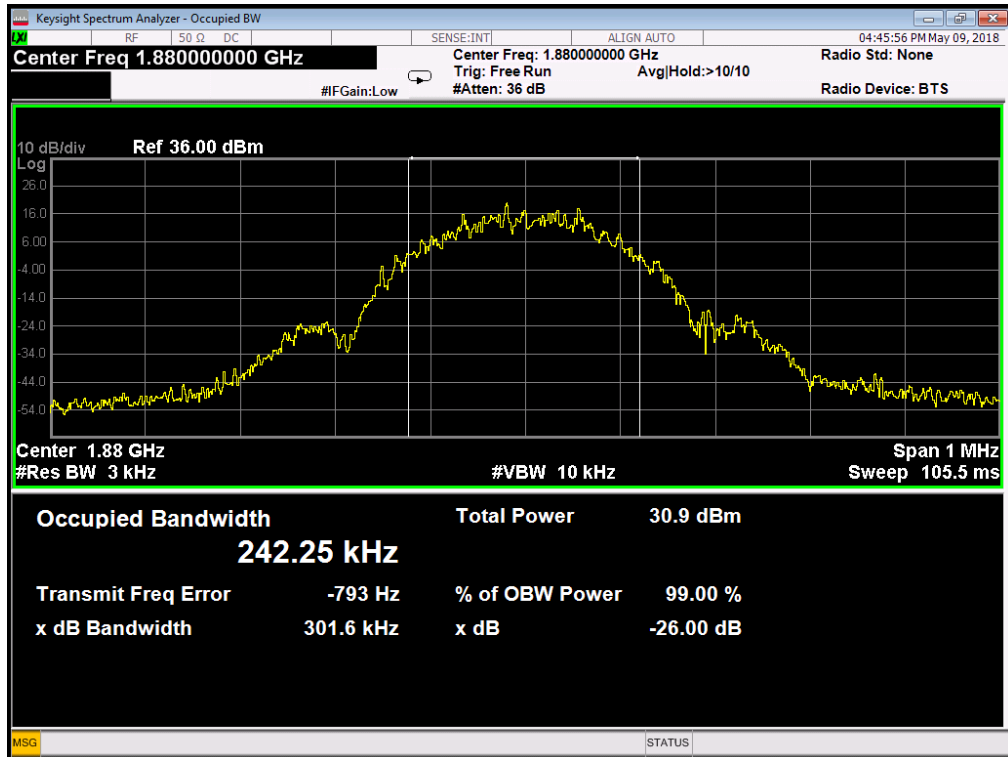

(Plot D2: EDGE 1900MHz Channel = 661 Occupied bandwidth)

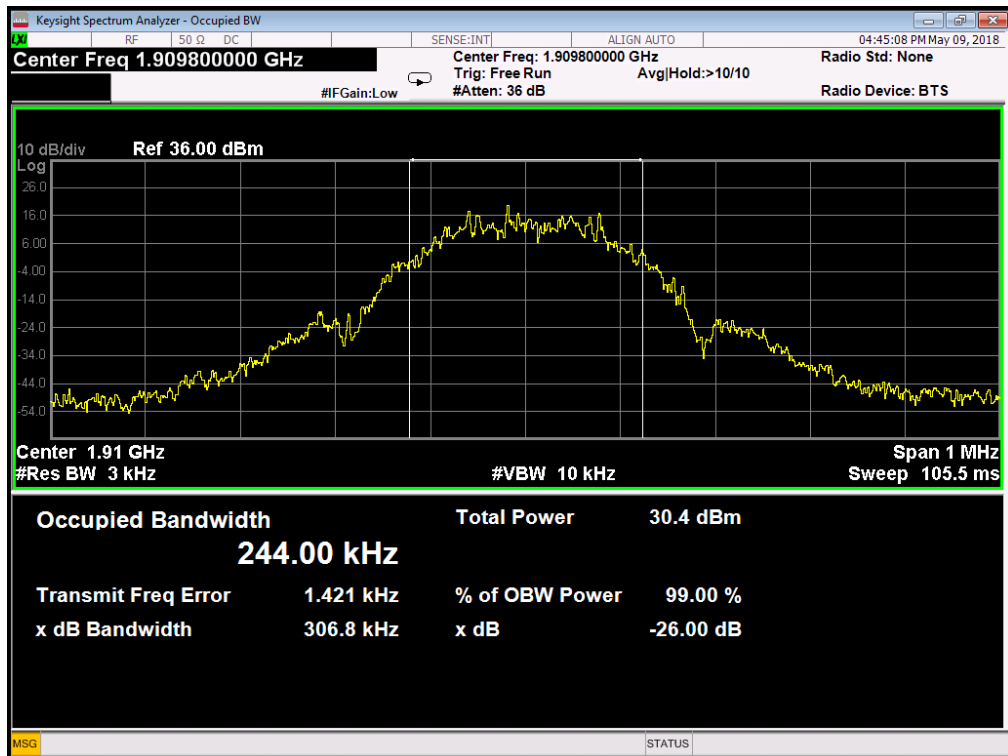

(Plot D3: EDGE 1900MHz Channel = 810 Occupied bandwidth)

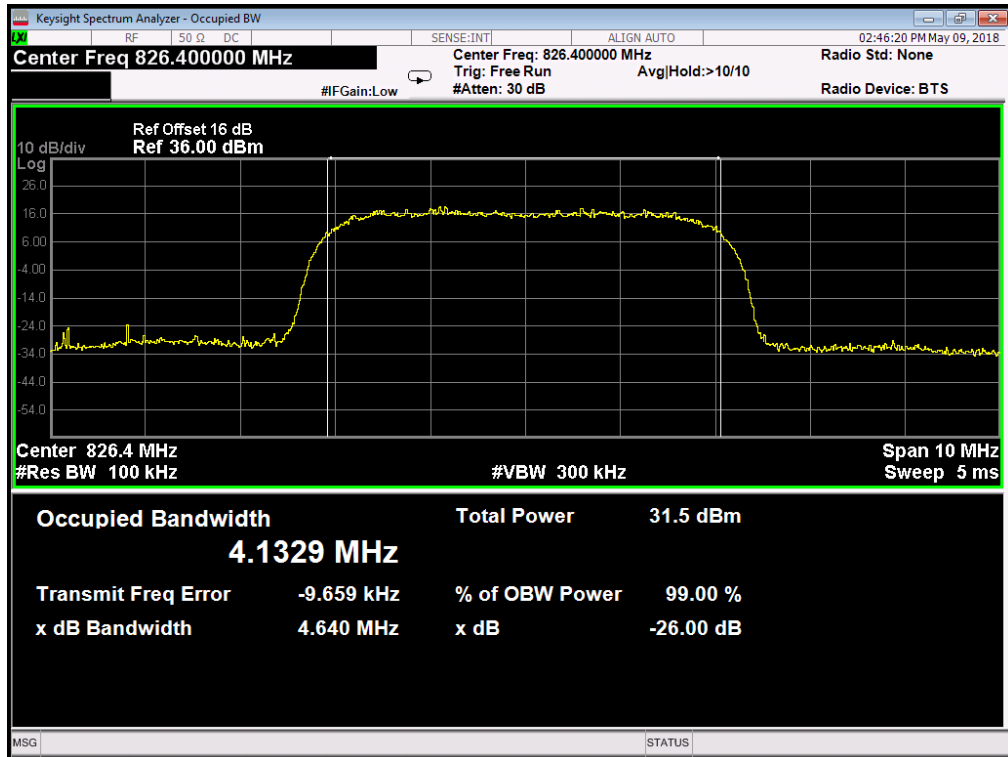

(Plot E1: WCDMA 850MHz Channel = 4132 Occupied bandwidth)

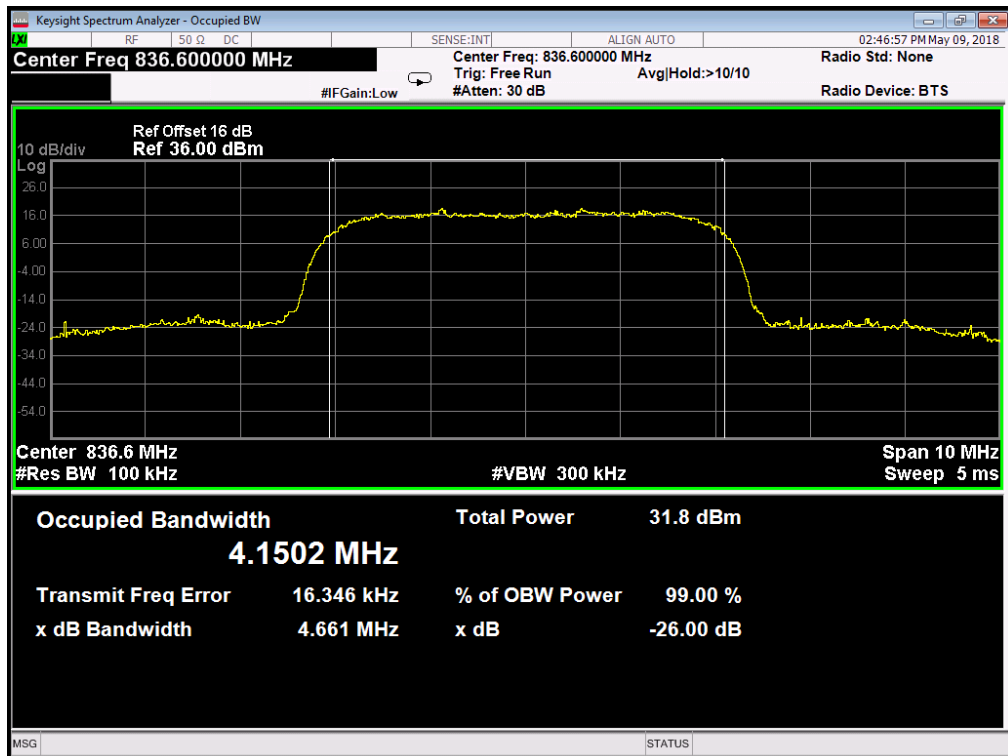

(Plot E2: WCDMA 850MHz Channel = 4183 Occupied bandwidth)

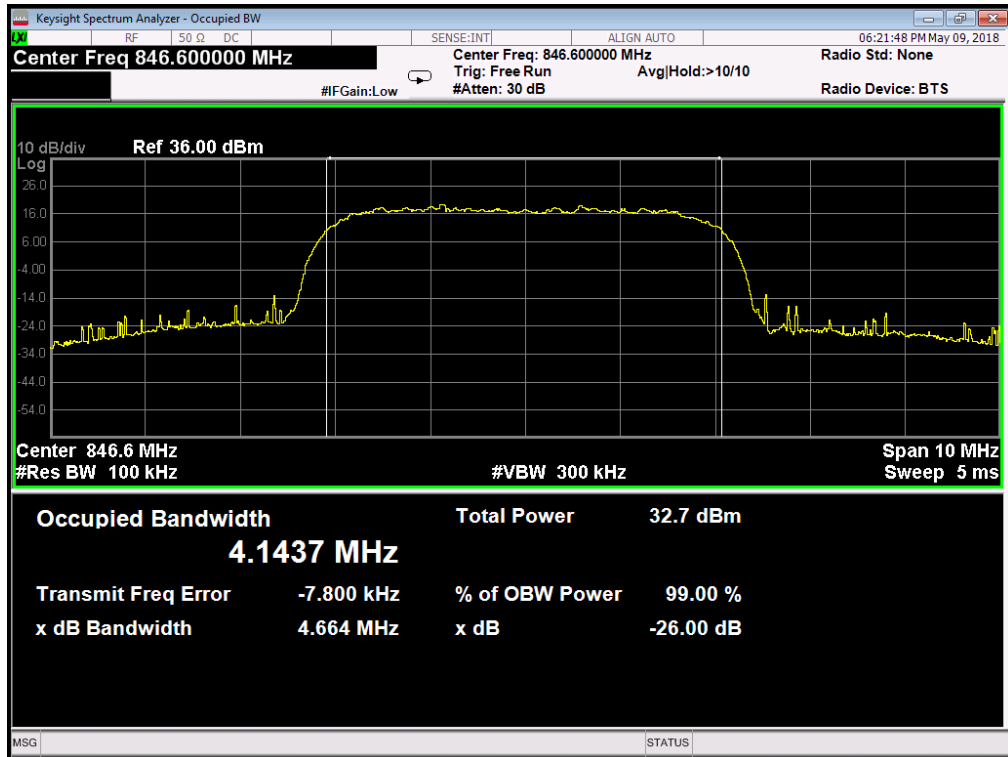

(Plot E3: WCDMA 850MHz Channel = 4233 Occupied bandwidth)

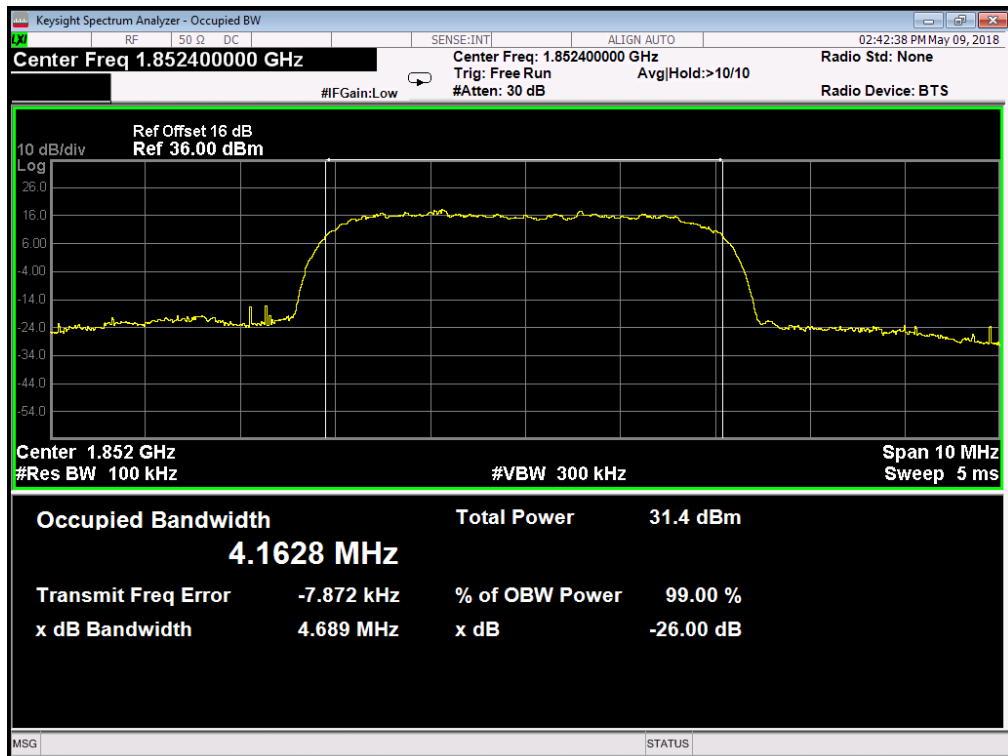

(Plot F1: WCDMA 1900MHz Channel = 9262 Occupied bandwidth)

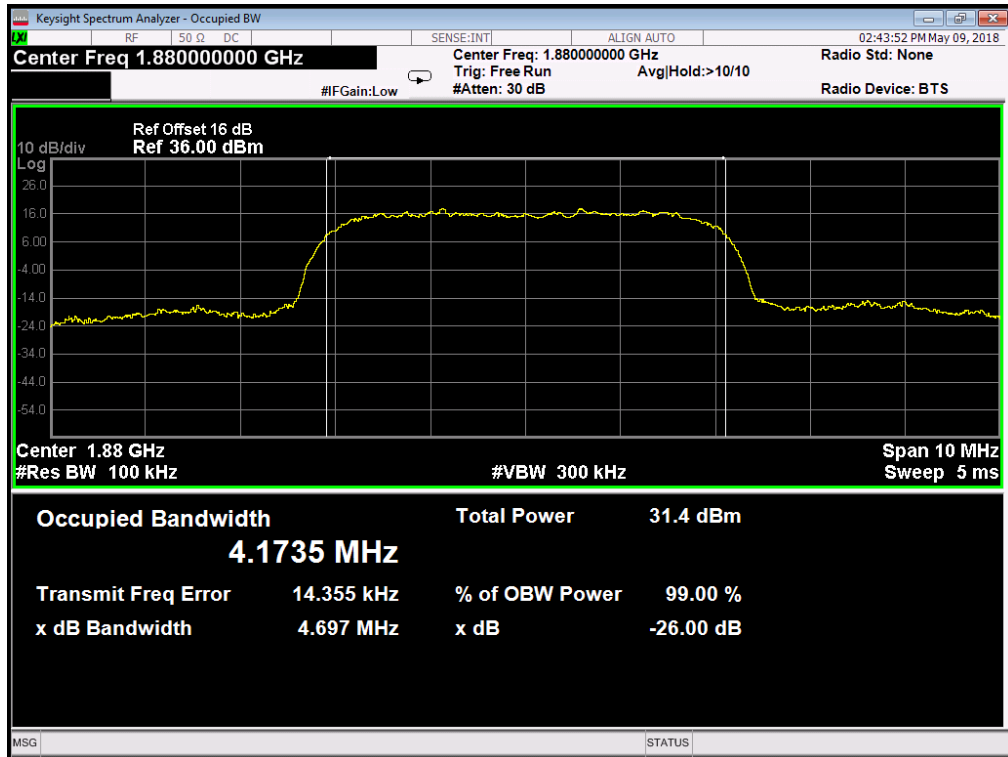

(Plot F2: WCDMA 1900MHz Channel = 9400 Occupied bandwidth)

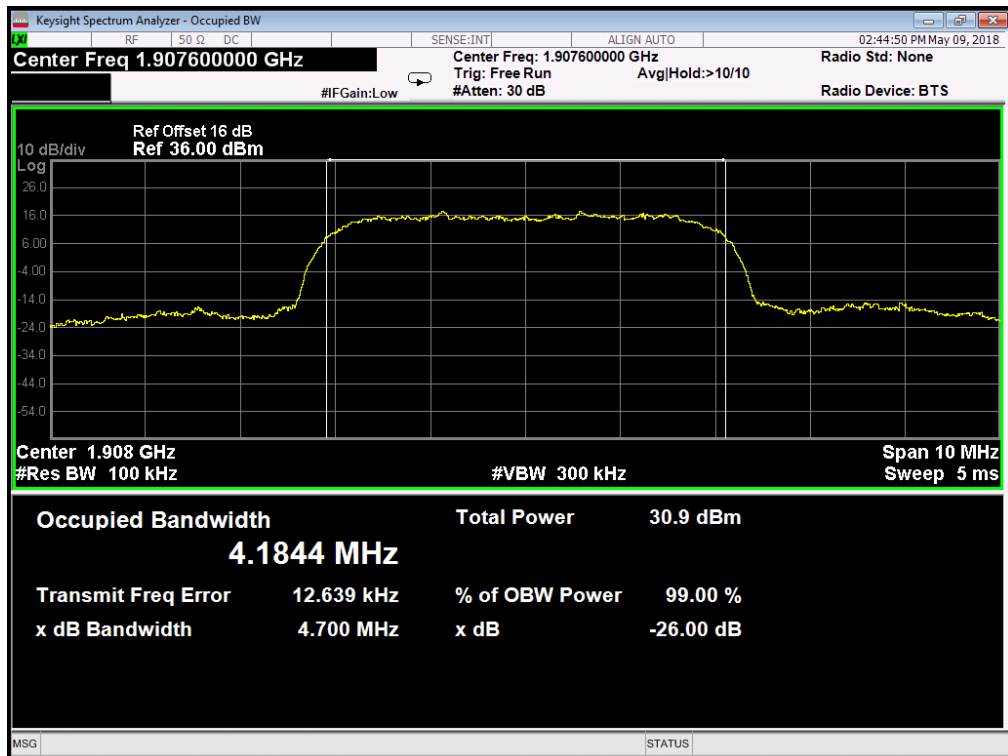

(Plot F3: WCDMA 1900MHz Channel = 9538 Occupied bandwidth)

2.4 Frequency Stability

2.4.1 Requirement

The frequency stability shall be measured by variation of ambient temperature and variation of primary supply voltage to ensure that the fundamental emission stays within the authorized frequency block. The frequency stability of the transmitter shall be maintained within $\pm 0.00025\%$ ($\pm 2.5\text{ppm}$) of the center frequency.

2.4.2 Measuring Instruments

The measuring equipment is listed in the section 3 of this test report.

2.4.3 Test Procedures for Temperature Variation

1. The testing follows FCC KDB 971168 D01 v03r01 Section 9.0.
2. The EUT was set up in the thermal chamber and connected with the system simulator.
3. With power OFF, the temperature was decreased to -30°C and the EUT was stabilized before testing. Power was applied and the maximum change in frequency was recorded within one minute.
4. With power OFF, the temperature was raised in 10°C steps up to 50°C . The EUT was stabilized at each step for at least half an hour. Power was applied and the maximum frequency change was recorded within one minute.

2.4.4 Test Procedures for Voltage Variation

1. The testing follows FCC KDB 971168 D01 v03r01 Section 9.0.
2. The EUT was placed in a temperature chamber at $25\pm 5^{\circ}\text{C}$ and connected with the system simulator.
3. The power supply voltage to the EUT was varied from BEP to 115% of the nominal value measured at the input to the EUT.
4. The variation in frequency was measured for the worst case.

2.4.5 Test Setup

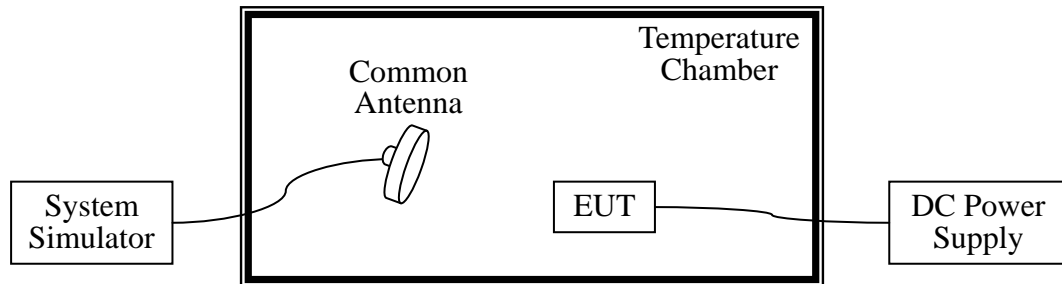

2.4.6 Test Results of Frequency Stability

1. GSM 850MHz Band

Band:	GSM 850	Channel:	190
Limit(ppm):	2.5	Frequency:	836.6MHz

Power (VDC)	Temperature (°C)	GSM		EDGE		Result
		Freq. Dev. (Hz)	Deviation (ppm)	Freq. Dev. (Hz)	Deviation (ppm)	
3.8	-30	18	0.02	12	0.001	PASS
	-20	20	0.02	19	0.002	
	-10	25	0.03	17	0.002	
	0	10	0.01	13	0.001	
	+10	11	0.01	26	0.003	
	+20	19	0.02	19	0.002	
	+30	17	0.02	12	0.001	
	+40	25	0.03	25	0.003	
	+50	8	0.01	10	0.001	
4.3	+25	11	0.01	26	0.003	
3.5	+25	26	0.03	19	0.002	



2. GSM 1900MHz Band

Band:	GSM 1900	Channel:	661
Limit(ppm):	2.5	Frequency:	1880.0MHz

Power (VDC)	Temperature (°C)	GSM		EDGE		Result
		Freq. Dev. (Hz)	Deviation (ppm)	Freq. Dev. (Hz)	Deviation (ppm)	
3.8	-30	38	0.02	59	0.003	PASS
	-20	47	0.02	22	0.001	
	-10	26	0.01	45	0.002	
	0	57	0.03	23	0.001	
	+10	44	0.02	45	0.002	
	+20	22	0.01	25	0.001	
	+30	41	0.02	46	0.002	
	+40	56	0.03	24	0.001	
	+50	25	0.01	58	0.003	
4.3	+25	58	0.03	23	0.001	
3.5	+25	22	0.01	57	0.003	

3. WCDMA 850MHz Band

Band:	WCDMA Band V	Channel:	4183
Limit(ppm):	2.5	Frequency:	836.6MHz

Power (VDC)	Temperature (°C)	RMC 12.2Kbps		Result
		Freq. Dev. (Hz)	Deviation (ppm)	
3.8	-30	15	0.002	PASS
	-20	16	0.002	
	-10	27	0.003	
	0	17	0.002	
	+10	18	0.002	
	+20	8	0.001	
	+30	17	0.002	
	+40	11	0.001	
	+50	25	0.003	
4.3	+25	19	0.002	
3.5	+25	26	0.003	



4. WCDMA 1900MHz Band

Band:	WCDMA Band II	Channel:	9400
Limit(ppm):	2.5	Frequency:	1880.0MHz

Power (VDC)	Temperature (°C)	RMC 12.2Kbps		Result
		Freq. Dev. (Hz)	Deviation (ppm)	
3.8	-30	54	0.003	PASS
	-20	37	0.002	
	-10	22	0.001	
	0	18	0.001	
	+10	45	0.002	
	+20	21	0.001	
	+30	57	0.003	
	+40	38	0.002	
+50	15	0.001		
4.3	+25	54	0.003	
3.5	+25	21	0.001	

2.5 Conducted Out of Band Emissions

2.5.1 Requirement

The power of any emission outside of the authorized operating frequency ranges must be lower than the transmitter power (P) by a factor of at least $43 + 10 \log (P)$ dB.

It is measured by means of a calibrated spectrum analyzer and scanned from 30 MHz up to a frequency including its 10th harmonic.

2.5.2 Measuring Instruments

The measuring equipment is listed in the section 3 of this test report.

2.5.3 Test Procedures

1. The testing follows FCC KDB 971168 D01 v03r01 Section 6.0.
2. The EUT was connected to the spectrum analyzer and system simulator via a power divider.
3. The RF output of EUT was connected to the spectrum analyzer by an RF cable and attenuator. The path loss was compensated to the results for each measurement.
4. The middle channel for the highest RF power within the transmitting frequency was measured.
5. The conducted spurious emission for the whole frequency range was taken.
6. The RF fundamental frequency should be excluded against the limit line in the operating frequency band.
7. The limit line is derived from $43 + 10\log(P)$ dB below the transmitter power P(Watts)
 $= P(W) - [43 + 10\log(P)]$ (dB)
 $= [30 + 10\log(P)]$ (dBm) - $[43 + 10\log(P)]$ (dB)
 $= -13$ dBm.
8. For 9KHz to 30MHz: the amplitude of spurious emissions are attenuated by more than 20dB below the permissible value has no need to be reported.

2.5.4 Test Setup

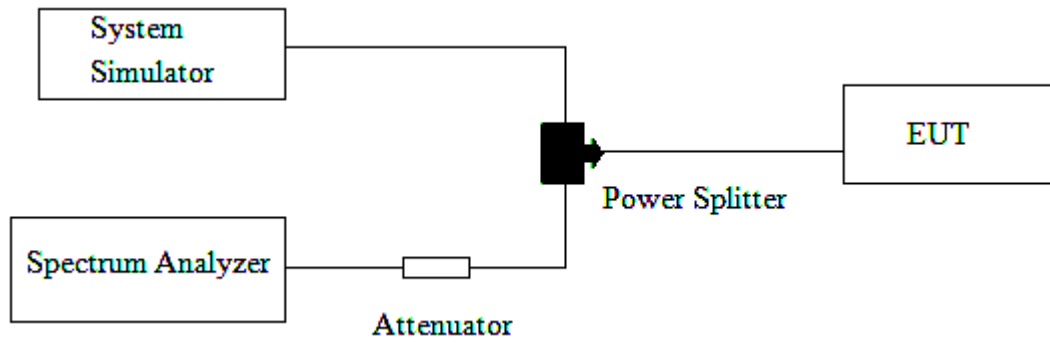

2.5.5 Test Result (Plots) of Conducted Spurious Emission

Note: For 9 KHz to 30MHz: the amplitude of spurious emissions is attenuated by more than 20dB below the permissible value, so we not provide the test result here.

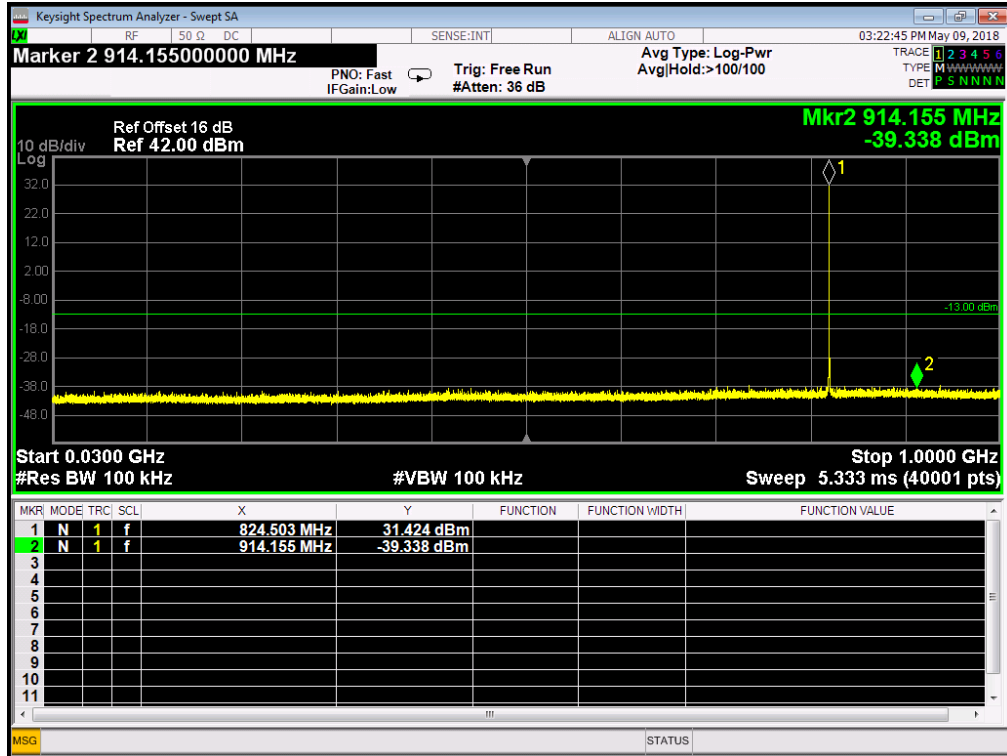

GSM 850MHz Channel = 128, 30MHz to 1GHz

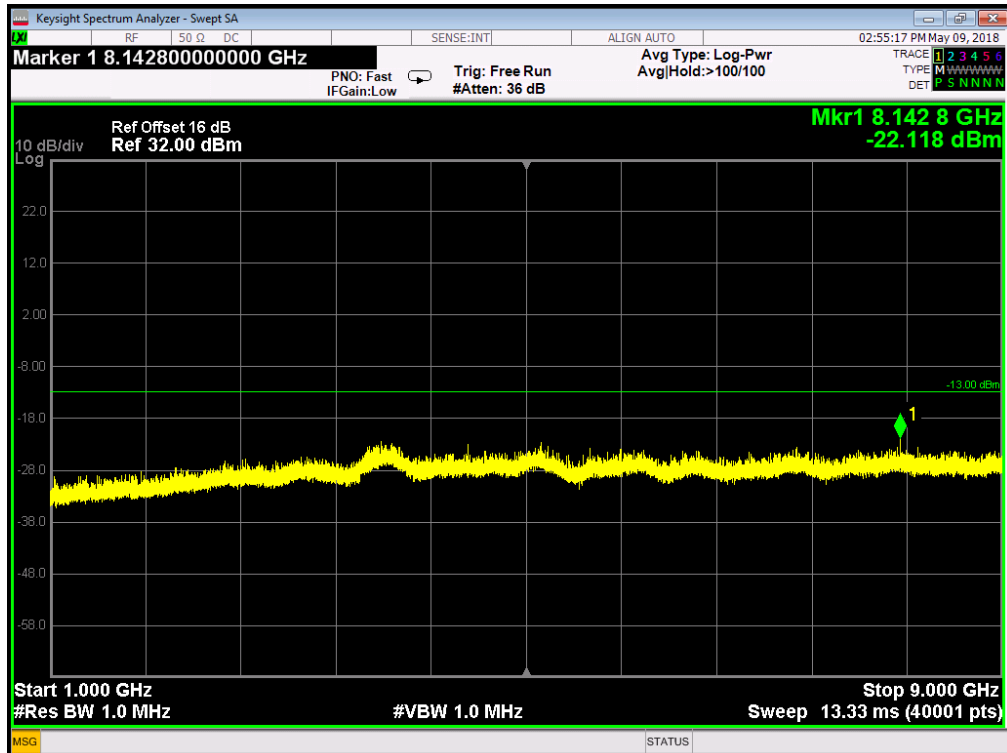

GSM 850MHz Channel = 128, 1GHz to 9GHz

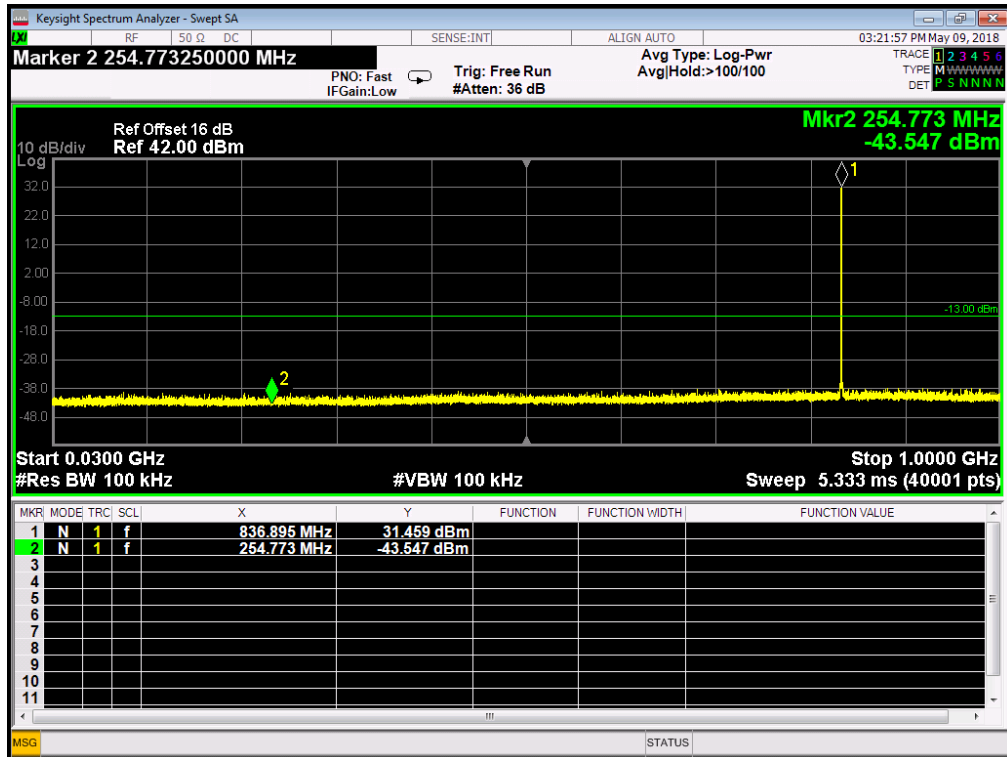

GSM 850MHz Channel = 190, 30MHz to 1GHz

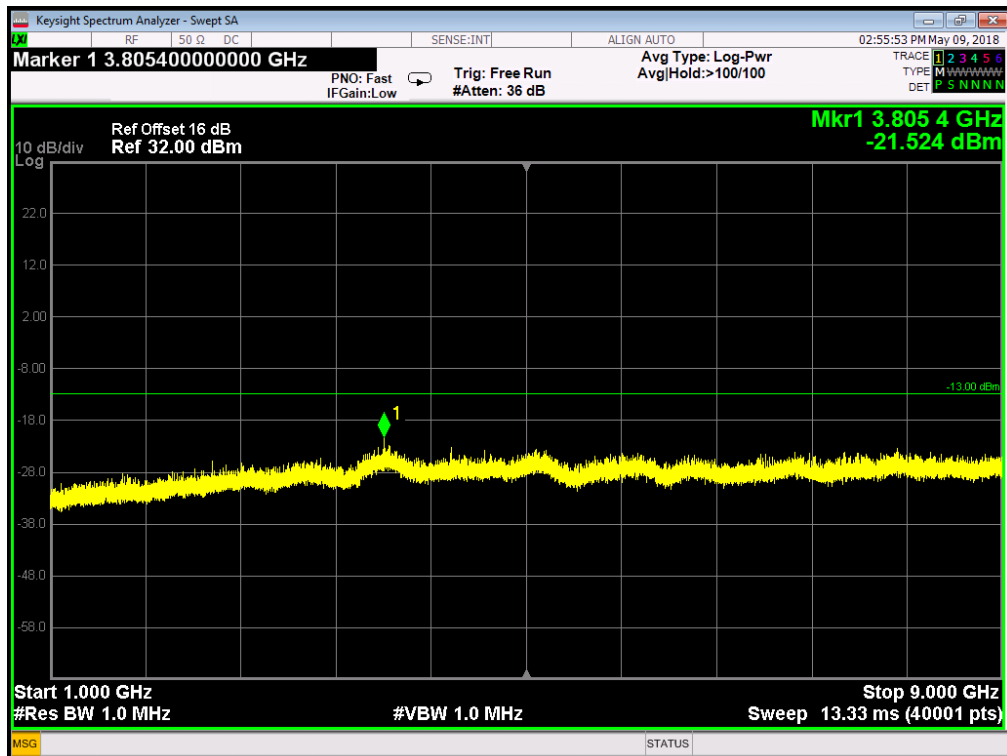

GSM 850MHz Channel = 190, 1GHz to 9GHz

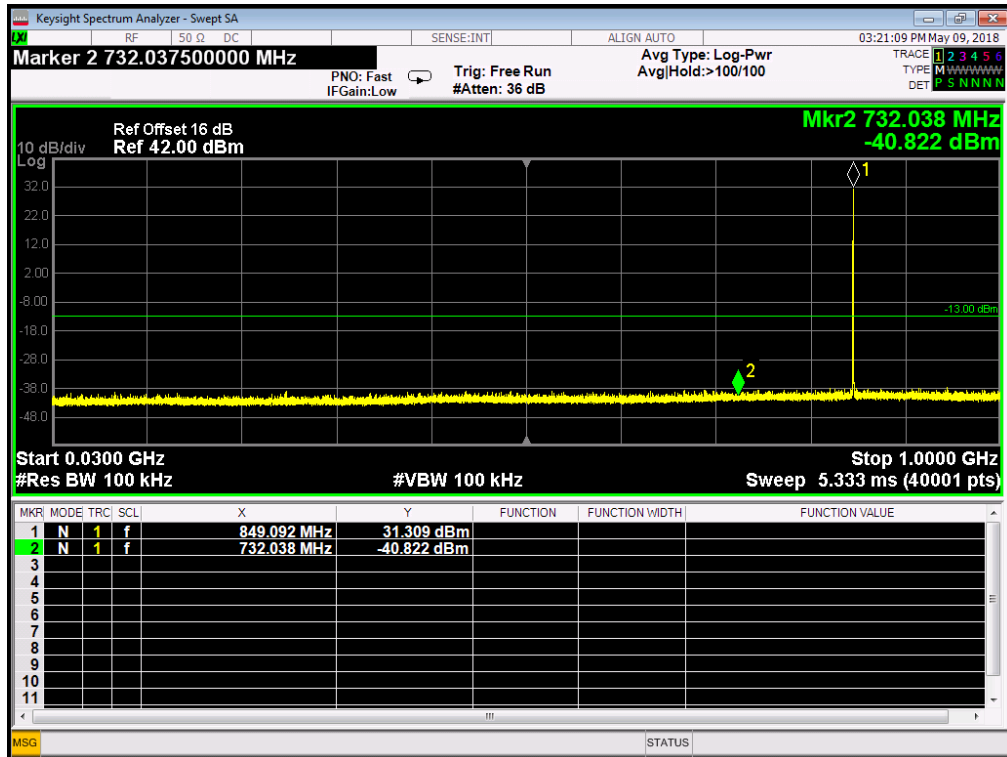

GSM 850MHz Channel = 251, 30MHz to 1GHz

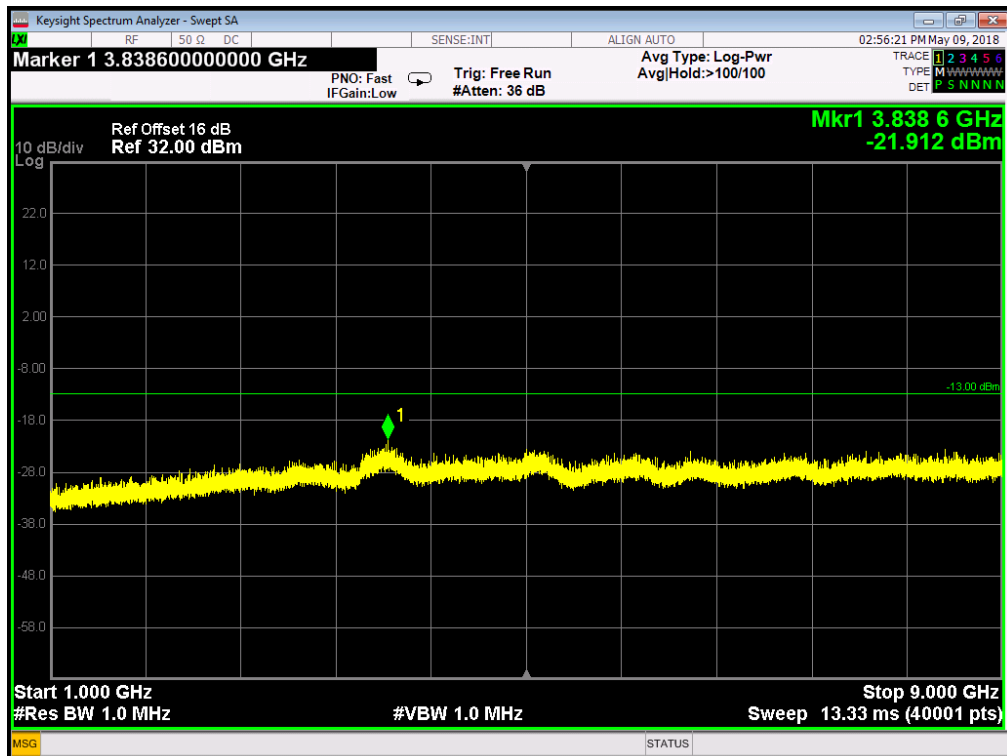

GSM 850MHz Channel = 251, 1GHz to 9GHz

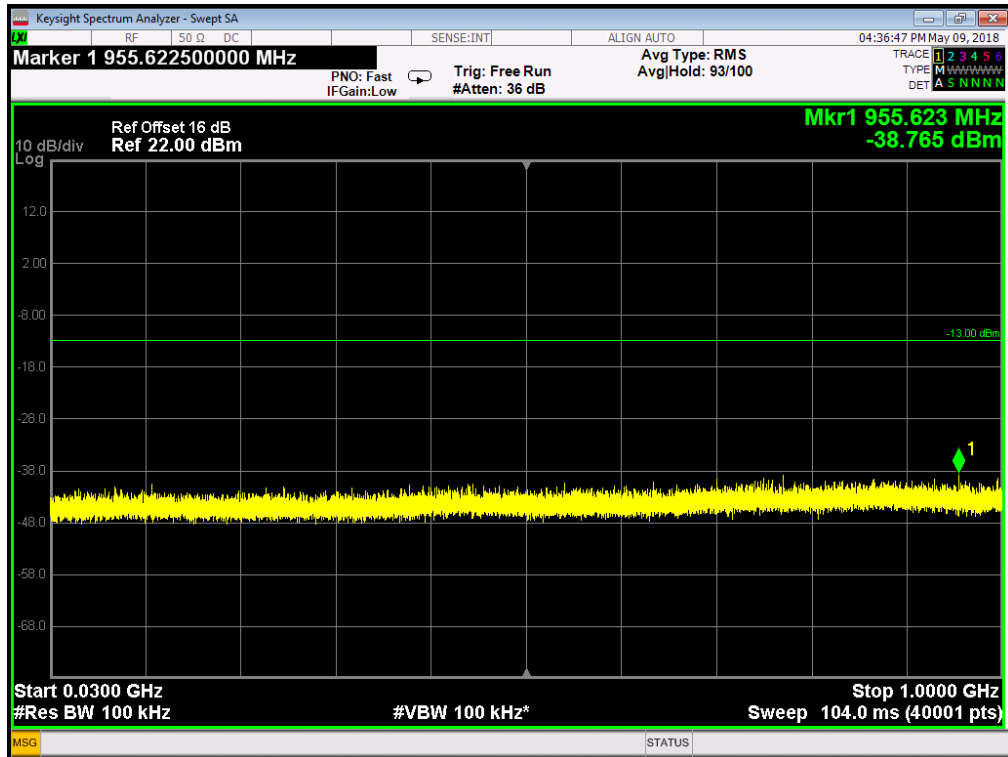

GSM 1900MHz Channel = 512, 30MHz to 1GHz

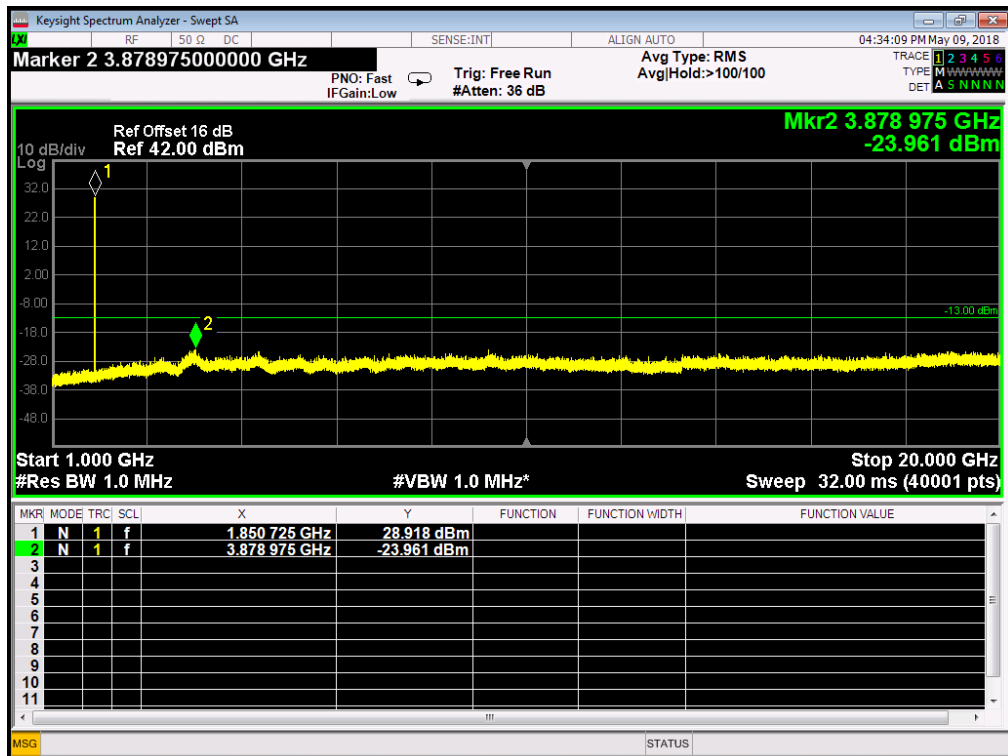

GSM 1900MHz Channel = 512, 1GHz to 20GHz

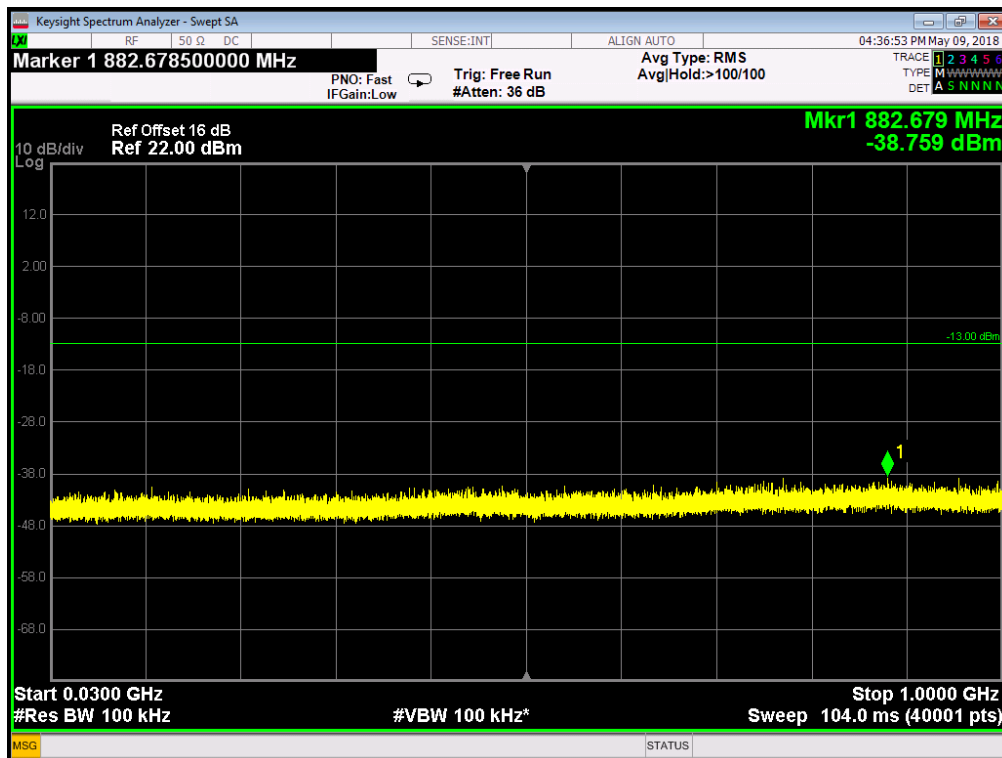

GSM 1900MHz Channel = 661, 30MHz to 1GHz

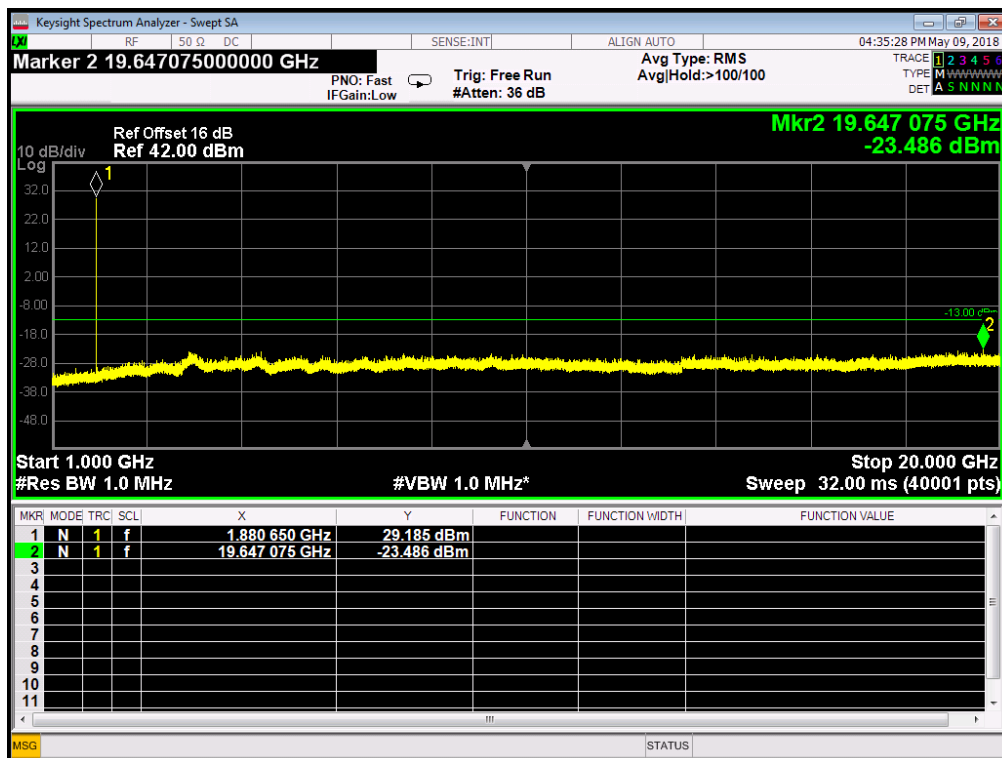

GSM 1900MHz Channel = 661, 1GHz to 20GHz

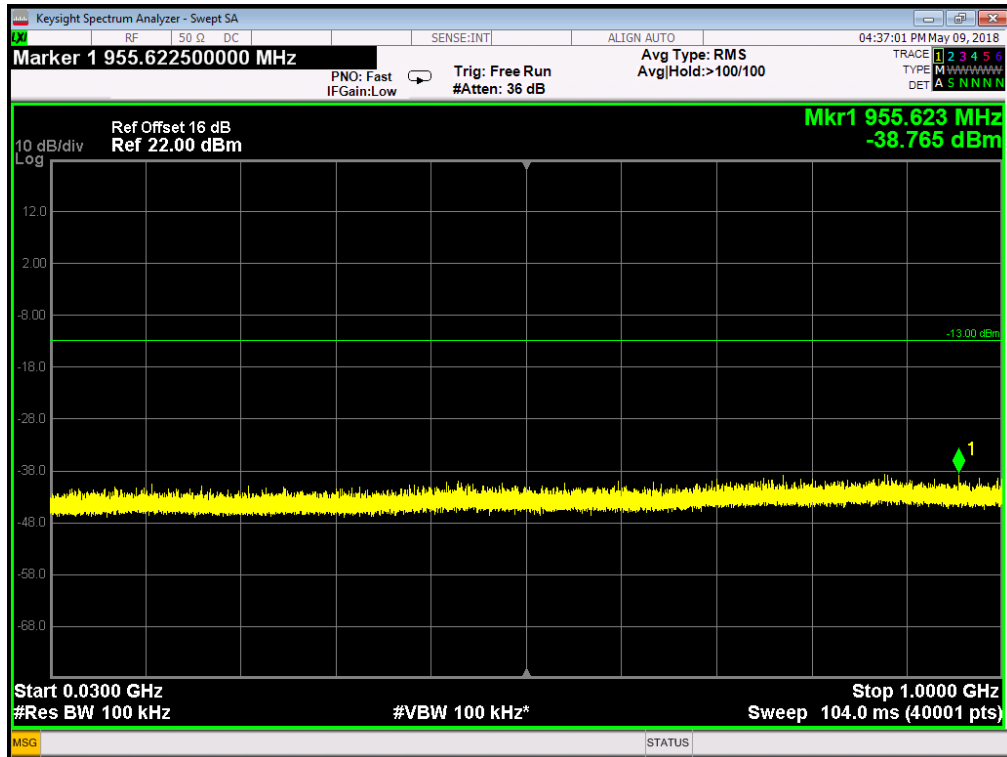

GSM 1900MHz Channel = 810, 30MHz to 1GHz

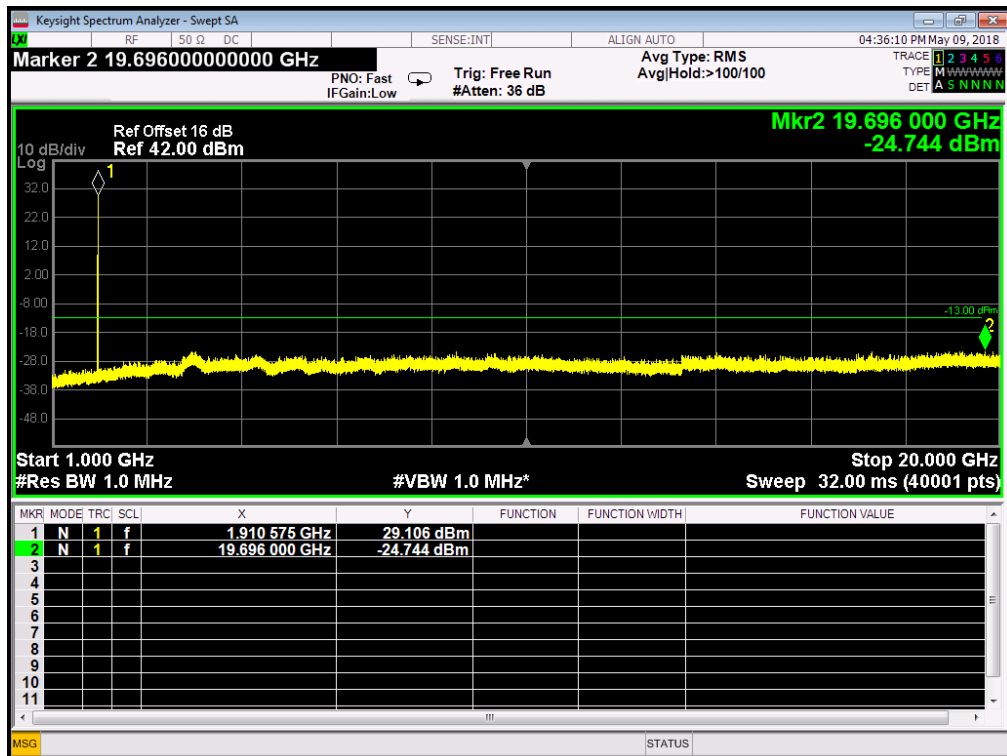

GSM 1900MHz Channel = 810, 1GHz to 20GHz

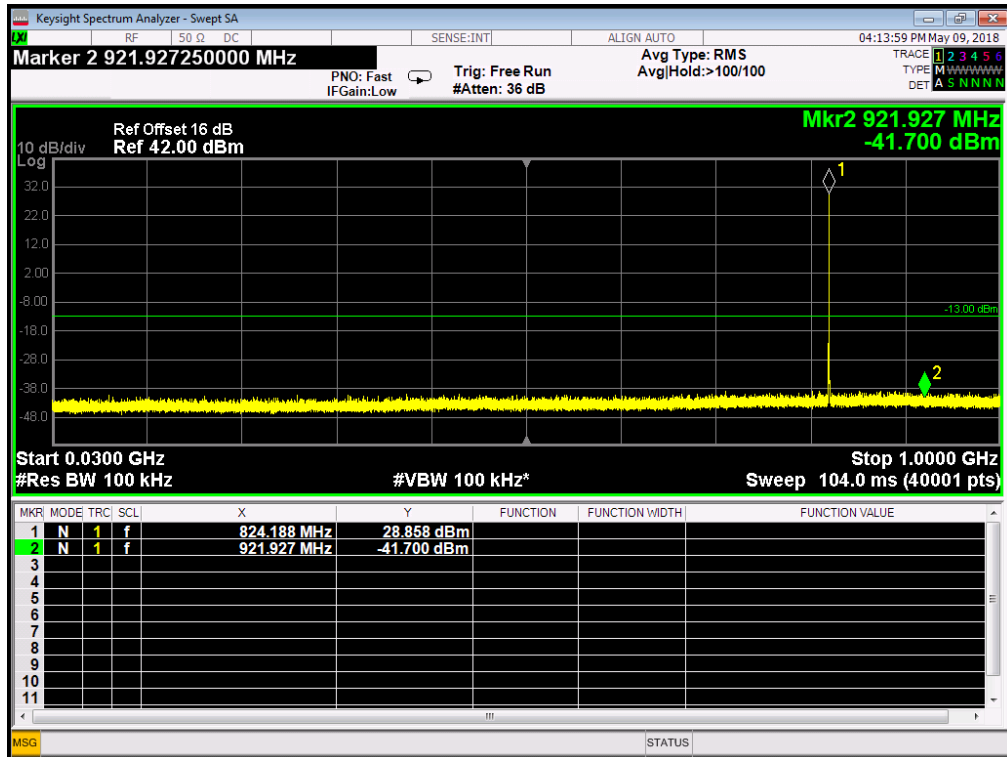

EDGE 850MHz Channel = 128, 30MHz to 1GHz

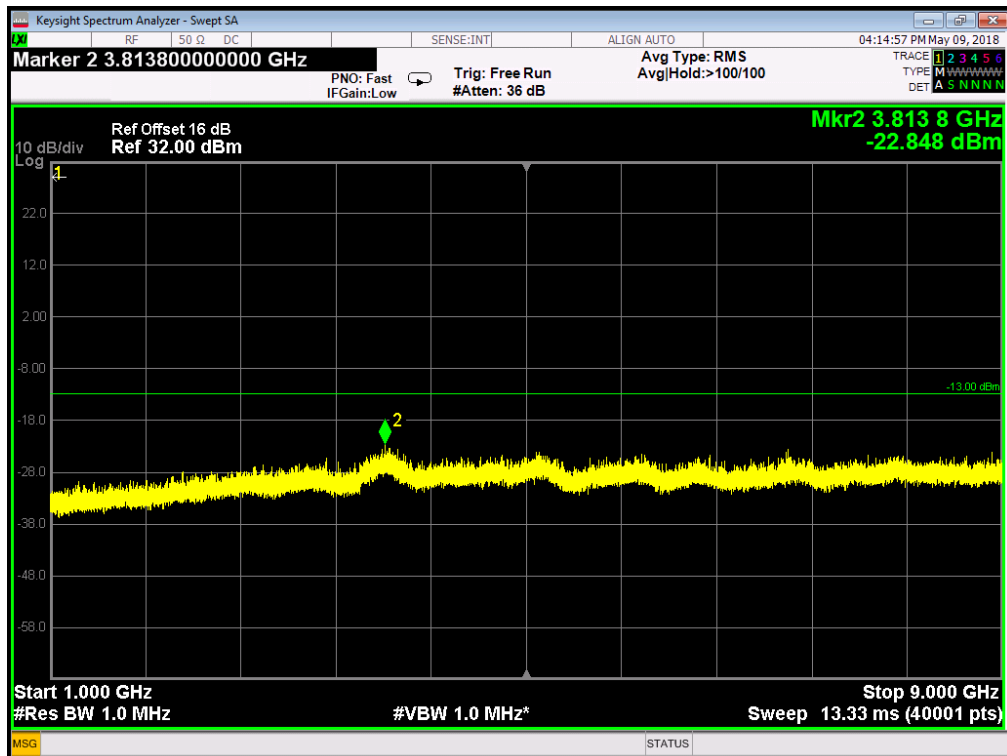

EDGE 850MHz Channel = 128, 1GHz to 9GHz

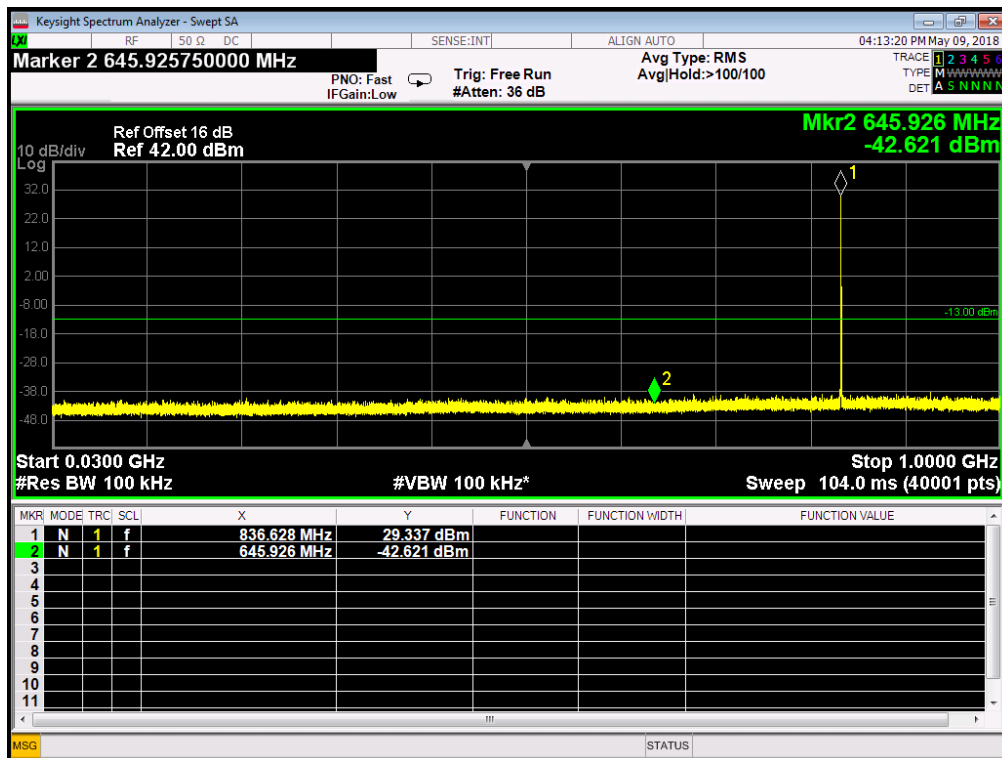

EDGE 850MHz Channel = 190, 30MHz to 1GHz

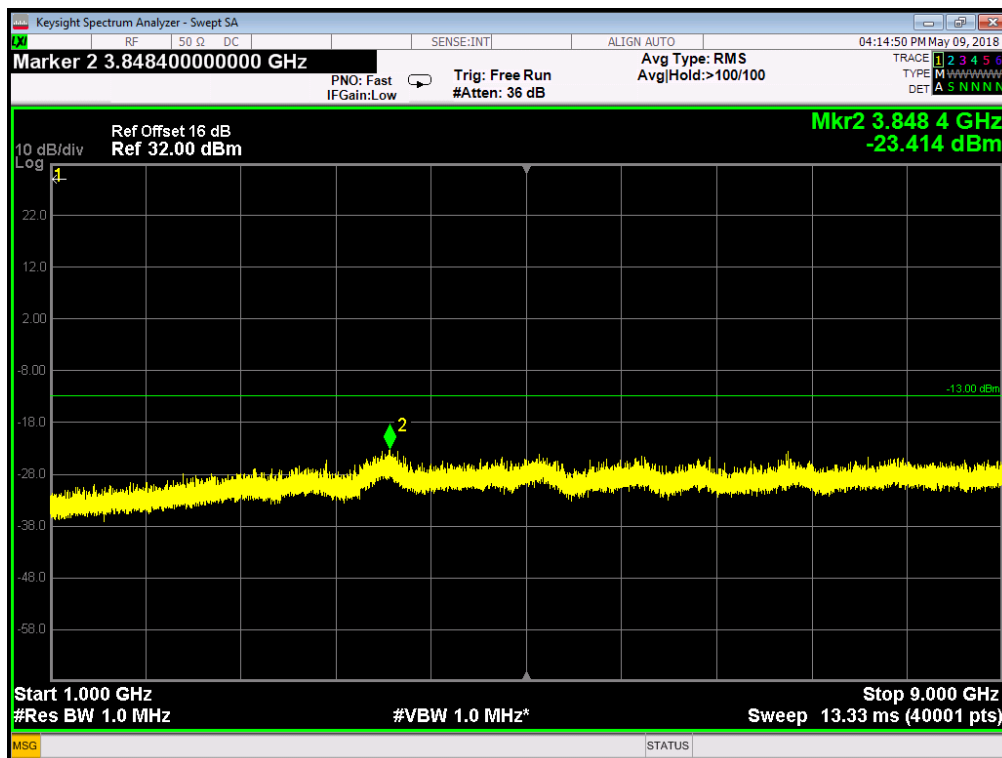

EDGE 850MHz Channel = 190, 1GHz to 9GHz

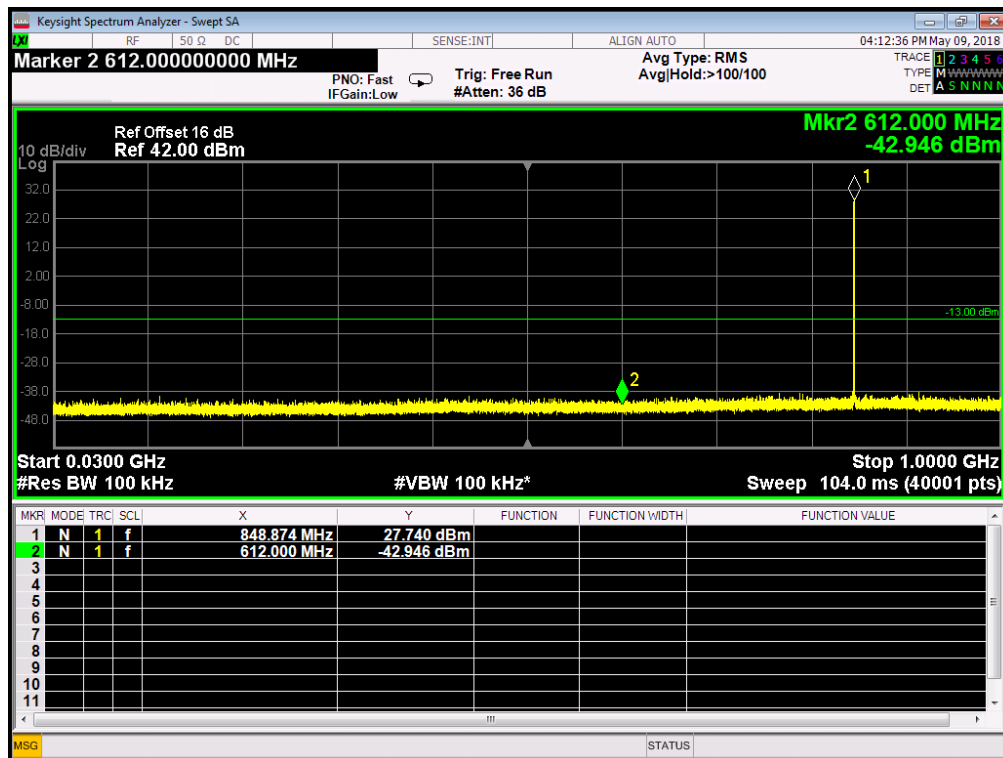

EDGE 850MHz Channel = 251, 30MHz to 1GHz

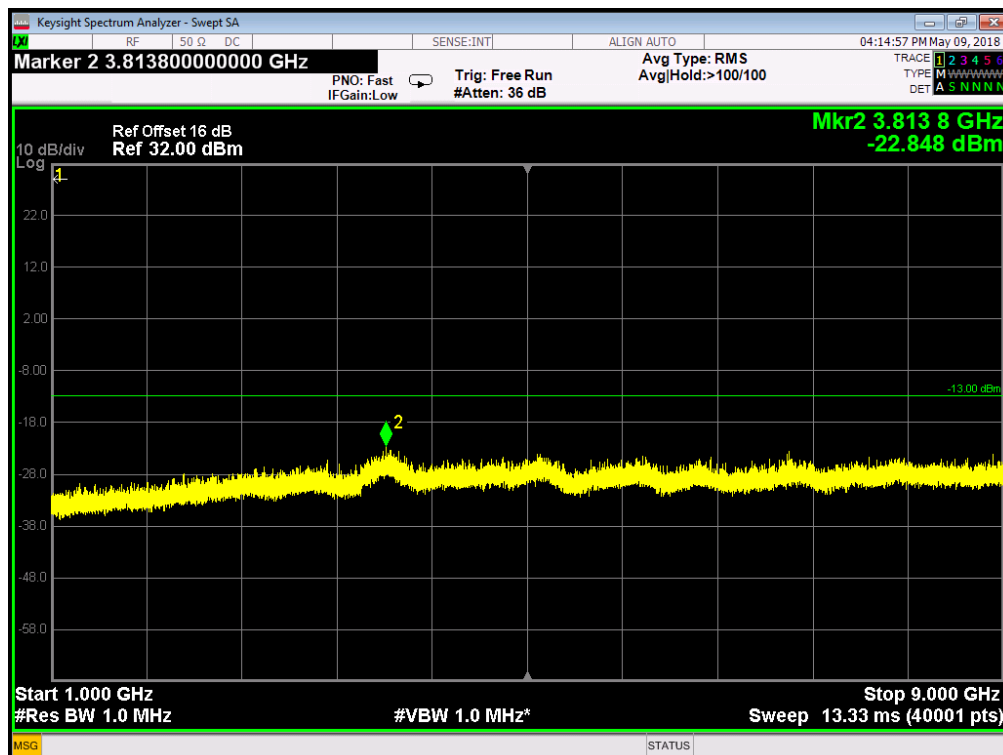

EDGE 850MHz Channel = 251, 1GHz to 9GHz

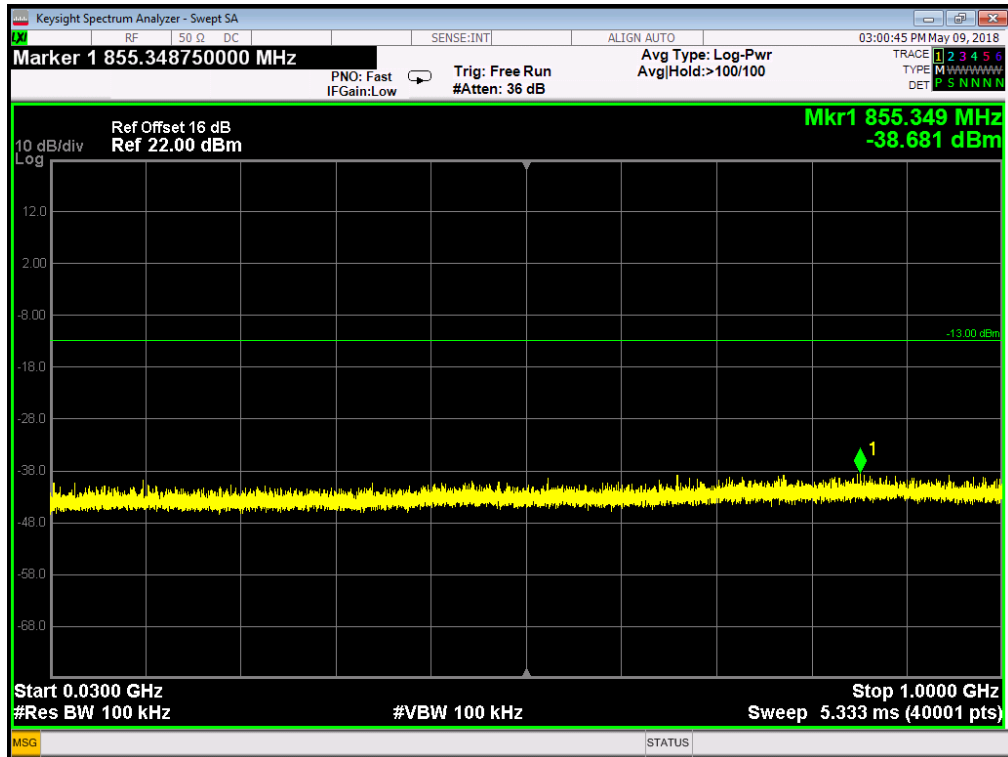

EDGE 1900MHz Channel = 512, 30MHz to 1GHz

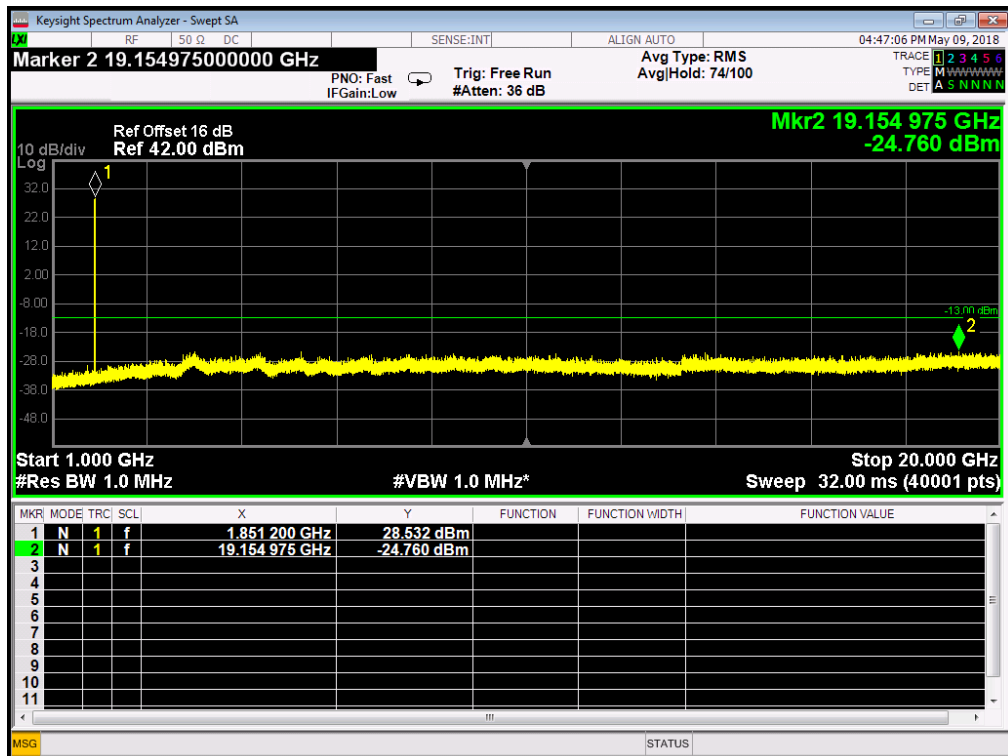

EDGE 1900MHz Channel = 512, 1GHz to 20GHz

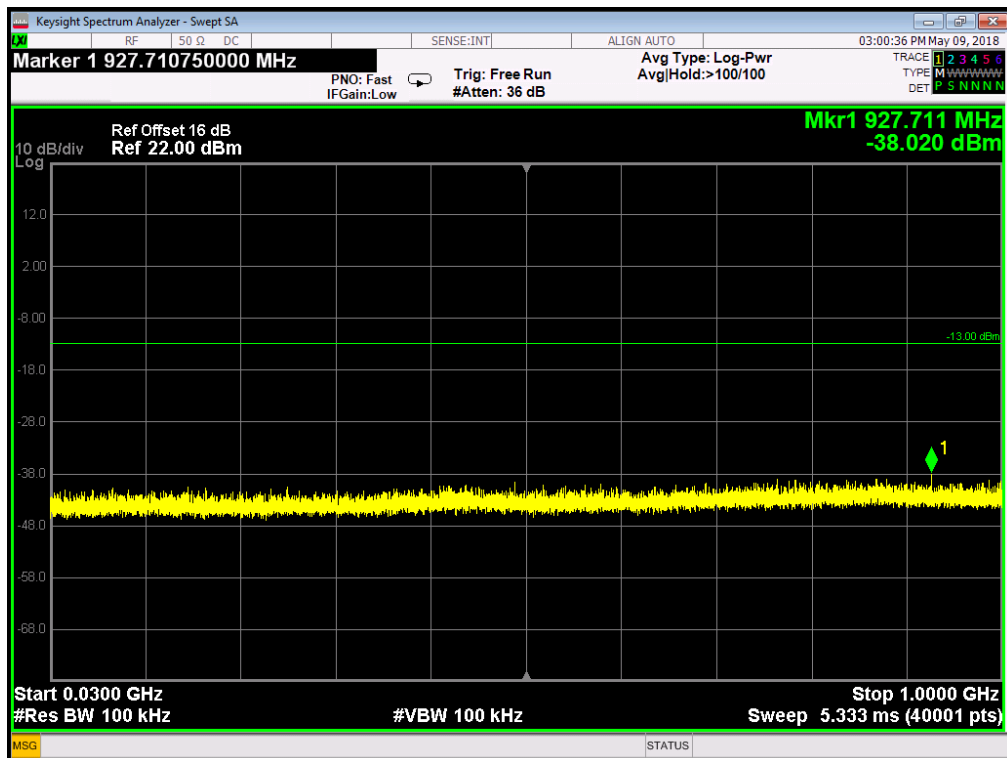

EDGE 1900MHz Channel = 661, 30MHz to 1GHz

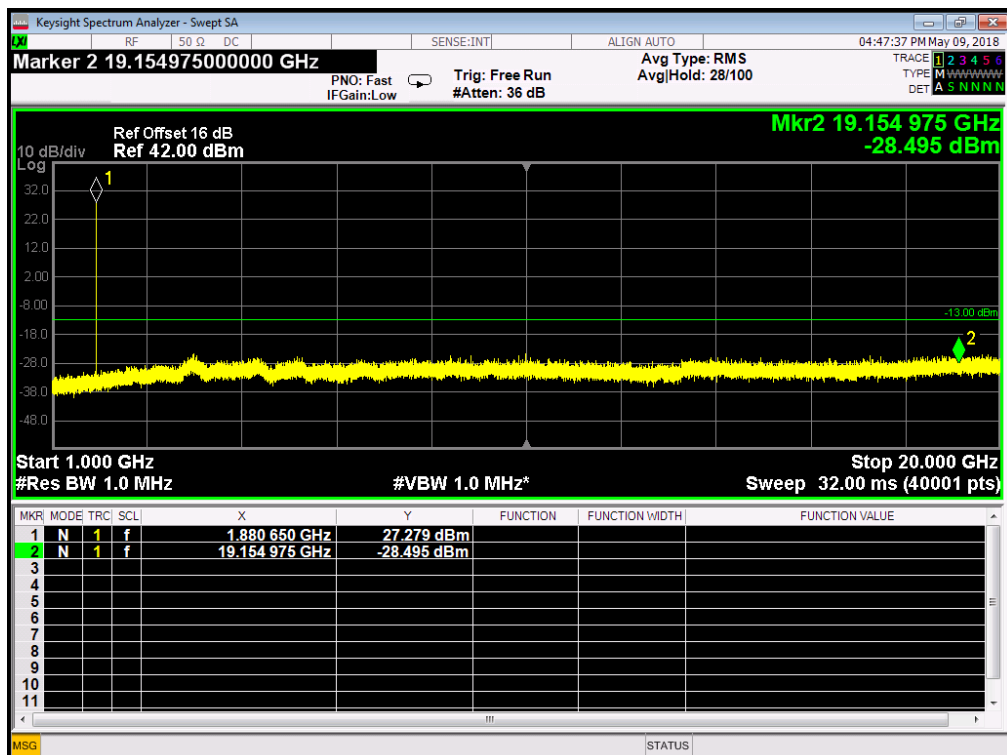

EDGE 1900MHz Channel = 661, 1GHz to 20GHz

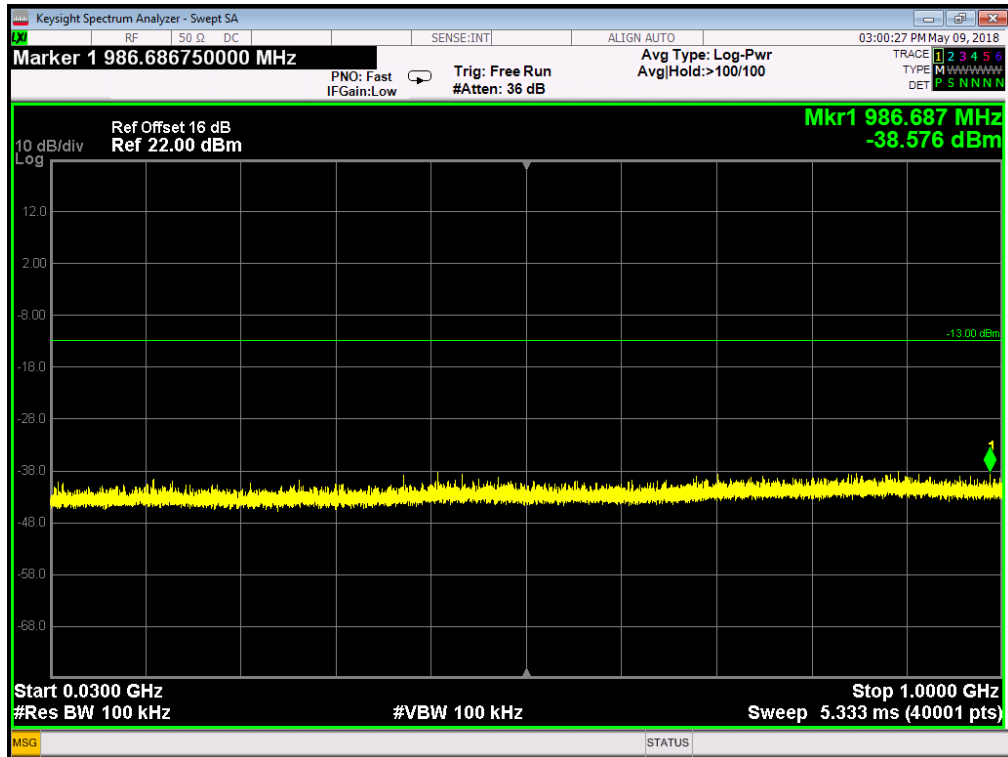

EDGE 1900MHz Channel = 810, 30MHz to 1GHz

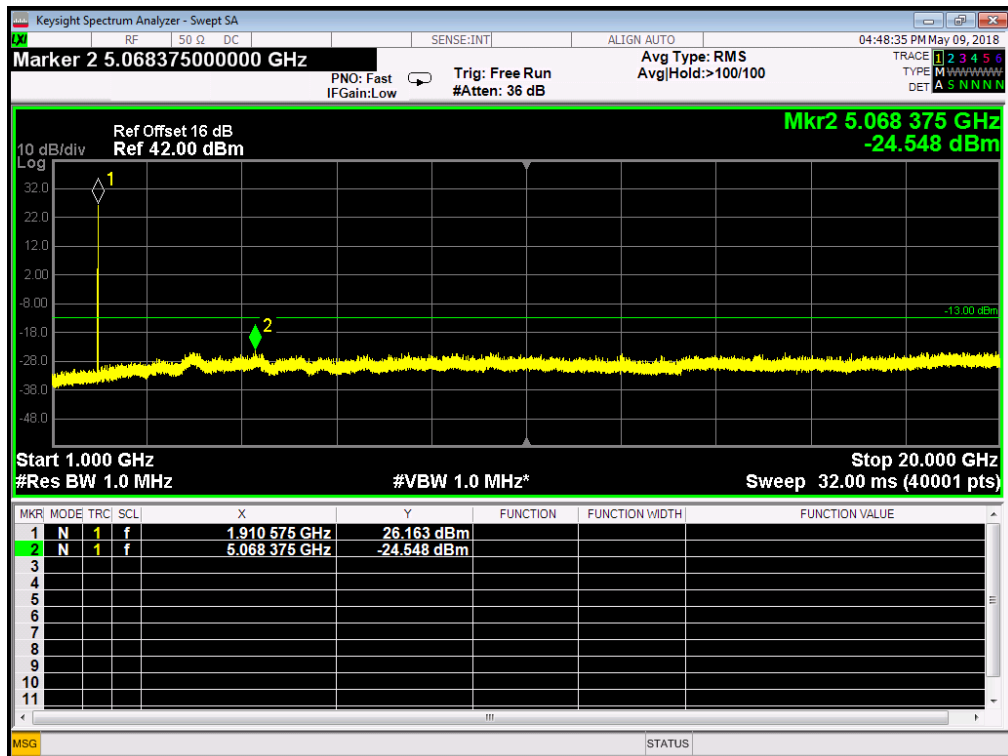

EDGE 1900MHz Channel = 810, 1GHz to 20GHz

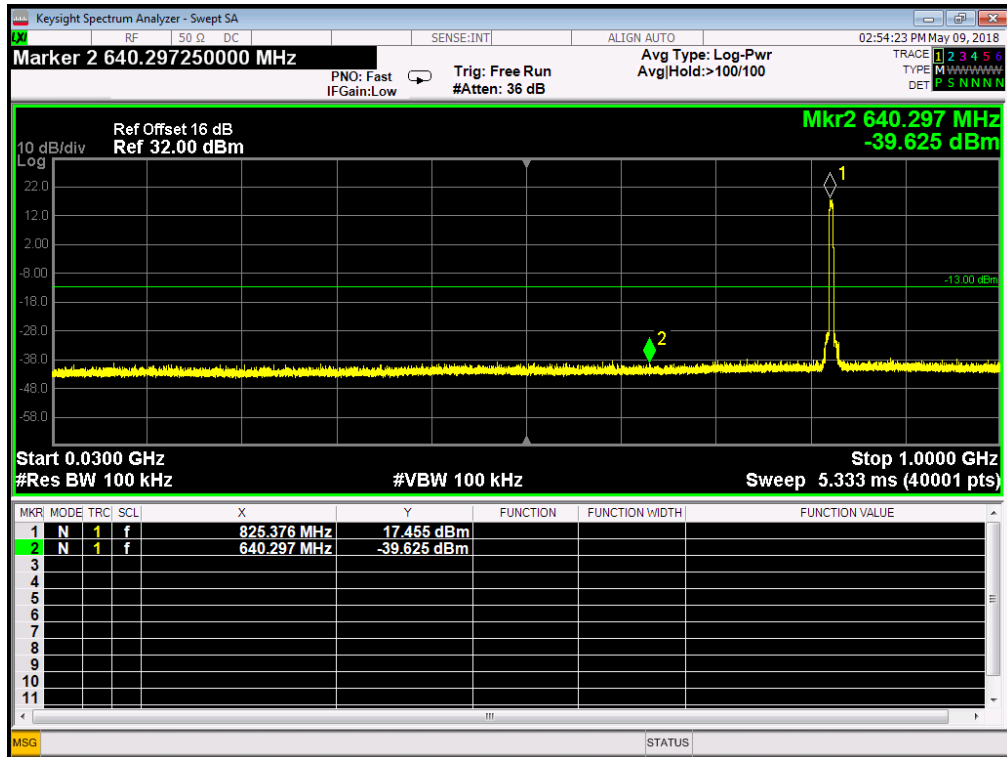

WCDMA850MHz Channel = 4132, 30MHz to 1GHz

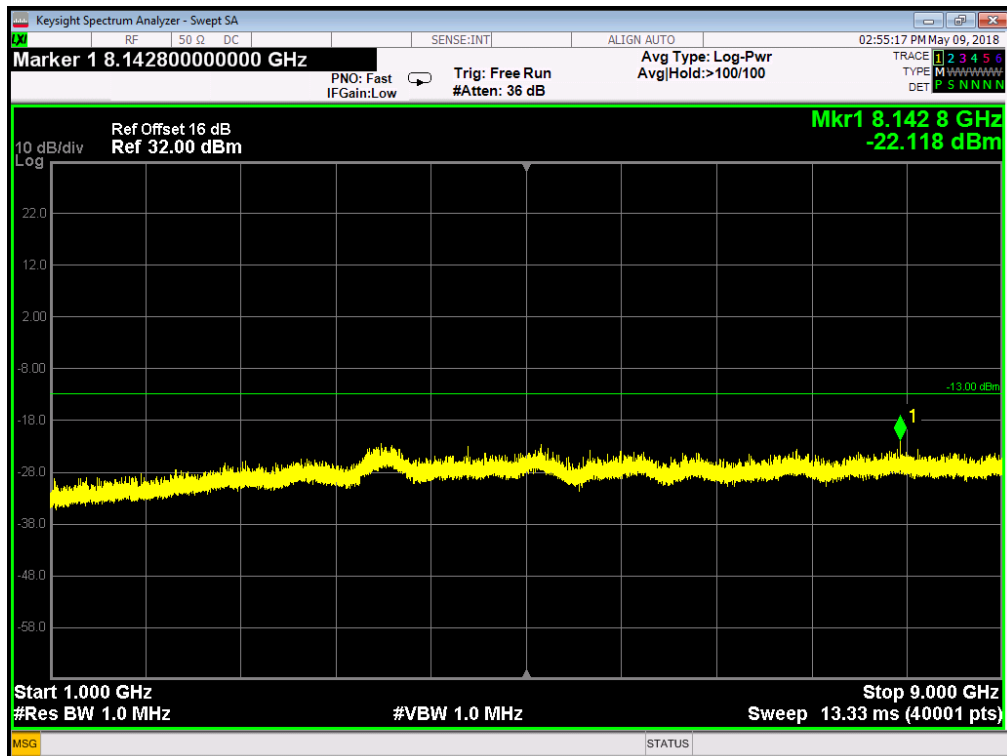

WCDMA850MHz Channel = 4132, 1GHz to 9GHz

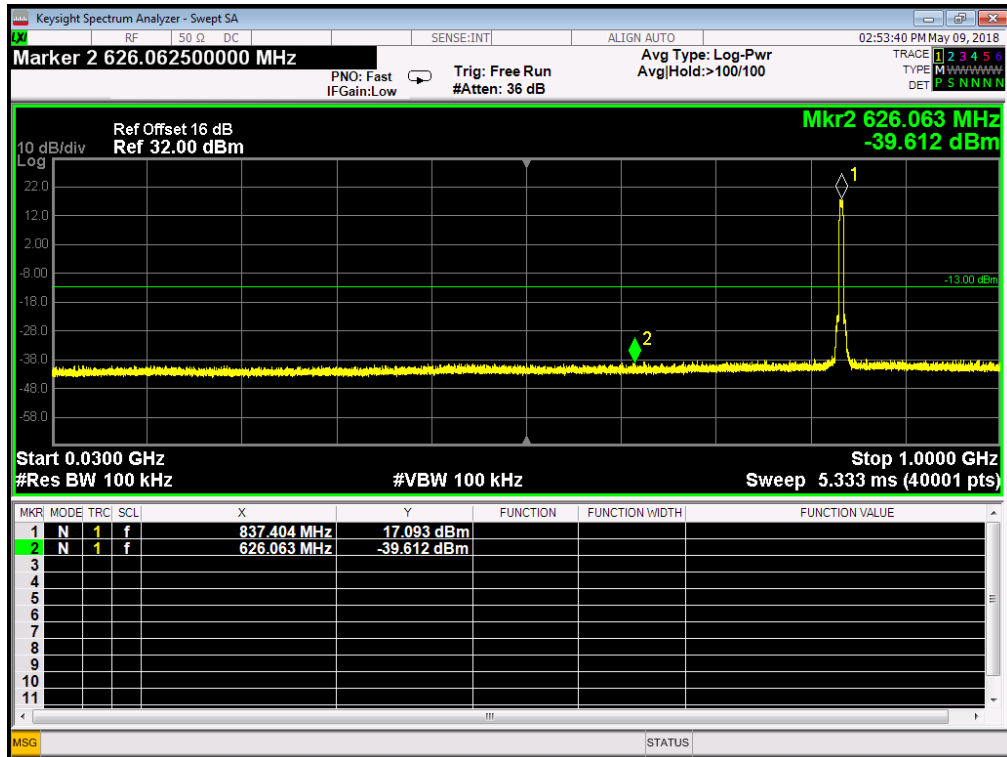

WCDMA850MHz Channel = 4183, 30MHz to 1GHz

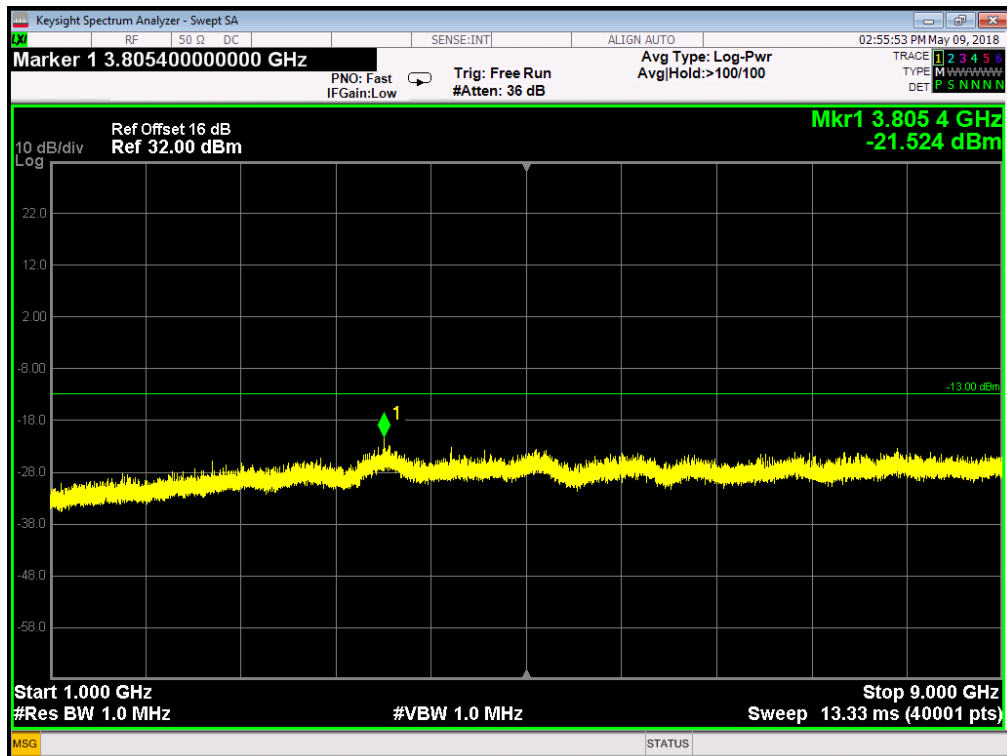

WCDMA850MHz Channel = 4183, 1GHz to 9GHz

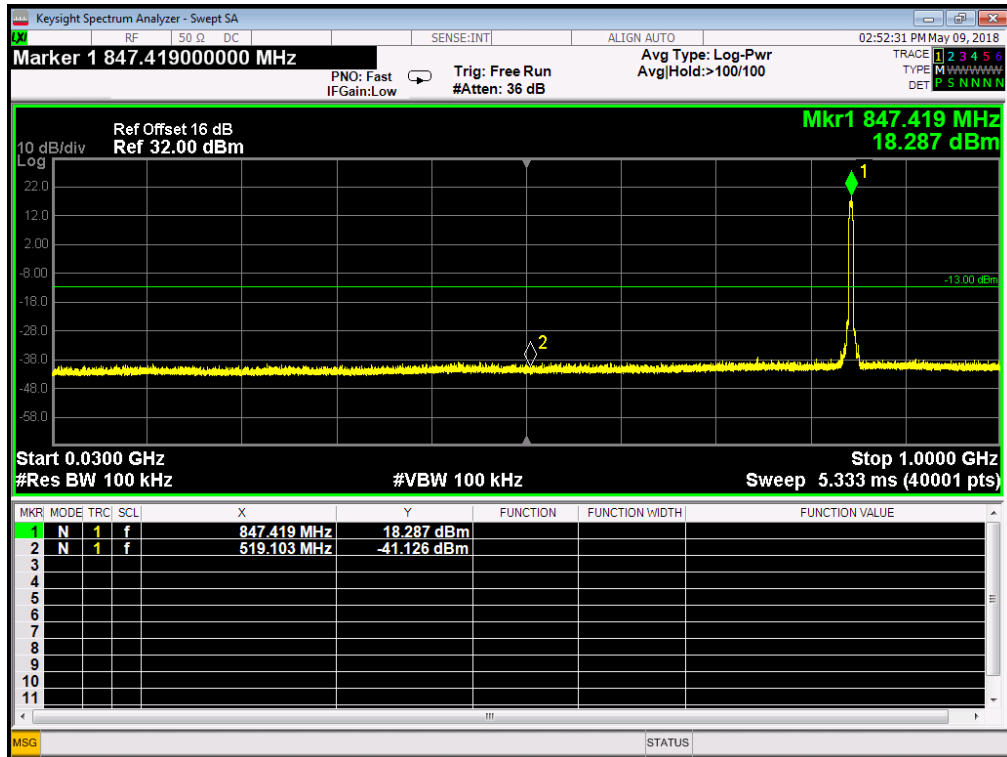

WCDMA850MHz Channel = 4233, 30MHz to 1GHz

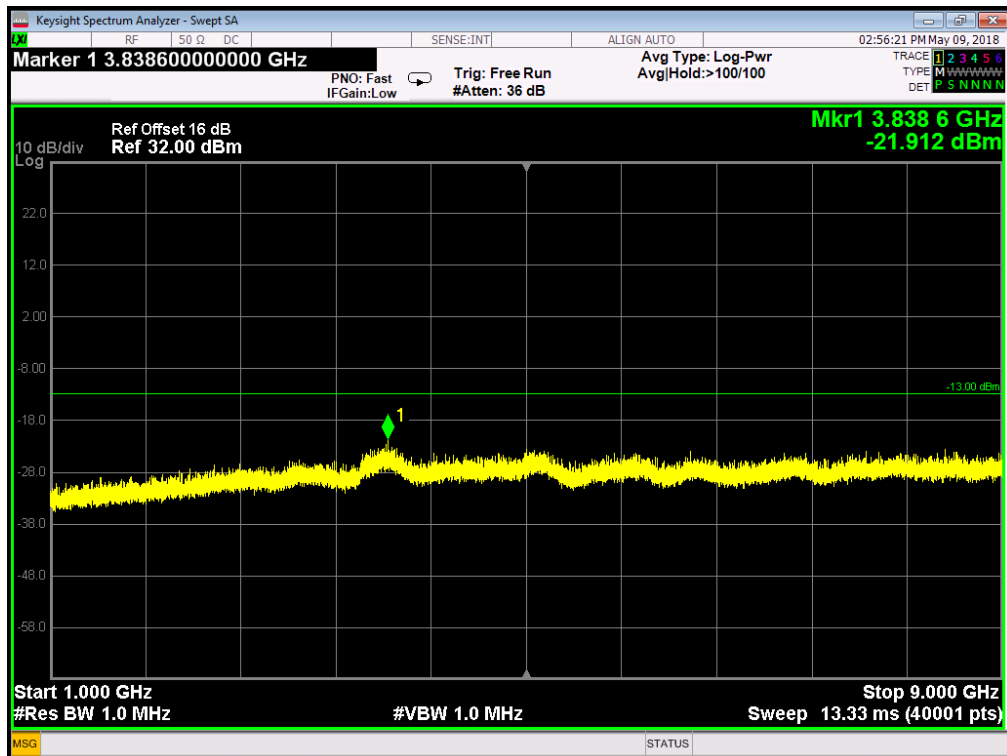

WCDMA850MHz Channel = 4233, 1GHz to 9GHz

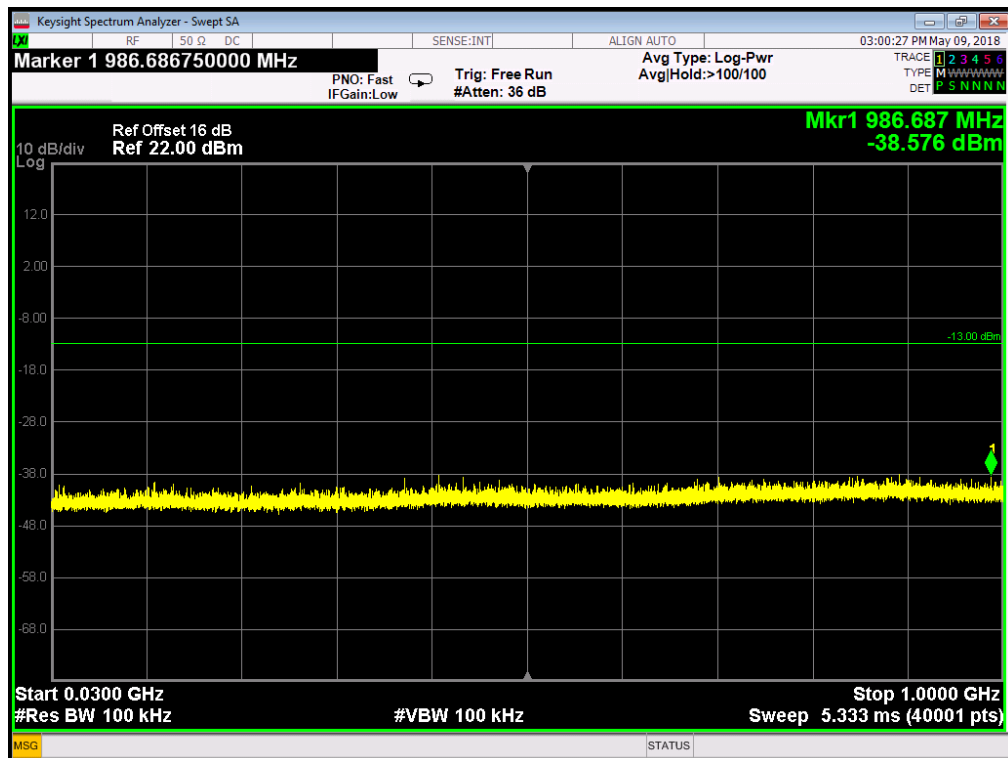

WCDMA1900MHz Channel = 9262, 30MHz to 1GHz

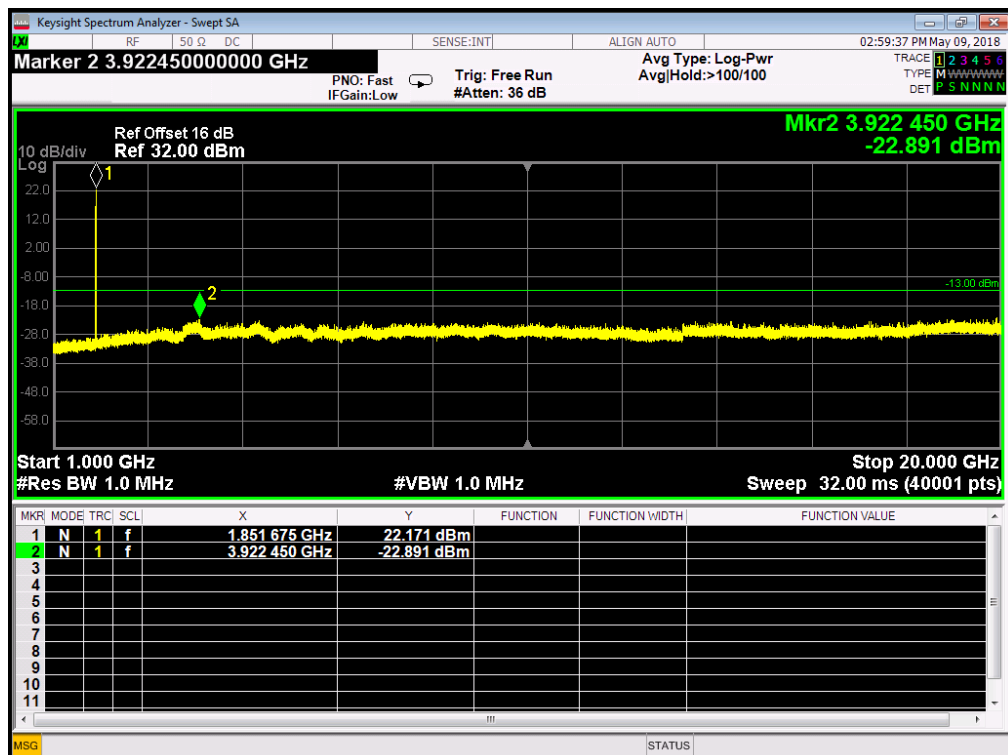

WCDMA1900MHz Channel = 9262, 1GHz to 20GHz

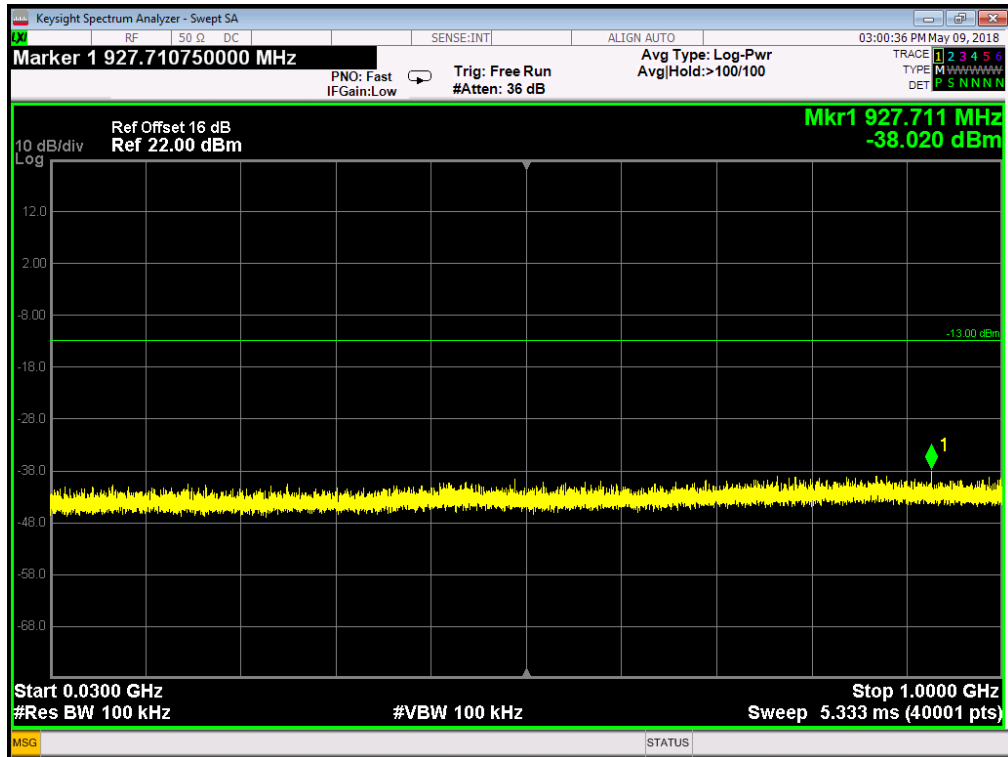

WCDMA1900MHz Channel = 9400, 30MHz to 1GHz

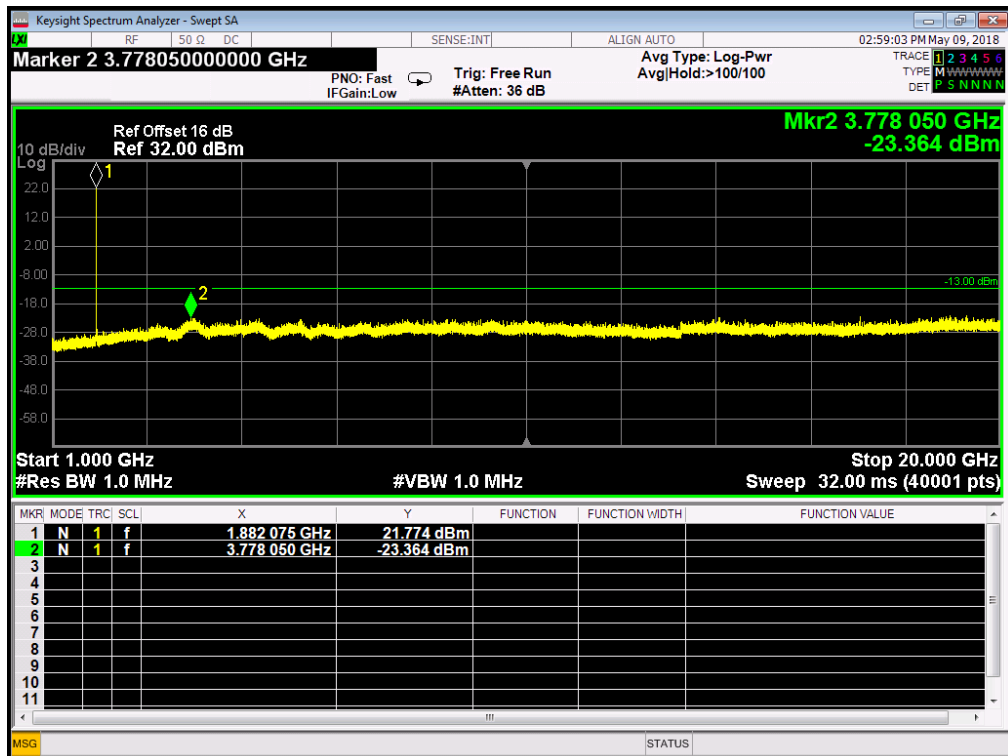

WCDMA1900MHz Channel = 9400, 1GHz to 20GHz

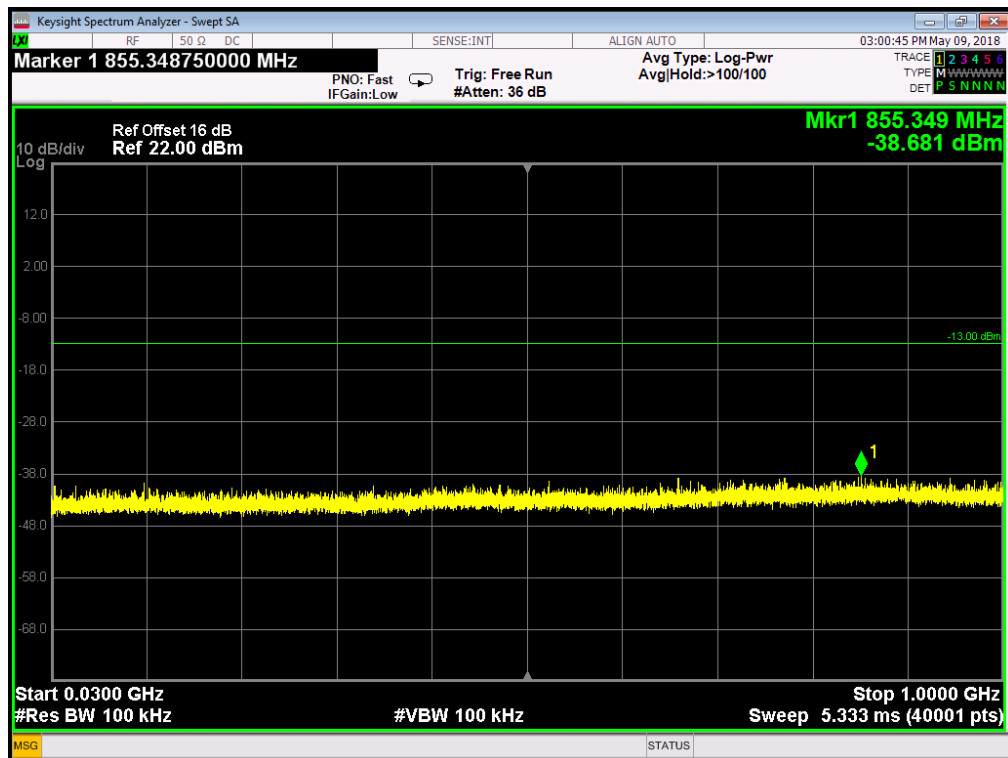

WCDMA1900MHz Channel = 9538, 30MHz to 1GHz

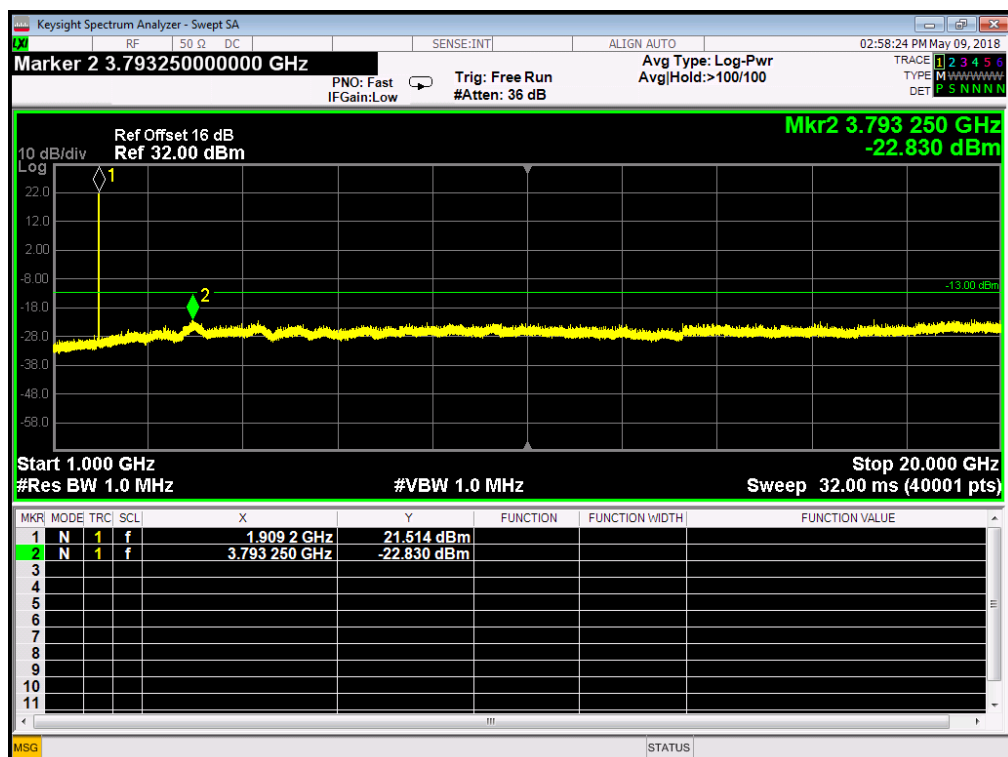

WCDMA1900MHz Channel = 9538 1GHz to 20GHz

2.6 Bandedge

2.6.1 Requirement

The power of any emission outside of the authorized operating frequency ranges must be lower than the transmitter power (P) by a factor of at least $43 + 10 \log (P)$ dB.

2.6.2 Measuring Instruments

The measuring equipment is listed in the section 3 of this test report.

2.6.3 Test Procedures

1. The testing follows FCC KDB 971168 D01 v03r01 Section 6.0.
2. The EUT was connected to the spectrum analyzer and system simulator via a power divider.
3. The RF output of EUT was connected to the spectrum analyzer by an RF cable and attenuator. The path loss was compensated to the results for each measurement.
4. The band GPRSs of low and high channels for the highest RF powers were measured.
5. The RF fundamental frequency should be excluded against the limit line in the operating frequency band.
6. The limit line is derived from $43 + 10\log(P)$ dB below the transmitter power P(Watts)
 $= P(W) - [43 + 10\log(P)]$ (dB)
 $= [30 + 10\log(P)]$ (dBm) - $[43 + 10\log(P)]$ (dB)
 $= -13\text{dBm}$.

2.6.4 Test Setup

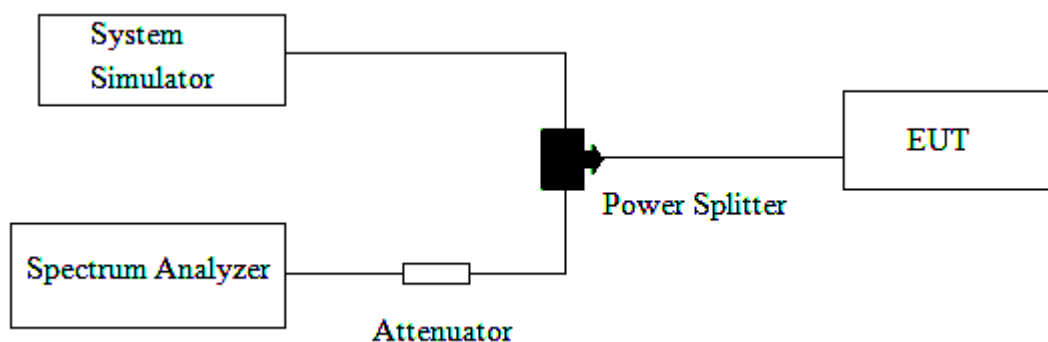

**2.6.5 Test Result of Conducted Bandedge**

Band	Channel	Frequency (MHz)	Measured Max. Bandedge Emission (dBm)	Refer to Plot	Limit (dBm)	Verdict
GSM 850MHz	128	824.2	-19.62	Plat A	-13	PASS
	251	848.8	-15.13	Plot B		PASS
GSM 1900MHz	512	1850.2	-19.74	Plat C	-13	PASS
	810	1909.8	-17.94	Plot D		PASS
EDGE 850MHz	128	824.2	-24.04	Plat E	-13	PASS
	251	848.8	-24.73	Plot F		PASS
EDGE 1900MHz	512	1850.2	-28.64	Plat G	-13	PASS
	810	1909.8	-25.19	Plot H		PASS
WCDMA 850MHz	4132	826.4	-27.23	Plot I	-13	PASS
	4233	846.6	-25.20	Plot J		PASS
WCDMA 1900MHz	9262	1852.4	-23.16	Plot K	-13	PASS
	9538	1907.6	-19.31	Plot L		PASS

2.6.6 Test Result (Plots) of Conducted Bandedge

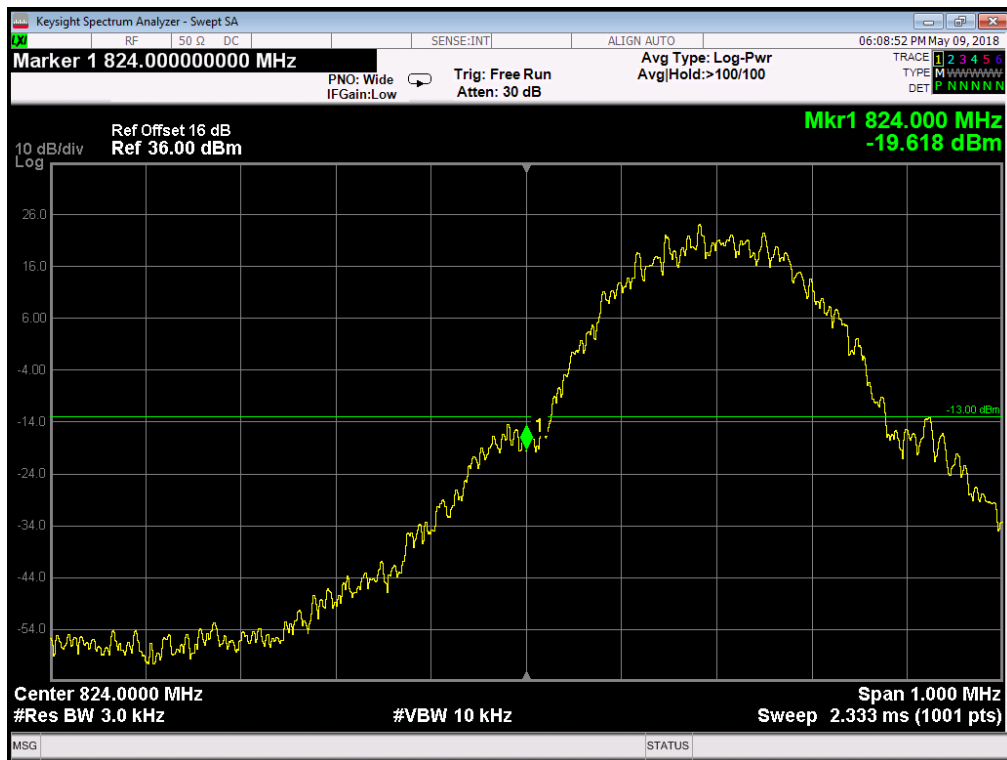

(Plot A: GSM 850 Channel = 128)



(Plot B: GSM 850 Channel = 251)

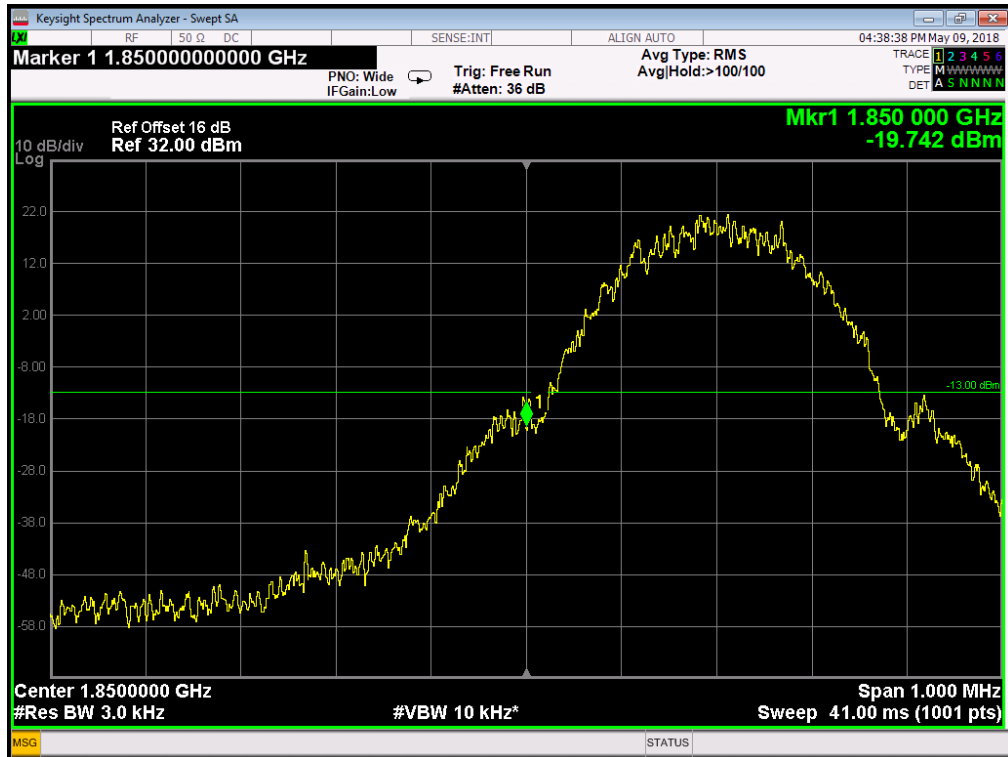

(Plot C: GSM 1900 Channel = 512)

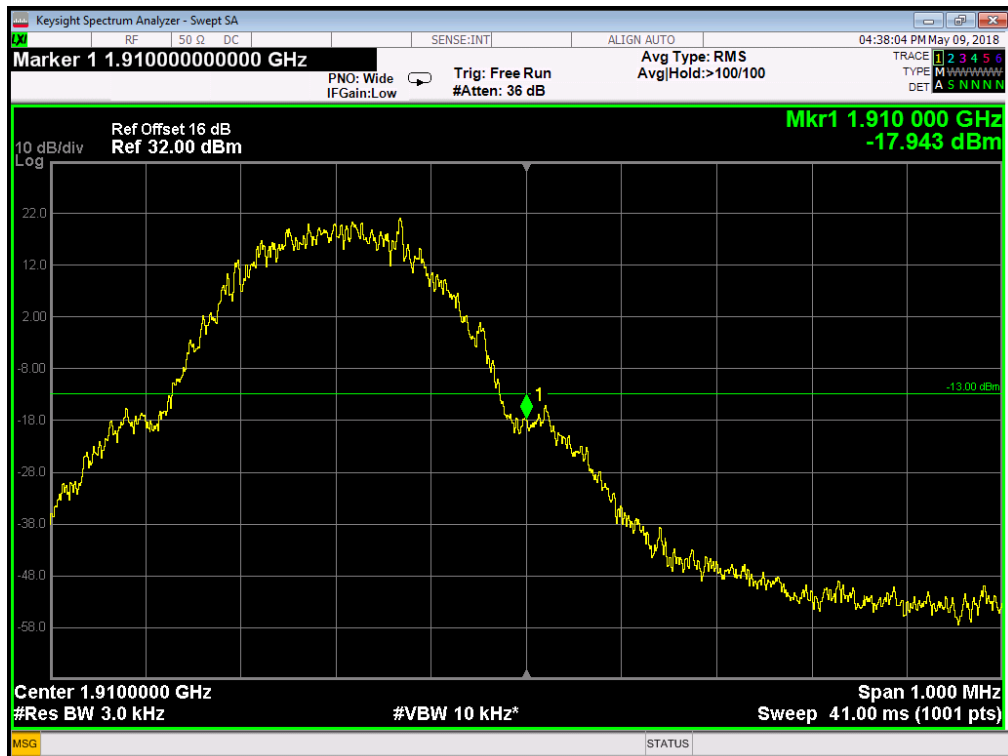

(Plot D: GSM 1900 Channel = 810)

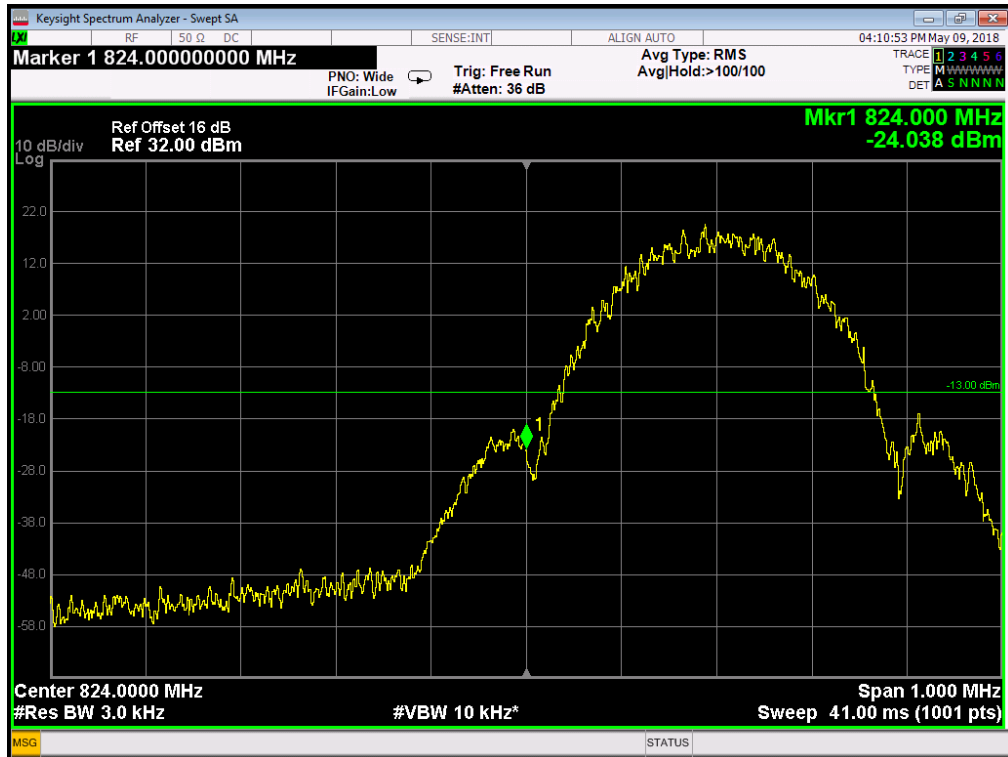

(Plot E: EDGE 850 Channel = 128)

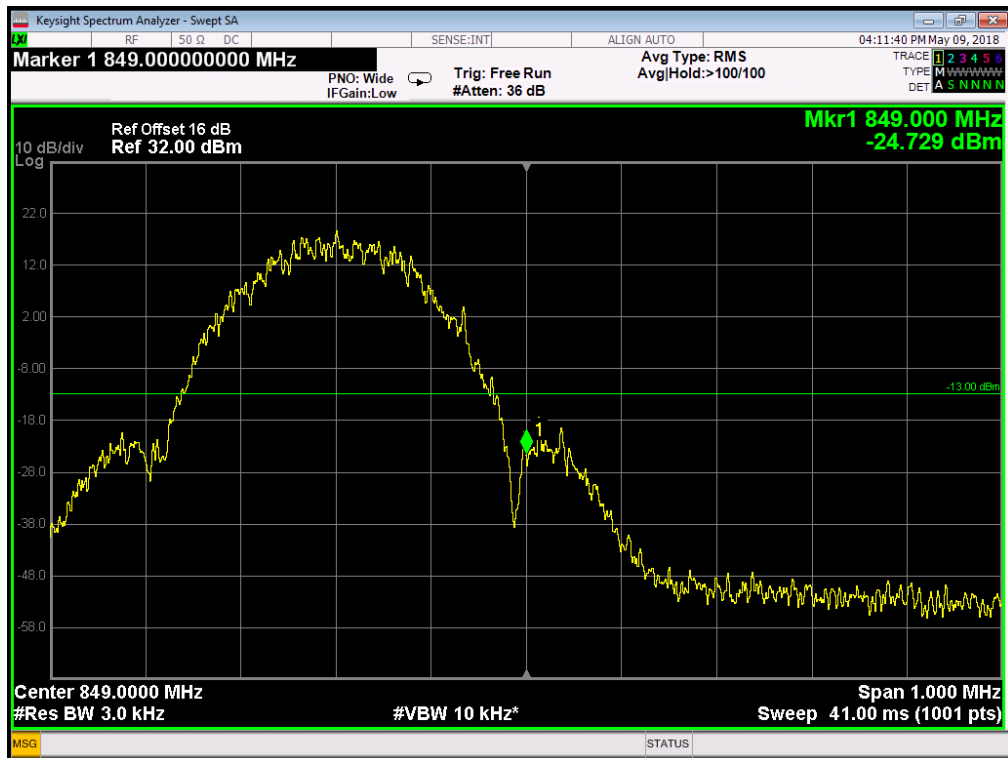

(Plot F: EDGE 850 Channel = 251)

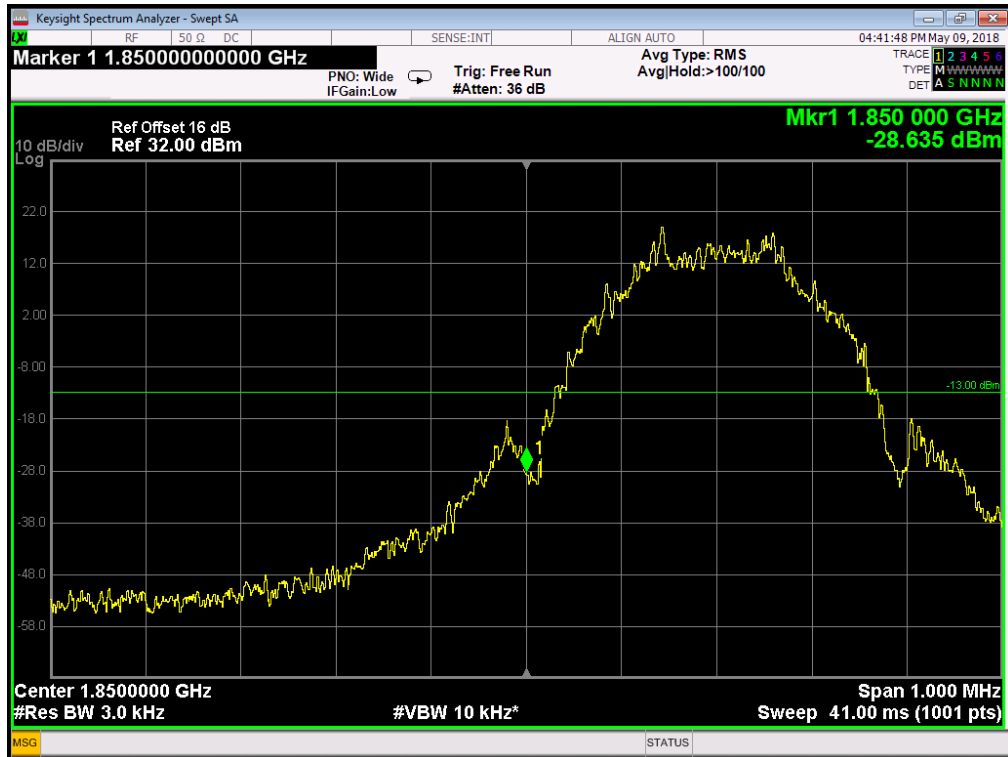

(Plot G: EDGE 1900 Channel = 512)



(Plot H: EDGE 1900 Channel = 810)

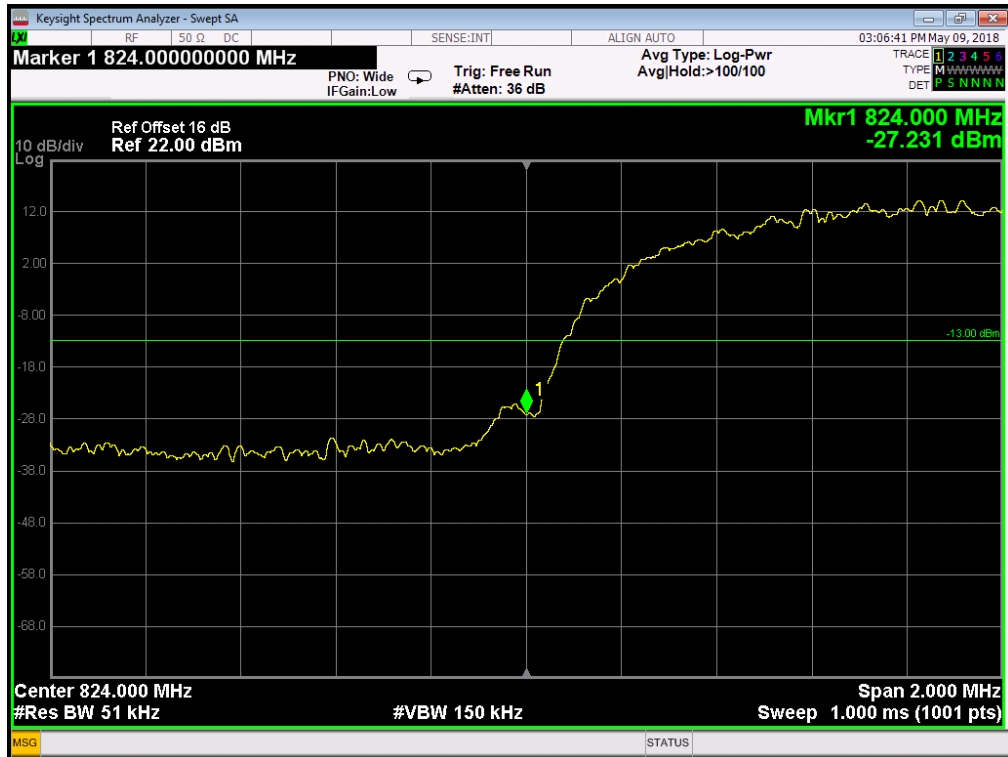

(Plot I: WCDMA 850 Channel = 4132)



(Plot J: WCDMA 850 Channel = 4233)

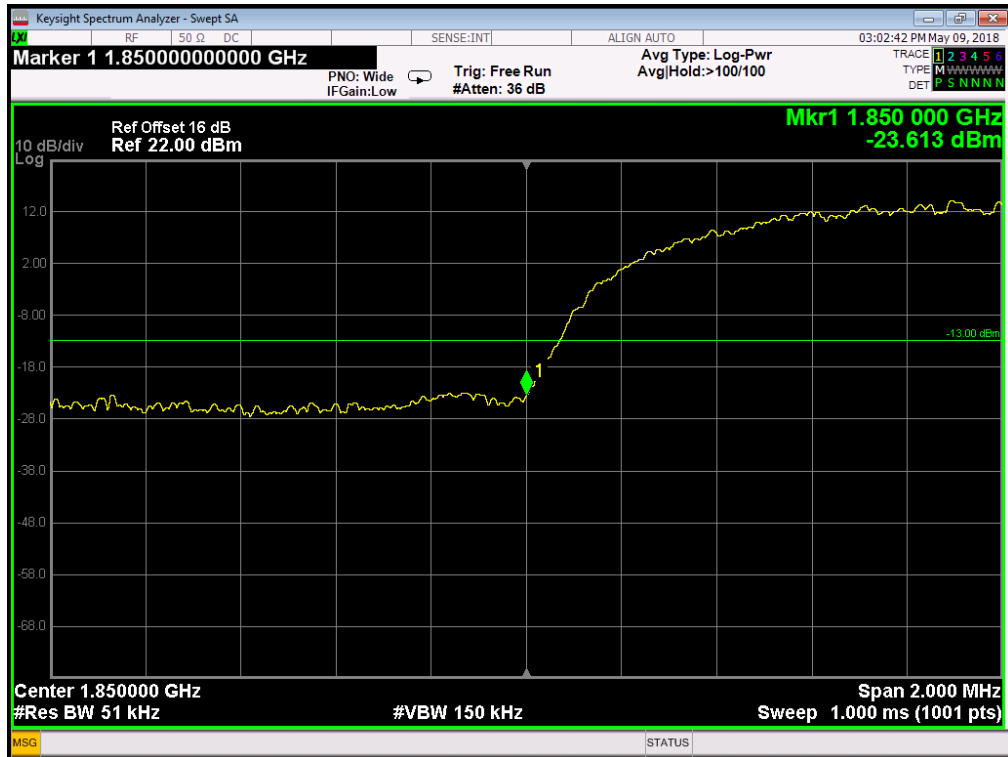

(Plot K: WCDMA 1900 Channel = 9262)



(Plot L: WCDMA 1900 Channel = 9538)

2.7 Transmitter Radiated Power (EIRP/ERP)

2.7.1 Requirement

The substitution method, in ANSI / TIA / EIA-603-D-2010, was used for ERP/EIRP measurement, and the spectrum analyzer configuration follows KDB 971168 D01 Power Meas. License Digital Systems v03r01. The ERP of mobile transmitters must not exceed 7 Watts (Cellular Band) and the EIRP of mobile transmitters are limited to 2 Watts (PCS Band) and 1 Watts (AWS Band).

2.7.2 Measuring Instruments

The measuring equipment is listed in the section 3 of this test report.

2.7.3 Test Procedures

1. The testing follows FCC KDB 971168 D01 v03r01 Section 5.2.1. (for CDMA/WCDMA), Section 5.2.2.2 (for GSM/GSM/GPRS) and ANSI / TIA-603-D-2010 Section 2.2.17.
2. The EUT was placed on a turntable 1.5 meters high in a fully anechoic chamber.
3. The EUT was placed 3 meters from the receiving antenna, which was mounted on the antenna tower.
4. GSM operating modes: Set RBW= 1MHz, VBW= 3MHz, RMS detector over burst;
UMTS operating modes: Set RBW= 100 kHz, VBW= 300 kHz, RMS detector over frame, and use channel power option with bandwidth=5MHz, per KDB 971168 D01 v03r01.
5. The table was rotated 360 degrees to determine the position of the highest radiated power.
6. The height of the receiving antenna is adjusted to look for the maximum ERP/EIRP.
7. Taking the record of maximum ERP/EIRP.
8. A dipole antenna was substituted in place of the EUT and was driven by a signal generator.

9. The conducted power at the terminal of the dipole antenna is measured.
10. Repeat step 3 to step 5 to get the maximum ERP/EIRP of the substitution antenna.
11. $ERP/EIRP = P_s + E_t - E_s + G_s = P_s + R_t - R_s + G_s$

P_s (dBm): Input power to substitution antenna.

G_s (dBi or dBd): Substitution antenna Gain.

$E_t = R_t + AF$ $E_s = R_s + AF$

AF (dB/m): Receive antenna factor

R_t : The highest received signal in spectrum analyzer for EUT.

R_s : The highest received signal in spectrum analyzer for substitution antenna.

2.7.4 Test Setup

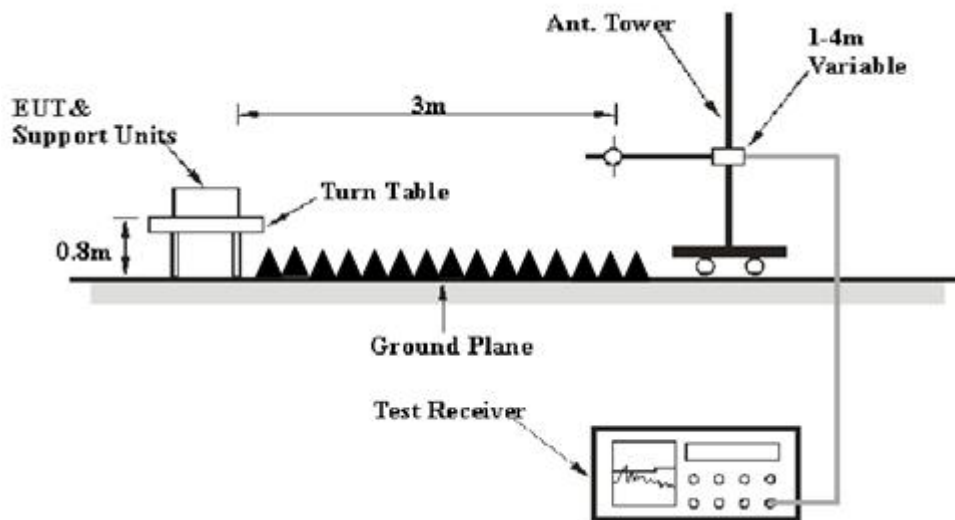



2.7.5 Test Result of Transmitter Radiated Power

Test Notes:

1. This device employs GMSK technology with GSM capabilities. All configurations were investigated and the worst case emissions were found in GSM mode.
2. This device employs UMTS technology with WCDMA (AMR/RMC), HSDPA, HSUPA capabilities. All configurations were investigated and the worst case UMTS emissions were found in RMC WCDMA mode at 12.2Kbps.
3. This unit was tested with its standard battery.
4. The worst case test configuration was found in the vertical positioning where the EUT is laying on its side. The data reported in the tables below were measured in this test setup.

Band	Channel	Frequency (MHz)	PCL	Antenna Pol (H/V)	Measured ERP dBm	Limit dBm	Verdict
GSM 850MHz	128	824.20	5	H	32.35	38.5	PASS
				V	29.84		
	190	836.60	5	H	32.15		PASS
				V	29.64		
	251	848.80	5	H	32.26		PASS
				V	28.59		

Band	Channel	Frequency (MHz)	PCL	Antenna Pol (H/V)	Measured EIRP dBm	Limit dBm	Verdict
GSM 1900MHz	512	1850.2	0	H	30.25	33	PASS
				V	27.69		
	661	1880.0	0	H	30.35		PASS
				V	27.56		
	810	1909.8	0	H	30.09		PASS
				V	27.66		



Band	Channel	Frequency (MHz)	PCL	Antenna Pol (H/V)	Measured ERP dBm	Limit dBm	Verdict
EDGE 850MHz	128	824.20	5	H	26.38	38.5	PASS
				V	24.15		
	190	836.60	5	H	26.69		PASS
				V	24.08		
	251	848.80	5	H	26.84		PASS
				V	24.21		

Band	Channel	Frequency (MHz)	PCL	Antenna Pol (H/V)	Measured EIRP dBm	Limit dBm	Verdict
EDGE 1900MHz	512	1850.2	0	H	26.23	33	PASS
				V	24.04		
	661	1880.0	0	H	26.38		PASS
				V	24.03		
	810	1909.8	0	H	26.19		PASS
				V	24.00		

Band	Channel	Frequency (MHz)	Antenna Pol (H/V)	Measured ERP dBm	Limit dBm	Verdict
WCDMA 850MHz	4132	826.4	H	22.56	38.5	PASS
			V	22.09		
	4175	835	H	22.41		PASS
			V	22.04		
	4233	846.6	H	22.65		PASS
			V	22.07		

Band	Channel	Frequency (MHz)	Antenna Pol (H/V)	Measured EIRP dBm	Limit dBm	Verdict
WCDMA 1900MHz	9262	1852.4	H	22.35	33	PASS
			V	22.15		
	9400	1880	H	22.24		PASS
			V	22.09		
	9538	1907.6	H	22.32		PASS
			V	22.11		

2.8 Radiated Spurious Emissions

2.8.1 Requirement

The power of any emission outside of the authorized operating frequency ranges must be attenuated below the transmitter power (P) by a factor of at least $43 + 10 \log (P)$ dB. The spectrum is scanned from 30 MHz up to a frequency including its 10th harmonic.

2.8.2 Measuring Instruments

The measuring equipment is listed in the section 3 of this test report.

2.8.3 Test Setup

For radiated emissions from 9 kHz to 30MHz

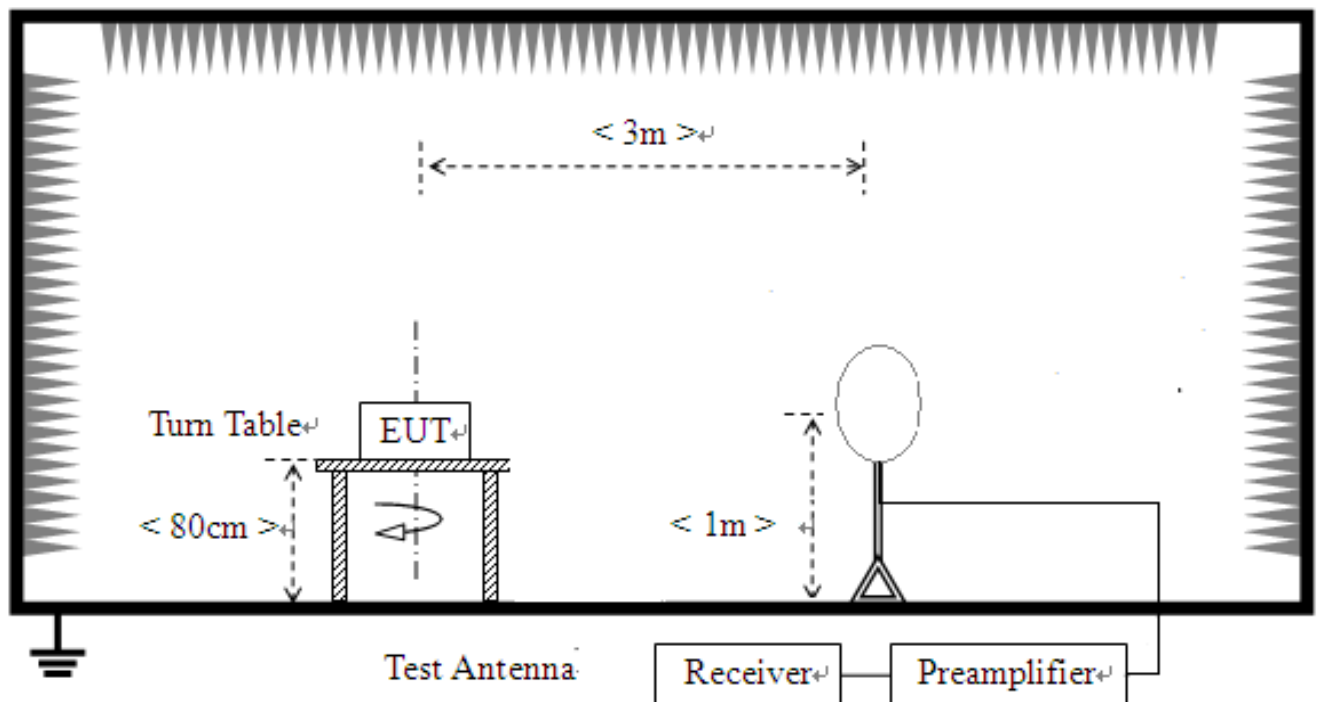

For radiated emissions from 30MHz to 1GHz

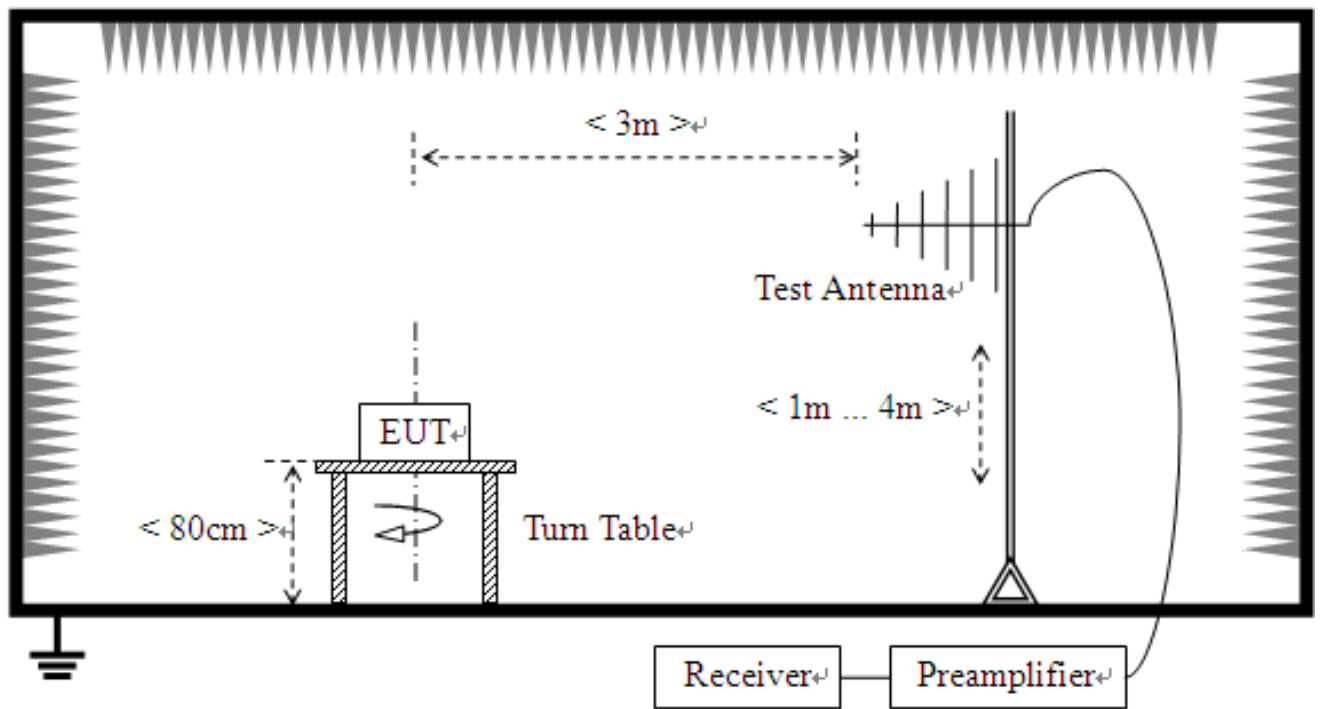

For radiated emissions above 1GHz

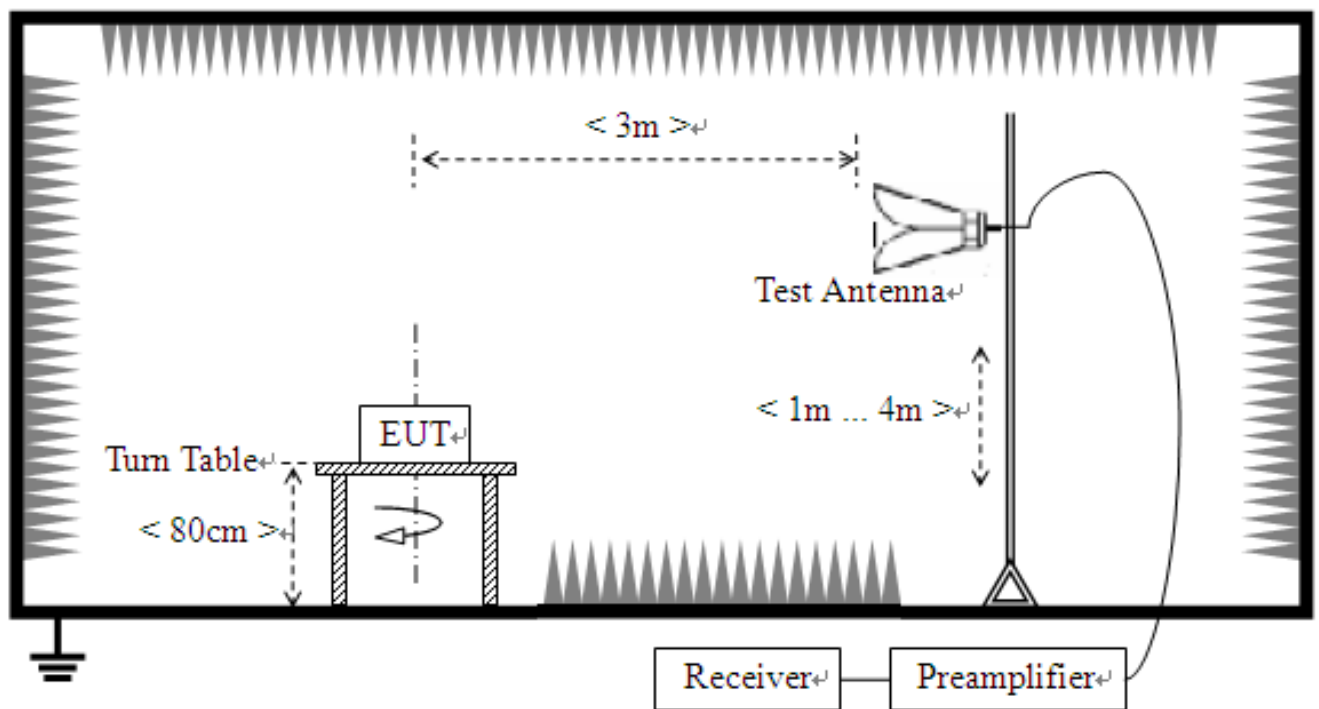

2.8.4 Test Procedures

1. The testing follows FCC KDB 971168 D01 v03r01 Section 5.8 and ANSI / TIA-603-D-2010 Section 2.2.12.
2. The EUT was placed on a rotatable wooden table 0.8 meters above the ground.
3. The EUT was set 3 meters from the receiving antenna, which was mounted on the antenna tower.
4. The table was rotated 360 degrees to determine the position of the highest spurious emission.
5. The height of the receiving antenna is varied between one meter and four meters to search for the maximum spurious emission for both horizontal and vertical polarizations.
6. Make the measurement with the spectrum analyzer's RBW = 1MHz, VBW = 3MHz, taking record of maximum spurious emission.
7. A horn antenna was substituted in place of the EUT and was driven by a signal generator.
8. Tune the output power of signal generator to the same emission level with EUT maximum spurious emission.
9. Taking the record of output power at antenna port.
10. Repeat step 7 to step 8 for another polarization.
11. The RF fundamental frequency should be excluded against the limit line in the operating frequency band.
12. The limit line is derived from $43 + 10\log(P)$ dB below the transmitter power P(Watts)
 $= P(W) - [43 + 10\log(P)]$ (dB)
 $= [30 + 10\log(P)]$ (dBm) - $[43 + 10\log(P)]$ (dB)
 $= -13\text{dBm}$.
13. This device employs GMSK technology with GSM and GSM capabilities. All configurations were investigated and the worst case emissions were found in GSM mode.
14. This device employs UMTS technology with WCDMA (AMR/RMC), HSDPA, HSUPA capabilities. All configurations were investigated and the worst case UMTS emissions were found in RMC WCDMA mode at 12.2Kbps.
15. This unit was tested with its standard battery.
16. All Spurious Emission tests were performed in X, Y, Z axis direction and low, middle, high channel. And only the worst axis test condition was recorded in this test report.
17. The spectrum is measured from 9 KHz to the 10th harmonic of the fundamental frequency



of the transmitter using CISPR quasi peak detector below 1GHz. The worst case emissions are reported however emissions whose levels were not within 20dB of the respective limits were not reported.

18. For 9KHz to 30MHz: the amplitude of spurious emissions are attenuated by more than 20dB below the permissible value has no need to be reported.



2.8.5 Test Results of Radiated Spurious Emissions

Worst-Case test data provide as below:

30MHz~10GHz:

GSM 850 (Low Channel)				
Frequency (MHz)	Polarity (H/V)	Corrected Reading (dBm)	Limit (dBm)	Result
1648.4	H	-40.11	-13	Pass
1648.4	V	-38.62	-13	Pass
2742.6	H	-47.01	-13	Pass
2742.6	V	-54.39	-13	Pass

GSM 850 (Mid Channel)				
Frequency (MHz)	Polarity (H/V)	Corrected Reading (dBm)	Limit (dBm)	Result
1673.2	H	-38.72	-13	Pass
1673.2	V	-37.47	-13	Pass
2509.9	H	-45.43	-13	Pass
2509.9	V	-55.70	-13	Pass

GSM 850 (High Channel)				
Frequency (MHz)	Polarity (H/V)	Corrected Reading (dBm)	Limit (dBm)	Result
1697.60	H	-39.11	-13	Pass
1697.60	V	-38.35	-13	Pass
2546.40	H	-46.77	-13	Pass
2546.40	V	-56.09	-13	Pass



Worst-Case test data provide as below:

30MHz~20GHz:

GSM 1900 (Low Channel)				
Frequency (MHz)	Polarity (H/V)	Corrected Reading (dBm)	Limit (dBm)	Result
300.4	H	-49.11	-13	Pass
310.4	V	-48.35	-13	Pass
1972.86	H	-58.77	-13	Pass
5800.27	V	-58.09	-13	Pass

GSM 1900 (Mid Channel)				
Frequency (MHz)	Polarity (H/V)	Corrected Reading (dBm)	Limit (dBm)	Result
890.2	H	-57.01	-13	Pass
890.1	V	-57.35	-13	Pass
3096.01	H	-57.16	-13	Pass
3099.01	V	-56.22	-13	Pass

GSM 1900 (High Channel)				
Frequency (MHz)	Polarity (H/V)	Corrected Reading (dBm)	Limit (dBm)	Result
190.2	H	-56.21	-13	Pass
90.1	V	-55.30	-13	Pass
3819.6	H	-58.44	-13	Pass
3819.6	V	-57.26	-13	Pass



Worst-Case test data provide as below:

30MHz~10GHz:

WCDMA Band V (Low Channel)				
Frequency (MHz)	Polarity (H/V)	Corrected Reading (dBm)	Limit (dBm)	Result
305.61	H	-49.11	-13	Pass
499.20	V	-50.28	-13	Pass
5121.02	H	-56.00	-13	Pass
5820.01	V	-56.23	-13	Pass

WCDMA Band V (Middle Channel)				
Frequency (MHz)	Polarity (H/V)	Corrected Reading (dBm)	Limit (dBm)	Result
307.1	H	-43.71	-13	Pass
501.5	V	-44.48	-13	Pass
3081.01	H	-56.62	-13	Pass
3054.01	V	-56.24	-13	Pass

WCDMA Band V (High Channel)				
Frequency (MHz)	Polarity (H/V)	Corrected Reading (dBm)	Limit (dBm)	Result
307.1	H	-48.3	-13	Pass
501.5	V	-49.48	-13	Pass
3081.01	H	-58.33	-13	Pass
3054.01	V	-57.01	-13	Pass



Worst-Case test data provide as below:

30MHz~20GHz:

WCDMA Band II (Low Channel)				
Frequency (MHz)	Polarity (H/V)	Corrected Reading (dBm)	Limit (dBm)	Result
117.14	H	-50.14	-13	Pass
102.54	V	-47.94	-13	Pass
3084.01	H	-56.06	-13	Pass
3066.01	V	-56.02	-13	Pass

WCDMA Band II (Mid Channel)				
Frequency (MHz)	Polarity (H/V)	Corrected Reading (dBm)	Limit (dBm)	Result
999.12	H	-53.04	-13	Pass
86.11	V	-46.41	-13	Pass
3084.01	H	-56.86	-13	Pass
3108.02	V	-56.04	-13	Pass

WCDMA Band II (High Channel)				
Frequency (MHz)	Polarity (H/V)	Corrected Reading (dBm)	Limit (dBm)	Result
815.2	H	-47.04	-13	Pass
86.11	V	-45.48	-13	Pass
5300.21	H	-55.11	-13	Pass
6448.20	V	-54.12	-13	Pass

Note: 1. Absolute Level=Substituted Level-Cable loss + Antenna Gain

**3. LIST OF MEASURING EQUIPMENT**

Description	Manufacturer	Model	Serial No.	Cal. Date	Due Date	Remark
EMI Test Receiver	R&S	ESIB26	A0304218	2017.06.02	2018.06.01	Radiation
Loop Antenna	Schwarz beck	HFH2-Z2	100047	2017.06.02	2018.06.01	Radiation
Bilog Antenna	Schwarzbeck	VULB 9163	9163-274	2017.06.02	2018.06.01	Radiation
Broadband antenna (30MHz~1GHz)	R&S	HL562	101341	2017.06.02	2018.06.01	Radiation
Broadband antenna (30MHz~1GHz)	R&S	HL562	101339	2017.06.02	2018.06.01	Radiation
Double ridge horn antenna (1GHz~18GHz)	R&S	HF906	100150	2017.06.02	2018.06.01	Radiation
Double ridge horn antenna (1GHz~18GHz)	R&S	HF906	100148	2017.06.02	2018.06.01	Radiation
Horn antenna (18GHz~26.5GHz)	R&S	HM118	101286	2017.06.02	2018.06.01	Radiation
Horn antenna (18GHz~26.5GHz)	R&S	HM118	101284	2017.06.02	2018.06.01	Radiation
Amplifier 20M~3GHz	R&S	PAP-0203H	22018	2017.06.02	2018.06.01	Radiation
Ampilier 1G~18GHz	R&S	MITEQ AFS42-00101800	25-S-42	2017.06.02	2018.06.01	Radiation
Ampilier 18G~40GHz	R&S	JS42-18002600-2 8-5A	12111.0980.00	2017.06.02	2018.06.01	Radiation
Spectrum Analyzer	R&S	FSP40	1164.4391.40	2017.11.12	2018.11.11	Conducted
LISN	ROHDE&SCH WARZ	ESH2-Z5	A0304221	2017.06.02	2018.06.01	Conducted
Test Receiver	R&S	ESCS30	A0304260	2017.06.02	2018.06.01	Conducted
Cable	SUNHNER	SUCOFLEX 100	/	2017.06.02	2018.06.01	Radiation
Cable	SUNHNER	SUCOFLEX 104	/	2017.06.02	2018.06.01	Radiation
Temperature chamber	espec	SU-642	93008519	2017.08.25	2018.08.24	Conducted
Wideband Radio Communication tester	R&S	CMW500	149332	2018.05.04	2019.05.03	Conducted
Power Supply	R&S	NGMO1	101037	2018.05.04	2019.05.03	Conducted

** END OF REPORT **