



# RF TEST REPORT

**Report No.:** SET2019-15917

**Product Name:** Handheld Data Terminal

**FCC ID:** SWSDT40

**Model No. :** DT40, DT40S , DT40T

**Applicant:** UROVO TECHNOLOGY CO., LTD.

**Address:** 36F,High-Tech Zone Union Tower,No.63,Xuefu Road, Nanshan  
District, Shenzhen, Guangdong, China.

**Dates of Testing:** 11/01/2019 — 12/04/2019

**Issued by:** CCIC Southern Testing Co., Ltd.

**Lab Location:** Electronic Testing Building, No.43 Shahe Road Xili Street, Nanshan  
District, Shenzhen, Guangdong, 518055 China.

**Tel:** 86 755 26627338      **Fax:** 86 755 26627238

This test report consists of 66 pages in total. It may be duplicated completely for legal use with the approval of the applicant. It should not be reproduced except in full, without the written approval of our laboratory. The client should not use it to claim product endorsement by CCIC-SET. The test results in the report only apply to the tested sample. The test report shall be invalid without all the signatures of testing engineers, reviewer and approver. Any objections must be raised to CCIC-SET within 15 days since the date when the report is received. It will not be taken into consideration beyond this limit.



## Test Report

**Product**.....: Handheld Data Terminal

**Brand Name**.....: UROVO

**Trade Name**.....: UROVO

**Applicant**.....: UROVO TECHNOLOGY CO., LTD.

**Applicant Address**.....: 36F,High-Tech Zone Union Tower,No.63,Xuefu Road,  
Nanshan District, Shenzhen, Guangdong, China

**Manufacturer**.....: UROVO TECHNOLOGY CO., LTD.

**Manufacturer Address**....: 36F,High-Tech Zone Union Tower,No.63,Xuefu Road,  
Nanshan District, Shenzhen, Guangdong, China

**Test Standards**.....: 47 CFR FCC Part 2/22/24

**Test Result**.....: PASS

**Tested by**.....: Vincent 2019.12.04  
Vincent, Test Engineer

**Reviewed by**.....: Chris You 2019.12.04  
Chris You, Senior Engineer

**Approved by**.....: Shuangwen Zhang 2019.12.04  
Shuangwen Zhang, Manager



## Table of Contents

|            |   |           |
|------------|---|-----------|
| <b>1.</b>  | <b>GENERAL INFORMATION .....</b>  | <b>5</b>  |
| <b>1.1</b> | <b>EUT Description .....</b>  | <b>5</b>  |
| <b>1.2</b> | <b>Maximum ERP/EIRP Power, Frequency Tolerance, and Emission Designator .....</b> | <b>6</b>  |
| <b>1.3</b> | <b>Test Standards and Results .....</b>   | <b>7</b>  |
| <b>1.4</b> | <b>Test Configuration of Equipment under Test.....</b>                            | <b>8</b>  |
| <b>1.5</b> | <b>Measurement Results Explanation Example .....</b>                              | <b>9</b>  |
| <b>1.6</b> | <b>Facilities and Accreditations .....</b>  | <b>9</b>  |
| <b>2.</b>  | <b>47 CFR PART 2, PART 22H &amp; 24E REQUIREMENTS .....</b>                       | <b>10</b> |
| <b>2.1</b> | <b>Conducted RF Output Power .....</b>  | <b>10</b> |
| <b>2.2</b> | <b>Peak to Average Ratio.....</b>   | <b>13</b> |
| <b>2.3</b> | <b>99% Occupied Bandwidth and 26dB Bandwidth Measurement .....</b>                | <b>15</b> |
| <b>2.4</b> | <b>Frequency Stability .....</b>  | <b>23</b> |
| <b>2.5</b> | <b>Conducted Out of Band Emissions .....</b>                                      | <b>27</b> |
| <b>2.6</b> | <b>Bandedge .....</b>   | <b>47</b> |
| <b>2.7</b> | <b>Transmitter Radiated Power (EIRP/ERP) .....</b>                                | <b>54</b> |
| <b>2.8</b> | <b>Radiated Spurious Emissions .....</b>  | <b>58</b> |
| <b>3.</b>  | <b>LIST OF MEASURING EQUIPMENT .....</b>  | <b>66</b> |



| Change History |            |                   |
|----------------|------------|-------------------|
| Issue          | Date       | Reason for change |
| 1.0            | 2019.12.04 | First edition     |
|                |            |                   |
|                |            |                   |



## 1. GENERAL INFORMATION

### 1.1 EUT Description

|                                 |  |
|---------------------------------|--|
| EUT Type                        | Handheld Data Terminal   |
| EUT supports Radios application | GPRS/EDGE/WCDMA/HSPA   |
| Multi Slot Class                | GPRS: Multi slot Class12, EGPRS: Multi slot Class12  |
| Frequency Range                 | GSM 850MHz:<br>Tx: 824.2 - 848.8MHz (at intervals of 200kHz);<br>Rx: 869.2 - 893.8MHz (at intervals of 200kHz)<br>GSM 1900MHz:<br>Tx: 1850.2 - 1909.8MHz (at intervals of 200kHz);<br>Rx: 1930.2 - 1989.8MHz (at intervals of 200kHz)<br>WCDMA 850MHz<br>Tx: 826.4 - 846.6MHz (at intervals of 200kHz);<br>Rx: 871.4 - 891.6MHz (at intervals of 200kHz)<br>WCDMA 1900MHz<br>Tx: 1852.4 - 1907.6MHz (at intervals of 200kHz);<br>Rx: 1932.4 - 1987.6MHz (at intervals of 200kHz) |
| Maximum Output Power to Antenna | GSM 850: 32.35dBm<br>GSM 1900: 29.83dBm<br>EDGE 850: 25.84dBm<br>EDGE 1900: 24.97dBm<br>WCDMA 850: 22.42dBm<br>WCDMA 1900: 22.45dBm  |
| Type of Modulation              | GSM / GPRS:GMSK<br>EDGE:GMSK / 8PSK<br>WCDMA: QPSK(Uplink)<br>HSDPA:QPSK(Downlink)<br>HSUPA:QPSK(Uplink)   |
| Antenna Type                    | Internal Antenna   |

**1.2 Maximum ERP/EIRP Power, Frequency Tolerance, and Emission Designator**

| System                     | Type of Modulation | Emission Designator | Frequency Tolerance (ppm) | Maximum ERP/EIRP(W) |
|----------------------------|--------------------|---------------------|---------------------------|---------------------|
| GSM 850                    | GMSK               | 245KGXW             | 0.072                     | 1.841               |
| GSM 1900                   | GMSK               | 248KGXW             | 0.054                     | 0.966               |
| EDGE 850                   | 8PSK               | 244KG7W             | 0.069                     | 0.364               |
| EDGE 1900                  | 8PSK               | 243KG7W             | 0.092                     | 0.298               |
| WCDMA 850<br>RMC 12.2Kbps  | QPSK               | 4M12F9W             | 0.0093                    | 0.192               |
| WCDMA 1900<br>RMC 12.2Kbps | QPSK               | 4M13F9W             | 0.0099                    | 0.185               |



### 1.3 Test Standards and Results

1. 47 CFR Part 2, 22(H), 24(E)
2. ANSI / TIA / EIA-603-D-2010
3. FCC KDB 971168 D01 Power Meas. License Digital Systems v03r01

**Remark:**

1. All test items were verified and recorded according to the standards and without any deviation during the test.
2. This EUT has also been tested and complied with the requirements of FCC Part 15, Subpart B, recorded in a separate test report.

Test detailed items/section required by FCC rules and results are as below:

| No. | Section                          | Description                         | Limit                            | Result |
|-----|----------------------------------|-------------------------------------|----------------------------------|--------|
|     | FCC                              |                                     |                                  |        |
| 1   | 2.1046                           | Conducted Output Power              | Reporting Only                   | PASS   |
| 2   | 24.232(d)                        | Peak to Average Ratio               | <13dBm                           | PASS   |
| 3   | 2.1049<br>22.917(b)<br>24.238(b) | Occupied Bandwidth                  | Reporting Only                   | PASS   |
| 4   | 2.1055<br>22.355<br>24.235       | Frequency Stability                 | $\leq \pm 2.5\text{ppm}$         | PASS   |
| 5   | 2.1051<br>22.917<br>24.238       | Conducted Out of Band Emissions     | $< 43+10\log_{10}$<br>(P[Watts]) | PASS   |
| 6   | 2.1051<br>22.917<br>24.238       | Band GPRS                           | $< 43+10\log_{10}$<br>(P[Watts]) | PASS   |
| 7   | 22.913                           | Effective Radiated Power            | <7Watts                          | PASS   |
|     | 24.232                           | Equivalent Isotropic Radiated Power | <2Watts                          | PASS   |
| 8   | 2.1053<br>22.917<br>24.238       | Radiated Spurious Emissions         | $< 43+10\log_{10}$<br>(P[Watts]) | PASS   |



#### 1.4 Test Configuration of Equipment under Test

Antenna port conducted and radiated test items were performed according to KDB 971168 D01 Power Meas. License Digital Systems v03r01 with maximum output power.

Radiated measurements were performed with rotating EUT in different three orthogonal test planes to find the maximum emission.

Radiated emissions were investigated as following frequency range:

1. 30 MHz to 9000 MHz for GSM850 and WCDMA Band V.
2. 30 MHz to 20000 MHz for GSM1900 and WCDMA Band II.

All modes and data rates and positions were investigated.

Test modes are chosen to be reported as the worst case configuration below:

| Test Modes    |                   |                   |
|---------------|-------------------|-------------------|
| Band          | Radiated TCs      | Conducted TCs     |
| GSM 850       | GPRS Link         | GPRS Link         |
|               | GPRS Link         | GPRS Link         |
| GSM 1900      | GPRS Link         | GPRS Link         |
|               | GPRS Link         | GPRS Link         |
| WCDMA Band V  | RMC 12.2Kbps Link | RMC 12.2Kbps Link |
| WCDMA Band II | RMC 12.2Kbps Link | RMC 12.2Kbps Link |

Note: The maximum power levels are chosen to test as the worst case configuration as follows:

GSM mode for GMSK modulation,

EDGE multi-slot class 8 mode for 8PSK modulation,

RMC 12.2Kbps mode for WCDMA band V,

RMC 12.2Kbps mode for WCDMA band II, only these modes were used for all tests.





## 1.5 Measurement Results Explanation Example

### For all conducted test items:

The offset level is set in the spectrum analyzer to compensate the RF cable loss and attenuator factor between EUT conducted output port and spectrum analyzer. With the offset compensation, the spectrum analyzer reading level is exactly the EUT RF output level.

The spectrum analyzer offset is derived from RF cable loss and attenuator factor.

Offset = RF cable loss + attenuator factor.

Following shows an offset computation example with cable loss 6B and 10dB attenuator.

Example:

$$\begin{aligned}\text{Offset (dB)} &= \text{RF cable loss(dB)} + \text{attenuator factor(dB)} \\ &= 7.5 + 10 = 17.5(\text{dB})\end{aligned}$$

## 1.6 Facilities and Accreditations

### 1.6.1 Test Facilities

#### **NVLAP Lab Code: 201008-0**

CCIC-SET is a third party testing organization accredited by NVLAP according to ISO/IEC 17025. The accreditation certificate number is 201008-0.

#### **FCC- Designation Number: CN5031**

CCIC Southern Testing Co., Ltd EMC Laboratory has been registered and fully described in a report filed with the FCC (Federal Communications Commission). The acceptance letter from the FCC is maintained in our files. Designation Number: CN5031, valid time is until December 31, 2020.

#### **ISED Registration: 11185A-1**

#### **CAB identifier: CN0064**

CCIC Southern Testing Co., Ltd EMC Laboratory has been registered by Certification and Engineering Bureau of Industry Canada for the performance of radiated measurements with Registration No. 11185A-1 on Aug. 04, 2016, valid time is until Dec. 03, 2020

### 1.6.2 Test Environment Conditions

During the measurement, the environmental conditions were within the listed ranges:

|                             |              |
|-----------------------------|--------------|
| Temperature (°C):           | 15°C - 35°C  |
| Relative Humidity (%):      | 30% -60%     |
| Atmospheric Pressure (kPa): | 86KPa-106KPa |

## 2. 47 CFR PART 2, PART 22H & 24E REQUIREMENTS

### 2.1 Conducted RF Output Power

#### 2.1.1 Definition

A system simulator was used to establish communication with the EUT. Its parameters were set to enforce EUT transmitting at the maximum power. The measured power in the radio frequency on the transmitter output terminals shall be reported.

#### 2.1.2 Measuring Instruments

The measuring equipment is listed in the section 3 of this test report.

#### 2.1.3 Test Procedures

1. The transmitter output port was connected to the system simulator.
2. Set EUT at maximum power through system simulator.
3. Select lowest, middle, and highest channels for each band and different modulation.
4. Measure and record the power level from the system simulator.

#### 2.1.4 Test Setup

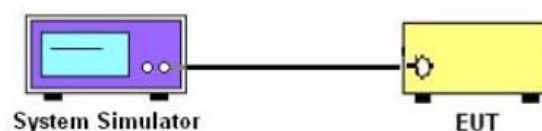



### 2.1.5 Test Results of Conducted Output Power

1. Test Verdict:

| GSM850      |            | Burst-Averaged output Power (dBm) |       |       | Division Factors | Frame-Averaged output Power (dBm) |       |       |
|-------------|------------|-----------------------------------|-------|-------|------------------|-----------------------------------|-------|-------|
|             |            | 128CH                             | 190CH | 251CH |                  | 28CH                              | 190CH | 251CH |
| GSM (CS)    |            | 31.96                             | 32.14 | 32.35 | -9.19            | 22.77                             | 22.95 | 23.16 |
| GPRS (GMSK) | 1 Tx Slot  | 31.91                             | 32.02 | 32.46 | -9.19            | 22.72                             | 22.83 | 23.27 |
|             | 2 Tx Slots | 29.67                             | 29.74 | 30.06 | -6.13            | 23.54                             | 23.61 | 23.93 |
|             | 3 Tx Slots | 28.11                             | 28.21 | 28.43 | -4.42            | 23.69                             | 23.79 | 24.01 |
|             | 4 Tx Slots | 27.01                             | 27.10 | 27.32 | -3.18            | 23.83                             | 23.92 | 24.14 |
| EDGE (8PSK) | 1 Tx Slot  | 25.70                             | 25.77 | 25.84 | -9.19            | 16.51                             | 16.58 | 16.65 |
|             | 2 Tx Slots | 23.35                             | 23.41 | 23.48 | -6.13            | 17.22                             | 17.28 | 17.35 |
|             | 3 Tx Slots | 22.16                             | 22.24 | 22.31 | -4.42            | 17.74                             | 17.82 | 17.89 |
|             | 4 Tx Slots | 21.04                             | 21.12 | 21.25 | -3.18            | 17.86                             | 17.94 | 18.07 |
| GSM1900     |            | Burst-Averaged output Power (dBm) |       |       | Division Factors | Frame-Averaged output Power (dBm) |       |       |
|             |            | 512CH                             | 661CH | 810CH |                  | 512CH                             | 661CH | 810CH |
| GSM (CS)    |            | 29.64                             | 29.83 | 29.72 | -9.19            | 20.45                             | 20.64 | 20.53 |
| GPRS (GMSK) | 1 Tx Slot  | 29.60                             | 29.81 | 29.70 | -9.19            | 20.41                             | 20.62 | 20.51 |
|             | 2 Tx Slots | 27.43                             | 27.62 | 27.54 | -6.13            | 21.30                             | 21.49 | 21.41 |
|             | 3 Tx Slots | 26.24                             | 26.41 | 26.33 | -4.42            | 21.82                             | 21.99 | 21.91 |
|             | 4 Tx Slots | 25.13                             | 25.34 | 25.26 | -3.18            | 21.95                             | 22.16 | 22.08 |
| EDGE (8PSK) | 1 Tx Slot  | 24.85                             | 24.97 | 24.91 | -9.19            | 15.66                             | 15.78 | 15.72 |
|             | 2 Tx Slots | 22.47                             | 22.65 | 22.55 | -6.13            | 16.34                             | 16.52 | 16.42 |
|             | 3 Tx Slots | 21.23                             | 21.40 | 21.34 | -4.42            | 16.81                             | 16.98 | 16.92 |
|             | 4 Tx Slots | 20.15                             | 20.31 | 20.22 | -3.18            | 16.97                             | 17.13 | 17.04 |



2. WCDMA Model Test Verdict:

| UMTS1900<br>(Band II) |              | Average Power (dBm) |        |        |
|-----------------------|--------------|---------------------|--------|--------|
|                       |              | 9262CH              | 9400CH | 9538cH |
| WCDMA                 | 12.2kbps RMC | 22.45               | 22.27  | 22.42  |
| HSDPA                 | Subtest 1    | 22.38               | 22.16  | 22.33  |
|                       | Subtest 2    | 22.26               | 22.05  | 22.24  |
|                       | Subtest 3    | 22.17               | 21.97  | 22.15  |
|                       | Subtest 4    | 22.08               | 21.87  | 22.04  |
| HSUPA                 | Subtest 1    | 21.97               | 21.76  | 21.93  |
|                       | Subtest 2    | 21.86               | 21.67  | 21.82  |
|                       | Subtest 3    | 21.77               | 21.56  | 21.74  |
|                       | Subtest 4    | 21.66               | 21.47  | 21.62  |
|                       | Subtest 5    | 21.58               | 21.38  | 21.51  |
| UMTS850<br>(Band V)   |              | Average Power (dBm) |        |        |
|                       |              | 4132CH              | 4183CH | 4233CH |
| WCDMA                 | 12.2kbps RMC | 22.32               | 22.42  | 22.38  |
| HSDPA                 | Subtest 1    | 22.21               | 22.35  | 22.26  |
|                       | Subtest 2    | 22.13               | 22.26  | 22.17  |
|                       | Subtest 3    | 22.04               | 22.14  | 22.08  |
|                       | Subtest 4    | 21.93               | 22.07  | 21.95  |
| HSUPA                 | Subtest 1    | 21.82               | 21.96  | 21.84  |
|                       | Subtest 2    | 21.71               | 21.85  | 21.76  |
|                       | Subtest 3    | 21.60               | 21.77  | 21.67  |
|                       | Subtest 4    | 21.53               | 21.66  | 21.58  |
|                       | Subtest 5    | 21.42               | 21.55  | 21.49  |

## **2.2 Peak to Average Ratio**

### **2.2.1 Definition**

Power Complementary Cumulative Distribution Function (CCDF) curves provide a means for characterizing the power peaks of a digitally modulated signal on a statistical basis. A CCDF curve depicts the probability of the peak signal amplitude exceeding the average power level. Most contemporary measurement instrumentation include the capability to produce CCDF curves for an input signal provided that the instrument's resolution bandwidth can be set wide enough to accommodate the entire input signal bandwidth. In measuring transmissions in this band using an average power technique, the peak-to-average ratio (PAR) of the transmission may not exceed 13 dB.

### **2.2.2 Measuring Instruments**

The measuring equipment is listed in the section 3 of this test report.

### **2.2.3 Test Procedures**

1. The testing follows FCC KDB 971168 D01 v03r01 Section 5.7.1.
2. The EUT was connected to the spectrum analyzer and system simulator via a power divider.
3. For GSM/EGPRS operating modes:
  - a. Set EUT in maximum power output.
  - b. Set the RBW = 1MHz, VBW = 3MHz, Peak detector on spectrum analyzer for first trace.
  - c. Set the RBW = 1MHz, VBW = 3MHz, RMS detector on spectrum analyzer for second trace.
  - d. The wanted burst signal is triggered by spectrum analyzer, and measured respectively the peak level and Mean level without burst-off time, after system simulator has synchronized with the spectrum analyzer.
4. For UMTS operating modes:
  - a. Set the CCDF (Complementary Cumulative Distribution Function) option on the spectrum analyzer.
  - b. The highest RF powers were measured and recorded the maximum PAPR level associated with a probability of 0.1 %.
5. Record the deviation as Peak to Average Ratio.

### 2.2.4 Test Setup

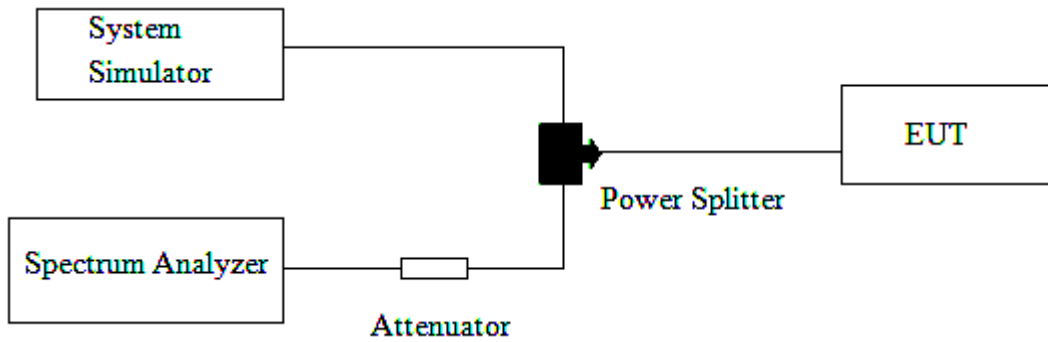

### 2.2.5 Test Results of Peak-to-Average Ratio

| Band             | Channel | Frequency (MHz) | Peak to Average ratio | Limit | Verdict |
|------------------|---------|-----------------|-----------------------|-------|---------|
|                  |         |                 | dB                    | dB    |         |
| GSM<br>1900MHz   | 512     | 1850.2          | 3.1                   | 13    | PASS    |
|                  | 661     | 1880.0          | 0.2                   |       | PASS    |
|                  | 810     | 1909.8          | 0.2                   |       | PASS    |
| EDGE<br>1900MHz  | 512     | 1850.2          | 3.3                   | 13    | PASS    |
|                  | 661     | 1880.0          | 3.3                   |       | PASS    |
|                  | 810     | 1909.8          | 3.1                   |       | PASS    |
| WCDMA<br>1900MHz | 9262    | 1852.4          | 2.95                  | 13    | PASS    |
|                  | 9400    | 1880.0          | 2.83                  |       | PASS    |
|                  | 9538    | 1907.6          | 2.79                  |       | PASS    |

## 2.3 99% Occupied Bandwidth and 26dB Bandwidth Measurement

### 2.3.1 Definition

The 99% occupied bandwidth is the width of a frequency band such that, below the lower and above the upper frequency limits, the mean powers emitted are each equal to a specified percentage 0.5% of the total mean transmitted power.

The emission bandwidth is defined as the width of the signal between two points, located at the 2 sides of the carrier frequency, outside of which all emissions are attenuated at least 26 dB below the transmitter power.

### 2.3.2 Measuring Instruments

The measuring equipment is listed in the section 3 of this test report.

### 2.3.3 Test Procedures

1. The testing follows FCC KDB 971168 D01 v03r01 Section 4.2.
2. The EUT was connected to the spectrum analyzer and system simulator via a power divider.
3. The RF output of the EUT was connected to the spectrum analyzer by RF cable and attenuator.

The path loss was compensated to the results for each measurement.

4. The 99% occupied bandwidth were measured, set RBW= 1% of span, VBW= 3\*RBW, sample detector, trace maximum hold.
5. The 26dB bandwidth were measured, set RBW= 1% of EBW, VBW= 3\*RBW, peak detector, trace maximum hold.

### 2.3.4 Test Setup

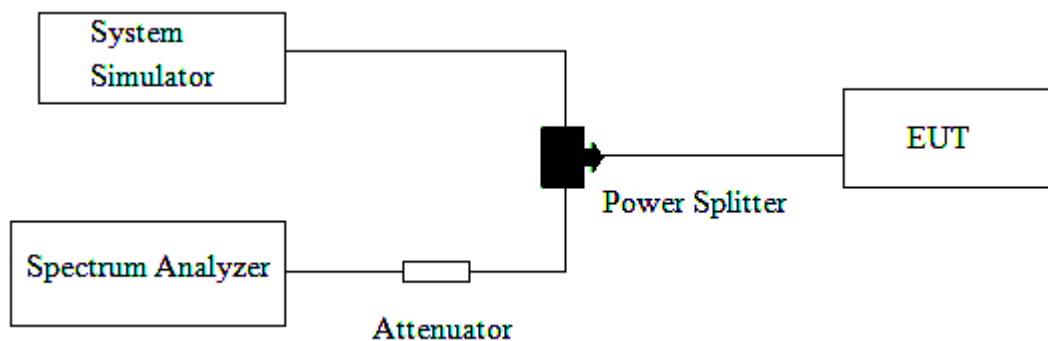

**2.3.5 Test Results of 99% Occupied Bandwidth and 26dB Bandwidth**

| Band          | Channel | Frequency (MHz) | 26dB bandwidth (KHz) | 99% Occupied Bandwidth (KHz) | Refer to Plot |
|---------------|---------|-----------------|----------------------|------------------------------|---------------|
| GSM 850MHz    | 128     | 824.2           | 307.5                | 244.54                       | Plot A1       |
|               | 190     | 836.6           | 304.5                | 244                          | Plot A2       |
|               | 251     | 848.8           | 304.9                | 244.62                       | Plot A3       |
| GSM 1900MHz   | 512     | 1850.2          | 316.1                | 244.23                       | Plot B1       |
|               | 661     | 1880.0          | 310.3                | 246.76                       | Plot B2       |
|               | 810     | 1909.8          | 313.9                | 244.53                       | Plot B3       |
| EDGE 850MHz   | 128     | 824.2           | 287.2                | 244.19                       | Plot C1       |
|               | 190     | 836.6           | 274.1                | 236.67                       | Plot C2       |
|               | 251     | 848.8           | 303.9                | 238.99                       | Plot C3       |
| EDGE 1900MHz  | 512     | 1850.2          | 286.2                | 243.13                       | Plot D1       |
|               | 661     | 1880.0          | 298.7                | 241.1                        | Plot D2       |
|               | 810     | 1909.8          | 300.9                | 242.93                       | Plot D3       |
| WCDMA 850MHz  | 4132    | 826.4           | 4671                 | 4116.1                       | Plot E1       |
|               | 4183    | 836.6           | 4657                 | 4101.3                       | Plot E2       |
|               | 4233    | 846.6           | 4682                 | 4098.5                       | Plot E3       |
| WCDMA 1900MHz | 9262    | 1852.4          | 4665                 | 4110.3                       | Plot F1       |
|               | 9400    | 1880            | 4669                 | 4113.8                       | Plot F2       |
|               | 9538    | 1907.6          | 4651                 | 4126.8                       | Plot F3       |



### 2.3.6 Test Results (Plots) of 99% Occupied Bandwidth and 26dB Bandwidth

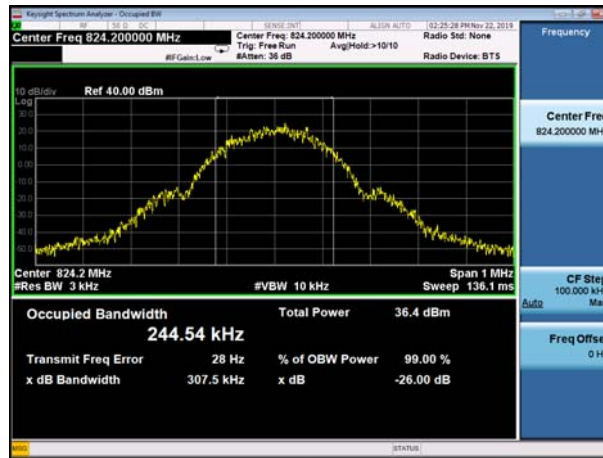

(Plot A1: GSM 850MHz Channel = 128 Occupied bandwidth)



(Plot A2: GSM 850MHz Channel = 190 Occupied bandwidth)

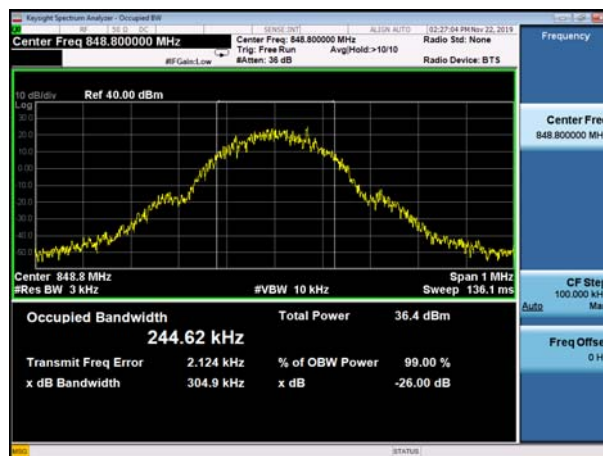

(Plot A3: GSM 850MHz Channel = 251 Occupied bandwidth)

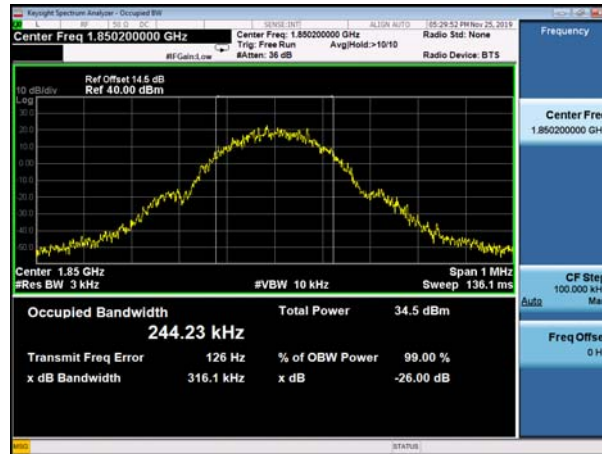

(Plot B1: GSM 1900MHz Channel = 512 Occupied bandwidth)

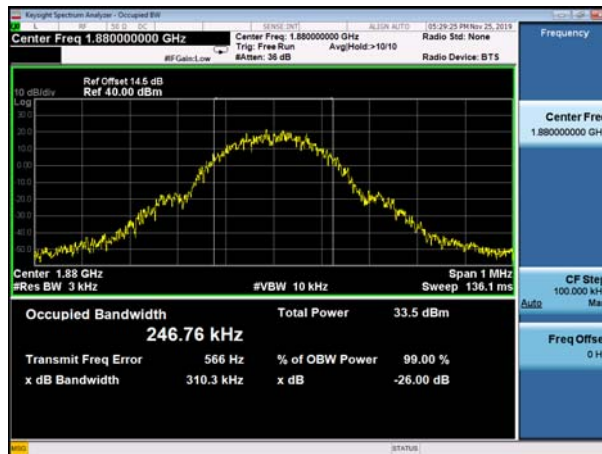

(Plot B2: GSM 1900MHz Channel = 661 Occupied bandwidth)

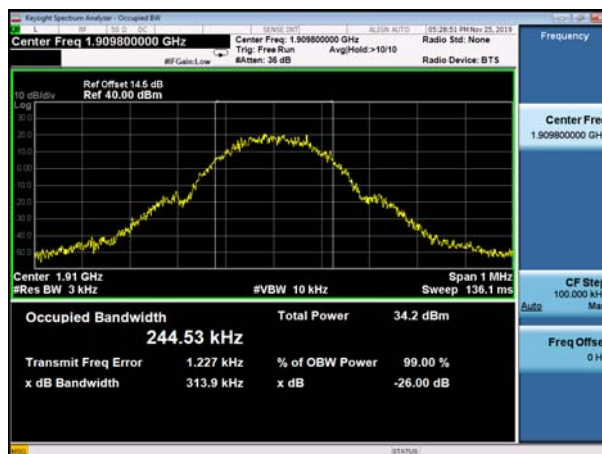

(Plot B3: GSM 1900MHz Channel = 810 Occupied bandwidth)

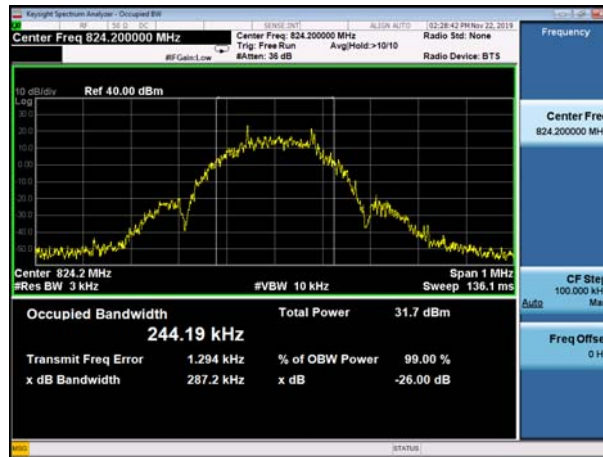

(Plot C1: EDGE 850MHz Channel = 128 Occupied bandwidth)

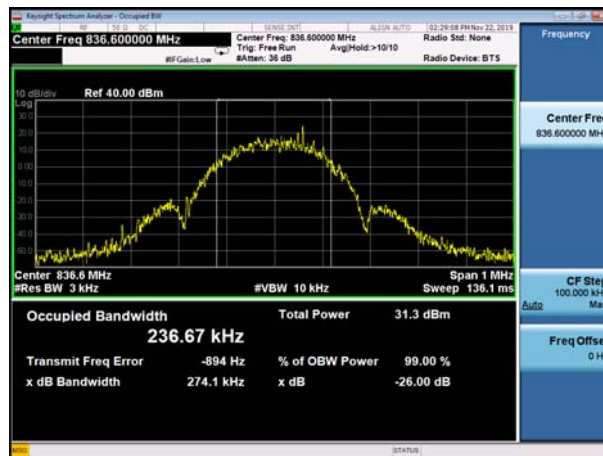

(Plot C2: EDGE 850MHz Channel = 190 Occupied bandwidth)



(Plot C3: EDGE 850MHz Channel = 251 Occupied bandwidth)

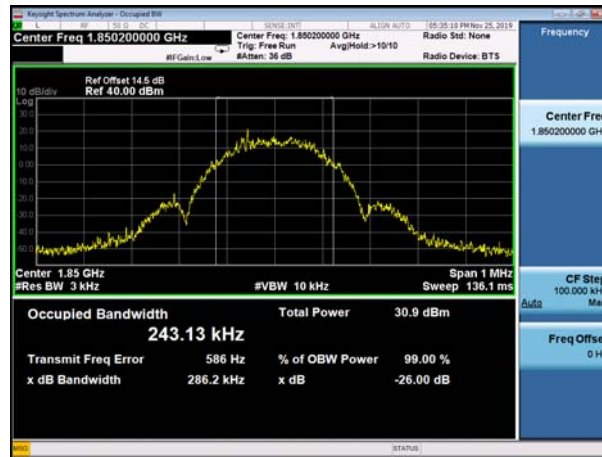

(Plot D1: EDGE 1900MHz Channel = 512 Occupied bandwidth)



(Plot D2: EDGE 1900MHz Channel = 661 Occupied bandwidth)

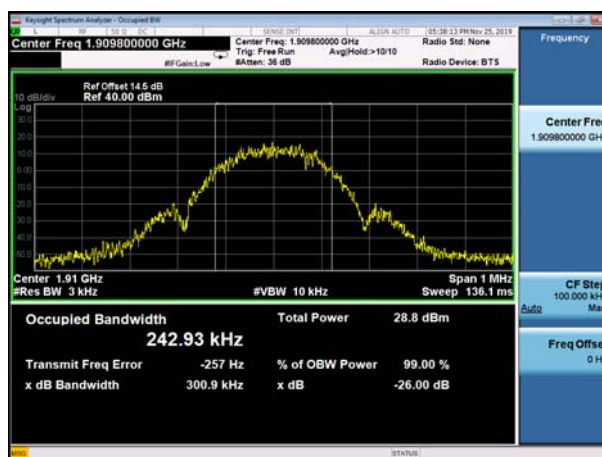

(Plot D3: EDGE 1900MHz Channel = 810 Occupied bandwidth)



(Plot E1: WCDMA 850MHz Channel = 4132 Occupied bandwidth)



(Plot E2: WCDMA 850MHz Channel = 4183 Occupied bandwidth)



(Plot E3: WCDMA 850MHz Channel = 4233 Occupied bandwidth)

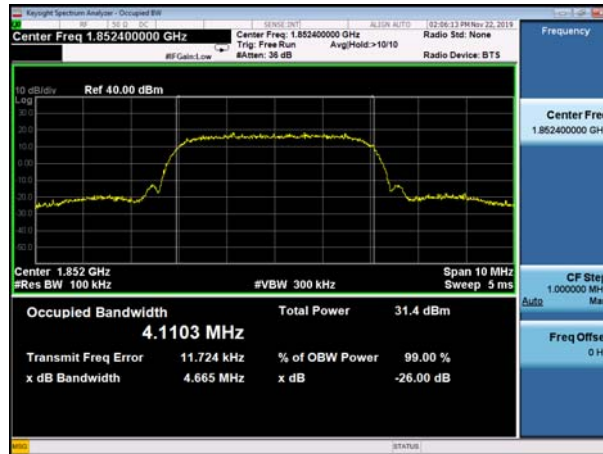

(Plot F1: WCDMA 1900MHz Channel = 9262 Occupied bandwidth)



(Plot F2: WCDMA 1900MHz Channel = 9400 Occupied bandwidth)



(Plot F3: WCDMA 1900MHz Channel = 9538 Occupied bandwidth)

## **2.4 Frequency Stability**

### **2.4.1 Requirement**

The frequency stability shall be measured by variation of ambient temperature and variation of primary supply voltage to ensure that the fundamental emission stays within the authorized frequency block. The frequency stability of the transmitter shall be maintained within  $\pm 0.00025\%$  ( $\pm 2.5\text{ppm}$ ) of the center frequency.

### **2.4.2 Measuring Instruments**

The measuring equipment is listed in the section 3 of this test report.

### **2.4.3 Test Procedures for Temperature Variation**

1. The testing follows FCC KDB 971168 D01 v03r01 Section 9.0.
2. The EUT was set up in the thermal chamber and connected with the system simulator.
3. With power OFF, the temperature was decreased to  $-30^{\circ}\text{C}$  and the EUT was stabilized before testing. Power was applied and the maximum change in frequency was recorded within one minute.
4. With power OFF, the temperature was raised in  $10^{\circ}\text{C}$  steps up to  $50^{\circ}\text{C}$ . The EUT was stabilized at each step for at least half an hour. Power was applied and the maximum frequency change was recorded within one minute.

### **2.4.4 Test Procedures for Voltage Variation**

1. The testing follows FCC KDB 971168 D01 v03r01 Section 9.0.
2. The EUT was placed in a temperature chamber at  $25\pm 5^{\circ}\text{C}$  and connected with the system simulator.
3. The power supply voltage to the EUT was varied from BEP to 115% of the nominal value measured at the input to the EUT.
4. The variation in frequency was measured for the worst case.

### 2.4.5 Test Setup

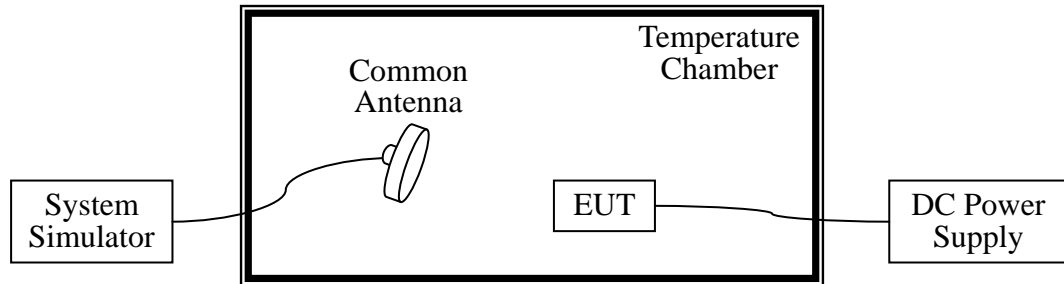

### 2.4.6 Test Results of Frequency Stability

GSM 850MHz Band

|             |         |            |          |
|-------------|---------|------------|----------|
| Band:       | GSM 850 | Channel:   | 190      |
| Limit(ppm): | 2.5     | Frequency: | 836.6MHz |

| Power (VDC) | Temperature (°C) | GSM             | EDGE            | Result |
|-------------|------------------|-----------------|-----------------|--------|
|             |                  | Deviation (ppm) | Deviation (ppm) |        |
| 3.85        | -30              | 0.029           | <b>0.069</b>    | PASS   |
|             | -20              | 0.030           | 0.030           |        |
|             | -10              | 0.019           | 0.022           |        |
|             | 0                | 0.020           | 0.021           |        |
|             | +10              | 0.028           | 0.019           |        |
|             | +20              | 0.028           | 0.041           |        |
|             | +30              | <b>0.072</b>    | 0.042           |        |
|             | +40              | 0.028           | 0.039           |        |
|             | +50              | 0.029           | 0.032           |        |
| 4.4         | +25              | 0.028           | 0.030           |        |
| 3.5         | +25              | 0.027           | 0.038           |        |





GSM 1900MHz Band

|             |          |            |           |
|-------------|----------|------------|-----------|
| Band:       | GSM 1900 | Channel:   | 661       |
| Limit(ppm): | 2.5      | Frequency: | 1880.0MHz |

| Power (VDC) | Temperature (°C) | GSM             | EDGE            | Result |
|-------------|------------------|-----------------|-----------------|--------|
|             |                  | Deviation (ppm) | Deviation (ppm) |        |
| 3.85        | -30              | 0.026           | 0.032           | PASS   |
|             | -20              | 0.028           | 0.032           |        |
|             | -10              | 0.026           | 0.028           |        |
|             | 0                | 0.026           | 0.027           |        |
|             | +10              | 0.026           | 0.028           |        |
|             | +20              | 0.027           | 0.022           |        |
|             | +30              | 0.026           | 0.027           |        |
|             | +40              | 0.028           | 0.031           |        |
|             | +50              | 0.027           | 0.028           |        |
| 4.4         | +25              | <b>0.054</b>    | 0.029           |        |
| 3.5         | +25              | 0.027           | <b>0.092</b>    |        |

WCDMA 850MHz Band

|             |              |            |          |
|-------------|--------------|------------|----------|
| Band:       | WCDMA Band V | Channel:   | 4183     |
| Limit(ppm): | 2.5          | Frequency: | 836.6MHz |

| Power (VDC) | Temperature (°C) | RMC 12.2Kbps    | Result |
|-------------|------------------|-----------------|--------|
|             |                  | Deviation (ppm) |        |
| 3.85        | -30              | 0.0008          | PASS   |
|             | -20              | <b>0.0093</b>   |        |
|             | -10              | 0.0082          |        |
|             | 0                | 0.0081          |        |
|             | +10              | 0.0079          |        |
|             | +20              | 0.0083          |        |
|             | +30              | 0.0077          |        |
|             | +40              | 0.0077          |        |
|             | +50              | 0.0082          |        |
| 4.4         | +25              | 0.0081          |        |
| 3.5         | +25              | 0.0083          |        |



## WCDMA 1900MHz Band

|             |               |            |           |
|-------------|---------------|------------|-----------|
| Band:       | WCDMA Band II | Channel:   | 9400      |
| Limit(ppm): | 2.5           | Frequency: | 1880.0MHz |

| Power (VDC) | Temperature (°C) | RMC 12.2Kbps    | Result |
|-------------|------------------|-----------------|--------|
|             |                  | Deviation (ppm) |        |
| 3.85        | -30              | 0.0084          | PASS   |
|             | -20              | 0.0087          |        |
|             | -10              | <b>0.0099</b>   |        |
|             | 0                | 0.0089          |        |
|             | +10              | 0.0089          |        |
|             | +20              | 0.0090          |        |
|             | +30              | 0.0093          |        |
|             | +40              | 0.0091          |        |
|             | +50              | 0.0087          |        |
| 4.4         | +25              | 0.0048          |        |
| 3.5         | +25              | 0.0093          |        |

## **2.5 Conducted Out of Band Emissions**

### **2.5.1 Requirement**

The power of any emission outside of the authorized operating frequency ranges must be lower than the transmitter power (P) by a factor of at least  $43 + 10 \log (P)$  dB.

It is measured by means of a calibrated spectrum analyzer and scanned from 30 MHz up to a frequency including its 10th harmonic.

### **2.5.2 Measuring Instruments**

The measuring equipment is listed in the section 3 of this test report.

### **2.5.3 Test Procedures**

1. The testing follows FCC KDB 971168 D01 v03r01 Section 6.0.
2. The EUT was connected to the spectrum analyzer and system simulator via a power divider.
3. The RF output of EUT was connected to the spectrum analyzer by an RF cable and attenuator. The path loss was compensated to the results for each measurement.
4. The middle channel for the highest RF power within the transmitting frequency was measured.
5. The conducted spurious emission for the whole frequency range was taken.
6. The RF fundamental frequency should be excluded against the limit line in the operating frequency band.
7. The limit line is derived from  $43 + 10\log(P)$  dB below the transmitter power P(Watts)  
 $= P(W) - [43 + 10\log(P)]$  (dB)  
 $= [30 + 10\log(P)]$  (dBm) -  $[43 + 10\log(P)]$  (dB)  
 $= -13\text{dBm}$ .
8. For 9KHz to 30MHz: the amplitude of spurious emissions are attenuated by more than 20dB below the permissible value has no need to be reported.

### 2.5.4 Test Setup

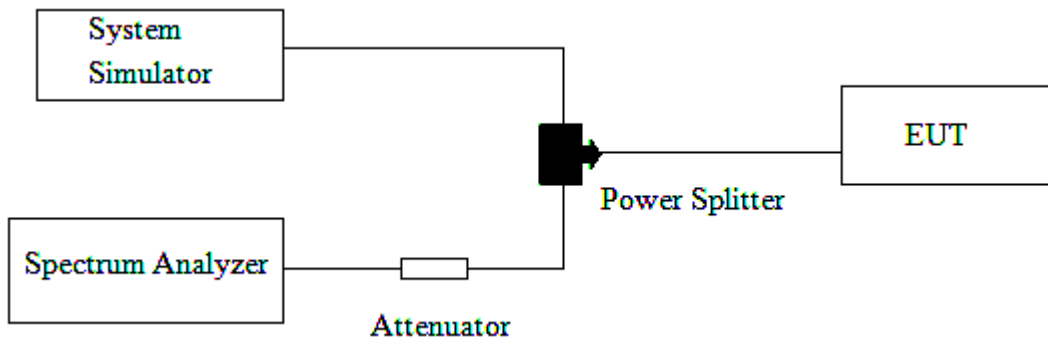

### 2.5.5 Test Result (Plots) of Conducted Spurious Emission

Note: For 9 KHz to 30MHz: the amplitude of spurious emissions is attenuated by more than 20dB below the permissible value, so we not provide the test result here.

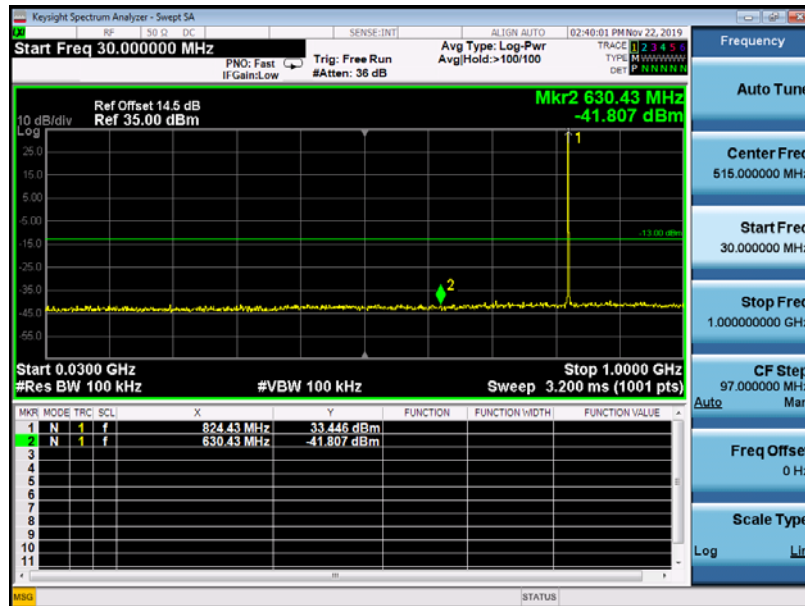

GSM 850MHz Channel = 128, 30MHz to 1GHz

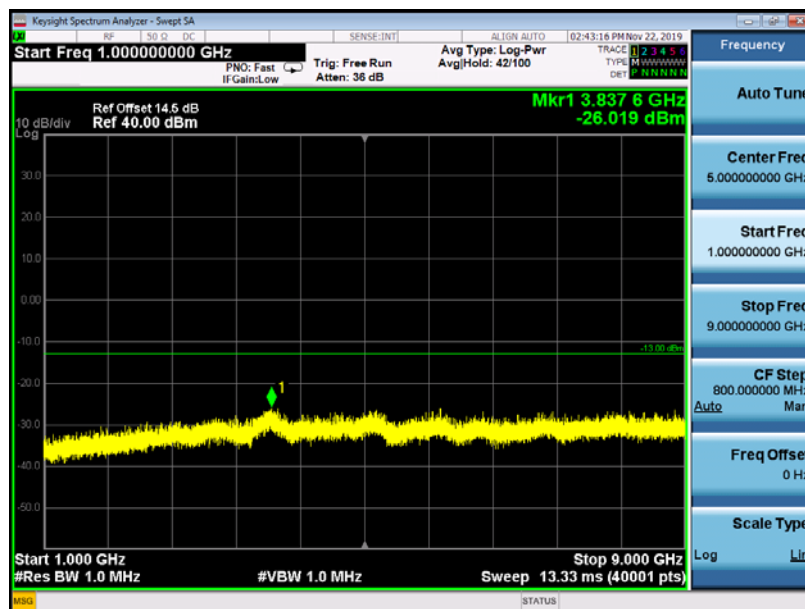

GSM 850MHz Channel = 128, 1GHz to 9GHz

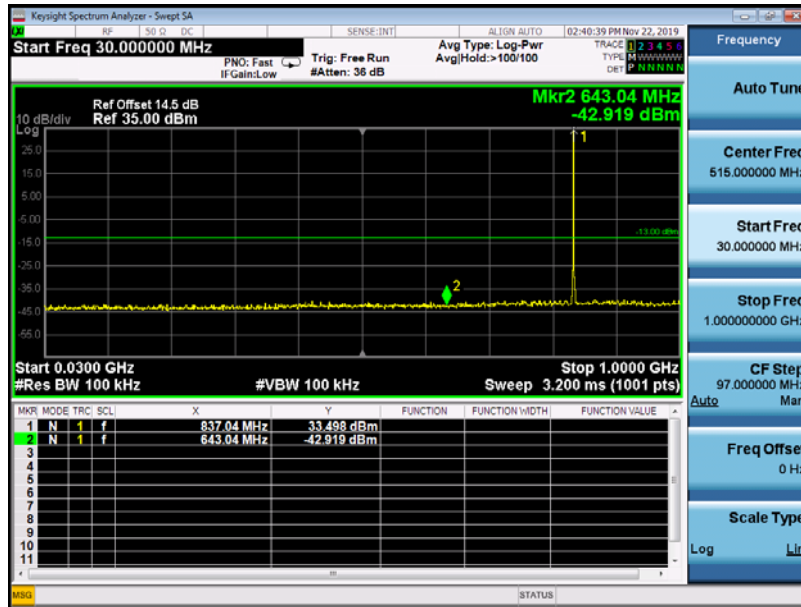

GSM 850MHz Channel = 190, 30MHz to 1GHz

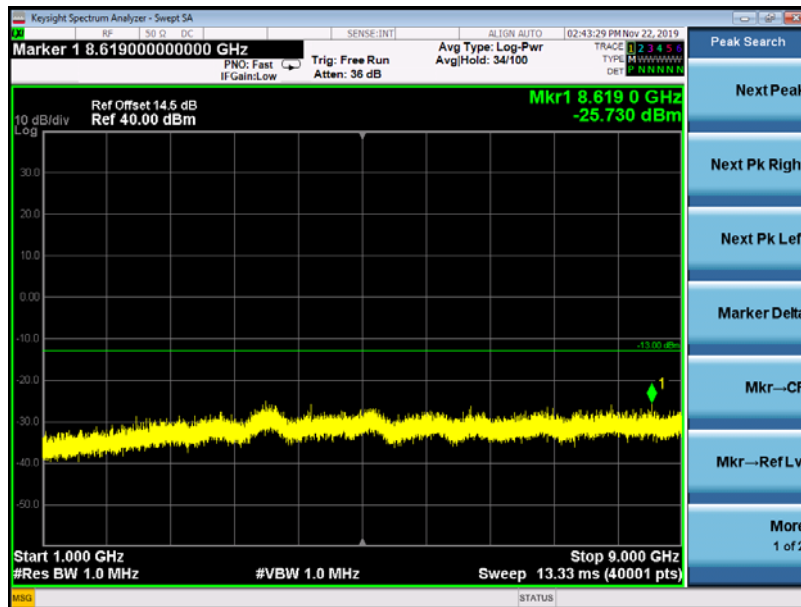

GSM 850MHz Channel = 190, 1GHz to 9GHz

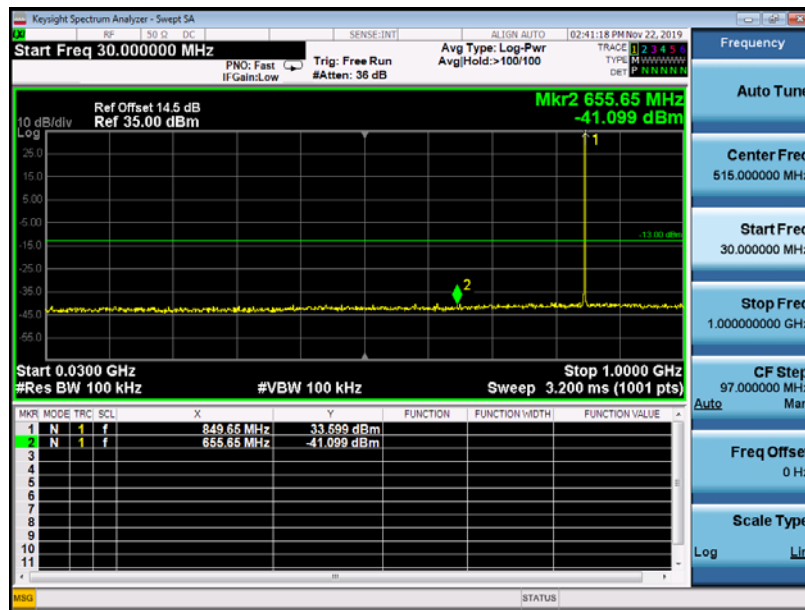

GSM 850MHz Channel = 251, 30MHz to 1GHz

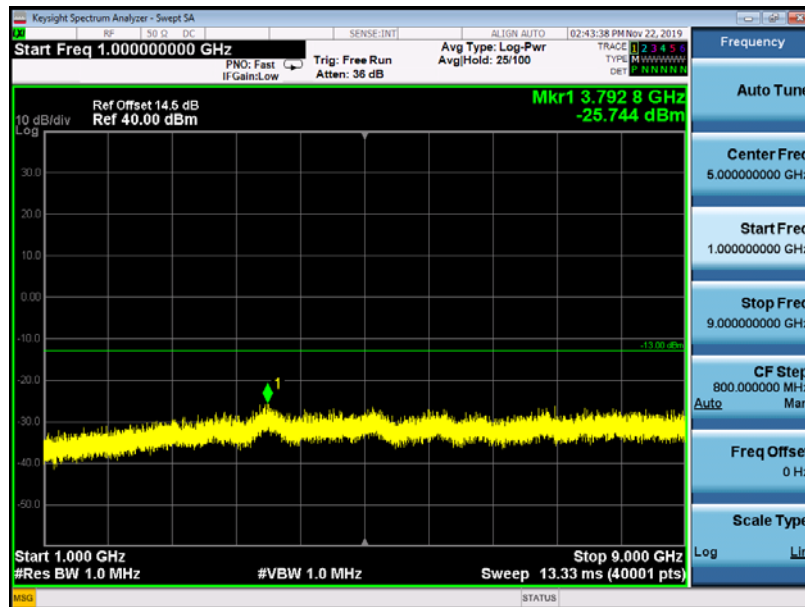

GSM 850MHz Channel = 251, 1GHz to 9GHz

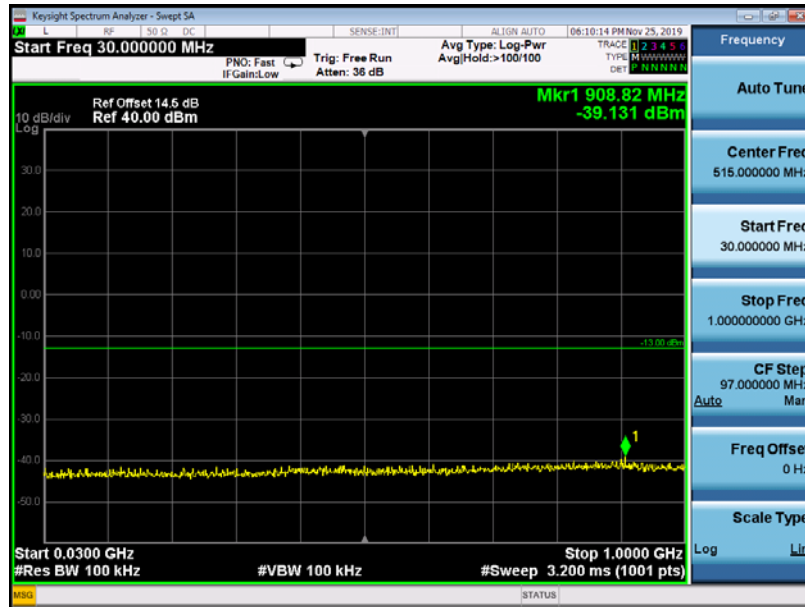

GSM 1900MHz Channel = 512, 30MHz to 1GHz

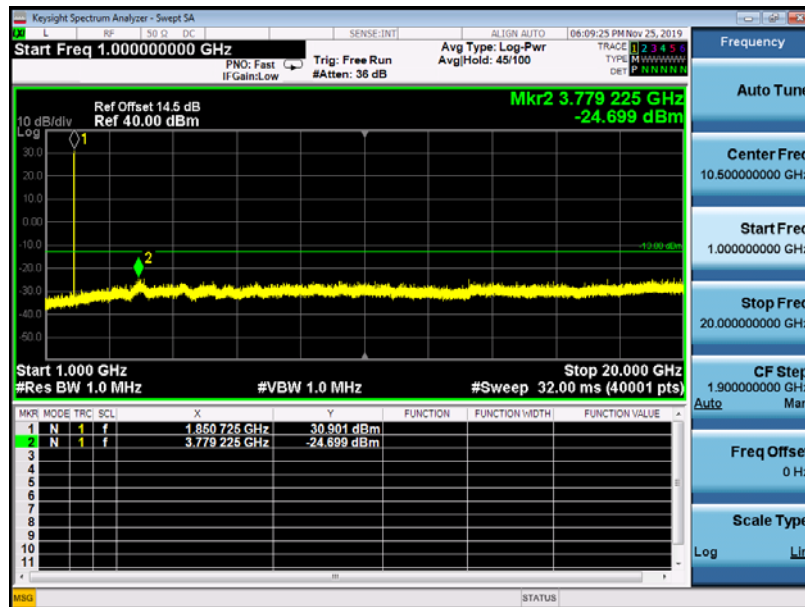

GSM 1900MHz Channel = 512, 1GHz to 20GHz



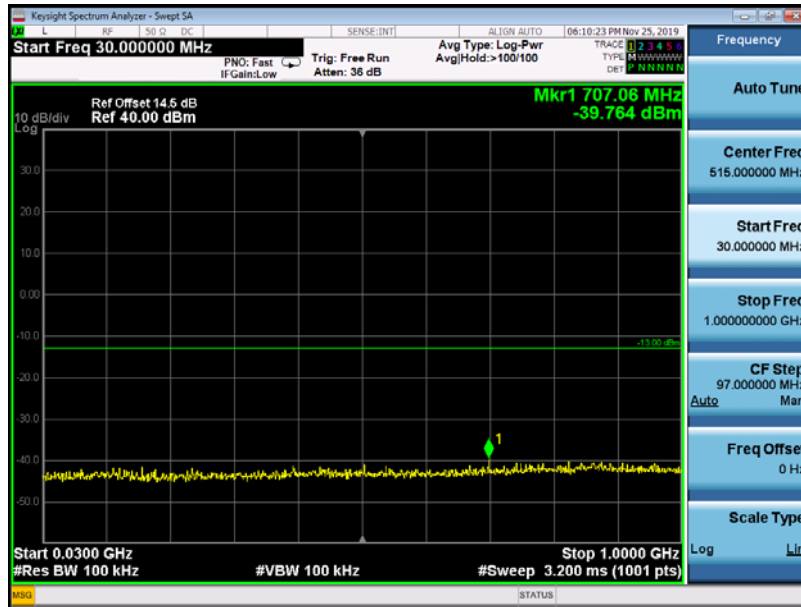

GSM 1900MHz Channel = 661, 30MHz to 1GHz

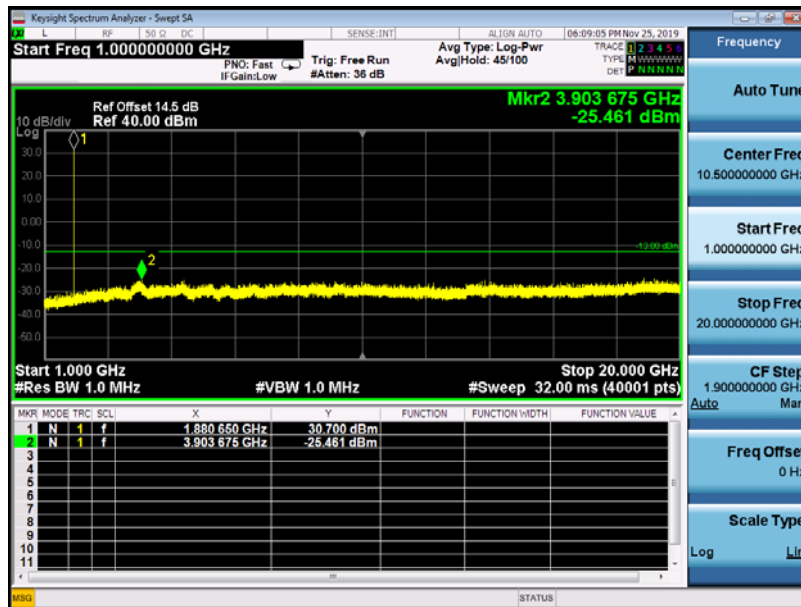

GSM 1900MHz Channel = 661, 1GHz to 20GHz

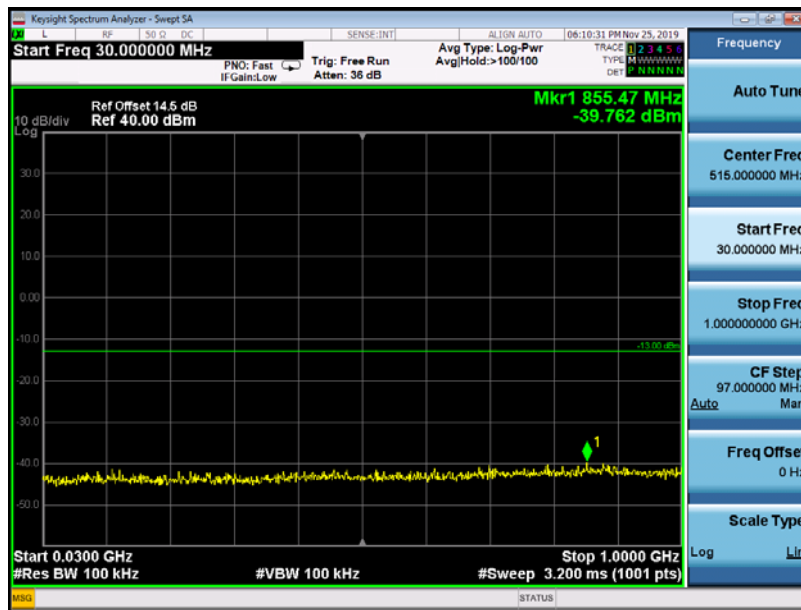

GSM 1900MHz Channel = 810, 30MHz to 1GHz

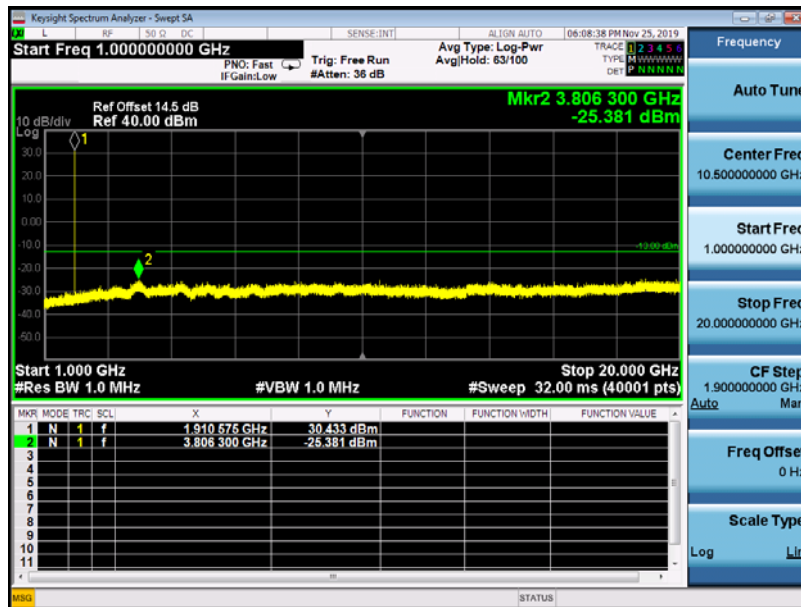

GSM 1900MHz Channel = 810, 1GHz to 20GHz

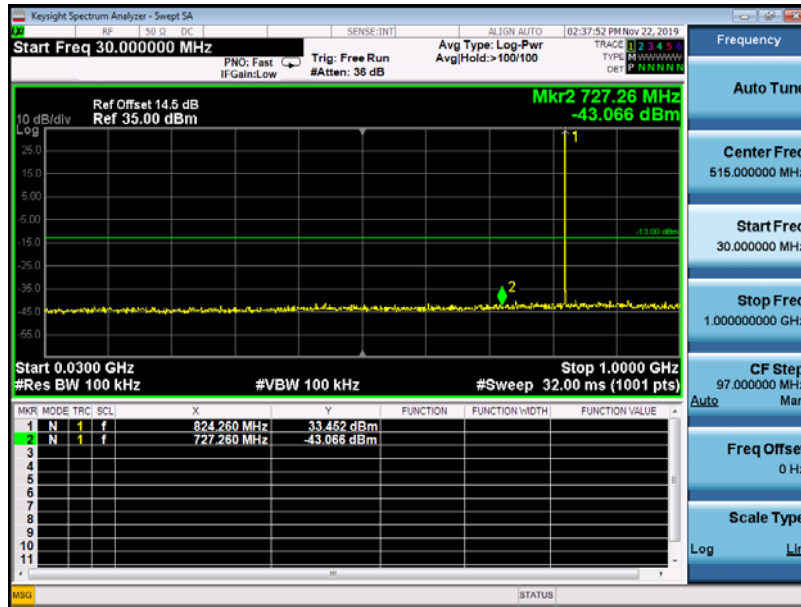

EDGE 850MHz Channel = 128, 30MHz to 1GHz

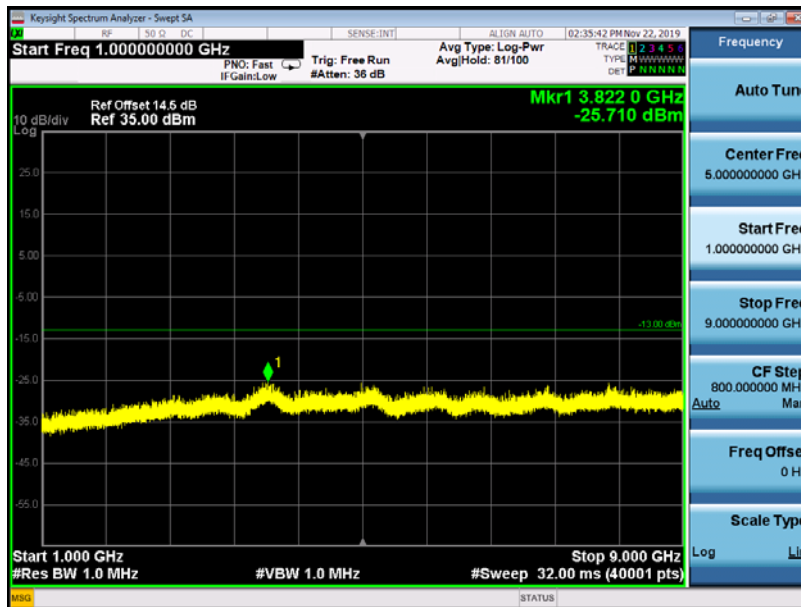

EDGE 850MHz Channel = 128, 1GHz to 9GHz

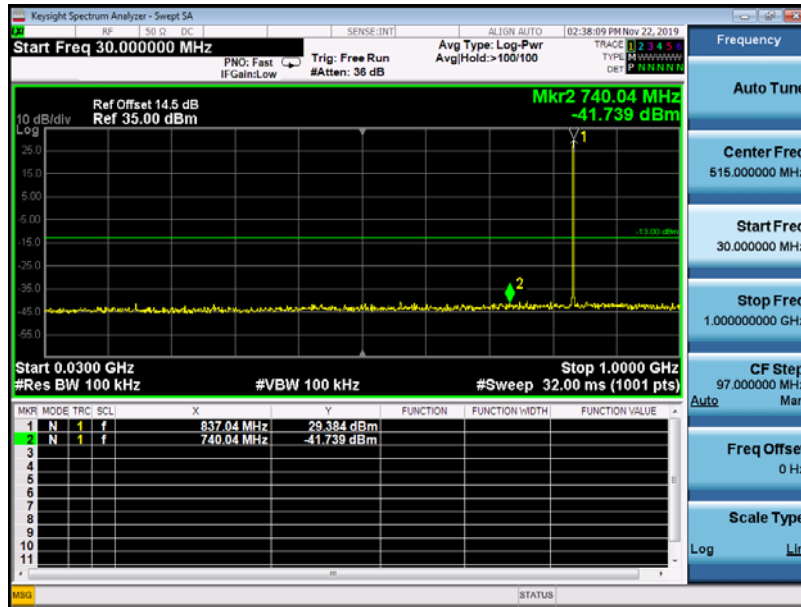

EDGE 850MHz Channel = 190, 30MHz to 1GHz

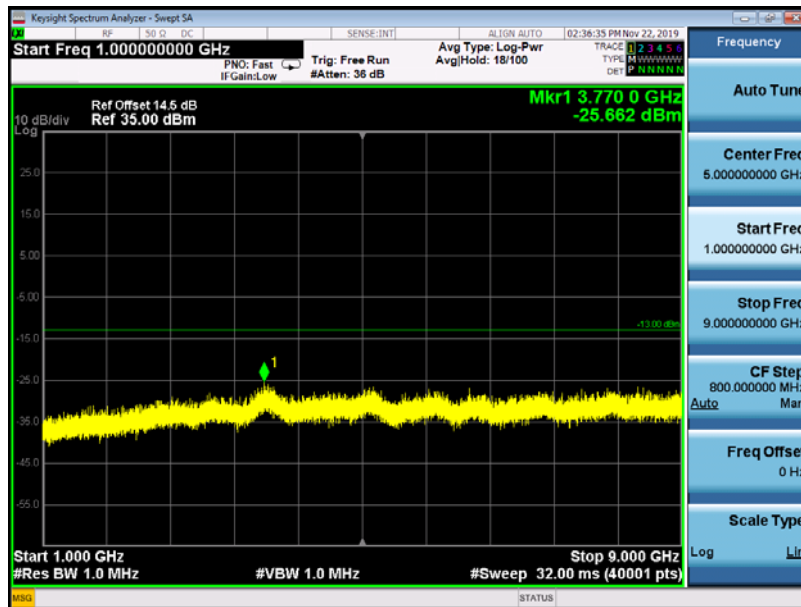

EDGE 850MHz Channel = 190, 1GHz to 9GHz

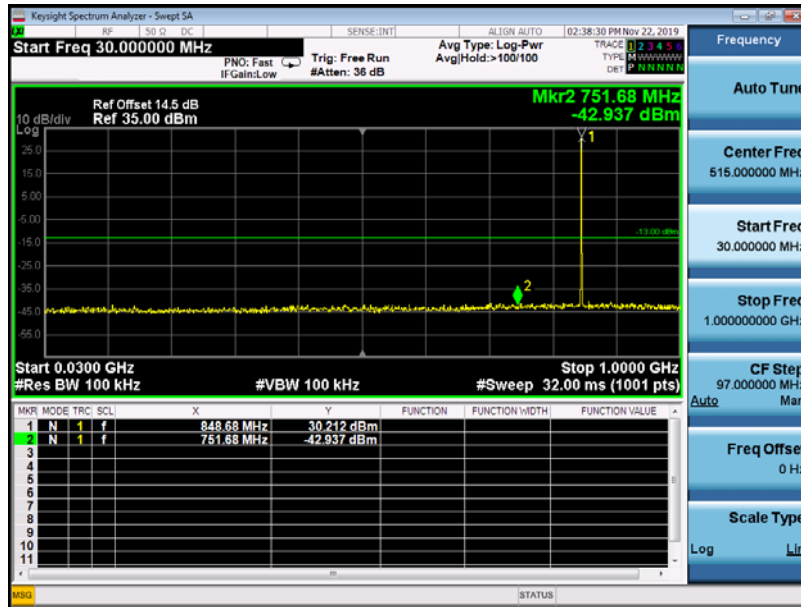

EDGE 850MHz Channel = 251, 30MHz to 1GHz

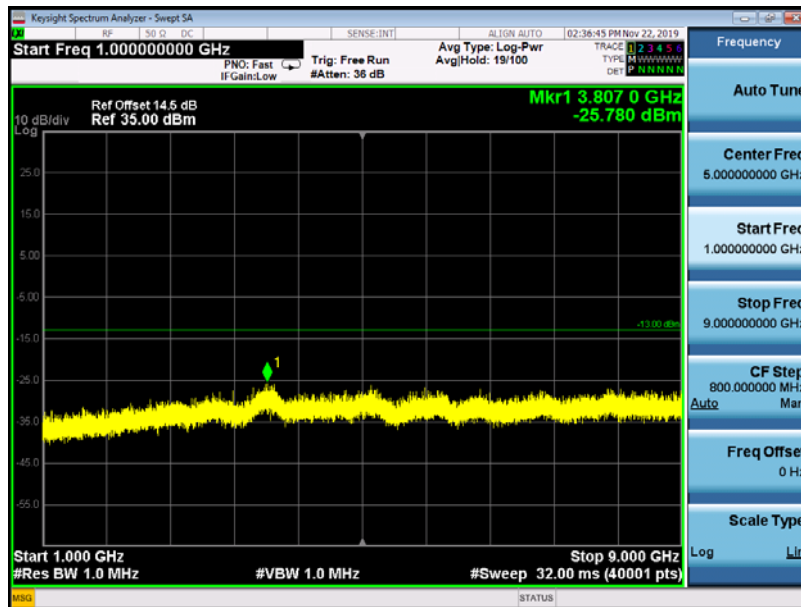

EDGE 850MHz Channel = 251, 1GHz to 9GHz

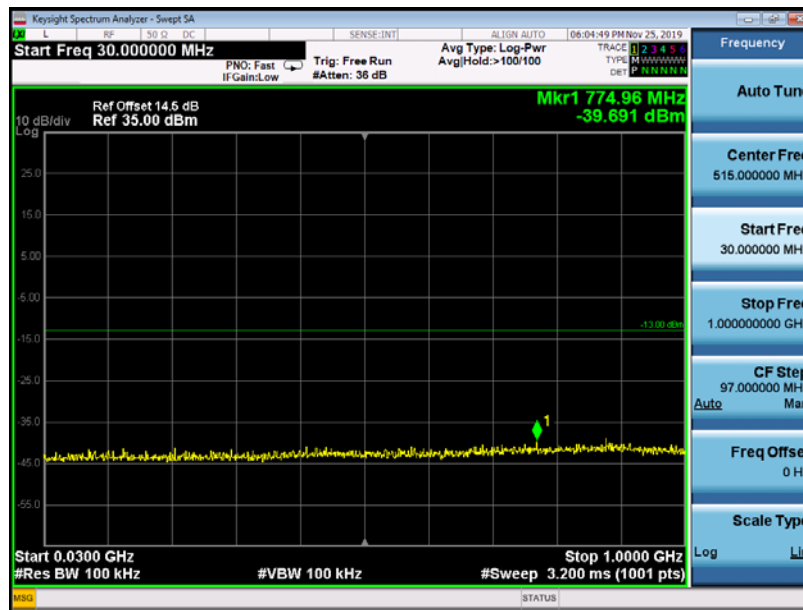

EDGE 1900MHz Channel = 512, 30MHz to 1GHz

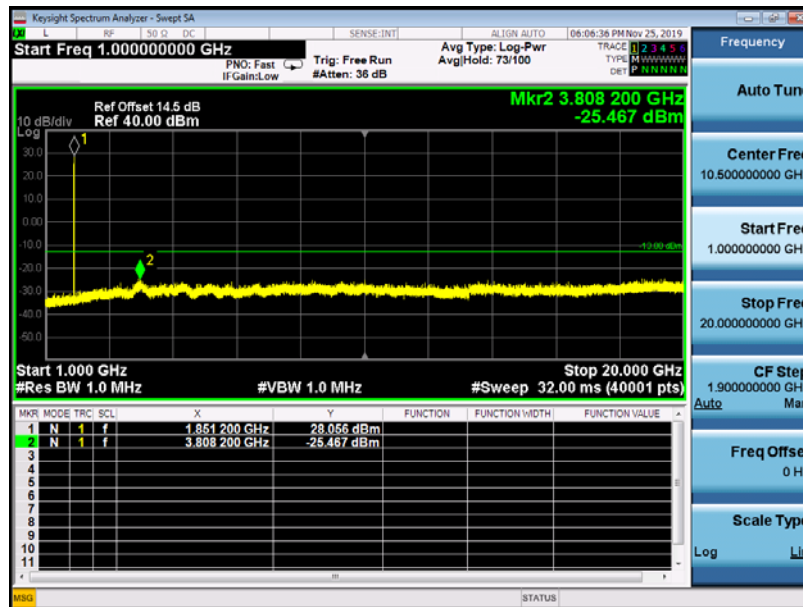

EDGE 1900MHz Channel = 512, 1GHz to 20GHz

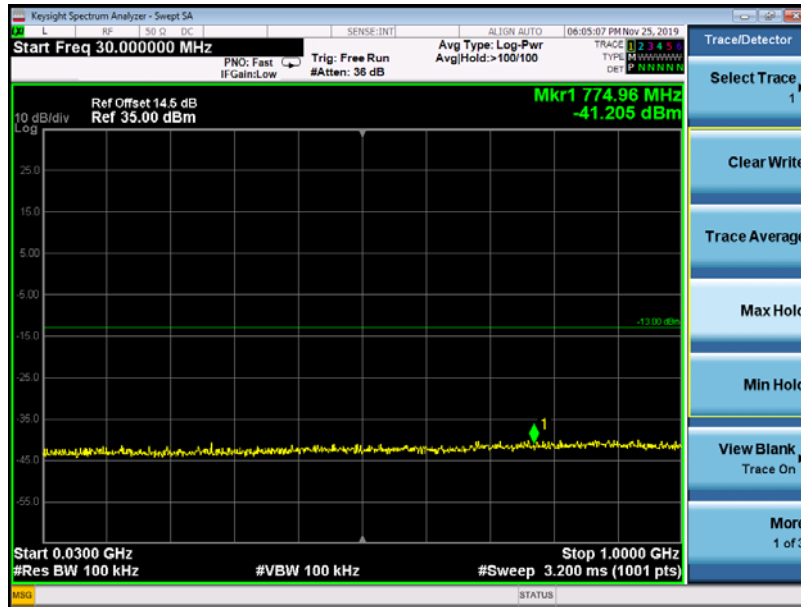

EDGE 1900MHz Channel = 661, 30MHz to 1GHz

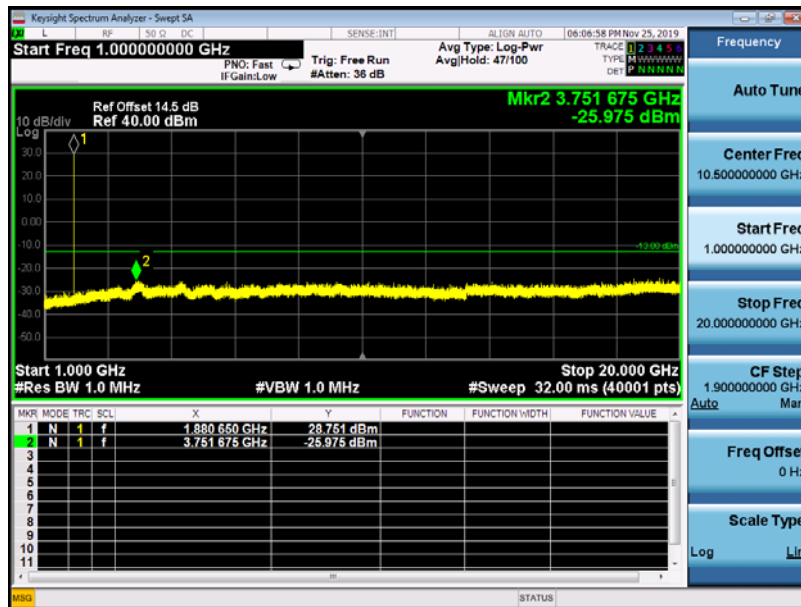

EDGE 1900MHz Channel = 661, 1GHz to 20GHz

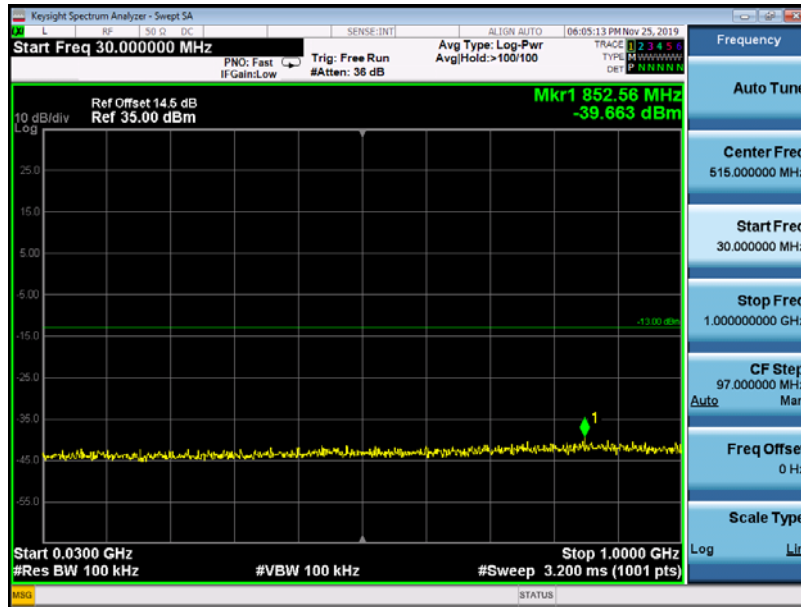

EDGE 1900MHz Channel = 810, 30MHz to 1GHz

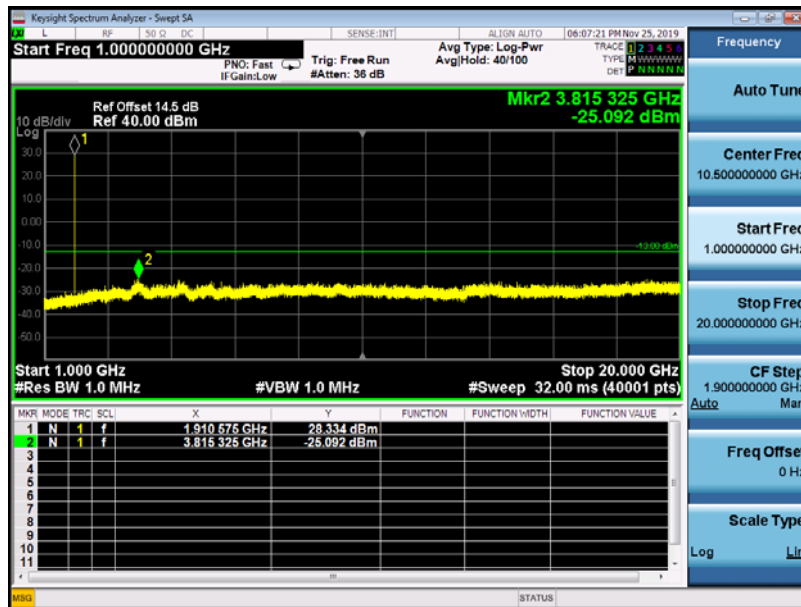

EDGE 1900MHz Channel = 810, 1GHz to 20GHz



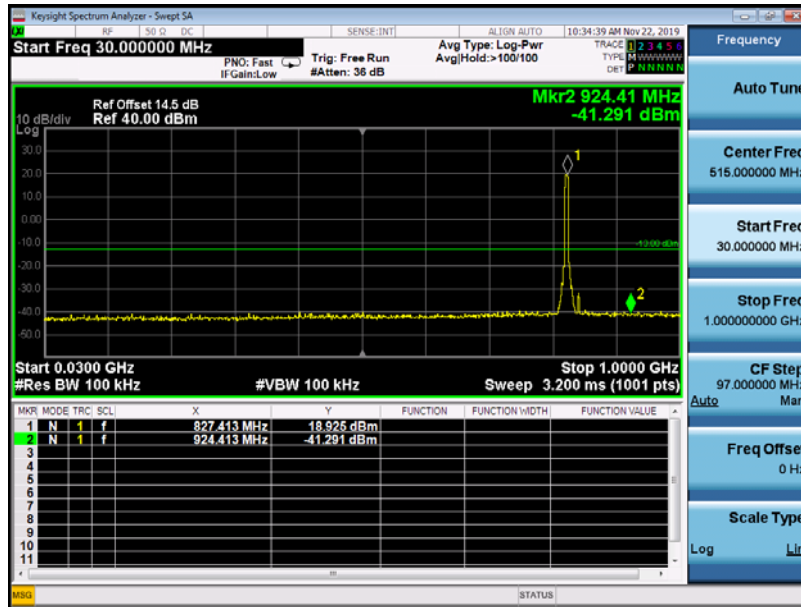

WCDMA850MHz Channel = 4132, 30MHz to 1GHz

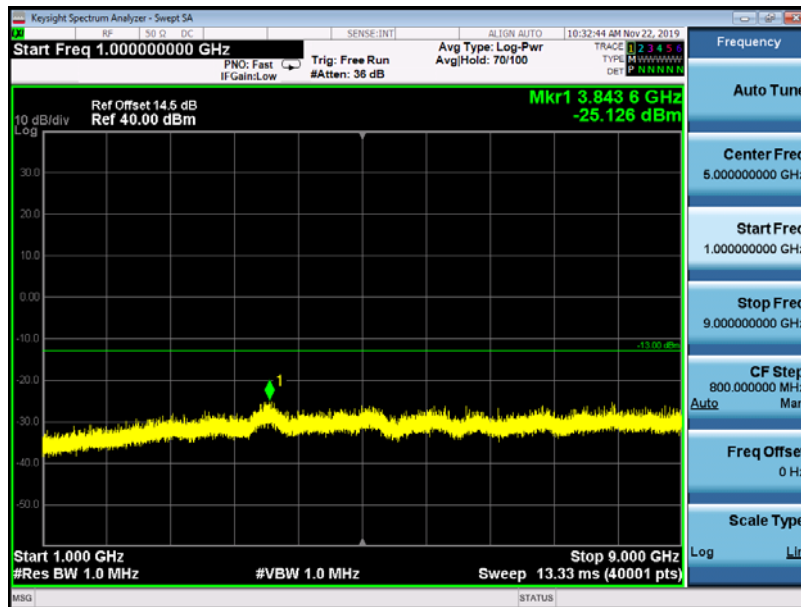

WCDMA850MHz Channel = 4132, 1GHz to 9GHz

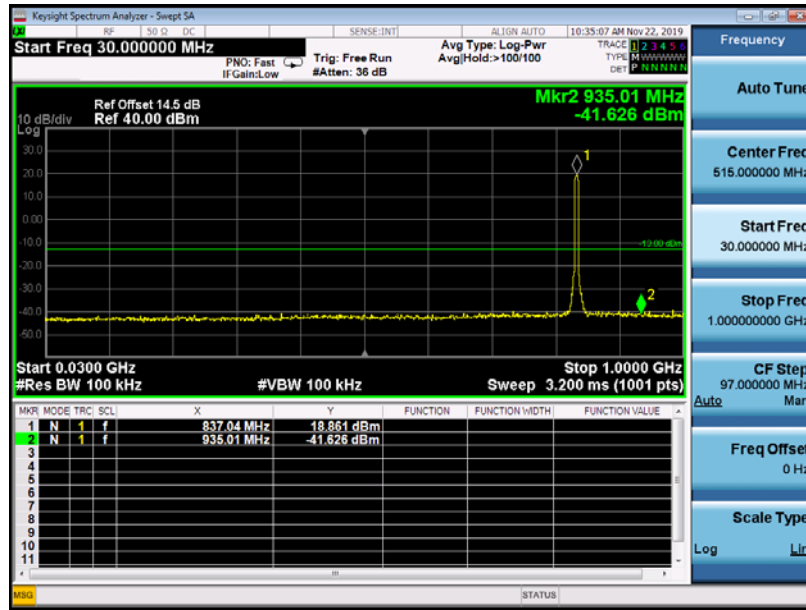

WCDMA850MHz Channel = 4183, 30MHz to 1GHz

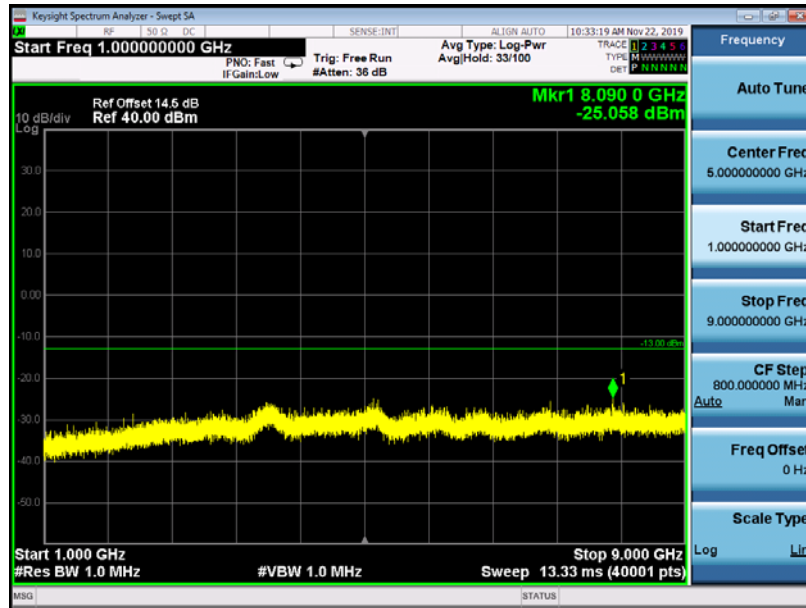

WCDMA850MHz Channel = 4183, 1GHz to 9GHz

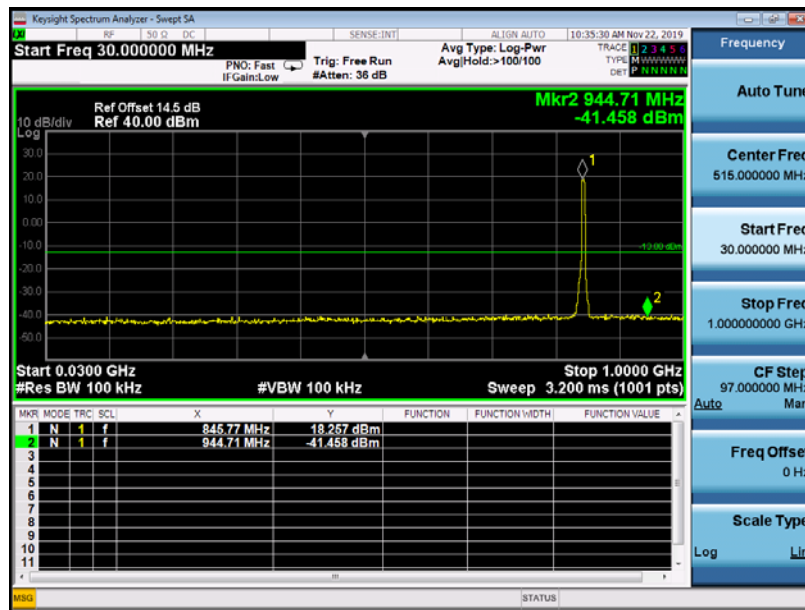

WCDMA850MHz Channel = 4233, 30MHz to 1GHz

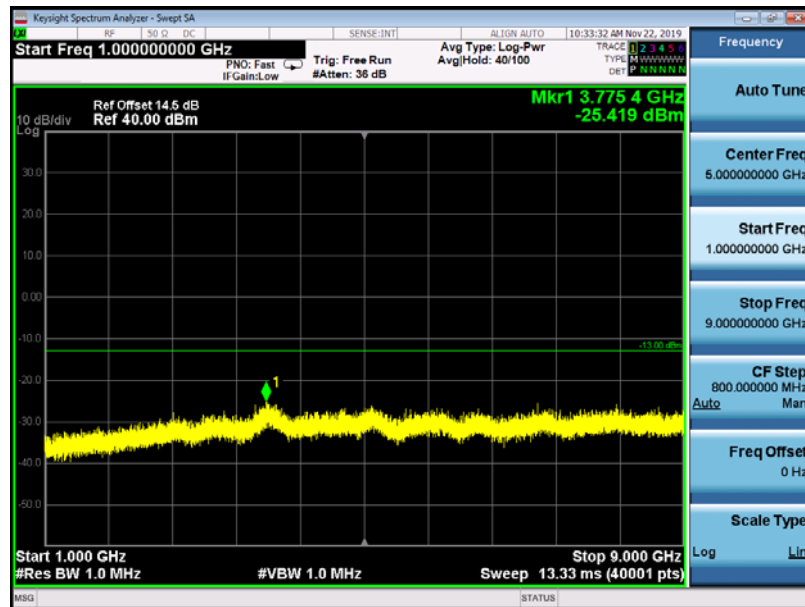

WCDMA850MHz Channel = 4233, 1GHz to 9GHz

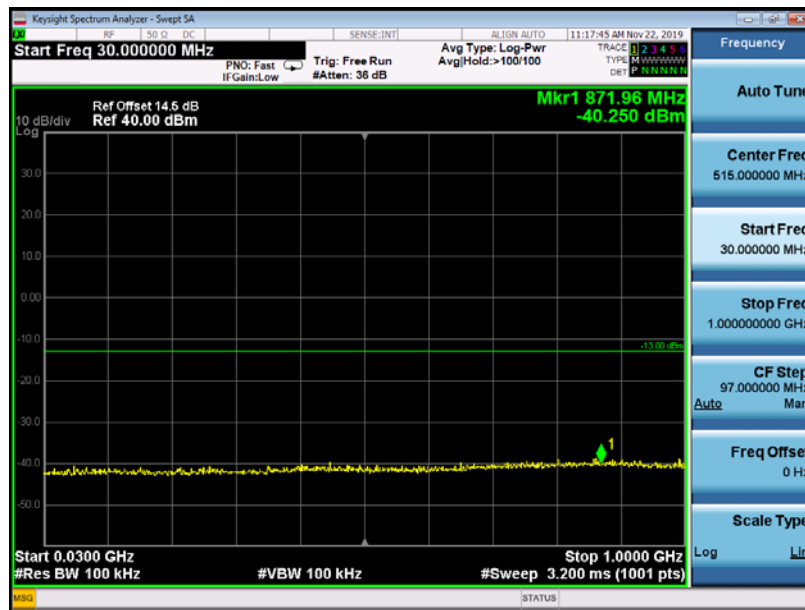

WCDMA1900MHz Channel = 9262, 30MHz to 1GHz

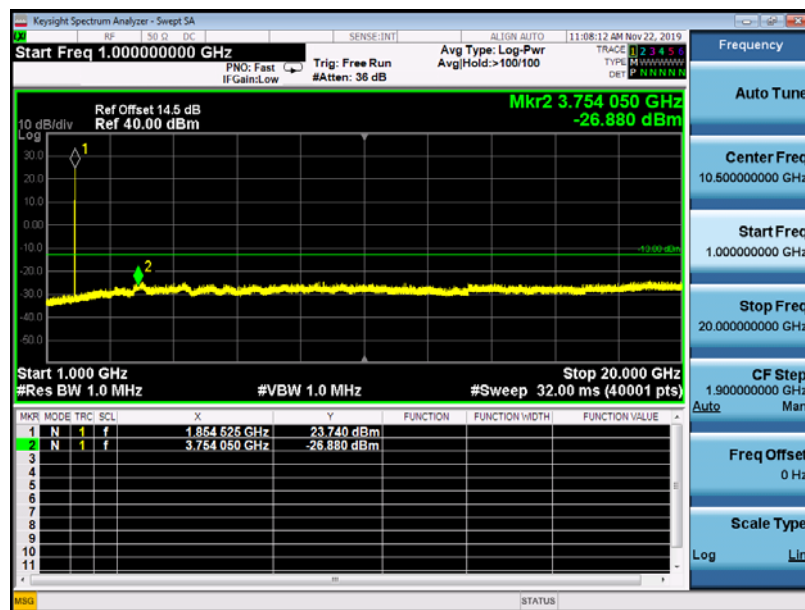

WCDMA1900MHz Channel = 9262, 1GHz to 20GHz

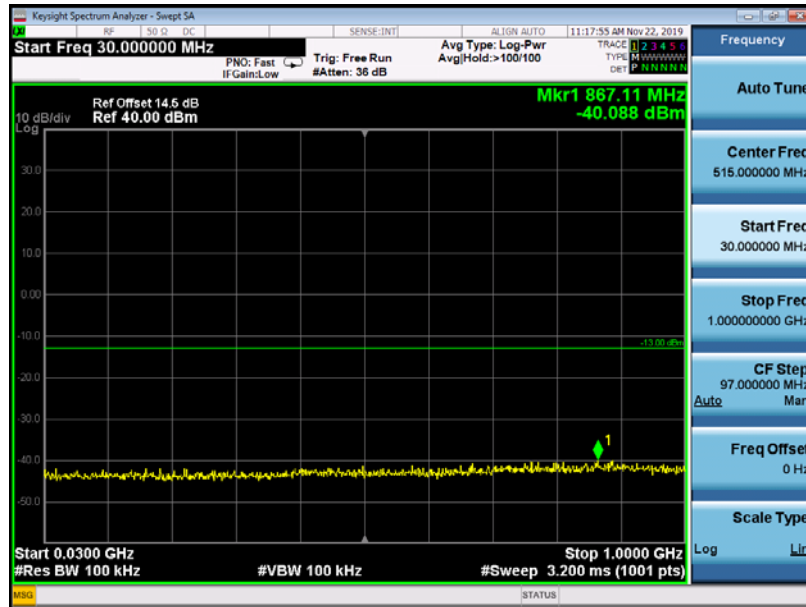

WCDMA1900MHz Channel = 9400, 30MHz to 1GHz

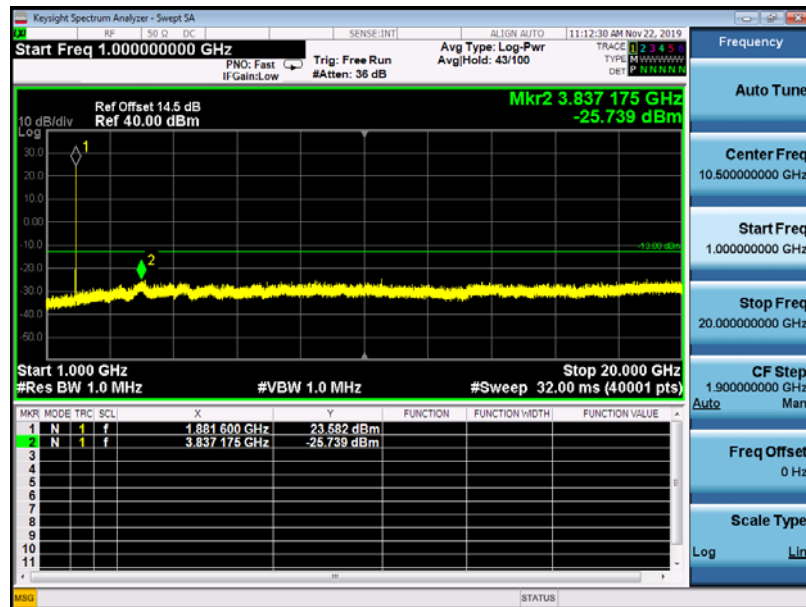

WCDMA1900MHz Channel = 9400, 1GHz to 20GHz

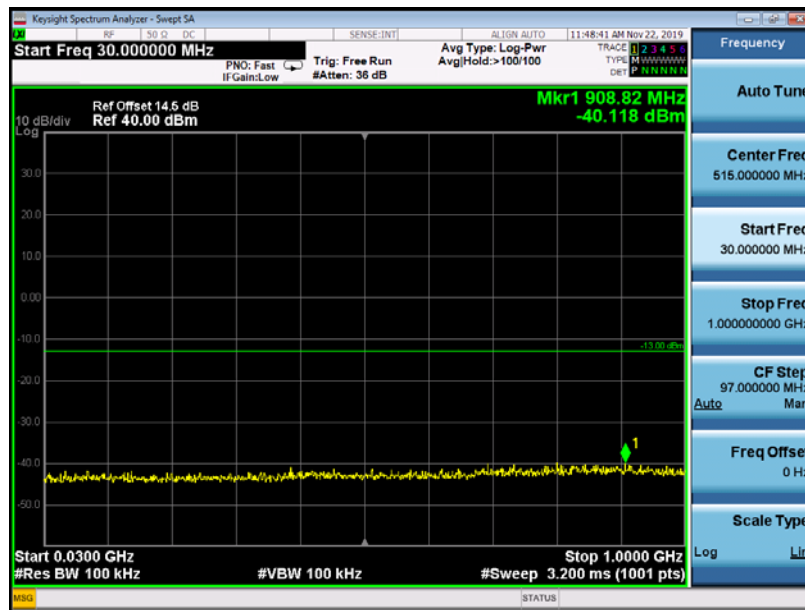

WCDMA1900MHz Channel = 9538, 30MHz to 1GHz

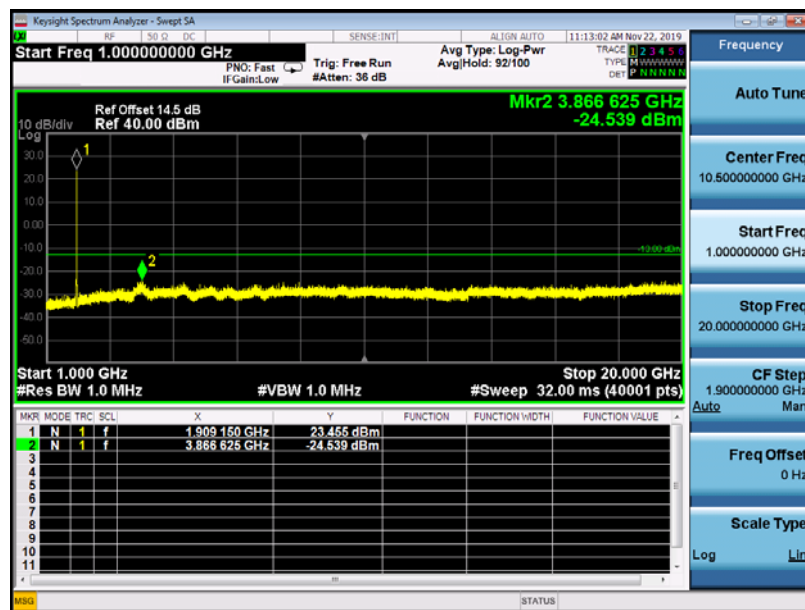

WCDMA1900MHz Channel = 9538 1GHz to 20GHz

## 2.6 Bandedge

### 2.6.1 Requirement

The power of any emission outside of the authorized operating frequency ranges must be lower than the transmitter power (P) by a factor of at least  $43 + 10 \log (P)$  dB.

### 2.6.2 Measuring Instruments

The measuring equipment is listed in the section 3 of this test report.

### 2.6.3 Test Procedures

1. The testing follows FCC KDB 971168 D01 v03r01 Section 6.0.
2. The EUT was connected to the spectrum analyzer and system simulator via a power divider.
3. The RF output of EUT was connected to the spectrum analyzer by an RF cable and attenuator. The path loss was compensated to the results for each measurement.
4. The band GPRSs of low and high channels for the highest RF powers were measured.
5. The RF fundamental frequency should be excluded against the limit line in the operating frequency band.
6. The limit line is derived from  $43 + 10\log(P)$  dB below the transmitter power P(Watts)  
 $= P(W) - [43 + 10\log(P)]$  (dB)  
 $= [30 + 10\log(P)]$  (dBm) -  $[43 + 10\log(P)]$  (dB)  
 $= -13\text{dBm}$ .

### 2.6.4 Test Setup

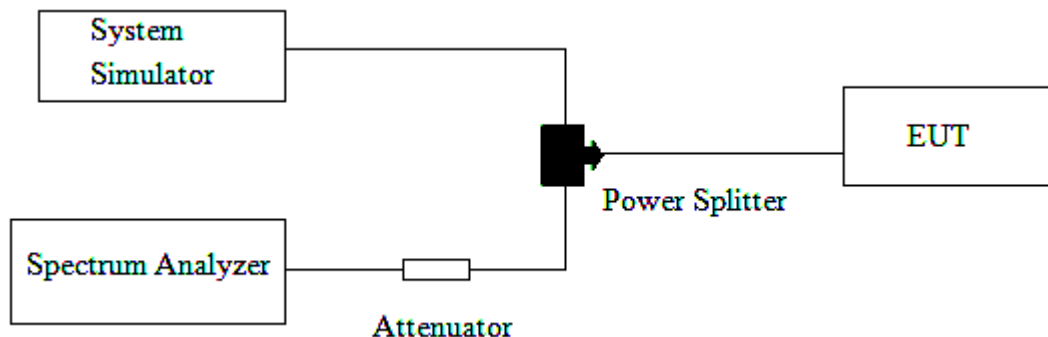

### 2.6.5 Test Result of Conducted Bandedge



(Plot A: GSM 850 Channel = 128)

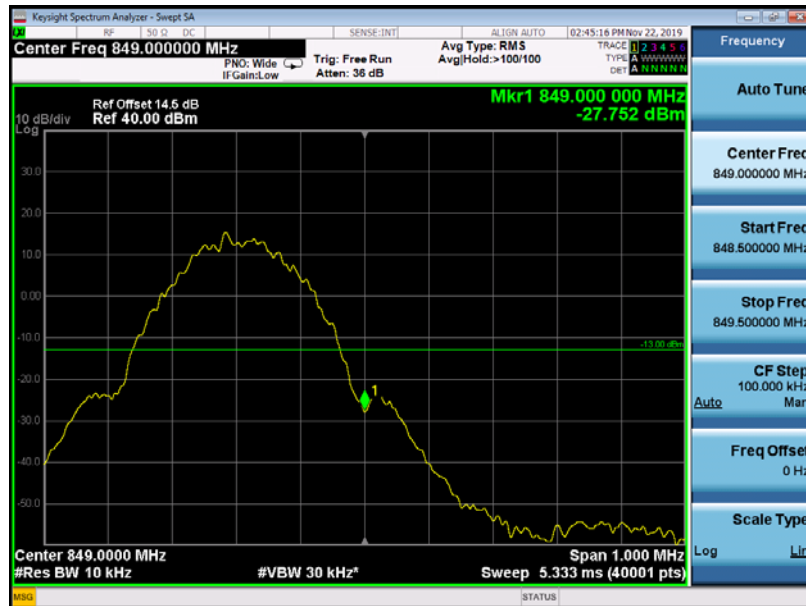

(Plot B: GSM 850 Channel = 251)





(Plot C:GSM 1900 Channel = 512)



(Plot D: GSM 1900 Channel = 810)

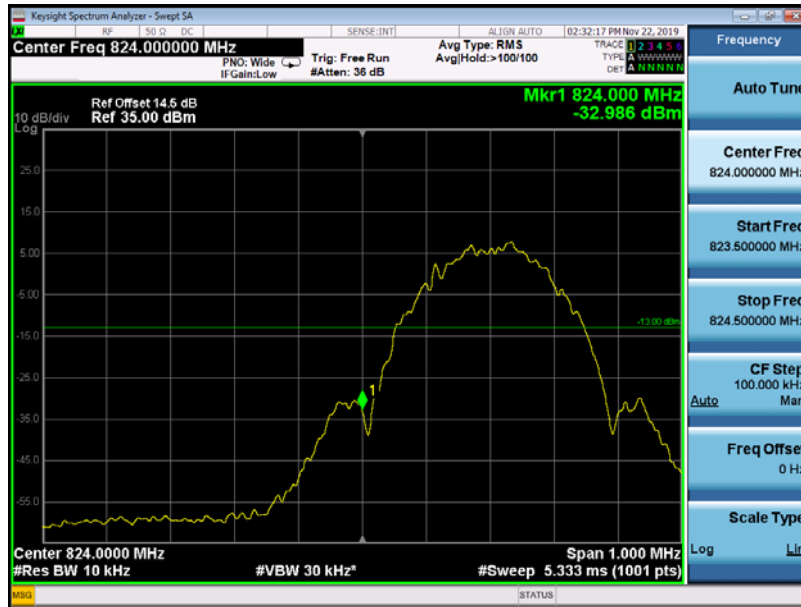

(Plot E: EDGE 850 Channel = 128)



(Plot F: EDGE 850 Channel = 251)



(Plot G: EDGE 1900 Channel = 512)



(Plot H: EDGE 1900 Channel = 810)



(Plot I: WCDMA 850 Channel = 4132)



(Plot J: WCDMA 850 Channel = 4233)



(Plot K: WCDMA 1900 Channel = 9262)



(Plot L: WCDMA 1900 Channel = 9538)

## **2.7 Transmitter Radiated Power (EIRP/ERP)**

### **2.7.1 Requirement**

The substitution method, in ANSI / TIA / EIA-603-D-2010, was used for ERP/EIRP measurement, and the spectrum analyzer configuration follows KDB 971168 D01 Power Meas. License Digital Systems v03r01. The ERP of mobile transmitters must not exceed 7 Watts (Cellular Band) and the EIRP of mobile transmitters are limited to 2 Watts (PCS Band) and 1 Watts (AWS Band).

### **2.7.2 Measuring Instruments**

The measuring equipment is listed in the section 3 of this test report.

### **2.7.3 Test Procedures**

1. The testing follows FCC KDB 971168 D01 v03r01 Section 5.2.1. (for CDMA/WCDMA), Section 5.2.2.2 (for GSM/GSM/GPRS) and ANSI / TIA-603-D-2010 Section 2.2.17.
2. The EUT was placed on a turntable 1.5 meters high in a fully anechoic chamber.
3. The EUT was placed 3 meters from the receiving antenna, which was mounted on the antenna tower.
4. GSM operating modes: Set RBW= 1MHz, VBW= 3MHz, RMS detector over burst;  
UMTS operating modes: Set RBW= 100 kHz, VBW= 300 kHz, RMS detector over frame, and use channel power option with bandwidth=5MHz, per KDB 971168 D01 v03r01.
5. The table was rotated 360 degrees to determine the position of the highest radiated power.
6. The height of the receiving antenna is adjusted to look for the maximum ERP/EIRP.
7. Taking the record of maximum ERP/EIRP.
8. A dipole antenna was substituted in place of the EUT and was driven by a signal generator.

9. The conducted power at the terminal of the dipole antenna is measured.
10. Repeat step 3 to step 5 to get the maximum ERP/EIRP of the substitution antenna.
11.  $ERP/EIRP = P_s + E_t - E_s + G_s = P_s + R_t - R_s + G_s$

$P_s$  (dBm): Input power to substitution antenna.

$G_s$  (dBi or dBd): Substitution antenna Gain.

$E_t = R_t + AF$        $E_s = R_s + AF$

$AF$  (dB/m): Receive antenna factor

$R_t$ : The highest received signal in spectrum analyzer for EUT.

$R_s$ : The highest received signal in spectrum analyzer for substitution antenna.

### 2.7.4 Test Setup

Below 1GHz

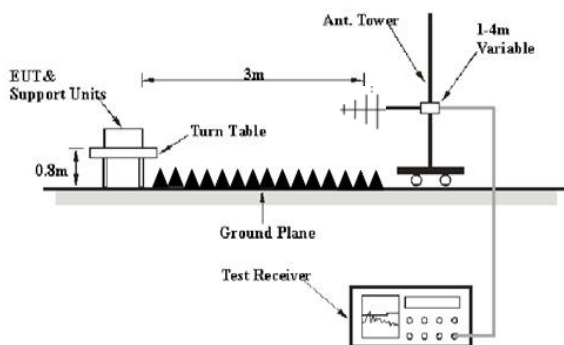

Above 1GHz

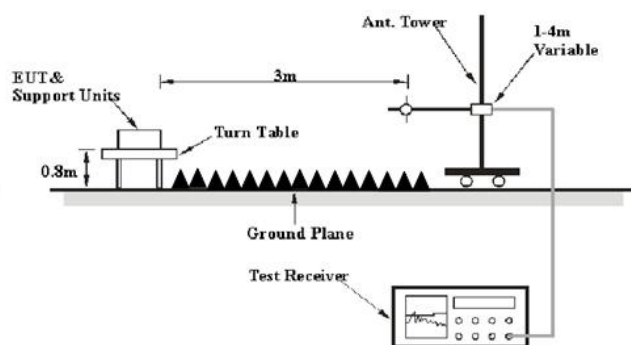



### 2.7.5 Test Result of Transmitter Radiated Power

Test Notes:

1. This device employs GMSK technology with GSM capabilities. All configurations were investigated and the worst case emissions were found in GSM mode.
2. This device employs UMTS technology with WCDMA (AMR/RMC), HSDPA, HSUPA capabilities. All configurations were investigated and the worst case UMTS emissions were found in RMC WCDMA mode at 12.2Kbps.
3. This unit was tested with its standard battery.
4. The worst case test configuration was found in the vertical positioning where the EUT is laying on its side. The data reported in the tables below were measured in this test setup.

| Band       | Channel | Frequency (MHz) | PCL | Antenna Pol (H/V) | Measured ERP dBm | Limit dBm | Verdict |
|------------|---------|-----------------|-----|-------------------|------------------|-----------|---------|
| GSM 850MHz | 128     | 824.20          | 5   | H                 | 32.57            | 38.5      | PASS    |
|            |         |                 |     | V                 | 31.69            |           |         |
|            | 190     | 836.60          | 5   | H                 | <b>32.65</b>     |           | PASS    |
|            |         |                 |     | V                 | 31.26            |           |         |
|            | 251     | 848.80          | 5   | H                 | 32.47            |           | PASS    |
|            |         |                 |     | V                 | 31.27            |           |         |

| Band        | Channel | Frequency (MHz) | PCL | Antenna Pol (H/V) | Measured EIRP dBm | Limit dBm | Verdict |
|-------------|---------|-----------------|-----|-------------------|-------------------|-----------|---------|
| GSM 1900MHz | 512     | 1850.2          | 0   | H                 | 29.26             | 33        | PASS    |
|             |         |                 |     | V                 | 28.27             |           |         |
|             | 661     | 1880.0          | 0   | H                 | <b>29.85</b>      |           | PASS    |
|             |         |                 |     | V                 | 28.25             |           |         |
|             | 810     | 1909.8          | 0   | H                 | 29.25             |           | PASS    |
|             |         |                 |     | V                 | 28.41             |           |         |





| Band           | Channel | Frequency (MHz) | PCL | Antenna Pol (H/V) | Measured ERP dBm | Limit dBm | Verdict |
|----------------|---------|-----------------|-----|-------------------|------------------|-----------|---------|
| EDGE<br>850MHz | 128     | 824.20          | 5   | H                 | 25.57            | 38.5      | PASS    |
|                |         |                 |     | V                 | 24.32            |           |         |
|                | 190     | 836.60          | 5   | H                 | 25.48            |           | PASS    |
|                |         |                 |     | V                 | 24.29            |           |         |
|                | 251     | 848.80          | 5   | H                 | <b>25.61</b>     |           | PASS    |
|                |         |                 |     | V                 | 24.30            |           |         |

| Band            | Channel | Frequency (MHz) | PCL | Antenna Pol (H/V) | Measured EIRP dBm | Limit dBm | Verdict |
|-----------------|---------|-----------------|-----|-------------------|-------------------|-----------|---------|
| EDGE<br>1900MHz | 512     | 1850.2          | 0   | H                 | <b>24.74</b>      | 33        | PASS    |
|                 |         |                 |     | V                 | 23.52             |           |         |
|                 | 661     | 1880.0          | 0   | H                 | 24.56             |           | PASS    |
|                 |         |                 |     | V                 | 23.94             |           |         |
|                 | 810     | 1909.8          | 0   | H                 | 24.70             |           | PASS    |
|                 |         |                 |     | V                 | 23.87             |           |         |

| Band            | Channel | Frequency (MHz) | Antenna Pol (H/V) | Measured ERP dBm | Limit dBm | Verdict |
|-----------------|---------|-----------------|-------------------|------------------|-----------|---------|
| WCDMA<br>850MHz | 4132    | 826.4           | H                 | 22.65            | 38.5      | PASS    |
|                 |         |                 | V                 | 22.12            |           |         |
|                 | 4175    | 835             | H                 | 22.75            |           | PASS    |
|                 |         |                 | V                 | 22.32            |           |         |
|                 | 4233    | 846.6           | H                 | <b>22.84</b>     |           | PASS    |
|                 |         |                 | V                 | 22.49            |           |         |

| Band             | Channel | Frequency (MHz) | Antenna Pol (H/V) | Measured EIRP dBm | Limit dBm | Verdict |
|------------------|---------|-----------------|-------------------|-------------------|-----------|---------|
| WCDMA<br>1900MHz | 9262    | 1852.4          | H                 | 22.39             | 33        | PASS    |
|                  |         |                 | V                 | 22.07             |           |         |
|                  | 9400    | 1880            | H                 | 22.52             |           | PASS    |
|                  |         |                 | V                 | 22.17             |           |         |
|                  | 9538    | 1907.6          | H                 | <b>22.66</b>      |           | PASS    |
|                  |         |                 | V                 | 22.29             |           |         |

## 2.8 Radiated Spurious Emissions

### 2.8.1 Requirement

The power of any emission outside of the authorized operating frequency ranges must be attenuated below the transmitter power (P) by a factor of at least  $43 + 10 \log (P)$  dB. The spectrum is scanned from 30 MHz up to a frequency including its 10th harmonic.

### 2.8.2 Measuring Instruments

The measuring equipment is listed in the section 3 of this test report.

### 2.8.3 Test Setup

For radiated emissions from 9 kHz to 30MHz

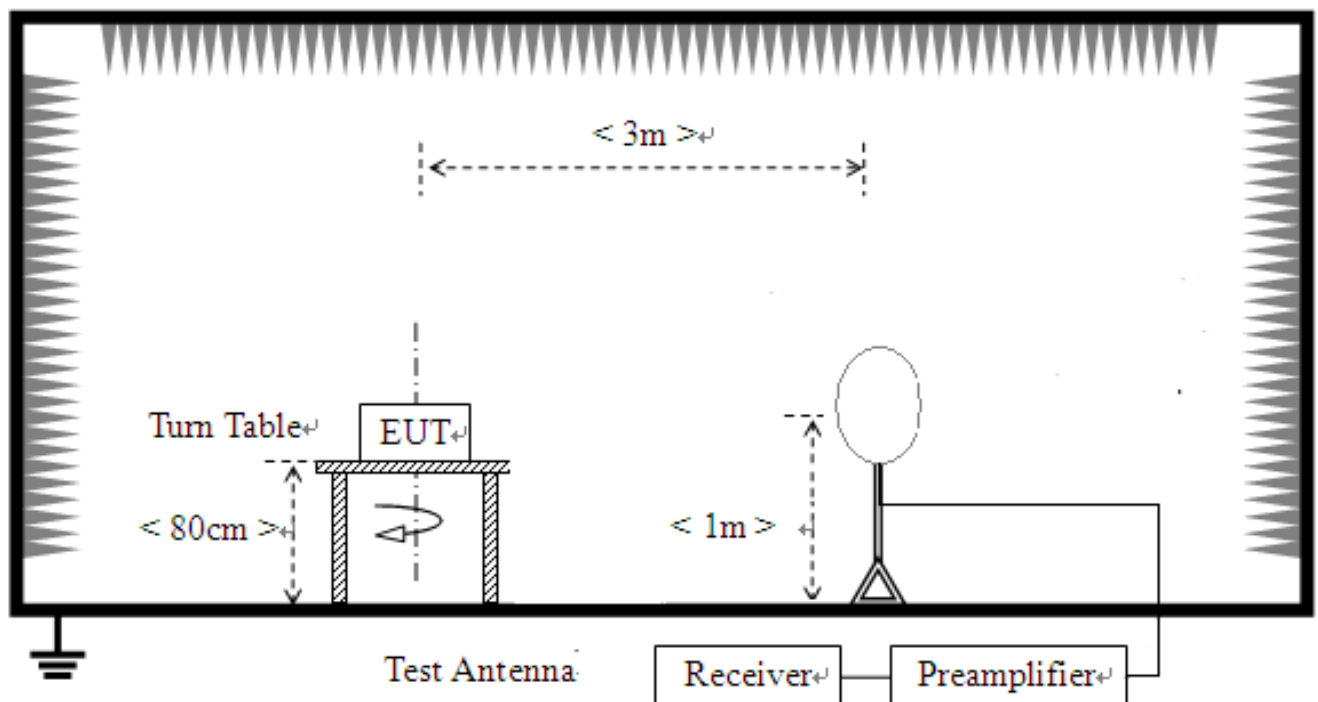

For radiated emissions from 30MHz to 1GHz

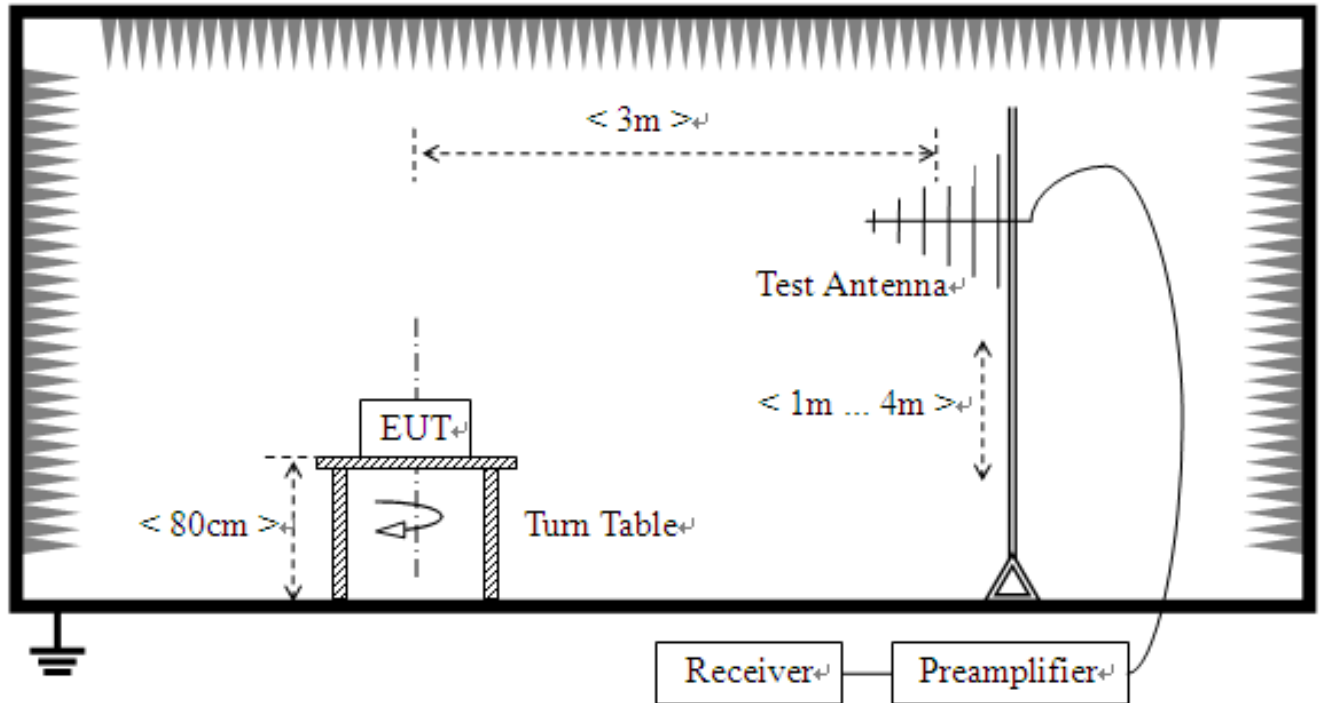

For radiated emissions above 1GHz

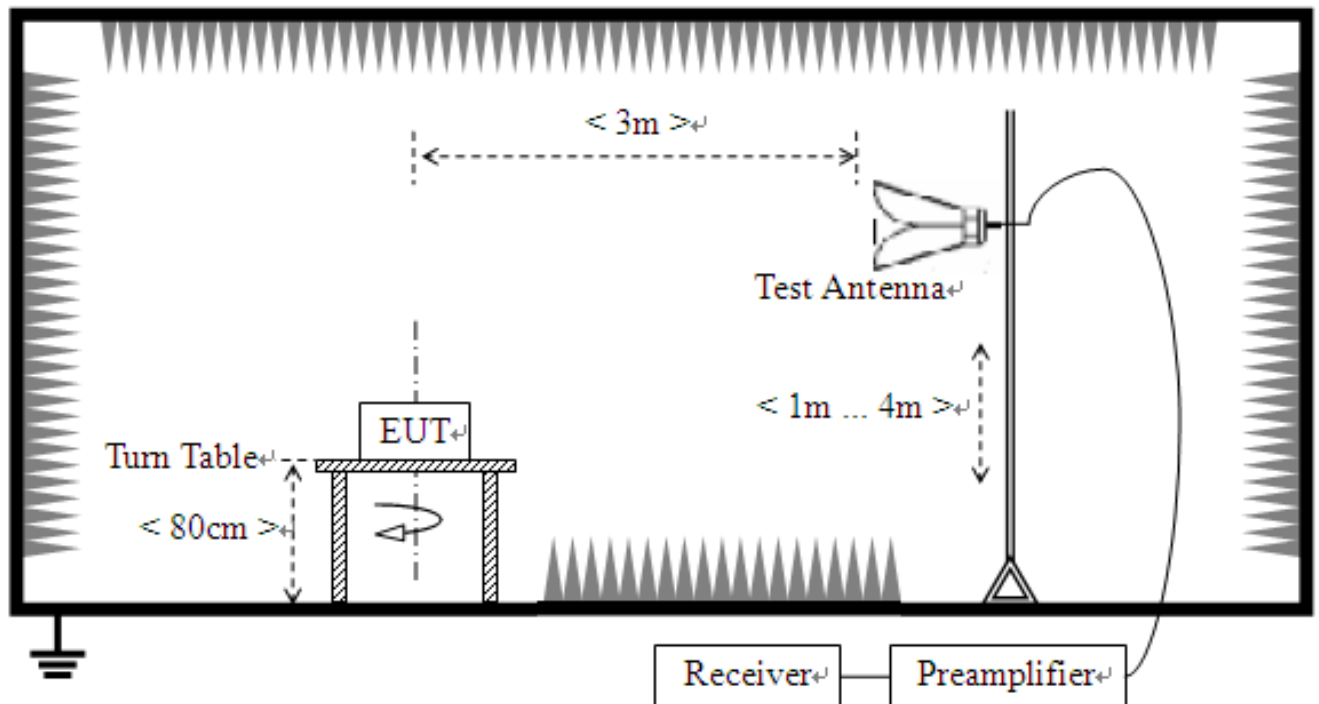

#### 2.8.4 Test Procedures

1. The testing follows FCC KDB 971168 D01 v03r01 Section 5.8 and ANSI / TIA-603-D-2010 Section 2.2.12.
2. The EUT was placed on a rotatable wooden table 0.8 meters above the ground.
3. The EUT was set 3 meters from the receiving antenna, which was mounted on the antenna tower.
4. The table was rotated 360 degrees to determine the position of the highest spurious emission.
5. The height of the receiving antenna is varied between one meter and four meters to search for the maximum spurious emission for both horizontal and vertical polarizations.
6. Make the measurement with the spectrum analyzer's RBW = 1MHz, VBW = 3MHz, taking record of maximum spurious emission.
7. A horn antenna was substituted in place of the EUT and was driven by a signal generator.
8. Tune the output power of signal generator to the same emission level with EUT maximum spurious emission.
9. Taking the record of output power at antenna port.
10. Repeat step 7 to step 8 for another polarization.
11. The RF fundamental frequency should be excluded against the limit line in the operating frequency band.
12. The limit line is derived from  $43 + 10\log(P)$  dB below the transmitter power P(Watts)  
 $= P(W) - [43 + 10\log(P)]$  (dB)  
 $= [30 + 10\log(P)]$  (dBm) -  $[43 + 10\log(P)]$  (dB)  
 $= -13\text{dBm}$ .
13. This device employs GMSK technology with GSM and GSM capabilities. All configurations were investigated and the worst case emissions were found in GSM mode.
14. This device employs UMTS technology with WCDMA (AMR/RMC), HSDPA, HSUPA capabilities. All configurations were investigated and the worst case UMTS emissions were found in RMC WCDMA mode at 12.2Kbps.
15. This unit was tested with its standard battery.
16. All Spurious Emission tests were performed in X, Y, Z axis direction and low, middle, high channel. And only the worst axis test condition was recorded in this test report.



17. The spectrum is measured from 9 KHz to the 10<sup>th</sup> harmonic of the fundamental frequency of the transmitter using CISPR quasi peak detector below 1GHz. The worst case emissions are reported however emissions whose levels were not within 20dB of the respective limits were not reported.
18. For 9KHz to 30MHz: the amplitude of spurious emissions are attenuated by more than 20dB below the permissible value has no need to be reported.



## 2.8.5 Test Results of Radiated Spurious Emissions

**Note: 1. (Absolute)Level=Reading Level + Factor**

Worst-Case test data provide as below:

GSM850 Middle Channel

30MHz~10GHz:

| Suspected List |                |                  |                |                |                |                |            |
|----------------|----------------|------------------|----------------|----------------|----------------|----------------|------------|
| NO.            | Freq.<br>[MHz] | Reading<br>[dBm] | Level<br>[dBm] | Limit<br>[dBm] | Margin<br>[dB] | Factor<br>[dB] | Polarity   |
| 1              | 35.1751        | -86.63           | -61.30         | -13.00         | 48.30          | 25.33          | Horizontal |
| 2              | 61.3738        | -91.75           | -69.98         | -13.00         | 56.98          | 21.77          | Horizontal |
| 3              | 2028.51        | -57.99           | -56.26         | -13.00         | 43.26          | 1.73           | Horizontal |
| 4              | 2848.92        | -56.07           | -49.10         | -13.00         | 36.10          | 6.97           | Horizontal |
| 5              | 3853.42        | -57.61           | -48.39         | -13.00         | 35.39          | 9.22           | Horizontal |
| 6              | 6322.66        | -58.77           | -43.71         | -13.00         | 30.71          | 15.06          | Horizontal |
| Suspected List |                |                  |                |                |                |                |            |
| NO.            | Freq.<br>[MHz] | Reading<br>[dBm] | Level<br>[dBm] | Limit<br>[dBm] | Margin<br>[dB] | Factor<br>[dB] | Polarity   |
| 1              | 35.1751        | -86.65           | -63.25         | -13.00         | 50.25          | 23.40          | Vertical   |
| 2              | 61.3738        | -92.56           | -69.91         | -13.00         | 56.91          | 22.65          | Vertical   |
| 3              | 90.1601        | -96.84           | -71.11         | -13.00         | 58.11          | 25.73          | Vertical   |
| 4              | 1788.39        | -57.23           | -56.44         | -13.00         | 43.44          | 0.79           | Vertical   |
| 5              | 2684.84        | -56.32           | -49.94         | -13.00         | 36.94          | 6.38           | Vertical   |
| 6              | 5034.01        | -58.12           | -44.22         | -13.00         | 31.22          | 13.90          | Vertical   |



Worst-Case test data provide as below:

GSM1900 Middle Channel

30MHz~20GHz:

| Suspected List |             |               |             |             |             |             |            |
|----------------|-------------|---------------|-------------|-------------|-------------|-------------|------------|
| NO.            | Freq. [MHz] | Reading [dBm] | Level [dBm] | Limit [dBm] | Margin [dB] | Factor [dB] | Polarity   |
| 1              | 34.8549     | -89.62        | -67.50      | -13.00      | 54.50       | 22.12       | Horizontal |
| 2              | 51.3614     | -91.31        | -72.69      | -13.00      | 59.69       | 18.62       | Horizontal |
| 3              | 61.0711     | -92.28        | -73.88      | -13.00      | 60.88       | 18.40       | Horizontal |
| 4              | 2877.87     | -56.14        | -48.02      | -13.00      | 35.02       | 8.12        | Horizontal |
| 5              | 7264.26     | -59.30        | -42.49      | -13.00      | 29.49       | 16.81       | Horizontal |
| 6              | 10552.5     | -61.74        | -37.53      | -13.00      | 24.53       | 24.21       | Horizontal |
| Suspected List |             |               |             |             |             |             |            |
| NO.            | Freq. [MHz] | Reading [dBm] | Level [dBm] | Limit [dBm] | Margin [dB] | Factor [dB] | Polarity   |
| 1              | 34.8549     | -89.13        | -68.97      | -13.00      | 55.97       | 20.16       | Vertical   |
| 2              | 61.0711     | -91.21        | -71.96      | -13.00      | 58.96       | 19.25       | Vertical   |
| 3              | 90.2002     | -96.11        | -73.67      | -13.00      | 60.67       | 22.44       | Vertical   |
| 4              | 2693.69     | -57.14        | -48.17      | -13.00      | 35.17       | 8.97        | Vertical   |
| 5              | 5072.07     | -59.65        | -45.63      | -13.00      | 32.63       | 14.02       | Vertical   |
| 6              | 10282.2     | -61.40        | -37.72      | -13.00      | 24.72       | 23.68       | Vertical   |



Worst-Case test data provide as below:

WCDMA 850 Middle Channel

30MHz~10GHz:

| Suspected List |             |               |             |             |             |             |            |
|----------------|-------------|---------------|-------------|-------------|-------------|-------------|------------|
| NO.            | Freq. [MHz] | Reading [dBm] | Level [dBm] | Limit [dBm] | Margin [dB] | Factor [dB] | Polarity   |
| 1              | 34.8549     | -87.88        | -62.48      | -13.00      | 49.48       | 25.40       | Horizontal |
| 2              | 61.0711     | -92.13        | -70.36      | -13.00      | 57.36       | 21.77       | Horizontal |
| 3              | 2035.51     | -56.96        | -55.12      | -13.00      | 42.12       | 1.84        | Horizontal |
| 4              | 2949.97     | -56.84        | -49.12      | -13.00      | 36.12       | 7.72        | Horizontal |
| 5              | 5033.51     | -58.62        | -47.42      | -13.00      | 34.42       | 11.20       | Horizontal |
| 6              | 7217.10     | -59.44        | -42.48      | -13.00      | 29.48       | 16.96       | Horizontal |
| Suspected List |             |               |             |             |             |             |            |
| NO.            | Freq. [MHz] | Reading [dBm] | Level [dBm] | Limit [dBm] | Margin [dB] | Factor [dB] | Polarity   |
| 1              | 34.8549     | -86.73        | -63.29      | -13.00      | 50.29       | 23.44       | Vertical   |
| 2              | 83.4034     | -96.77        | -71.78      | -13.00      | 58.78       | 24.99       | Vertical   |
| 3              | 1763.38     | -54.00        | -53.79      | -13.00      | 40.79       | 0.21        | Vertical   |
| 4              | 3142.57     | -57.95        | -49.47      | -13.00      | 36.47       | 8.48        | Vertical   |
| 5              | 5093.54     | -60.03        | -45.81      | -13.00      | 32.81       | 14.22       | Vertical   |
| 6              | 10331.1     | -61.41        | -37.43      | -13.00      | 24.43       | 23.98       | Vertical   |





Worst-Case test data provide as below:

WCDMA 1900 Middle Channel

30MHz~20GHz:

| Suspected List |             |               |             |             |             |             |            |
|----------------|-------------|---------------|-------------|-------------|-------------|-------------|------------|
| NO.            | Freq. [MHz] | Reading [dBm] | Level [dBm] | Limit [dBm] | Margin [dB] | Factor [dB] | Polarity   |
| 1              | 34.8549     | -89.91        | -67.79      | -13.00      | 54.79       | 22.12       | Horizontal |
| 2              | 51.3614     | -91.54        | -72.92      | -13.00      | 59.92       | 18.62       | Horizontal |
| 3              | 3172.58     | -58.48        | -49.56      | -13.00      | 36.56       | 8.92        | Horizontal |
| 4              | 3900.45     | -58.90        | -49.19      | -13.00      | 36.19       | 9.71        | Horizontal |
| 5              | 5093.54     | -59.75        | -47.66      | -13.00      | 34.66       | 12.09       | Horizontal |
| 6              | 10271.1     | -61.23        | -37.40      | -13.00      | 24.40       | 23.83       | Horizontal |
| Suspected List |             |               |             |             |             |             |            |
| NO.            | Freq. [MHz] | Reading [dBm] | Level [dBm] | Limit [dBm] | Margin [dB] | Factor [dB] | Polarity   |
| 1              | 34.8549     | -89.97        | -69.81      | -13.00      | 56.81       | 20.16       | Vertical   |
| 2              | 51.3614     | -91.07        | -72.70      | -13.00      | 59.70       | 18.37       | Vertical   |
| 3              | 2714.85     | -58.46        | -49.90      | -13.00      | 36.90       | 8.56        | Vertical   |
| 4              | 3967.98     | -57.80        | -48.35      | -13.00      | 35.35       | 9.45        | Vertical   |
| 5              | 5101.05     | -59.30        | -45.05      | -13.00      | 32.05       | 14.25       | Vertical   |
| 6              | 10376.1     | -62.01        | -37.62      | -13.00      | 24.62       | 24.39       | Vertical   |



### 3. LIST OF MEASURING EQUIPMENT

| Description                                  | Manufacturer                              | Model        | Serial No. | Cal. Date  | Due Date   | Remark    |
|--|---|--------------|------------|------------|------------|-----------|
| EMI Test Receiver                            | R&S                                       | ESIB26       | A0304218   | 2019.05.20 | 2020.05.19 | Radiation |
| Loop Antenna                                 | Schwarz beck                              | HFH2-Z2      | 100047     | 2019.04.26 | 2022.04.25 | Radiation |
| Broadband antenna<br>(30MHz~1GHz)            | R&S                                       | HL562        | 101341     | 2017.07.14 | 2020.07.13 | Radiation |
| Broadband antenna<br>(30MHz~1GHz)            | R&S                                       | HL562        | 101339     | 2017.07.14 | 2020.07.13 | Radiation |
| Double ridge horn<br>antenna<br>(1GHz~18GHz) | R&S                                       | HF906        | 100150     | 2019.04.27 | 2022.04.26 | Radiation |
| Double ridge horn<br>antenna<br>(1GHz~18GHz) | R&S                                       | HF906        | 100149     | 2019.04.17 | 2022.04.16 | Radiation |
| Horn antenna<br>(18GHz~26.5GHz)              | AR  | AT4002A      | 305753     | 2017.07.12 | 2020.07.11 | Radiation |
| Horn antenna<br>(18GHz~26.5GHz)              | AR  | AT4003A      | 0329293    | 2018.09.17 | 2020.09.16 | Radiation |
| Amplifier<br>1GHz-18GHz                      | AR  | 25S1G4AM1    | 22018      | 2018.09.17 | 2020.09.16 | Radiation |
| Amplifier<br>20M~3GHz                        | MILMEGA                                   | 80RF1000-250 | 1064573    | 2017.10.09 | 2020.10.08 | Radiation |
| Spectrum Analyzer                            | KEYSIGHT                                  | N9030A       | A160702554 | 2019.06.05 | 2020.06.04 | Conducted |
| LISN   | ROHDE&SC<br>HWARZ                         | ESH2-Z5      | A0304221   | 2019.04.30 | 2020.04.29 | Conducted |
| Test Receiver                                | R&S                                       | ESCS30       | A0304260   | 2019.05.25 | 2020.05.24 | Conducted |
| Temperature<br>chamber                       | Dongguan<br>gaoda<br>instrument<br>CO.LTD | GD-7005-100  | 130130101  | 2019.04.22 | 2020.04.21 | Conducted |
| Wideband Radio<br>Communication<br>tester    | R&S                                       | CMW500       | 149332     | 2019.04.01 | 2020.03.31 | Conducted |
| Power Supply                                 | R&S                                       | NGMO1        | 101037     | 2019.08.03 | 2020.08.02 | Conducted |

\*\* END OF REPORT \*\*