

1、 Main Antenna

● Technical Parameters

Antenna model: 2G/3G/4G

Manufacturer: Sunnyway Technology (Shenzhen) Co.,Ltd.

Antenna type: PIFA

Frequency Range: 700MHz~2690MHz

Voltage standing wave ratio: $\leq 26.8: 1$

● S11

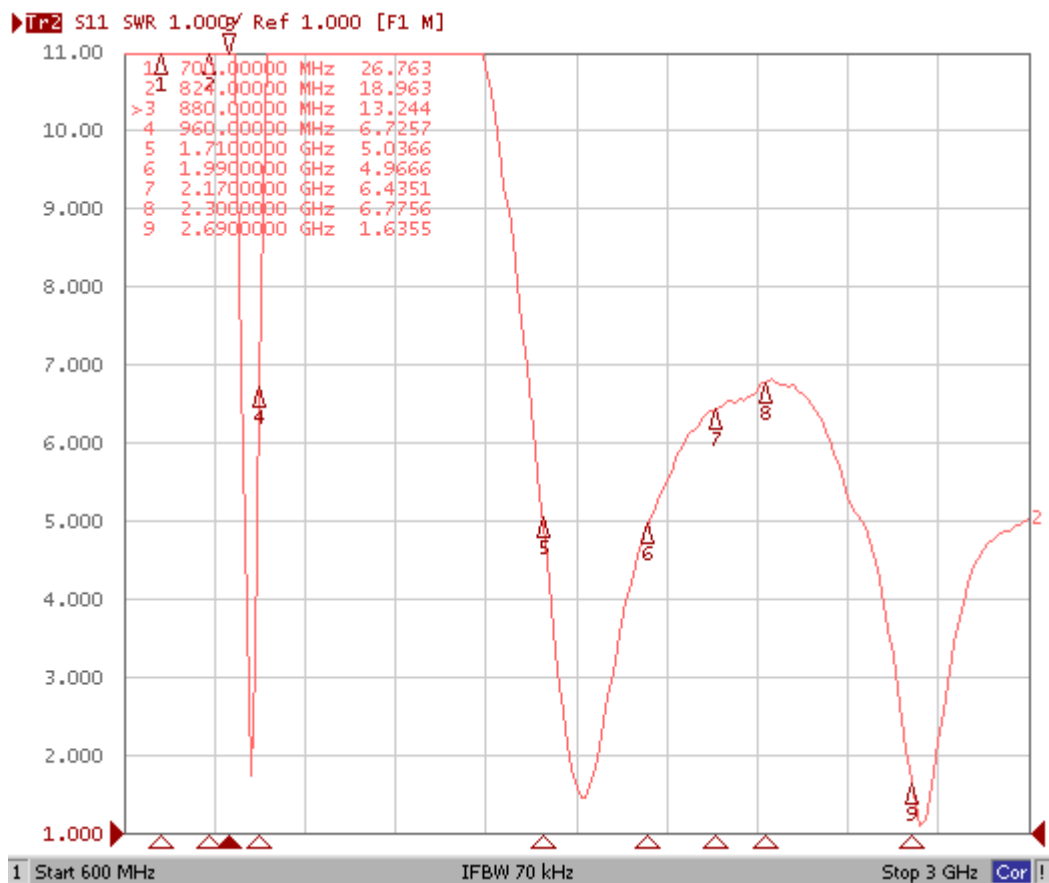

● Antenna efficiency and Gain

Frequency/Mhz	MaxGain/dBi	Efficiency / %
700	-0.4	15.07
710	-0.36	15.49
720	-0.87	14.83
730	-1.62	14.42
740	-1.4	15.89
750	-1.25	16.6
760	-1.05	17.38
770	-1.1	18.49
780	-0.84	19.05
790	-0.39	19.95
800	-2.04	19.28
810	-1.7	19.45
820	-2.06	18.84
830	-1.78	20
840	-1.62	21.09
850	-1.5	21.53
860	-1.1	23.33
870	-0.61	26.18
880	-0.43	27.48
890	-0.34	27.48
900	-0.41	28.38
910	-0.26	29.04
920	-0.65	26.98
930	-1	23.93
940	-1.44	21.78
950	-2.17	18.62
960	-2.92	15.78
1710	1.93	37.58
1730	1.94	36.64
1750	2.12	38.19
1770	1.59	37.76
1790	0.73	33.96
1810	1.4	34.36
1830	1.98	30.76
1850	2.63	31.55
1870	1.64	26.85
1890	1.33	33.94
1910	1.96	33.94

Frequency/Mhz	MaxGain/dBi	Efficiency / %
1930	1.87	33.47
1950	1.5	33.64
1970	1.45	34.3
1990	1.47	33.12
2010	1.61	33
2030	1.42	31.93
2050	1.59	32.49
2070	1.28	31.6
2090	1.26	31.71
2110	0.68	28.75
2130	0.43	28.75
2150	-0.85	25.86
2170	-1.69	24.48
2190	-2.53	23.42
2210	-2.93	23.38
2230	-2.6	23.74
2250	-2.43	24.79
2270	-2.62	25.42
2310	-2.36	25.62
2330	-2.12	25.95
2350	-1.6	26.54
2370	-1.01	27.1
2390	-0.9	26.28
2410	-0.75	26.24
2430	-0.52	26.66
2450	-0.18	27.5
2470	0.07	27.59
2490	0.22	27.77
2510	-0.02	27.36
2530	-0.11	26.62
2550	0.2	27.54
2570	0.28	26.92
2590	0.6	27.68
2610	0.2	26.88
2630	0.27	28.37
2650	0.47	29.38
2670	1.03	31.5
2690	1.48	32.15

● Direction map

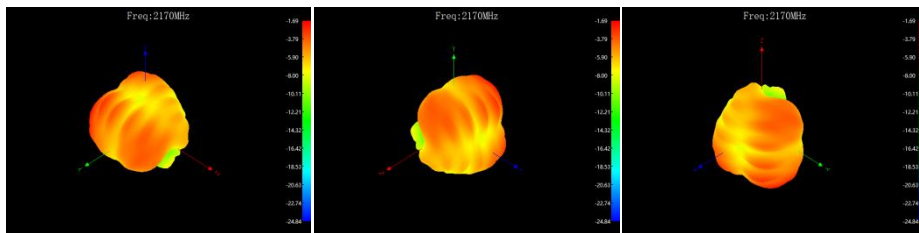
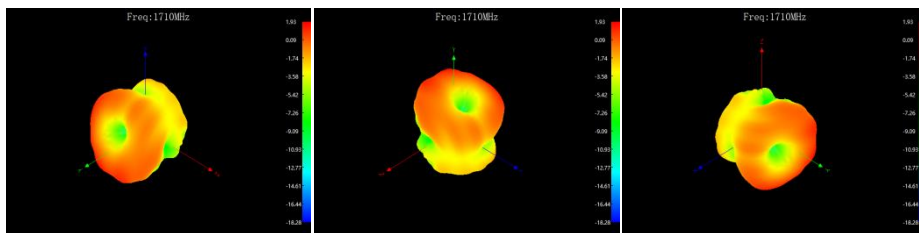
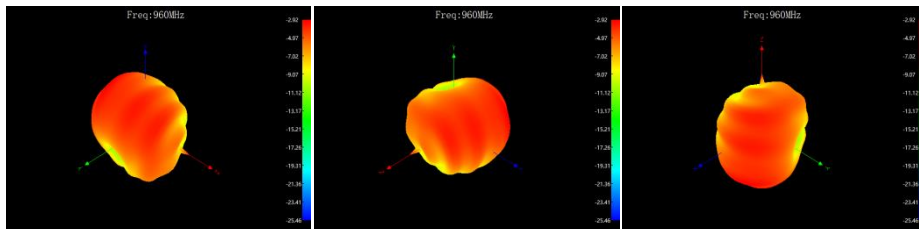
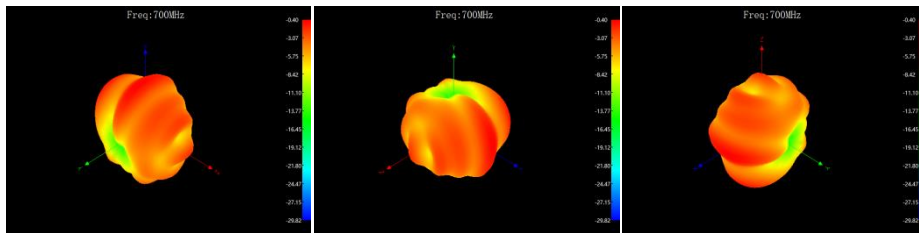
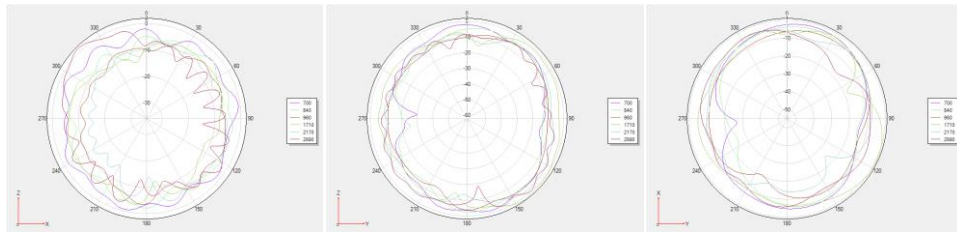

DEV-QR-06

客户料号: 3.01.42.00683

版本	修改内容	修改人	日期

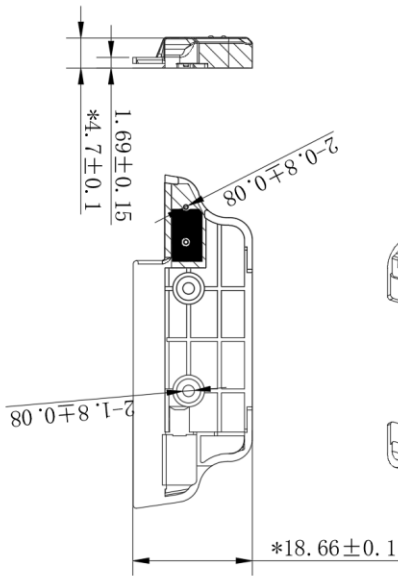
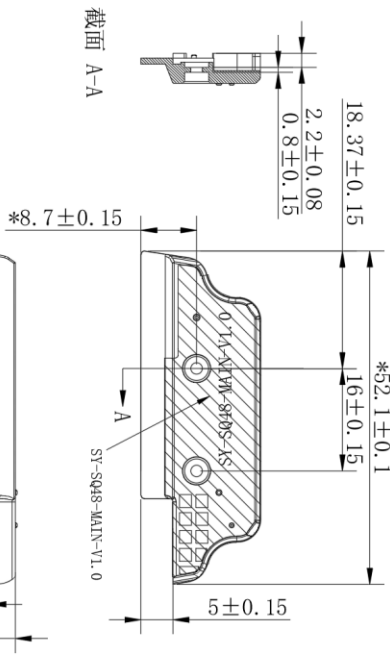
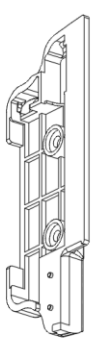
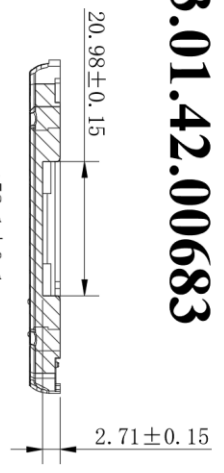

BOM 明細表

部件序号	部件品名/规格	材料	外觀	用量
2	主天线支架	ABS+PC	黑色	1
3	MAIN天线	FPC	黑色	1
1				

尚远科技(中国)有限公司

PART NAME: 主天线支架组件 (SQ48)		DATE: 2023-08-28	
PART NO: S2226541B73-1		DRAWN: 徐伟	
MATERIAL: ABS+PC LG GNS001RFG		CHECKED: 陈敏	
FINISHING:		APPROVED:	
TOLERANCE X X ±0.25 .XX ±0.20 .XXX±0.05		UNIT: mm	
ANGULAR: ±0.5°		SCALE: 1:1	
COLOUR: 黑色		TEST: T:A	

● Structure size:

2、DIV Antenna

● Technical Parameters

Antenna model: 2G/3G/4G

Manufacturer: Sunnyway Technology (Shenzhen) Co.,Ltd.

Antenna type: monopole

Frequency Range: 700MHz~2690MHz

voltage standing wave ratio: $\leq 12: 1$

● S11

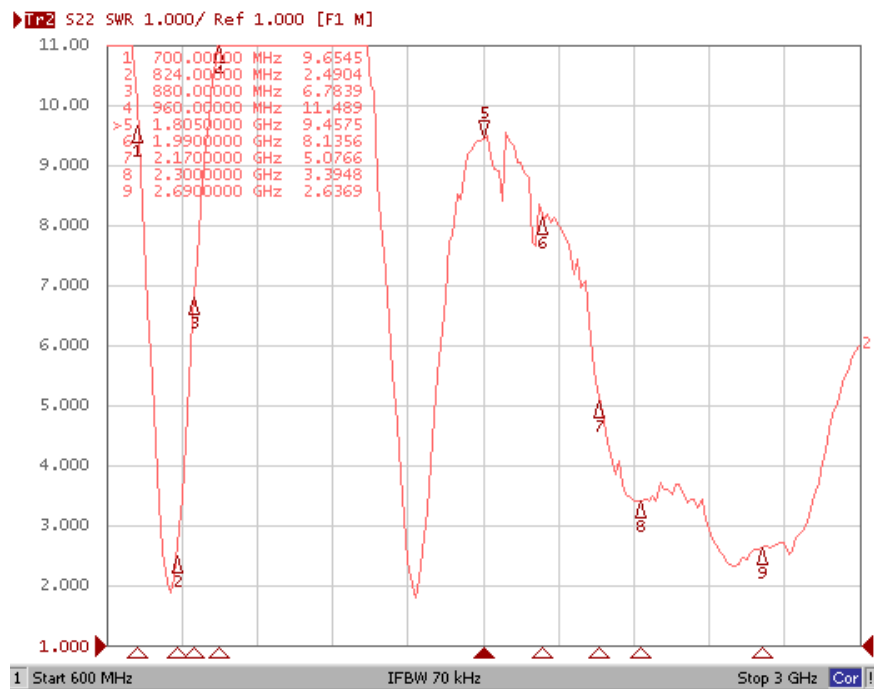

● Antenna efficiency and Gain

Frequency/Mhz	MaxGain/dBi	Efficiency / %	Frequency/Mhz	MaxGain/dBi	Efficiency / %
720	-7.01	9.52	2130	-5.15	17.31
740	-5.47	12.16	2150	-4.57	19.12
760	-3.58	16.94	2170	-3.45	17.96
780	-2.34	17.86	2190	-2.41	21.06
800	-2.99	20.75	2210	-1.51	21.09
820	-3.68	17.82	2230	-0.98	23.01
840	-4.65	15.12	2250	-0.61	25.94
860	-6.39	14.67	2270	-0.31	28.31
880	-8.26	11.89	2290	-0.07	28.58
900	-9.94	10.22	2310	0.16	28.44
920	-11.53	7.03	2330	0.26	29.04
940	-12.36	6.26	2350	0.13	28.51
960	-12.9	5.86	2370	0.77	30.27
1810	-10.69	9	2390	0.79	30.06
1830	-10.38	8.8	2410	0.78	28.97
1850	-9.97	8.97	2430	0.68	28.12
1870	-10.77	8.7	2450	1.25	31.41
1890	-10.34	8.86	2470	0.93	30.06
1910	-9.95	9.13	2490	1.06	30.34
1930	-9.82	9.28	2510	1.45	32.43
1950	-9.55	11.61	2530	1.89	33.04
1970	-8.87	12.04	2550	2.45	35.56
1990	-8.82	12.16	2570	2.35	34.83
2010	-8.63	12.42	2590	2.6	35.89
2030	-8.24	12.6	2610	2.66	33.65
2050	-7.98	12.98	2630	3.02	34.75
2070	-8.3	13.35	2650	2.88	32.51
2090	-7.25	14.46	2670	2.89	31.33
2110	-6.32	15.06	2690	2.9	29.99

● Directional map

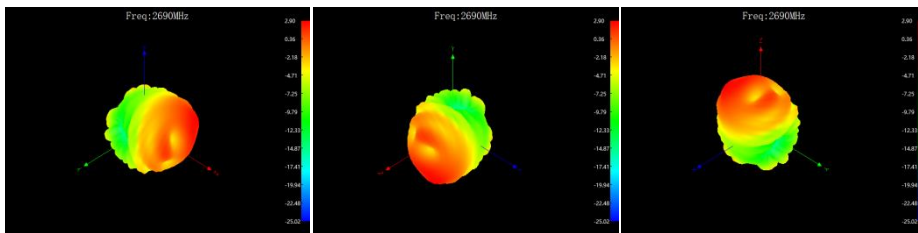
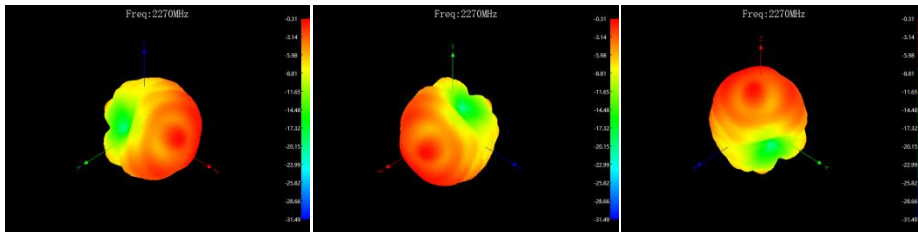
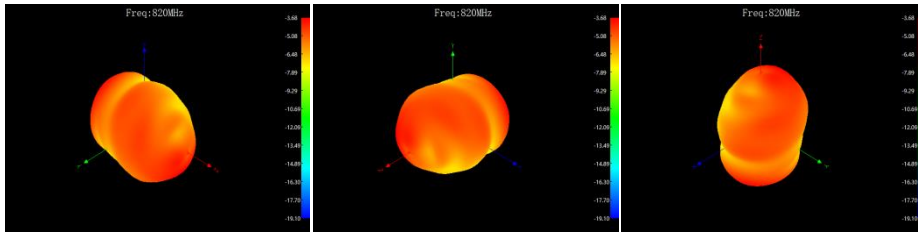
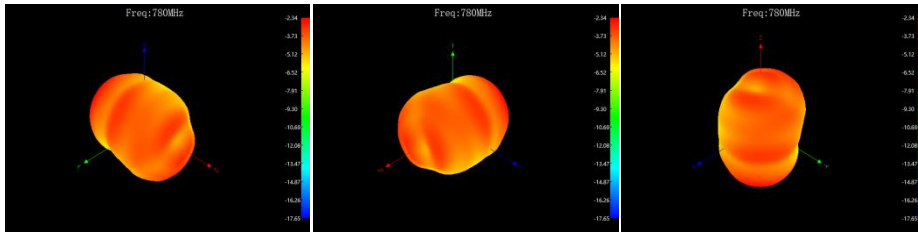
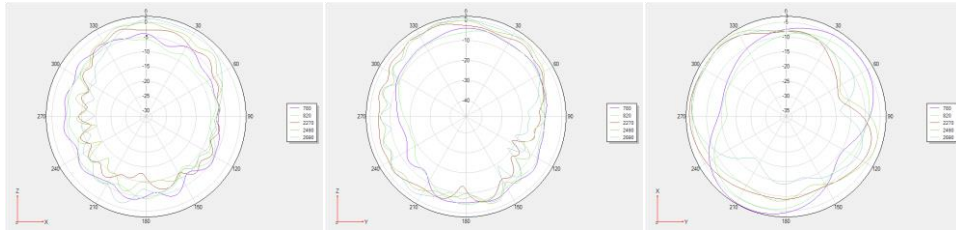

● Structure size

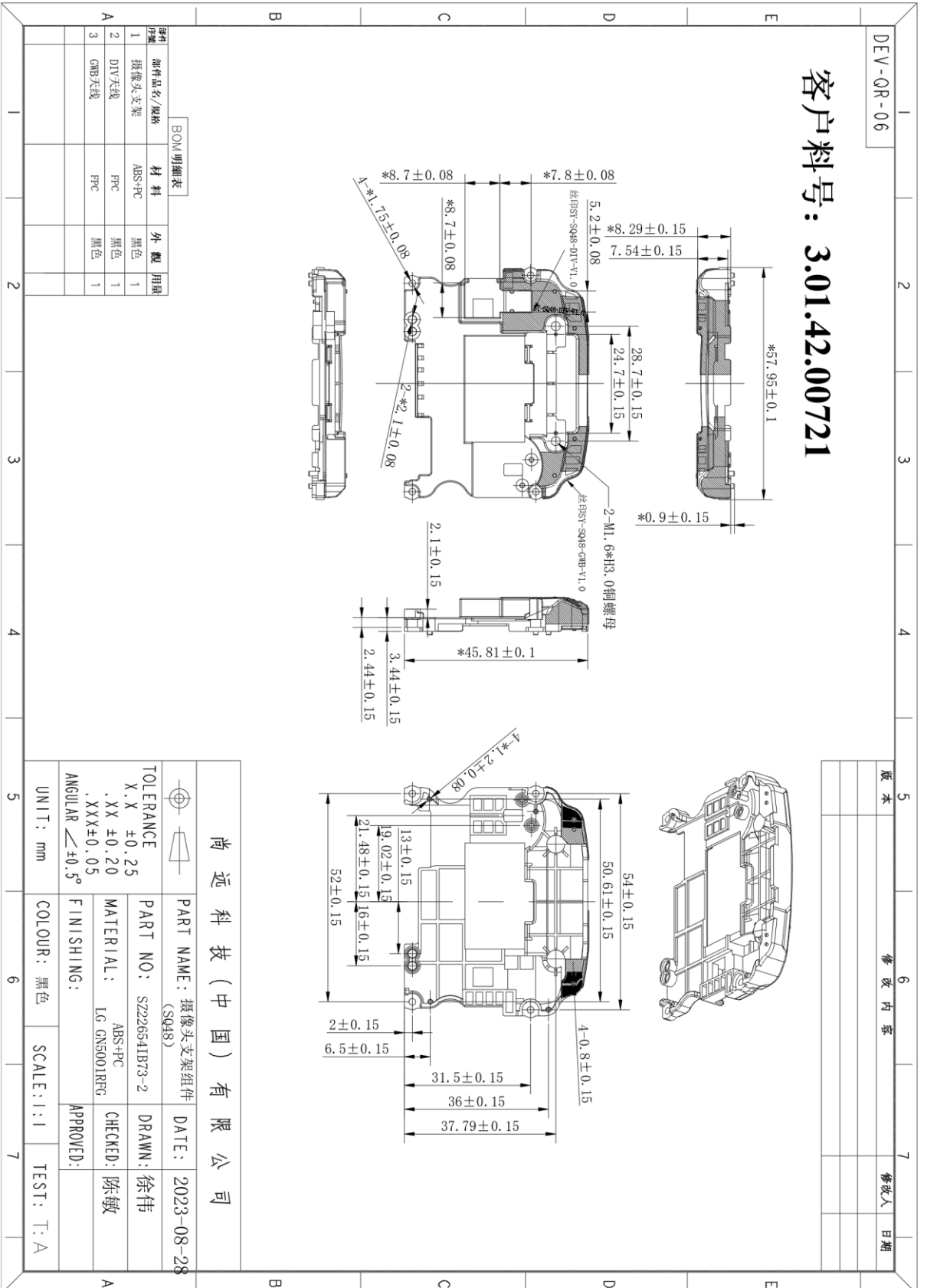

3、GPS&WIFI&BT Antenna

- Technical Parameters

Antenna model: GPS&WIFI&BT

Manufacturer: Sunnyway Technology (Shenzhen) Co.,Ltd.

Antenna type: PIFA

Frequency Range : 1575MHz , 2400MHz~2500MHz ,
5150MHz~5850MHz

Voltage standing wave ratio: $\leq 7.0: 1$

- S11

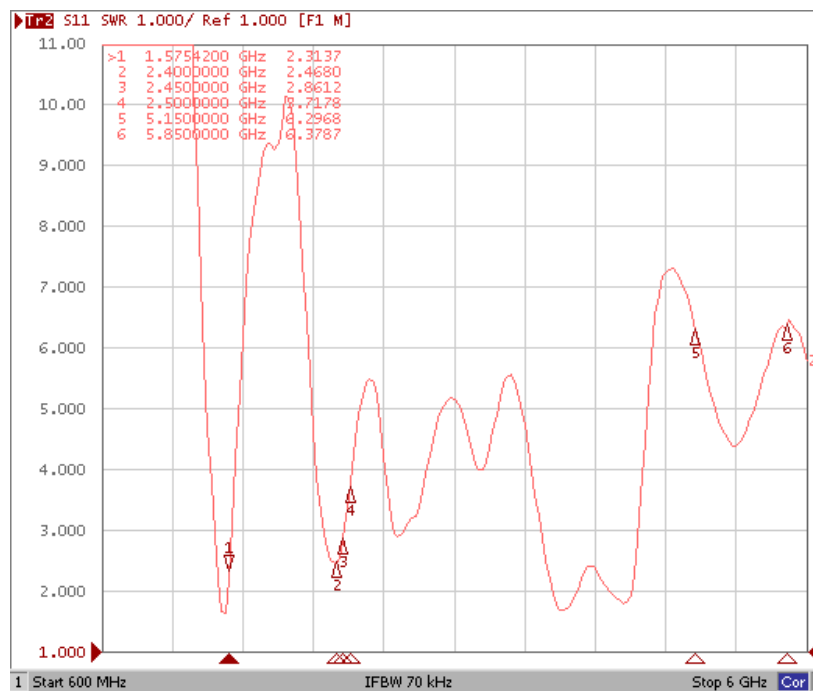

● Antenna efficiency and Gain

Frequency/Mhz	MaxGain/dBi	Efficiency / %	Frequency/Mhz	MaxGain/dBi	Efficiency / %
1571	1.22	31.7	5150	3.9	35.89
1573	1.15	31.26	5170	3.91	34.75
1575	1.04	30.9	5190	3.92	34.28
1577	0.92	29.99	5210	3.75	33.19
1579	0.89	29.92	5230	3.61	33.04
2400	2.25	41.88	5250	3.47	32.36
2410	2.07	40.46	5270	3.43	31.92
2420	2.09	39.99	5290	3.25	30.97
2430	1.96	38.99	5310	3.11	30.69
2440	1.98	38.55	5330	3.02	30.06
2450	1.88	37.76	5350	2.92	29.65
2460	1.88	37.24	5370	2.72	28.25
2470	1.67	35.56	5390	2.77	28.71
2480	1.62	34.51	5410	2.65	28.25
2490	1.6	33.04	5430	2.48	27.73
2500	1.55	31.41	5450	2.45	27.29
			5470	2.44	26.98
			5490	2.32	26.42
			5510	2.24	25.7
			5530	2.21	25.29
			5550	2.12	24.6
			5570	2.14	24.27
			5590	2.21	24.43
			5610	2.15	24.21
			5630	2.13	24.27
			5650	2.18	24.89
			5670	2.05	23.99
			5690	1.97	23.71
			5710	2.03	24.15
			5730	1.95	24.04
			5750	1.96	24.1
			5770	2.02	24.43
			5790	2.09	24.83
			5810	2.12	25.23
			5830	2.22	26
			5850	2.27	26.79

● Direction map

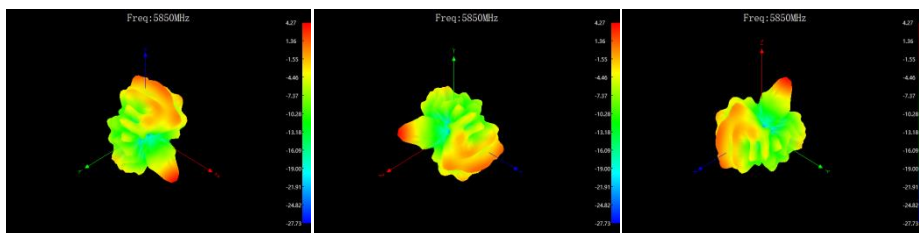
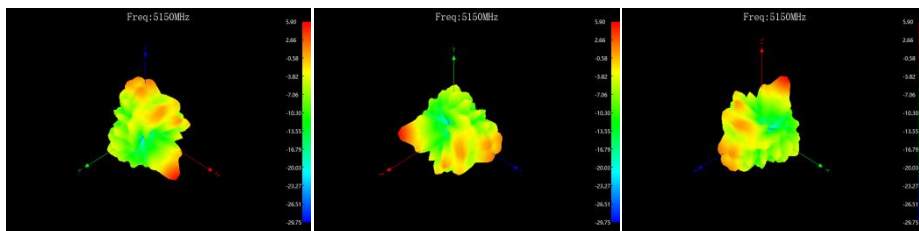
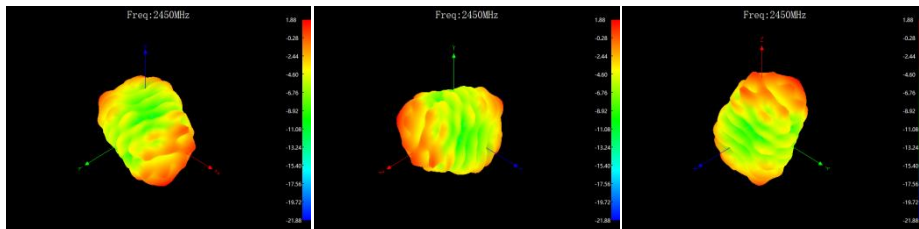
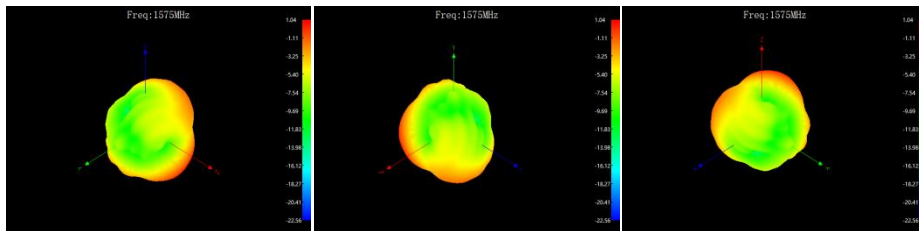
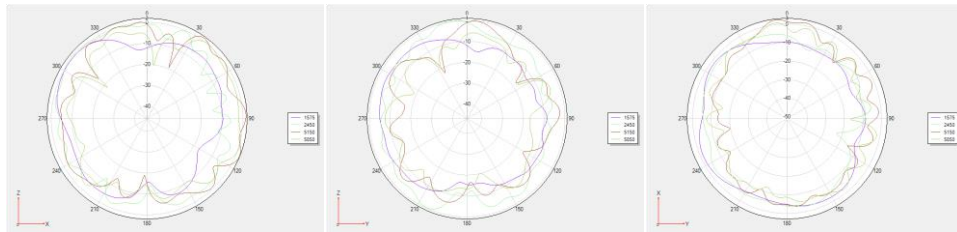

● Structure size

