

EDGE RT

EXPANDABLE TO 3-DOG SYSTEM

Owner's Manual

Please read this manual thoroughly
before operating the EDGE RT training e-collar.

IMPORTANT SAFETY AND PRODUCT INFORMATION

WARNING

Please read all safety and product information below before using your Dogtra product. Failure to follow these safety instructions could result in injury to you, your dog and others, or it could result in damage to your Dogtra product or other property.

PRODUCT SAFETY

Training Methods

Dogtra products may be used with a variety of training methods. However, each dog may have a different reaction to training methods and to Dogtra products. Closely observe your dog when determining the right training method to use with your Dogtra product.

Aggressive Dogs

Do not use Dogtra products with aggressive dogs as such dogs may react adversely and cause injury to people or other dogs. Seek the assistance of a dog-training specialist or veterinarian when dealing with aggressive dogs.

Children

Dogtra products are not toys. Adult supervision and close attention are necessary when Dogtra products are used by or near children.

PRODUCT DAMAGE

Electrical Product

Your Dogtra product contains electrical components and batteries. Do not use or keep your product near heat or flammable sources. Such use or storage may damage your

product and/or cause fire, explosion, injury, or property damage.

Medical Device Interference

Dogtra products contain electrical and magnetic components that emit low level electromagnetic waves and radio frequencies. These electromagnetic waves or radio frequencies may interfere with pacemakers, defibrillators, or other medical devices. Consult your physician or medical device maker before using your medical device with a Dogtra product. If you think that your Dogtra product is interfering with your pacemaker, defibrillator, or other medical device, stop using the Dogtra product.

Inadvertent Activation

The digital microprocessor offers thousands of unique codes to eliminate frequency match-up with other Dogtra e-collars. The Constant button will automatically shut down after being held down for 12 seconds or more as a safety feature.

UNAUTHORIZED USE

Your Dogtra product should be used only in a humane manner to train and educate your dog. Dogtra products are not intended for use in any other manner nor are they intended for use with other animals or with humans.

BATTERY

Your Dogtra product contains batteries. Take care when removing and installing batteries as your fingers may get caught. Dispose of batteries as provided by your local regulations. Do not disassemble, crush, heat, or otherwise alter the battery as it may cause fire, injury or property damage.

CONTENTS

AT A GLANCE	5
MAIN FEATURES	6
OVERVIEW	7
UNDERSTANDING YOUR TRAINING SYSTEM	
1. TURNING THE EDGE RT ON/OFF	9
2. TRANSMITTER BUTTON FUNCTION	10
3. USING THE DOG SELECTOR DIAL	12
4. RECEIVER FITTING	12
5. FINDING THE RIGHT STIMULATION	13
6. MAXIMIZING THE DISTANCE	14
7. LED INDICATOR	15
8. CHARGING THE BATTERY	16
9. CHANGING THE CONTACT POINT LENGTH	17
10. CODE SETTING	19
11. ATTACHING THE BELT CLIP	20
12. USING THE TEST LIGHT	21
GENERAL TRAINING TIPS	22
MAINTENANCE	24
TROUBLESHOOTING GUIDE	25
WARRANTY AND REPAIR INFORMATION	27

AT A GLANCE

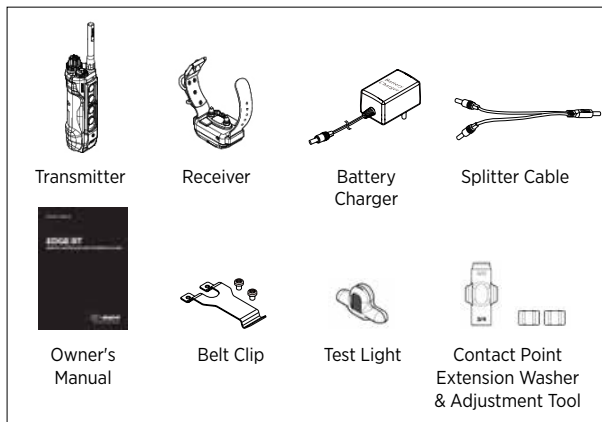

Optional Accessories

Auto Charger

The auto charger for the EDGE RT has an input of 12-volts to 24-volts and has an output of 10-volts 1500mAh.

European Charger

Dogtra's European chargers are designed for use with a 220 volt AC electrical outlet.

To purchase accessories, please visit www.dogtra.com or call customer service at (888) 811-9111.

MAIN FEATURES

- Selector Dial for stimulation levels 1-8
- 1-mile range
- 2 different stimulation types - Nick & Constant
- Pager vibration feature
- Stimulation/Combination buttons
- Expandable to a 3-dog system
- IPX9K waterproof certified
- Enhanced contact points
- Belt clip
- 2-hour rapid charge batteries
- High stimulation output
- For dogs as small as 35 lbs.

OVERVIEW

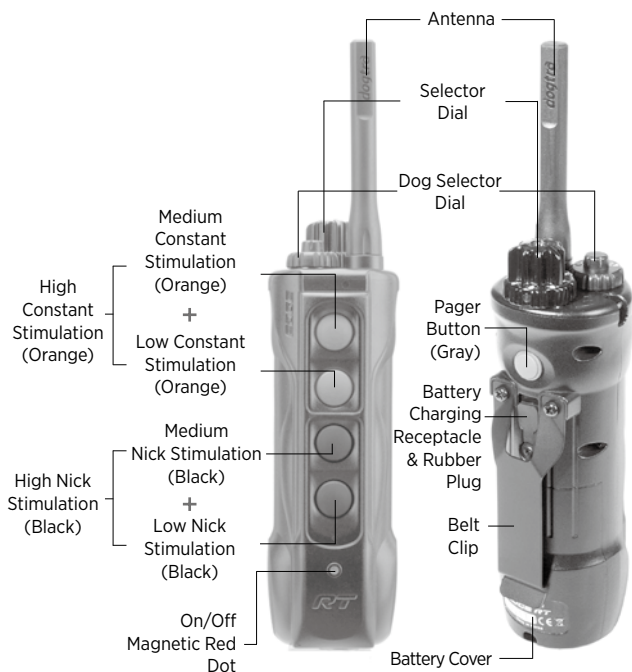

EDGE RT Transmitter

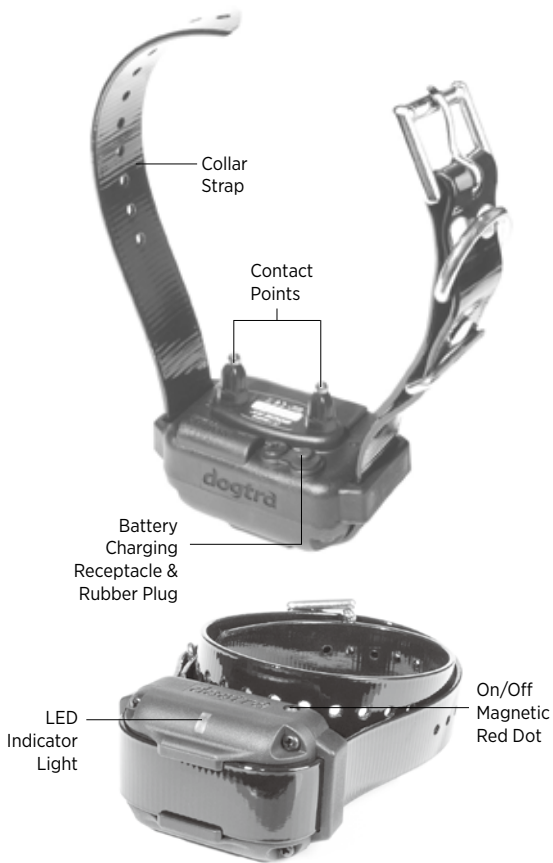

EDGE RT Receiver

UNDERSTANDING YOUR SYSTEM

1. Turning the EDGE RT On/Off

To turn the receiver on, place the red dot on the back of the handheld transmitter to the red dot on the receiver. Hold the two red dots together for a moment until the LED light on the receiver comes on.

To turn the receiver off, repeat the same procedure holding the two red dots together momentarily. The LED light will turn red for a brief moment indicating that the receiver is now off.

The transmitter does not have an on/off button and it will only activate when the buttons are pressed.

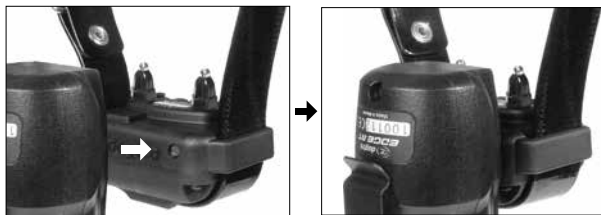

2. Transmitter Button Function

The handheld transmitter uses 4 buttons to send stimulation. The LED indicator will blink on both the handheld transmitter and the receiver when the stimulation buttons are pressed.

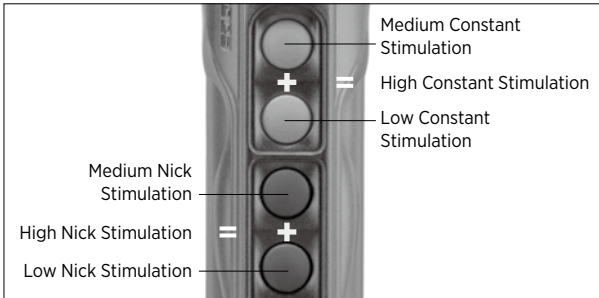

1) Constant Stimulation

The two orange buttons on the front of the transmitter control 3 levels of Constant stimulation. Pressing the Constant button gives continuous stimulation as long as the button is pressed, for up to 12 seconds. If the button is not released after 12 seconds, the stimulation will automatically turn off as a safety feature. The receiver will be ready to be reactivated once the button has been released.

- **Low Constant Stimulation:** Press the lower orange button for a low power Constant stimulation.
- **Medium Constant Stimulation:** Press the top orange button for a medium power Constant stimulation.
- **High Constant Stimulation:** Press both orange buttons together for a high power Constant stimulation.

2) Nick Stimulation

The two black buttons on the front of the transmitter control 3 levels of Nick stimulation. When the Nick button is pressed, the receiver emits a single rapid pulse of electrical stimulation.

- **Low Nick Stimulation:** Press the lower black button for a low power Nick stimulation.
- **Medium Nick Stimulation:** Press the top black button for a medium power Nick stimulation.
- **High Nick Stimulation:** Press both black buttons together for a high power Nick stimulation.

3) Pager Button

The Pager button is located on the back of the transmitter. Pressing it will give a vibration for as long as the button is pressed, for up to 12 seconds.



3. Using the Dog Selector Dial

The EDGE RT is expandable to a 3-dog system.



Change the dial to select the number of the receiver that you would like to control from the transmitter.

4. Receiver Fitting

Proper Fit

The receiver should be fitted so that the medical grade stainless steel contact points press firmly against the dog's skin. You should be able to fit two fingers underneath the collar strap. The best location is on either side of the dog's windpipe.

Improper Fit

A loose fit can allow the receiver to move around on the dog's neck. When this happens, the contact points may rub against the skin and cause irritation. If the receiver is too loose, the contact will not be consistent and cause the corrections to be inconsistent. Dogtra uses medical grade stainless steel contact points and anti-microbial plastic to protect the dog's skin.

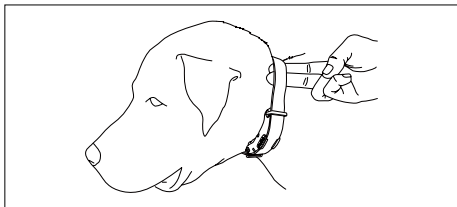

Attention!

Leaving the receiver in the same location on the dog's neck for an extended period of time can cause skin irritation due to the sensitivity from the contact points. If the dog is to wear the receiver for long periods, occasionally reposition the receiver every few hours so that the contact points are moved to a different location on the dog's neck and remove the receiver after 8 hours of usage. Make sure you check for skin irritation each time you use the unit.

5. Finding the Right Stimulation

The EDGE RT has a Selector Dial on the top of the transmitter (1 is the lowest and 8 is the highest). Remember that you will need to adjust the setting (upward or downward) depending on your dog's temperament and threshold for stimulation. Always start at the lowest level and work your way up. The appropriate level can be found when the dog responds to the stimulation with a mild reaction. Also, as the dog's attitude changes, especially during times of increased excitement or distraction, you may need to adjust the intensity level.

NOTE: The stimulation intensity can be adjusted even while the stimulation is in use.

6. Maximizing the Distance

Depending on the way you use your transmitter, the transmitter range may vary.

To get the greatest range, hold the transmitter away from your body and avoid touching the antenna. Keep your unit properly charged for maximum signal strength.

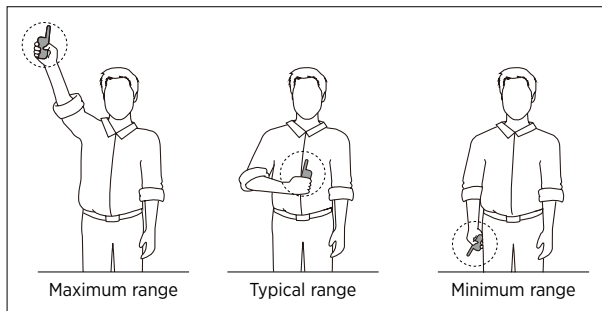

7. LED Indicator

The LED indicator flashes every 4 seconds when the receiver is on and ready for use. The LED indicator will blink on both the transmitter and the receiver when the transmitter buttons are pressed.

The LED indicator color indicates the battery life level.

Green = Full charge

Amber = Medium charge

Red = Needs charge

If the unit is used while the LED indicator is red, it may shut down automatically.



8. Charging the Battery

The Dogtra EDGE RT uses a lithium polymer battery. Recharge the unit if the indicator light is red or does not come on, or if the system will not stay on when any button is pressed.

NOTE 1: Only use Dogtra-approved batteries, chargers, and accessories for your Dogtra e-collars. This will prevent any damage that can be incurred from attempting to use a different charger.

NOTE 2: The unit has a partial charge when it leaves the Dogtra facility. Upon receipt of the system, be sure to give it a full 2-hour initial charge before the first use away from any flammable substances.

NOTE 3: When a charger is not in use, disconnect it from the power source. Fully charge the batteries if the unit is to be stored without use for a period of 3 months or more.



Follow the steps below to charge your system:

1. Open the rubber plugs on the battery charging receptacles and plug in the charging cable.
2. Plug the charger into a 120-volt wall outlet or, if using the auto charger, plug into a cigarette lighter only for lithium polymer batteries (use a 220 volt European charger for Europe). All indicator lights should glow red when properly plugged in and the unit will automatically shut off during the charging process. You will need to turn the unit on again before use once the unit is fully charged and unplugged from the battery cable.
3. The lithium polymer battery is fully charged within 2 hours. The lights will stay red during the charging process and turn green once the unit is fully charged.
4. After charging, cover the battery charging receptacles with the rubber plugs.

9. Changing the Contact Point Length

The Dogtra EDGE RT comes equipped with standard 5/8" contact points that can be extended to 3/4" contact points to use on dogs with longer coats.

To increase the contact point length from 5/8" to 3/4", follow the steps below.

1. Using the included adjustment tool with the side marked 5/8", unscrew the contact points counter-clockwise.
2. Place the contact point extension over the exposed threads, flat side down.
3. Place the contact points over the extensions and tighten the contact points and extensions clockwise using the adjustment tool with the side marked 3/4".

* **Caution:** Tighten until firmly in place. Be careful not to over tighten.

To shorten the contact points back to the standard 5/8", start with the adjustment tool with the side marked 3/4", remove the contact point extensions, and tighten the contact points with the adjustment tool with the side marked 5/8".

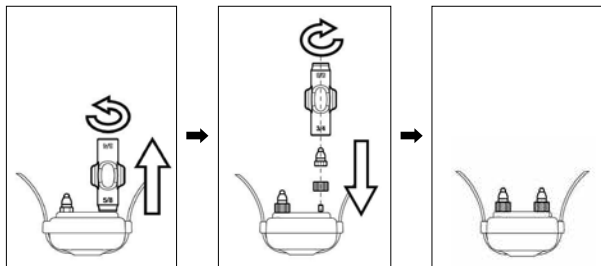

10. Code Setting

Follow the steps below to code an EDGE RT transmitter to a new or existing receiver.



1. Set the Selector Dial to level 1 and set the Dog Selector Dial to the number you want to code the receiver to.



2. With the receiver turned off, place the red dot on the back of the transmitter to the red dot on the receiver. Hold the two red dots together for about 5 seconds until the green LED blinks rapidly on the receiver.



3. While the green LED is rapidly blinking on the receiver, separate the two devices and press the top orange button on the front of the transmitter and the Pager button on the back of the transmitter simultaneously. The LED light on the receiver will blink every 4 seconds when coding is complete.

11. Attaching the Belt Clip

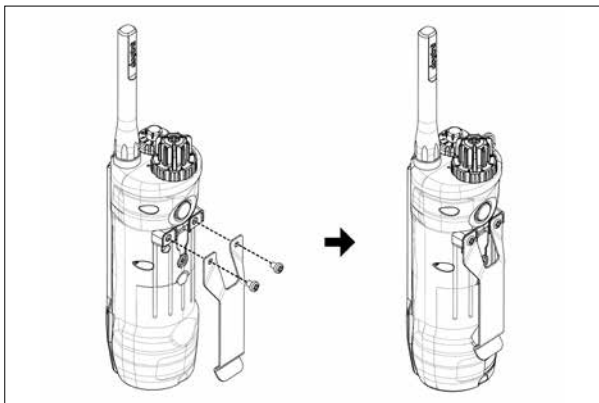

Follow the instructions below to attach the included belt clip to the transmitter.

1. Align the belt clip to the grooves on the back of the transmitter.
2. With a firm grip, screw on the belt clip's Phillips head screws with a screwdriver.

Caution!

Tighten until firmly in place. Be careful not to over tighten.

12. Using the Test Light

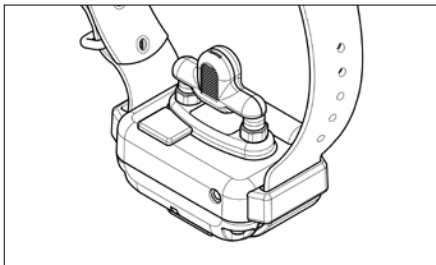

1. Turn on the receiver by placing the red dot on the back of the transmitter to the red dot on the receiver.
2. Place the test light, included in the package contents, on the contact points as shown in the diagram.
3. Watch the test light as you press the Nick button on the transmitter. It should light up for just a moment. The higher the intensity level, the brighter the test light will be.
4. Watch the test light as you press the Constant button on the transmitter. It should light up as long as the button is pressed. However, as a safety feature, the receiver will automatically stop the stimulation if the Constant button is pressed for 12 seconds or longer.
5. Turn the Selector Dial on the transmitter clockwise and then counterclockwise. The test light should glow brighter with higher levels of stimulation and dimmer with lower levels.

NOTE: The test light may not be visible if the intensity level is too low.

GENERAL TRAINING TIPS

Your dog must know some basic obedience commands before beginning training with the EDGE RT. A dog learns by first being shown a command, followed by lots of repetition over an extended period. As the dog becomes proficient at these commands, the trainer can introduce distractions and different locations to strengthen them.

Obedience Training on the Leash

Your dog must fully understand the obedience commands (sit, stay, here, heel, and kennel) before using the e-collar for reinforcement of these commands. A leash attached to a standard collar is used to "teach" the dog the basic obedience commands (here, heel, sit, and stay). A tug on the leash/collar is used to reinforce the command. When the dog complies with the command, use positive reinforcement/praise. Once the dog understands these commands, the e-collar can be used to reinforce them.

Beginning E-Collar Training

When you feel your dog understands the obedience commands on the leash we can now start with the e-collar training. With the dog on the leash and wearing the e-collar, continue with your obedience drills. Apply light stimulation (Nick or Constant) when a command is given; the stimulation can be removed as the dog complies. Through repetition, the dog learns to perform the command.

The final step is the avoidance phase in which the dog learns that he can avoid the stimulation altogether by performing your commands. When these training procedures are complete, the e-collar is used as a reminder when the dog does not comply with your commands at home or in the field. Keep your initial training sessions short and positive as dogs have a short attention span.

How Much Stimulation to Use

Always start with low levels of stimulation and work your way up depending on the disposition of your dog and the given situation. By using the correct amount of stimulation to get your point across, you will have a more controllable environment and a dog that is under less stress. Animals (and humans) perform better in a less stressful environment.

For more training information, please visit our website at www.dogtra.com.

MAINTENANCE

Basic maintenance

Make sure the rubber-charging cap is securely in place when the e-collar is in use. After each training session, carefully inspect the unit for any missing parts or damage to the casing. Damaged or broken casing may affect the waterproof guarantee on the unit. After confirming that there is no damage to the casing, rinse the receiver and clean out any dirt or debris.

Storage maintenance

The EDGE RT should be fully charged before storing for extended periods. While in storage, the unit should be given a full charge once a month and before the first use. Store the units in room temperature. Do not keep the units exposed to extreme climates.

Troubleshooting

If the unit is malfunctioning, please refer to the “Troubleshooting Guide” before sending it to Dogtra for service. If you have any questions or concerns, you may email them to info@dogtra.com, or call customer service at (888) 811-9111.

TROUBLESHOOTING GUIDE

1. My dog is not reacting to the system.

- Make sure the receiver and transmitter are on.
- Make sure the collar strap is tight enough so both contact points are touching the dog's skin.
- The contact points may be too short for the dog. To place an order for longer contact points that are more appropriate for your dog, please call (888) 811-9111. If you are already using the longest contact points available, you might need to trim down the hair on the dog's neck so both contact points are touching the dog's skin.
- The intensity level may be too low for your dog. Keep increasing the stimulation until the dog responds, usually with neck movement, head shaking, looking over its shoulder, etc. (response may be very subtle).

2. The LED indicator light comes on, but I do not feel any stimulation.

- Testing the system at various levels using the test light is the best way to test your system. Your tolerance may be higher than the level you are testing yourself.
- The battery may be low, so check the LED light for battery life.

3. The transmitter has no range or stimulation is less when the dog is farther away.

- The antenna(s) may be damaged. To order parts, please contact customer service at (888) 811-9111 or go to www.dogtra.com.
- The range indicated on the unit's box is for flat terrain. Heavy brush, trees, hills, or moisture will affect the

range of your unit. For best range, hold the transmitter vertically above your head, and/or try moving to higher ground.

- Any electrical conductors will affect the range, such as cars, chain-link dog runs, metal structures, and radio towers. For best results, operate away from these items.

4. My unit is not holding a charge.

- The batteries might not be charged properly, or the charger, splitter, and the charging port may not be functioning properly. You can send in your charging units to have us inspect them.
- The charging pin may be damaged. Inside the charging port, there is a metal pin that should be standing straight up and stiff. If the pin is wobbling, broken, or missing, you will need to send the unit in to the Repair Department. The charging port must be clean prior to charging; clean the dirt out with a cotton swab and some rubbing alcohol. If the dog is in salt-water, be sure to rinse the receiver and charging port with clean water.
- If the above does not resolve your issues, contact Dogtra customer service at info@dogtra.com or (888) 811-9111.

DOGTRA EXTENDED PRODUCT WARRANTY

EXTENDED LIMITED WARRANTY

For Certain Dogtra Products Purchased from Dogtra Authorized Dealers

1+1 Year Extended Warranty

Except as otherwise provided, Dogtra warrants to the original retail purchaser (“You”) that your Dogtra product shall be free of defects in materials and workmanship for a period of one (1) year from the date of purchase (“Original Warranty”). As a special promotion, Dogtra further warrants that your Dogtra product shall be free of defects in materials and workmanship for an additional one (1) year from the date that your original warranty expires (“Extended Warranty”). The Original and Extended Warranties cover the cost of repair (parts and labor) or replacement (if repair is not feasible) of a defective Dogtra product during said warranty periods. For such repaired or replaced products, the remaining portion of the warranty periods, or ninety (90) days, whichever is longer, shall apply. Dogtra, at its sole discretion, shall determine whether to repair or replace a product covered by the Original Warranty or Extended Warranty.

Warranty Conditions

The Original and Extended Warranties are not transferrable and apply to your Dogtra product only if:

- (1) You are the original retail purchaser of the product,
- (2) You bought the product from a Dogtra Authorized Dealer, and
- (3) You present a receipt or other proof of purchase showing a valid purchase date, the name and address of the Dogtra Authorized Dealer, and the purchased product identified by model and/or serial number.

Warranty Exclusions

The Original and Extended Warranties do not cover damage, loss, or deterioration to your Dogtra product caused: by misuse, neglect, abuse, or other improper handling of the product; by failure to follow use or care instructions; by use of the product for other than its intended purpose; by accident or natural forces such as fire or flooding; or by normal wear and tear such as scratches to the product surface.

The Original and Extended Warranties also do not cover Dogtra products that: are purchased from non-authorized dealers; are purchased outside of the United States or Canada; have been damaged during shipment (even if Dogtra paid or arranged for shipping); have been modified or tampered with in any manner; are opened or repaired by anyone other than Dogtra; or have serial numbers that have been altered or defaced.

Sole Warranties

The Original and Extended Warranties are the only warranties offered by Dogtra for your Dogtra product during said warranty periods. Other than the Original and Extended Warranties, Dogtra makes no other representations or warranties whatsoever regarding its products, whether oral or in any product manual, on any packaging, on any website, or in any other written material. No dealer of Dogtra products, nor any employee or agent of Dogtra, is authorized to make any additions, changes, or extensions to the Original Warranty or Extended Warranty. Dogtra, at its sole discretion and at any time, reserves the right to modify the Original and/or Extended Warranties.

DISCLAIMER OF OTHER WARRANTIES

THE FOREGOING ORIGINAL AND EXTENDED WARRANTIES ARE PROVIDED IN LIEU OF ALL OTHER WARRANTIES, WHETHER EXPRESS OR IMPLIED. DOGTRA DISCLAIMS ANY IMPLIED WARRANTIES INCLUDING, BUT NOT LIMITED TO, THE IMPLIED WARRANTIES OF MERCHANTABILITY AND FITNESS FOR A PARTICULAR PURPOSE.

Limitation of Remedies

Dogtra's liability is limited to the cost of repair or replacement of the Dogtra product under the Original Warranty or Extended Warranty. Any claim or action to enforce the Original and/or Extended Warranties must be commenced within thirty (30) days of such warranty's expiration for your product. Dogtra will not be liable for any indirect, incidental, special, consequential, or similar damages based on breach of warranty, breach of contract, negligence, strict tort, or any other legal theory related to Dogtra and its products. Damages that Dogtra will not be responsible for include, but are not limited to: loss of income or profits; loss of revenue or savings; loss of use of the product or associated products; cost of any substitute products or services; inconvenience, downtime, or any other time; loss of goodwill; claims of third parties including customers; and damage to property.

WARNING STATEMENT

FCC Part 15.19

This device complies with part 15 of the FCC Rules. Operation is subject to the following two conditions: (1) This device may not cause harmful interference, and (2) this device must accept any interference received, including interference that may cause undesired operation.

FCC Part 15.21

Any changes or modifications (including the antennas) to this device that are not expressly approved by the manufacturer may void the user's authority to operate the equipment.

FCC and IC RF Radiation Exposure Statement: This equipment complies with FCC and IC RF Radiation exposure limits set forth for an uncontrolled environment.

This device and its antenna must not be co-located or operating in conjunction with any other antenna or transmitter.

RF du FCC et IC d'exposition aux radiations: Cet équipement est conforme à l'exposition de FCC et IC rayonnements RF limites établies pour un environnement non contrôlé.

L'antenne pour ce transmetteur ne doit pas être même endroit avec d'autres émetteur sauf conformément à FCC et IC procédures de produits Multi-émetteur.

This device contains licence-exempt transmitter(s)/receiver(s) that comply with Innovation, Science and Economic Development Canada's licence-exempt RSS(s). Operation is subject to the following two conditions:

- (1) This device may not cause interference.
- (2) This device must accept any interference, including interference that may cause undesired operation of the device.

L'émetteur/récepteur exempt de licence contenu dans le présent appareil est conforme aux CNR d'Innovation, Sciences et Développement économique Canada applicables aux appareils radio exempts de licence. L'exploitation est autorisée aux deux conditions suivantes :

- (1) L'appareil ne doit pas produire de brouillage;
- (2) L'appareil doit accepter tout brouillage radioélectrique subi, même si le brouillage est susceptible d'en compromettre le fonctionnement.

Legal Rights May Vary By State or Jurisdiction

The Original and Extended Warranties give You specific legal rights, and You may also have other rights which vary by state or jurisdiction. Some states or jurisdictions do not allow certain limitations of implied warranties or of incidental or consequential damages or other remedies, so certain of the foregoing limitations may not apply to You.

If any portion of the Original Warranty or Extended Warranty is held by a court to be invalid or unenforceable, the remaining portions of such warranties shall remain in full force and effect and shall in no way be affected or invalidated, and the invalid or unenforceable portion shall be modified so as to most nearly achieve the intent of the Original Warranty or Extended Warranty.

Product Registration

Dogtra recommends that customers register their products as soon as possible after purchase. Product registration will facilitate any future warranty service. You may also receive useful information and updates about your existing and future Dogtra products. To register your product, visit www.dogtra.com/product-registration. If your product is not registered with Dogtra, You will be required to provide a receipt or other proof purchase (as provided above) to qualify for warranty service.

How to Obtain Warranty Service

Should your Dogtra product require warranty service, please contact Customer Service by phone or email for a warranty evaluation (see below for contact information). Upon approval of your warranty work, Dogtra will repair or replace (at Dogtra's election) your product without charge for labor or parts. You are responsible for shipping, including cost, of your product to Dogtra for warranty service. Dogtra will handle shipping, including cost, of the repaired or replaced product back to customers in the USA. Dogtra will not be responsible for shipping, including cost and/or applicable taxes or fees, for products sent outside the USA. Such costs, taxes, or fees will be borne by the customer.

Dogtra Customer Service

12322 Monarch Street, Garden Grove, CA 92841

(888) 811-9111

repair@dogtra.com

Mon – Fri, 8:00 AM to 4:30 PM (PST)

© 2021 Dogtra. All rights reserved.