

RADIO TEST REPORT

FCC 47 CFR PART 15 SUBPART C

Test Standard	FCC Part 15.249
Product name	Z-Wave® Scene Button
Brand Name	GOOD WAY
Model	TR1B100Z1
Test Result	Pass
Statements of Conformity	Determination of compliance is based on the results of the compliance measurement, not taking into account measurement instrumentation uncertainty.

The test Result was tested by Compliance Certification Services Inc. The test data, data evaluation, test procedures, and equipment configurations shown in this report were given in ANSI C63.10: 2013 and compliance standards.

The test results of this report relate only to the tested sample (EUT) identified in this report.

The test Report of full or partial shall not copy. Without written approval of Compliance Certification Services Inc. (Wugu Laboratory)

Approved by:



Kevin Tsai
Deputy Manager

Unless otherwise stated the results shown in this test report refer only to the sample(s) tested and such sample(s) are retained for 90 days only.
除非另有說明，此報告結果僅對測試之樣品負責，同時此樣品僅保留90天。本報告未經本公司書面許可，不可部份複製。

This document is issued by the Company subject to its General Conditions of Service printed overleaf, available on request or accessible at <http://www.sgs.com.tw/Terms-and-Conditions> and, for electronic format documents, subject to Terms and Conditions for Electronic Documents at <http://www.sgs.com.tw/Terms-and-Conditions>. Attention is drawn to the limitation of liability, indemnification and jurisdiction issues defined therein. Any holder of this document is advised that information contained hereon reflects the Company's findings at the time of its intervention only and within the limits of client's instruction, if any. The Company's sole responsibility is to its Client and this document does not exonerate parties to a transaction from exercising all their rights and obligations under the transaction documents. This document cannot be reproduced, except in full, without prior written approval of the Company. Any unauthorized alteration, forgery or falsification of the content or appearance of this document is unlawful and offenders may be prosecuted to the fullest extent of the law.



Report No.: T200528D01-RP

Page: 2 / 36

Rev.: 00

Revision History

Rev.	Issue Date	Revisions	Effect Page	Revised By
00	July 2, 2020	Initial Issue	ALL	Allison Chen



TABLE OF CONTENTS

1. GENERAL INFORMATION	4
1.1 EUT INFORMATION	4
1.2 EUT CHANNEL INFORMATION	5
1.3 ANTENNA INFORMATION	5
1.4 MEASUREMENT UNCERTAINTY	6
1.5 FACILITIES AND TEST LOCATION	7
1.6 INSTRUMENT CALIBRATION	7
1.7 SUPPORT AND EUT ACCESSORIES EQUIPMENT	8
1.8 TEST METHODOLOGY AND APPLIED STANDARDS	8
2. TEST SUMMERY	9
3. DESCRIPTION OF TEST MODES	10
3.1 THE WORST MODE OF OPERATING CONDITION	10
3.2 THE WORST MODE OF MEASUREMENT	10
3.3 EUT DUTY CYCLE	11
4. TEST RESULT	12
4.1 AC POWER LINE CONDUCTED EMISSION	12
4.2 20dB BANDWIDTH	13
4.3 RADIATION BANDEDGE AND SPURIOUS EMISSION	18
APPENDIX-A TEST PHOTO	A-1

1. GENERAL INFORMATION

1.1 EUT INFORMATION

Applicant	GOOD WAY TECHNOLOGY CO., LTD. 3F, No. 135, Ln. 235, Baociao Rd., Sindian Dist., New Taipei City 231, Taiwan
Equipment	Z-Wave® Scene Button
Brand Name	GOOD WAY
Model No.	TR1B100Z1
Model Discrepancy	N/A
Received Date	May 28, 2020
Date of Test	June 3, 2020
Power Operation	Power from Battery. (AAA*2)
RF Field Strength	908.4 MHz: 90.24 dBuV/m @peak
	908.42 MHz: 93.90 dBuV/m @peak
	916 MHz: 93.06 dBuV/m @peak
Date Rate	9.6 kbps / 40 kbps / 100 kbps

Report No.: T200528D01-RP

1.2 EUT CHANNEL INFORMATION

Frequency Range	908.4 MHz, 908.42 MHz, 916 MHz
Modulation Type	FSK / GFSK
Number of channel	3 Channel

Remark:

Refer as ANSI C63.10: 2013 clause 5.6.1 Table 4 for test channels

Number of frequencies to be tested		
Frequency range in which device operates	Number of frequencies	Location in frequency range of operation
<input checked="" type="checkbox"/> 1 MHz or less	1	Middle
<input type="checkbox"/> 1 MHz to 10 MHz	2	1 near top and 1 near bottom
<input type="checkbox"/> More than 10 MHz	3	1 near top, 1 near middle, and 1 near bottom

1.3 ANTENNA INFORMATION

Antenna Type	<input type="checkbox"/> PIFA <input type="checkbox"/> PCB <input type="checkbox"/> Dipole <input checked="" type="checkbox"/> Chip
Antenna Gain	Gain: -0.7 dBi
Antenna Connector	N/A

1.4 MEASUREMENT UNCERTAINTY

PARAMETER	UNCERTAINTY
AC Powerline Conducted Emission	+/- 1.2575
Emission bandwidth, 20dB bandwidth	+/- 0.0014
RF output power, conducted	+/- 1.14
Power density, conducted	+/- 1.40
3M Semi Anechoic Chamber / 30M~200M	+/- 4.12
3M Semi Anechoic Chamber / 200M~1000M	+/- 4.68
3M Semi Anechoic Chamber / 1G~8G	+/- 5.18
3M Semi Anechoic Chamber / 8G~18G	+/- 5.47
3M Semi Anechoic Chamber / 18G~26G	+/- 3.81
3M Semi Anechoic Chamber / 26G~40G	+/- 3.87

Remark:

1. This uncertainty represents an expanded uncertainty expressed at approximately the 95% confidence level using a coverage factor of $k=2$
2. ISO/IEC 17025 requires that an estimate of the measurement uncertainties associated with the emissions test results be included in the report.

1.5 FACILITIES AND TEST LOCATION

All measurement facilities used to collect the measurement data are located at No.11, Wugong 6th Rd., Wugu Dist., New Taipei City, Taiwan. (R.O.C.)

Test site	Test Engineer	Remark
AC Conduction Room	-	Not applicable, because EUT doesn't connect to AC Main Source direct.
Radiation	Jerry Chang	-
RF Conducted	Jerry Chang	-

Remark: The sites are constructed in conformance with the requirements of ANSI C63.7, ANSI C63.4 and CISPR Publication 22.

1.6 INSTRUMENT CALIBRATION

RF Conducted Test Site					
Name of Equipment	Manufacturer	Model	Serial Number	Calibration Date	Calibration Due
Coaxial Cable	Woken	WC12	CC003	06/28/2019	06/27/2020
Signal Analyzer	R&S	FSV 40	101073	09/25/2019	09/24/2020
Software	N/A				

Wugu 966 Chamber A					
Name of Equipment	Manufacturer	Model	Serial Number	Calibration Date	Calibration Due
Bilog Antenna	Sunol Sciences	JB3	A030105	07/26/2019	07/25/2020
Coaxial Cable	HUBER SUHNER	SUCOFLEX 104PEA	20995	02/25/2020	02/24/2021
Coaxial Cable	EMCI	EMC105	190914+25111	09/20/2019	09/19/2020
Digital Thermo-Hygro Meter	WISEWIND	1206	D07	01/15/2020	01/14/2021
double Ridged Guide Horn Antenna	ETC	MCTD 1209	DRH13M02003	10/04/2019	10/03/2020
High Pass Filter	SOLVANG TECHNOLOGY INC.	STI15	9923	02/25/2020	02/24/2021
Loop Ant	COM-POWER	AL-130	121051	03/27/2020	03/26/2021
Pre-Amplifier	EMEC	EM330	060609	02/25/2020	02/24/2021
Pre-Amplifier	HP	8449B	3008A00965	02/25/2020	02/24/2021
Signal Analyzer	Agilent	N9010A	MY52220817	03/19/2020	03/18/2021
Antenna Tower	CCS	CC-A-1F	N/A	N.C.R	N.C.R
Controller	CCS	CC-C-1F	N/A	N.C.R	N.C.R
Turn Table	CCS	CC-T-1F	N/A	N.C.R	N.C.R
Software	e3 6.11-20180413				

Remark: Each piece of equipment is scheduled for calibration once a year.



1.7 SUPPORT AND EUT ACCESSORIES EQUIPMENT

EUT Accessories Equipment					
No.	Equipment	Brand	Model	Series No.	FCC ID
	N/A				

Support Equipment					
No.	Equipment	Brand	Model	Series No.	BSMI ID
	N/A				

1.8 TEST METHODOLOGY AND APPLIED STANDARDS

The test methodology, setups and results comply with all requirements in accordance with ANSI C63.10:2013, FCC Part 2, FCC Part 15.249.

2. TEST SUMMERY

FCC Standard Section	Report Section	Test Item	Result
15.203	1.3	Antenna Requirement	Pass
15.207(a)	4.1	AC Conducted Emission	N/A
15.215(c)	4.2	20 dB Bandwidth	Pass
15.249(a)	4.3	Field strength of the fundamental signal	Pass
15.249(a) /15.209	4.3	Radiation Spurious Emission	Pass

3. DESCRIPTION OF TEST MODES

3.1 THE WORST MODE OF OPERATING CONDITION

Operation mode	Z-wave
Test Channel Frequencies	908.4 MHz, 908.42 MHz, 916 MHz

3.2 THE WORST MODE OF MEASUREMENT

Radiated Emission Measurement Above 1G	
Test Condition	Radiated Emission Above 1G
Power supply Mode	Mode 1: EUT power by Battery
Worst Mode	<input checked="" type="checkbox"/> Mode 1 <input type="checkbox"/> Mode 2 <input type="checkbox"/> Mode 3 <input type="checkbox"/> Mode 4
Worst Position	<input type="checkbox"/> Placed in fixed position. <input checked="" type="checkbox"/> Placed in fixed position at X-Plane (E2-Plane) <input type="checkbox"/> Placed in fixed position at Y-Plane (E1-Plane) <input type="checkbox"/> Placed in fixed position at Z-Plane (H-Plane)

Radiated Emission Measurement Below 1G	
Test Condition	Radiated Emission Below 1G
Power supply Mode	Mode 1: EUT power by Battery
Worst Mode	<input checked="" type="checkbox"/> Mode 1 <input type="checkbox"/> Mode 2 <input type="checkbox"/> Mode 3 <input type="checkbox"/> Mode 4

Remark:

1. The worst mode was record in this test report.
2. EUT pre-scanned in three axis ,X,Y, Z and two polarity, for radiated measurement. The worst case(X-Plane) were recorded in this report

3.3 EUT DUTY CYCLE

Duty Cycle				
Configuration	Duty Cycle (%)	Duty Factor (dB) =10*log (1/Duty Cycle)	1/T (kHz)	VBW setting (kHz)
908.4 MHz	100.00	0.00	N/A	10Hz
908.42 MHz	100.00	0.00	N/A	10Hz
916 MHz	100.00	0.00	N/A	10Hz

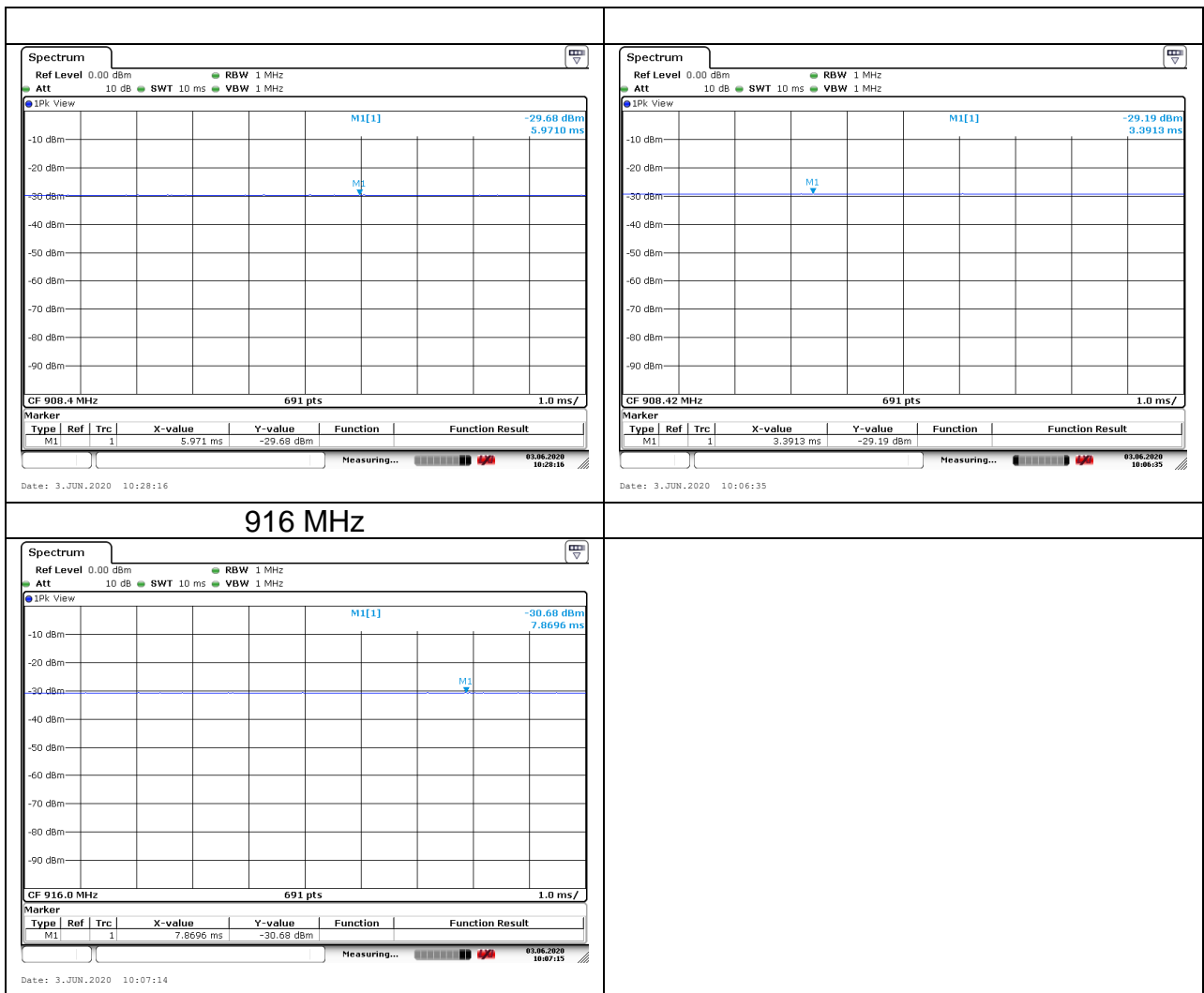

4. TEST RESULT

4.1 AC POWER LINE CONDUCTED EMISSION

4.1.1 Test Limit

According to §15.207(a),

Frequency Range (MHz)	Limits(dBµV)	
	Quasi-peak	Average
0.15 to 0.50	66 to 56*	56 to 46*
0.50 to 5	56	46
5 to 30	60	50

* Decreases with the logarithm of the frequency.

4.1.2 Test Procedure

Test method Refer as ANSI C63.10: 2013 clause 6.2,

1. The EUT was placed on a non-conducted table, which is 0.8m above horizontal ground plane and 0.4m above vertical ground plane.
2. EUT connected to the line impedance stabilization network (LISN)
3. Receiver set RBW of 9kHz and Detector Peak, and note as quasi-peak and average.
4. Maximum procedure was performed on the six highest emissions to ensure EUT compliance.
5. Recorded Line for Neutral and Line.

4.1.3 Test Setup

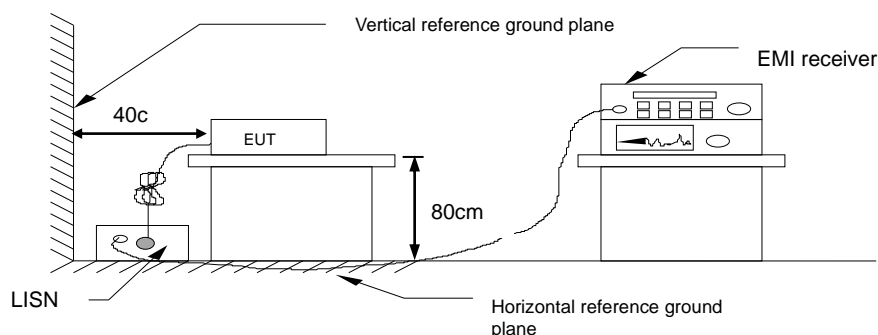

4.1.4 Test Result

Not applicable, because EUT doesn't connect to AC Main Source direct.

4.2 20dB BANDWIDTH

LIMIT

None; for reporting purposes only.

Test Configuration

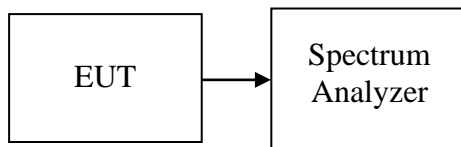

TEST PROCEDURE

1. Place the EUT on the table and set it in the transmitting mode.
2. Remove the antenna from the EUT and then connect a low loss RF cable from the antenna port to the spectrum analyzer.
3. Set the spectrum analyzer as RBW=3kHz, VBW = 10kHz, Span = 500kHz, Sweep = auto.
4. Set the spectrum analyzer as OBW(99%) function.
5. Mark the peak frequency and 20dB (upper and lower) frequency.
6. Repeat until all the rest channels are investigated.

TEST RESULTS

No non-compliance noted

Test Data

Frequency (MHz)	20dB Bandwidth (kHz)	99% OBW (kHz)
908.4 MHz	62.23	55.7163
908.42 MHz	65.85	59.3342
916 MHz	76.7	71.6353

Test Plot 20dB Bandwidth

908.4 MHz

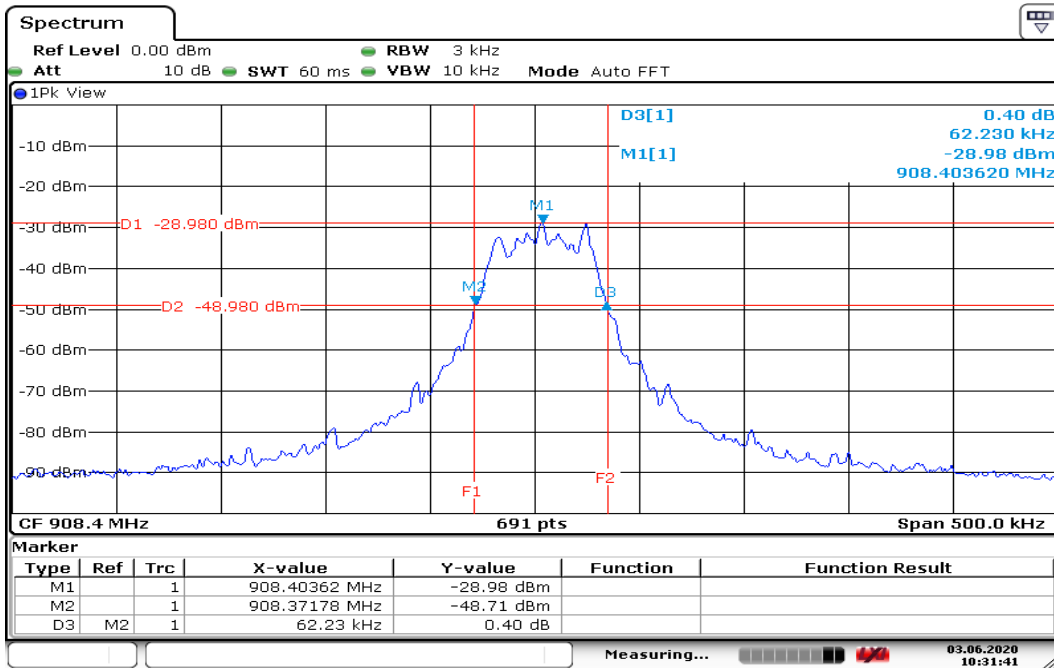

Date: 3.JUN.2020 10:31:41

908.42 MHz

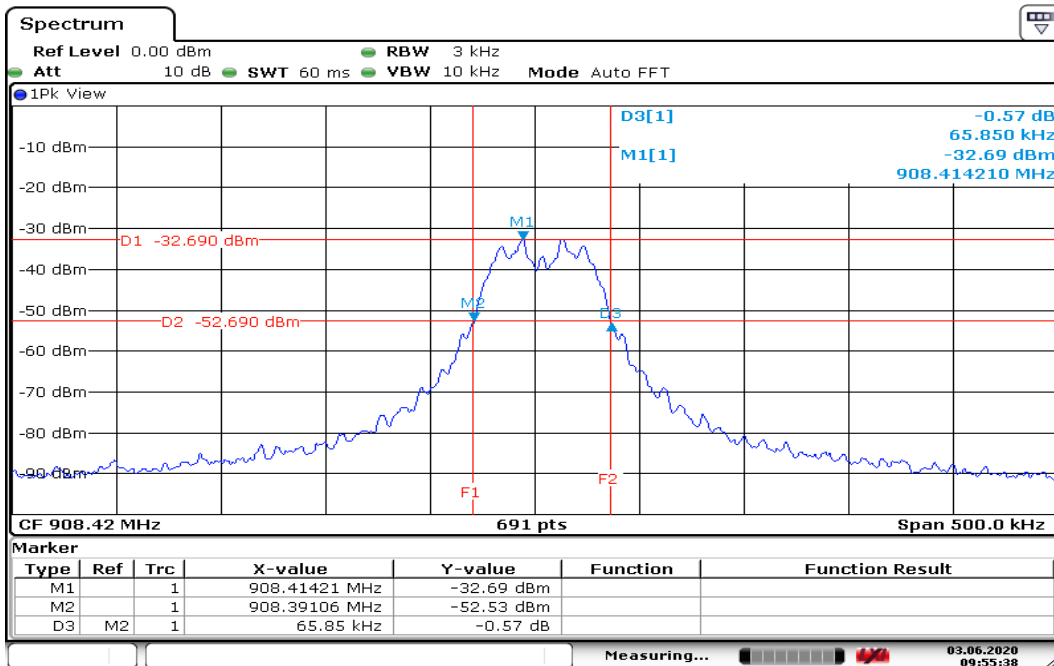

Date: 3.JUN.2020 09:55:37

916 MHz

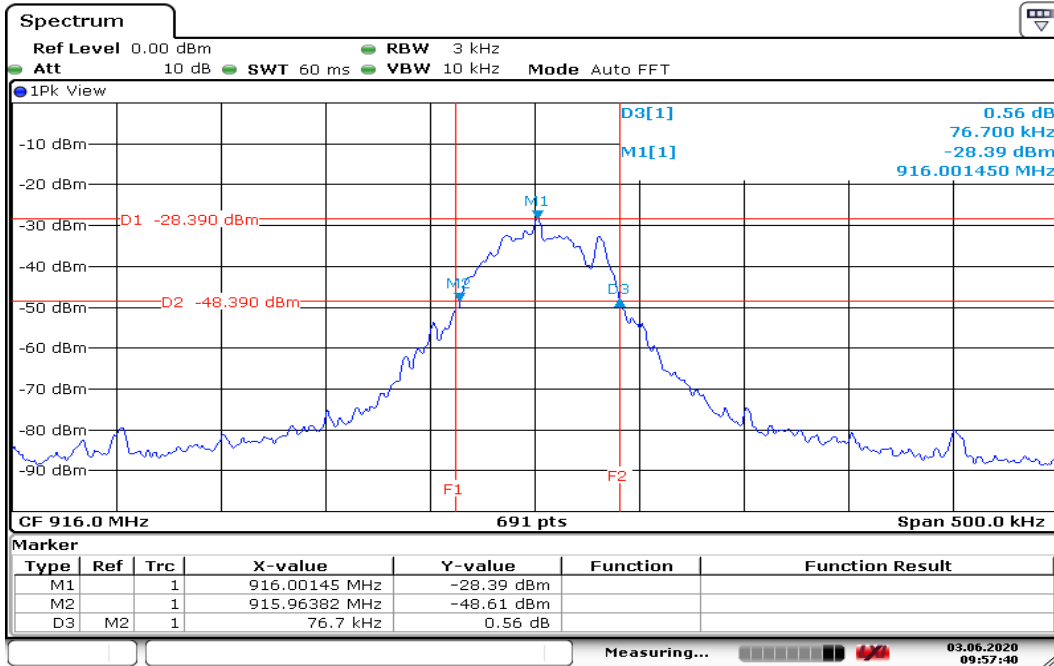

Date: 3.JUN.2020 09:57:40

Test Plot 99% OBW

908.4 MHz

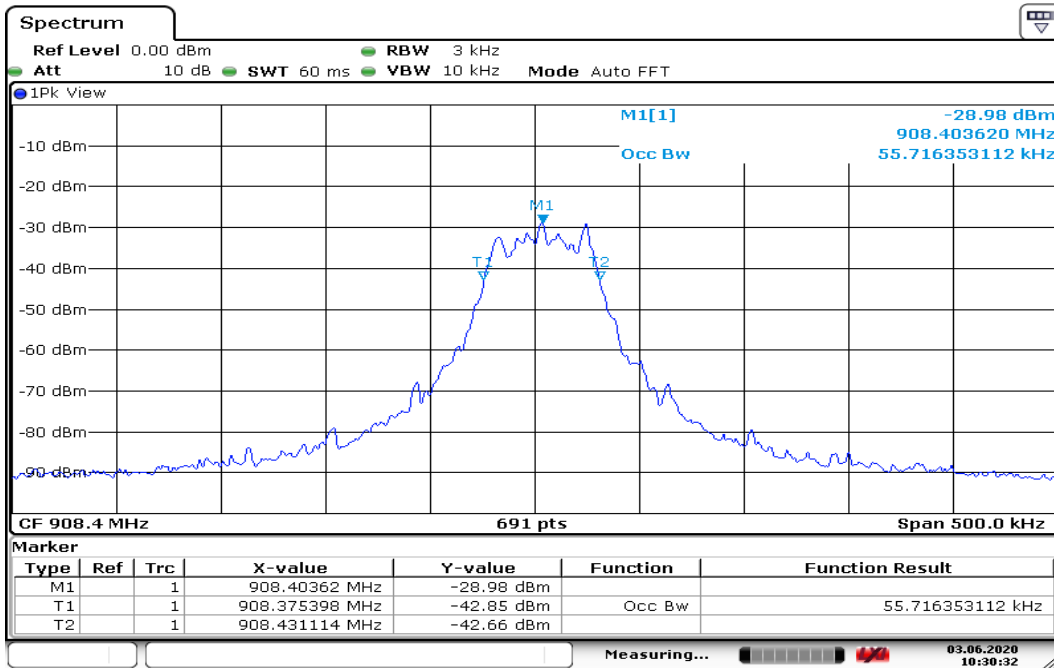

Date: 3.JUN.2020 10:30:32

908.42 MHz

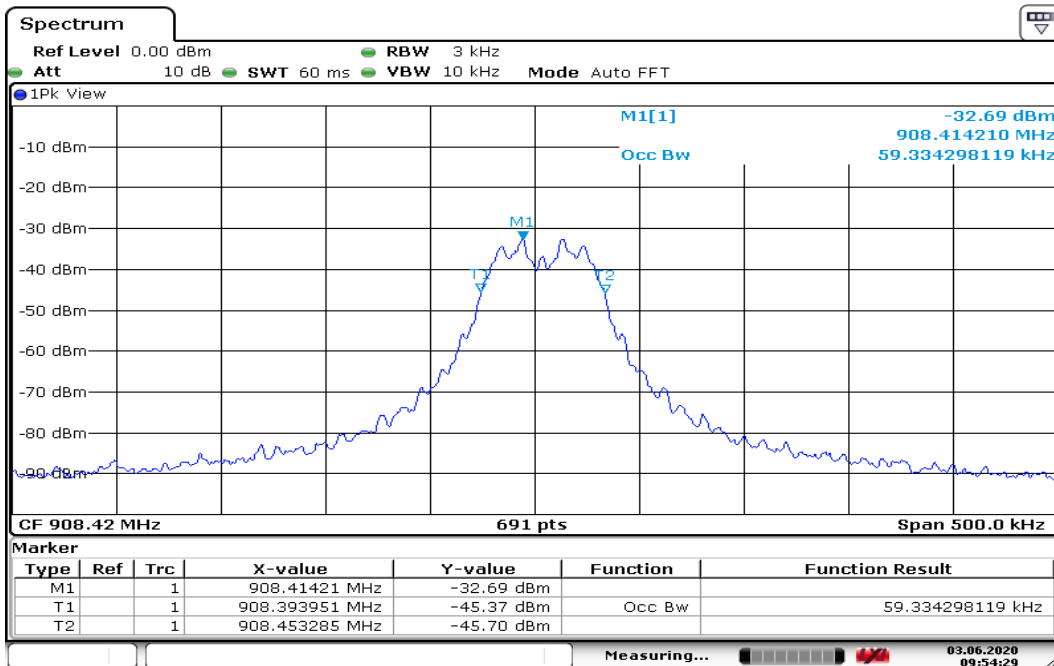

Date: 3.JUN.2020 09:54:28

916 MHz

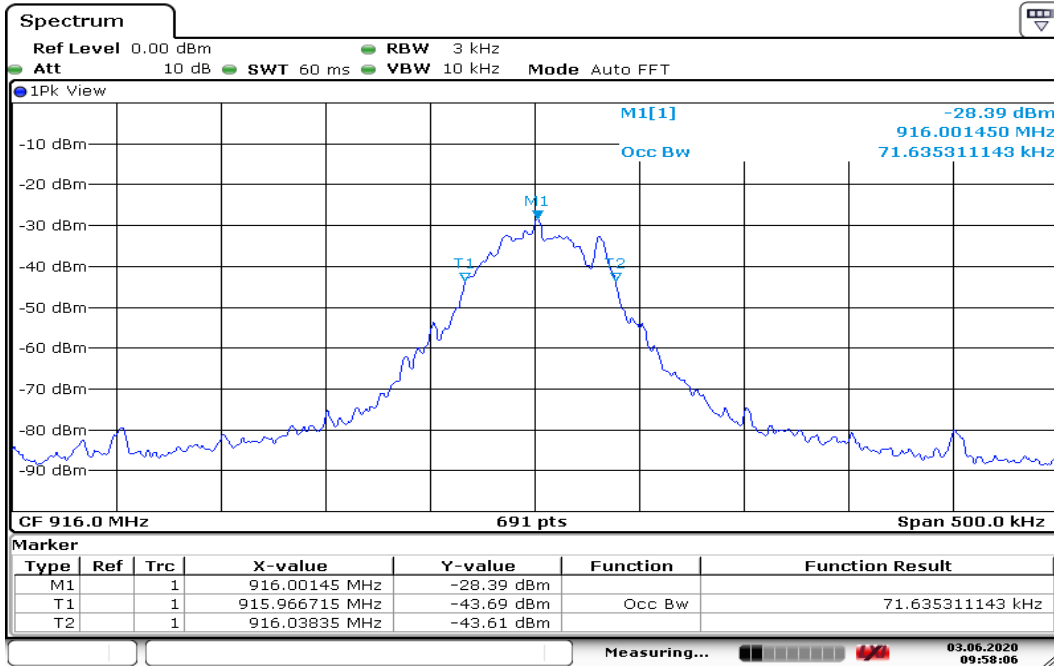

Date: 3.JUN.2020 09:58:06

4.3 RADIATION FUNDAMENTAL AND SPURIOUS EMISSION

4.3.1 Test Limit

According to §15.249(a), the field strength of emissions from intentional radiators operated within these frequency bands shall comply with the follow:

Fundamental frequency	Field strength of fundamental (millivolts/meter)	Field strength of harmonics (microvolts/meter)
902-928 MHz	50	500
2400-2483.5 MHz	50	500
5725-5875 MHz	50	500
24.0-24.25 GHz	250	2500

According to §15.249(d), Emission Radiated outside of specified frequency bands, except for harmonics, shall be attenuated by at 50dB below the level of the fundamental or to the general radiated emission limits in section §15.209.

According to §15.249(e), for frequencies above 1000 MHz, the above field strength limits are based on average limits. The peak field strength of any emission shall not exceed the maximum permitted average limits specified above by more than 20 dB under any condition of modulation.

Below 30 MHz

Frequency	Field Strength (microvolts/m)	Magnetic H-Field (microamperes/m)	Measurement Distance (metres)
9-490 kHz	2,400/F (F in kHz)	2,400/F (F in kHz)	300
490-1,705 kHz	24,000/F (F in kHz)	24,000/F (F in kHz)	30
1.705-30 MHz	30	N/A	30

Above 30 MHz

Frequency (MHz)	Field Strength microvolts/m at 3 metres (watts, e.i.r.p.)	
	Transmitters	Receivers
30-88	100 (3 nW)	100 (3 nW)
88-216	150 (6.8 nW)	150 (6.8 nW)
216-960	200 (12 nW)	200 (12 nW)
Above 960	500 (75 nW)	500 (75 nW)

Remark:

Although these tests were performed other than open area test site, adequate comparison measurements were confirmed against 30 m open are test site. Therefore sufficient tests were made to demonstrate that the alternative site produces results that correlate with the ones of tests made in an open field based on KDB 414788.

4.3.2 Test Procedure

1. The EUT is placed on a turntable, Above 1 GHz is 1.5m and below 1 GHz is 0.8m above ground plane. The EUT Configured un accordance with ANSI C63.10: 2013, and the EUT set in a continuous mode.

2. The turntable shall be rotated for 360 degrees to determine the position of maximum emission level. And EUT is set 3m away from the receiving antenna, which is scanned from 1m to 4m above the ground plane to find out the highest emissions. Measurement are made polarized in both the vertical and the horizontal positions with antenna.

3. Span shall wide enough to full capture the emission measured. The SA from 9kHz to 26.5GHz set to the low, Mid and High channels with the EUT transmit.

Note: No emission found between lowest internal used/generated frequency to 30MHz(9KHz~30MHz)

4. The SA setting following :

(1) Below 1G : RBW = 100kHz, VBW \geq 3 RBW, Sweep = Auto, Detector = Peak, Trace = Max hold.

(2) Above 1G :

(2.1) For Peak measurement : RBW = 1MHz, VBW \geq 3 RBW, Sweep = Auto, Detector = Peak, Trace = Max hold.

(2.2) For Average measurement : RBW = 1MHz, VBW

·If Duty Cycle \geq 98%, VBW=10Hz.

·If Duty Cycle < 98%, VBW \geq 1/T.

4.3.3 Test Setup

9kHz ~ 30MHz

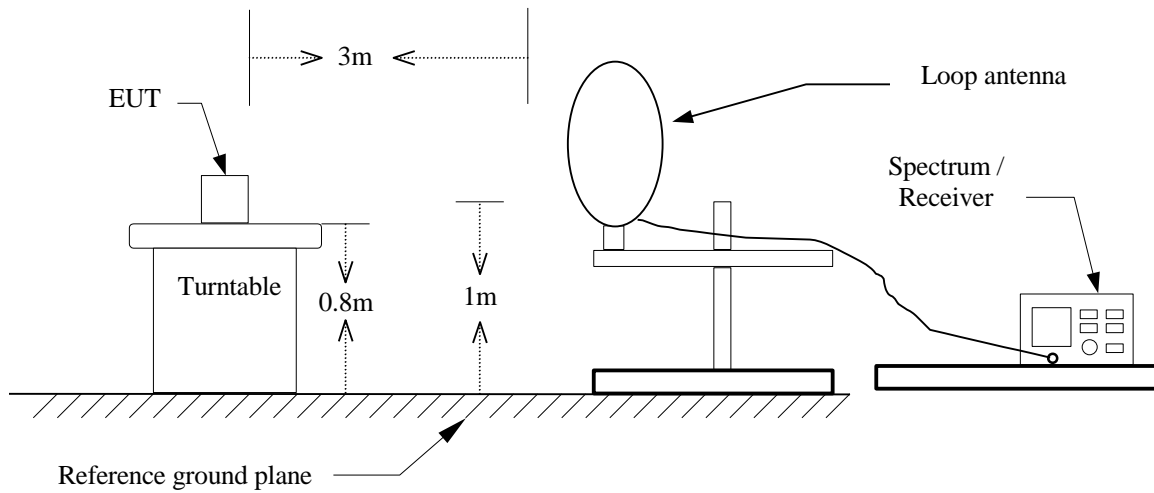

30MHz ~ 1GHz

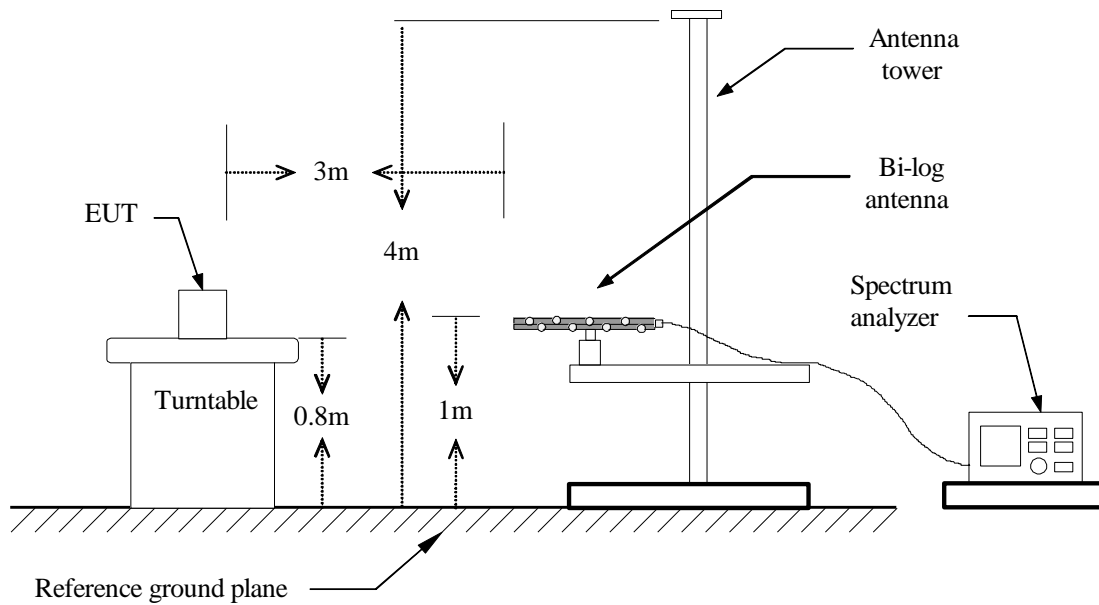

Above 1 GHz

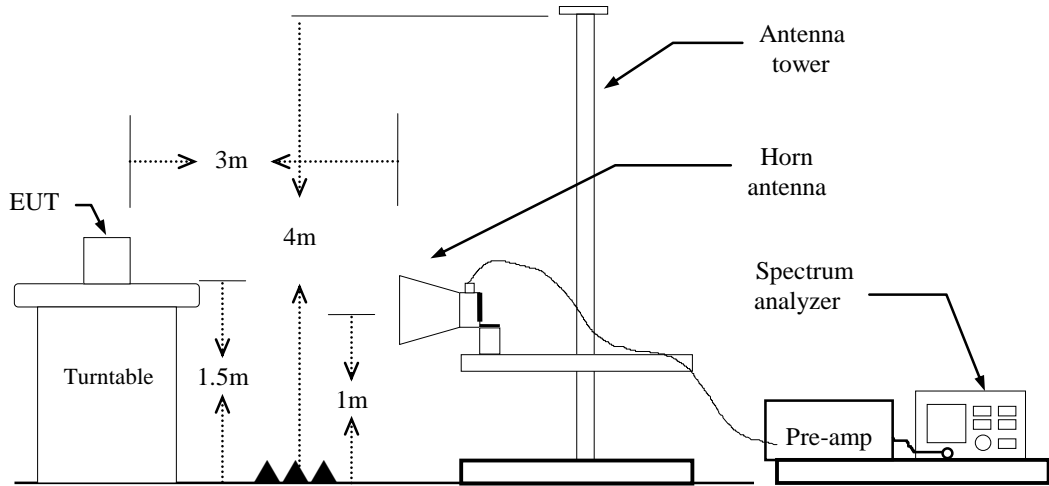



Radiation Fundamental

Test Mode:	908.4 MHz	Temp/Hum	24.6(°C)/ 51%RH
Test Item	Main	Test Date	June 3, 2020
Polarize	Vertical / Horizontal	Test Engineer	Jerry Chang

Vertical

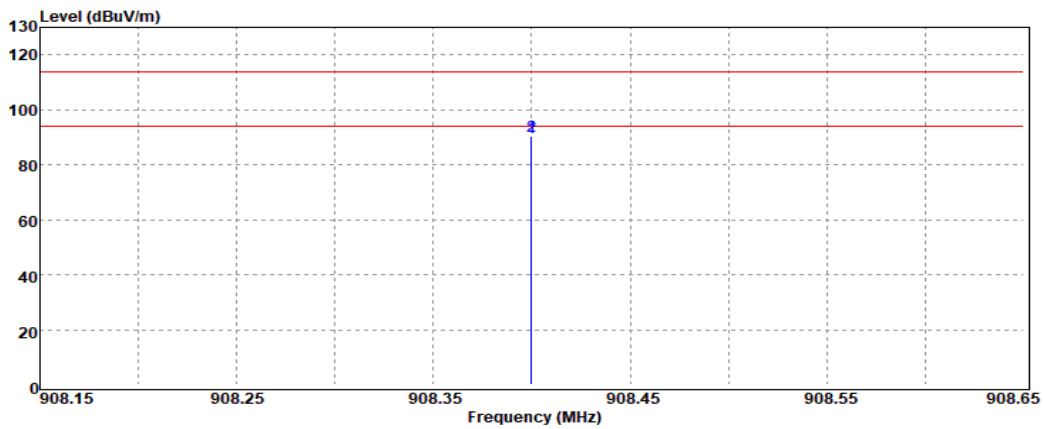

Horizontal

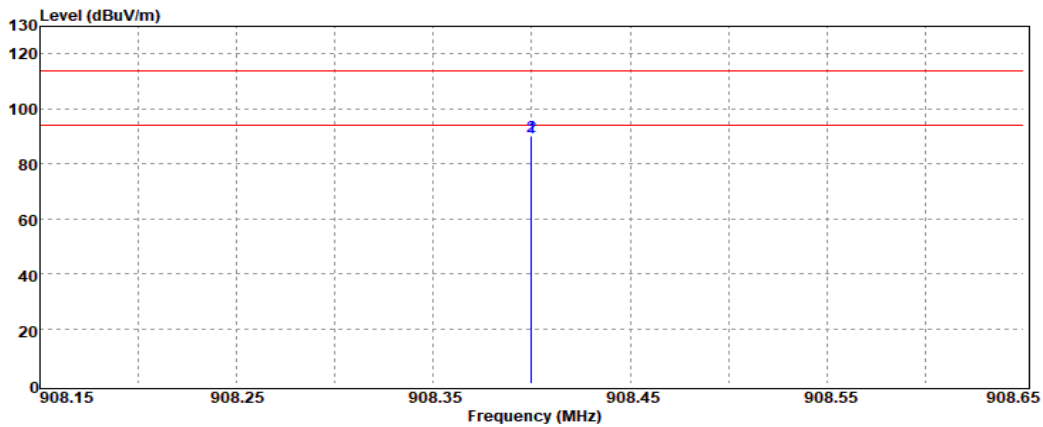

Freq. MHz	Detector Mode PK/QP/AV	Spectrum Reading Level dBµV	Factor dB	Actual FS dBµV/m	Limit @3m dBµV/m	Margin dB	Remark
908.40	Average	86.48	3.55	90.03	94.00	-3.97	V
908.40	Peak	86.69	3.55	90.24	114.00	-23.76	V
908.40	Average	86.03	3.55	89.58	94.00	-4.42	H
908.40	Peak	86.21	3.55	89.76	114.00	-24.24	H



Report No.: T200528D01-RP

Test Mode:	908.42 MHz	Temp/Hum	24.6(°C)/ 51%RH
Test Item	Main	Test Date	June 3, 2020
Polarize	Vertical / Horizontal	Test Engineer	Jerry Chang

Vertical

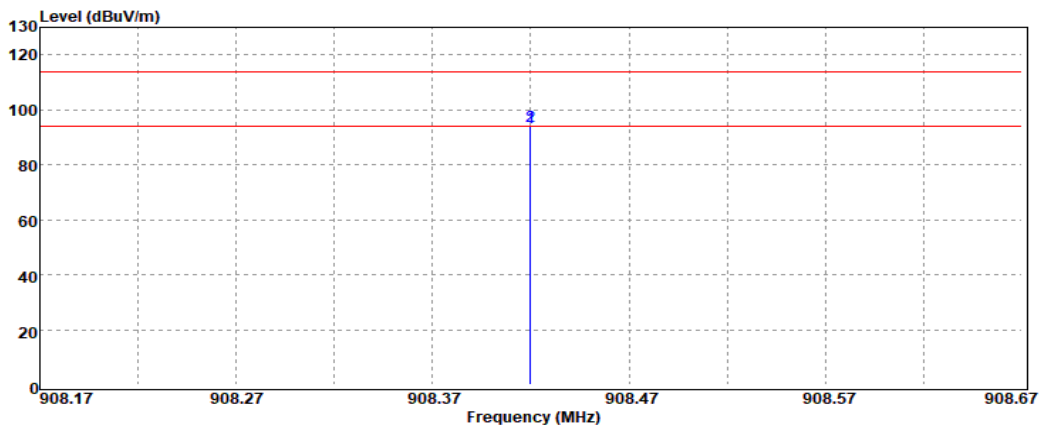

Horizontal

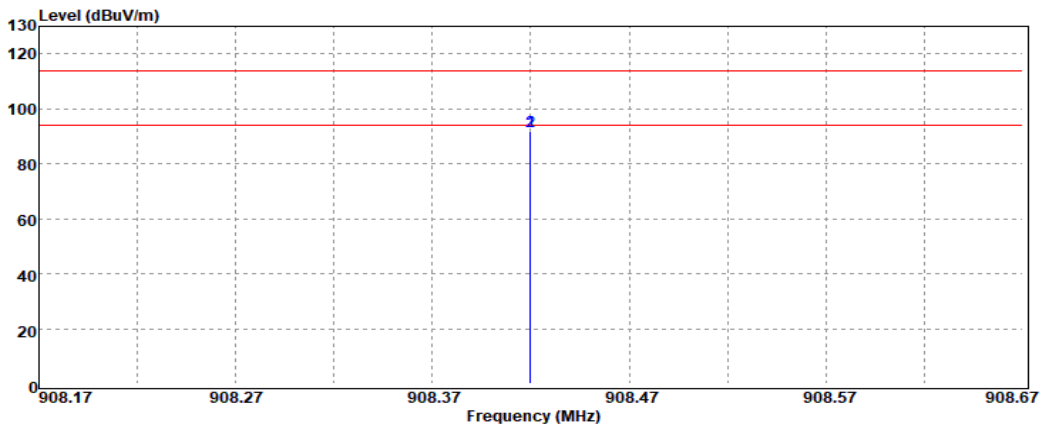

Freq. MHz	Detector Mode PK/QP/AV	Spectrum Reading Level dBμV	Factor dB	Actual FS dBμV/m	Limit @3m dBμV/m	Margin dB	Remark
908.42	Average	90.14	3.55	93.69	94.00	-0.31	V
908.42	Peak	90.35	3.55	93.90	114.00	-20.10	V
908.42	Average	88.22	3.55	91.77	94.00	-2.23	H
908.42	Peak	88.35	3.55	91.90	114.00	-22.10	H

Test Mode:	916 MHz	Temp/Hum	24.6(°C)/ 51%RH
Test Item	Main	Test Date	June 3, 2020
Polarize	Vertical / Horizontal	Test Engineer	Jerry Chang

Vertical

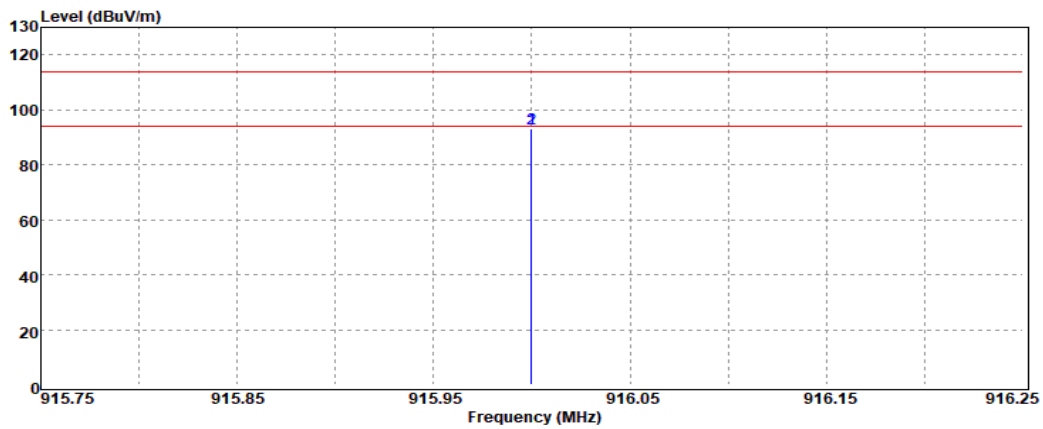

Horizontal

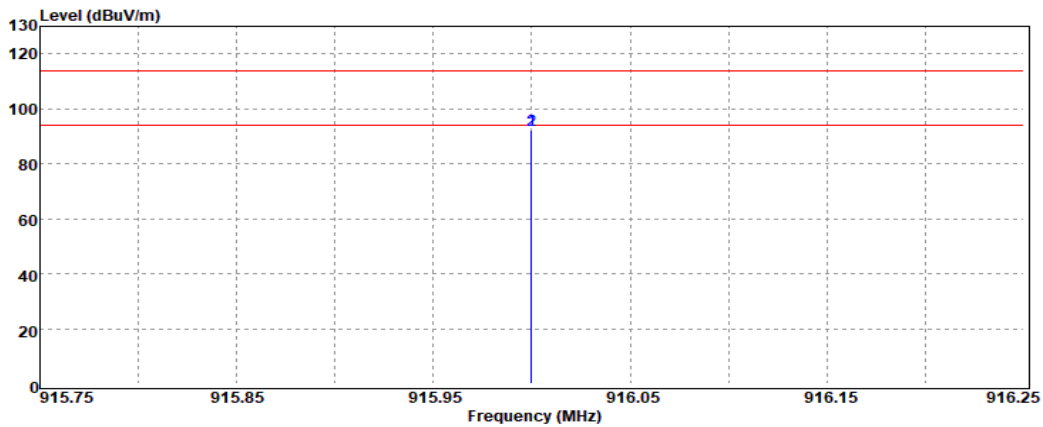

Freq. MHz	Detector Mode PK/QP/AV	Spectrum Reading Level dBµV	Factor dB	Actual FS dBµV/m	Limit @3m dBµV/m	Margin dB	Remark
916.00	Average	89.45	3.57	93.02	94.00	-0.98	V
916.00	Peak	89.49	3.57	93.06	114.00	-20.94	V
916.00	Average	88.57	3.57	92.14	94.00	-1.86	H
916.00	Peak	88.75	3.57	92.32	114.00	-21.68	H

Report No.: T200528D01-RP

Below 1G Test Data

Test Mode:	908.4 MHz	Temp/Hum	24.6(°C)/ 51%RH
Test Item	30MHz-1GHz	Test Date	June 3, 2020
Polarize	Vertical	Test Engineer	Jerry Chang
Detector	Peak		

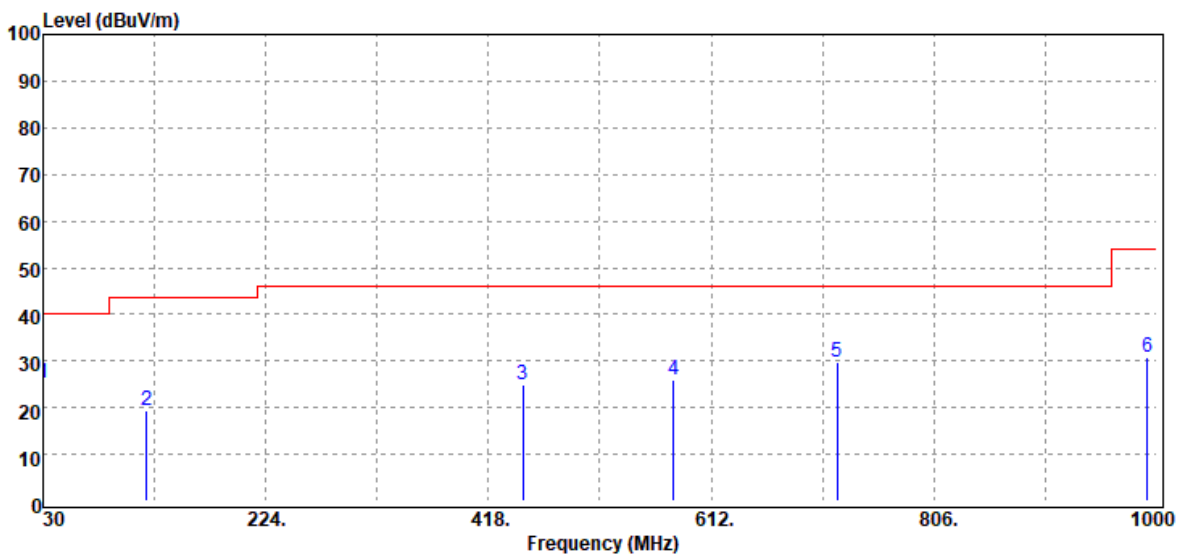

No.	Freq. MHz	Detector Mode PK/QP/AV	Spectrum Reading Level dB μ V	Factor dB	Actual FS dB μ V/m	Limit @3m dB μ V/m	Margin dB
1	30.00	Peak	27.81	-2.44	25.37	40.00	-14.63
2	120.21	Peak	28.64	-9.17	19.47	43.50	-24.03
3	448.07	Peak	29.10	-4.33	24.77	46.00	-21.23
4	579.02	Peak	28.09	-1.98	26.11	46.00	-19.89
5	721.61	Peak	29.25	0.54	29.79	46.00	-16.21
6	992.24	Peak	25.98	4.85	30.83	54.00	-23.17

Report No.: T200528D01-RP

Test Mode:	908.4 MHz	Temp/Hum	24.6(°C)/ 51%RH
Test Item	30MHz-1GHz	Test Date	June 3, 2020
Polarize	Horizontal	Test Engineer	Jerry Chang
Detector	Peak		

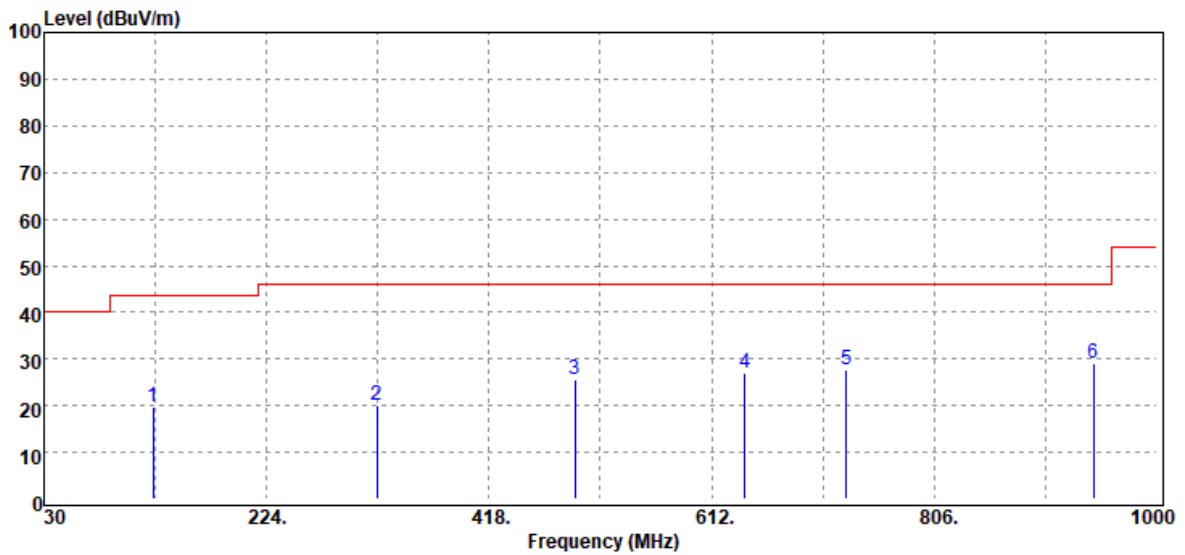

No.	Freq. MHz	Detector Mode PK/QP/AV	Spectrum Reading Level dB μ V	Factor dB	Actual FS dB μ V/m	Limit @3m dB μ V/m	Margin dB
1	125.06	Peak	28.65	-9.06	19.59	43.50	-23.91
2	320.03	Peak	27.94	-7.88	20.06	46.00	-25.94
3	492.69	Peak	28.65	-3.21	25.44	46.00	-20.56
4	641.10	Peak	27.52	-0.55	26.97	46.00	-19.03
5	729.37	Peak	27.00	0.53	27.53	46.00	-18.47
6	944.71	Peak	24.90	4.05	28.95	46.00	-17.05

Report No.: T200528D01-RP

Test Mode:	908.42 MHz	Temp/Hum	24.6(°C)/ 51%RH
Test Item	30MHz-1GHz	Test Date	June 3, 2020
Polarize	Vertical	Test Engineer	Jerry Chang
Detector	Peak		

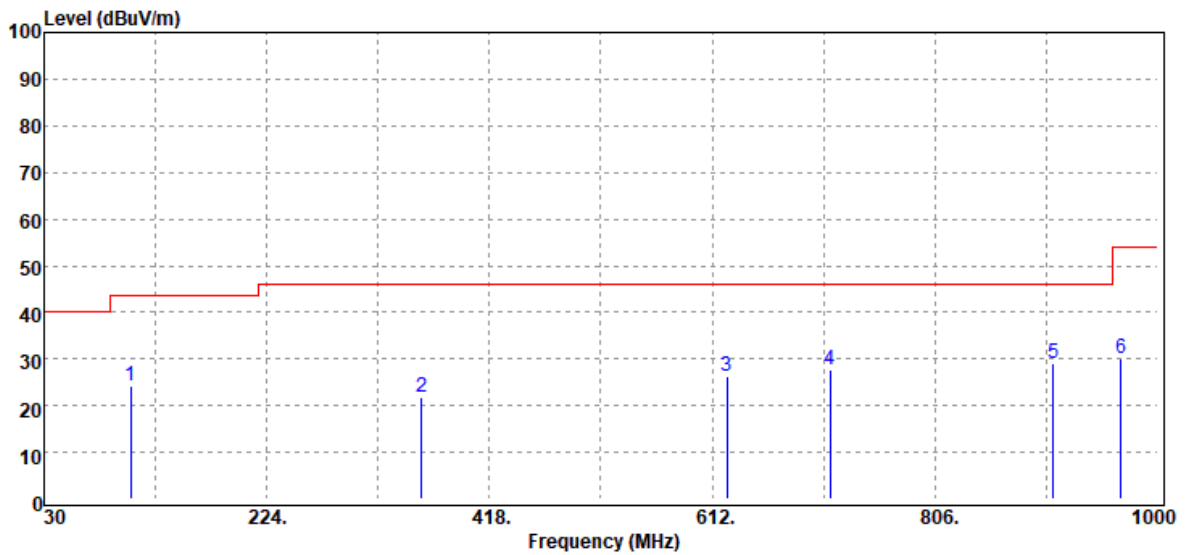

No.	Freq. MHz	Detector Mode PK/QP/AV	Spectrum Reading Level dB μ V	Factor dB	Actual FS dB μ V/m	Limit @3m dB μ V/m	Margin dB
1	105.66	Peak	35.52	-11.23	24.29	43.50	-19.21
2	358.83	Peak	28.75	-6.83	21.92	46.00	-24.08
3	624.61	Peak	27.10	-0.92	26.18	46.00	-19.82
4	714.82	Peak	27.37	0.37	27.74	46.00	-18.26
5	908.82	Peak	25.49	3.54	29.03	46.00	-16.97
6	967.99	Peak	25.97	4.21	30.18	54.00	-23.82

Report No.: T200528D01-RP

Test Mode:	908.42 MHz	Temp/Hum	24.6(°C)/ 51%RH
Test Item	30MHz-1GHz	Test Date	June 3, 2020
Polarize	Horizontal	Test Engineer	Jerry Chang
Detector	Peak		

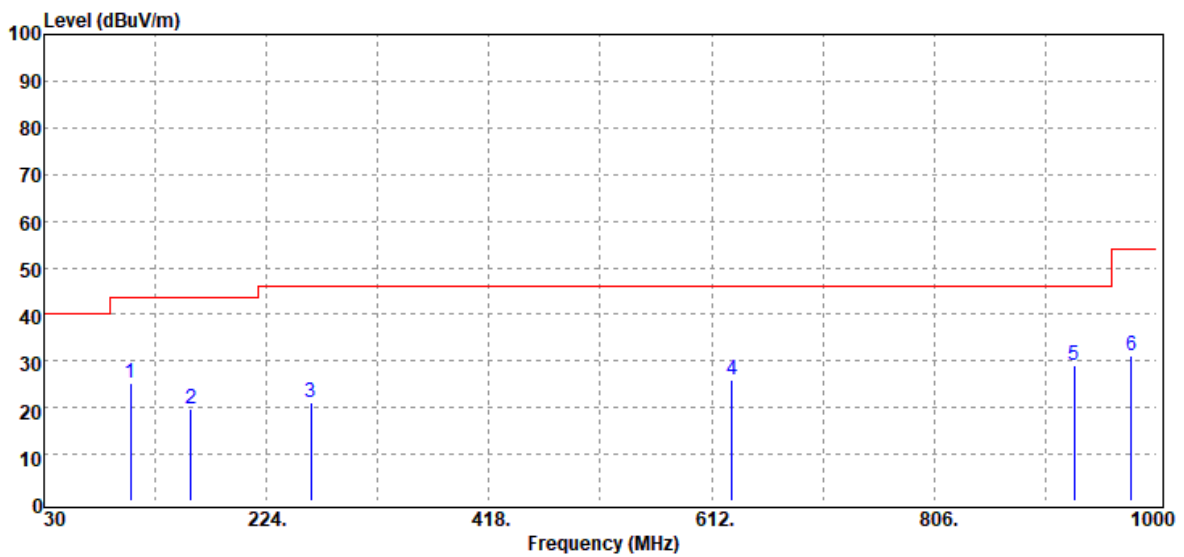

No.	Freq. MHz	Detector Mode PK/QP/AV	Spectrum Reading Level dB μ V	Factor dB	Actual FS dB μ V/m	Limit @3m dB μ V/m	Margin dB
1	105.66	Peak	36.32	-11.23	25.09	43.50	-18.41
2	158.04	Peak	30.16	-10.31	19.85	43.50	-23.65
3	262.80	Peak	30.61	-9.55	21.06	46.00	-24.94
4	629.46	Peak	26.69	-0.78	25.91	46.00	-20.09
5	928.22	Peak	25.28	3.66	28.94	46.00	-17.06
6	977.69	Peak	26.69	4.51	31.20	54.00	-22.80

Report No.: T200528D01-RP

Test Mode:	916 MHz	Temp/Hum	24.6(°C)/ 51%RH
Test Item	30MHz-1GHz	Test Date	June 3, 2020
Polarize	Vertical	Test Engineer	Jerry Chang
Detector	Peak		

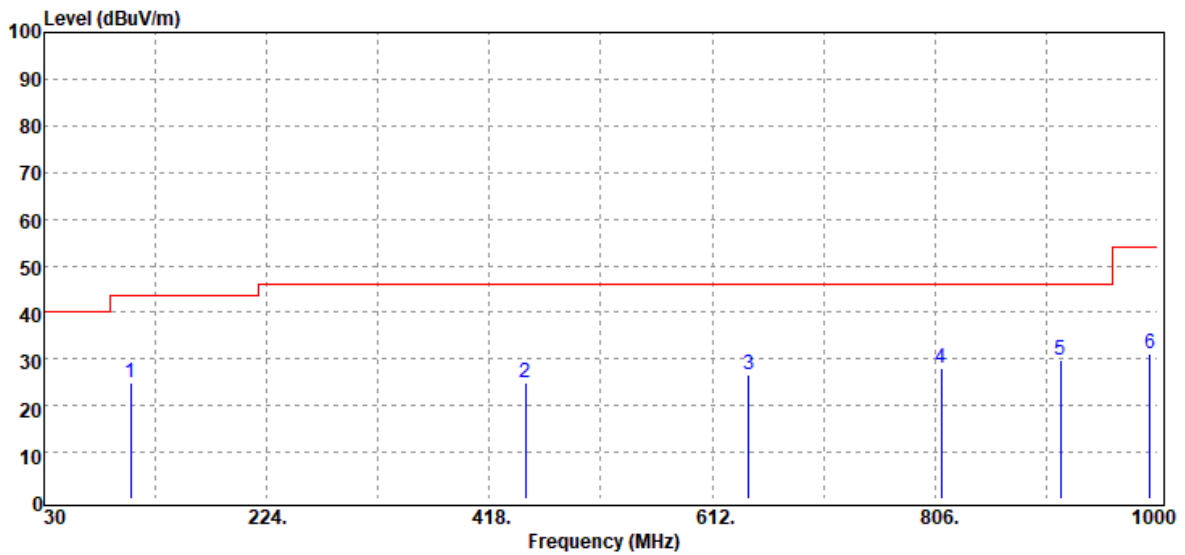

No.	Freq. MHz	Detector Mode PK/QP/AV	Spectrum Reading Level dB μ V	Factor dB	Actual FS dB μ V/m	Limit @3m dB μ V/m	Margin dB
1	105.66	Peak	36.19	-11.23	24.96	43.50	-18.54
2	449.04	Peak	29.22	-4.29	24.93	46.00	-21.07
3	644.01	Peak	27.15	-0.58	26.57	46.00	-19.43
4	811.82	Peak	25.98	2.09	28.07	46.00	-17.93
5	915.61	Peak	26.16	3.57	29.73	46.00	-16.27
6	993.21	Peak	26.37	4.84	31.21	54.00	-22.79

Report No.: T200528D01-RP

Test Mode:	916 MHz	Temp/Hum	24.6(°C)/ 51%RH
Test Item	30MHz-1GHz	Test Date	June 3, 2020
Polarize	Horizontal	Test Engineer	Jerry Chang
Detector	Peak		

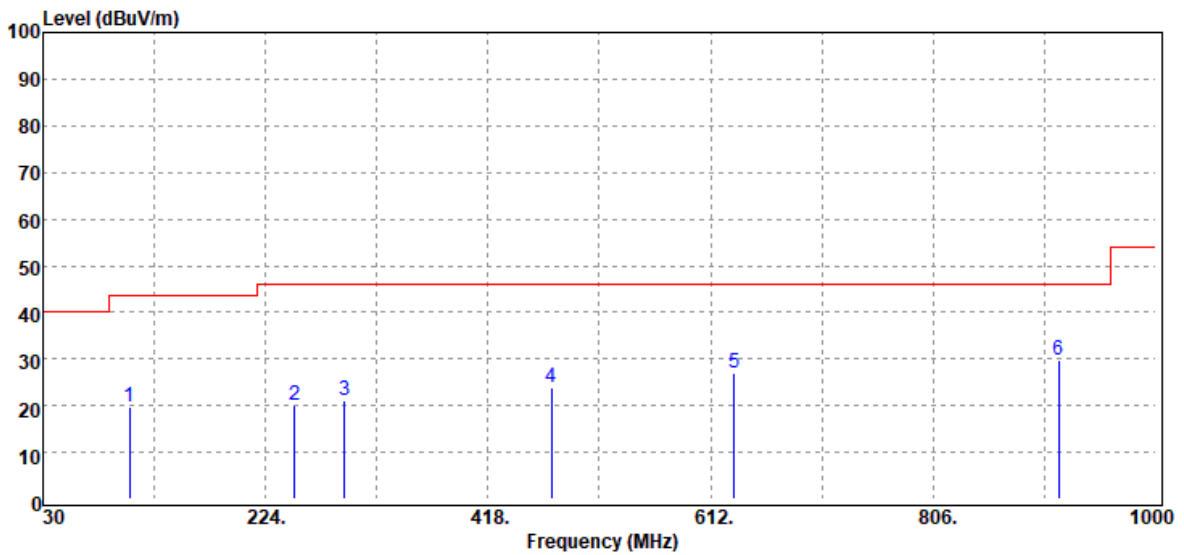

No.	Freq. MHz	Detector Mode PK/QP/AV	Spectrum Reading Level dB μ V	Factor dB	Actual FS dB μ V/m	Limit @3m dB μ V/m	Margin dB
1	105.66	Peak	31.12	-11.23	19.89	43.50	-23.61
2	249.22	Peak	30.60	-10.60	20.00	46.00	-26.00
3	292.87	Peak	29.57	-8.59	20.98	46.00	-25.02
4	473.29	Peak	27.43	-3.45	23.98	46.00	-22.02
5	632.37	Peak	27.70	-0.64	27.06	46.00	-18.94
6	915.61	Peak	26.07	3.57	29.64	46.00	-16.36

Above 1G Test Data

Test Mode:	908.4 MHz	Temp/Hum	24.6(°C)/ 51%RH
Test Item	Harmonic	Test Date	June 3, 2020
Polarize	Vertical	Test Engineer	Jerry Chang
Detector	Peak		

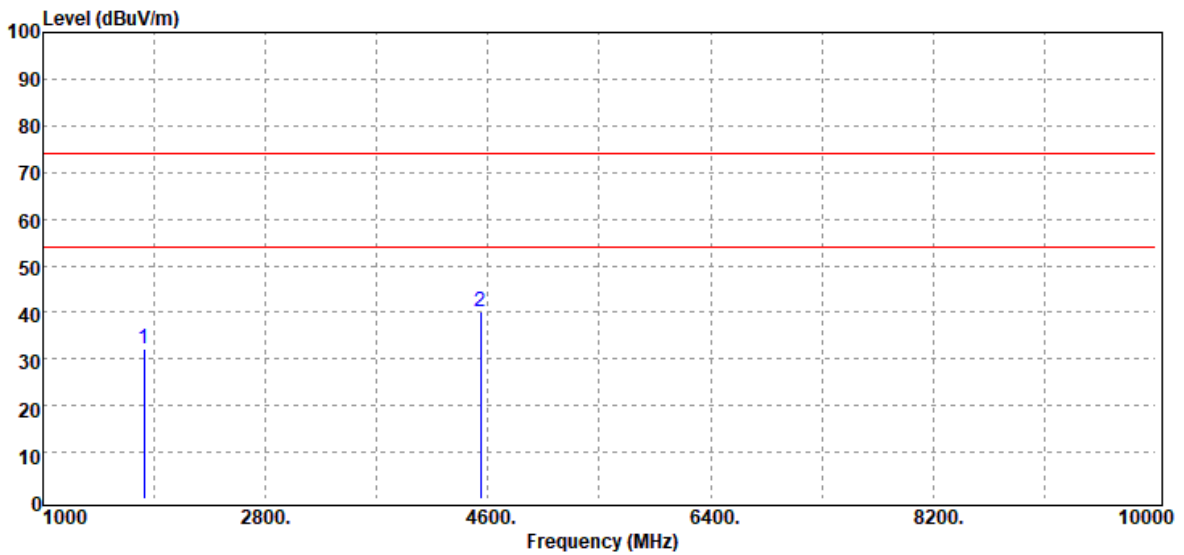

No.	Freq. MHz	Detector Mode PK/QP/AV	Spectrum Reading Level dB μ V	Factor dB	Actual FS dB μ V/m	Limit @3m dB μ V/m	Margin dB
1	1816.80	Peak	43.14	-11.04	32.10	74.00	-41.90
2	4542.00	Peak	44.93	-4.77	40.16	74.00	-33.84
	N/A						

Remark:

1. Measuring frequencies from 1 GHz to the 10th harmonic of highest fundamental frequency.
2. For above 1GHz, the EUT peak value was under average limit, therefore the Average value compliance with the average limit

Test Mode:	908.4 MHz	Temp/Hum	24.6(°C)/ 51%RH
Test Item	Harmonic	Test Date	June 3, 2020
Polarize	Horizontal	Test Engineer	Jerry Chang
Detector	Peak		

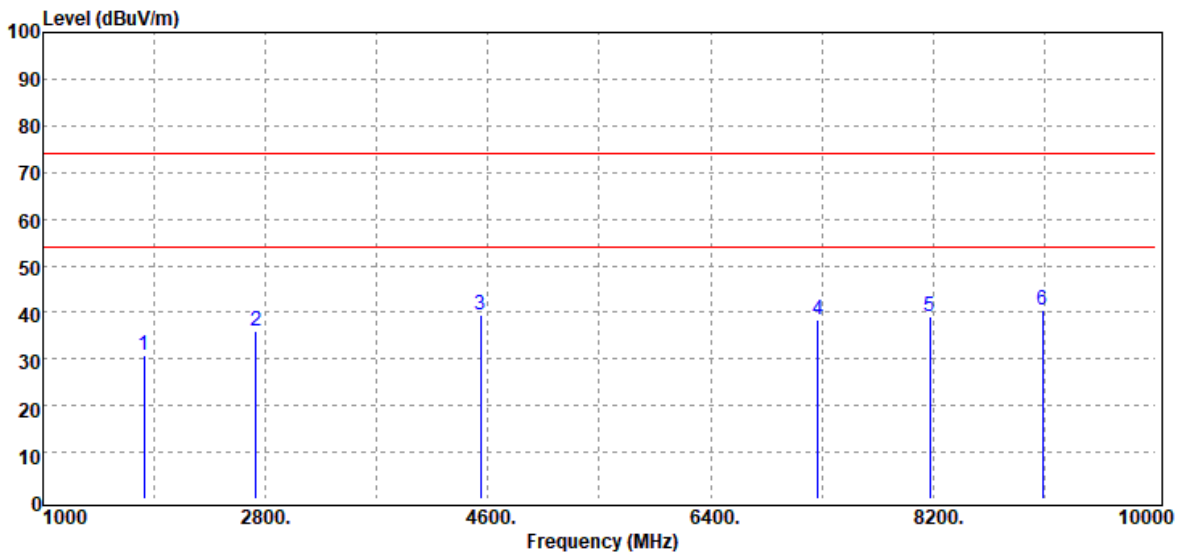

No.	Freq. MHz	Detector Mode PK/QP/AV	Spectrum Reading Level dBuV	Factor dB	Actual FS dBuV/m	Limit @3m dBuV/m	Margin dB
1	1816.80	Peak	41.72	-11.04	30.68	74.00	-43.32
2	2725.20	Peak	44.33	-8.34	35.99	74.00	-38.01
3	4542.00	Peak	44.36	-4.77	39.59	74.00	-34.41
4	7267.20	Peak	38.83	-0.47	38.36	74.00	-35.64
5	8175.60	Peak	39.45	-0.43	39.02	74.00	-34.98
6	9084.00	Peak	40.24	0.29	40.53	74.00	-33.47

Remark:

1. Measuring frequencies from 1 GHz to the 10th harmonic of highest fundamental frequency.
2. For above 1GHz, the EUT peak value was under average limit, therefore the Average value compliance with the average limit

Test Mode:	908.42 MHz	Temp/Hum	24.6(°C)/ 51%RH
Test Item	Harmonic	Test Date	June 3, 2020
Polarize	Vertical	Test Engineer	Jerry Chang
Detector	Peak		

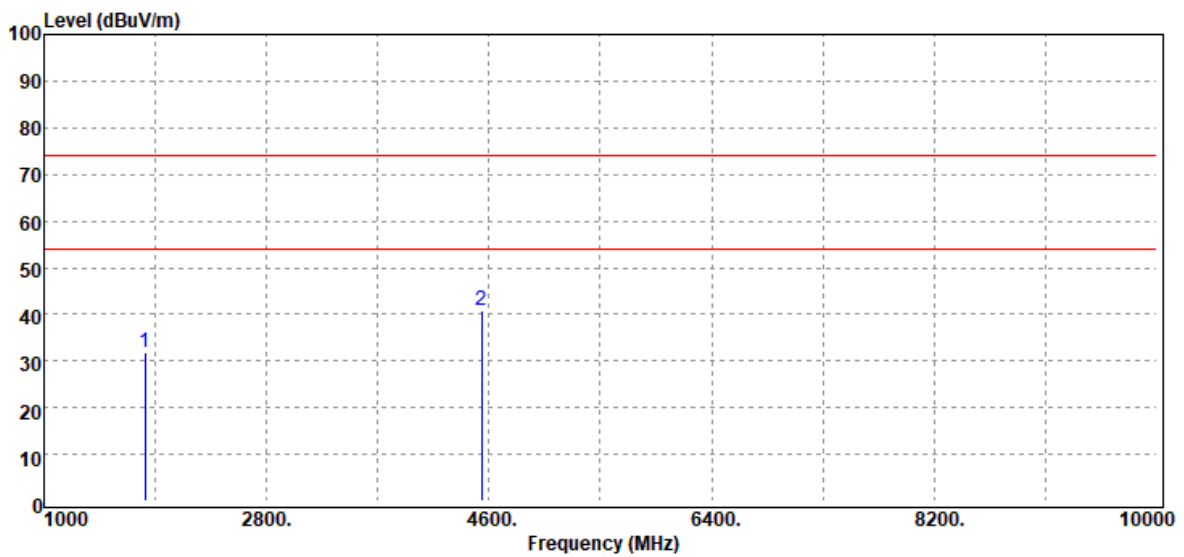

No.	Freq. MHz	Detector Mode PK/QP/AV	Spectrum Reading Level dBµV	Factor dB	Actual FS dBµV/m	Limit @3m dBµV/m	Margin dB
1	1816.84	Peak	43.02	-11.04	31.98	74.00	-42.02
2	4542.10	Peak	45.54	-4.77	40.77	74.00	-33.23
	N/A						

Remark:

1. Measuring frequencies from 1 GHz to the 10th harmonic of highest fundamental frequency.
2. For above 1GHz, the EUT peak value was under average limit, therefore the Average value compliance with the average limit

Report No.: T200528D01-RP

Test Mode:	908.42 MHz	Temp/Hum	24.6(°C)/ 51%RH
Test Item	Harmonic	Test Date	June 3, 2020
Polarize	Horizontal	Test Engineer	Jerry Chang
Detector	Peak		

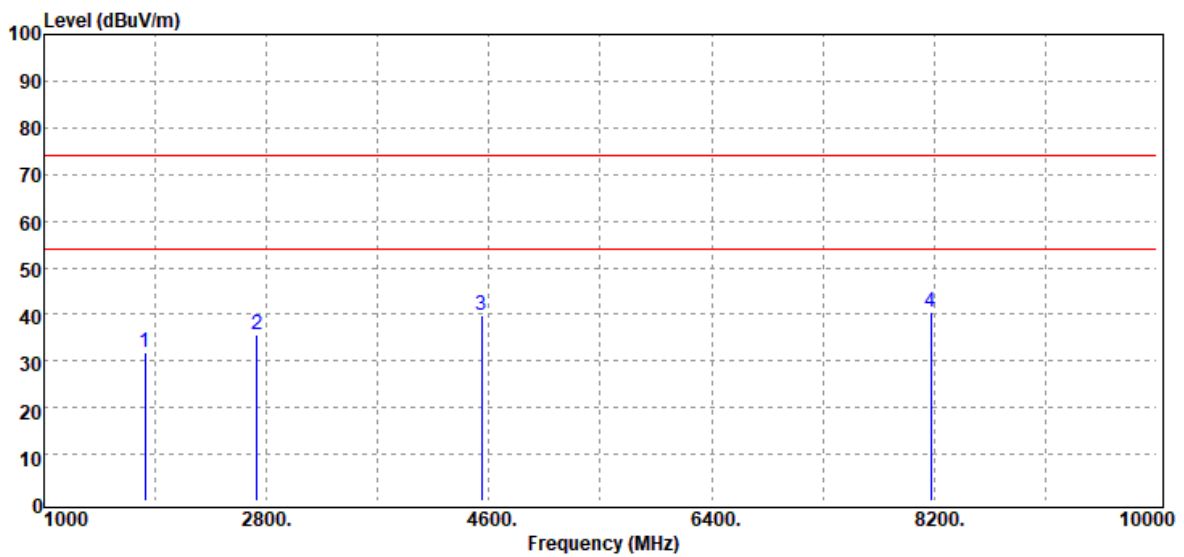

No.	Freq. MHz	Detector Mode PK/QP/AV	Spectrum Reading Level dB μ V	Factor dB	Actual FS dB μ V/m	Limit @3m dB μ V/m	Margin dB
1	1816.84	Peak	42.98	-11.04	31.94	74.00	-42.06
2	2725.26	Peak	43.99	-8.34	35.65	74.00	-38.35
3	4542.10	Peak	44.40	-4.77	39.63	74.00	-34.37
4	8175.78	Peak	40.88	-0.44	40.44	74.00	-33.56
	N/A						

Remark:

1. Measuring frequencies from 1 GHz to the 10th harmonic of highest fundamental frequency.
2. For above 1GHz, the EUT peak value was under average limit, therefore the Average value compliance with the average limit

Test Mode:	916 MHz	Temp/Hum	24.6(°C)/ 51%RH
Test Item	Harmonic	Test Date	June 3, 2020
Polarize	Vertical	Test Engineer	Jerry Chang
Detector	Peak		

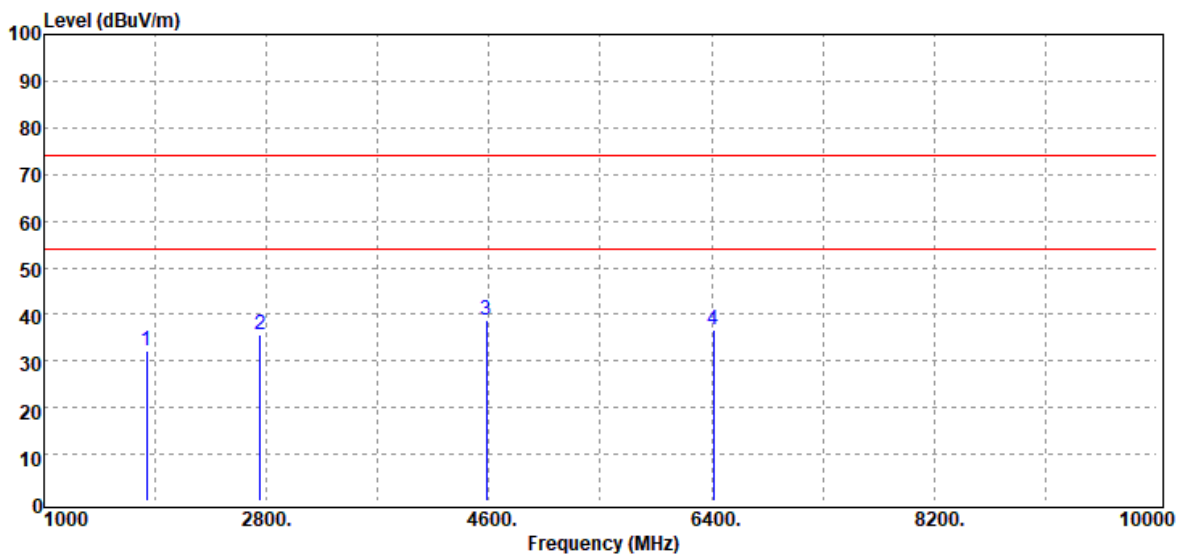

No.	Freq. MHz	Detector Mode PK/QP/AV	Spectrum Reading Level dBuV	Factor dB	Actual FS dBuV/m	Limit @3m dBuV/m	Margin dB
1	1832.00	Peak	42.97	-10.96	32.01	74.00	-41.99
2	2748.00	Peak	43.94	-8.43	35.51	74.00	-38.49
3	4580.00	Peak	43.85	-4.94	38.91	74.00	-35.09
4	6412.00	Peak	38.47	-1.69	36.78	74.00	-37.22
	N/A						

Remark:

1. Measuring frequencies from 1 GHz to the 10th harmonic of highest fundamental frequency.
2. For above 1GHz, the EUT peak value was under average limit, therefore the Average value compliance with the average limit

Test Mode:	916 MHz	Temp/Hum	24.6(°C)/ 51%RH
Test Item	Harmonic	Test Date	June 3, 2020
Polarize	Horizontal	Test Engineer	Jerry Chang
Detector	Peak		

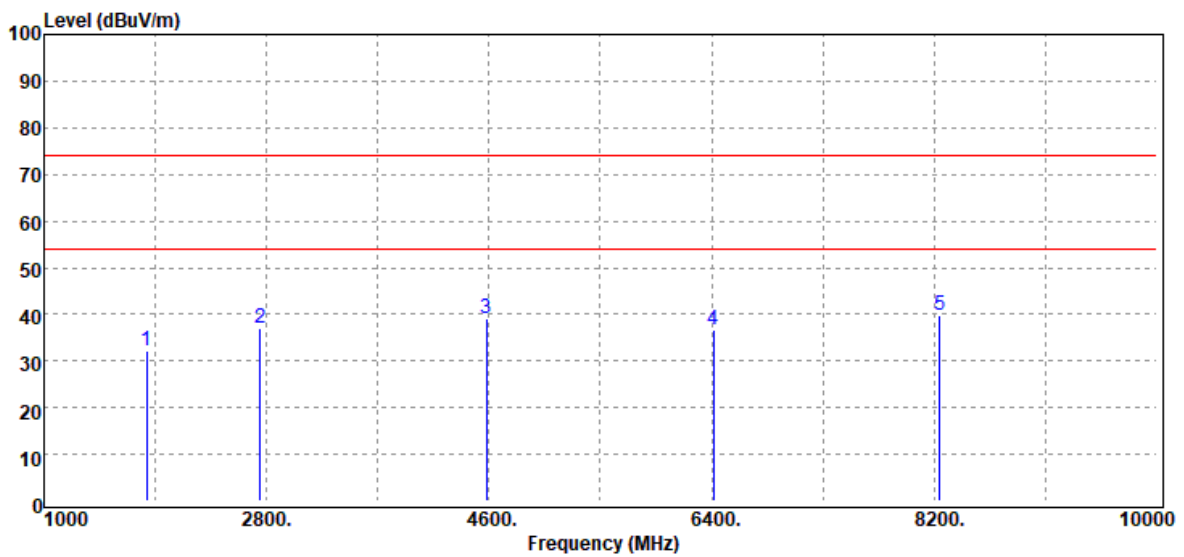

No.	Freq. MHz	Detector Mode PK/QP/AV	Spectrum Reading Level dBuV	Factor dB	Actual FS dBuV/m	Limit @3m dBuV/m	Margin dB
1	1832.00	Peak	43.06	-10.96	32.10	74.00	-41.90
2	2748.00	Peak	45.29	-8.43	36.86	74.00	-37.14
3	4580.00	Peak	43.91	-4.94	38.97	74.00	-35.03
4	6412.00	Peak	38.44	-1.69	36.75	74.00	-37.25
5	8244.00	Peak	40.25	-0.58	39.67	74.00	-34.33
	N/A						

Remark:

1. Measuring frequencies from 1 GHz to the 10th harmonic of highest fundamental frequency.
2. For above 1GHz, the EUT peak value was under average limit, therefore the Average value compliance with the average limit

--End of Report--