

FCC ID: SW8TD13000Z2
Report No.: T180528D01-RP

Page: 1 / 27
Rev.: 01

RADIO TEST REPORT

FCC 47 CFR PART 15 SUBPART C

Test Standard	FCC Part 15.249
Product name	Z-Wave In-Wall Power Monitor Switch
Brand Name	GOOD WAY
Model No.	TD13000Z2
Test Result	Pass

The test Result was tested by Compliance Certification Services Inc. The test data, data evaluation, test procedures, and equipment configurations shown in this report were given in ANSI C63.10: 2013 and compliance standards.

The test results of this report relate only to the tested sample (EUT) identified in this report.

The test Report of full or partial shall not copy. Without written approval of Compliance Certification Services Inc. (Wugu Laboratory)

Approved by:

Reviewed by:

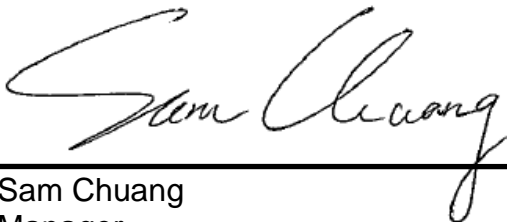

Sam Chuang
Manager



Jerry Chuang
Engineer

Unless otherwise stated the results shown in this test report refer only to the sample(s) tested and such sample(s) are retained for 90 days only.
除非另有說明，此報告結果僅對測試之樣品負責，同時此樣品僅保留90天。本報告未經本公司書面許可，不可部分複製。

This document is issued by the Company subject to its General Conditions of Service printed overleaf, available on request or accessible at www.sgs.com/terms_and_conditions.htm and for electronic format documents, subject to Terms and Conditions for Electronic Documents at www.sgs.com/terms_e-document.htm. Attention is drawn to the limitation of liability, indemnification and jurisdiction issues defined therein. Any holder of this document is advised that information contained hereon reflects the Company's findings at the time of its intervention only and within the limits of Client's instructions, if any. The Company's sole responsibility is to its Client and this document does not exonerate parties to a transaction from exercising all their rights and obligations under the transaction documents. This document cannot be reproduced except in full, without prior written approval of the Company. Any unauthorized alteration, forgery or falsification of the content or appearance of this document is unlawful and offenders may be prosecuted to the fullest extent of the law.



Report No.: T180528D01-RP

Page: 2 / 27
Rev.: 01

Revision History

Rev.	Issue Date	Revisions	Effect Page	Revised By
00	August 6, 2018	Initial Issue	ALL	May Lin
01	August 14, 2018	1. Modify the modulation type. 2. Removed the plot frame title. 3. Modify the 4.2, title. 4. Update test procedure.	P.5, P.13, P.17, P.20	May Lin



TABLE OF CONTENTS

1. GENERAL INFORMATION	4
1.1 EUT INFORMATION	4
1.2 EUT CHANNEL INFORMATION	5
1.3 ANTENNA INFORMATION	5
1.4 MEASUREMENT UNCERTAINTY	6
1.5 FACILITIES AND TEST LOCATION	7
1.6 INSTRUMENT CALIBRATION	8
1.7 SUPPORT AND EUT ACCESSORIES EQUIPMENT	9
1.8 TEST METHODOLOGY AND APPLIED STANDARDS	9
2. TEST SUMMERY	10
3. DESCRIPTION OF TEST MODES	11
3.1 THE WORST MODE OF OPERATING CONDITION	11
3.2 THE WORST MODE OF MEASUREMENT	12
3.3 EUT DUTY CYCLE	13
4. TEST RESULT	14
4.1 AC POWER LINE CONDUCTED EMISSION	14
4.2 20dB BANDWIDTH	17
4.3 RADIATION FUNDAMENTAL AND SPURIOUS EMISSION	19



Report No.: T180528D01-RP

Page: 4 / 27
Rev.: 01

1. GENERAL INFORMATION

1.1 EUT INFORMATION

Applicant	GOOD WAY TECHNOLOGY CO., LTD. 3F, No. 135, Ln. 235, Baociao Rd., Sindian Dist., New Taipei City 231, Taiwan
Equipment	Z-Wave In-Wall Power Monitor Switch
Trade Name	GOOD WAY
Model No.	TD13000Z2
Model Discrepancy	N/A
Received Date	May 28, 2018
Date of Test	May 31 ~ August 1, 2018
Power Operation	Power by AC power cord: 110-230Vac ~ 50/60Hz
RF Field Strength	90.52dBuV/m @peak

1.2 EUT CHANNEL INFORMATION

Frequency Range	916MHz
Modulation Type	GFSK
Number of channel	1 Channel

Remark:

Refer as ANSI 63.10:2013 clause 5.6.1 Table 4 for test channels

Number of frequencies to be tested		
Frequency range in which device operates	Number of frequencies	Location in frequency range of operation
<input checked="" type="checkbox"/> 1 MHz or less	1	Middle
<input type="checkbox"/> 1 MHz to 10 MHz	2	1 near top and 1 near bottom
<input type="checkbox"/> More than 10 MHz	3	1 near top, 1 near middle, and 1 near bottom

1.3 ANTENNA INFORMATION

Antenna Type	<input type="checkbox"/> PIFA <input type="checkbox"/> PCB <input type="checkbox"/> Dipole <input checked="" type="checkbox"/> Monopole
Antenna Gain	Gain: -3 dBi

1.4 MEASUREMENT UNCERTAINTY

PARAMETER	UNCERTAINTY
AC Powerline Conducted Emission	+/- 1.2575
Emission bandwidth, 20dB bandwidth	+/- 1.4003
RF output power, conducted	+/- 1.1372
Power density, conducted	+/- 1.4003
3M Semi Anechoic Chamber / 30M~200M	+/- 4.0138
3M Semi Anechoic Chamber / 200M~1000M	+/- 3.9483
3M Semi Anechoic Chamber / 1G~8G	+/- 2.5975
3M Semi Anechoic Chamber / 8G~18G	+/- 2.6112
3M Semi Anechoic Chamber / 18G~26G	+/- 2.7389
3M Semi Anechoic Chamber / 26G~40G	+/- 2.9683

Remark:

1. This uncertainty represents an expanded uncertainty expressed at approximately the 95% confidence level using a coverage factor of $k=2$
2. ISO/IEC 17025 requires that an estimate of the measurement uncertainties associated with the emissions test results be included in the report.



Report No.: T180528D01-RP

Page: 7 / 27
Rev.: 01

1.5 FACILITIES AND TEST LOCATION

All measurement facilities used to collect the measurement data are located at
No.11, Wugong 6th Rd., Wugu Dist., New Taipei City 24891, Taiwan. (R.O.C.)

Test site	Test Engineer	Remark
AC Conduction Room	Dally Hong	
Radiation	Jerry Chuang	
RF Conducted	Jerry Chuang	

Remark: The sites are constructed in conformance with the requirements of ANSI C63.7, ANSI C63.4 and CISPR Publication 22.

1.6 INSTRUMENT CALIBRATION

RF Conducted Test Site					
Name of Equipment	Manufacturer	Model	Serial Number	Calibration Date	Calibration Due
Spectrum Analyzer	R&S	FSV 40	101073	10/02/2017	10/01/2018

Wugu 966 Chamber A					
Name of Equipment	Manufacturer	Model	Serial Number	Calibration Date	Calibration Due
Bilog Antenna	Sunol Sciences	JB3	A030105	07/13/2018	07/12/2019
Cable	HUBER SUHNER	SUCOFLEX 104PEA	25157	07/31/2017	07/30/2018
Cable	HUBER SUHNER	SUCOFLEX 104PEA	20995	07/31/2017	07/30/2018
Digital Thermo-Hygro Meter	WISEWIND	1206	D07	02/08/2018	02/07/2019
double Ridged Guide Horn Antenna	ETC	MCTD 1209	DRH13M02003	08/25/2017	08/24/2018
Loop Ant	COM-POWER	AL-130	121051	03/21/2018	03/20/2019
Pre-Amplifier	EMEC	EM330	060609	07/31/2017	07/30/2018
Pre-Amplifier	HP	8449B	3008A00965	07/28/2017	07/27/2018
PSA Series Spectrum Analyzer	Agilent	E4446A	MY46180323	05/31/2018	05/30/2019
Antenna Tower	CCS	CC-A-1F	N/A	N.C.R	N.C.R
Controller	CCS	CC-C-1F	N/A	N.C.R	N.C.R
Turn Table	CCS	CC-T-1F	N/A	N.C.R	N.C.R

Conducted Emission Room # B					
Name of Equipment	Manufacturer	Model	Serial Number	Calibration Date	Calibration Due
CABLE	EMCI	CFD300-NL	CERF	07/04/2017	07/03/2018
LISN	R&S	ENV216	101054	02/06/2018	02/05/2019
LISN	SCHWARZBECK	NSLK 8127	8127-541	02/09/2018	02/08/2019
EMI Test Receiver	R&S	ESCI	101203	11/02/2017	11/01/2018

Remark: Each piece of equipment is scheduled for calibration once a year.



Report No.: T180528D01-RP

Page: 9 / 27
Rev.: 01

1.7 SUPPORT AND EUT ACCESSORIES EQUIPMENT

EUT Accessories Equipment					
No.	Equipment	Brand	Model	Series No.	FCC ID
	N/A				

Support Equipment					
No.	Equipment	Brand	Model	Series No.	BSMI ID
	N/A				

1.8 TEST METHODOLOGY AND APPLIED STANDARDS

The test methodology, setups and results comply with all requirements in accordance with ANSI C63.10:2013, FCC Part 15.249, FCC Part 15.215, FCC Part 15.209, FCC Part 15.205.



Report No.: T180528D01-RP

Page: 10 / 27
Rev.: 01

2. TEST SUMMERY

FCC Standard Section	Report Section	Test Item	Result
15.203	1.3	Antenna Requirement	Pass
15.207(a)	4.1	AC Conducted Emission	Pass
15.215(c)	4.2	20 dB Bandwidth	Pass
15.249(a)	4.3	Field strength of the fundamental signal	Pass
15.249(a) /15.209	4.3	Radiation Spurious Emission	Pass



Report No.: T180528D01-RP

Page: 11 / 27
Rev.: 01

3. DESCRIPTION OF TEST MODES

3.1 THE WORST MODE OF OPERATING CONDITION

Operation mode	Z-wave
Test Channel Frequencies	916 MHz

Remark:

1. EUT pre-scanned data rate of output power for each mode, the worst data rate were recorded in this report.

3.2 THE WORST MODE OF MEASUREMENT

AC Power Line Conducted Emission	
Test Condition	AC Power line conducted emission for line and neutral
Power supply Mode	Mode 1: EUT power by AC power cord
Worst Mode	<input checked="" type="checkbox"/> Mode 1 <input type="checkbox"/> Mode 2 <input type="checkbox"/> Mode 3 <input type="checkbox"/> Mode 4

Radiated Emission Measurement Above 1G	
Test Condition	Band edge, Emission for Unwanted and Fundamental
Power supply Mode	Mode 1: EUT power by AC power cord
Worst Mode	<input checked="" type="checkbox"/> Mode 1 <input type="checkbox"/> Mode 2 <input type="checkbox"/> Mode 3 <input type="checkbox"/> Mode 4
Worst Position	<input type="checkbox"/> Placed in fixed position. <input type="checkbox"/> Placed in fixed position at X-Plane (E2-Plane) <input checked="" type="checkbox"/> Placed in fixed position at Y-Plane (E1-Plane) <input type="checkbox"/> Placed in fixed position at Z-Plane (H-Plane)
Worst Polarity	<input checked="" type="checkbox"/> Horizontal <input type="checkbox"/> Vertical

Radiated Emission Measurement Below 1G	
Test Condition	Radiated Emission Below 1G
Power supply Mode	Mode 1: EUT power by AC power cord
Worst Mode	<input checked="" type="checkbox"/> Mode 1 <input type="checkbox"/> Mode 2 <input type="checkbox"/> Mode 3 <input type="checkbox"/> Mode 4

Remark:

- 1. The worst mode was record in this test report.*
- 2. EUT pre-scanned in three axis, X, Y, Z and two polarity, Horizontal and Vertical for radiated measurement. The worst case (Y-Plane and Horizontal) were recorded in this report*
- 3. AC power line conducted emission and for below 1G radiation emission were performed the EUT transmit at the highest output power channel as worse case.*

3.3 EUT DUTY CYCLE

Duty Cycle				
Configuration	TX ON (ms)	TX ALL (ms)	Duty Cycle (%)	Duty Factor(dB)
916MHz	1.0000	1.0000	100.00%	0.00

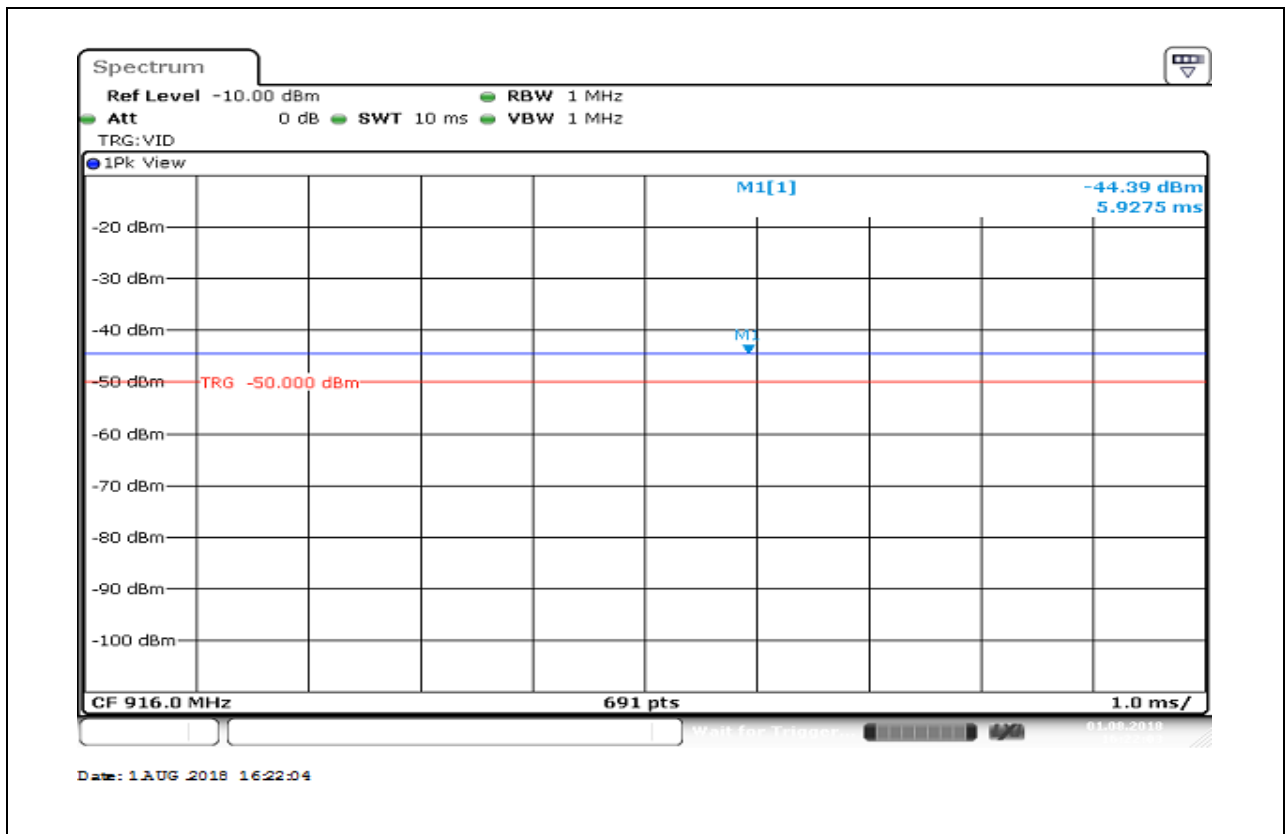

Report No.: T180528D01-RP

4. TEST RESULT

4.1 AC POWER LINE CONDUCTED EMISSION

4.1.1 Test Limit

According to §15.207(a),

Frequency Range (MHz)	Limits(dB μ V)	
	Quasi-peak	Average
0.15 to 0.50	66 to 56*	56 to 46*
0.50 to 5	56	46
5 to 30	60	50

* Decreases with the logarithm of the frequency.

4.1.2 Test Procedure

Test method Refer as ANSI 63.10:2013 clause 6.2,

1. The EUT was placed on a non-conducted table, which is 0.8m above horizontal ground plane and 0.4m above vertical ground plane.
2. EUT connected to the line impedance stabilization network (LISN)
3. Receiver set RBW of 9kHz and Detector Peak, and note as quasi-peak and average.
4. Maximum procedure was performed on the six highest emissions to ensure EUT compliance.
5. Recorded Line for Neutral and Line.

4.1.3 Test Setup

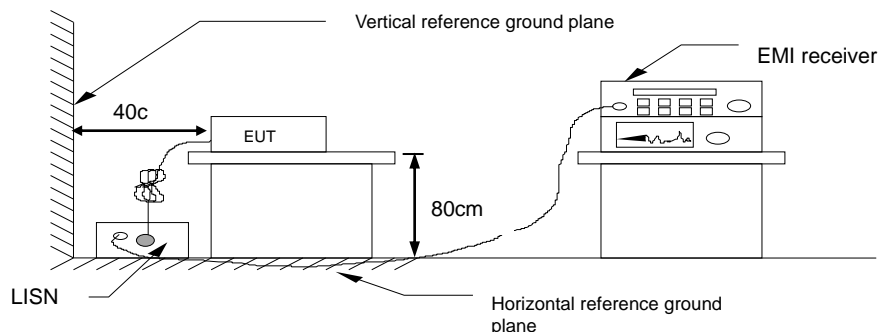

4.1.4 Test Result

PASS

Test Data

Test Mode:	Mode 1	Temp/Hum	24(°C)/ 50%RH
Phase:	Line	Test Date	May 31, 2018
		Test Engineer	Dally Hong

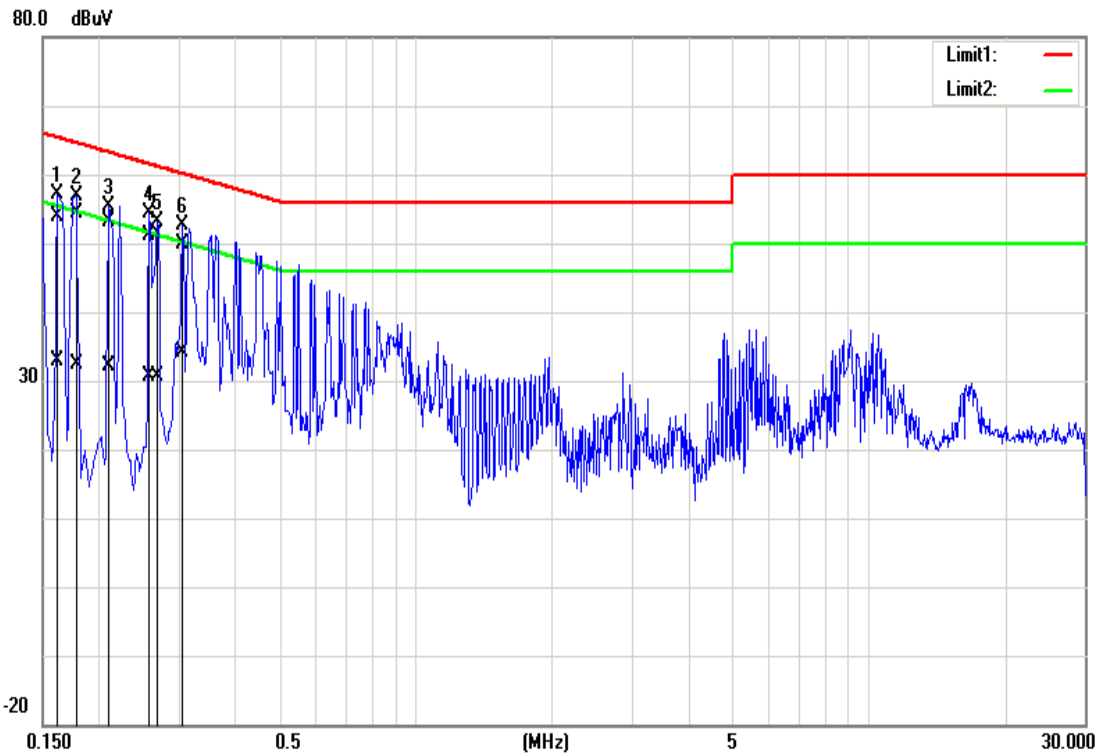

Frequency (MHz)	Quasi Peak reading (dBuV)	Average reading (d uV)	Correction factor (dB)	Quasi Peak result (dBuV)	Average result (dBuV)	Quasi Peak limit (dBuV)	Average limit (dBuV)	Quasi Peak margin (dB)	Average margin (dB)	Remark
0.1620	53.79	32.76	0.11	53.90	32.87	65.36	55.36	-11.46	-22.49	Pass
0.1780	54.22	32.21	0.11	54.33	32.32	64.58	54.58	-10.25	-22.26	Pass
0.2100	52.91	31.91	0.11	53.02	32.02	63.21	53.21	-10.19	-21.19	Pass
0.2580	50.95	30.60	0.11	51.06	30.71	61.50	51.50	-10.44	-20.79	Pass
0.2701	51.22	30.47	0.11	51.33	30.58	61.11	51.11	-9.78	-20.53	Pass
0.3060	49.74	34.08	0.12	49.86	34.20	60.08	50.08	-10.22	-15.88	Pass

Test Mode:	Mode 1	Temp/Hum	24(°C)/ 50%RH
Phase:	Neutral	Test Date	May 31, 2018
		Test Engineer	Dally Hong

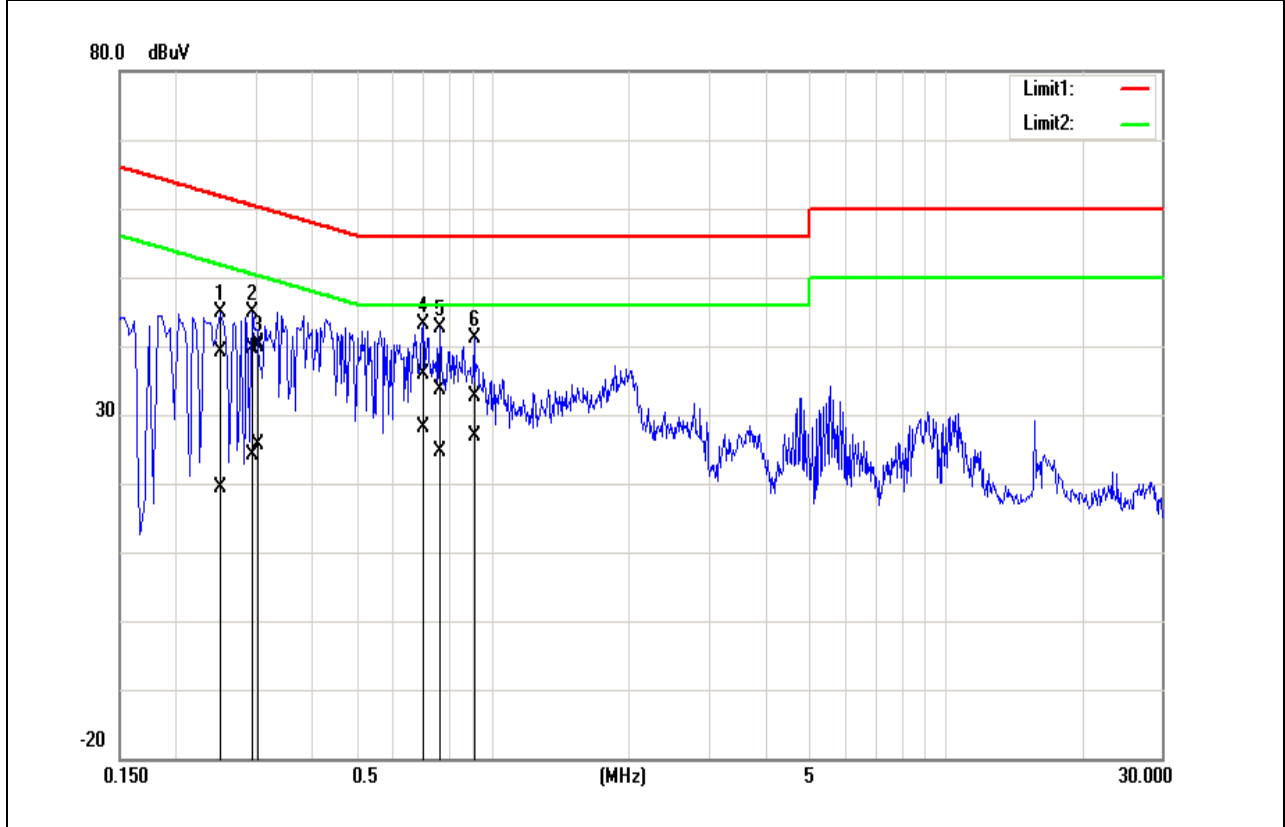

Frequency (MHz)	Quasi Peak reading (dBuV)	Average reading (dBuV)	Correction factor (dB)	Quasi Peak result (dBuV)	Average result (dBuV)	Quasi Peak limit (dBuV)	Average limit (dBuV)	Quasi Peak margin (dB)	Average margin (dB)	Remark
0.2500	39.03	19.30	0.13	39.16	19.43	61.76	51.76	-22.60	-32.33	Pass
0.2940	39.57	24.06	0.13	39.70	24.19	60.41	50.41	-20.71	-26.22	Pass
0.3060	39.75	25.61	0.13	39.88	25.74	60.08	50.08	-20.20	-24.34	Pass
0.7020	35.78	27.90	0.14	35.92	28.04	56.00	46.00	-20.08	-17.96	Pass
0.7660	33.41	24.61	0.14	33.55	24.75	56.00	46.00	-22.45	-21.25	Pass
0.9100	32.52	26.64	0.14	32.66	26.78	56.00	46.00	-23.34	-19.22	Pass

4.2 20dB BANDWIDTH

LIMIT

None; for reporting purposes only.

Test Configuration

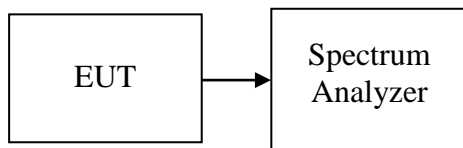

TEST PROCEDURE

1. Place the EUT on the table and set it in the transmitting mode.
2. Remove the antenna from the EUT and then connect a low loss RF cable from the antenna port to the spectrum analyzer.
3. Set the spectrum analyzer as RBW=100kHz, VBW = 300kHz, Span = 1MHz, Sweep = auto.
4. Mark the peak frequency and 20dB (upper and lower) frequency.
5. Repeat until all the rest channels are investigated.

TEST RESULTS

No non-compliance noted

Test Data

Frequency (MHz)	20dB Bandwidth (kHz)
916	125.9

Test Plot

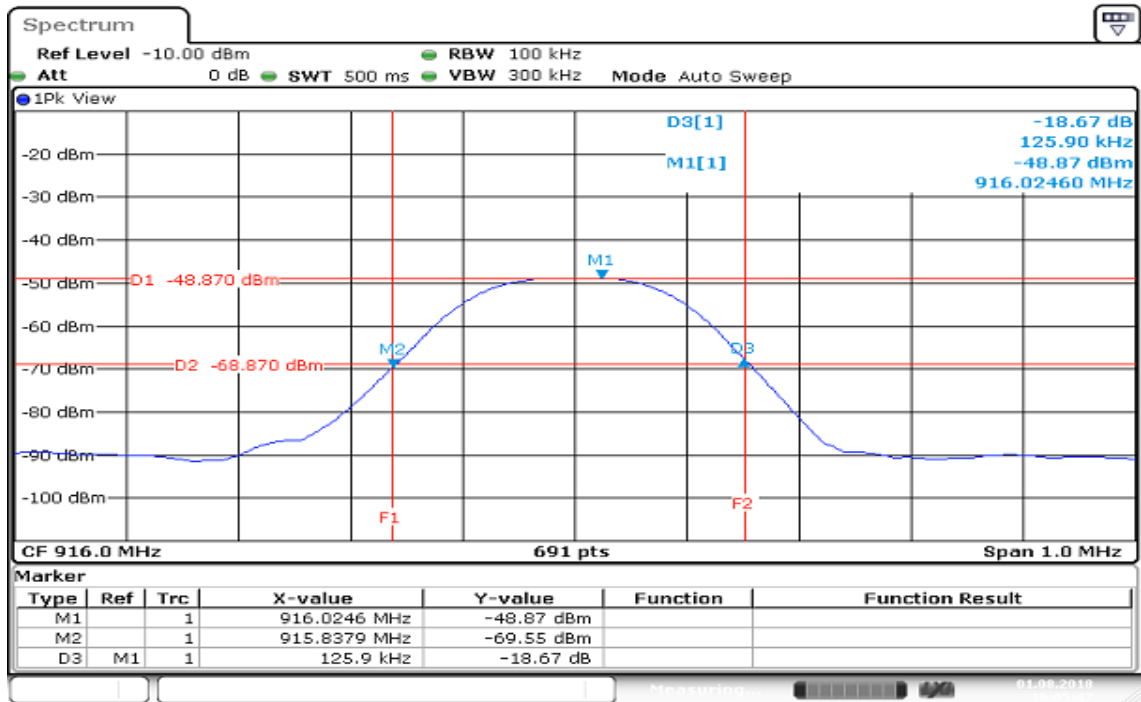

Date: 1 AUG 2018 16:05:47

4.3 RADIATION FUNDAMENTAL AND SPURIOUS EMISSION

4.3.1 Test Limit

According to §15.249(a), the field strength of emissions from intentional radiators operated within these frequency bands shall comply with the follow:

Fundamental frequency	Field strength of fundamental (millivolts/meter)	Field strength of harmonics (microvolts/meter)
902-928 MHz	50	500
2400-2483.5 MHz	50	500
5725-5875 MHz	50	500
24.0-24.25 GHz	250	2500

According to §15.249(d), Emission Radiated outside of specified frequency bands, except for harmonics, shall be attenuated by at 50dB below the level of the fundamental or to the general radiated emission limits in section §15.209.

According to §15.249(e), for frequencies above 1000 MHz, the above field strength limits are based on average limits. The peak field strength of any emission shall not exceed the maximum permitted average limits specified above by more than 20 dB under any condition of modulation.

Below 30 MHz

Frequency	Field Strength (microvolts/m)	Magnetic H-Field (microamperes/m)	Measurement Distance (metres)
9-490 kHz	2,400/F (F in kHz)	2,400/F (F in kHz)	300
490-1,705 kHz	24,000/F (F in kHz)	24,000/F (F in kHz)	30
1.705-30 MHz	30	N/A	30

Above 30 MHz

Frequency (MHz)	Field Strength microvolts/m at 3 metres (watts, e.i.r.p.)	
	Transmitters	Receivers
30-88	100 (3 nW)	100 (3 nW)
88-216	150 (6.8 nW)	150 (6.8 nW)
216-960	200 (12 nW)	200 (12 nW)
Above 960	500 (75 nW)	500 (75 nW)

Remark:

Although these tests were performed other than open area test site, adequate comparison measurements were confirmed against 30 m open area test site. Therefore sufficient tests were made to demonstrate that the alternative site produces results that correlate with the ones of tests made in an open field based on KDB 937606.

4.3.2 Test Procedure

1. The EUT is placed on a turntable, Above 1 GHz is 1.5m and below 1 GHz is 0.8m above ground plane. The EUT Configured un accordance with ANSI C63.10, and the EUT set in a continuous mode.

2. The turntable shall be rotated for 360 degrees to determine the position of maximum emission level. And EUT is set 3m away from the receiving antenna, which is scanned from 1m to 4m above the ground plane to find out the highest emissions. Measurement are made polarized in both the vertical and the horizontal positions with antenna.

3. Span shall wide enough to full capture the emission measured. The SA from 9kHz to 26.5GHz set to the low, Mid and High channels with the EUT transmit.

Note: No emission found between lowest internal used/generated frequency to 30MHz(9KHz~30MHz)

4. The SA setting following :

(1) Below 1G : RBW = 100kHz, VBW \geq 3 RBW, Sweep = Auto, Detector = Peak, Trace = Max hold.

(2) Above 1G :

(2.1) For Peak measurement : RBW = 1MHz, VBW \geq 3 RBW, Sweep = Auto, Detector = Peak, Trace = Max hold.

(2.2) For Average measurement : RBW = 1MHz, VBW

·If Duty Cycle \geq 98%, VBW=10Hz.

·If Duty Cycle < 98%, VBW \geq 1/T.

Configuration	Duty Cycle (%)	T(ms)	1/T (Hz)	VBW setting
916 MHz	100%	1.0000	-	10Hz

4.3.3 Test Setup

9kHz ~ 30MHz

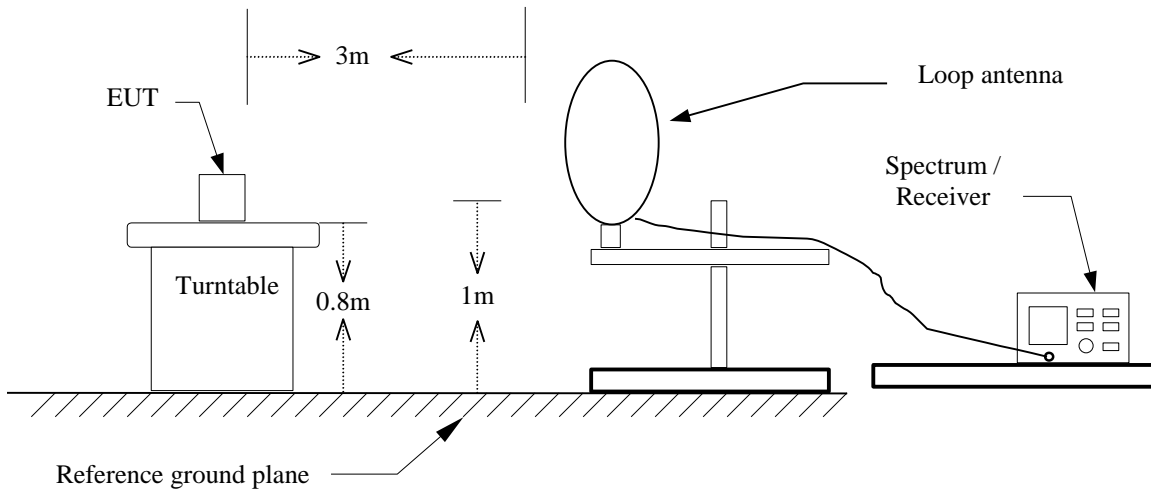

30MHz ~ 1GHz

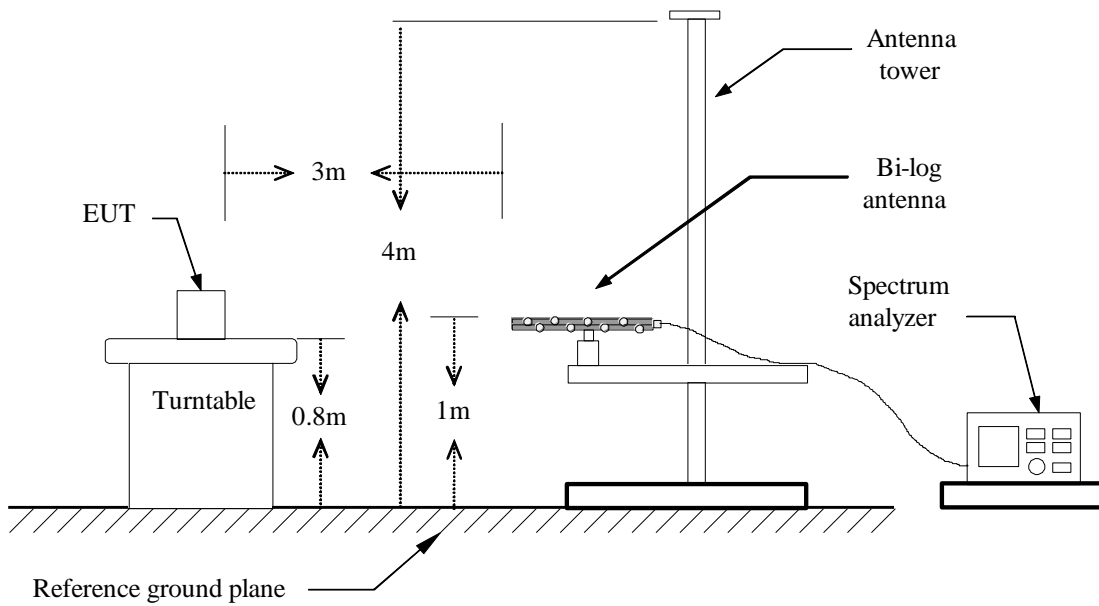

Above 1 GHz

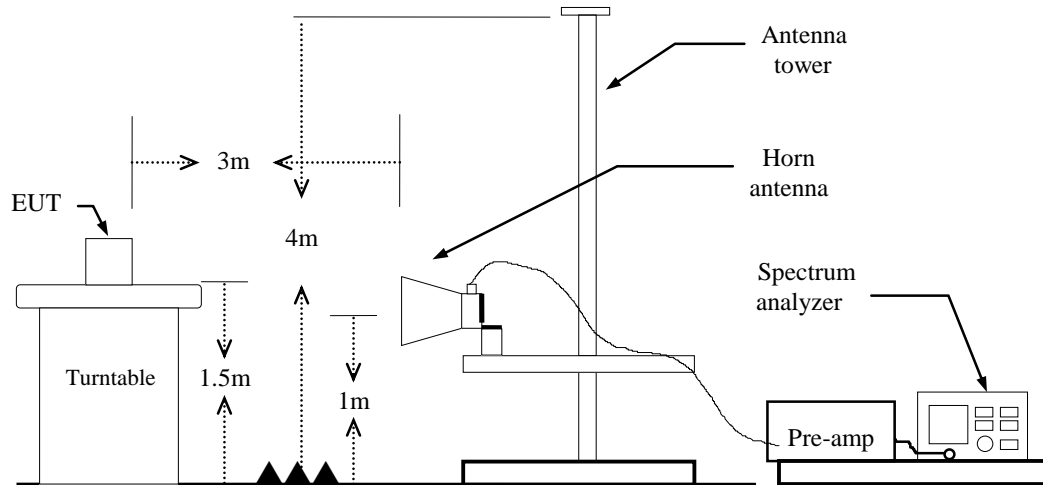

Radiation Fundamental

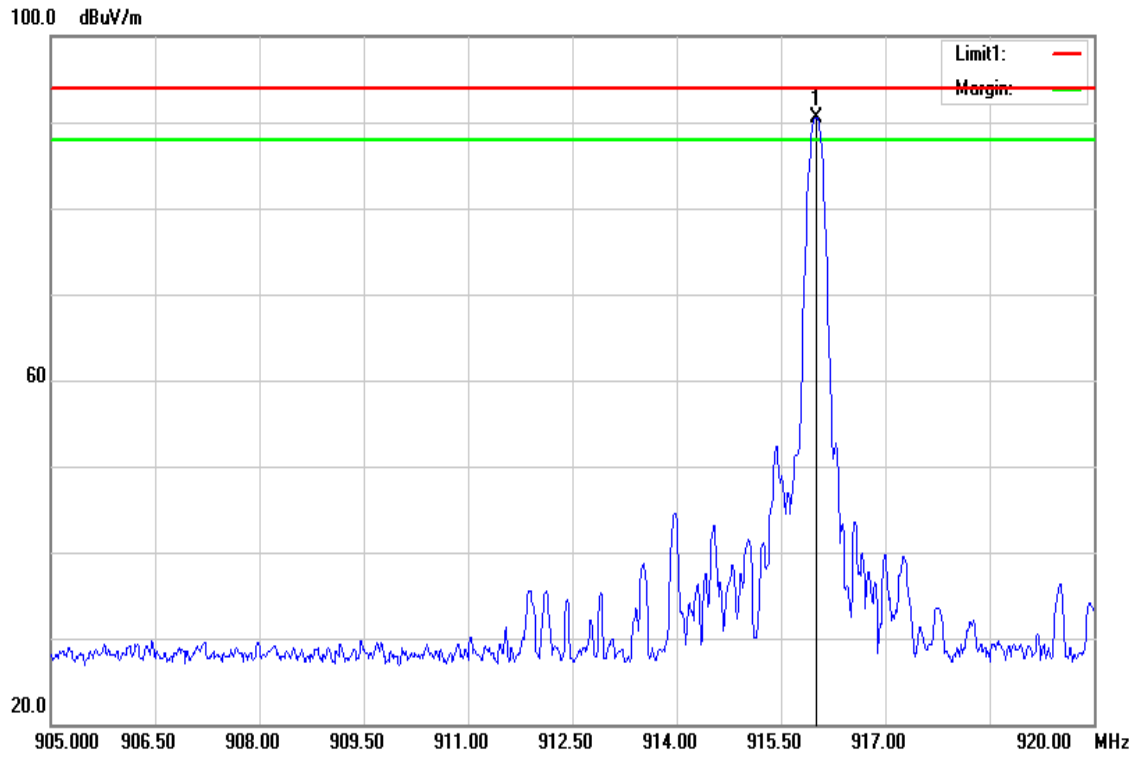

No.	Frequency (MHz)	Reading (dBuV)	Correct Factor(dB/m)	Result (dBuV/m)	Limit (dBuV/m)	Margin (dB)	Remark
1	916.0100	85.86	4.66	90.52	93.97	-3.45	peak

Report No.: T180528D01-RP

Below 1G Test Data

Test Mode:	916MHz	Temp/Hum	22(°C)/ 34%RH
Test Item	30MHz-1GHz	Test Date	July 20, 2018
Polarize	Vertical	Test Engineer	Jerry Chuang
Detector	Peak		

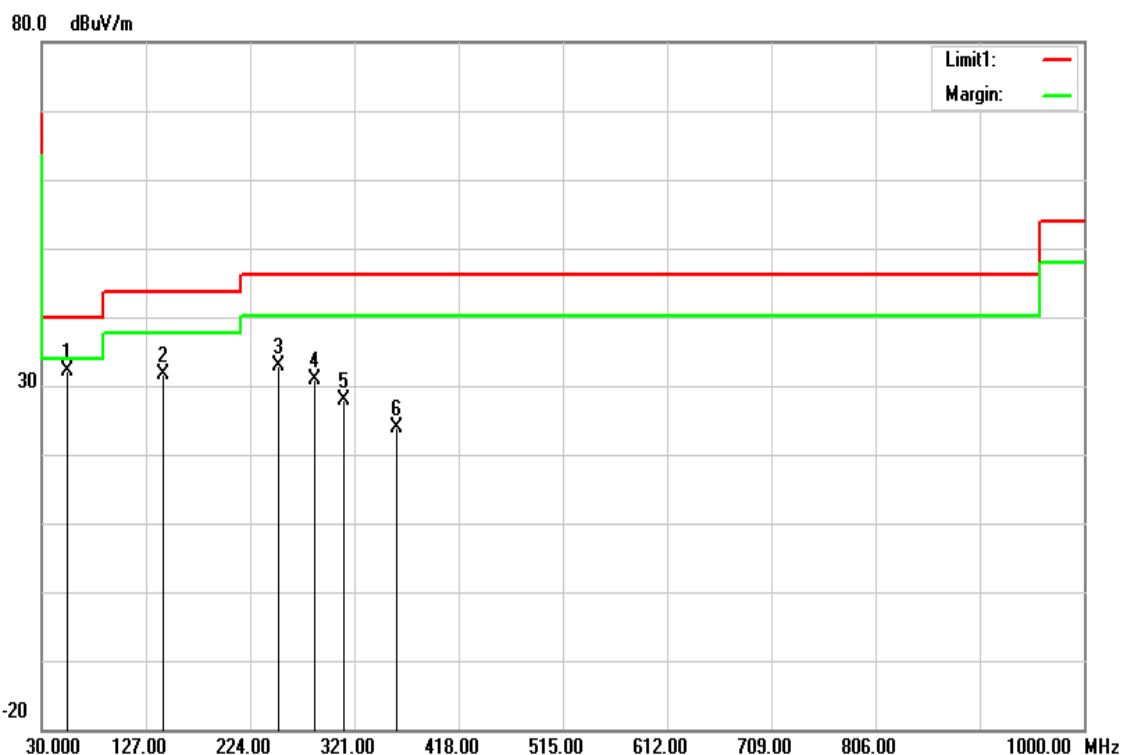

No.	requency (MHz)	Reading (dBuV)	Correct Factor(dB/m)	Result (dBuV/m)	Limit (dBuV/m)	Margin (dB)	Remark
1	54.2500	47.45	-15.34	32.11	40.00	-7.89	peak
2	143.4900	41.27	-9.71	31.56	43.52	-11.96	peak
3	250.1900	42.58	-9.82	32.76	46.02	-13.26	peak
4	284.1400	39.11	-8.13	30.98	46.02	-15.04	peak
5	311.3000	35.48	-7.71	27.77	46.02	-18.25	peak
6	359.8000	30.31	-6.48	23.83	46.02	-22.19	peak

Test Mode:	916MHz	Temp/Hum	22(°C)/ 34%RH
Test Item	30MHz-1GHz	Test Date	July 20, 2018
Polarize	Horizontal	Test Engineer	Jerry Chuang
Detector	Peak		

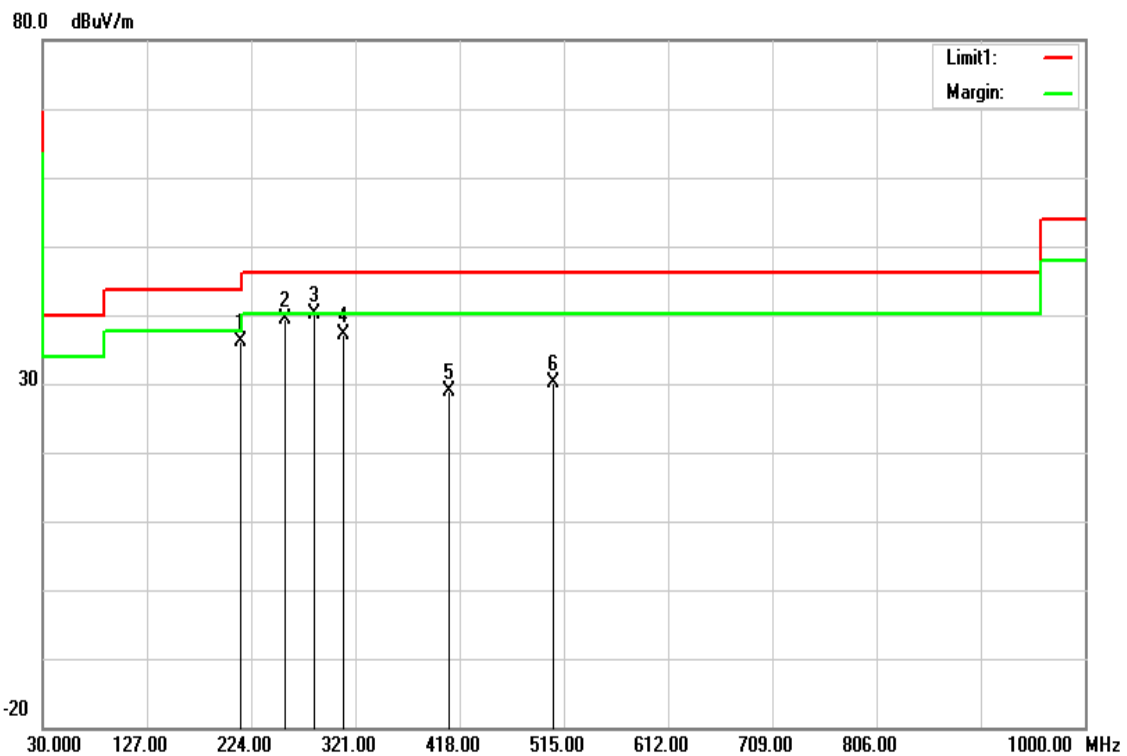

No.	Frequency (MHz)	Reading (dBuV)	Correct Factor(dB/m)	Result (dBuV/m)	Limit (dBuV/m)	Margin (dB)	Remark
1	214.3000	46.78	-10.65	36.13	43.52	-7.39	peak
2	255.0400	49.05	-9.67	39.38	46.02	-6.64	peak
3	283.1700	48.19	-8.14	40.05	46.02	-5.97	peak
4	310.3300	44.84	-7.72	37.12	46.02	-8.90	peak
5	408.3000	33.79	-5.03	28.76	46.02	-17.26	peak
6	505.3000	32.61	-2.50	30.11	46.02	-15.91	peak

Above 1G Test Data

Test Mode:	916MHz	Temp/Hum	22(°C)/ 34%RH
Test Item	Harmonic	Test Date	July 23, 2018
Polarize	Vertical	Test Engineer	Jerry Chuang
Detector	Peak and Average		

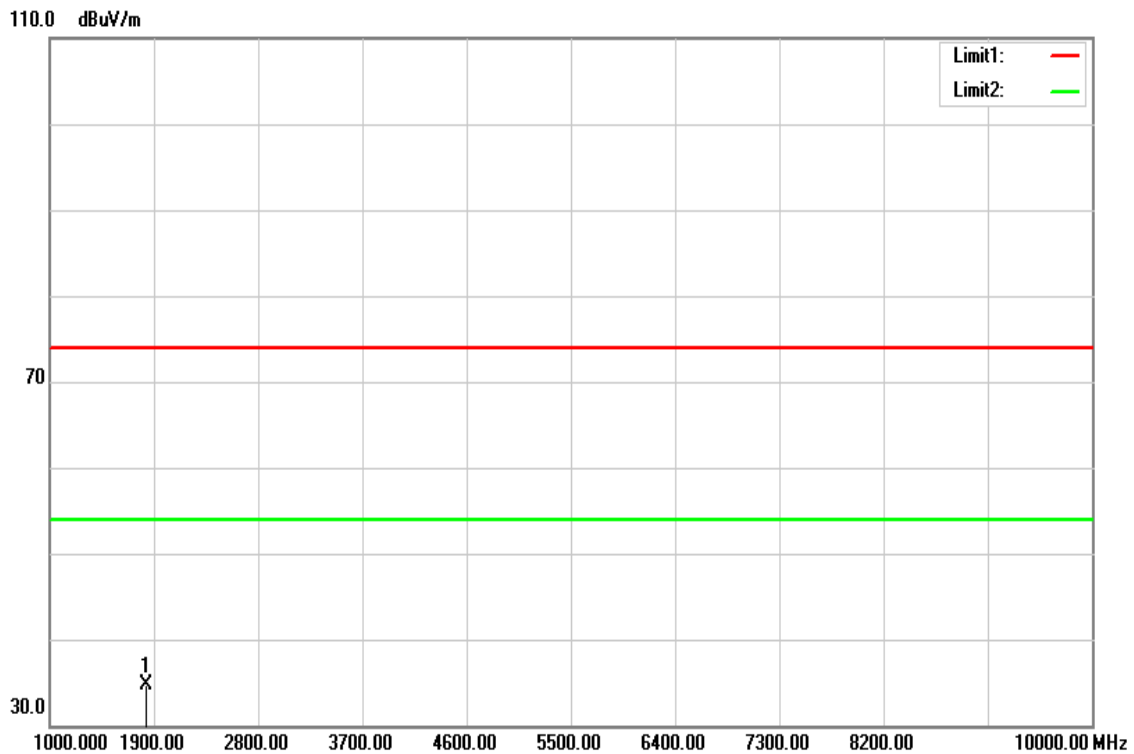

No.	Frequency (MHz)	Reading (dBuV)	Correct Factor(dB/m)	Result (dBuV/m)	Limit (dBuV/m)	Margin (dB)	Remark
1	1832.000	40.16	-5.37	34.79	74.00	-39.21	peak

Remark:

1. Measuring frequencies from 1 GHz to the 10th harmonic of highest fundamental frequency.
2. For above 1GHz, the EUT peak value was under average limit, therefore the Average value compliance with the average limit

Test Mode:	916MHz	Temp/Hum	22(°C)/ 34%RH
Test Item	Harmonic	Test Date	July 23, 2018
Polarize	Horizontal	Test Engineer	Jerry Chuang
Detector	Peak and Average		

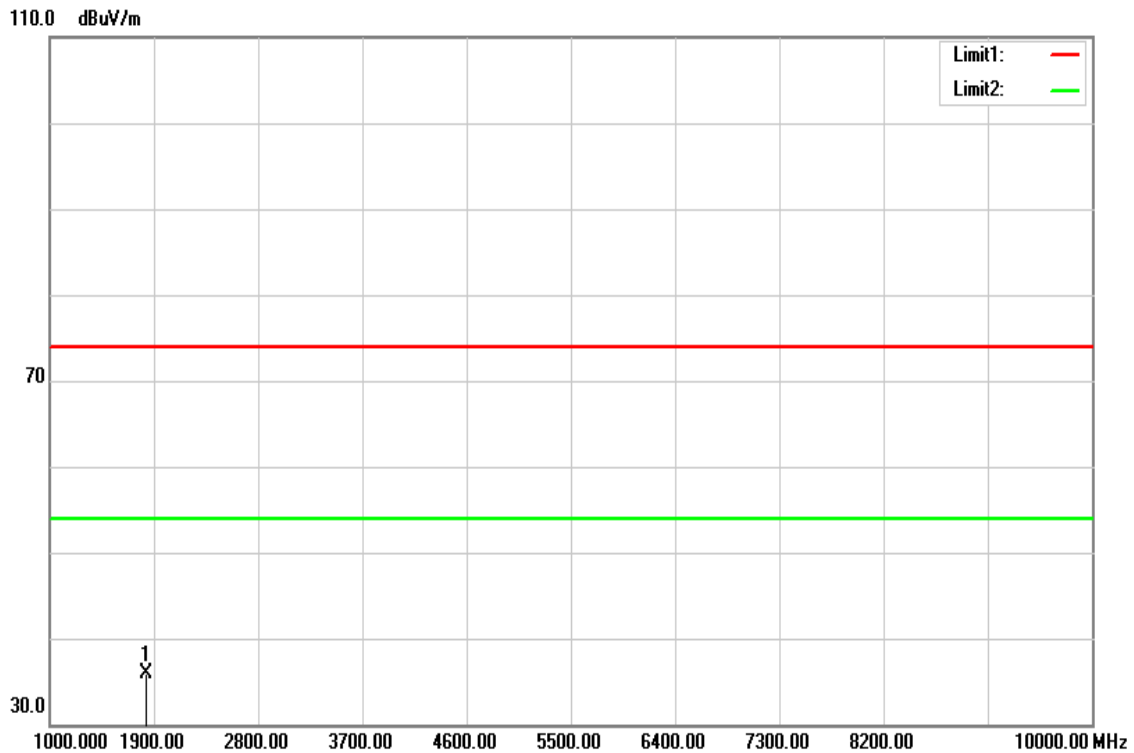

No.	Frequency (MHz)	Reading (dBuV)	Correct Factor(dB/m)	Result (dBuV/m)	Limit (dBuV/m)	Margin (dB)	Remark
1	1832.000	41.24	-5.37	35.87	74.00	-38.13	peak

Remark:

1. Measuring frequencies from 1 GHz to the 10th harmonic of highest fundamental frequency.
2. For above 1GHz, the EUT peak value was under average limit, therefore the Average value compliance with the average limit

--End of Report--