

DAIKIN ZONING KIT

DAIKIN ZONING KIT



Main & Wireless Thermostat User's Manual

SUMMARY

1.	WARNINGS AND ENVIRONMENTAL POLICY.....	4
	1.1 SAFETY CONSIDERATIONS.....	4
	1.2 ENVIRONMENTAL POLICY.....	4
	1.3 FCC Regulatory Notices	5
2.	GETTING STARTED	5
3.	MAIN THERMOSTAT	6
	3.1 Home Screen Display	6
	3.2 Using you Main Thermostat	8
	3.2.1 Adjusting the temperature.....	8
	3.2.2 Operation Mode	8
	3.2.3 Cleaning the Main Thermostat.....	9
	3.2.4 Thermostat Help Screens	9
	3.3 Time Schedule Programming.....	13
	3.3.1 Time schedule programming activation	13
	3.3.2 Create a new time scheduled program	14
	3.3.3 Using the Time Schedule Programming editor:.....	14
	3.4 Remote zone control.....	15
	3.4.1 Remote control.....	15
	3.4.2 Edit Name Zone	15
	3.5. Eco-Adapt	16
	3.5.1 Description	16
	3.5.2 Eco-Adapt menu	16
	3.6 Configuring your Main Thermostat.....	17
	3.6.1 Interface.....	17
	3.6.2 User settings.....	18
	3.7 Understanding the Alerts.....	19
	3.7.1 DZK Zoning system Alerts	19
4.	WIRELESS THERMOSTAT	20
	4.1 Home Screen Display	20
	4.2 Idle Screen.....	19
	4.3 Using your Wireless Thermostat	23
	4.3.1 Adjusting the temperature.....	23
	4.3.2 Low batteries.....	23
	4.3.3 Cleaning the Wireless thermostat	24
	4.4. Advanced functions in your Wireless Thermostat	24
	4.4.1 Time Schedule Programming.....	24
	4.4.2 Local Ventilation.....	24
	4.4.3 Sleep Mode.....	25
	4.5. Remote zone control.....	26
	4.6. Wireless Thermostat Configuraion	27
	4.7 Understanding the Alerts.....	27
	4.7.1 List of DZK system alerts	27
5.	NAVIGATION GUIDES	25
	5.1 Main Thermostat navigation guide	25
	5.2 Wireless Themostat navigation guide	26
6.	TROUBLESHOOTING	27

1. WARNINGS AND ENVIRONMENTAL POLICY

1.1 SAFETY CONSIDERATIONS

For personal safety and protection of the equipment, use the following safety precautions:

- Do not handle the system with wet or damp hands.
- Disconnect the power supply before making any connections.
- Disconnect the power supply from the air conditioning and heating system before connecting or disconnecting equipment.
- Take care not to cause a short circuit in any of the system's connections.

1.2 ENVIRONMENTAL POLICY



Do not dispose of this equipment with household waste. Electrical and electronic equipment contain substances that may damage the environment if not handled appropriately. The symbol of a crossed-out waste bin indicates electrical equipment that must be disposed separately from other urban waste. For correct environmental management, it must be taken to the collection centers provided for this purpose when it is no longer usable.

Equipment components may be recycled. Act in accordance with current regulations on environmental protection.

If you replace it with other equipment, you must return it to the distributor or take it to a specialized collection center.

Those breaking the law or by-laws will be subjected to environmental protection fines.

1.3. FCC Regulatory Notices

Modification statement

Corporacion Empresarial Altra S.L. has not approved any changes or modifications to this device by the user. Any changes or modifications could void the user's authority to operate the equipment.

Interference statement:

This device complies with Part 15 of the FCC Rules. Operation is subject to the following two conditions: (1) this device may not cause interference, and (2) this device must accept any interference, including interference that may cause undesired operation of the device.

Radiation Exposure Statement

This device complies with FCC radiation exposure limits set forth for an uncontrolled environment and meets the FCC radio frequency (RF) Exposure Guidelines in Supplement C to OET65 This transmitter must not be co-located or operating in conjunction with any other antenna or transmitter.

FCC Class B digital device notice

This equipment has been tested and found to comply with the limits for a Class B digital device, pursuant to part 15 of the FCC Rules. These limits are designed to provide reasonable protection against harmful interference in a residential installation. This equipment generates, uses and can radiate radio frequency energy and, if not installed and used in accordance with the instructions, may cause harmful interference to radio communications. However, there is no guarantee that interference will not occur in a particular installation. If this equipment does cause harmful interference to radio or television reception, which can be determined by turning the equipment off and on, the user is encouraged to try to correct the interference by one or more of the following measures:

- Reorient or relocate the receiving antenna.
- Increase the separation between the equipment and receiver.
- Connect the equipment into an outlet on a circuit different from that to which the receiver is connected.
- Consult the dealer or an experienced radio/TV technician for help.

2. GETTING STARTED

Main Thermostat



Key features of the Main Thermostat

- Color display.
- Precision +/- 1°F (0.5°C) temperature control.
- Dual set.
- Auto changeover mode.
- Remote zone control.
- Vacation programming.
- Seven day programming.
- Automatic adjustment for Daylight Savings Time (DST).

Wireless Thermostat



Key features of the Wireless Thermostat

- Backlit LCD display.
- Precision +/- 1°F (0.5°C) temperature control.
- Dual set point - Remote zone control.

3. MAIN THERMOSTAT

The Main Thermostat has an user-friendly color screen that displays all the information you need to set and manage your DZK Zoning unit.

3.1 Home Screen Display

The Main Screen options for the Main Thermostat are:

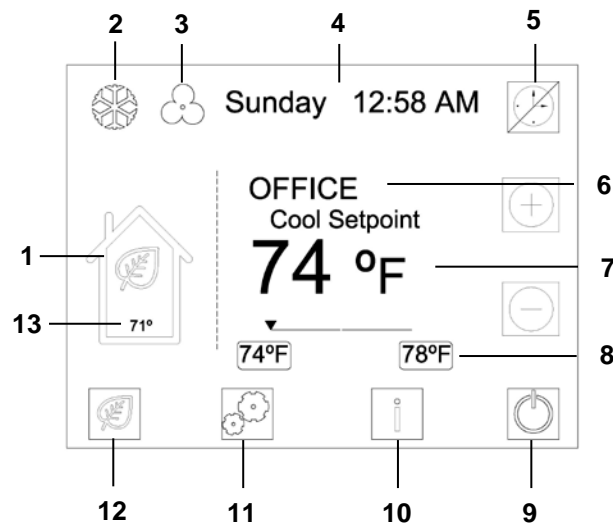

Home Screen

To access Eco-Adapt menu

- Press to access.

1. Eco-Adapt & Efficiency Indicator

The energy efficiency level is indicated by color and is a function of temperature and the Eco-Adapt system.

- Green: High Energy Efficiency
- Yellow: Medium-High Energy Efficiency
- Orange: Medium-Low Energy Efficiency
- Red: Low Energy Efficiency

See Eco-Adapt mode on page 16.

To access Operation Mode

- Press Operation mode icon to access.

2. Operation Mode

The current mode of temperature control: Stop, Heat, Cool, Dry, Emergency Heat, or Automatic. See Operation Mode on page 11.

To change Local Ventilation Value

- Press to change.

3. Local ventilation

This option allows activation (White icon) or deactivation (Grey icon) of the ventilation in the selected zone during system inactivity periods.

See Local Ventilation on page 19.

4. Current day and time

Displays the current day and time for your time zone.

5. Time schedule programming

This option allows activating  or deactivating  the Time schedule programming on the Main Thermostat.



See Time schedule programming on page 13.

6. Current Zone

Displays the current zone and allows access to remote zone control. See Remote Zone Control on page 15.

7. Current Set point

The programmed temperature for a zone to maintain during a particular timeframe.

Press  (Up) or  (Down) to manually adjust by increments of 1°F (0.5°C).

If the system is set to Auto, press the set point temperature to switch between heating and cooling set points.



See Adjust the Temperature on page 11.

8. Sleep Mode Activated

Display if the Sleep timer is activated.

See Sleep mode on page 18.

9. On/Off Icon

On is indicated by  (Blue) and Off is indicated by  (Red) in the room where the Main Thermostat is installed.

10. Info

Displays screen help information and alerts about your system.

See Info on page 12 and 19.

11. Configuration Menu

Use to set the Operation mode, Remote zones, Time schedule programming, Eco-Adapt, and System setup.

See the Configuration Menu on page 14.

12. Eco-Adapt Menu

The energy efficiency level for the system is set through the Eco-Adapt Menu. See Eco-Adapt on page 16.

13. Current Room Temperature

The current (actual) temperature in the room where the Main Thermostat is installed.

To access Set Date & Time Menu

- Press current day to access.

To change Time schedule programming value

- Press  to change.

To access Remote Zone control Menu

- Press current Zone to access.

To access Help info

- Press  to access.

To access Configuration menu

- Press  to access.

To access Eco-Adapt menu

- Press  to access.



3.2 Using your Main Thermostat

The color touch-screen on your Main thermostat makes it simple to review and adjust the settings at any time.

3.2.1 Adjusting the temperature

The set point displayed on the screen is the current default temperature.

You can easily adjust the temperature on your Main Thermostat.

- Press  to activate or deactivate the zone's air conditioning.
- Press  to increase the temperature set point by 1°F (0.5°C).
- Press  to decrease the temperature set point by 1°F (0.5°C).
- Press **74°F** (Current set point) to switch between heating and cooling set points.

The permitted temperature range is:

- Heating mode: 59° F – 84° F.
- Cooling mode: 64° F – 86° F.

If you are using Auto mode, note that there is a minimum difference allowed between heating and cooling set point temperatures. The system will prevent you from setting the temperatures to within those limits

To change Operation Mode

From the Home Screen:



- Press  (icon mode).
- Select your Operation Mode:

- **Stop**
- **Cool**
- **Heat**
- **Autochange**
- **Dry**
- **Emergency Heat***



*This option is only visible when it is configured.

3.2.2 Operation Mode

This menu sets your system to use heat, cool or auto mode.

- **STOP**  The air-conditioning system will remain switched off regardless of the demand status of any zone, and all the motorized dampers will stay open.
- **COOL**  In this mode the air-conditioning unit will start a Cooling cycle any time that any zone is in cool demand ($T_{\text{Set-Point}} < T_{\text{room}}$).
- **HEAT**  Enables the heating cycle whenever a zone is in heat demand. ($T_{\text{Set-Point}} > T_{\text{room}}$).

• **AUTOCHANGE A**

The AUTO mode allows automatic switching between Cool  and Heat , depending on the global demand.

• **EMERGENCY HEAT** 

This mode activates the **Auxiliary Heat** to provide heated air in case of a mechanical failure in the system.

**Note: This mode is only visible when the installation includes an auxiliary heating device.*

• **DRY** 

In this mode the air-conditioning unit will start a Dry Cooling cycle any time that any zone is under demand ($T_{Set-Point} < T_{room}$).

Dry



Dry mode decreases humidity in the room by entering the dry cycle.

3.2.3 Cleaning the Main Thermostat

You can clean the Main Thermostat screen by spraying water or any mild, non-abrasive household cleaner onto a clean cloth. Wipe the surface of the screen with the dampened cloth.

**Note: Do not spray any liquids directly onto your Main Thermostat.*

To clean the screen From the Home Screen



- Press  to **turn off**.
- Press  to access to clean mode.
- Press **Clean** to Start.

Screen blocked during 30 sec.

3.2.4 Thermostat Help Screens

The help icon  is displayed on every screen on the Main thermostat. When touched, it displays informative help text. The help screens can be viewed at any time with easy access to return to a prior screen.

Help Navigation buttons

- Press  to go on.
- Press  to go back or exit.
- Press  to return to Home Screen.

3.3 Time Schedule Programming

Your heating and cooling needs, change depending on the time of day and the day of the week. For example, if no one is in the house during the workday, you can reduce energy by letting the temperature go up in the summer and down in the winter.

By default, the Main Thermostat includes six configurable periods:

- **WAKE:** The start time of this period typically represents when you get up in the morning. It is an occupied program.
- **DAY:** This represents when you leave to go to work. It is a setback program.
- **EVENING:** This represents when you get home from work in the evening. It is an occupied program.
- **SLEEP:** This represents when you go to bed at night. It is an occupied program.
- **OCCUPIED:** This represents when you are at work. It is an occupied program.
- **UNOCCUPIED:** This represents when you are not at work. It is a setback program.

For protection, the default programs cannot be deleted, but they can be edited, enabled, or disabled.



You can create 18 different additional programs.

The Main thermostat allows three types of Time schedule programming:

- **AC MODE:** Sets an operation mode for the defined period.
- **OCCUPIED:** Sets a comfortable temperature for the defined period.
- **SETBACK:** Defines a period when the room is unused so the Zoning system can establish a setback temperature for the zone.

3.3.1 Time schedule programming activation

This menu can enable the option of time programs.

-  Time schedule programming activated.
-  Time schedule programming deactivated.

Remember to set the time-scheduled programs before Time Schedule Programming is activated.

To access the Programming menus

From the Home Screen:

- Press  for the Configuration menu.

- Press **Programming** for the Programming menu.

An **enabled** program displays a green button.





A **disabled** program displays a grey button.

To change Time Schedule Programming activation

From the Home Screen:

- Press  to change the value.





3.3.2 Create a new time scheduled program

- Press  CREATE PROG.
- Select type of program:
 - AC MODE
 - OCCUPIED
 - SETBACK
- Customize the name: Press  and use the arrows pad :
 - Up-Down: Changes the character.
 - Left-right: Selects the next character position.
 - Delete : Deletes the selected character.
- Select:
 - *Operation mode* for OPERATION MODE programs.
 - *Cool & Heating set point* for Occupied/Setback programs.
- Select days desired for the program:
 - Full week
 - Week days
 - Weekend
 - Personalized
- Select the start and end time.

If you wish to define a time to end the schedule, touch the box to enable the end of schedule parameter.

- Check the time program summary.
- Once a program is completed, it will be displayed in the active time schedule programming list available in the memory.

Keep in mind

- Press  to confirm the value.
- Press the parameter to change or be edited.
- Use   to select the value.
- Press  to go back or exit to previous menu.
- Press  to return to Home Screen.

Keep in mind

If there is no another time schedule starting right away, there will be no airflow in the zone until the next schedule starts. If no end of time is used, the current schedule will end when the next schedule starts.

3.3.3 Using the Time Schedule Programming editor

The Time Schedule Programming editor lets you set specific times, temperatures, and Operation modes for each day of the week. If your system is enabled for auto-changeover mode, the heating and cooling set temperatures will automatically be adjusted to ensure a minimum difference.

The available options are:

- **COPY:** Allows the user to copy the selected program to any other zone in the system.
- **EDIT:** Allows editing of the values defined in the selected time program.
- **DISABLE/ENABLE:** Disable or Enable the selected time schedule programming.
- **DELETE:** Delete the selected time program from memory. This option is only available and visible for customer- created programs.

Edit

Same process as Create a New Program.

When the program is **enabled**, a green button next to the named program is displayed. When **disabled**, a grey button is displayed.

3.4 Remote zone control

3.4.1 Remote control

Selecting the Remote Zone menu, lists all zones in the system and by selecting the zone, the user can access any thermostat in the system from the Main Thermostat.

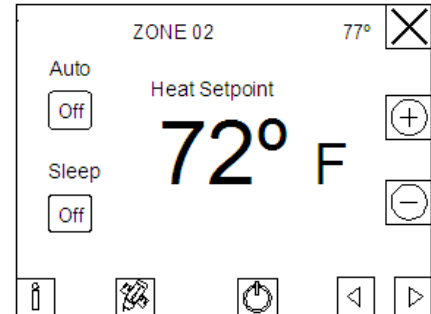

- Press the zone label to access a remote zone to modify.

- Press  to access the global zone to modify all zones at the same time.

To Remote zone control From the Home Screen:

- Press  to access Configuration menu.





- Press **Remote zones** to access.

Keep in mind

- Press  to confirm the value.



- Press  to return to the previous menu.

- Press  to return to Home Screen.

- **Room Name & Temperature.**
- **Set point Mode.**
 - Press  to activate or deactivate the zone's air conditioning.
 - Press  to increase the temperature set point by 1°F (0.5°C).
 - Press  to decrease the temperature set point by 1°F (0.5°C).
 - Press **72°F** (Current set point) to switch between heating and cooling set points.
- **Auto:** Time schedule programming activation.
 - Press value to change.
- **Sleep:** Timer information on page 18.
 - Press on value to change.
- **Time schedule programming** : Access time schedule programming in selected zone.

3.4.2 Edit Name Zone

You can customize the name of your zone in the Main Thermostat from remote zone menu. The process is as follows:

- Press .
- Press the zone that you want to rename, i.e., .
- To change the name, use the arrows pad .
 - **Up-Down:** changes the character.
 - **Left-Right:** selects the next character position.
 - **Delete** : deletes the selected character.

To edit Time schedule programming
See page 14.

3.5 Eco-Adapt

3.5.1 Description

Eco-Adapt allow the user to enhance the energy efficiency by setting a temperature limit for all zones. Setting temperatures allows the user to set different energy-efficient levels, choosing from Light, Medium, or Strong.



This function ensures a more efficient use of the DZK system installation.

3.5.2 Eco-Adapt menu



- **Off:** All temperature ranges are available and the system will work in **Comfort Mode**.
- **On:** Temperature ranges are limited and the system will work in **Efficiency Mode**.

The saving-modes available are:

- **Manual mode:** Temperature limit is defined manually by the temperature selected by the user on the Main thermostat.

Manual Mode	Lim. Min.	Lim. Max.
	64 F	86 F
	59 F	86 F

- **Efficiency Level:** Temperature limits are limited as follows:

Efficiency level	Light	Medium	Strong
	≥75 F	≥78 F	≥79 F
	≤72 F	≤70 F	≤68 F

To change Eco-Adapt

From the Home Screen:

- Press .
- Select **ON** or **OFF**.

If you are selected **ON**:

Press **Manual Mode** or select the **Efficiency level**:

- **Light**
- **Medium**
- **Strong**

Note: It is important to know that if a temperature time schedule programming is running, the set point temperatures will be limited to those selected on the Eco-Adapt.





3.6 Configuring your Main Thermostat

To Configuration menu

From the Home Screen:

- Press .

In the configuration menu the following options are available.

-  **Mode.** See page 11.
-  **Programming.** See page 13.
-  **Remote zones.** See page 15.
-  **Eco-Adapt.** See page 16.
-  **Settings:**
 - **Interface**
 - **User settings**
 - **Configuration** (Only for contractors)

To Interface settings

From the setting menu screen:

- Press **Interface**.

3.6.1 Interface

Brightness

- Select the screen brightness for both active modes.
- Select the standby mode (**Off** or **Bright**).

Keep in mind

- Press the parameter to change or be edited.

- Use  to select the value.

- Press  to confirm.

- Press  to go back or exit to previous menu.

- Press  to return to main menu or Home Screen.

Date & Time

Select Date:

- Select current day, month and year.

Select Time:

- Select current time.
- Select a 12-hour (AM/PM) or 24-hour time format.
- Enable or disable daylight savings.

Language

Select among 3 languages:

- **Español**
- **English** (default)
- **Français**

Beeping

Select the beeping sound mode:

- **Sound ON** (default)
- **Sound OFF**

3.6.2 User settings

Units

Select temperature to be displayed:

- °C (Celsius)
- °F (Fahrenheit)

To Interface settings

From the setting menu screen, press **User setting**.

Vacation

The Vacation mode feature helps you save energy while you are away for extended periods of time. Select type of Vacation mode:

- **System:** Activate (**On**) or deactivate (**Off**) vacation mode to all zone's system.
- **Zone:** Activate (**On**) or deactivate (**Off**) vacation mode to the current zone. Display the set temperatures:
 - **Heat:** Select 52-54-56°F.
 - **Cool:** Select 89-91-93°F.

Sleep

Sleep mode is a zone timer that shifts the set point temperature to a more energy efficient value. Select the value.

- **OFF:** Eco-Timer is not activated.
- **30:** Thirty minutes after its activation, the zone will vary its set point temperature by 2°F (1°C).
- **60:** Thirty minutes after its activation, the zone will vary its set point temperature by 2°F (1°C) and sixty minutes after its activation, the zone will vary another 2°F (1°C).
- **90:** Thirty minutes after its activation, the zone's set point temperature will vary by 2°F (1°C), another 2°F (1°C) after sixty minutes, and will again vary 2°F (1°C) following ninety minutes after its activation.

After the selected time, the set point temperature will remain at the lowest value. When Sleep mode is activated, a timeline is displayed on the Home Screen that informs of its evolution.





Global Ventilation

Global Ventilation allows activation of ventilation in all system zones during the system inactivity periods. Select Status.

- **NO.** Disable Global ventilation.
- **YES.** Enable Global ventilation.
 - **Every (mins).** Length of the interval between periods of ventilation (in minutes).
 - **Run for (mins).** Duration of ventilation(in minutes).

Global ventilation*

When global ventilation is activated, the icon modes are displayed on the Home Screen:

- Stop 
- Heat 
- Cool 
- Dry 

*This option will be deactivated when a zone is in demand.

Local ventilation

Not available for the
Operation Mode.



Local Ventilation

Local ventilation allows activation of ventilation in the Main Thermostat zone during system inactivity periods.

Select Status:

- **On:** Enable Local ventilation
- **Off:** Disable Local ventilation

3.7 Understanding the Alerts

If a problem arises, the DZK Alerts system displays a warning message about the current zone shown on the Home Screen.

If a problem arises in the Daikin system, a help icon  remains on the screen until the problem is resolved.

3.7.1 DZK system Alerts

The Main Thermostat can generate the following alert messages. Depending on your configuration, some of these may not apply.

ECO: If you do not want to retain the temperature limit set by the Eco-Adapt function, disable Eco-Adapt or select a lower efficiency setting.

UNOCCUPIED: The Setback time schedule programming is activated. If you touch the Home Screen, the setback program deactivates and returns to occupancy set point during the override time.

OVERRIDE: The override time is activated. When the override time has finished, the zone returns to its previous status.

VACATION: The vacation mode is activated.

Error 1: Communication error between Main Thermostat and controller board. This error blocks the thermostat and you should notify your contractor.

Error 9: Air-conditioning communication error with the system. The system will open every motorized outlet, enabling the air-conditioning controller. Contact your contractor.

4. WIRELESS THERMOSTAT

The Wireless Thermostat has a backlit LCD touch screen that displays all the information you need to set and manage your zone.

4.1 Home Screen Display

The Home Screen options for the Wireless Thermostat are:

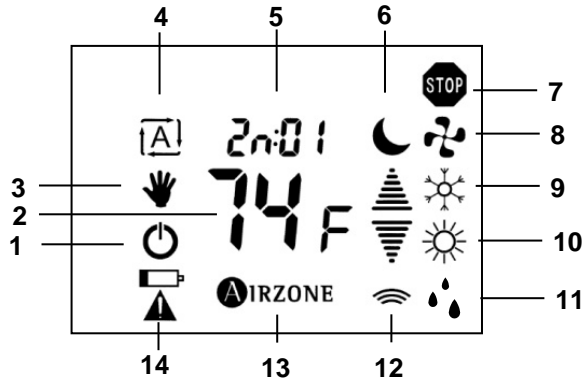

Home Screen

1. On/Off icon

Enables turning the air conditioning On or Off in the zone where the Wireless Thermostat is installed.

2. Current Set point

The zone temperature programmed to be maintained during a designated timeframe.

Press ▲ (Up) or ▼ (Down) to adjust manually by increments of 1°F (0.5°C). If the system is set to Auto, press the set point value to switch between heating and cooling set points.

See Adjusting the Temperature on page 23.

3. Hand Icon

Indicates zone air conditioning is activated.

4. Time Schedule Programming activated

Displays that Time schedule programming is activated.

See Time schedule programming information on page 24.

To deactivate Time Schedule Programming

- Press  on Home Screen.

5. Current Zone

Displays the current zone allowing remote zone control.

See Remote Zone Control on page 23.

To deactivate the Sleep mode

- Press  on the Home Screen.

6. Sleep Mode Activated

Displays sleep mode is activated in this zone.

See Sleep Mode on page 25.

To deactivate the Local Ventilation

- Press  on the Home Screen.

7. Stop Operation mode

The current operation mode is Stop.

8. Local Ventilation activated

Indicates local ventilation is activated in this zone. See Local Ventilation described on page 24.

9. Cool Set point & Operation mode

Display Cool Set point or Current operation mode.

10. Heat Set point & Operation mode

Display Heat Set point or Current operation mode.

11. Dry Operation mode

The current operation mode is Dry.

12. Communication Icon

Displays the communications between the Wireless Thermostat and the zoning box control board. To save battery life, the thermostat updates its screen every 5 minutes, and the current status may not be shown in the screen.

To manually update the screen just touch it and the current status will be shown.

13. Airzone Icon

Used to enter another menu or confirm a value.

14. Low Battery

Displayed when batteries have run low. It has 2 weeks of life left*. See how to change the batteries on page 23.

**Note: The indicated battery life is based on the original batteries shipped from Manufacturing.*

4.2 Idle Screen

When you are not actively using your Wireless thermostat, the screen will dim to indicate an Idle Screen.

To activate the Home Screen

- Press the Idle Screen.

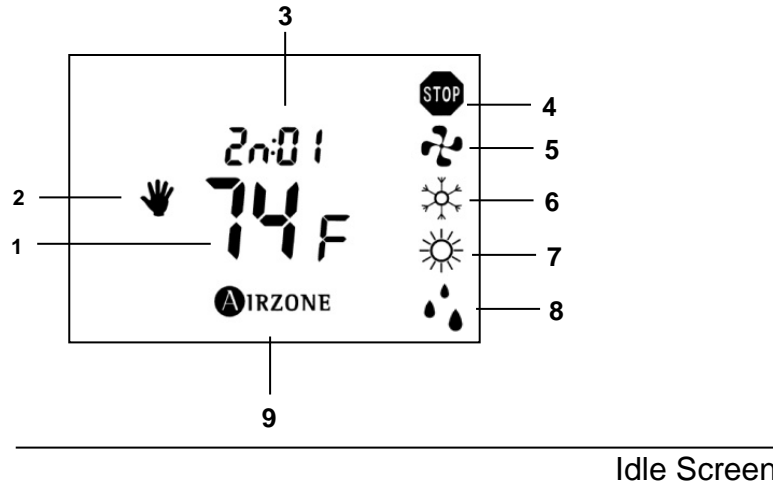

1. Current Temperature

The current (actual) temperature in the room where the Wireless Thermostat is installed.

2. Hand Icon

Indicates active temperature control.

3. Current Zone

Displays the current zone.

4. Stop Mode

Zone is actively in Stop Operation Mode.

5. Local Ventilation activated

Local ventilation is activated in this zone.
See Local Ventilation on page 24.

6. Cool Mode

Zone calling demand is currently in Cool Operation Mode.

7. Heat Mode

Zone calling demand is currently in Heat Operation Mode.

8. Dry Mode

Zone calling demand is currently in Dry Operation Mode.

9. Airzone icon

4.3 Using your Wireless Thermostat

Keep in mind

To save battery life, the thermostat updates its screen every 5 minutes, and the current status may not be shown in the screen.

To manually update the screen just touch it and the current status will be shown.

Cool & Heat set point





When you press the current set point, the mode's selected set point will be blinking.

The backlit LCD touch screen on your Wireless Thermostat allows easy access to adjust the settings.

4.3.1 Adjusting the temperature

By default, the set point displayed on the screen is the current Operation Mode.

You can easily adjust the temperature on your Main Thermostat.

- Press  to activate or deactivate the zone's air conditioning.
- Press  to increase the temperature set point by 1°F (0.5°C).
- Press  to decrease the temperature set point by 1°F (0.5°C).
- Press  (current set point) to switch between heating and cooling set points.

The permitted range is as follows:

- Heating mode: 59°F – 84°F.
- Cooling mode: 64°F – 86°F.

When the zone is activated, a hand icon is displayed. 

If using Auto mode, note that there is a minimum difference allowed between heating and cooling set temperatures. The system prevents you from setting the temperatures outside these limits. See the DZK Zoning Box Installation manual for information about configuring the minimum temperature-difference settings.

4.3.2 Low batteries

When  is displayed on Wireless Thermostat, batteries have 2 weeks of life left. It is time to change the batteries for new ones.

To replace the batteries, insert a coin in the slot placed at the bottom of the frame and turn the coin until the thermostat opens. Once the touch screen is separated from the support, replace the batteries according to the indicated polarity near the battery contacts (2 AAA 1.5V batteries). Reassemble both parts to their original positions.

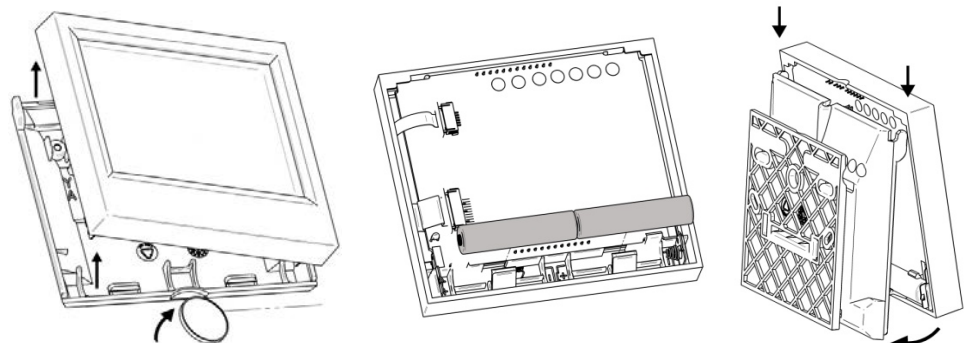

4.3.3 Cleaning the Wireless Thermostat

You can clean the Wireless Thermostat screen by spraying water or any mild, non-abrasive household cleaner onto a clean cloth. Wipe the surface of the screen with the dampened cloth.

**Note: Do not spray any liquids directly onto your Wireless Thermostat.*

4.4 Advanced functions in your Wireless Thermostat

From this menu, you can execute actions such as Time schedule programming, Local Ventilation and Sleep Mode.

4.4.1 Time Schedule Programming

The DZK Zoning system allows activation or deactivation of the Time schedule programming set on the Wireless Thermostat.

Activation

Press on  to activate time schedule programming in the current zone. The thermostat then returns to Home Screen.

The icon  is displayed on the Home Screen, indicating that this function is activated.

Deactivation

If the time schedule programming is activated, you can deactivate it from the Home Screen.

Press on  to deactivate time schedule programming. The icon will no longer be displayed.

4.4.2 Local Ventilation

This function activates the zone ventilation while the AC unit is not running a heating or cooling cycle.

Activation

Press on  to activate local ventilation in the current zone. The thermostat then returns to Home Screen.

The icon  will be displayed on both the Home and Idle screens, indicating that this function is activated.



To access the Advance Functions screen

From Home Screen.

- Short press on



The arrows   will disappear in Advance Screen.

The arrows   are displayed on the Home Screen.

Local Ventilation

Not available when the





AC unit is in  mode.

Deactivation

If local ventilation is activated, you can deactivate it from the Home Screen.



Press on  to deactivate the local ventilation. The icon will no longer be displayed.

To set Sleep Mode

- Press  to set the value.
- Press  to select the value.
- Press  to confirm.
- Press  to exit.

4.4.3 Sleep Mode

Sleep mode is a zone timer and operates as follows:

- : Sleep Mode Timer is activated 30 minutes after its activation, the zone varies its set point temperature by 2°F (1°C).
- : Sleep Mode Timer is activated 30 minutes after its activation, the zone varies its set point temperature by 2°F (1°C) and 60 minutes after its activation, varies by 2°F (1°C) more.
- : Sleep Mode Timer is activated 30 minutes after its activation, the zone varies its set point temperature by 2°F (1°C), another 2°F (1°C) after 60 minutes and 2°F (1°C) more after 90 minutes of activation.

Activation

Press on  icon, then select the value and confirm to activate sleep mode in the current zone. The thermostat will return to Home Screen.

The icon  is displayed on the Home Screen, indicating that this function is activated.

Deactivation

If the sleep mode is activated, you can deactivate it from the Home Screen.

Press on  to deactivate the sleep mode. The icon will no longer be displayed.

If you deactivate sleep mode before the selected time, the set point temperature remains as the last value set.

4.5 Remote zone control

Select the Remote Zone menu to list all zones in the system, and by selecting a zone, the user can access any thermostat in the system from the Wireless Thermostat.

- Select the room's zone number (ie, # 1.)
- **ALL** provides global zone access to modify all zones simultaneously and control all every room's system.



In remote zone screen, display:

- Room Number.
- On/Off icon.
 - On: Display Set point and hand icon are displayed.
 - Off: Set point and hand icon no longer displays.
- Set point mode.
- Operation mode. You can select the Operation mode only for all zones if you lost the Main thermostat.



To Remote zone control
From Home Screen, press on **20:02** (current zone).

- Press to exit.
- Press to select the value.
- Press to confirm.

- Press to On/Off.
- Press to select the set point.
- Press to switch between heat and cool set point. The set point icon mode is blinking. The current mode icon is fixed.
- Press to confirm.

4.6 Wireless Thermostat Configuration

This section describes how to configure user settings.

Units &

Select temperatures to be displayed.

- **°C** (Celsius)
- **°F** (Fahrenheit)



To configuration access
From Home Screen:

- Turn Off the room setting. .
- Short Press on to advance screen.

The icons are displayed.



- Long Press on till display .

Keep in mind

- Press  to go back.
- Press  to select the value.
- Press  to edit a value or confirm.

Vacation mode

The Vacation mode feature helps you save energy while you are away for extended periods of time. It also ensures your home is comfortable when you return. Select status:

-  Enable (Default)
-  Disable

Vacation set point temperatures

Select the set temperatures:

- **Heat:** Select *52-54-55°*
- **Cool:** Select *89-91-93°*

4.7 Understanding the Alerts

In case of system alerts regarding problems in the DZK Zoning system, a message is posted for the current zone displayed on the Home Screen.

4.7.1 List of DZK zoning system alerts

Your Wireless Thermostat can generate the following alert messages:

U7DC - Unoccupied: The Setback time schedule programming is activated. If you touch on the Home Screen, it will deactivate the setback program and return to occupancy set point during the override time.

ECD - Eco limit: The user has tried to exceed the Eco-Adapt temperature limit. If required, disable the Eco-Adapt to set the desired temperature. See page 16

OUER - Override: The override time is activated. When the override time has finished, the system returns to its previous status.

UACA - Vacation: The vacation mode is activated.

Err 1. - Error 1: Communication error between Wireless thermostat and the control board. This error blocks the thermostat so notify your contractor immediately.

Err9. - Error 9: Air-conditioning communication error with the system. The system will open every motorized outlet and the air-conditioning controller will be enabled. Notify your contractor.

5. NAVIGATION GUIDES

5.1 Main Thermostat navigation guide

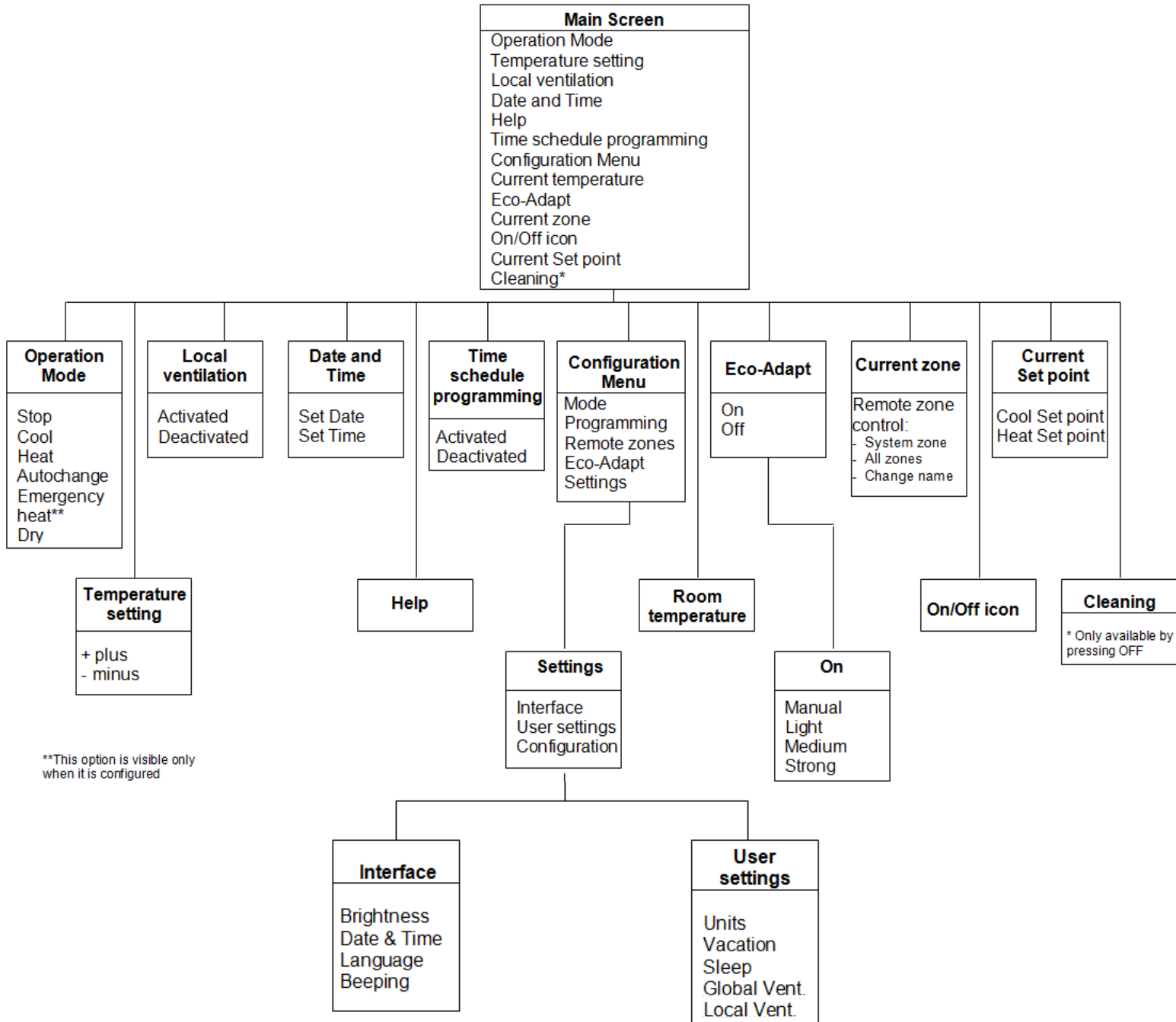

**This option is visible only when it is configured

5.2 Wireless Thermostat navigation guide

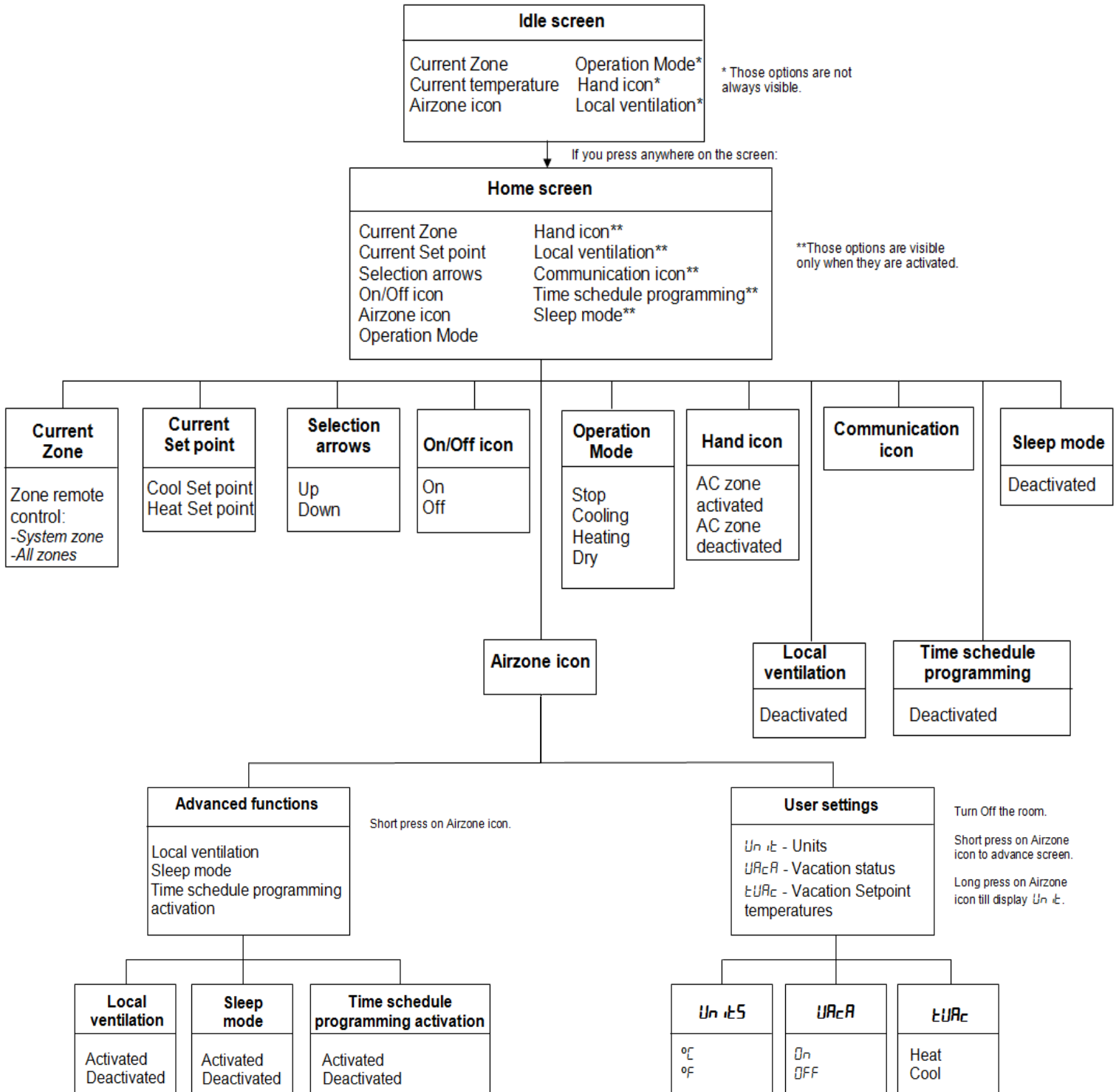

6. TROUBLESHOOTING

Item	Symptom	Verification/Action
1	Main Thermostat does not light up	Verify if the wireless thermostats show <i>Err 1</i> contact your service. Otherwise, proceed as indicated in pages 23 and 26 as a temporary solution until the Main thermostat is replaced
2	Wireless Thermostat does not work	If the screen is blank, replace the batteries. See page 23.
		If the screen is blocked, disconnect the batteries and re-install them back. If the problem persists contact your service. See page 23.
3	After a power failure, the Wireless Thermostat displays <i>Err 1</i>	The Wireless Thermostats can take up to 5 minutes to update the screen. Touch the screen to force an immediate update.
4	When accessing remote zones, one of them is not listed	Verify that the thermostat of the zone missing is working correctly. See pages 11 and 23.
5	The Wireless Thermostat shows all zones, but not its own	When trying to remote access other zones, the wireless thermostat will not show its own zone.
6	On activating the zone, no air is supplied to its grille (s)	Verify that the unit is not in Stop mode in the Main thermostat. See page 9.
		Verify if the zones is in demand, checking the ambient temperature (normally displayed in the thermostat and the set point (appears upon touching the thermostat screen) See pages 23 and 26.
		If this zone does not receive air, call your contractor.
7	One Wireless Thermostat displays " <i>SCAn</i> " permanently	Call your contractor for a replacement to verify the wireless communication.
8	Some time after changing the set point in the thermostat the set point varies 1 or 2 °F	Verify if the sleep mode is activated. See pages 18 and 25.
9	Some time after changing the set point in the thermostat it changes by itself to a different set point	Verify if the automatic mode is enabled. See page 11.
10	What do I do if one (or several) zones do not control the temperature?	Verify that the Operation mode is not STOP. See page 9.
		Verify ambient and set point temperatures in the non-working zone thermostat to see if it is creating demand. See pages 11 and 23.

11	How much time do I have left when the battery symbol is shown?	When the battery icon is shown in the screen there are about 15 days left to change the thermostat batteries.
12	When trying to lower or increase the set point ECO/ECO appears on the screen	You have tried to exceed the Eco-Adapt temperature limit. If required, disable the Eco-Adapt to set the desired temperature. See page 16.
13	Error 1 in the Main Thermostat	This error indicates that the Main thermostat is inoperative. The associated damper will remain open, and the use will be able to change the operation mode from any wireless thermostat. See page 16.
14	Err 1 in the Wireless Thermostat	This error indicates that the wireless thermostat is not communicating and the zone will not have temperature control. See page 27.
15	Error 9 in the Main & Wireless Thermostat	This error indicates that the zoning system is not controlling the Daikin system. See pages 19 and 27.



PHONE: 972 245 1510
E-mail: info@daikinac.com
<http://www.daikinac.com>





DZK Zoning Box

Installation Manual

Summary

1. WARNINGS, ENVIRONMENTAL POLICY, AND CERTIFICATIONS	5
1.1. Warnings.....	5
1.2. Environmental Policy.....	5
1.3 FCC Regulatory Notices	6
2. SYSTEM DESCRIPTION	6
2.2. DZK Control.....	10
2.2.1 DZK Control Board.....	10
2.2.2 Daikin - Interface Board	10
2.2.3 Main Thermostat	11
2.2.4 Wireless Thermostat	11
3. DESCRIPTION, INSTALLATION AND CONNECTION OF THE COMPONENTS	12
3.1 General recommendations.....	12
3.2 DZK Zoning box	14
3.2.1 Assembly	14
3.2.2 Damper setting	14
3.2.3 Connection	19
3.3 Daikin Interface Board	23
3.3.1 Connection & Configuration	23
3.4 Main Thermostat	24
3.4.1 Installation	24
3.4.2 Wiring	25
3.4.3 Main Thermostat Configuration	25
3.5 Wireless Thermostat	27
3.5.1 Installation	27
3.5.2 Wireless thermostat configuration.....	27
4. ADVANCE CONFIGURATION	29
4.1 Main Thermostat	29
4.1.1 Main Thermostat Configuration Menu.....	29
4.1.2 Interface Menu.....	35
4.1.3 User settings.....	35
4.2 Wireless Thermostat Configuration	37
4.2.1 Access to the Configuration Menu	37
4.2.2 Configuration Menu	37
4.2.3 User Settings	40
4.2.4 Other functions	35
5. COMMISSIONING STEPS	42
5.1 Turn on power to all systems	42
5.2 Communications with the Indoor unit – Modes/Temperature	44
5.3 Zone assignment	45
5.4 Airflow control	45
5.5 Other configuration parameters	45
6. EXCEPTION CODES	48
List of DZK zoning box system alerts	48
7. AUTO DIAGNOSTICS.....	50
7.1 Zoning box control board	50
7.2 Daikin Interface Board	51

- 8. NAVIGATION GUIDES 51
 - 8.1 Main Thermostat navigation guide 51
 - 8.2 Wireless Thermostat navigation guide 50
- 9. TROUBLESHOOTING 50

1. WARNINGS, ENVIRONMENTAL POLICY, AND CERTIFICATIONS

1.1. Warnings

For personal safety and equipment protection, follow these instructions:

- Do not operate the system if it is wet, or handle it with wet hands.
- Connect the power supply cable before connecting the AC power.
- Perform any connection or disconnection with the power supply **OFF**.
- Verify that there is no short-circuited connection in the connectors between different cables or ground.
- Verify there are no abnormalities in the wiring.

1.2. Environmental Policy



Never dispose of this equipment with household waste. Electrical and electronic products contain substances that can be harmful to the environment if they are not given proper treatment. The symbol of the crossed container indicates separate collection of electronic equipment, unlike the rest of urban garbage. For proper environmental management, the equipment to be disposed must be taken to the proper collection center at the end of its lifespan.

The components of this equipment can be recycled. Follow the existing regulations on environmental protection in your area.

The unit must be delivered to your dealer if it is being replaced. If it is to be discarded, it must be sent to a specialized collection center.

1.3. FCC Regulatory Notices

Modification statement

Corporacion Empresarial Altra S.L. has not approved any changes or modifications to this device by the user. Any changes or modifications could void the user's authority to operate the equipment.

Interference statement:

This device complies with Part 15 of the FCC Rules. Operation is subject to the following two conditions: (1) this device may not cause interference, and (2) this device must accept any interference, including interference that may cause undesired operation of the device.

Radiation Exposure Statement

This device complies with FCC radiation exposure limits set forth for an uncontrolled environment and meets the FCC radio frequency (RF) Exposure Guidelines in Supplement C to OET65 This transmitter must not be co-located or operating in conjunction with any other antenna or transmitter.

FCC Class B digital device notice

This equipment has been tested and found to comply with the limits for a Class B digital device, pursuant to part 15 of the FCC Rules. These limits are designed to provide reasonable protection against harmful interference in a residential installation. This equipment generates, uses and can radiate radio frequency energy and, if not installed and used in accordance with the instructions, may cause harmful interference to radio communications. However, there is no guarantee that interference will not occur in a particular installation. If this equipment does cause harmful interference to radio or television reception, which can be determined by turning the equipment off and on, the user is encouraged to try to correct the interference by one or more of the following measures:

- Reorient or relocate the receiving antenna.
- Increase the separation between the equipment and receiver.
- Connect the equipment into an outlet on a circuit different from that to which the receiver is connected.
- Consult the dealer or an experienced radio/TV technician for help.

2. SYSTEM DESCRIPTION

Daikin Zoning Kit, DZK is an optional kit that increases the flexibility of the FXMQ and FBQ Indoor Unit fan coils. It allows multiple separate ducts to be connected to fan coil and supply air to different individually controlled zones in a building.

2.1 Product Range DZK Zoning Box

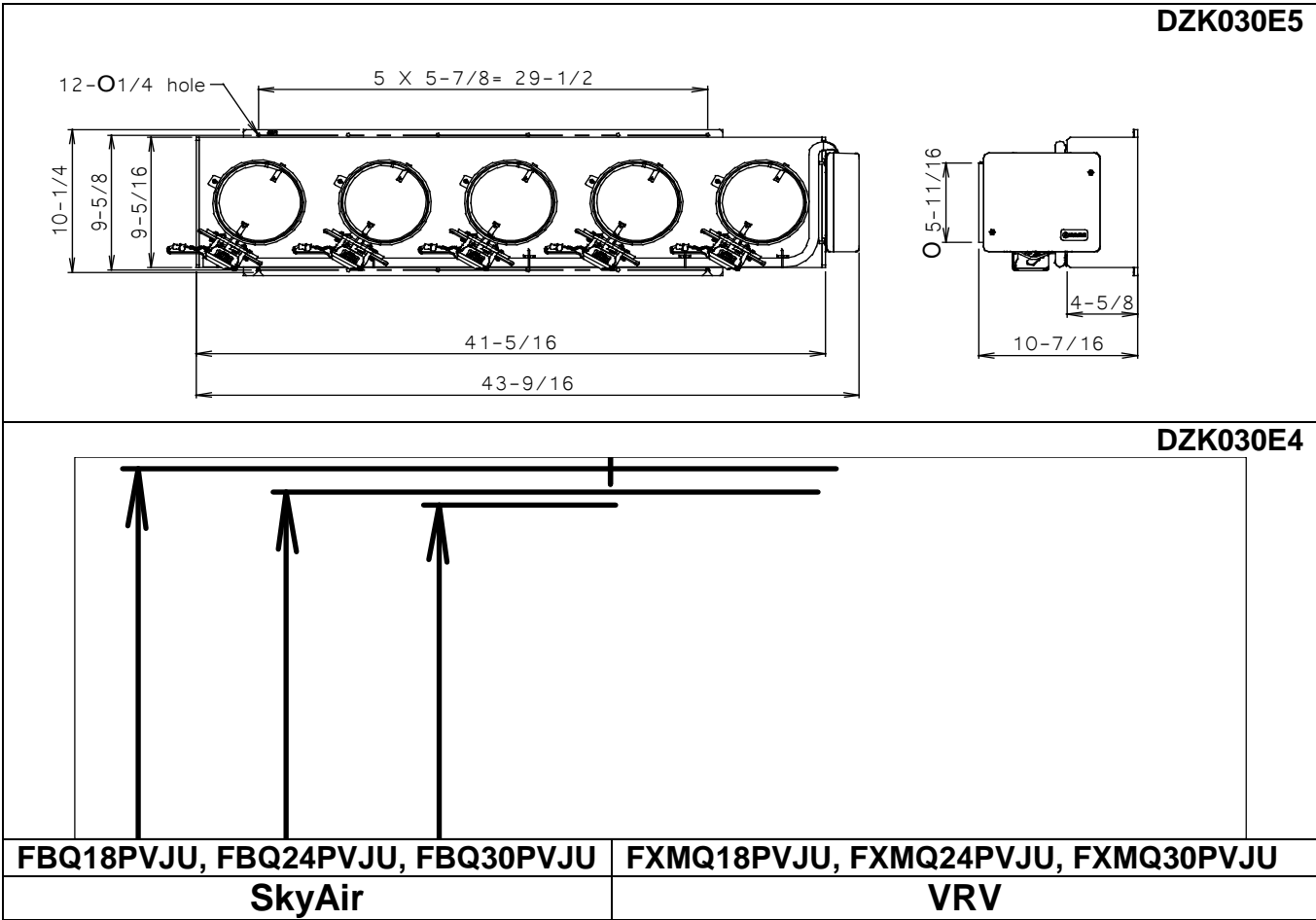

DZK048E6

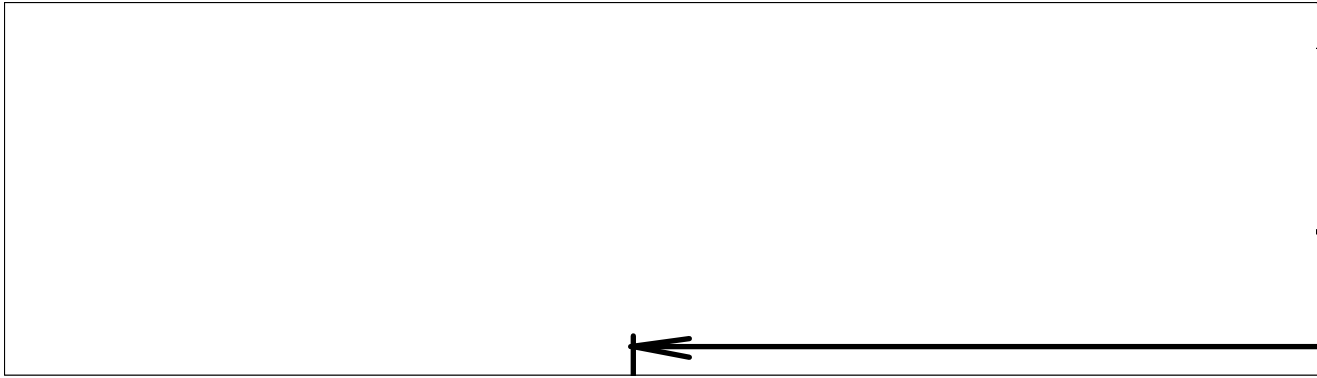

DZK048E4

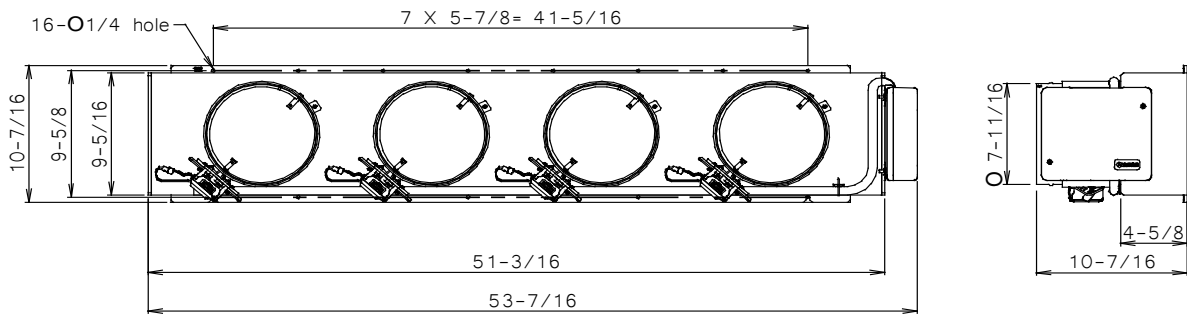

FBQ36PVJU, FBQ42PVJU
SkyAir

FXMQ36PVJU, FXMQ48PVJU
VRV

DZK Zoning box

A. Damper limitation adjustment

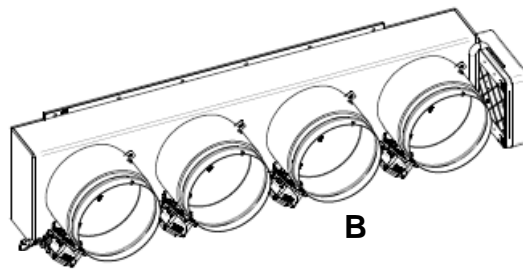
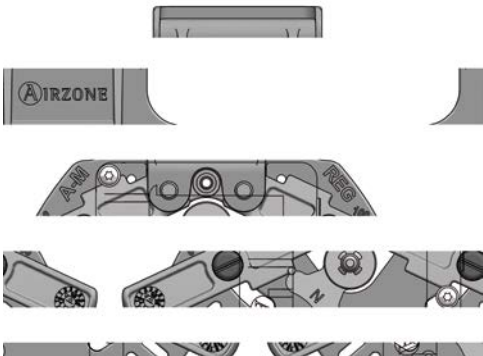

B. Motorized Damper

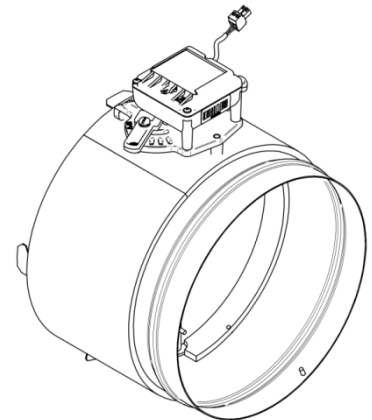

2.2. DZK Control

2.2.1 DZK Control Board

This device manages all wired and wireless devices in the system, performing the following functions:

- Controls and manages the status of each thermostat or controller.
- Outputs for the motorized dampers.
- Control of the auxiliary heat (up to two stages).
- Manages communication with the DAIKIN Interface Board.

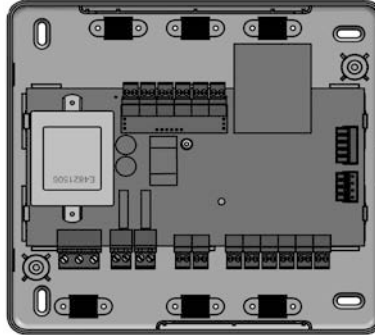

Controls the ON/Off status, mode, fan speed, and set point temperature of the DAIKIN Indoor units.

2.2.2 Daikin - Interface Board

This unit integrates the Daikin Indoor unit with the DZK control board.

The Daikin interface board includes an Energy Efficiency Control Algorithm that is controlled with the Main Thermostat, including the following functions:

- Automatically changes the Indoor Unit operation mode (Stop, Ventilation, Cooling, Heating, or Dry) from the in the DZK system's Main Thermostat.
- Temperature setting for the AC unit based on the overall demand of the DZK zone thermostats.
- Defrost function: In heating Mode, when User Set Point Temperatures are satisfied, instead of setting the Daikin unit to OFF, a 60F set point Temperature is set. This function is set by means of DIP-switch configuration.

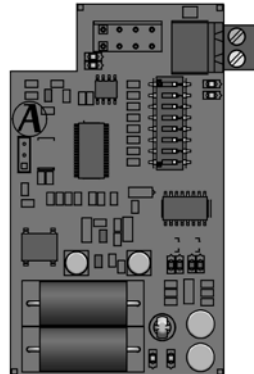

2.2.3 Main Thermostat

Graphic color touch pad display for control of zone temperature master thermostat. Wall mounted.

- Graphic interface with 3 languages (Spanish, English, and French).
- Zone On/Off.
- Set point temperature setting (steps of 1°F).
- When configured as master, operation mode selection for the system (STOP, COOL, HEAT, AUTO CHANGEOVER EMERGENCY HEAT, DRY,).
- Sleep Function.
- Eco-Adapt.
- Time schedule programming and, when configured as master, operation mode scheduling.
- Remote zone control.
- Used to set system parameters.

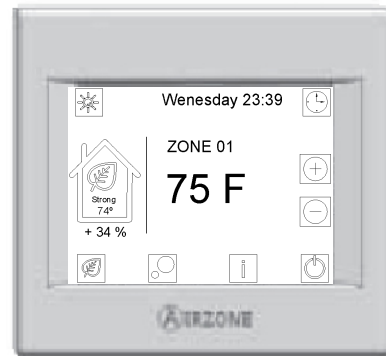

2.2.4 Wireless Thermostat

This is a battery powered, wall-mounted, and back-lighted monochrome LCD touchpad digital thermostat to control the zone temperature.

- Zone On/Off.
- Set point temperature setting at steps of 1 °F.
- Sleep Function.
- Remote zone access.
- Local ventilation.
- Time schedule control.
- Powered by two 1,5V batteries (type AAA; included).



3. DESCRIPTION, INSTALLATION AND CONNECTION OF THE COMPONENTS

3.1 General recommendations

Closely follow the instructions on this manual to avoid installation and maintenance issues.

- The system should only be installed by qualified personnel.
- Never use solid wire to install the system. This is a communication device and requires the use of communication cables.
- While connecting the devices, be sure the system is not powered.
- Follow the local installation regulations for low and high voltage installation.

The recommended specifications for the cable to install this system are:



- 4 wired
- Stranded
- AWG 20
- Plenum
- Shielded

When connecting to other systems fed with high voltage, only use the A and B contacts of the communication bus. It is not recommended to connect the + and – contacts, nor the ground.

- Follow the color codes and polarity indications in the system components.
- Do not run the bus cable near high power cables or near electrical motors to avoid electromagnetic interference in the system communications.
- Use the following recommendations to locate the thermostats:

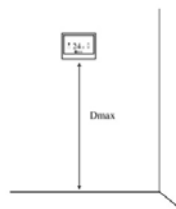
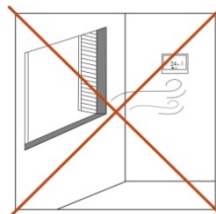

- To open the thermostat in preparation for its installation, it is recommended to use a coin. Using a screwdriver or other Sharp tool can damage the frame and the electronic components of the thermostat.

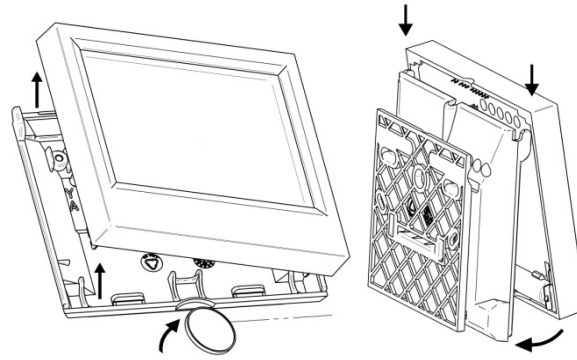

If upon receiving the unit it is determined that one of the outlets will not be used, take the following actions:

- 1) Install the unit and wiring ready to start with the Main Thermostat Configuration. The unit should have all dampers open.
- 2) Configure the Main Thermostat. Once the thermostat is assigned a zone, all other dampers will close with the exception of that assigned to the Master thermostat.
- 3) At this time, disconnect the motor cable from the outlet that will not be used.
- 4) Permanently seal the outlet using the supplied plug and follow the local installation recommendations.

3.2 DZK Zoning box

3.2.1 Assembly

The Zoning Box allows providing a fast and simple zoning to Daikin systems. The compatible Indoor unit fan coils and DZK models are listed in the following table:

Model		Damper Size	Number of Dampers
FBQxxPVJU FXMQxxPVJU	18 - 24 - 30	6"	5
		8"	4
	36 - 42 / 48	6"	6
		8"	4

Keep in mind

Make sure that the zoning box is in its correct position (Actuators at the bottom)

Follow the steps listed below to make an easy and reliable DZK installation:

- 1. The adaptor is shipped with the dampers fully open.** One of them includes a plug to be used in case one of the dampers is not used. If the damper is not used, the contractor needs to be sure that the plug will stay in place. If all dampers are used, take the plug out and store it.

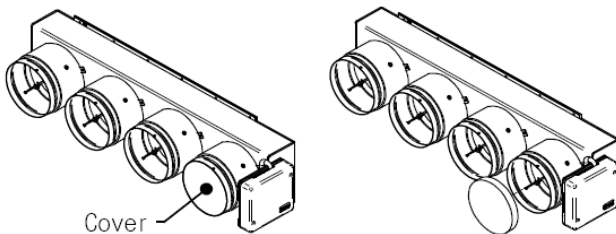

- 2. Insert sharp pointed object through the frame holes and the frame sealing to facilitate the location of the setting holes used to assemble the zoning box to the indoor unit.**

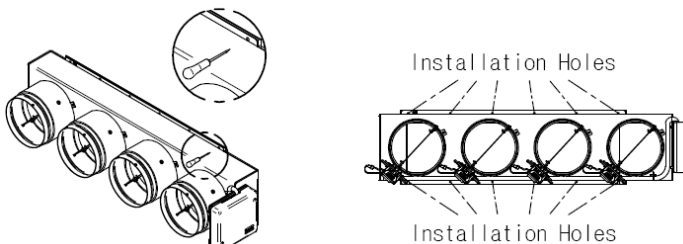

3. Take away the indoor unit collar. Insert a screw (not fully tightened) in the bottom corners of the indoor unit as how in the following figure:

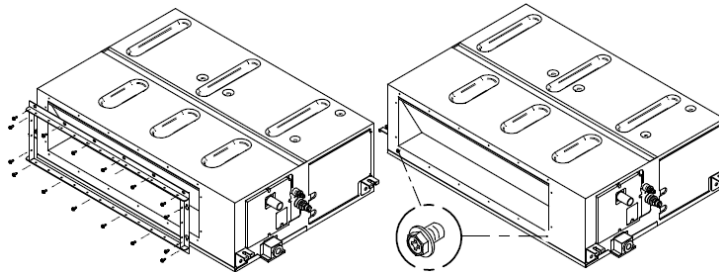

3. Sit the zoning box on the screws as shown below, and then affix the box using the left screws.

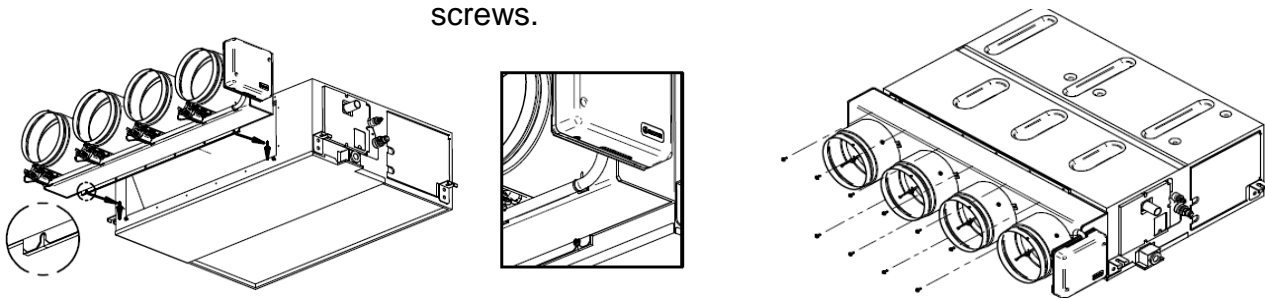

5. Attach each zone duct with its assigned damper. Follow the local recommendations to insulate and seal the ductwork with the damper. **Make a cutout along the duct to keep the motor outside of the insulation.**

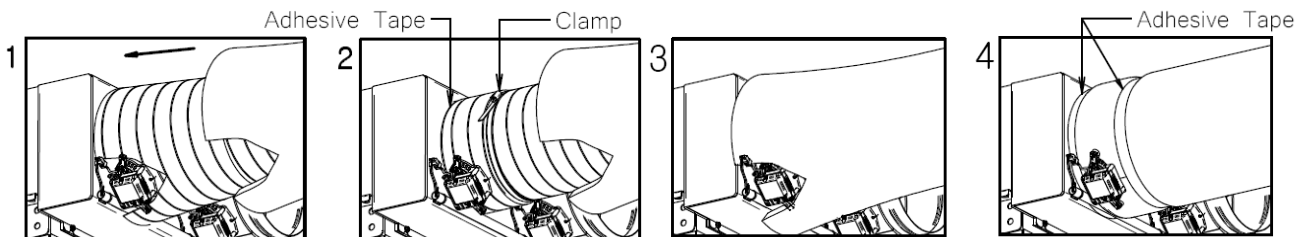
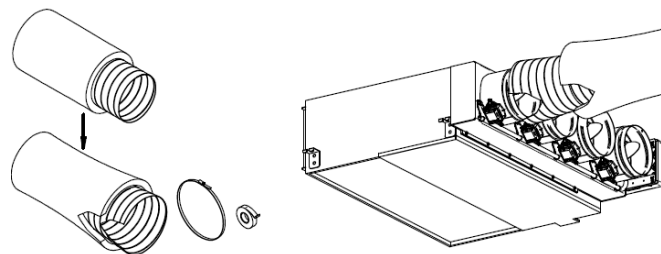

6. Use of the insulated stopper. If a damper is not being used in the installation, proceed as follows:

- Make sure the damper is closed before installing the insulated stopper.
(The damper will close as soon as the first zone is assigned)

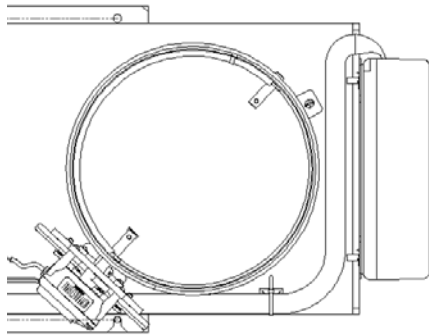

Damper is closed

- Check that the power cable is disconnected for the damper motor that will not be used.

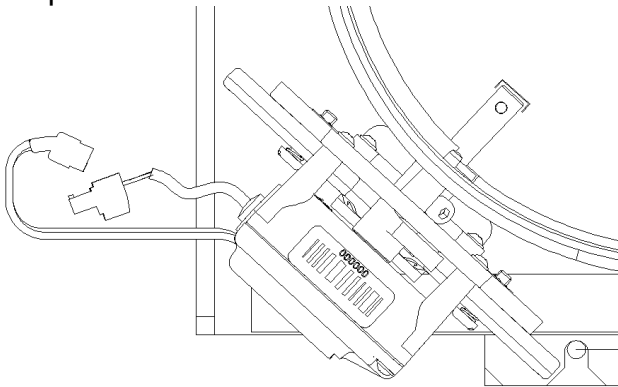

Power cable is disconnected

- Check that the damper remains airtight with the power **ON** and the fan running.

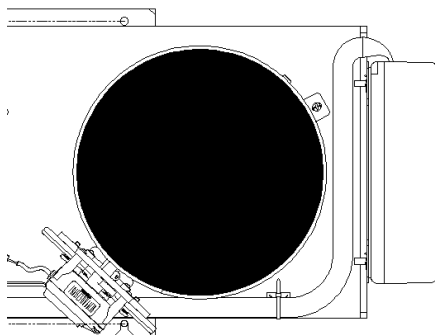

Damper is closed

Keep in mind

This setting must be done after all dampers are assigned to their thermostats.

3.2.2. Damper setting

The dampers included in the zoning box has a built-in control system that allows you to manually set the maximum and minimum opening of each damper according to the needs of each installation.

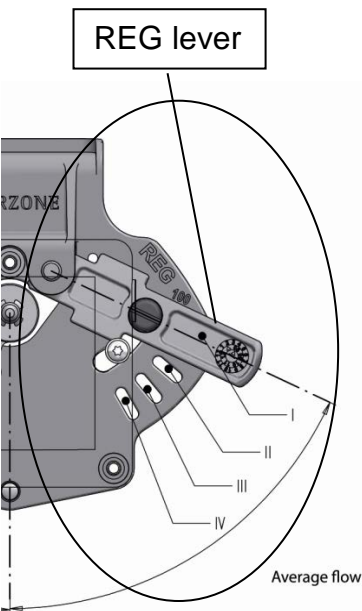
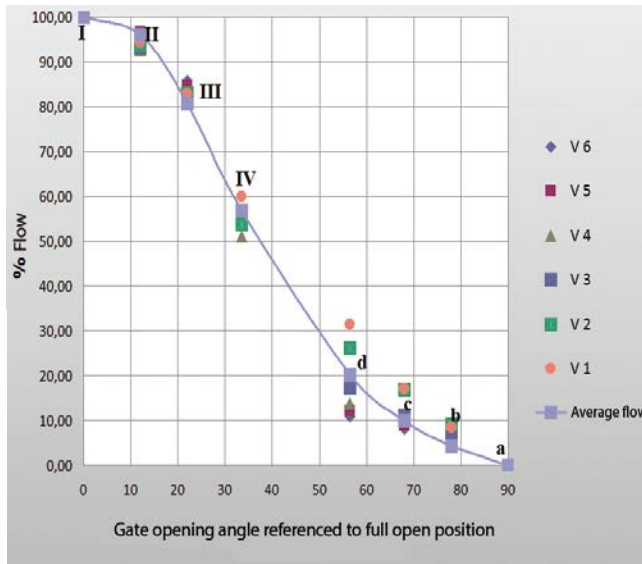

Average Flow (REG)

Due to the unique characteristics of each ID unit supply port with respect to the dampers of the box, the flow distribution is not identical in each damper. The central dampers receive more airflow than the others, being the damper No. 1 the one that receives less flow.

This zoning box offers maximum aperture regulation which balances the flow of each damper to the needs of the installation.

By default, the dampers are configured with a maximum opening at **Position I**. To adjust the control of the dampers proceed as follows:

- The damper must be completely closed to mechanically adjust its flow. To make this adjustment create demand in all zones, so that the indoor unit runs at maximum capacity. Then deactivate the zone to be adjusted, and verify that there is no air supplied to that zone.
- With the damper closed, place the lever marked REG in the actuator to the desired open position. There are 4 positions - I, II, III, and IV, with position I being completely open and position IV having the slightest opening

- Perform the setting of the dampers by changing the lever REG position, beginning with the central one and ending with damper No. 1 (Closest to the zoning box control board). The reduced flow in the central dampers will increase the flow of the dampers at the ends.

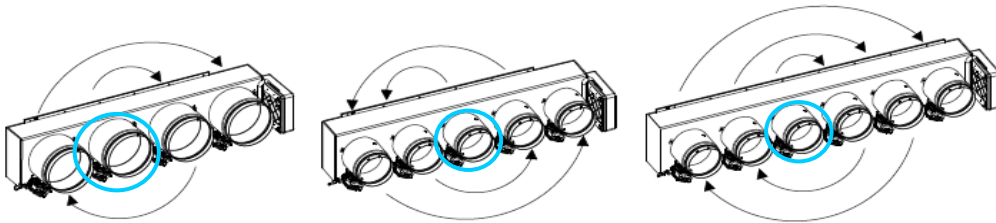

- Using an anemometer verify that the flow in each grille is within the installation requirements.

Keep in mind that this setting is not compatible with the System configuration set to Airflow>Modulating. (See on page 30)

Minimum Air (A-M)

Similarly, the zoning box allows a minimum air opening for each damper, if needed. By default, the “a” damper is configured in the full-close position. To adjust minimum air for any damper, proceed as follows:

- Check that the dampers are wide open to start its control. To do so, set the system to STOP mode, from the Main Thermostat.
- Perform the setting of the dampers by changing the lever A-M position beginning with the one in the center of the box and ending with damper 1. (Closest to the zoning box control board). Reduced flow in the central dampers will increase the flow of the dampers at the ends.
- With the damper open, place the handle **A-M** in the desired open position. It has 4 positions - a, b, c, d-, where "a" is fully closed and is "d" is the fully open.
- Check with an anemometer that the flow in each grille is within the installation requirements.

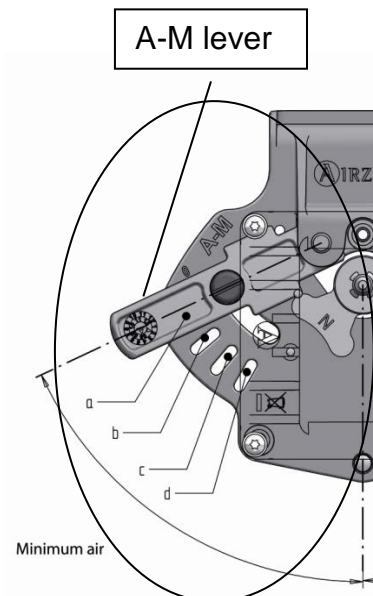

3.2.3 Connection

Ref	Function
1	Power supply
2	Heating Stage 1 Output
3	Heating Stage 2 Output
4	Protection probe input
5	Alarm input (NC)
6	Actuator Control output
7	Daikin Interface Board
8	Expansion bus
9	Wireless Interface
10	Reset System Button
11	RS485 MODBUS interface

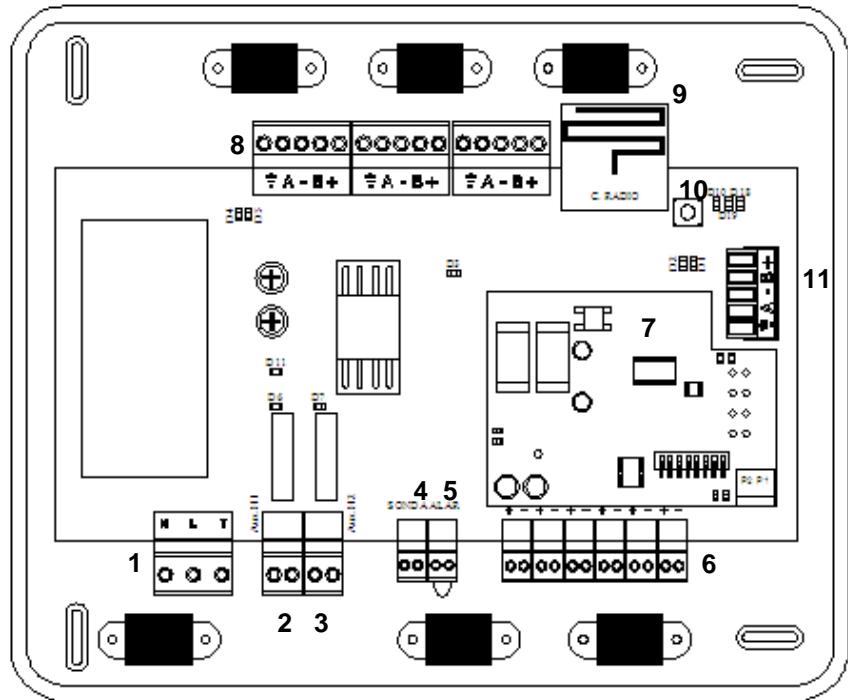

1. - Power supply

Power supply 120/240 VAC line.

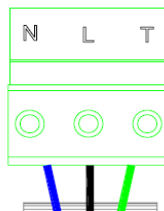

N	Neutral / Neutro / Neutre
L	Phase / Fase / Phase
T	Ground / Tierra / Terre

The Zoning box control board is protected by a self-resettable fuse. This is an electronic component that does not require any action other than cycling the power to perform the reset.

2. - Heating Stage 1 Output

If the system includes Auxiliary Heat, when required by the heat demand, this output enables the First Stage of Auxiliary Heat.

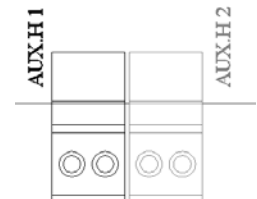

The technical specifications for the 1st Stage Aux. Heat relay are:

$I_{max} = 1 \text{ A @ 24V}$, dry contacts.

If higher power is required for control, use external contactors of appropriate capabilities.

3. - Heating Stage 2 Output

This output enables Second Stage of Auxiliary Heat, if the system includes a two stages Auxiliary Heat.

The technical specifications for the 2nd Stage Aux. Heat relay are: $I_{max} = 1 \text{ A @ 24V}$, dry contacts.

If higher power is required for control, use external contactors with appropriate capabilities.

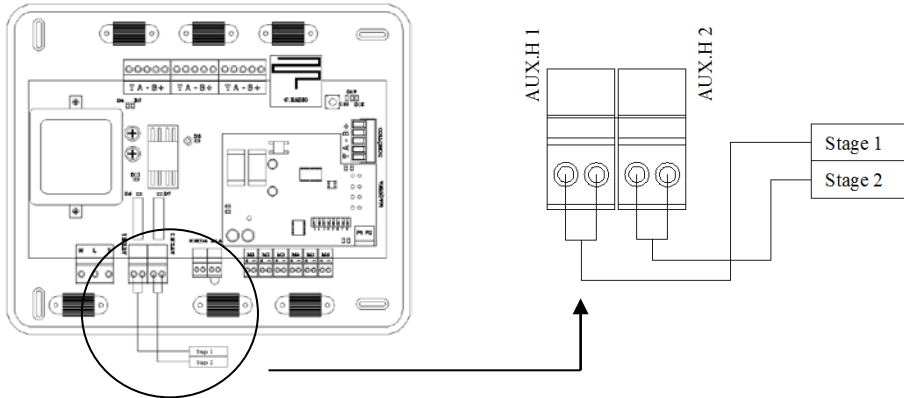
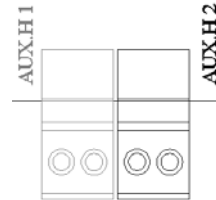

4. – Protection probe Input

This input is used to connect the supply temperature sensor.

5. - Alarm input (NC)

When this input is open it will stop the AC unit, and close all dampers. This input is shipped with a jumper in the connector that should be left in place unless an alarm input is connected.

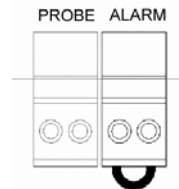

6. – Actuator control outputs

These outputs are used to drive the damper actuators with 12VDC control for each zone, as shown in the following diagram:

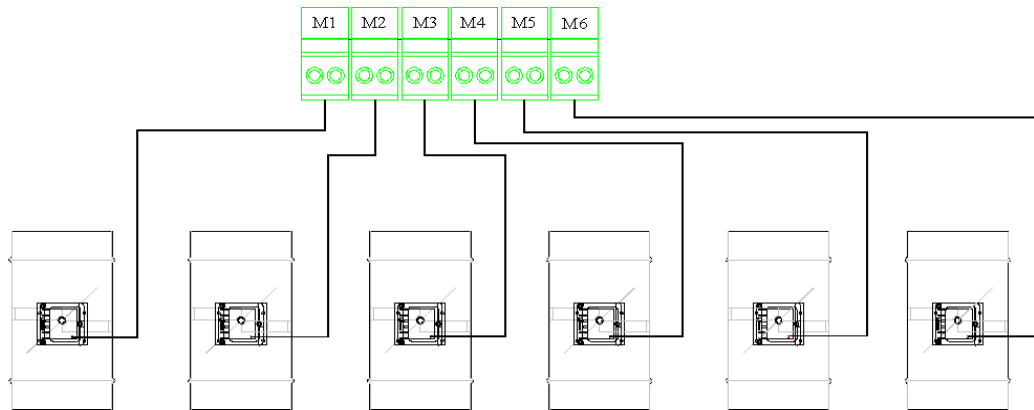

7. - Daikin Interface Board

This Interface provides the communication between Zoning box control board and Daikin Indoor unit.

8. - Expansion Bus

The expansion bus allows the connection of the Main Thermostat. There are 3 connectors with 5 contacts available to connect the expansion Bus. The Main Thermostat is connected to this bus. Connect the cables to the connector contacts according with the color code indicated below.

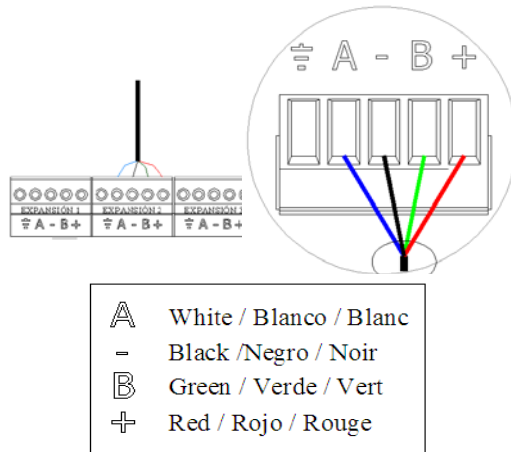

9. - Wireless Interface

This device provides the communication between the Zoning box control board and the Wireless thermostats.

10. - Reset System Button

If the whole system needs to be reset (normally a replacement board that has been used before, or at the request of the technical support as a last resource to fix a problem), press and hold SW1 until the LED 19 stops flashing. A system reset will return all configurations to default values and conditions.

Keep in mind

Once this sequence is started it cannot be interrupted and the Quick Setup process should be allowed to finish.

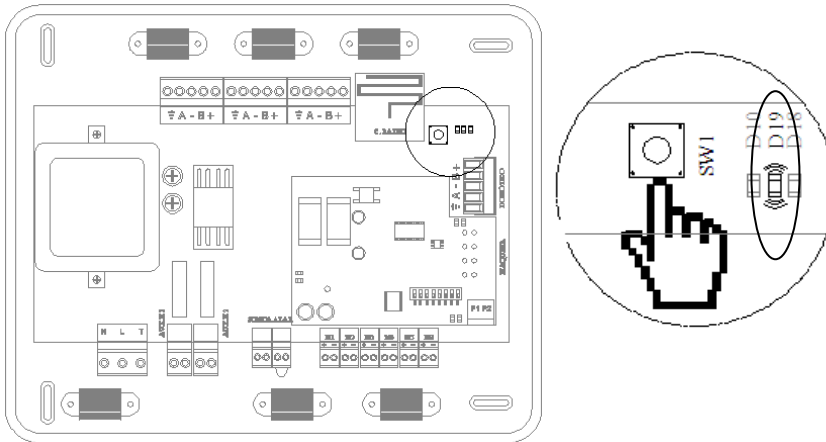

11. - RS 485 MODBUS interface

The RS 485 MODBUS interface allows communicating with a BMS or other external compatible device to have access to the system.

There is one connector with 5 contacts to connect the communication bus. This connector only supports the daisy chain configuration. Connect the cables to the connector contacts following the color code indicated below.

A	White / Blanco / Blanc
-	Black / Negro / Noir
B	Green / Verde / Vert
+	Red / Rojo / Rouge

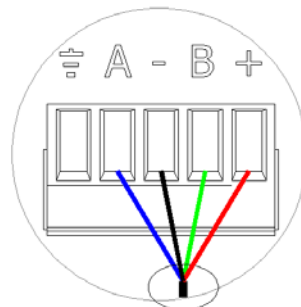

3.3 Daikin Interface Board

3.3.1 Connection & Configuration

Complete the connections adhering to the following steps, in this order:

- 1) Disconnect the power supply from both the Daikin Indoor unit and the DZK system.
- 2) Open the protective cover of the Daikin Indoor unit, and locate the **P1, P2 connection** (to which the Daikin navigation controller is connected).

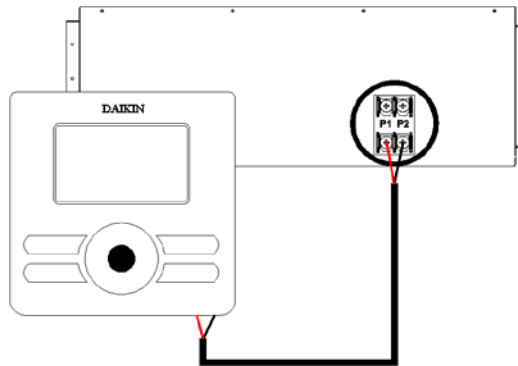

- 3) Connect a two-wire cable to **P1 P2** on the Indoor unit, in parallel with the Daikin navigation controller.
- 4) Connect the other end of this cable to the connector labeled **P1 P2** on the interface unit mounted on top of the control board, maintaining the polarity.

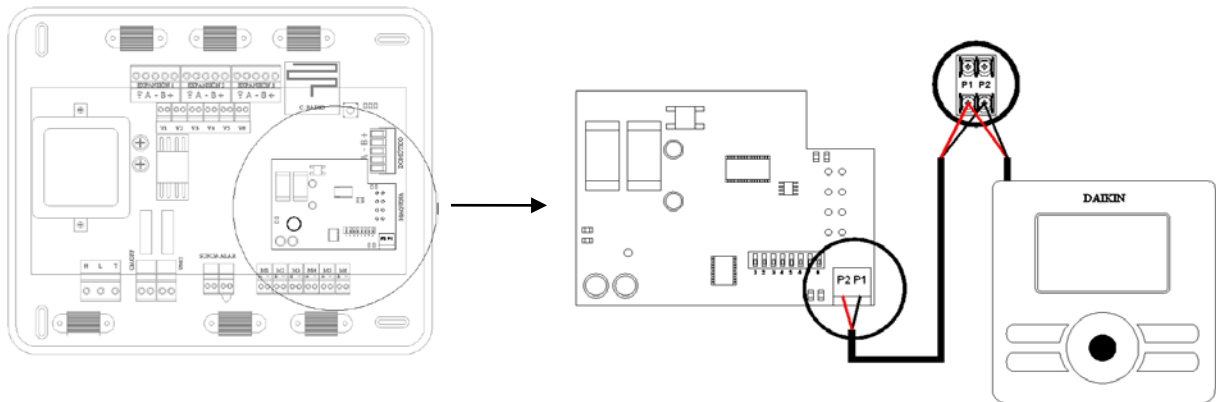

- 5) Close the Daikin Indoor unit's protective cover.

6) Configure the DIP-switch as required.

DIP switches	Configuration
	2 Speeds <i>Default configuration</i>
	3 Speeds
	Enable Defrost

3.4 Main Thermostat

3.4.1 Installation

Main Thermostat is available for wall mount. The wiring should not exceed 131 ft., and stranded AWG20 shielded cable should be used.

To mount the thermostat on the wall, take the following steps:

- Disassemble the thermostat in three parts. To split the frame from the base, use the edge of a coin. Do not use any sharp object.
- Affix the wall plate to the wall using screws and anchors according with the wall material.
- Insert the cable to the middle plate, and reassemble it to the wall plate.
- Reassemble the front frame to the base.

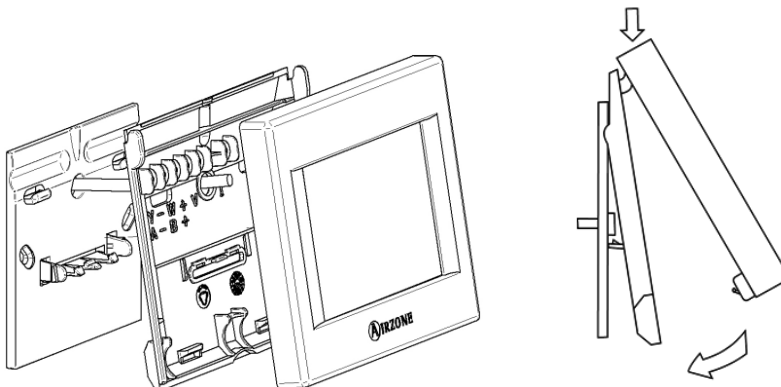

3.4.2 Wiring

DZK thermostats are connected to the expansion bus.

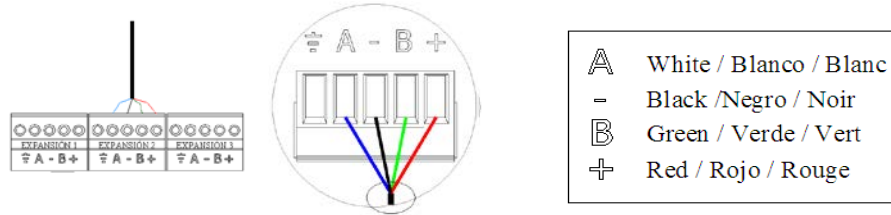

The wall mounted thermostats are wired to the screws located in the middle frame. Be sure to connect the cables according to the engraving in the middle frame.

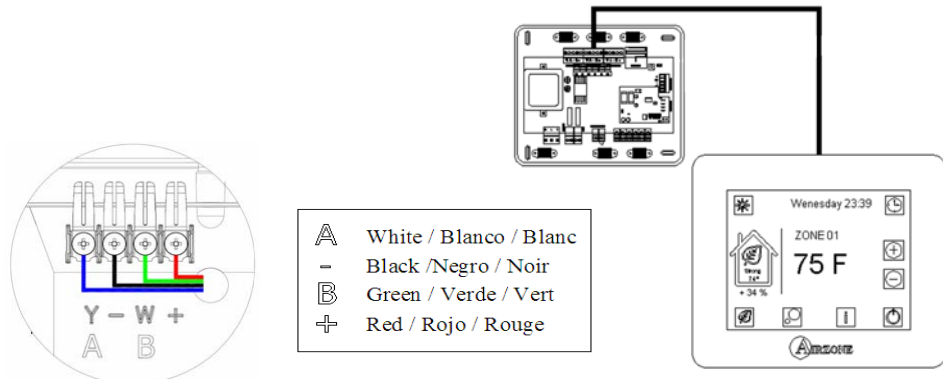

3.4.3 Main Thermostat Configuration

Language

-Press the value to select.

-Press to confirm the value

1) Language

You may select one of the three languages available for the interface.

- Español
- English (Default)
- Français

Zone ID

-Press to change the value

-Press to confirm the value

2) Select Zone

It is now required to define the zone number associated with this thermostat. Each zone is associated with a control outlet. Zone 1 controls damper 1, zone 2 controls damper 2, and so on for up to 6 zones in the system.

3) Zone subordinate (subordinate damper)



If needed, the system allows associating more than one damper with a single zone. This allows managing dampers from the thermostat that is being configured.

Select **NO** if there is no need to associate an additional damper with a zone.

Select **SUBORDINATE** if one or more additional dampers are needed for a zone. Repeat this process to associate the outlets as needed. The screen will indicate the number of subordinate dampers associated with the zone.

Zone subordinate

- Press **NO** to change the value.

- Press   to change the subordinate zone.

- Press  to return to previous menu.

- Press  to confirm the value.

4) Thermostat type

The Main Thermostat must be configured as Master.

The thermostat's capabilities are determined by how it is configured:

- **Master thermostat:** Controls the system and zone parameters, operation mode, Time schedule programming, and AC configuration.
- **Zone thermostat:** Controls the local temperature and activation/deactivation of scheduled temperatures, and local ventilation.

Thermostat Type

- Press   to change the value.

- Press  to confirm the value.

Given that only one thermostat can be configured as Master, this parameter will not appear for selection if one thermostat in the system was already configured as Master.

* *Thermostat reset: If there was some error in the initial configuration process and it is required to make changes, follow the steps described on 25.*

3.5 Wireless Thermostat

3.5.1 Installation

Wireless thermostats are only available for wall mount. The wireless open space maximum reach between Zoning box control board & Wireless thermostat is 164 ft.

To mount the thermostat on the wall, take the following steps:

- Disassemble the thermostat in three parts as shown in the following figures. To split the frame from the base, use the edge of a coin. Do not use any sharp object.
- Affix the wall plate to the wall using screws and anchors according with the wall material.
- Reassemble the front frame to the base as shown in the following figure:

Important

Perform the pairing of thermostat in their final location.

Distances less than 18 inches between the thermostat and the control board can saturate the receivers and make the pairing impossible.

To activate Zone search

From the Home Screen of Main Thermostat:

- Press to access Configuration menu.
- Press **Settings**.
- Press **Configuration**.
- Press **Enter** on the advertisement screen.
- Press **Zone search** to access.
- Press **On** to activate.
- Press to confirm the value.

When you finish the association, turn it **OFF** to close the zone search.

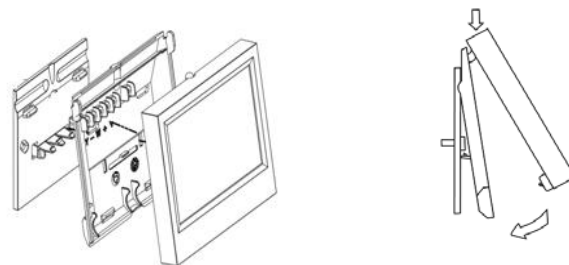

3.5.2 Wireless thermostat configuration

Before installing a Wireless thermostat, install the batteries in the thermostat.

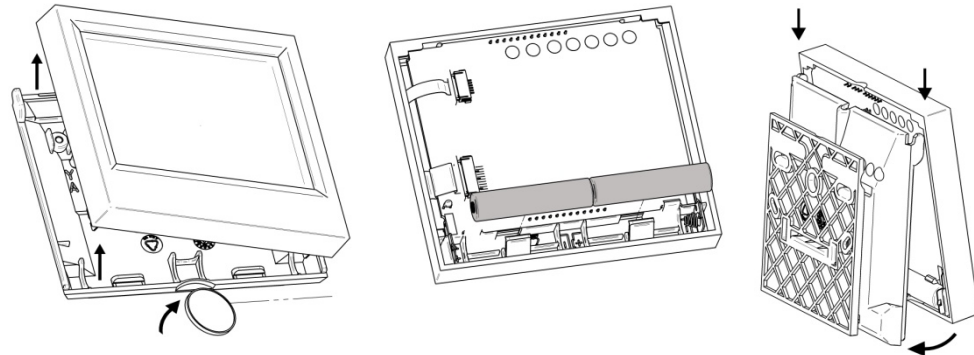

1) Zone search SCAR

In order to pair the thermostats in the system it is first necessary to open the pairing protocol process. To open this protocol, you must activate the zone search.

After initiating the pairing sequence, it will remain active for 15 minutes to pair all thermostats.

The Wireless Thermostat will display the letters SCAR. Press and hold the AIRZONE icon until the zone selection menu displays ZONE.

2) Zone selection ZONE

In this stage the zone number has to be assigned to the thermostat. Each zone corresponds to a zone damper.

The default menu displays the lowest available zone number. The menu displays the zones that are not assigned to other thermostats.

If the menu displays ZONE 0, all zones are associated and there are not any free zones.

Zone ID

- Press ▲▼ to change the value.

- Press AIRZONE to confirm the value.

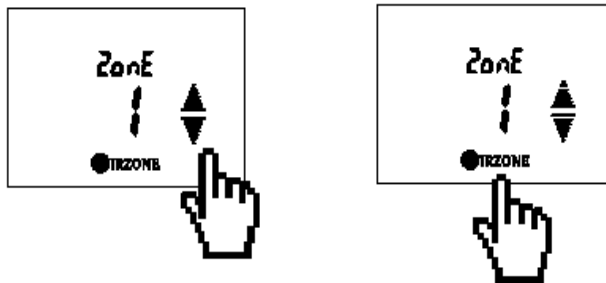

3) Subordinate damper DEP

The system allows a zone to be associated with more than one damper, if needed. This allows the control of several outlets from the same thermostat.

- 0. (Default) This option indicates that no subordinate damper is required to be associated with the zone.

- ASDC. If more than one damper is required, then the thermostat will display the first damper number available for association.

Subordinate Damper

- Press ▲▼ to change the value.

- Press ⏪ to return to previous menu.

- Press AIRZONE to confirm the value.

Repeat this process to associate the dampers that are needed.

At the top of the specific thermostat, a display indicates the number of dependent dampers associated to the zone.



* Thermostat reset: If there was some error in the initial configuration process and changes are required, follow the steps described on page 25.

4. ADVANCE CONFIGURATION

To access

Configuration menu:

From the Home Screen of Main Thermostat:

- Press  to access Configuration menu.



- Press **Settings**.

- Press **Configuration**.

- Press **Enter** on the advertisement screen.

Keep in mind

- Press the parameter to change or be selected.

- Use   to select the value.

- Press  to confirm.

- Press  to go back or exit to previous menu.

- Press  to return to main menu or Home Screen.

4.1 Main Thermostat



4.1.1 Main Thermostat Configuration Menu

Besides the quick configuration menu, the system has a number of configuration parameters to complete the installation.



- **System ID:** This option allows the installer to define the number of this system inside the whole installation. By default the value is 1. This parameter is used when there is more than one system in the same installation and it is necessary to address them. The system displays the free address values with a maximum value of 247.
- **Zone ID:** This option displays the address associated with the zone of the thermostat.



Main Thermostat reset: If the value 0 is selected it will reset the thermostat and damper associated, leaving them free for a new configuration. The thermostat returns to the first screen where the association process can begin again.

- **Subordinate:** It shows secondary control dampers associated with this thermostat. You have the following selection options:

- **Look up:** Displays the secondary dampers associated to the thermostat. Use   to display the associated zones. If **NO** is displayed, this thermostat has no associated secondary control dampers.

- **Link:** Allow associate secondary dampers to the thermostat.

Press **Link** to activate this option. Use   to select the dampers to associate and then press  to confirm. Repeat this process to associate the dampers required. If **NO** is displayed, no available zones are available to associate.

- **Release:** Release a secondary damper associated to the thermostat. Press **Release** to activate this option. Use   to select the damper to associate and then press  to confirm. If **NO** is displayed, there is no secondary damper associated to release.

- **Thermostat type:** This option shows whether the Main Thermostat is configured as **Master** or **Zone**.

- **Temperature SP range:** This menu allows you to change the maximum set point temperature for heating mode [86°F - 66°F] and minimum temperature in cooling mode temperature [64°F - 78°]. If you want to disable any of the modes, select **OFF** and the mode will be disabled for the user. By default the system has the maximum temperature in 86F° for heating and minimum temperature of 64F° for cooling.

Link

When you confirm a Link, the value displayed is the next available zone.

Keep in mind

- Press the parameter to change or be selected.

- Use   to select the value.

- Press  to confirm.



- Press  to go back or exit to previous menu.

- Press  to return to main menu or Home Screen.

Airflow



This parameter applies to all motorized dampers in the system.

It is NOT allowed when you modify the maximum Average Flow.
See on Page 14.

- **Air flow:** This menu allows you to enable or disable the modulating system dampers. Proportionality graduated in four steps, the opening or closing of the damper is based on the demand for zone temperature to adjust the flow rate.
- **Supply temp:** This option allows the system demand to be ignored if the supply temperature exceeds a certain limit. The system selects as cutting heat temperature **100-114-129-143-158 °F**. By default the system is to cut heat temperature **129 °F**.
- **Zone search:** This option allows you to open wireless channel association for connecting Wireless Thermostat to the Zoning box control board.
 - **On:** The wireless channel is open for 15 minutes.
 - **Off:** The wireless channel is closed.
- **Disable program:** The system allows you to disable the time schedule programming functions and enables Sleep Mode in the zone for the user.
 - **On:** The time programs and sleep mode are enabled.
 - **Off:** The time programs and sleep mode are disabled.
- **Information:** This option provides useful information in the system:
 - **Ambient temp:** Displays room temperatures for each of the zones in a system. Select the zone you wish to display using  .
 - **Devices:** Provides a detailed list of the various devices installed in the system: Wireless thermostats, wired thermostats, Main Thermostat (Graphic TT), Gateway (board-enabled Daikin interface, and wireless channel).

Keep in mind

- Press the parameter to change or be selected.

- Use   to select the value.

- Press  to confirm.

- Press  to go back or exit to previous menu.

- Press  to return to main menu or Home Screen.

- **Firmware:** The information displayed for the system check: Main Thermostat and Zoning box control board firmware.
- **Q-Adapt:** This option allows the user to select the system velocity map adequate for the installation. The available options are:
 - **Q Power:** Promotes increased flow in the velocity map.
 - **Q Standard:** Default configuration.
 - **Q silence:** Noise reduction.
 - **Q Minimum:** The indoor unit fan coil works at minimum speed.
 - **Q Maximum:** The indoor unit fan coil works at maximum speed.
- **Offset:** This option allows the user to apply an offset on the room temperature of the zone. The possible values will range from **-5°F** to **+5°F** in 1°F. The default value is **0**. This offset will be applied immediately on the room temperature of the zone.
- **Weight:** With this option you can set the weight of the zone. The weight of the zone will be used for calculating the mode (auto-change over) or for calculating heat demands if auxiliary heat. It is an indicator of the size / importance of the zone. Possible values range from **0-100**. The default value is **100 / Number zones**.
- **Setback:** Unoccupied time schedule programming is determined by two settings:
 - **Disable:** If the default demand temperature is surpass (°F, 4°F), the area will cease the demand.
 - **Override Time:** Is the time that the zone will enter in occupied mode when the user touches the thermostat screen during an unoccupied period. [10-120] minutes, 60 minutes by default.
- **Auxiliary Heat:** The operation of auxiliary heat is influenced by several parameters:

Keep in mind

*If the setting is not confirmed with the **continue** button,  the new settings will not be saved*

- Auxiliary heat (1)

- Defines how many stages of auxiliary heat a system has. Possible values are 0, 1, and 2, with a default of 0.
 - **0:** There is no auxiliary heat. The system works only with the heat pump. If set to 0, Emergency Heat mode will not be available.
 - **1:** One-Stage Auxiliary Heat.
 - **2:** Two-Stage Auxiliary Heat.
- First Supply Heat. If the setting for Auxiliary heat is 1 or 2, then the first system to supply heat must be defined as either:
 - **Heat Pump.**
 - **Aux. Heat.**

Auxiliary Heat (2)
Only displays if One/Two Stage is selected.

- **Auxiliary Heat (2) Fan Configuration:** In the second screen configuration, there are the following parameters:
 - Heating device: Defines if the ID unit fan must be active during the auxiliary heat operation.
 - **Electric (Fan ON).**
 - **Furnace (Fan OFF).**

****Note: If the auxiliary heat is electrical, then the first to supply heat must be set to be the Heat Pump.***

Auxiliary Heat (3)
Only displays if One/Two Stage is selected.

- **Auxiliary Heat (3) First Stage Activation:** the user must define three parameters:
 - Second Stage Differential: Temperature the system has to surpass to activate the first stage of auxiliary heat. Values **[2-10]°F**, by default **2°F**.
 - First stage hysteresis: Defines the hysteresis for the operation of the first stage. Values **[1-3]°F**, by default **1°F**.

- Min time exhausted: the minimum time that must be active the Heat Pump before the first stage of auxiliary heat can be activated. Values [0-120] minutes, by default, 30 minutes
- **Auxiliary Heat (4) Second stage activation**: the user must define three parameters:
 - Second stage differential: Temperature the system has to surpass to activate the second stage of heating. Values [2-10]°F, by default 2°F.
 - Second stage hysteresis: It defines the hysteresis for the operation of the second stage. Values [1-3]°F, by default 1°F.
 - Minimum time exhausted: the minimum time that must be active the first stage before the second stage of auxiliary heat can be activated. Values [0-120] minutes, by default, 30 minutes.
- **Autochange**: This option of the configuration menu, the user sets the three values that define the operation of the auto-changeover.
 - Set point Differential: Minimum differential between heating and cooling set points. For example, if set to two degrees Fahrenheit, the system will force the cooling set point is at least two degrees lower than the heat. Values [0-7]°F, by default 2°F.
 - Mode Switching Protection: Minimum run time in a way before allowing a mode change. Values [15-90] minutes, by default 30 minutes.

Auxiliary Heat (4)

Only displays if Two Stage is selected.

Keep in mind

- Press the parameter to change or be selected.

- Use   to select the value.

- Press  to confirm.

- Press  to go back or exit to previous menu.

- Press  to return to main menu or Home Screen.

To access Interface menu

From the Home Screen of Main Thermostat:



- Press  to access Configuration menu.

- Press **Settings**.
- Press **Interface** to access.

- **Heat OVR Temp**: If a zone has a higher heat demand than this temperature, the system reverts heating operation, even though the cold global demand exceeds the heat demand. Possible values are: Not applicable, [3 to 8] °F in steps of 1°F. Default value: Not applicable.

Keep in mind

- Press the parameter to change or be selected.

- Use   to select the value.

- Press  to confirm.

- Press  to go back or exit to previous menu.

4.1.2 Interface Menu

This menu allows the user to modify several options related to the Main Thermostat controller interface.

Brightness

- Select the screen brightness for both active mode.
- Select the standby mode (**Off** or **Bright**).

Date & Time

Select Date:

- Select current day, month and year.

Select time:

- Select current time.
- Select a 12-hour (AM/PM) or 24-hour time format.
- Enable or disable daylight savings.

Language

Select among 3 languages:

- **Español**
- **English** (default)
- **Français**

Beeping

Select the beeping sound mode:

- **Sound ON** (default)
- **Sound OFF**

4.1.3 User Settings

On this menu the user will be able to configure some parameters:

Units

Select temperatures to be displayed:

- °C (Celsius)
- °F (Fahrenheit)

Vacation

The Vacation mode feature helps you conserve energy while you are away for extended periods of time. Select type of Vacation mode:

- **System.** Active (**On**) or deactivate (**Off**) vacation mode to all zones in the system.
- **Zone.** Active (**On**) or deactivate (**Off**) vacation mode to the current zone. Display the set temperatures:
 - **Heat.** Select 52-54-56°F.
 - **Cool.** Select 89-91-93°F.

Global Ventilation

Global Ventilation allows to activate the ventilation in all zones system during the system inactivity periods.

Select Status.

- **NO:** Disables Global ventilation.
- **YES:** Enables Global ventilation.
 - **Every __ (mins).** Length of the interval between periods of ventilation. (in minutes)

Run for (mins). Duration of ventilation. (In minutes)

Local Ventilation

Local ventilation allows activate the ventilation in the Main Thermostat zone during the system inactivity periods. Select Status:

- **On:** Enables Local ventilation.
- **Off:** Disables Local ventilation.

To access Interface menu:





From the Home Screen of Main Thermostat:

- Press  to access Configuration menu.

- Press **Settings**.
- Press **User setting** to access.

Global ventilation





When global ventilation is activated, the icons are displayed on the home screen as follows:

- Stop 
- Heat 
- Cool 
- Dry 

Local ventilation

Not available for the  operation mode.

Keep in mind

- Press  to access to the menu. The value is blinking when it is enable to edit.
- Press  to go back.
- Press   to select the value.
- Press  to edit a value or confirm.

4.2 Wireless Thermostat Configuration

4.2.1 Access to the Configuration Menu



To access the advanced setup menu, the Wireless Thermostat must be off. by pressing the ON/OFF icon.



Press the screen



Press the On/Off icon

- On the Home Screen, press the  icon until the test screen icon is displayed.
- Upon releasing the  icon, the zone temperature will be displayed.
- At this time, press and hold again the  icon until the first parameter is displayed.

From this menu, press  to return to the standby screen.

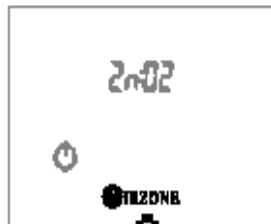

Long press



Long press



4.2.2 Configuration Menu

Besides the quick configuration menu, the system has a number of configuration parameters required to complete the installation. The following configurations are available:

- **Zone Zone ID:** This option displays the address associated with the zone of the thermostat.

Wireless Thermostat reset:

If the value **0** is selected, the thermostat and its associated damper(s) will reset, freeing them for a new configuration. The thermostat then returns to the first screen to allow you to start the association process again.

- **dEP Subordinate dampers:** Show the dampers associated to the thermostat.

Look up:

Displays the secondary dampers associated to the thermostat.

- Press **AIRZONE** to see all the subordinate dampers associated to current thermostat. The values begin blink.
- Use the arrows **▲▼** to change values.

If it displays **n0**, indicates that the thermostat has no damper associated to it.

Link:

Allow associate secondary dampers to the thermostat. The value then blinks.

- Use the arrows **▲▼** to select **RS0**.
- Press **AIRZONE** to access link menu which then displays. Displays **RS0C** and the damper numbers available for association.
- Use the arrows **▲▼** to select the value.
- Press **AIRZONE** to confirm the value which displays **n0**.

Repeat this process to associate the dampers you need.

Press **AIRZONE** with value **NO** to end the association and the screen returns to the Look-up menu.

Release:

Release a secondary damper associated to the thermostat.

The value then blinks.

- Use the arrows **▲▼** to select the value.
- Press **AIRZONE** to access the release menu which then displays **rL5**.

Keep in mind

- Press **AIRZONE** to access to menu. The value blinks when editing is available.
- Press **⏪** to go back.
- Press **▲▼** to select the value.
- Press **AIRZONE** to edit a value or confirm.

Look Up

If you displays **n0** when you access to **dEP** menu, means there isn't secondary dampers associated.

Link

If you displays **n0** when you access to link menu, means no secondary dampers available.

Keep in mind:





- Press **AIRZONE** to access to menu. The value blinks when editing is available.
- Press **⏪** to go back.
- Press **▲▼** to select the value.

Press **AIRZONE** to edit a value or confirm.

- Use the arrows **▲▼** to select **YES** to release or **NO** to cancel the release.
- Press **AIRZONE** to confirm the value and return to the Look-up menu.
- **INFO System information:** This option provides useful information about the system.
 - **Room Room temperature:** This option displays room temperature for each zone.
 - Press **AIRZONE** access.
 - Use the arrows **▲▼** to navigate the room temperatures for each remote zone **1**.
 - **Radio Level:** This option shows the receiving signal power in percentages **85**.
If **--** appears in the screen, there is no radio reception.
 - **Battery level:** Displays battery level of the thermostat in percentages.
 - **Device's System:** Provides a detailed list of the devices installed in the system: Wireless thermostats, Main thermostats, Daikin interface, and wireless channel. To access, touch **AIRZONE** and use the arrows **▲▼** to navigate through the different devices.
 - **W:** Number of Wireless thermostats connected to the Zoning box control board.
 - **W C:** Number of wired thermostats connected to the Zoning box control board. (N/A)
 - **WbF:** Main Thermostat connected to the Zoning box control board.
 - **CHi:** Wireless communication channel. Between **1** to **6**.
 - **GU:** When **Ac** is displayed, the Daikin Interface Board is enabled on the zoning box control board.

- **Firm Firmware:** The information displayed for the system check such as the current thermostat and Zoning box control board firmware:
 - **CSFU:** Zoning box control board firmware version.
 - **ZTFU:** Wireless Thermostat firmware version.
- **Offset Offset:** This option allows the user to apply an offset to the room temperature reading. The offset range goes from **-5 °F** to **+5 °F**. The default value is **0**. This offset will be applied immediately on the room temperature of the zone.
- **PERC Weight:** With this option the installer can set the weight of the zone. The weight of the zone is used to calculate the mode (auto change) or to calculate the heat demands when the auxiliary heat is active. It is an indicator of the size / importance of the zone. Possible values range from **0- 100**. The default value is **100** zones.

Keep in mind

- Press  to access to menu. The value blinks when editing is available.
- Press  to go back.
- Press  to select the value.
- Press  to edit a value or confirm.

4.2.3 User Settings

This section describes how to configure user settings.

- **Unit Units**

Select temperatures to be displayed.

- **°C** (Celsius)
- **°F** (Fahrenheit)

- **VACA Vacation status**

The Vacation mode feature helps you conserve energy while you are away for extended periods of time. It also ensures your home is comfortable when you return.

Select status:



- **On** Enable
- **OFF** Disable

To User access

From home screen:

- Turn Off the room .

- Short Press on  to advance screen.

Display   .

- Long Press on  till display **Unit Units**.

- **EURC Vacation set point temperatures**

Select the set temperatures:

- **Heat.** Select 52-54-56°F
- **Cool.** Select 89-91-93°F

4.2.4 Other functions

- **Time schedule programming disable**

The system allows disabling functionality for zone- scheduled temperature settings. To access the advanced setup menu the Wireless Thermostat zone must be off by pressing the ON/OFF icon.



Press the screen



Press the On/Off icon

- On the Home screen, press and hold the highlighted area in the following figure to access.



- To confirm the change, touch the AIRZONE icon to select the new setting and once again to go back to the standby screen.

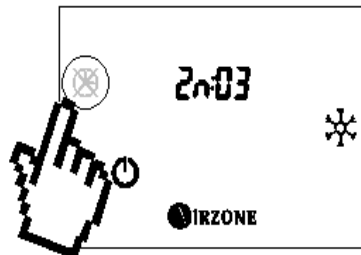

- **Time schedule programming enable**

To enable this option, press and hold the highlighted area in the following figure to access the **ON** screen.

To confirm the change, touch the icon to select the new setting and once again to return to the standby screen.

5. COMMISIONING STEPS

5.1 Turn on power to all systems

Main Thermostat. Verify that the device boots up (square clock icon will display temporarily). After a few seconds the configuration screen is displayed.



Configuration screen of the Main Thermostat

Main control Board. Verify that the LEDs status is correct.

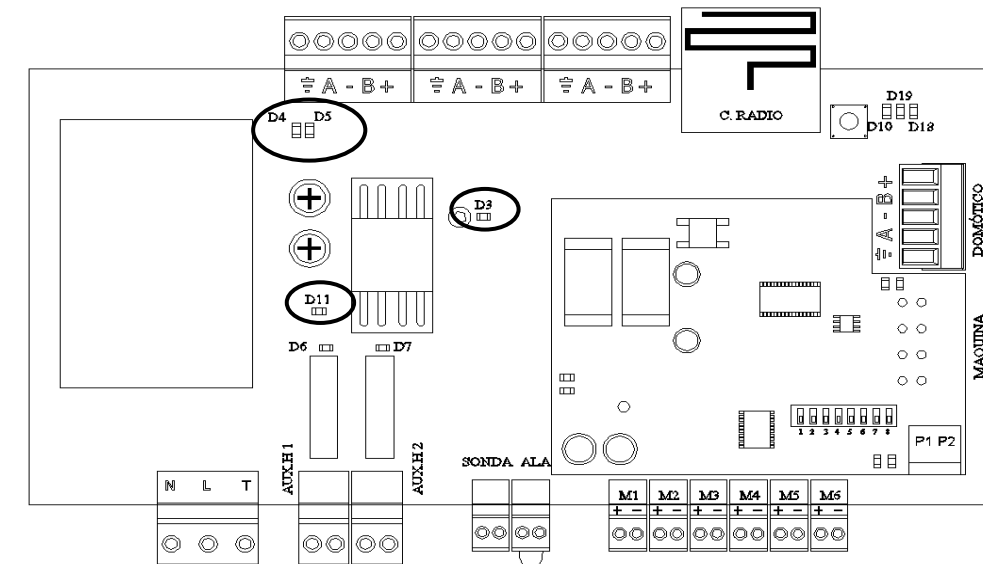

Ref	LED indication	Normal status	Color
D3	Control Board Internal Bus Activity	Blinking	Green
D4	Transmit data in the expansion bus	Blinking	Red
D5	Receive data in the expansion bus	Blinking	Green
D11	Power supply	Fixed	Red

LEDs status

Daikin interface Board. Verify that the LEDs status is correct.

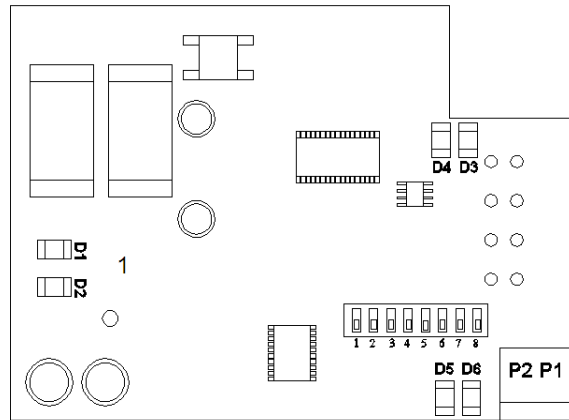

Correct LEDs status

Ref	LED indication	Normal status	Color
D1	Daikin Interface board power supply	Fixed	Red
D2	Daikin Interface board internal bus activity	Blinking	Green
D3	Data transmission to the DZK system	Blinking	Red
D4	Data reception from the DZK system	Blinking	Green
D5	Data transmission to DAIKIN thermostat	Blinking	Red
D6	Data reception from DAIKIN thermostat	Blinking	Green

LEDs status

Wireless Thermostat. Verify the word **SCAN** is displayed on the screen.



Wireless Thermostat during scanning

5.2 Communications with the Indoor unit – Modes/Temperature

- Check that the Navigation Controller receives the operating mode change from the zoning system. To verify that, change the operating mode on the Main thermostat and verify that the new mode appears in the Navigation Controller.

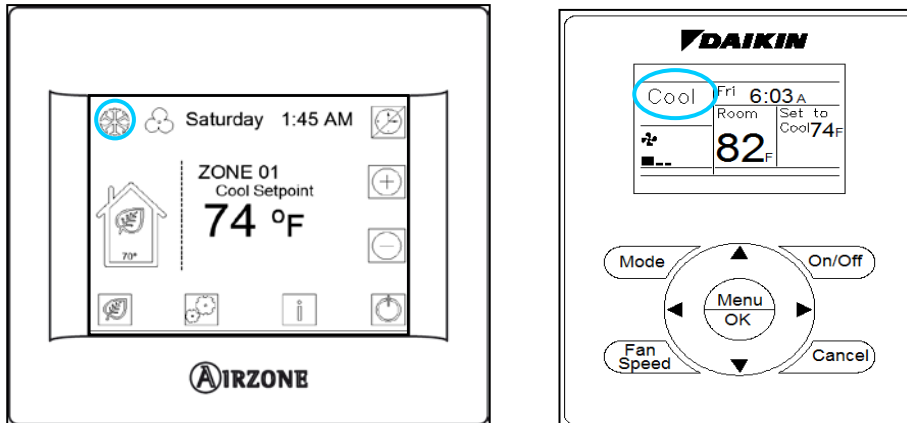

Airzone Main Thermostat and Daikin Thermostat

- Check that the Daikin thermostat receives the temperature changes from the zoning system. To do this, deactivate all thermostats but the Main thermostat. Change the main thermostat set point, and verify that the set point in the Daikin thermostat follows the specified set point changes.

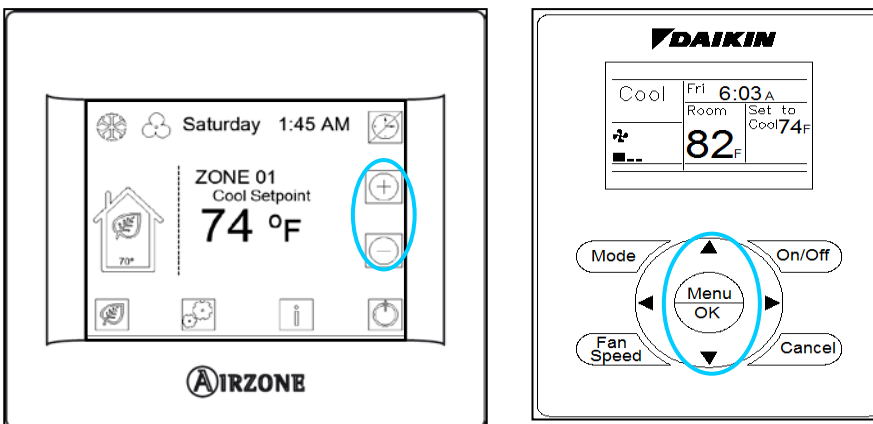

Airzone Main Thermostat and Daikin navigation controller

5.3 Zone assignment

- Activate every thermostat, one at a time, and set it for demand by pressing Select mode > Remote zone (see the section Remote Zone Control from the User's Manual). Verify that the zone where the thermostat is located is receiving air. Change the set point to eliminate the demand, and verify that the airflow stops.

5.4 Air flow regulation

- Check the change of the fan speed depending on the number of demand zones in the Q-Standard.
- Remember that the Q-Adapt function is available in the Main thermostat to adapt the velocity map according to the installation requirements.

2 speed indoor unit

N° Zones	Zones calling demand	Q-Minimum	Q-Silence	Q-Standard	Q-Power	Q-Maximum
6	6	1	2	2	2	2
	5	1	2	2	2	2
	4	1	1	2	2	2
	3	1	1	1	2	2
	2	1	1	1	1	2
	1	1	1	1	1	2
5	5	1	2	2	2	2
	4	1	2	2	2	2
	3	1	1	2	2	2
	2	1	1	1	2	2
	1	1	1	1	1	2
4	4	1	2	2	2	2
	3	1	1	2	2	2
	2	1	1	1	2	2
	1	1	1	1	1	2
3	3	1	2	2	2	2
	2	1	1	2	2	2
	1	1	1	1	2	2
2	2	1	1	2	2	2
	1	1	1	1	2	2

Fan speed depending on the number of demand zones

3 speed indoor unit

N° Zones	Zones calling demand	Q-Minimum	Q-Silence	Q-Standard	Q-Power	Q-Maximum
6	6	1	3	3	3	3
	5	1	2	3	3	3
	4	1	2	2	3	3
	3	1	2	2	2	3
	2	1	1	1	2	3
	1	1	1	1	1	3
5	5	1	3	3	3	3
	4	1	2	3	3	3
	3	1	2	2	3	3
	2	1	1	2	2	3
	1	1	1	1	1	3
4	4	1	2	3	3	3
	3	1	2	3	3	3
	2	1	1	2	3	3
	1	1	1	1	2	3
3	3	1	2	3	3	3
	2	1	1	2	3	3
	1	1	1	1	2	3
2	2	1	1	3	3	3
	1	1	1	2	3	3

Fan speed depending on the number of demand zones

- Check with an anemometer that the air supply to each zone is the desired amount. Verify the airflow with all zones open, and also individually with each zone open.
- Before setting maximum opening (REG), ensure that the zone damper is closed. To do this turn off the zone to be adjusted while keeping any other zone calling demand (See User's Manual).

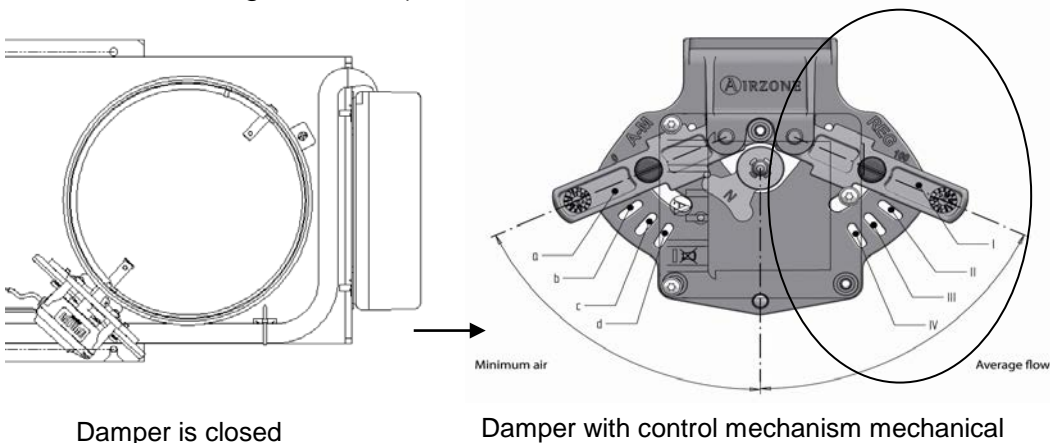

Damper is closed

Damper with control mechanism mechanical

5.5 Other configuration parameters

- If the installation has Auxiliary Heat, verify that it is correctly installed and configured. Verify that the Operation Mode menu displays Emergency Heat as an option.

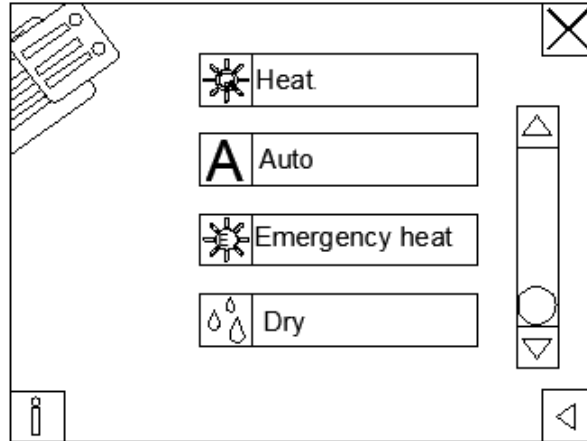

Operation Mode menu

- If you use Auxiliary Heat check the relays operation in the zoning box control board to ensure it is working properly (first H1, then H2). To verify, set the system calling demand for heat and keep in mind that there is an activation delay.

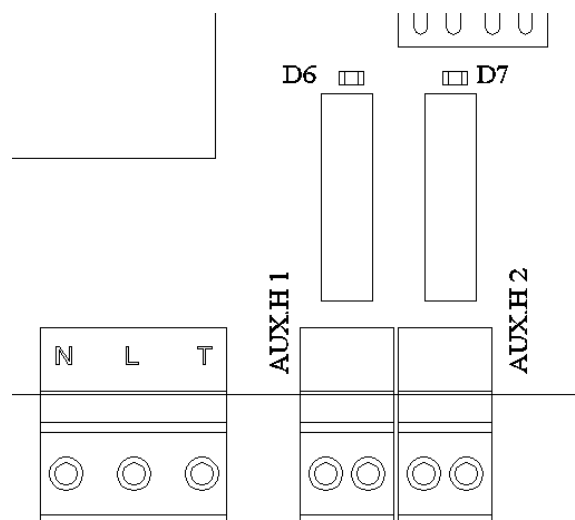

Relays operation of the zoning box control board

Ref	LED indication	Aux. Heat Status	Normal status	Color
D6	1st Stage Aux. Heat	On	On	Green
		Off	Off	
D7	2nd Stage Aux. Heat	On	On	Green
		Off	Off	

Relays operation of the zoning box control board

- Turn the system off and verify that H1 and H2 are disabled.

6. EXCEPTION CODES

In the event of Zoning system alerts, the system displays an error code on the home screen of the thermostat where the error is detected.

If there is an alert originated by the Daikin Unit, the Main thermostat displays an error text and an

exclamation mark on the help icon  until the problem has been solved.

Review the message with the Daikin Unit documentation and solve the issue according to Daikin recommendations.

List of DZK zoning box system alerts

Your Main Thermostat can generate the following alert messages:

UnOC Unoccupied. The Setback time program is active. If you touch on the Home screen, it will deactivate the setback program and return to occupancy set point during the override time.

ECD Eco limit. The user has tried to exceed the Eco-Adapt temperature limit. If required, disable the Eco-Adapt to set the desired temperature.

OUEr Override. The override time is active. When the override time has finished, the system returns to its previous status.

uAcA Vacation. The vacation mode is active.

Err 1 Error 1. Communication error between Main Thermostat and the Control Board. This error blocks the thermostat.

Corrective actions:

- Verify the status of the Zoning box control board.
- Verify the connections and the wiring between the Zoning box control board and the Main Thermostat.
- Verify the radio communications between the Wireless Thermostat and the Zoning box control board.

Err 9 Error 9. Air-conditioning communication error with the system. The system opens every motorized outlet and control from the air-conditioning controller is enabled.

Corrective actions:

- Verify the Daikin Interface board status.
- Verify the wiring connection between the Daikin Interface Unit and the Daikin Indoor unit.

7. AUTO DIAGNOSTICS

7.1 Zoning box control board

The Zoning box Control Board has integrated LED's that provide information of abnormal conditions.

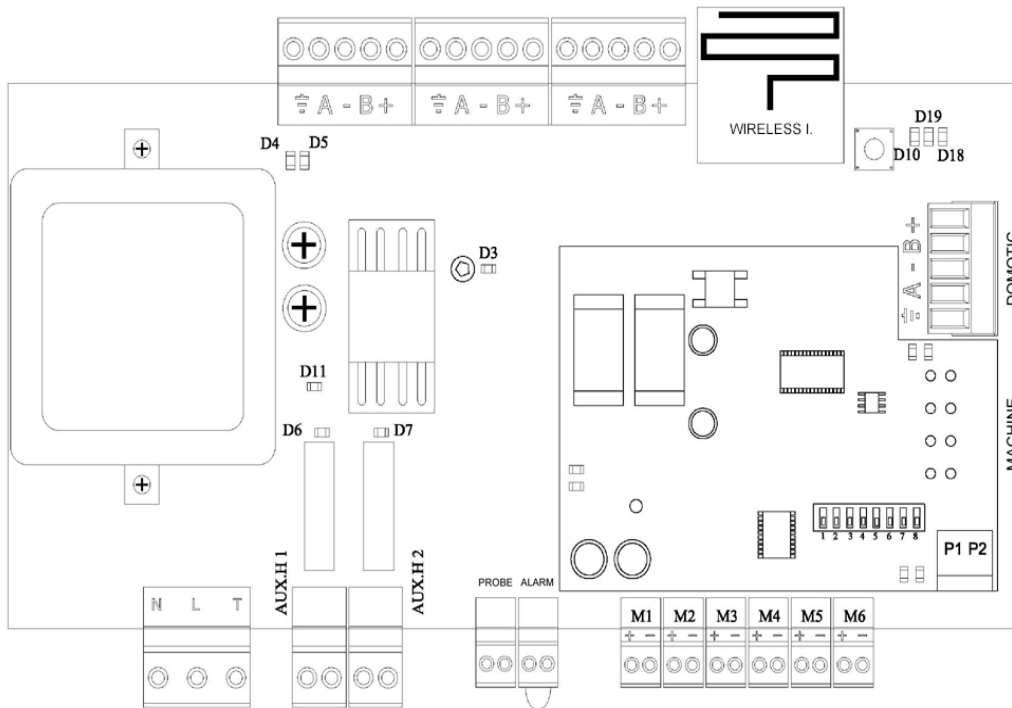

Ref	LED indication	Normal Status	Color
D3	Control Board Internal Bus Activity	Blinking	Green
D4	Transmit data to Main Thermostat	Blinking	Red
D5	Receive data from Main Thermostat	Blinking	Green
D6	1 st Stage Aux. Heat Activated	Fixed	Green
D7	2 nd Stage Aux. Heat Activated	Fixed	Green
D10	Packet radio reception	Blinking	Green
D11	Power supply	Fixed	Red
D18	Wireless Thermostat associated	Fixed	Green
D19	Radio link active	Fixed	Red

7.2 Daikin Interface Board

Daikin's interface board has integrated LED's that provide information about abnormal conditions.

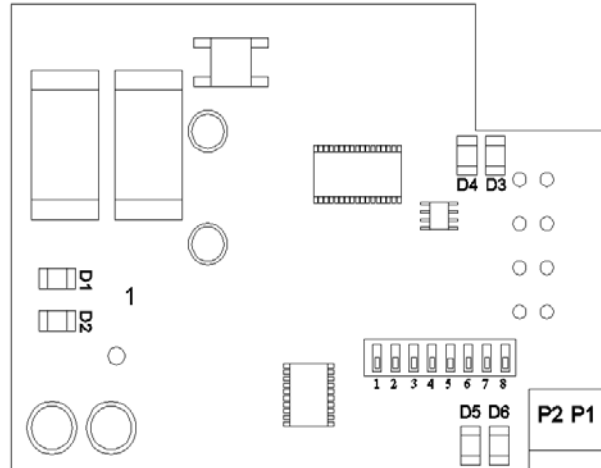

Ref	LED indication	Normal Status	Color
D1	Interface power supply	Fixed	Red
D2	Daikin Board Internal Bus Activity	Blinking	Green
D3	Data transmission to Zoning box control board	Blinking	Red
D4	Data reception from Zoning box control board	Blinking	Green
D5	Data transmission to Daikin navigation controller	Blinking	Red
D6	Data reception from Daikin navigation controller	Blinking	Green

- 1) **Power Supply LED (D1) is not ON**
 - Verify the AC Unit Power Supply.
 - Verify the correct connection between the Daikin Indoor unit and the Daikin interface board.
- 2) **Microcontroller Activity LED (D2) does not blink**
 - Contact Technical Support.
- 3) **Zoning box control board Communication LED's (D3/D4) does not blink**
 - Check the connection between the Daikin Interface board and the Zoning box control board.
- 4) **Indoor AC Unit Communication LED's (D5/D6) do not blink**

Check the correct connection between the Daikin Indoor unit and the Daikin interface board.

8. NAVIGATION GUIDE

8.1 Main Thermostat navigation guide

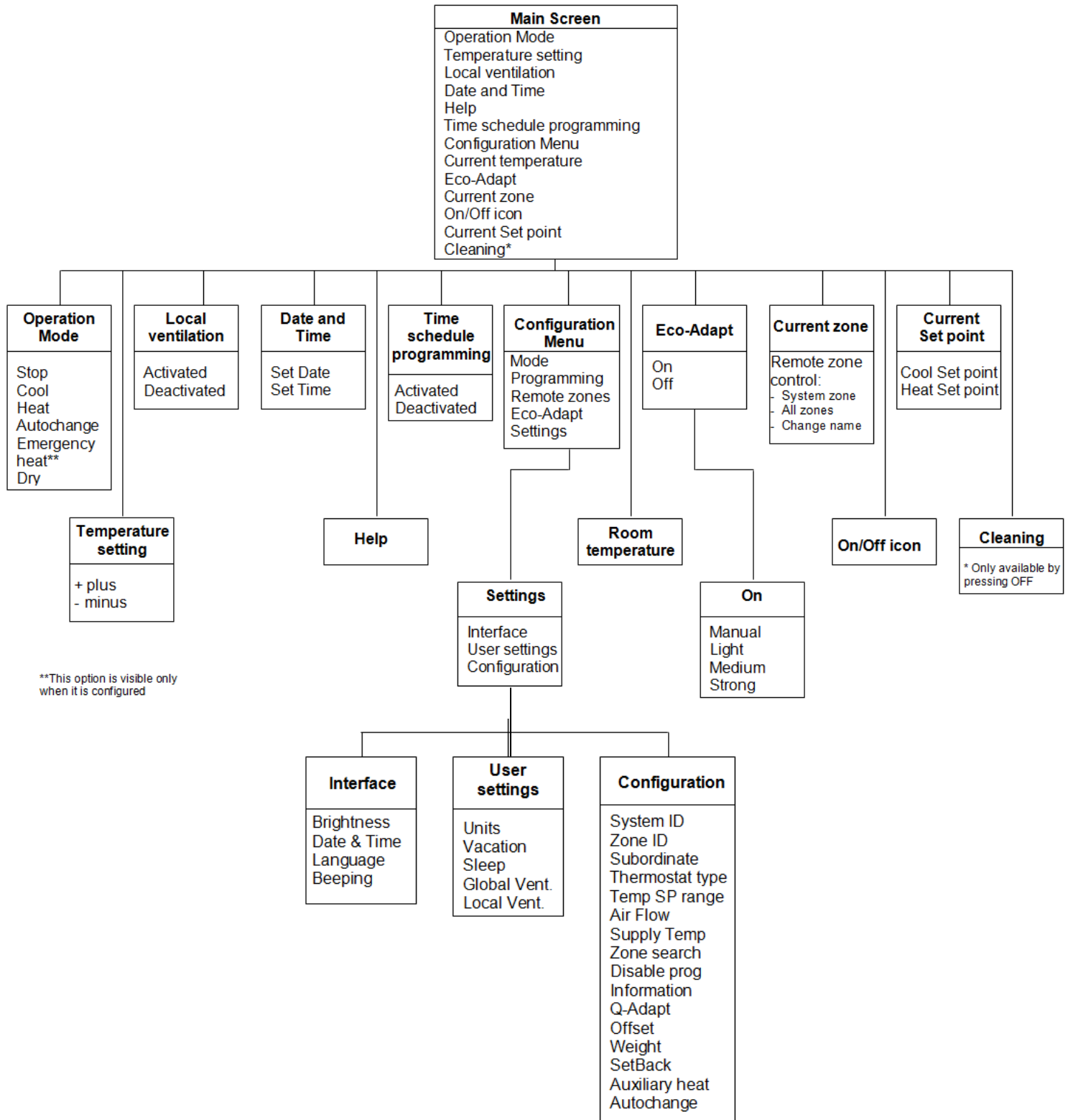

8.2 Wireless Thermostat navigation guide

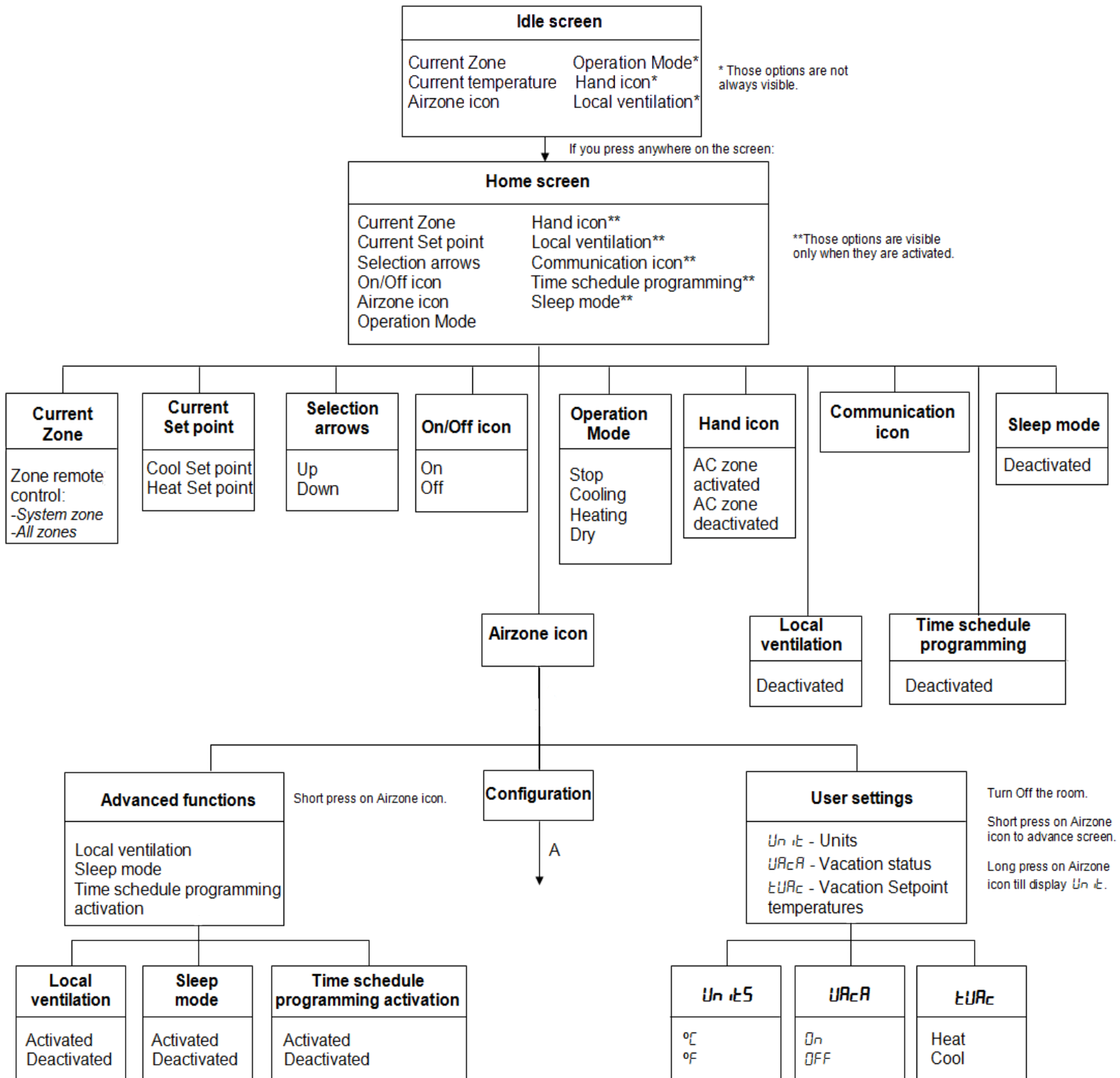

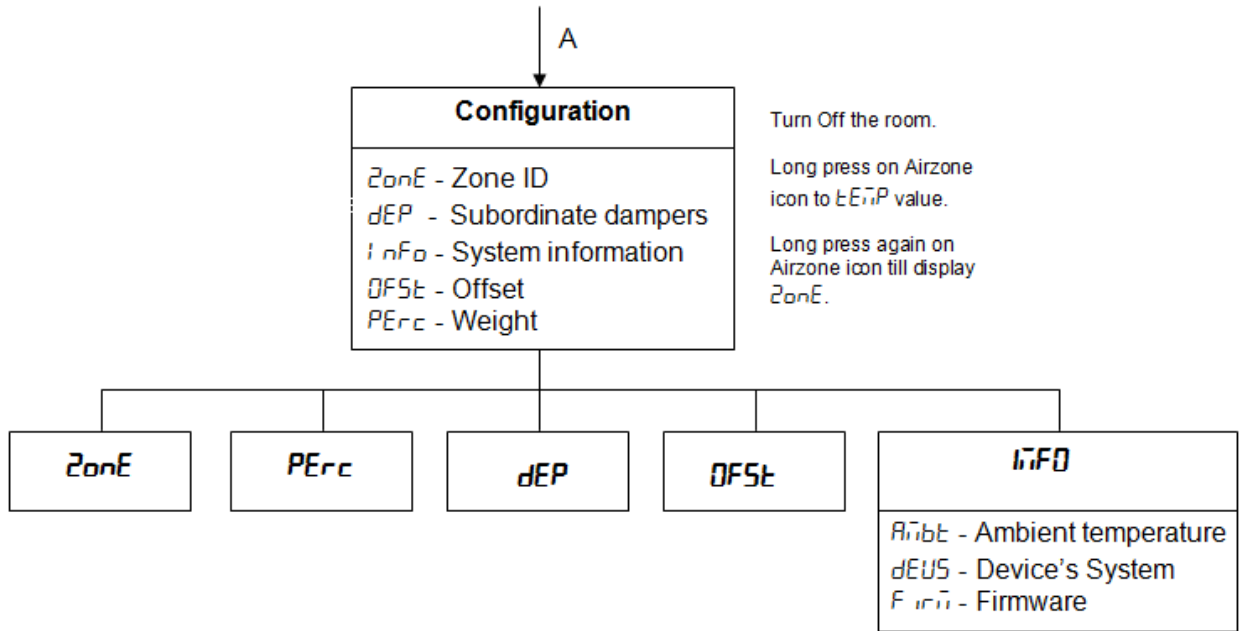

9. TROUBLESHOOTING

Item	Symptom	Verification/Action
1	Main Thermostat does not light up.	Verify the cable connection between the Main thermostat and the Control Board. Never use solid wire for this connection.
		Verify that the elastic contacts in the base of the thermostat are securely fastened to the circuit board. To ensure this contact, slightly bend forward the contacts.
		Verify that the voltages between the + and - contacts in the thermostat base are 12VDC.
		The zone controlled from the main thermostat cannot be remotely accessed. After 45 minutes, its damper(s) will open and remain open until the problem is fixed.
		From any other zone thermostat, accessing the remote zones by selecting ALL will allow you to change the Operation Mode until the Main Thermostat returns to normal operation.
		If the thermostat is replaced, only perform the initial configuration. All other parameters and settings will be recovered automatically from the Control Board.
2	Wireless thermostat does not work.	Verify polarity and power level of the batteries.
		The zone controlled from the wireless thermostat cannot be remotely accessed. After 45 minutes, its damper(s) will open and remain open until the problem is fixed.
		If the thermostat is replaced, only perform the initial configuration. All other parameters and settings will be recovered automatically from the Control Board. Reset the thermostat and thereafter perform an initial configuration.
3	After a power failure, Err 1 appears in the WTs.	The Wireless thermostats can take up to 5 minutes to update the screen. Touch the screen to force an immediate update.
4	The AC unit does not start even if everything is OK. After setting the mode to COOL , the Main Thermostat shows STOP .	Verify that there is a jumper between the contacts of the Alarm connector.
		Verify that the Indoor Unit is powered on.
		Verify that the Daikin Communication LEDs D5 and D6 located in the Daikin Interface board mounted over the Control Board are blinking.
5	When accessing remote zones, one of them is not listed.	Verify that the thermostat of the zone missing is working correctly. To this end, activate/deactivate the zone and check that the damper opens/closes correctly.
6	The Wireless Thermostat displays all zones but its own.	When trying to remote access other zones, the Wireless Thermostat will not display its own zone.
7	LED D3 in the Control Board is not blinking.	Verify that the Control Board is powered.
		If the power LED (D11) is on, the Control Board is faulty.
8	LED D5 in the Control Board is not blinking.	The board is not receiving information from the Main Thermostat. Verify the wiring between the Main Thermostat and the Control Board. Never use solid wires for this connection.
9	On activating the zone, no air is supplied to its grille(s) if the fan in the coil is on.	Verify that the damper assigned to the thermostat is not blocked by the insulation stopper.
		Verify that the motor is electrically connected properly. There is a connection at about 4 inches from the actuator.
		Verify in the actuator connection indicated above, that when demand is created from the thermostat, there are 12VDC between the contacts indicated above. This voltage will be present for about 5 seconds.
		Verify that the zone assigned to the thermostat is the correct one. If it is not the correct damper, proceed to reset the incorrectly assigned thermostats and reassign to the correct zones.

Item	Symptom	Verification/Action
10	One Wireless Thermostat shows “SCA” permanently.	<p>Ensure that the Zone Search is active. From the Main Thermostat: Setting>Configuration>Zone Search.</p> <p>Verify that there are available zones. The number of available zones depends on the DZK model, despite that the thermostat can show up to 6. Verify if there is any zone that has a dependent zone. In the Remote Zone menu in the Main Thermostat, verify which zones are installed.</p> <p>Bring the thermostat closer to the DZK Zoning Box, and associate it with a zone. Once completed, take it back to its final location. If the thermostat shows Err 1 or the signal power is too low, the distance to the control board is too great or there is too much radio interference. There are two possible solutions to this situation: Verify by moving the thermostat within the zone to see if it gets a good connection (remember to touch the screen to update it immediately), or install a wired Main thermostat into a configured zone.</p>
11	What do I do if one or more zones do not control the temperature?	<p>Verify that the Operation Mode is not STOP (see point 4).</p> <p>Verify ambient and set point temperatures in the non-working zone thermostat to see if it is creating demand.</p> <p>Verify that the damper actuator is connected properly at about 4 inches from the actuator.</p> <p>Verify communications between the Daikin Interface Board and the Indoor Unit (LEDs D5 and D6 in the Daikin Interface Board).</p> <p>Verify that no ERR number is shown on the screen.</p> <p>If D5 and D6 do not display normal behavior (constant blinking), verify the wiring between the Daikin interface Board and the Indoor Unit.</p>
12	How much time do I have left when the battery symbol is shown?	<p>When the battery icon is shown on the screen, there are about 15 days left to change the thermostat batteries.</p>
13	Error 1 on the Main Thermostat.	<p>If the Zoning box control board has just been powered on, Error 1 will display on the screen until the system completes its boot process (about 30 seconds).</p> <p>Verify that LEDs D4 and D5 are blinking, which indicates there is communication between the Control Board and the Main Thermostat.</p> <p>Verify the connections and the wiring between the Main Control Board and the Main thermostat.</p>
14	Error 1 on the Wireless Thermostat. (Err 1)	<p>If the zoning box control board has just been powered on, Error 1 will show on the screen until the system completes its boot process (about 30 seconds). Keep in mind that the wireless thermostat screen can take up to 5 minutes to update. However by touching its screen, it will update immediately.</p> <p>Verify the radio communications LEDs (D10) between the Wireless Thermostat and the Main Control Board.</p>
15	Error 5 on the Main & Wireless Thermostat.	<p>Remote temperature sensor assigned to the thermostat is open.</p>
16	Error 6 on the Main & Wireless thermostat.	<p>Remote temperature sensor assigned to the thermostat is short circuited.</p>
17	Error 9 on the Main & Wireless thermostat.	<p>Verify that the Indoor Unit is powered on.</p> <p>Verify the Daikin Interface board LEDs status.</p> <p>Verify the wiring connection between the Daikin Interface Unit and the Daikin Indoor Unit.</p>
18	The damper-modulating functionality does not work properly (Airflow >Modulating setting).	<p>Verify that the damper REG level is located at maximum opening.</p>



Parque Tecnológico de Andalucía

C/ Marie Curie, 21-29590

Campanillas - Malaga

SPAIN

TEL: +34 902 400 445

Fax: +34 902 400 446

<http://www.DZK zoning box.es>

<http://www.DZK zoning boxusa.com>

