

User's Manual



TABLE OF CONTENTS

Warnings and Environmental policy	3
FCC Regulatory Notices	4
DZK Interfaces	5
Wired Thermostat	6
Getting to know your Wired Thermostat	6
Main Screen Display	6
Screensaver	7
Using your Wired Thermostat	8
Adjusting the temperature	8
Operation Mode	8
User Mode	9
Airflow Control	9
Local Ventilation	9
Time Schedule	10
Zone Navigation	11
User Settings	11
Zone Settings	12
Warnings and Errors	13
Wireless Thermostat	14
Getting to know your Wireless Thermostat	14
Main Screen Display	14
Screensaver	15
Using your Wireless Thermostat	16
Navigation	16
Adjusting the temperature	16
About the battery	17
Setting Parameters	18
Warnings and Errors	19
Wireless Lite Thermostat	20
Getting to know your Wireless Lite Thermostat	20
Using your Wireless Lite Thermostat	21
Adjusting the temperature	21
About the battery	22
Warnings and Errors	22
Navigation Guides	23
Wired Thermostat	23
Wireless Thermostat	23

WARNINGS AND ENVIRONMENTAL POLICY

WARNINGS

For personal safety and protection of the equipment, use the following safety precautions:

- Do not handle the system with wet or damp hands.
- Disconnect the power supply before making any connections.
- Disconnect the power supply from the air conditioning and heating system before connecting or disconnecting equipment.
- Take care not to cause a short circuit in any of the system's connections.

ENVIRONMENTAL POLICY

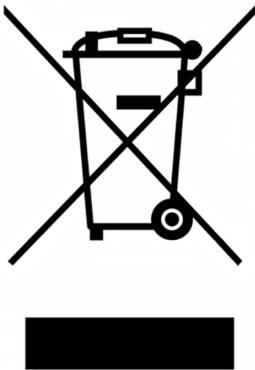

Do not dispose of this equipment with household waste. Electrical and electronic equipment contain substances that may damage the environment if not handled appropriately. The symbol of a crossed-out waste bin indicates electrical equipment that must be disposed separately from other urban waste. For correct environmental management, it must be taken to the collection centers provided for this purpose when it is no longer usable.

Equipment components may be recycled. Act in accordance with current regulations on environmental protection.

If you replace it with other equipment, you must return it to the distributor or take it to a specialized collection center.

Those breaking the law or by-laws will be subjected to environmental protection fines.

FCC REGULATORY NOTICES

Modification statement

Corporación Empresarial Altra S.L. has not approved any changes or modifications to this device by the user. Any changes or modifications could void the user's authority to operate the equipment.

Interference statement

This device complies with Part 15 of the FCC Rules. Operation is subject to the following two conditions: (1) this device may not cause interference, and (2) this device must accept any interference, including interference that may cause undesired operation of the device.

Radiation Exposure Statement

This device complies with FCC radiation exposure limits set forth for an uncontrolled environment and meets the FCC radio frequency (RF) Exposure Guidelines in Supplement C to OET65 This transmitter must not be co-located or operating in conjunction with any other antenna or transmitter.

FCC Class B digital device notice

This equipment has been tested and found to comply with the limits for a Class B digital device, pursuant to part 15 of the FCC Rules. These limits are designed to provide reasonable protection against harmful interference in a residential installation. This equipment generates uses and can radiate radio frequency energy and, if not installed and used in accordance with the instructions, may cause harmful interference to radio communications. However, there is no guarantee that interference will not occur in a particular installation. If this equipment does cause harmful interference to radio or television reception, which can be determined by turning the equipment off and on, the user is encouraged to try to correct the interference by one or more of the following measures:

- Reorient or relocate the receiving antenna.
- Increase the separation between the equipment and receiver.
- Connect the equipment into an outlet on a circuit different from that to which the receiver is connected.
- Consult the dealer or an experienced radio/TV technician for help.

FCC REGULATORY NOTICES

- The units shall be tested by a Nationally Recognized Testing Laboratory (NRTL) in accordance with ANSI/UL Standard UL 1995/CAN/CSA-C22.2 No. 236-11 – 4th Edition (R2011) – Heating and Cooling Equipment, and will bear the Listed Mark.
- All wiring shall be in accordance with the National Electric Code (NEC)/Canadian Electrical Code (CEC).

DZK INTERFACES

DZK thermostats control the air conditioning and boost the energy efficiency of your AC unit.

Both the master and zone thermostats can be easily configured. From your master thermostat you can select the available operation modes or define the energy efficiency (profile).



WIRED THERMOSTAT. Interface with a 3.5" color touch screen for controlling the zone.

- Control of set point temperature. Displayed in 1°F/0.5°C increments.
- Configurable set point range for Cooling and Heating.
- Room temperature and relative humidity reading.
- Operation mode, User mode and Airflow control (only available for the Master Wired Thermostat).
- Timer function.
- Zone navigation.
- Time schedules.
- Configurable as Master or Zone thermostat.

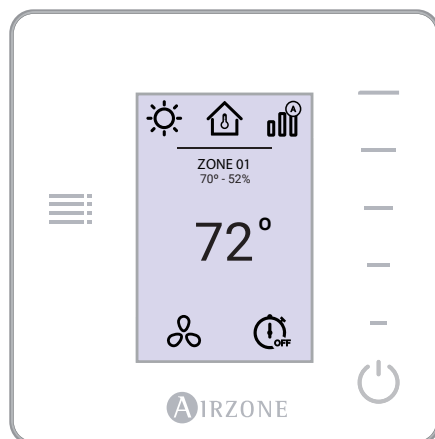

WIRELESS THERMOSTAT. Low-energy E-ink thermostat for controlling the zone through capacitive buttons.

- Control of set point temperature. Displayed in 1°F/0.5°C increments.
- Configurable set point range for Cooling and Heating.
- Room temperature and relative humidity reading.
- Timer function.
- Zone navigation (only if no Wired Thermostat available).



WIRELESS LITE THERMOSTAT. Interface for controlling the air conditioning through capacitive buttons.

- On/Off button.
- Allows adjustment of the base set point temperature in steps of $\pm 1^\circ\text{F}/0.5^\circ\text{C}$ (by default) or $\pm 2^\circ\text{F}/1^\circ\text{C}$ up to a limit of $\pm 6^\circ\text{F}/3^\circ\text{C}$. This base set point temperature can be configured only through any Wired Thermostat.
- Room temperature and relative humidity sensing.

WIRED THERMOSTAT

GETTING TO KNOW YOUR WIRED THERMOSTAT

MAIN SCREEN DISPLAY

The Main Screen options for the Wired Thermostat are:

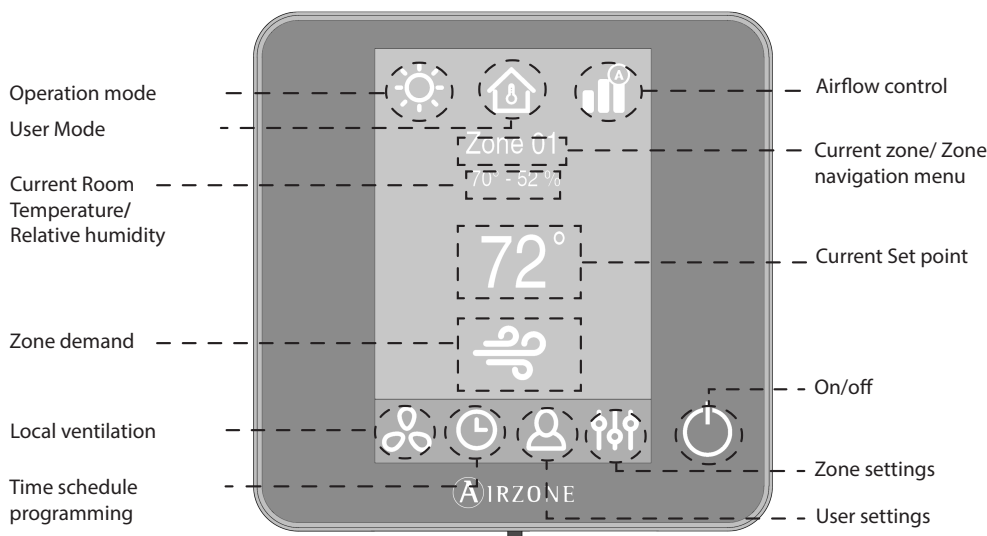

To access Operation Mode
Press Operation mode icon to access.

**Only available to the Master thermostat.*

To access Zone navigation Menu
Press current Zone to access.

Room temperature
The range of measured room temperature goes from 50°F/10°C to 90°F/35°C. If the room temperature is out of those limits, the temperature will be displayed as >90°F/35°C or <50°F/10°C.

Operation Mode*. The current mode of temperature control: Cool, Heat, Auto, Dry or Emergency Heat.

User Mode*. Allows to quickly change the configuration of the system by means of preloaded settings, adapted to daily situations: Eco, Vacation, Stop, Comfort, Unoccupied or Night time.

Airflow Control*. Regulates the airflow quantity. Available options: Silence, Standard, Power.

Current Zone/Zone Navigation Menu. Displays the current zone and allows access to zone navigation menu.

Current Room Temperature. Displays the current (actual) temperature in the room where the thermostat is installed.

Relative humidity. It indicates the relative humidity of the zone.

Current Set point. The programmed temperature for a zone. Press the set point temperature to switch between heating and cooling set points. Press + or - to manually adjust by increments of 1°F (0.5°C).

Zone Demand. This icon will be displayed if the zone is actively cooling or heating the space.

Local Ventilation. This option allows activation or deactivation of the fan mode in the selected zone when the system is no longer actively cooling or heating the zones.

Time Schedule Programming. In this menu, you can program your system and activate/deactivate time schedules.

User Settings. From this parameter you can control several functions such as the language, the screen brightness, etc.

*To change Local Ventilation Value
- Press icon to change*

Zone Settings:

Timer. Automatically switches off the zone after 30, 60 or 90 minutes. If any zones are using a Wireless Lite thermostat, the Lite parameters can be configured.

Lite Settings. Available when navigating to a Wireless Lite Thermostat from a Wired Thermostat.

On/Off. On and off of the zone where the thermostat is located.

SCREENSAVER

The screensaver activates after about 12 seconds of inactivity, displaying the following information:

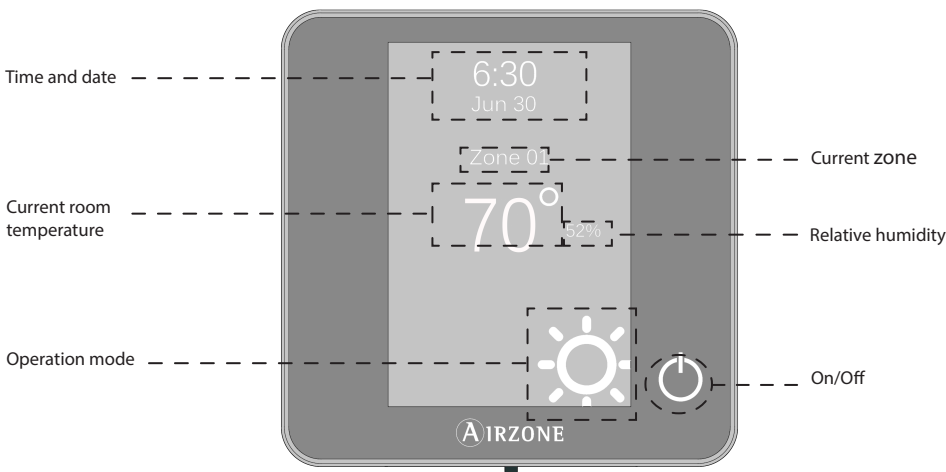

*To access Home Screen
With just one touch, the thermostat goes from the screensaver to home screen.*

Time and Date. This information can be edited from the user settings menu.

Current Zone. Displays the current zone.

Current Room Temperature. Displays the current (measured) temperature in the room where the thermostat is installed.

Relative Humidity. It indicates the humidity of the zone.

Operation Mode. Displays the current operation mode of the system.

On/Off. Press to switch On/Off the zone.

USING YOUR WIRED THERMOSTAT

Adjusting the temperature

 **On/Off.** Press to switch On/Off the zone.

72° Temperature Control. The temperature displayed on the screen is the current set point temperature. You can easily adjust the set point on your wired Thermostat.

Press the set point temperature to switch between heating and cooling set points. Press + or - to manually adjust by increments of 1°F (0.5°C).

The permitted temperature range is:

- Heating mode: 59° F – 84° F/ 15° C - 29° C.
- Cooling mode: 64° F – 86° F/ 17° C - 30° C.

There is a minimum difference allowed between heating and cooling set point temperatures. The system will prevent you from setting a temperature within the protection range.

To change Operation Mode

From the Home Screen:

- Press Operation Mode icon.

- Select your Operation Mode:

- Cool
- Heat
- Auto
- Dry
- Emergency Heat*

*This option is only visible if it has been configured

Dry

Dry mode decreases humidity in the room by entering the dehumidification cooling cycle.

Operation Mode*

*Only available to the Master thermostat.

 **Cool.** In this mode the air-conditioning unit will start a cooling cycle any time that any zone is in cool demand ($T_{\text{Set-Point}} < T_{\text{room}}$).

 **Heat.** Enables the heating cycle whenever a zone is in heat demand ($T_{\text{Set-Point}} > T_{\text{room}}$).

 **Auto.** The Auto mode allows automatic switching between cool and heat, depending on the global demand.







 **Dry.** In this mode the air-conditioning unit will start a dehumidification cooling cycle any time that any zone is under demand ($T_{\text{Set-Point}} < T_{\text{room}}$).

 **Emergency heat.** This mode activates the Auxiliary Heat to provide heated air in case of a mechanical failure in the system.

*Note: This mode is only visible when the installation includes an auxiliary heating device.

User Mode*



*Only available to the Master thermostat.

-  **Comfort.** Default and standard user mode. The desired set point temperature can be selected using the predefined temperature ranges.
-  **Eco.** The range of available set point temperatures changes for more efficient operation.
-  **Night time.** The system automatically changes the set point temperature 1° F/ 0.5° C every 30 minutes in up to 4 steps (4° F/ 2° C in 2 hours). When cooling, the system increases the set point temperature; when heating, the system decreases the set point temperature.
-  **Unoccupied.** To be used while you are away for short periods of time. A more efficient set point temperature will be set. If the thermostat is activated, the zone will start running in comfort mode.
-  **Vacation.** This mode feature helps you save energy while you are away for extended periods of time.
-  **Stop.** The air-conditioning system will remain switched off regardless of the demand status of any zone, and all the motorized dampers will stay opened.



Airflow Control*

*Only available to the Master thermostat.

Select the control algorithm that best fits your installation. These are the available options:

-  **Silence.** The fan speed is lower than in standard mode to reduce the noise.
-  **Standard.** Default setting. The system automatically regulates the fan speed based on the number of zones calling for cooling or heating.
-  **Power.** The fan speed is higher than in standard mode to increase the flow.

Local Ventilation

This option allows activation  or deactivation  of the ventilation in the selected zone when the system is not actively cooling or heating any of the zones.

Important

In Heat Pump installations, it is recommended not to activate the global and local ventilation in a DZK zoning box connected to the master indoor unit. It may cause the Stop user mode to turn off the rest of the DZK zoning box.

TIME SCHEDULE

If you press the time schedule icon, you will access the menu where you can schedule your air conditioning:

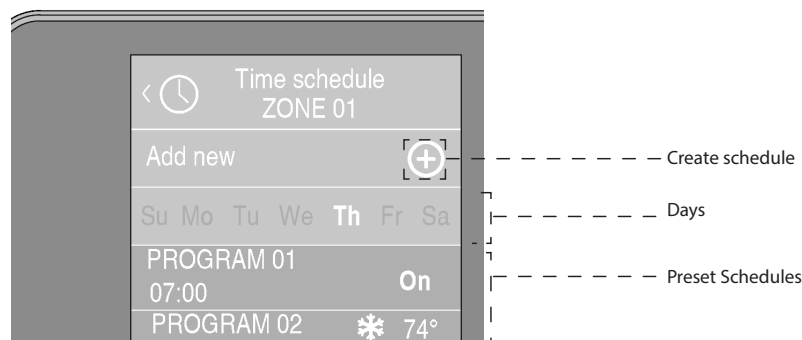

Two options available:

1. Preset schedules. Preset schedules are deactivated by default and they apply to all the zones, everyday. They can be activated and edited in any zone but not deleted.

- **WAKE:** The start time of this period typically represents when you get up in the morning. It is an occupied program.
- **DAY:** This represents when you leave to go to work. It is a setback program.
- **EVENING:** This represents when you get home from work in the evening. It is an occupied program.
- **SLEEP:** This represents when you go to bed at night. It is an occupied program.
- **OCCUPIED:** This represents when you are at home. It is an occupied program.
- **UNOCCUPIED:** This represents when you are not at home. It is a setback program.

2. Create new schedules*.

1. Press "Add New +".
2. Select the zone/ zones where the schedule applies.
3. Select the desired week days.
4. Select the type of time schedule you want to apply. There are three types of schedules:



- **User Mode:** It allows you to choose the user mode (only available for Master Wired Thermostat).
- **Temperature:** It allows to choose the temperature of the zone.
- **On/Off:** Schedule the zone On or Off.

4. Once the type of schedule is selected, please configure it (time, action). In addition, you can change the name of any schedule just pressing on it.
5. Finally, activate or deactivate the schedules using the on/off selector.

Save
All the setting are automatically saved pressing the back button.

*Option available for any Wired thermostat.







To configure the schedule, press the desired schedule to access the edit setting and then press the parameters to modify. Press and hold on any schedule, to see all the available settings:

-  Edit: Change the name of a schedule.
-  Delete: Deletes an existing schedule (Not available for preset schedules).
-  Copy: You can copy a schedule to apply it in any other zone.

ZONE NAVIGATION

After pressing on the name of the zone, a list with all the zones will be displayed. Each zone's status will be displayed. It is also possible to switch On/Off the zones from this screen.





After pressing on the zone name, all the parameters will be displayed to check and/or modify them.

-  On/Off.
-  72° Temperature control.
-  Local ventilation. Activation or deactivation.
-  Time schedules: create a time schedule or activate/deactivate an existing one.
-  User settings.
-  Zone settings.

The "All zones" option will broadcast the changes to all the zones.

USER SETTINGS

These settings control and edit all the basic functionalities. Touch once to display the shortcuts. Press on each icon to access the parameters.

-  **Units:** Select Celsius or Fahrenheit (by default) degrees.
-  **Language:** Select your language.
-  **Brightness:** Adjust the brightness, and enable or disable screen brightness when the screen saver is active.
-  **Date and time:** Press on the clock to set the time, the format type (12 or 24 hours) and enable daylight saving time. Press on the calendar to set the date.

Edit names

Press and hold on the name of the zone to access the name editor. Then, change the name.

Keep in mind: If a wireless zone is renamed, the name will be displayed in the wireless thermostat after 5 minutes of inactivity or after the first touch, whichever occurs first.

Remote zone icons

 Exit zone. It closes the zone and returns to the main zone.

 It returns to the list of zones.





-  **Information.** This parameter provides information on:
- Zone: firmware, zone, association, actuator or status of the communications.
 - System: firmware, settings and information about the system controllers.
 - Devices: It displays the elements connected to the system.
 - Warnings and errors on system.

 **Clean screen:** Select this option if you want to clean the screen. The touch screen will lock for a few seconds.

ZONE SETTINGS

Press on the icons to access the parameters.

 **Timer.** It is an auto power-off timer of the zone. You can select:

-  Off. Timer is not activated.
-  30. Thirty minutes after its activation, the zone will turn off.
-  60. Sixty minutes after its activation, the zone will turn off.
-  90. Ninety minutes after its activation, the zone will turn off.

***Note:**
This parameter is available when navigating to a Wireless Lite Thermostat from a Wired Thermostat.

 **Lite settings*.** This parameter defines the base set-point temperature for zones with Wireless Lite Thermostat.

WARNINGS AND ERRORS

Warnings

Unoccupied Override. A zone has been activated while the user mode is set on Unoccupied. The system will start using the Comfort Mode during the selected override time. When the override time has expired, the system returns to its previous status.

Lite Low Battery. Displayed when batteries have run low. It has 2 weeks of life left in normal conditions.

Global Ventilation. The global ventilation is activated.
**This warning is only displayed on Master thermostats.*

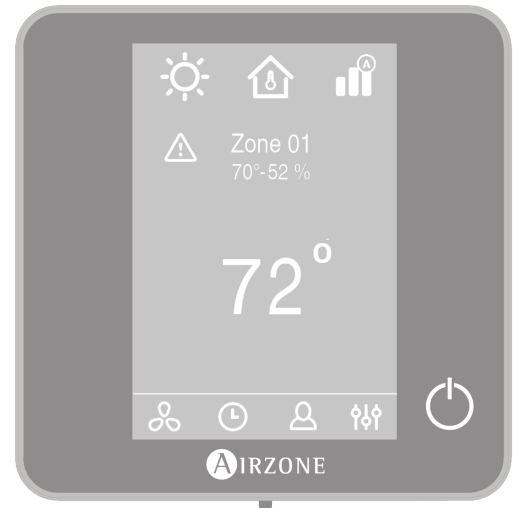

Errors

Error 1. Communication error with the main controller.

Error 5. Temperature sensor is opened.

Error 6. Temperature sensor is short circuited.

Error 8. Wireless Lite Thermostat not found.

Error 9. Communications error between the DZK Interface Board and the system.

Error 10. Communication error between the DZK BACnet Interface and the system.

Error 11. Communication error between the DZK Interface Board and the Daikin indoor unit.

AC Unit error.

Note: Refer to the DZK Installation Manual for troubleshooting steps.



WIRELESS THERMOSTAT

GETTING TO KNOW YOUR WIRELESS THERMOSTAT

MAIN SCREEN DISPLAY

Press on the Airzone icon to deactivate the screensaver and go to the home screen. The following functions are available:

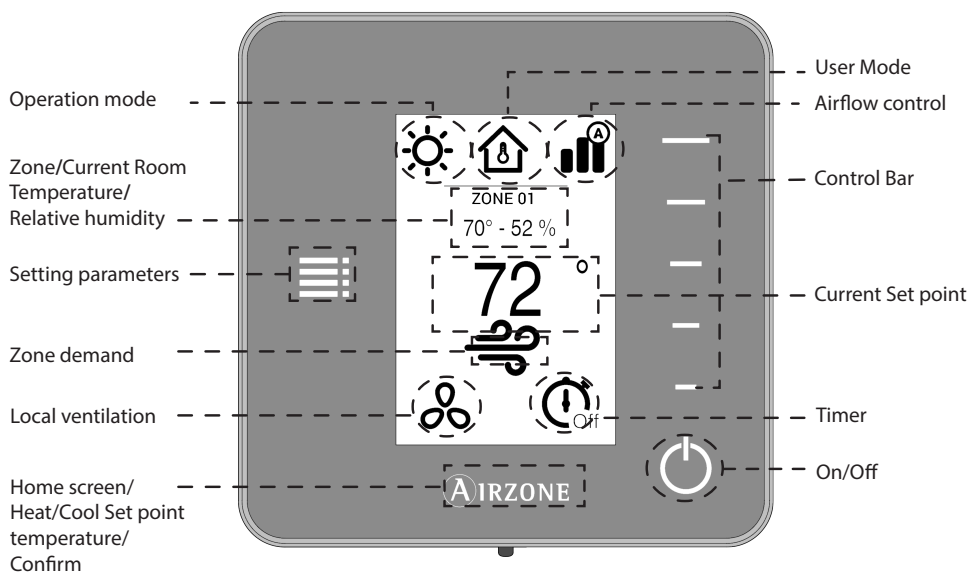

Operation Mode. Displays the operation mode selected from the Master thermostat: Cool, Heat, Auto, Dry or Emergency Heat.

User Mode. Displays the User Mode selected from the Master thermostat: Eco, Vacation, Stop, Comfort, Unoccupied or Night time.

Airflow Control. Displays the Airflow Control selected from the Master thermostat: Silence, Standard or Power.

Zone. Displays the current zone.

Current Room Temperature. Displays the current (actual) temperature in the room where the Wireless Thermostat is installed.

Relative humidity. It indicates the relative humidity of the zone.

Control Bar. It adjusts (by pressing or by sliding) all the parameters controlled by the Wireless Thermostat.

Note: Press once to adjust the the set point temperature by a single degree. Slide to adjust the set point temperature in larger steps.

Setting parameters. Press to access to Local ventilation, Timer and information parameters.

Current Set Point. Displays the set point temperature and modifies it using the Wireless Thermostat control bar.

Room temperature
The range of measured room temperature goes from 50°F/10°C to 90°F/35°C. If the room temperature is out of those limits, the temperature will be displayed as >90°F/35°C or <50°F/10°C.

Zone Demand. This icon will be displayed if the zone is calling for demand.

Local Ventilation. This option allows activation or deactivation of the ventilation in the selected zone during system inactivity periods.

Timer. Automatically switches off the zone after 30, 60 or 90 minutes.

On/Off. Turn On and Off the zone where the thermostat is located.

Airzone. A button used to confirm, return to home and to switch between the heating set point and cooling set point.

SCREENSAVER

The screensaver activates after about 12 seconds of inactivity, displaying the following information:

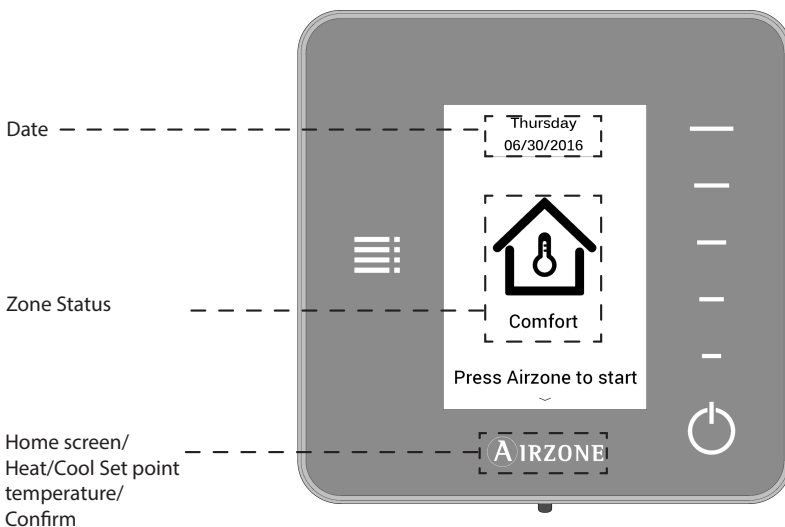

*To access Home Screen
When the screensaver is active, press the Airzone icon to get to the home screen.*

Date. Displays the date of system. It is defined by the Wired Thermostat in user settings.

Zone Status. It displays information about the status of the zone: the state (on/off) and the user mode. In case of failure, it also displays all the errors.

Airzone. A button used to confirm, return to home screen and to switch between the heating set point and cooling set point.

USING YOUR WIRELESS THERMOSTAT

Navigation

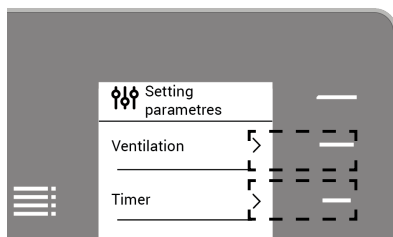

To navigate through Wireless Thermostat, follow the instructions you will see on the screen. Press the side buttons on the control bars to execute the instructions.



Adjusting the temperature

 **On/Off.** Press to turn the zone On/Off.

Control bar

Press once to adjust the set point temperature by a single degree. Slide to adjust the set point temperature in larger steps.

Heat set point temperature

Cool set point temperature
Press Airzone to switch between heat set point temperature and cool set point temperature.

72° **Temperature Control.** The temperature displayed on the screen is the current set point temperature. You can easily adjust the set point temperature on your Wireless Thermostat.

Select the set point temperature using the control bar (pressing or by sliding) to manually adjust by increments of 1°F (0.5°C).

The available temperature range is:

- Heating mode: 59° F/15° C – 84° F/29° C.
- Cooling mode: 64° F/18° C – 86° F/30° C.

There is a minimum difference allowed between heating and cooling set point temperatures. The system will prevent you from setting a temperature within the protection range.

About the battery

Wireless Thermostats will display a battery alert on their screen when the batteries are low.

In order to replace the battery, please remove the thermostat from its back plate and then replace it (CR2450).

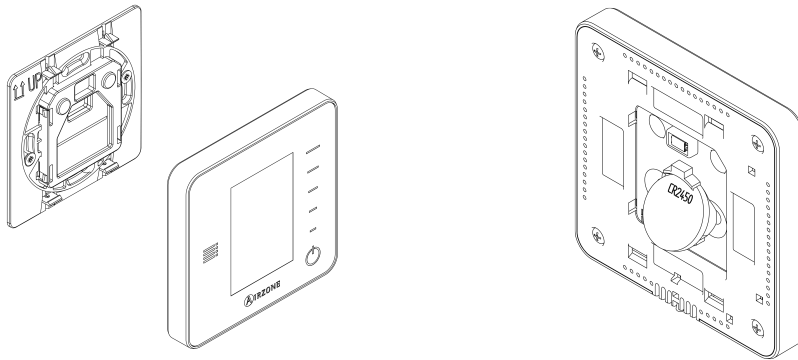



Important: We recommend the use of top-brand batteries. Using low-quality batteries may reduce the duration of use.

SETTING PARAMETERS





Press on the icon Setting Menu to access the parameters.

Important

In Heat Pump installations, it is recommended not to activate the global and local ventilation in a DZK zoning box connected to the master indoor unit. It may cause the Stop user mode to turn off the rest of the DZK zoning box.

Local Ventilation. This option allows activation  or deactivation  of the ventilation in the selected zone when the system is not actively cooling or heating any of the zones.

Timer. It is an auto power-off timer of the zone. You can select:

-  Off. Timer is not activated.
-  30. Thirty minutes after its activation, the zone will turn off.
-  60. Sixty minutes after its activation, the zone will turn off.
-  90. Ninety minutes after its activation, the zone will turn off.

Information. This parameter provides information on:

- Zone: firmware, zone, association, actuator or status of the communications.
- System: firmware, settings and information about the system controllers.
- Devices: It displays the elements connected to the system.

Zone navigation. Zone navigation will be available only when the Master thermostat is in error. Through the "All zones" option, you can access the Set point, Mode, User mode and Airflow parameters and modify them.

WARNINGS AND ERRORS

Warnings

Unoccupied Override. A zone has been activated while the user mode is set on Unoccupied. The system will start using the Comfort Mode during the selected override time. When the Override time has expired, the system returns to its previous status.

Low battery. Displayed when batteries have run low. It has 2 weeks of life left in normal conditions.



Errors

Communication error with the main controller.

Error 1. Communication error with the main controller.

Error 5. Temperature sensor is opened.

Error 6. Temperature sensor is short circuited.

Error 9. Communications error between the DZK Interface Board and the system.

Error 10. Communication error between the DZK BACnet Interface and the system.

Error 11. Communication error between the DZK Interface Board and the Daikin indoor unit.

AC Unit error.

Note: Refer to the DZK Installation Manual for troubleshooting steps.

WIRELESS LITE THERMOSTAT

GETTING TO KNOW YOUR WIRELESS LITE THERMOSTAT

The Wireless Lite Thermostat provides simple control the temperature of the zone.

It can be used to adjust the set point temperature in three steps, up or down, from the base set point set by any Wired thermostat.

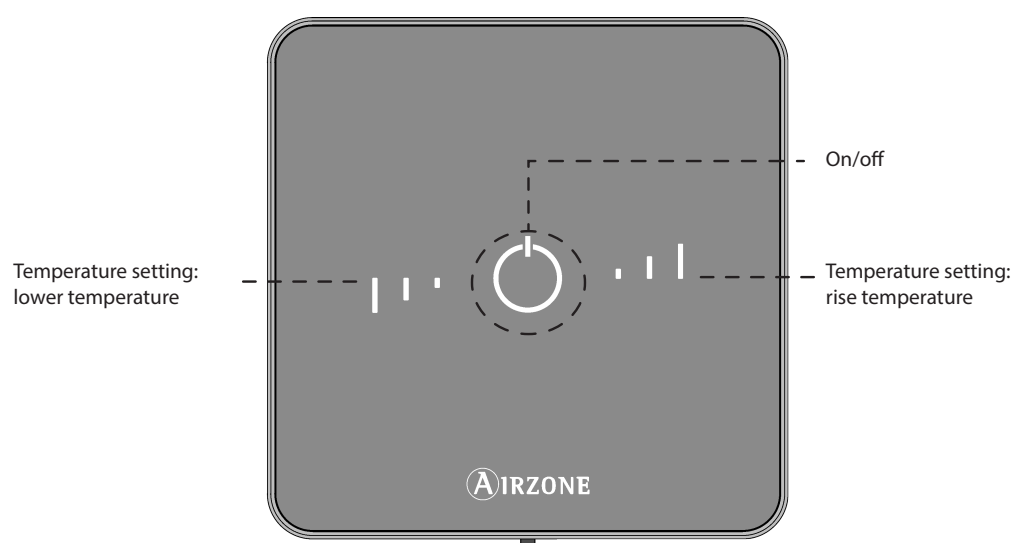





On/Off. Turn On and Off the zone. In addition, it indicates the operating mode by means of a color code.

Temperature Settings. Allows adjustment of the base set point temperature in steps of $\pm 1^{\circ}\text{F}/0.5^{\circ}\text{C}$ (by default) or $\pm 2^{\circ}\text{F}/1^{\circ}\text{C}$ up to a limit of $\pm 6^{\circ}\text{F}/3^{\circ}\text{C}$. This base set point temperature can be configured only through any Wired Thermostat.

USING YOUR WIRELESS LITE THERMOSTAT

Adjusting the temperature

 **On/Off.** Press on the On/Off button to turn on or off the zone. This button also displays the operation mode. It follows a color code system:

-  **Purple:** Stop User mode.
-  **Red:** Heating mode/Emergency heat.
-  **Blue:** Cooling and Dry mode.
-  **Green:** The set-point temperature has been reached.

If the button remains solid, the thermostat is ON.

If the button is blinking, the thermostat is OFF.

The button remains lit for 10 seconds to show the status, then turns off.

Temperature Control. Using the buttons, you can rise or lower the base set point temperature in steps of $\pm 1^{\circ}\text{F}/0.5^{\circ}\text{C}$ (by default) or $\pm 2^{\circ}\text{F}/1^{\circ}\text{C}$ up to a limit of $\pm 6^{\circ}\text{F}/3^{\circ}\text{C}$. This base set point temperature can be configured only through any Wired Thermostat.

The LEDs indicate the steps above or below the base temperature.

Once the three-step limit has been reached, the temperature control icons will flash.

About the battery

Wired Thermostat will display on your screensaver a battery alert when the battery of Wireless Lite Thermostat is low.

In order to replace the battery, please remove the thermostat from its back plate and then replace it (CR2450).

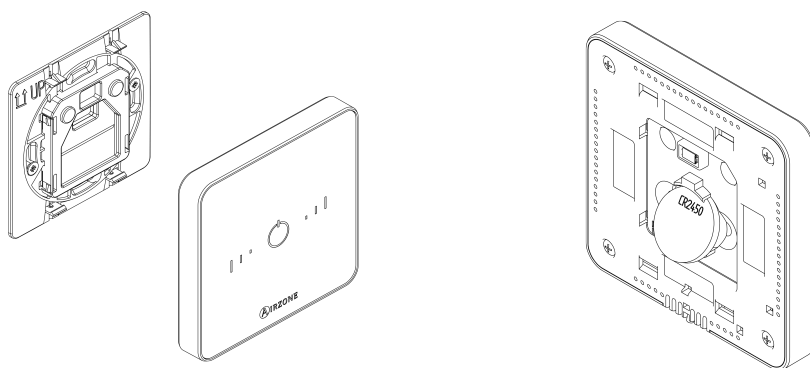

Important: We recommend the use of top-brand batteries. Using low-quality batteries may reduce the duration of use.

WARNINGS AND ERRORS

Errors



On/Off icon blinking red quickly. Loss of communication with the DZK Control Board.

NAVIGATION GUIDES

WIRED THERMOSTAT

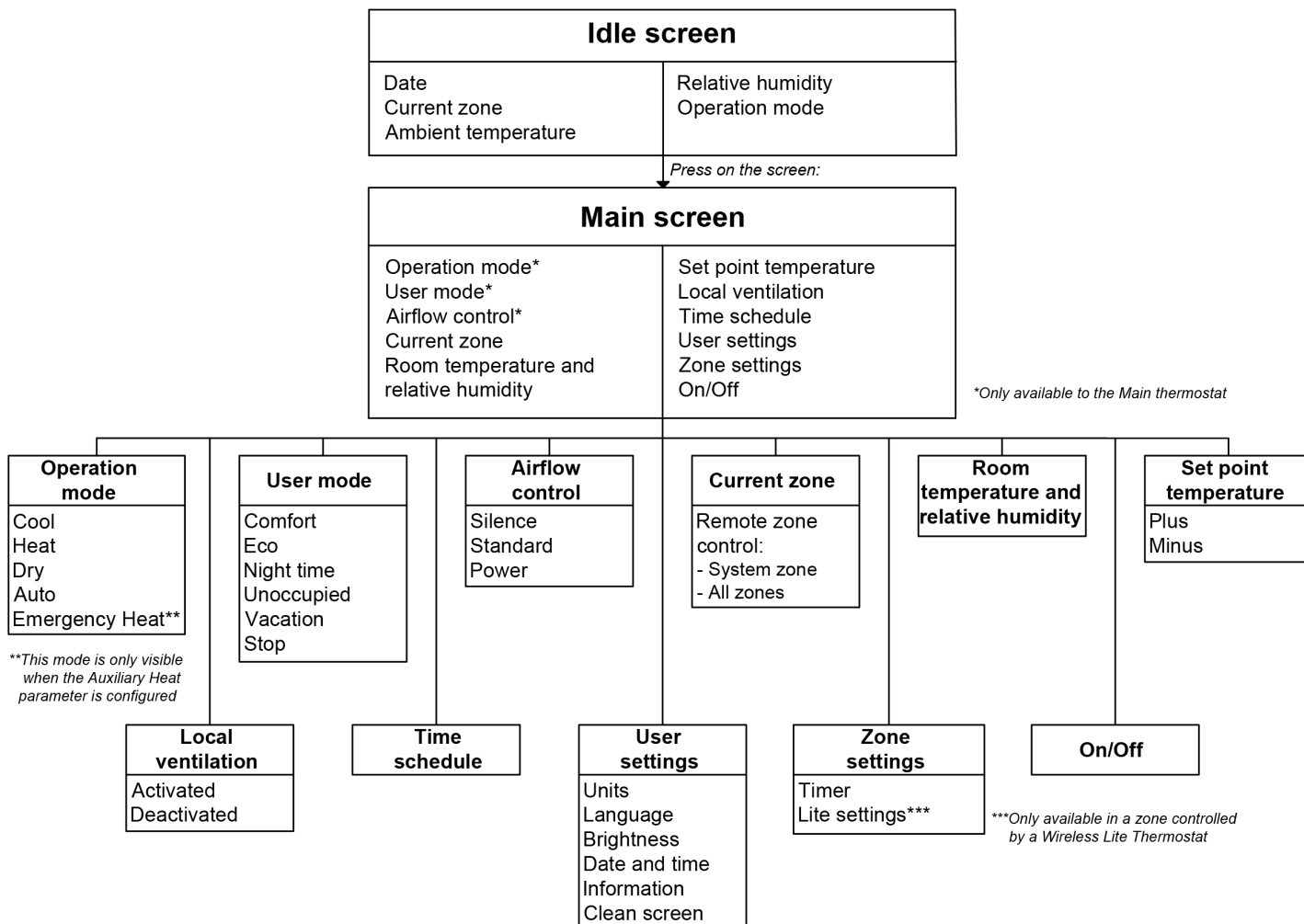

WIRELESS THERMOSTAT

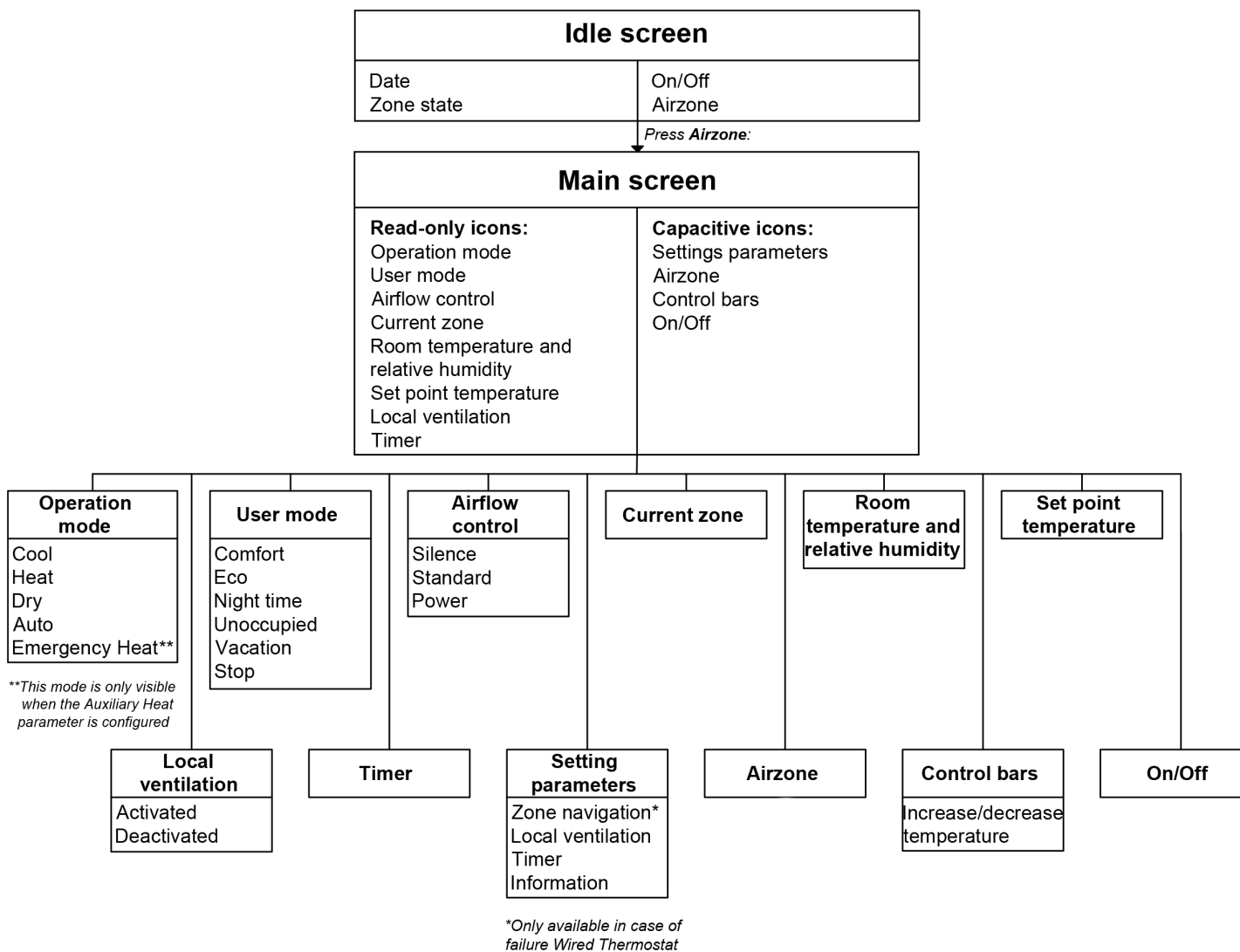



Phone: (855) 770-5678
<http://www.daikinac.com>



RECOGNIZED
COMPONENT



Intertek
4008862