



**FCC 47 CFR PART 15 SUBPART C**

**CERTIFICATION TEST REPORT**

*For*

**UAV Remote Controller**

**MODEL NUMBER: DHI-UAV-R1S-RH**

**FCC ID: SVN UAV-R1**

**REPORT NUMBER: 4788322398-4-3**

**ISSUE DATE: September 27, 2018**

*Prepared for*

**Zhejiang Dahua Vision Technology Co., Ltd.**

**No.1199, Bin'an Road, Binjiang District, Hangzhou, P.R. China**

*Prepared by*

**UL Verification Services (Guangzhou) Co., Ltd, Song Shan Lake Branch**

**Room 101, Building 10, Innovation Technology Park,**

**Song Shan Lake Hi tech Development Zone, Dongguan, 523808, China**

**Tel: +86 769 33817100**

**Fax: +86 769 33244054**

**Website: [www.ul.com](http://www.ul.com)**



Revision History

<u>Rev.</u>	<u>Issue Date</u>	<u>Revisions</u>	<u>Revised By</u>
--	09/27/2018	Initial Issue	



## TABLE OF CONTENTS

<b>1. ATTESTATION OF TEST RESULTS.....</b>	<b>4</b>
<b>2. TEST METHODOLOGY.....</b>	<b>5</b>
<b>3. FACILITIES AND ACCREDITATION.....</b>	<b>5</b>
<b>4. CALIBRATION AND UNCERTAINTY .....</b>	<b>6</b>
4.1. <i>MEASURING INSTRUMENT CALIBRATION .....</i>	<i>6</i>
4.2. <i>MEASUREMENT UNCERTAINTY.....</i>	<i>6</i>
<b>5. EQUIPMENT UNDER TEST .....</b>	<b>7</b>
5.1. <i>DESCRIPTION OF EUT .....</i>	<i>7</i>
5.2. <i>MAXIMUM EMISSIONS FIELD STRENGTH .....</i>	<i>7</i>
5.3. <i>TEST CHANNEL CONFIGURATION.....</i>	<i>7</i>
5.4. <i>TEST ENVIRONMENT .....</i>	<i>8</i>
5.5. <i>DESCRIPTION OF AVAILABLE ANTENNAS .....</i>	<i>9</i>
5.6. <i>THE WORSE CASE POWER SETTING PARAMETER.....</i>	<i>10</i>
5.7. <i>DESCRIPTION OF TEST SETUP.....</i>	<i>11</i>
5.8. <i>MEASURING INSTRUMENT AND SOFTWARE USED.....</i>	<i>12</i>
<b>6. SUMMARY OF TEST RESULTS.....</b>	<b>13</b>
<b>7. ANTENNA PORT TEST RESULTS .....</b>	<b>14</b>
7.1. <i>ON TIME AND DUTY CYCLE.....</i>	<i>14</i>
7.2. <i>20 dB BANDWIDTH.....</i>	<i>16</i>
<b>8. RADIATED TEST RESULTS.....</b>	<b>25</b>
8.1. <i>LIMITS AND PROCEDURE.....</i>	<i>25</i>
8.2. <i>RESTRICTED BANDEDGE AND FIELD STRENGTH OF INTENTIONAL EMISSIONS</i> <i>30</i>	
8.3. <i>SPURIOUS EMISSIONS BELOW 30M (WORST-CASE CONFIGURATION).....</i>	<i>78</i>
8.4. <i>SPURIOUS EMISSIONS BELOW 1 GHz (WORST-CASE CONFIGURATION).....</i>	<i>82</i>
8.5. <i>SPURIOUS EMISSIONS 1~18GHz .....</i>	<i>84</i>
8.6. <i>SIMULTANEOUS TRANSMISSION EVALUATION WORST CASE.....</i>	<i>108</i>
8.7. <i>SPURIOUS EMISSIONS 18G ~ 26GHz (WORST-CASE CONFIGURATION).....</i>	<i>118</i>
<b>9. AC POWER LINE CONDUCTED EMISSIONS.....</b>	<b>120</b>
<b>10. ANTENNA REQUIREMENTS .....</b>	<b>123</b>



# 1. ATTESTATION OF TEST RESULTS

## Applicant Information

Company Name: Zhejiang Dahua Vision Technology Co., Ltd.  
Address: No.1199, Bin'an Road, Binjiang District, Hangzhou, P.R. China

## Manufacturer Information

Company Name: Zhejiang Dahua Vision Technology Co., Ltd.  
Address: No.1199, Bin'an Road, Binjiang District, Hangzhou, P.R. China

## Factory Information

Company Name: Zhejiang Dahua Vision Technology Co., Ltd.  
Address: No.1199, Bin'an Road, Binjiang District, Hangzhou, P.R. China

**EUT Name:** UAV Remote Controller  
**Brand:**   
**Model:** DHI-UAV-R1S-RH  
**Serial Model:** See chapter 5.1  
**Sample Received Date:** November 20, 2017  
**Date of Tested:** April 10, 2018 ~ September 26, 2018

APPLICABLE STANDARDS	
STANDARD	TEST RESULTS
CFR 47 Part 15 Subpart C	Pass

Prepared By:

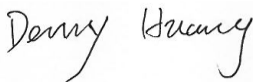

Checked By:



Denny Huang  
Engineer Project Associate  
Approved By:



Shawn Wen  
Laboratory Leader

Stephen Guo  
Laboratory Manager



## 2. TEST METHODOLOGY

The tests documented in this report were performed in accordance with FCC CFR 47 Part 2, FCC CFR 47 Part 15 and ANSI C63.10-2013.

## 3. FACILITIES AND ACCREDITATION

Accreditation Certificate	<p><b>A2LA (Certificate No.: 4102.01)</b> UL Verification Services (Guangzhou) Co., Ltd. Song Shan Lake Branch. has been assessed and proved to be in compliance with A2LA.</p> <p><b>IAS (Lab Code: TL-702)</b> UL Verification Services (Guangzhou) Co., Ltd. Song Shan Lake Branch. has demonstrated compliance with ISO/IEC Standard 17025:2005, General requirements for the competence of testing and calibration laboratories</p> <p><b>FCC (FCC Designation No.: CN1187)</b> UL Verification Services (Guangzhou) Co., Ltd. Song Shan Lake Branch. Has been recognized to perform compliance testing on equipment subject to the Commission's Declaration of Conformity (DoC) and Certification rules</p> <p><b>IC(Company No.: 21320)</b> UL Verification Services (Guangzhou) Co., Ltd. Song Shan Lake Branch. has been registered and fully described in a report filed with ISED. The Company Number is 21320.</p> <p><b>VCCI (Registration No.: G-20019, R-20004, C-20012 and T-20011)</b> UL Verification Services (Guangzhou) Co., Ltd. Song Shan Lake Branch. has been assessed and proved to be in compliance with VCCI, the Membership No. is 3793. Facility Name: Chamber D, the VCCI registration No. is G-20019 and R-20004 Shielding Room B , the VCCI registration No. is C-20012 and T-20011</p>
---------------------------	--

Note:

1. All tests measurement facilities use to collect the measurement data are located at Building 10, Innovation Technology Park, Song Shan Lake Hi tech Development Zone, Dongguan, 523808, China
2. The test anechoic chamber in UL Verification Services (Guangzhou) Co., Ltd. Song Shan Lake Branch had been calibrated and compared to the open field sites and the test anechoic chamber is shown to be equivalent to or worst case from the open field site.
3. For below 30MHz, lab had performed measurements at test anechoic chamber and comparing to measurements obtained on an open field site. And these measurements below 30MHz had been correlated to measurements performed on an OATS.



## 4. CALIBRATION AND UNCERTAINTY

### 4.1. MEASURING INSTRUMENT CALIBRATION

The measuring equipment utilized to perform the tests documented in this report has been calibrated in accordance with the manufacturer's recommendations, and is traceable to recognized national standards.

### 4.2. MEASUREMENT UNCERTAINTY

Where relevant, the following measurement uncertainty levels have been estimated for tests performed on the apparatus:

Test Item	Uncertainty
Uncertainty for Conduction emission test	2.90dB
Uncertainty for Radiation Emission test(include Fundamental emission) (9KHz-30MHz)	2.2dB
Uncertainty for Radiation Emission test(include Fundamental emission) (30MHz-1GHz)	4.52dB
Uncertainty for Radiation Emission test (1GHz to 26GHz)( include Fundamental emission)	5.04dB(1-6GHz)
	5.30dB (6GHz-18Gz)
	5.23dB (18GHz-26Gz)
Note: This uncertainty represents an expanded uncertainty expressed at approximately the 95% confidence level using a coverage factor of k=2.	



## 5. EQUIPMENT UNDER TEST

### 5.1. DESCRIPTION OF EUT

Equipment	UAV Remote Controller		
Product Description	The EUT is a remote controller used for UAV.		
Model Name	DHI-UAV-R1S-RH		
Series Model	UAV-R1S-RH,DH-UAV-R1S-RH,OEM-UAV-R1S-RH,DHI-UAV-R1123,DHI-UAV-R1133,UAV-R1123,UAV-R1133,DH-UAV-R1123,DH-UAV-R1133, OEM-UAV-R1123, OEM-UAV-R1133, DH-UAV-R1S-11,DHI-UAV-R1S-23,DHI-UAV-R1S-33,OEM-UAV-R1S-11,UAV-R1S-23,UAV-R1S-33,DH-UAV-R1S-11-C,DHI-UAV-R1S-23-C,DHI-UAV-R1S-33-C,OEM-UAV-R1S-11-C,UAV-R1S-23-C,UAV-R1S-33-C,DH-UAV-R1S-11CH,OEM-UAV-R1S-11CH,DH-UAV-R1S-11CH-C,OEM-UAV-R1S-11CH-C,DH-UAV-R1S-S-11CH,OEM-UAV-R1S-S-11CH,DH-UAV-R1S-S-11CH-C,OEM-UAV-R1S-S-11CH-C,DHI-UAV-R1S-33CH,UAV-R1S-33CH,DHI-UAV-R1S-33CH-C,UAV-R1S-33CH-C,DHI-UAV-R1S-S-33CH,UAV-R1S-S-33CH,DHI-UAV-R1S-S-33CH-C,UAV-R1S-S-33CH-C,DHI-UAV-R1S-23CH,UAV-R1S-23CH,UAV-R1S-23CH-C,HI-UAV-R1S-23CH-C,DHI-UAV-R1S-S-23CH,UAV-R1S-S-23CH,DHI-UAV-R1S-S-23CH-C,UAV-R1S-S-23CH-C.		
Model Difference	All the same except for the appearance of the different color and graphic pattern.		
Product Description	Operation Frequency	2413 MHz ~ 2475 MHz	
	Modulation Type		
	2GFSK		
Rated Power Input	100-240V~,50Hz/60Hz,1.5A max		
Battery	7.4V, 7800mAh		

### 5.2. MAXIMUM EMISSIONS FIELD STRENGTH

Frequency Range (MHz)	Number of Transmit Chains (NTX)	Frequency (MHz)	Max. Emissions Field Strength (dBμV/m)
2413 ~ 2475	1	2413 ~ 2475	108.20

### 5.3. TEST CHANNEL CONFIGURATION

Bandwidth	Low	Middle	High
10M	59830	60140	60450
	2413MHz	2444MHz	2475MHz
20M	59880	60140	60400
	2418MHz	2444MHz	2470MHz



#### 5.4. TEST ENVIRONMENT

Environment Parameter	Selected Values During Tests	
Relative Humidity	55 ~ 65%	
Atmospheric Pressure:	1025Pa	
Temperature	TN	23 ~ 28°C
Voltage :	VL	N/A
	VN	DC 7.4V
	VH	N/A

Note: VL= Lower Extreme Test Voltage  
VN= Nominal Voltage  
VH= Upper Extreme Test Voltage  
TN= Normal Temperatur



### 5.5. DESCRIPTION OF AVAILABLE ANTENNAS

Ant.	Frequency (MHz)	Antenna Type	Antenna Gain (dBi)
1	2413MHz~2475MHz	External Antenna	4.2

Test Mode	Transmit and Receive Mode	Description
QPSK, OFDM	<input checked="" type="checkbox"/> 1TX, 1RX	Chain 1 can be used as transmitting/receiving antenna.

Ant.	Frequency (MHz)	Antenna Type	Antenna Gain (dBi)
3	2413MHz~2475MHz	External Antenna	4.2

Test Mode	Transmit and Receive Mode	Description
QPSK, OFDM	<input checked="" type="checkbox"/> 1RX	Chain 3 can be used as receiving antenna.

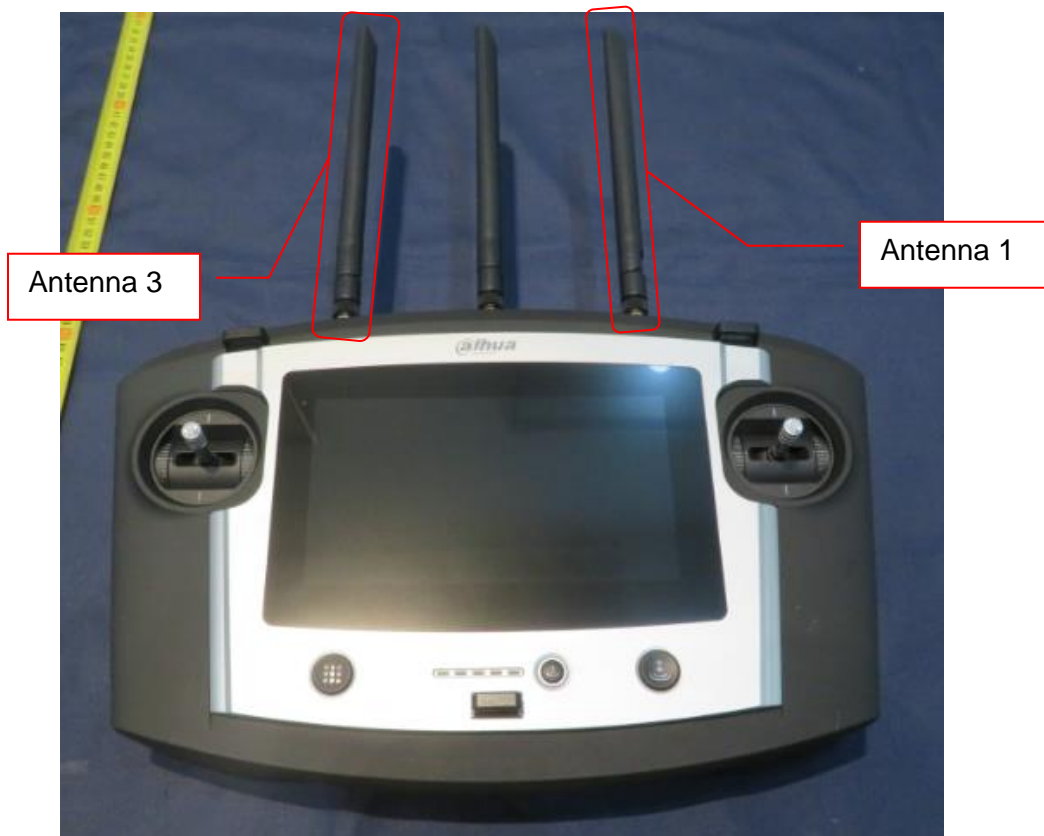



### 5.6. THE WORSE CASE POWER SETTING PARAMETER

The Worse Case Power Setting Parameter				
Test Software Version		10M Bandwidth Test Channel		
Modulation Type	Transmit Antenna Number	CH 59830	CH 60140	CH 60450
QPSK	1	Default	Default 75	Default
OFDM	1	Default	Default	Default

The Worse Case Power Setting Parameter				
Test Software Version		20M Bandwidth Test Channel		
Modulation Type	Transmit Antenna Number	CH 59880	CH 60140	CH 60400
QPSK	1	Default	Default	Default
OFDM	1	Default	Default	Default

## 5.7. DESCRIPTION OF TEST SETUP

### SUPPORT EQUIPMENT

Item	Equipment	Brand Name	Model Name	P/N
1	Laptop	ThinkPad	T460S	SL10K24796 JS

### I/O CABLES

Cable No	Port	Connector Type	Cable Type	Cable Length(m)	Remarks
1	N/A	N/A	N/A	N/A	N/A

### ACCESSORY

Item	Accessory	Brand Name	Model Name	Description
1	Switching Adapter		ADS-65HI-12N-1 12048E	AC Input: 100 ~ 240V, 1.5A DC Output: 12V, 4A

### TEST SETUP

The EUT can work in engineering mode with a software through a Laptop.

### SETUP DIAGRAM FOR TESTS

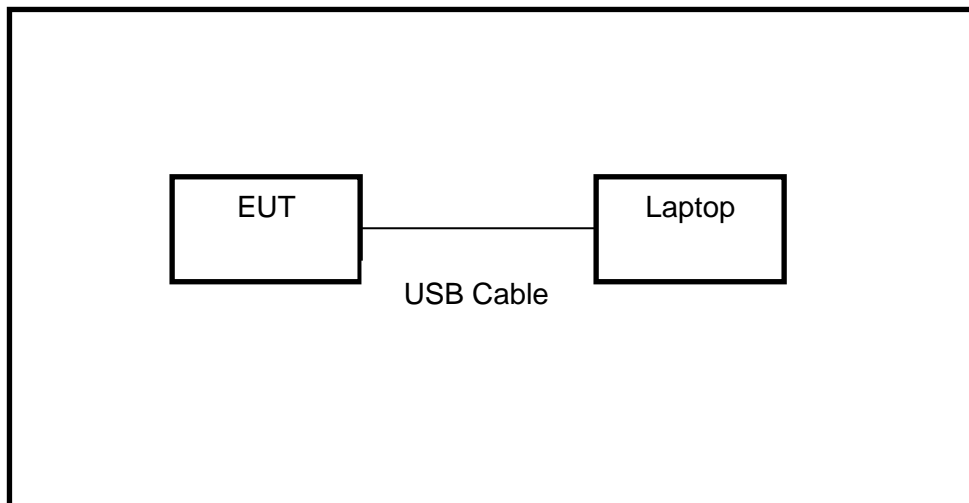



### 5.8. MEASURING INSTRUMENT AND SOFTWARE USED

Conducted Emissions						
Instrument						
Used	Equipment	Manufacturer	Model No.	Serial No.	Last Cal.	Next Cal.
<input checked="" type="checkbox"/>	EMI Test Receiver	R&S	ESR3	101961	Dec.12,2017	Dec.11,2018
<input checked="" type="checkbox"/>	Two-Line V-Network	R&S	ENV216	101983	Dec.12,2017	Dec.11,2018
<input checked="" type="checkbox"/>	Artificial Mains Networks	Schwarzbeck	NSLK 8126	8126465	Dec.12,2017	Dec.11,2018
Software						
Used	Description	Manufacturer	Name	Version		
<input checked="" type="checkbox"/>	Test Software for Conducted disturbance	Farad	EZ-EMC	Ver. UL-3A1		
Radiated Emissions						
Instrument						
Used	Equipment	Manufacturer	Model No.	Serial No.	Last Cal.	Next Cal.
<input checked="" type="checkbox"/>	MXE EMI Receiver	KESIGHT	N9038A	MY56400036	Dec.12,2017	Dec.11,2018
<input checked="" type="checkbox"/>	Hybrid Log Periodic Antenna	TDK	HLP-3003C	130960	Jan.09, 2016	Jan.09, 2019
<input checked="" type="checkbox"/>	Preamplifier	HP	8447D	2944A09099	Dec.12,2017	Dec.11,2018
<input checked="" type="checkbox"/>	EMI Measurement Receiver	R&S	ESR26	101377	Dec.12,2017	Dec.11,2018
<input checked="" type="checkbox"/>	Horn Antenna	TDK	HRN-0118	130939	Jan. 09, 2016	Jan. 09, 2019
<input checked="" type="checkbox"/>	High Gain Horn Antenna	Schwarzbeck	BBHA-9170	691	Jan.06, 2016	Jan.06, 2019
<input checked="" type="checkbox"/>	Preamplifier	TDK	PA-02-0118	TRS-305-00066	Dec.12,2017	Dec.11,2018
<input checked="" type="checkbox"/>	Preamplifier	TDK	PA-02-2	TRS-307-00003	Dec.12,2017	Dec.11,2018
<input checked="" type="checkbox"/>	Loop antenna	Schwarzbeck	1519B	00008	Mar. 26, 2016	Mar. 25, 2019
Software						
Used	Description	Manufacturer	Name	Version		
<input checked="" type="checkbox"/>	Test Software for Radiated disturbance	Farad	EZ-EMC	Ver. UL-3A1		
Other instruments						
Used	Equipment	Manufacturer	Model No.	Serial No.	Last Cal.	Next Cal.
<input checked="" type="checkbox"/>	Spectrum Analyzer	Keysight	N9030A	MY55410512	Dec.12,2017	Dec.11,2018
<input checked="" type="checkbox"/>	Power Meter	Keysight	N1911A	MY55416024	Dec.12,2017	Dec.11,2018
<input checked="" type="checkbox"/>	Power Sensor	Keysight	N1921A	MY51100041	Dec.12,2017	Dec.11,2018



## 6. SUMMARY OF TEST RESULTS

Summary of Test Results			
Clause	Test Items	FCC/IC Rules	Test Results
1	20dB Bandwidth	FCC 15.215	Pass
2	TX Spurious Emission	FCC 15.249 (a)(d)(e) FCC 15.209 FCC 15.205	Pass
3	Conducted Emission Test For AC Power Port	FCC 15.207	Pass



## 7. ANTENNA PORT TEST RESULTS

### 7.1. ON TIME AND DUTY CYCLE

#### LIMITS

None; for reporting purposes only

#### PROCEDURE

KDB 558074 Zero-Span Spectrum Analyzer Method

#### TEST SETUP

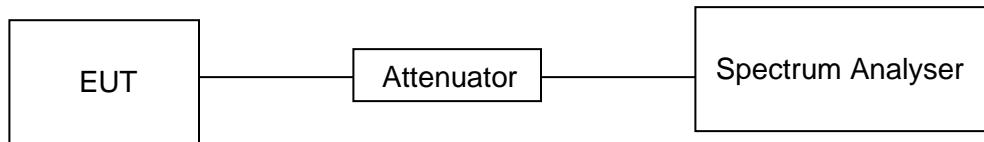

#### RESULTS

Mode	On Time (msec)	Period (msec)	Duty Cycle x (Linear)	Duty Cycle (%)	Duty Cycle Correction Factor (db)	1/T Minimum VBW (KHz)
QPSK	1.0145	10.029	0.10	10%	9.95	1

Note: Duty Cycle Correction Factor= $10\log(1/x)$ .  
Where: x is Duty Cycle (Linear)  
Where: T is On Time (transmit duration)



### ON TIME AND DUTY CYCLE MID CH PLOT-1

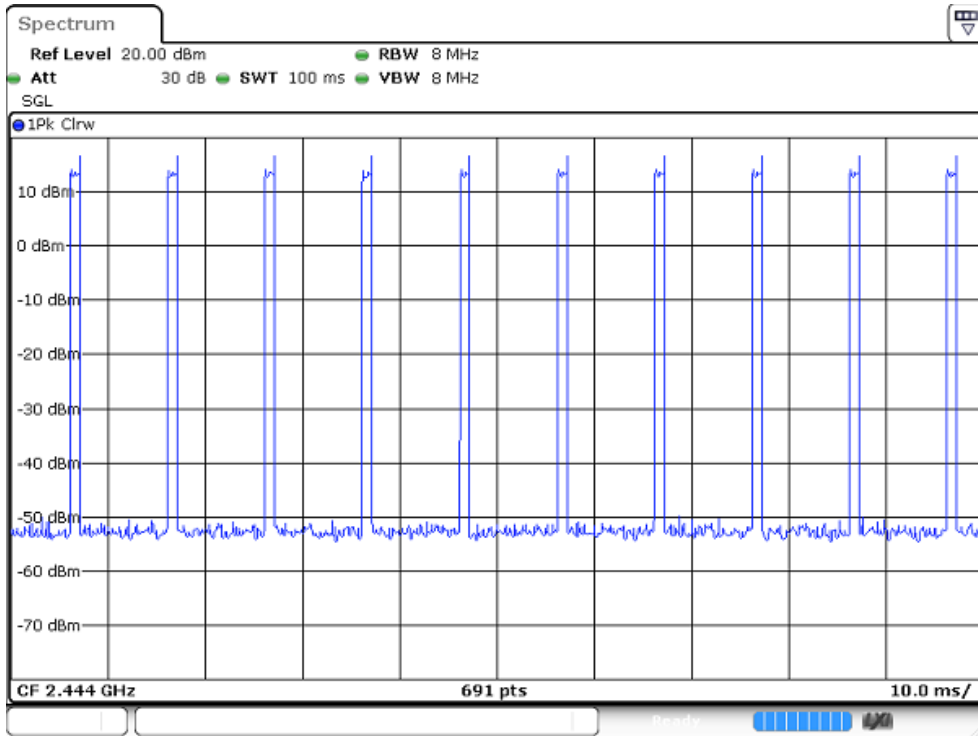

### ON TIME AND DUTY CYCLE MID CH PLOT-2

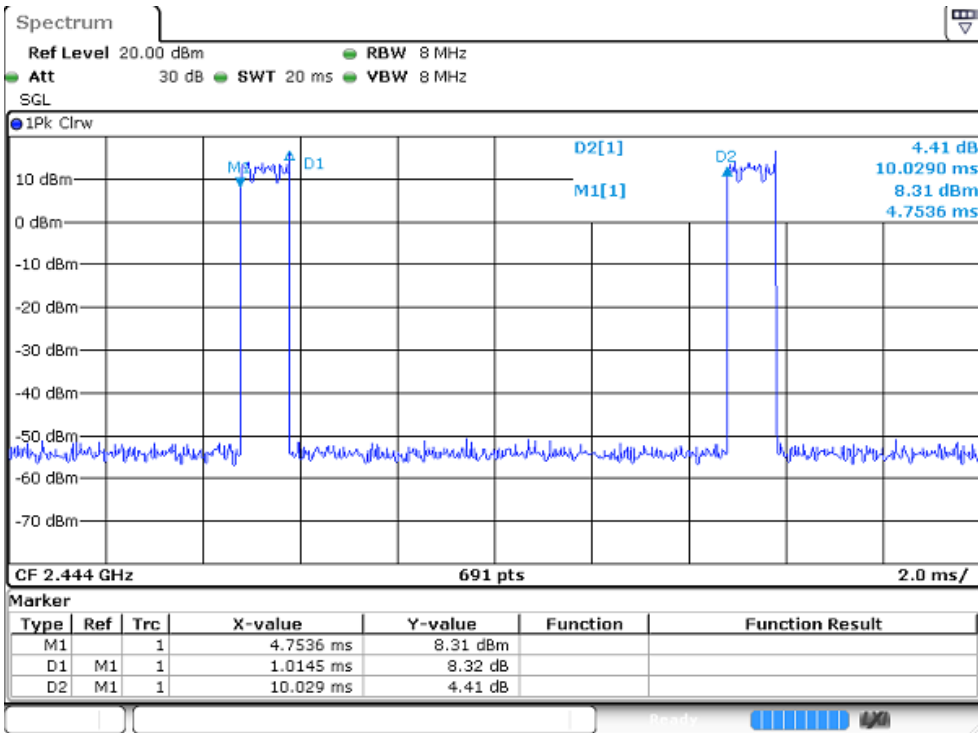

Note: The duty cycle of all modulations and bandwidths are the same, so we only report one mode and this will apply for all other mode.

## 7.2. 20 dB BANDWIDTH

### LIMITS

FCC Part15 (15.249) , Subpart C			
Section	Test Item	Limit	Frequency Range (MHz)
FCC 15.249(d)	Bandwidth	for reporting purposes only	2400-2483.5

### TEST PROCEDURE

Connect the UUT to the spectrum analyser and use the following settings:

Center Frequency	The centre frequency of the channel under test
Detector	Peak
RBW	1% to 5% of the occupied bandwidth
VBW	approximately 3×RBW
Trace	Max hold
Sweep	Auto couple

Allow the trace to stabilize and measure the maximum width of the emission that is constrained by the frequencies associated with the two outermost amplitude points (upper and lower frequencies) that are attenuated by 20 dB relative to the maximum level measured in the fundamental emission.

### TEST SETUP

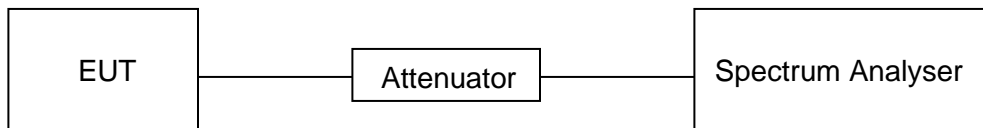





**RESULTS**

QPSK 10MHz Bandwidth Mode

Channel	Frequency (MHz)	20dB bandwidth (MHz)	Result
Low	2413	9.233	Pass
Middle	2444	9.349	Pass
High	2475	9.349	Pass

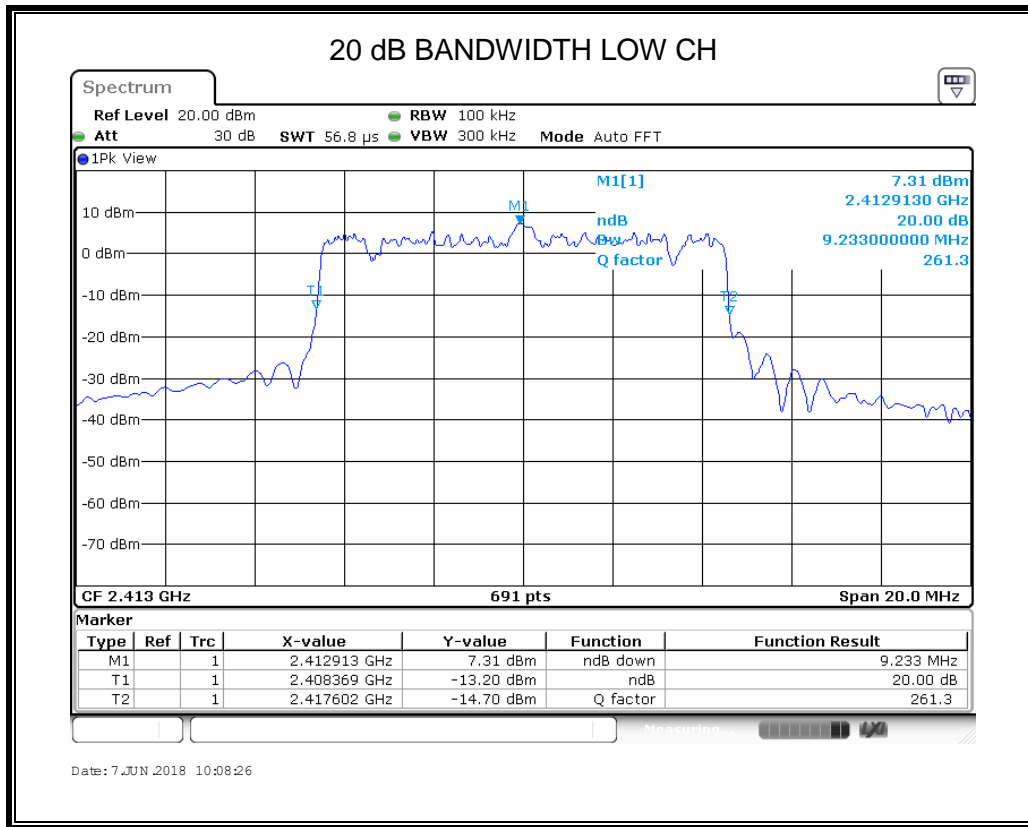

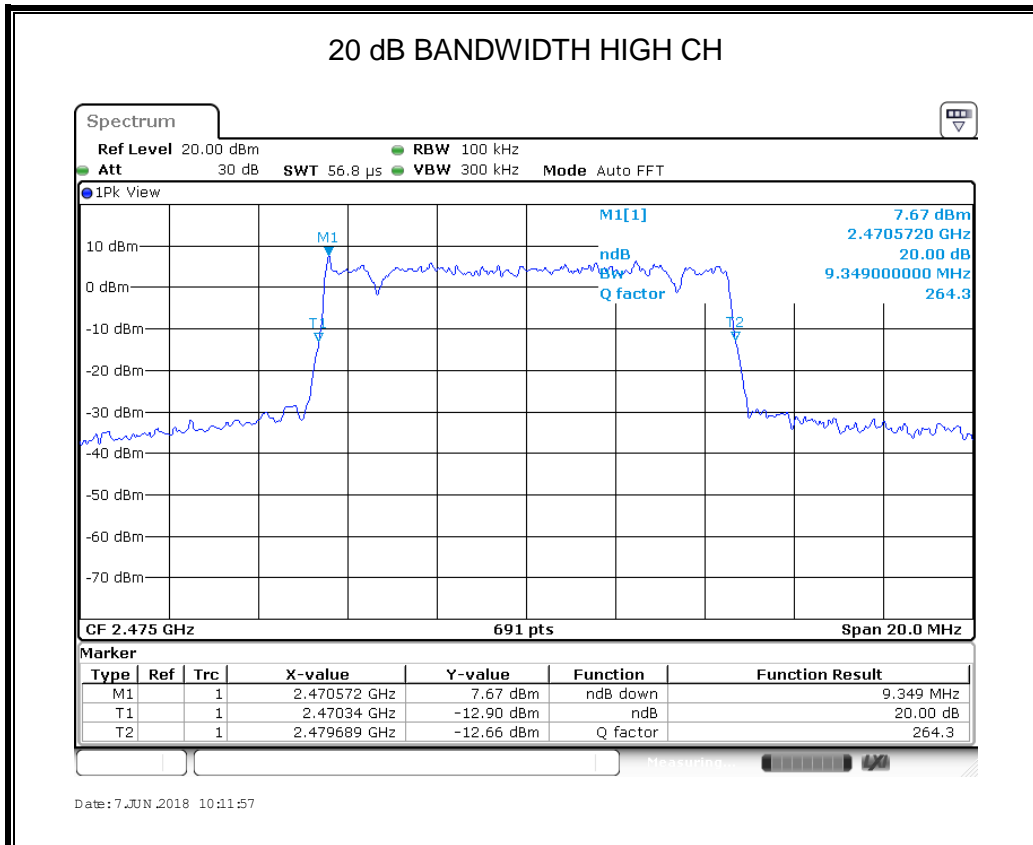
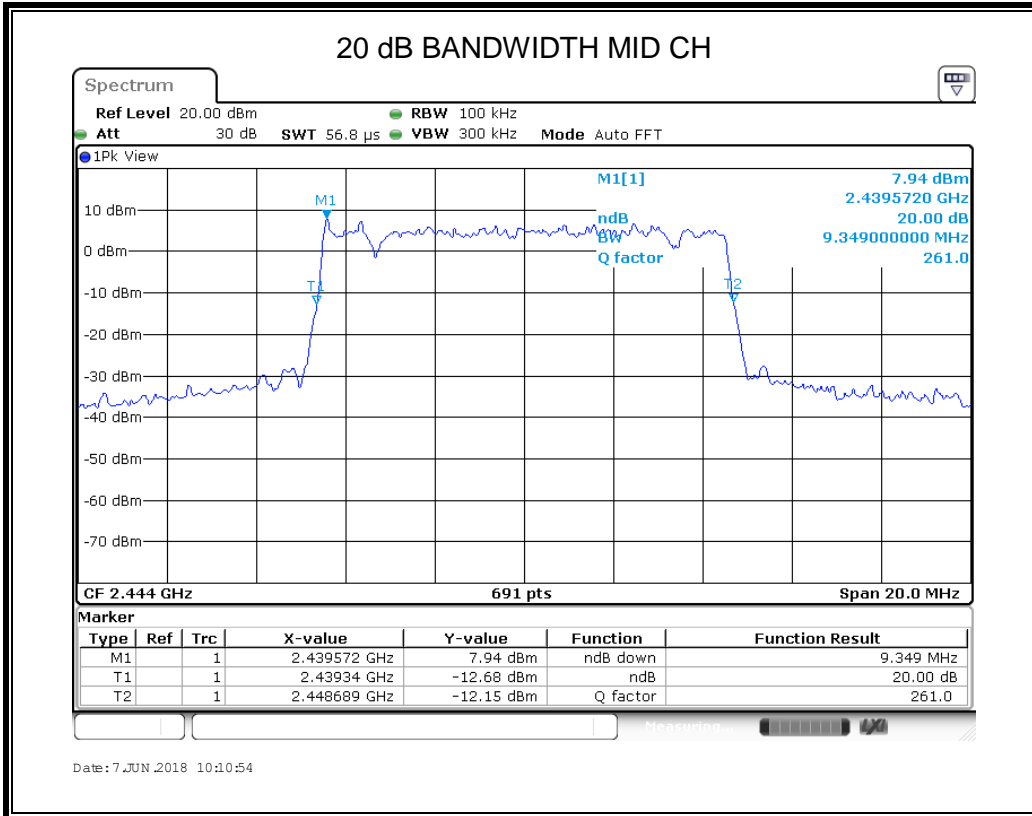



OFDM 10MHz Bandwidth Mode

Channel	Frequency (MHz)	20dB bandwidth (MHz)	Result
Low	2413	9.291	Pass
Middle	2444	9.320	Pass
High	2475	9.349	Pass

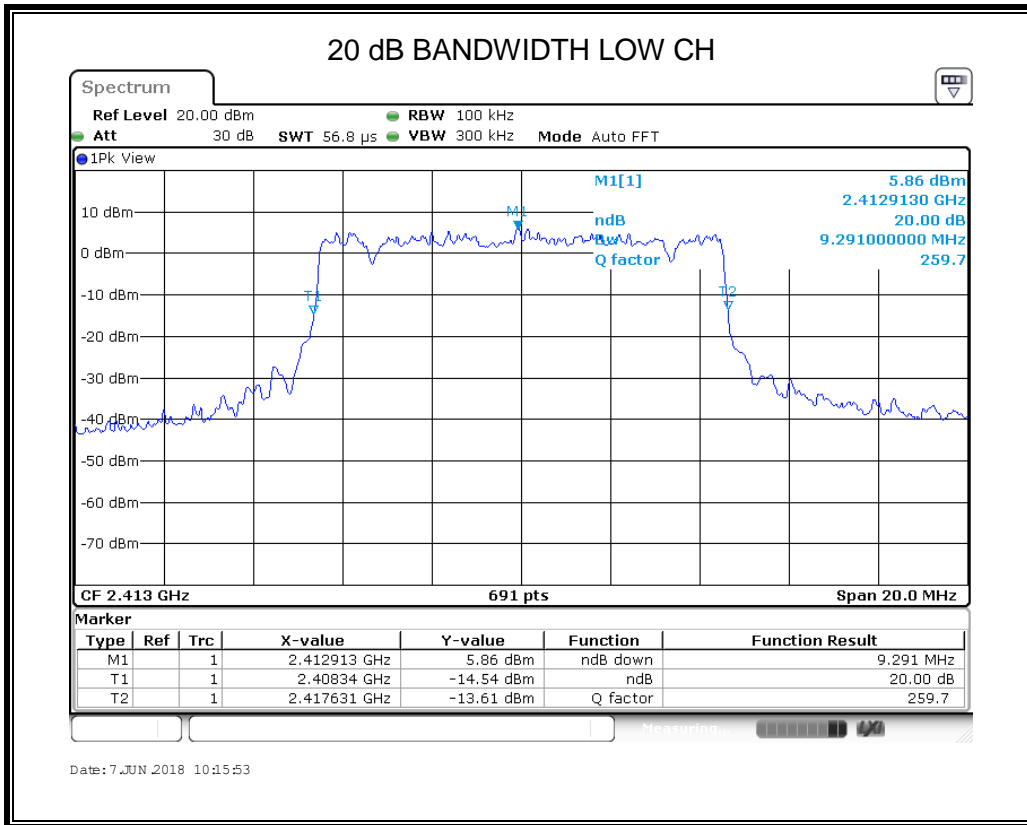

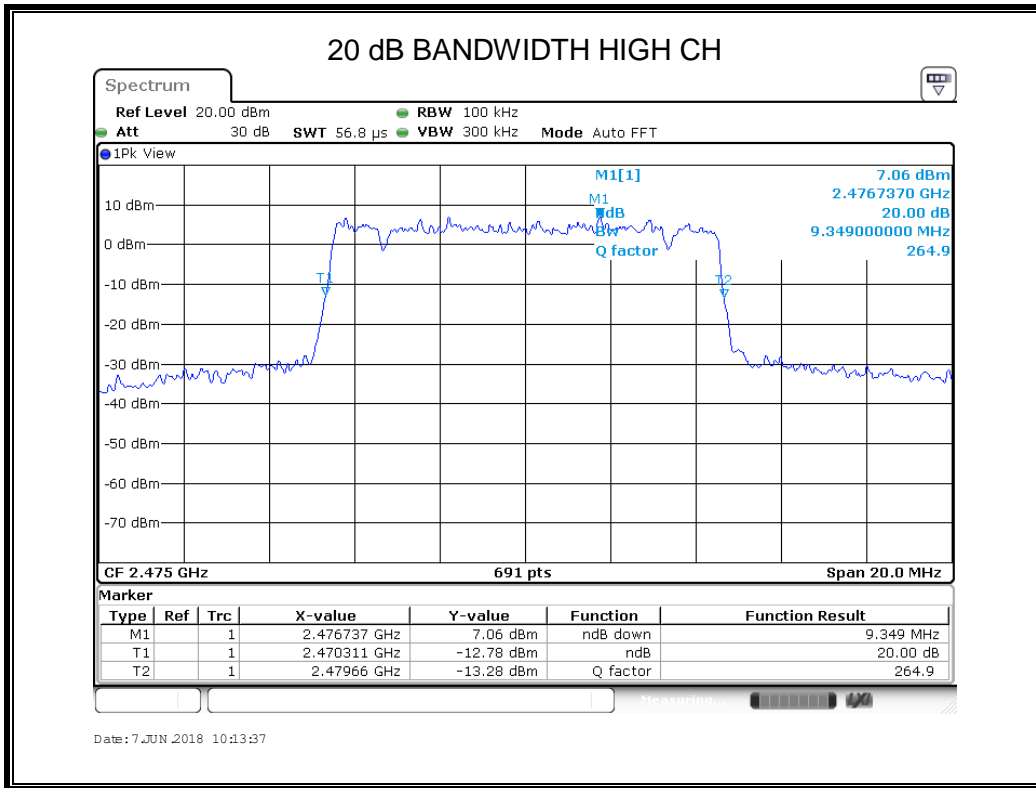
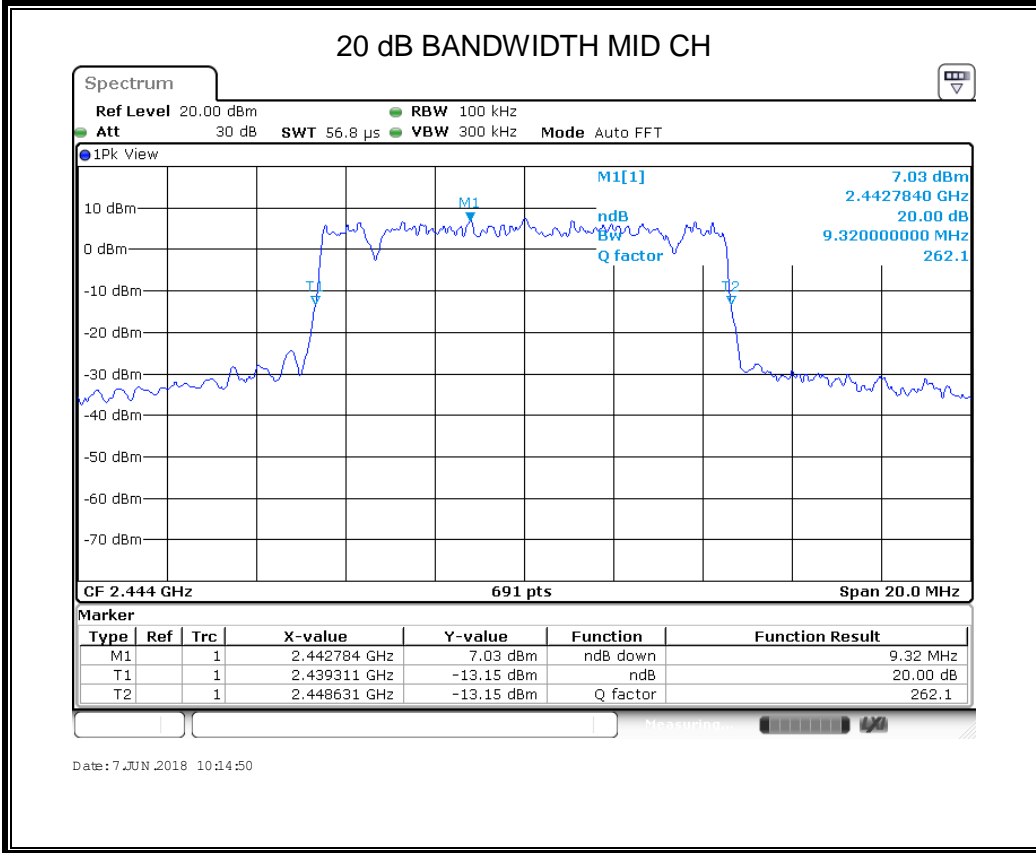



QPSK 20MHz Bandwidth Mode

Channel	Frequency (MHz)	20dB bandwidth (MHz)	Result
Low	2418	18.524	Pass
Middle	2444	18.292	Pass
High	2470	18.466	Pass

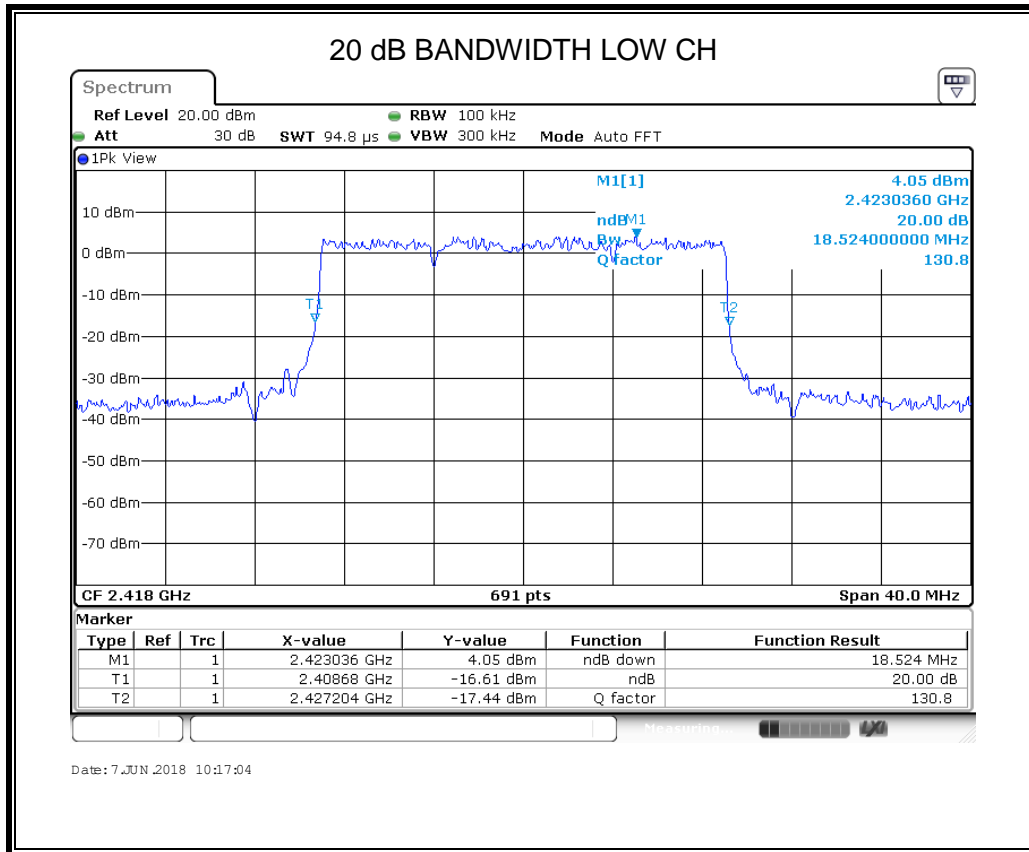

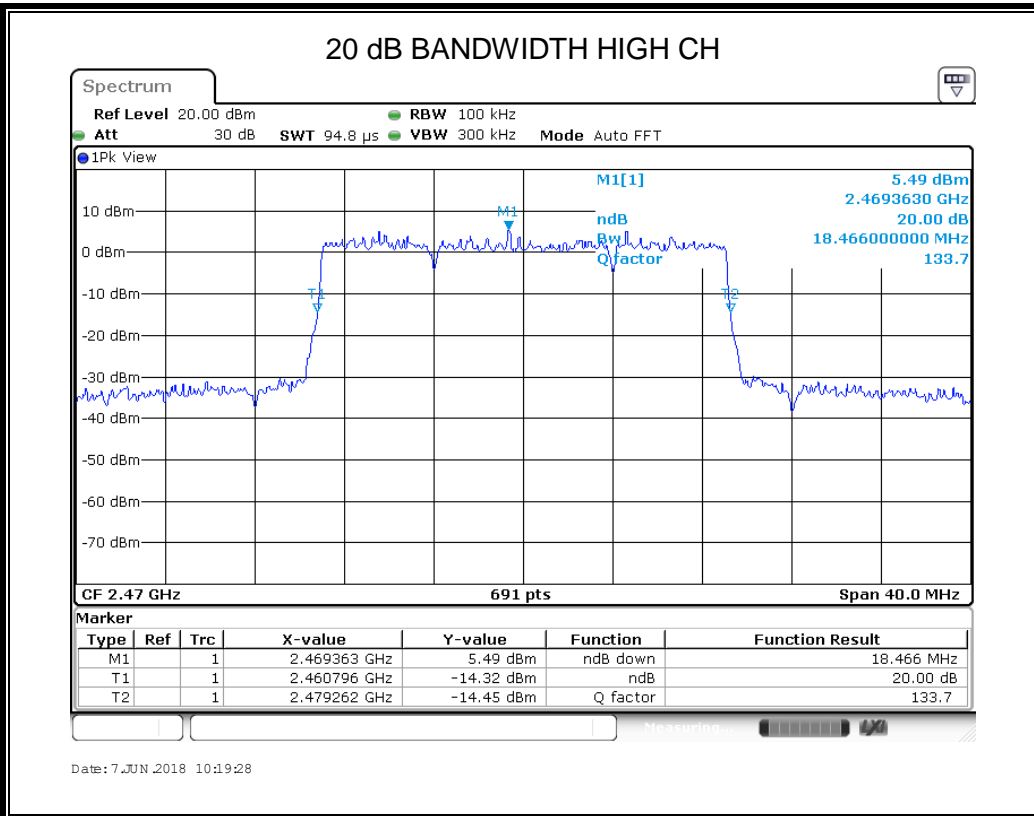
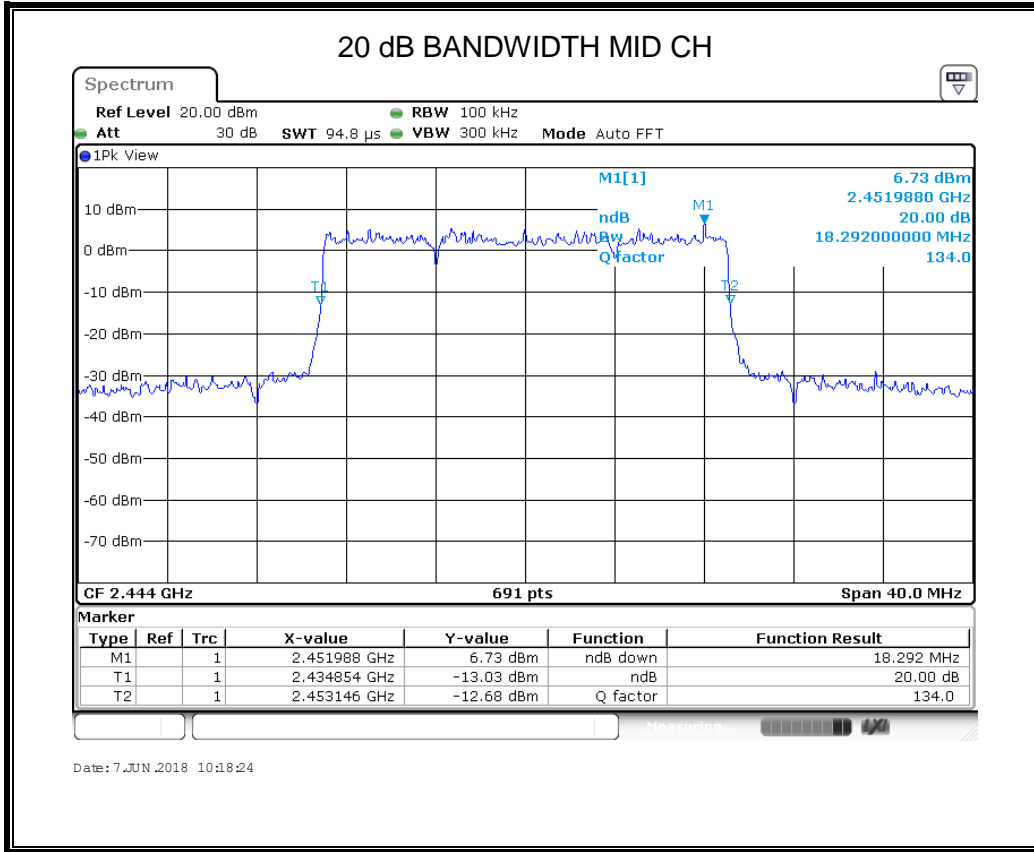



OFDM 20MHz Bandwidth Mode

Channel	Frequency (MHz)	20dB bandwidth (MHz)	Result
Low	2418	18.350	Pass
Middle	2444	18.292	Pass
High	2470	18.292	Pass

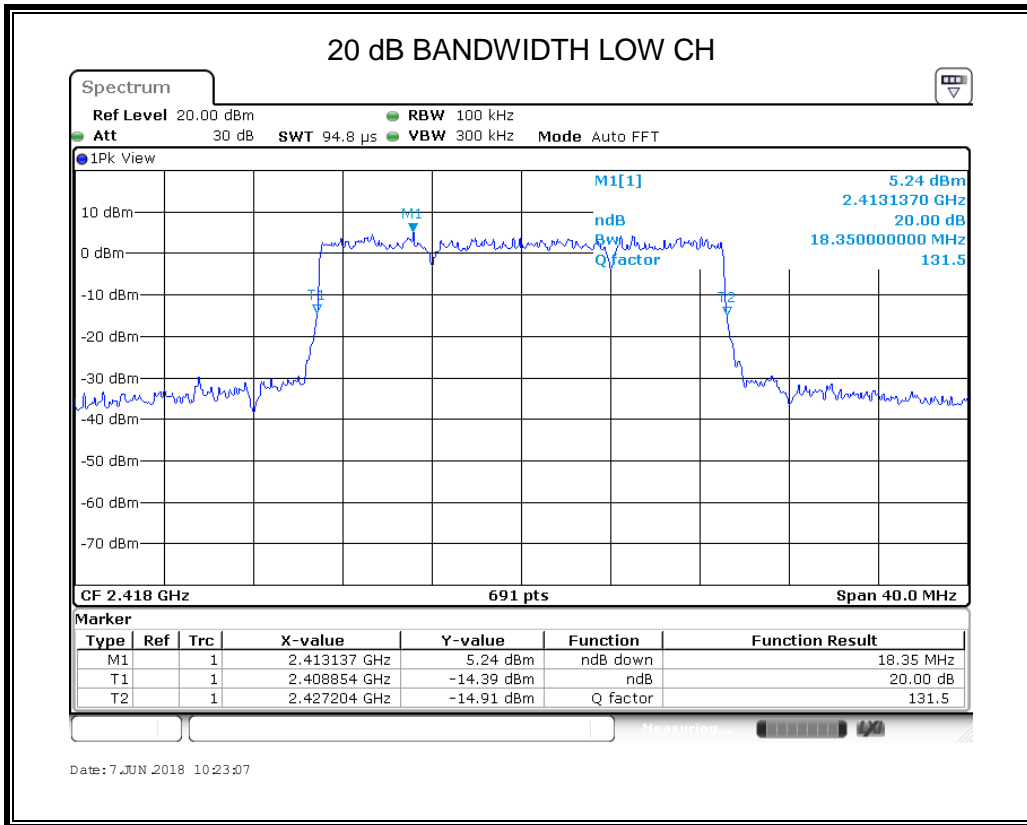

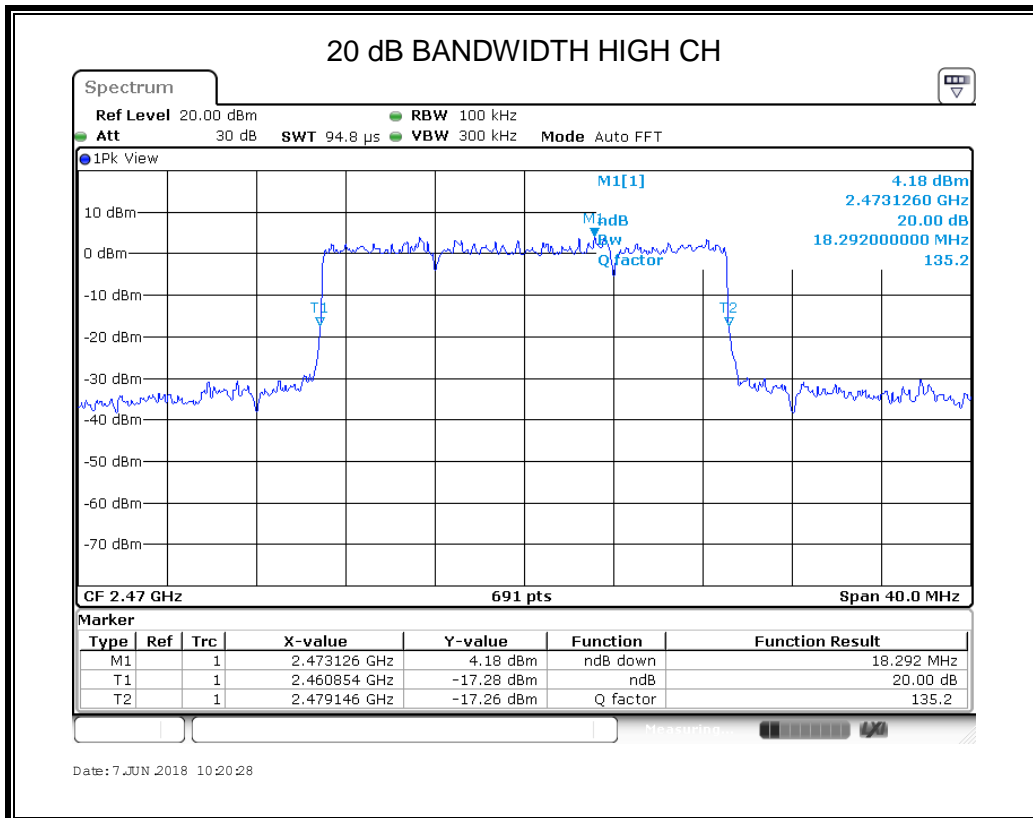
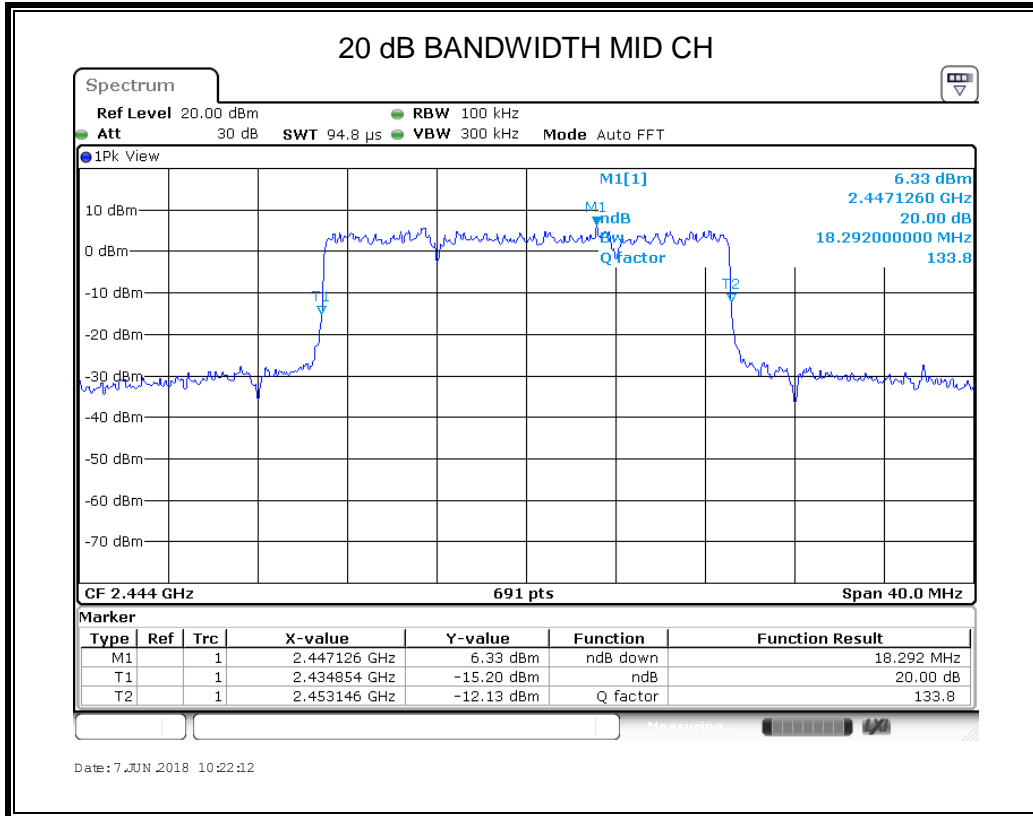





## 8. RADIATED TEST RESULTS

### 8.1. LIMITS AND PROCEDURE

#### LIMITS

Please refer to FCC §15.205 and §15.209

Please refer to FCC §15.249 (a)(d)(e)

The field strength of emissions from intentional radiators operated within these frequency bands			
Frequency (MHz)	Field strength of Fundamental	Field strength of Harmonics	Distance (m)
902 - 928	50 mV/m (94dBuV/m)	500 uV/m (54dBuV/m)	3
2400 – 2483.5	50 mV/m (94dBuV/m)	500 uV/m (54dBuV/m)	3
5725 – 5875	50 mV/m (94dBuV/m)	500 uV/m (54dBuV/m)	3

Emissions radiated outside of the specified frequency bands			
Frequency Range (MHz)	Field Strength Limit (uV/m) at 3 m	Field Strength Limit (dBuV/m) at 3 m	
		Quasi-Peak	
30 - 88	100	40	
30 - 88	100	40	
88 - 216	150	43.5	
216 - 960	200	46	
Above 960	500	54	
Above 1000	500	Peak	Average
		74	54

#### Restricted bands of operation

MHz	MHz	MHz	GHz
0.090-0.110	16.42-16.423	399.9-410	4.5-5.15
<sup>1</sup> 0.495-0.505	16.69475-16.69525	608-614	5.35-5.46
2.1735-2.1905	16.80425-16.80475	960-1240	7.25-7.75
4.125-4.128	25.5-25.67	1300-1427	8.025-8.5
4.17725-4.17775	37.5-38.25	1435-1626.5	9.0-9.2
4.20725-4.20775	73-74.6	1645.5-1646.5	9.3-9.5
6.215-6.218	74.8-75.2	1660-1710	10.6-12.7
6.26775-6.26825	108-121.94	1718.8-1722.2	13.25-13.4
6.31175-6.31225	123-138	2200-2300	14.47-14.5
8.291-8.294	149.9-150.05	2310-2390	15.35-16.2
8.362-8.366	156.52475-156.52525	2483.5-2500	17.7-21.4
8.37625-8.38675	156.7-156.9	2690-2900	22.01-23.12
8.41425-8.41475	162.0125-167.17	3260-3267	23.6-24.0
12.29-12.293	167.72-173.2	3332-3339	31.2-31.8
12.51975-12.52025	240-285	3345.8-3358	36.43-36.5
12.57675-12.57725	322-335.4	3600-4400	( <sup>2</sup> )
13.36-13.41			

Note: <sup>1</sup>Until February 1, 1999, this restricted band shall be 0.490-0.510 MHz.

<sup>2</sup>Above 38.6

**TEST SETUP AND PROCEDURE**

Below 30MHz

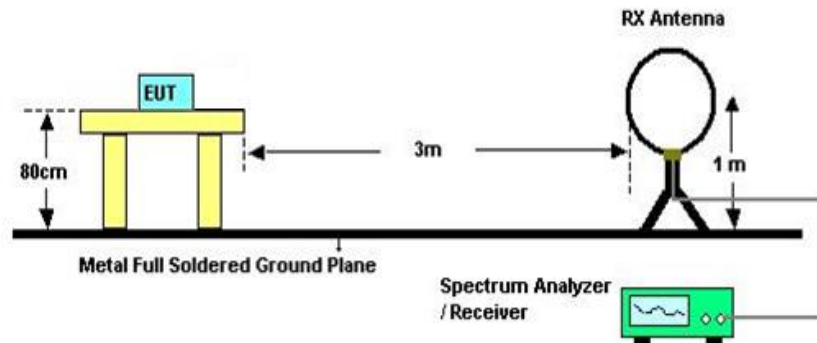

The setting of the spectrum analyser

RBW	200Hz (From 9kHz to 0.15MHz)/ 9KHz (From 0.15MHz to 30MHz)
VBW	200Hz (From 9kHz to 0.15MHz)/ 9KHz (From 0.15MHz to 30MHz)
Sweep	Auto
Detector	Peak/QP/ Average
Trace	Max hold

1. The testing follows the guidelines in ANSI C63.10-2013 and 414788 D01 Radiated Test Site v01.
2. The EUT was arranged to its worst case and then turntable (from 0 degree to 360 degrees) to find the maximum reading. A pre-amp and a high pass filter are used for the test in order to get better signal level. Both horizontal and vertical polarizations of the antenna are set to make the measurement.
3. The EUT was placed on a turntable with 80cm meter above ground.
4. The EUT was set 3 meters from the interference receiving antenna, which was mounted on the top of a variable height antenna tower.
5. The radiated emission limits are based on measurements employing a CISPR quasi-peak detector except for the frequency bands 9-90 kHz, 110-490 kHz and above 1000 MHz. Radiated emission limits in these three bands are based on measurements employing an average detector.
6. For measurement below 1GHz, the initial step in collecting conducted emission data is a spectrum analyzer peak detector mode pre-scanning the measurement frequency range. Significant peaks are then marked and then Quasi Peak detector mode re-measured. If the emission level of the EUT measured by the peak detector is 3 dB lower than the applicable limit, the peak emission level will be reported. Otherwise, the emission measurement will be repeated using the quasi-peak detector and reported.
7. Although these tests were performed other than open area test site, adequate comparison measurements were confirmed against 30m open are test site. Therefore sufficient tests were made to demonstrate that the alternative site produces results that correlate with the ones of tests made in an open field based on KDB 414788.

Below 1G

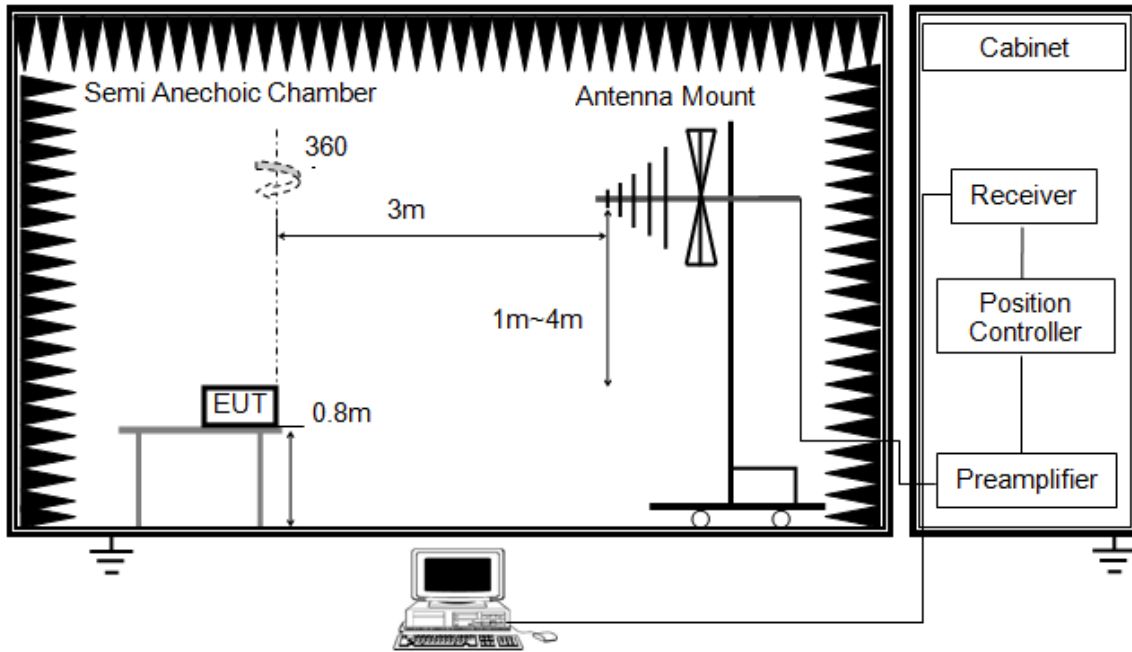

The setting of the spectrum analyser

RBW	120K
VBW	300K
Sweep	Auto
Detector	Peak/QP
Trace	Max hold

1. The testing follows the guidelines in ANSI C63.10-2013.
2. The EUT was arranged to its worst case and then tune the antenna tower (from 1 m to 4 m) and turntable (from 0 degree to 360 degrees) to find the maximum reading. A pre-amp and a high pass filter are used for the test in order to get better signal level. Both horizontal and vertical polarizations of the antenna are set to make the measurement.
3. The EUT was placed on a turntable with 0.8m above ground.
4. The EUT was set 3 meters from the interference receiving antenna, which was mounted on the top of a variable height antenna tower.
5. For measurement below 1GHz, the initial step in collecting conducted emission data is a spectrum analyzer peak detector mode pre-scanning the measurement frequency range. Significant peaks are then marked and then Quasi Peak detector mode re-measured. If the emission level of the EUT measured by the peak detector is 3 dB lower than the applicable limit, the peak emission level will be reported. Otherwise, the emission measurement will be repeated using the quasi-peak detector and reported.

ABOVE 1G

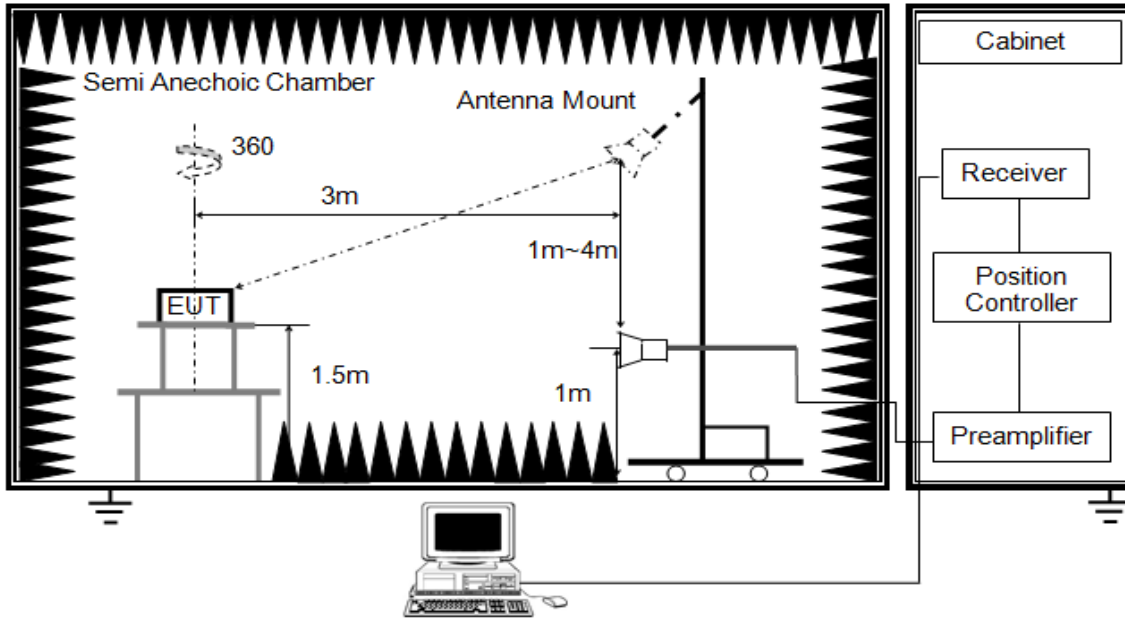

The setting of the spectrum analyser

RBW	1M MHz
VBW	PEAK: 3M AVG: see note 6
Sweep	Auto
Detector	Peak
Trace	Max hold

1. The testing follows the guidelines in ANSI C63.10-2013.
2. The EUT was arranged to its worst case and then tune the antenna tower (from 1 m to 4 m) and turntable (from 0 degree to 360 degrees) to find the maximum reading. A pre-amp and a high pass filter are used for the test in order to get better signal level. Both horizontal and vertical polarizations of the antenna are set to make the measurement.
3. The EUT was placed on a turntable with 1.5m above ground.
4. The EUT was set 3 meters from the interference receiving antenna, which was mounted on the top of a variable height antenna tower.
5. For measurement above 1GHz, the emission measurement will be measured by the peak detector. This peak level, once corrected, must comply with the limit specified in Section 15.209.
6. For measurements above 1 GHz the resolution bandwidth is set to 1 MHz, then the video bandwidth is set to 3 MHz for peak measurements and 1 MHz resolution bandwidth with 1/T video bandwidth with peak detector. For the Duty Cycle please refer to clause 7.1.ON TIME AND DUTY CYCLE.

X axis, Y axis, Z axis positions:

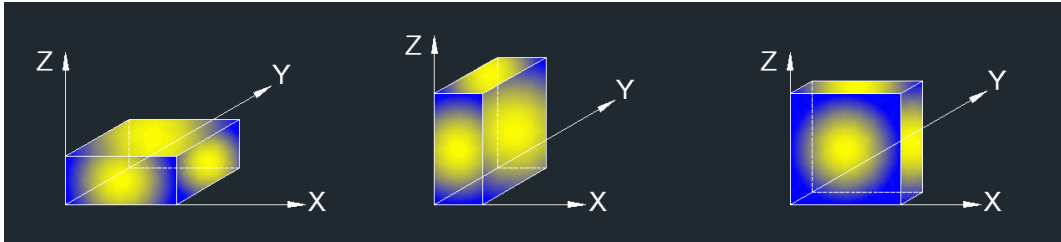

Note 1: For all radiated test, EUT in each of three orthogonal axis emissions had been tested, but only the worst case (X axis) data recorded in the report.

Note 2: All the EUT's emissions had been evaluated for simultaneous transmission with the other 915MHz and 5GHz transmitter and there were no any additional or worse emissions found.

Note 3: For all radiated measurements, EUT was worked in stand-alone mode but it can simulated the communication between PC and the accessories through software.



## 8.2. RESTRICTED BANDEGE AND FIELD STRENGTH OF INTENTIONAL EMISSIONS

QPSK 10MHz Bandwidth Mode

### RESTRICTED BANDEGE AND FIELD STRENGTH OF INTENTIONAL EMISSIONS (LOW CHANNEL, HORIZONTAL)

#### PEAK

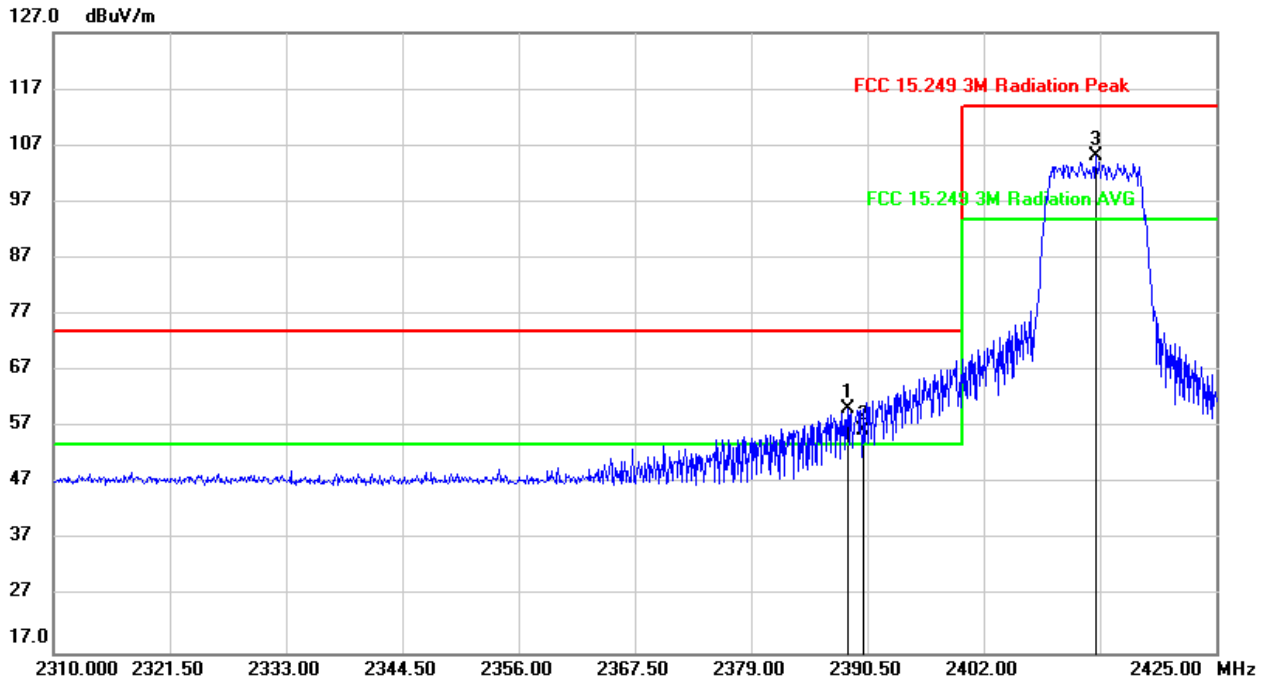

No.	Frequency (MHz)	Reading (dBuV)	Correct (dB/m)	Result (dBuV/m)	Limit (dBuV/m)	Margin (dB)	Remark
1	2388.545	27.13	33.15	60.28	74.00	-13.72	peak
2	2390.000	23.45	33.14	56.59	74.00	-17.41	peak
3	2413.040	72.15	33.00	105.15	114.00	-8.85	peak

Note: 1. Measurement = Reading Level + Correct Factor.

2. Only the worst case emission recorded in the report, if Peak Result complies with AV limit, AV Result is deemed to comply with AV limit.

3. Peak: Peak detector.



**AVG**

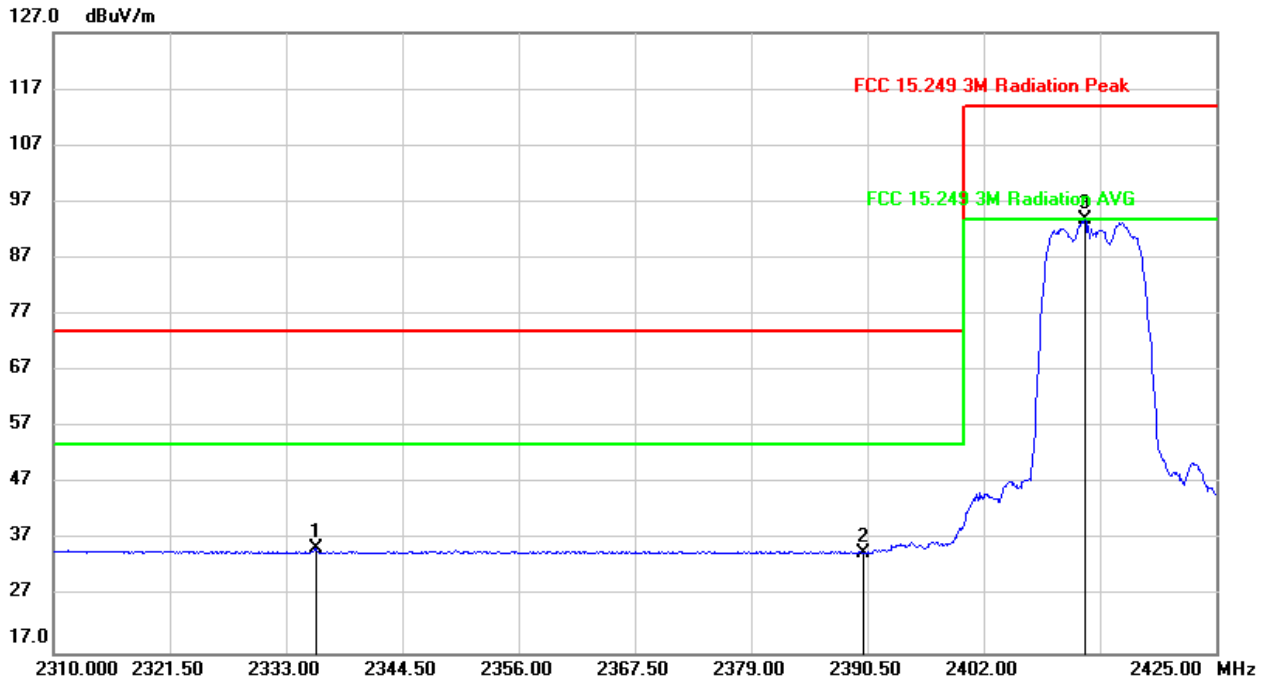

No.	Frequency (MHz)	Reading (dBuV)	Correct (dB/m)	Result (dBuV/m)	Limit (dBuV/m)	Margin (dB)	Remark
1	2335.990	1.91	33.53	35.44	54.00	-18.56	AVG
2	2390.000	1.63	33.14	34.77	54.00	-19.23	AVG
3	2412.005	60.72	33.01	93.73	94.00	-0.27	AVG

- Note:
1. Measurement = Reading Level + Correct Factor.
  2. If Peak Result complies with AV limit, AV Result is deemed to comply with AV limit.
  3. Peak: Peak detector.
  4. AVG: VBW=1/Ton=1K, where: Ton is transmit duration.
  5. For transmit duration, please refer to clause 7.1.



**RESTRICTED BANDEDGE AND FIELD STRENGTH OF INTENTIONAL EMISSIONS (LOW CHANNEL, VERTICAL)**

**PEAK**

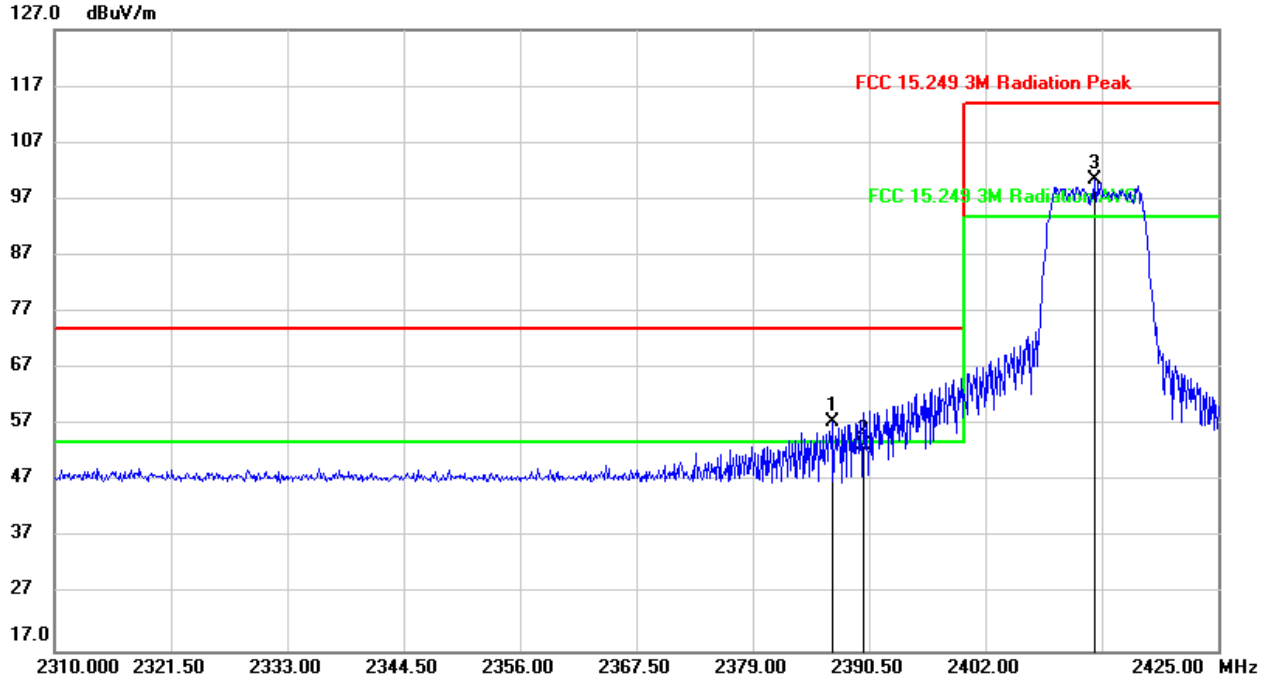

No.	Frequency (MHz)	Reading (dBuV)	Correct (dB/m)	Result (dBuV/m)	Limit (dBuV/m)	Margin (dB)	Remark
1	2386.820	24.32	33.27	57.59	74.00	-16.41	peak
2	2390.000	20.32	33.24	53.56	74.00	-20.44	peak
3	2412.810	67.42	33.10	100.52	114.00	-13.48	peak

Note: 1. Measurement = Reading Level + Correct Factor.

2. Only the worst case emission recorded in the report, if Peak Result complies with AV limit, AV Result is deemed to comply with AV limit.

3. Peak: Peak detector.





**AVG**

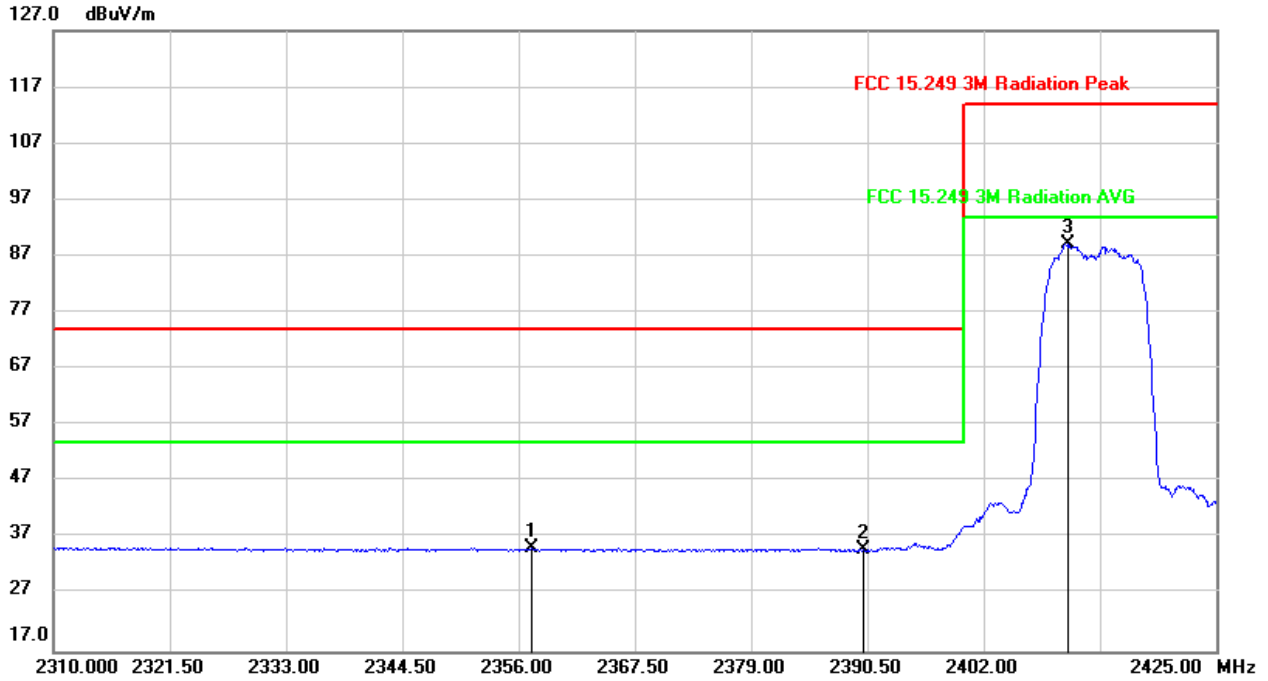

No.	Frequency (MHz)	Reading (dBuV)	Correct (dB/m)	Result (dBuV/m)	Limit (dBuV/m)	Margin (dB)	Remark
1	2357.265	1.77	33.48	35.25	54.00	-18.75	AVG
2	2390.000	1.75	33.24	34.99	54.00	-19.01	AVG
3	2410.280	56.03	33.12	89.15	94.00	-4.85	AVG

- Note:
1. Measurement = Reading Level + Correct Factor.
  2. If Peak Result complies with AV limit, AV Result is deemed to comply with AV limit.
  3. Peak: Peak detector.
  4. AVG:  $VBW=1/Ton=1K$ , where:  $Ton$  is transmit duration.
  5. For transmit duration, please refer to clause 7.1.



**FIELD STRENGTH OF INTENTIONAL EMISSIONS (MID CHANNEL, HORIZONTAL)**

**PEAK**

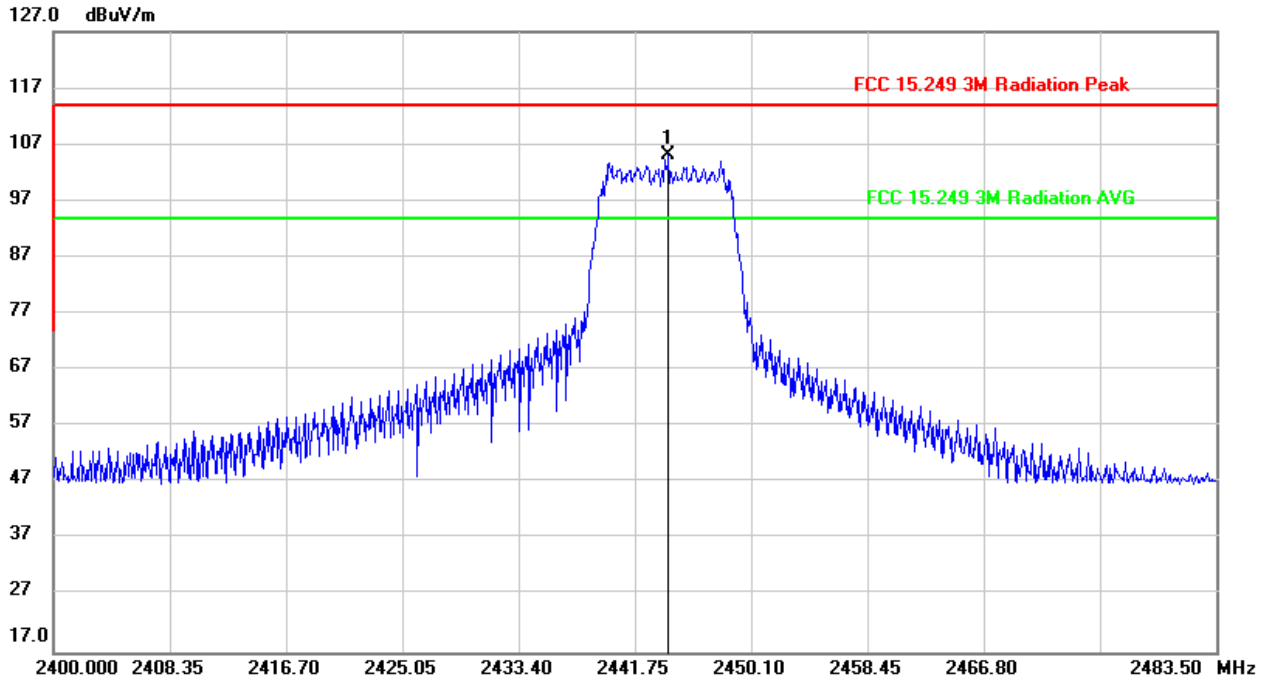

No.	Frequency (MHz)	Reading (dBuV)	Correct (dB/m)	Result (dBuV/m)	Limit (dBuV/m)	Margin (dB)	Remark
1	2444.171	72.18	32.84	105.02	114.00	-8.98	peak

- Note: 1. Measurement = Reading Level + Correct Factor.  
 2. Only the worst case emission recorded in the report, if Peak Result complies with AV limit, AV Result is deemed to comply with AV limit.  
 3. Peak: Peak detector.



**AVG**

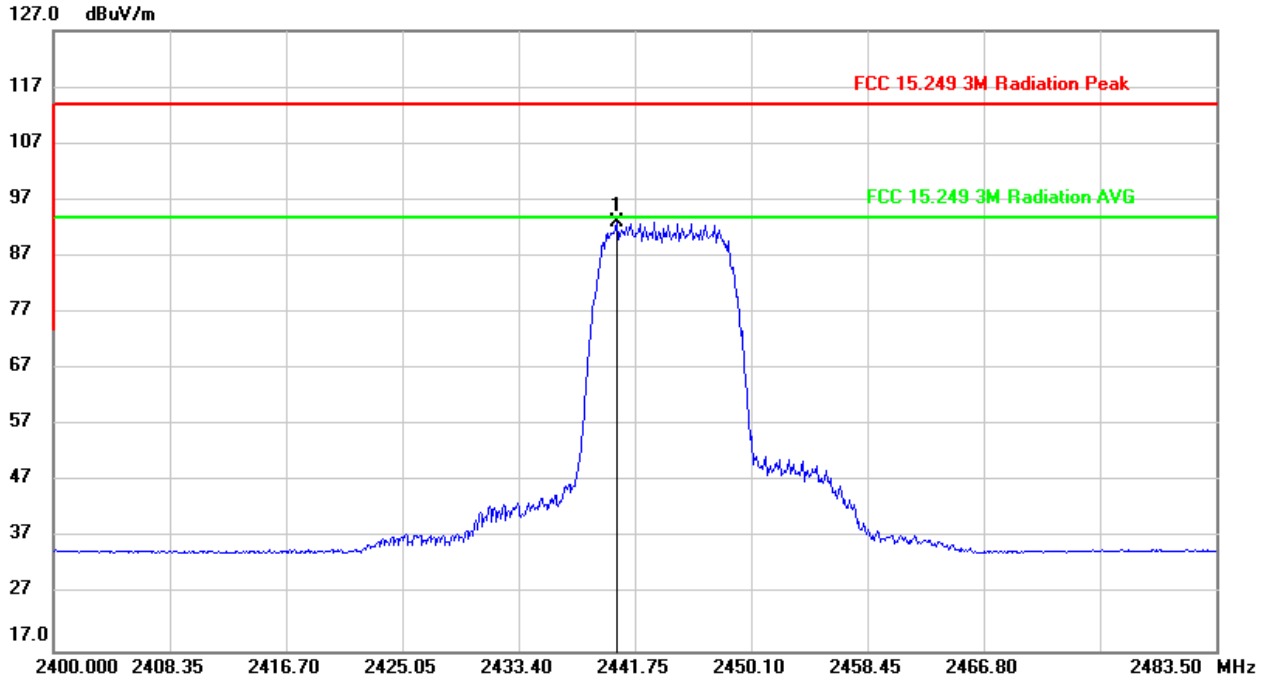

No.	Frequency (MHz)	Reading (dBuV)	Correct (dB/m)	Result (dBuV/m)	Limit (dBuV/m)	Margin (dB)	Remark
1	2440.414	60.13	32.87	93.00	94.00	-1.00	AVG

- Note:
1. Measurement = Reading Level + Correct Factor.
  2. If Peak Result complies with AV limit, AV Result is deemed to comply with AV limit.
  3. Peak: Peak detector.
  4. AVG: VBW=1/Ton=1K, where: Ton is transmit duration.
  5. For transmit duration, please refer to clause 7.1.



**FIELD STRENGTH OF INTENTIONAL EMISSIONS (MID CHANNEL, VERTICAL)**

**PEAK**

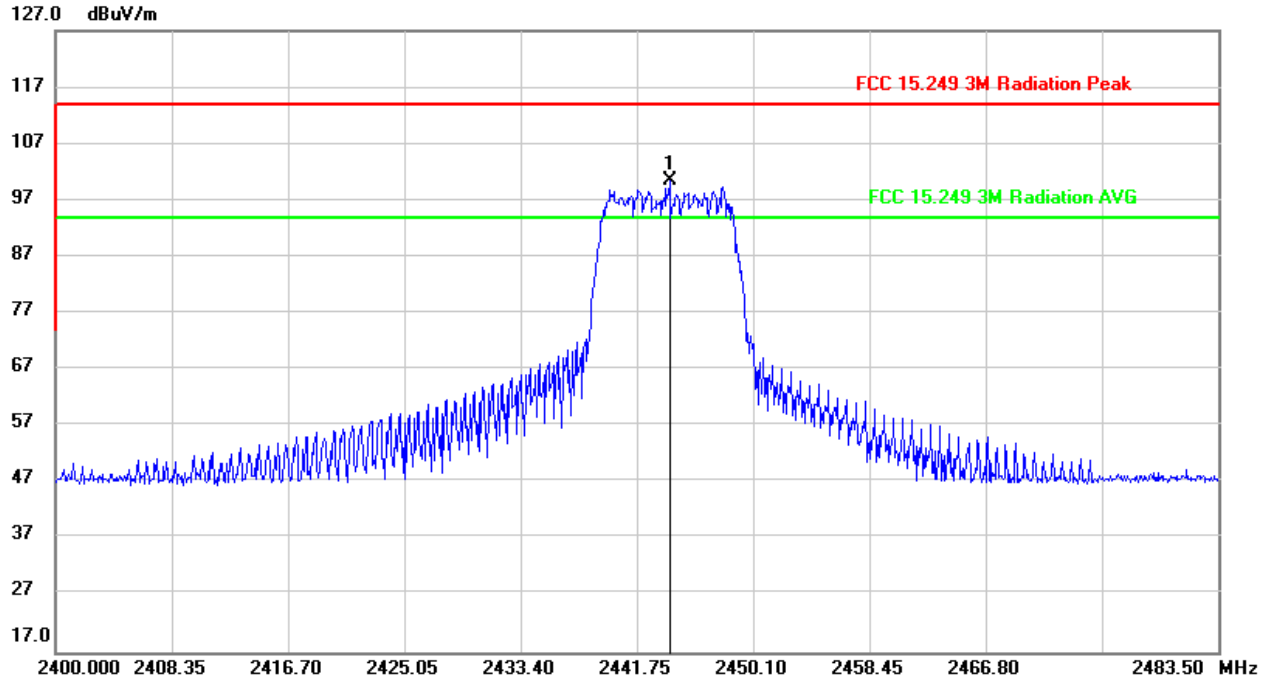

No.	Frequency (MHz)	Reading (dBuV)	Correct (dB/m)	Result (dBuV/m)	Limit (dBuV/m)	Margin (dB)	Remark
1	2444.088	67.59	32.95	100.54	114.00	-13.46	peak

- Note: 1. Measurement = Reading Level + Correct Factor.  
 2. Only the worst case emission recorded in the report, if Peak Result complies with AV limit, AV Result is deemed to comply with AV limit.  
 3. Peak: Peak detector.



**AVG**

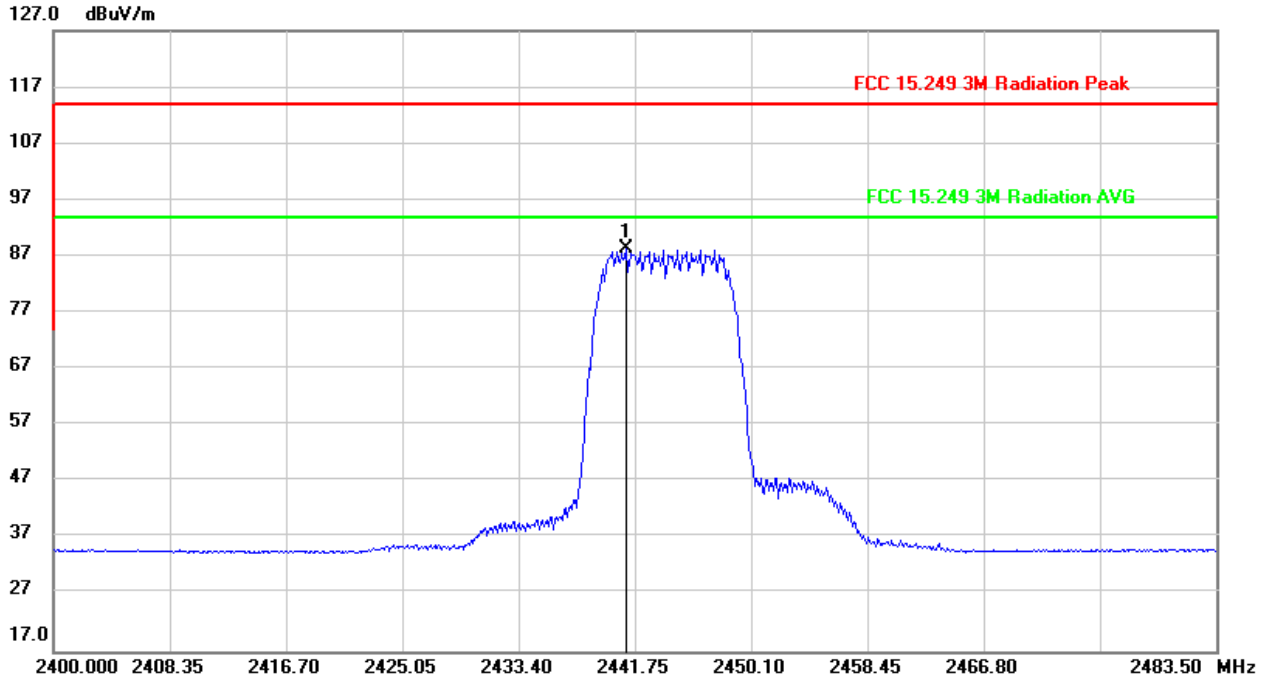

No.	Frequency (MHz)	Reading (dBuV)	Correct (dB/m)	Result (dBuV/m)	Limit (dBuV/m)	Margin (dB)	Remark
1	2441.166	55.30	32.96	88.26	94.00	-5.74	AVG

- Note:
1. Measurement = Reading Level + Correct Factor.
  2. If Peak Result complies with AV limit, AV Result is deemed to comply with AV limit.
  3. Peak: Peak detector.
  4. AVG:  $VBW=1/Ton=1K$ , where: Ton is transmit duration.
  5. For transmit duration, please refer to clause 7.1.



**RESTRICTED BANDEDGE AND FIELD STRENGTH OF INTENTIONAL EMISSIONS (HIGH CHANNEL, HORIZONTAL)**

**PEAK**

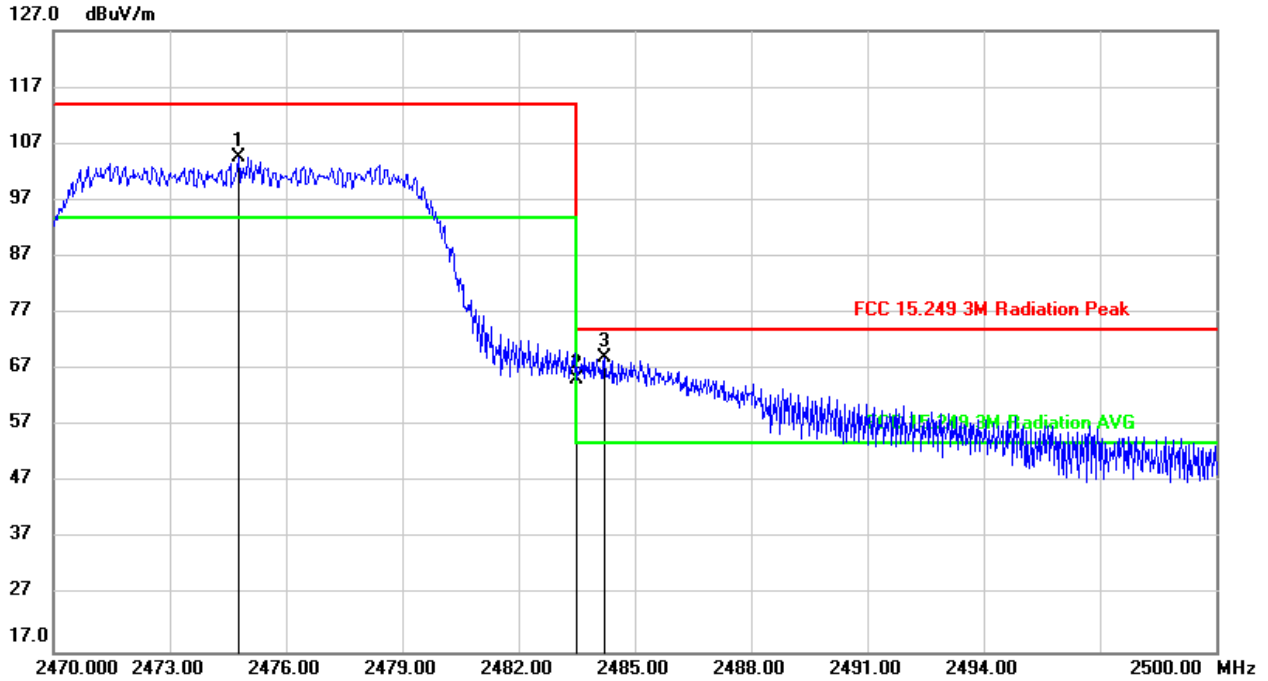

No.	Frequency (MHz)	Reading (dBuV)	Correct (dB/m)	Result (dBuV/m)	Limit (dBuV/m)	Margin (dB)	Remark
1	2474.770	71.78	32.79	104.57	114.00	-9.43	peak
2	2483.500	32.55	32.78	65.33	74.00	-8.67	peak
3	2484.220	36.41	32.78	69.19	74.00	-4.81	peak

- Note: 1. Measurement = Reading Level + Correct Factor.  
 2. Only the worst case emission recorded in the report, if Peak Result complies with AV limit, AV Result is deemed to comply with AV limit.  
 3. Peak: Peak detector.



**AVG**

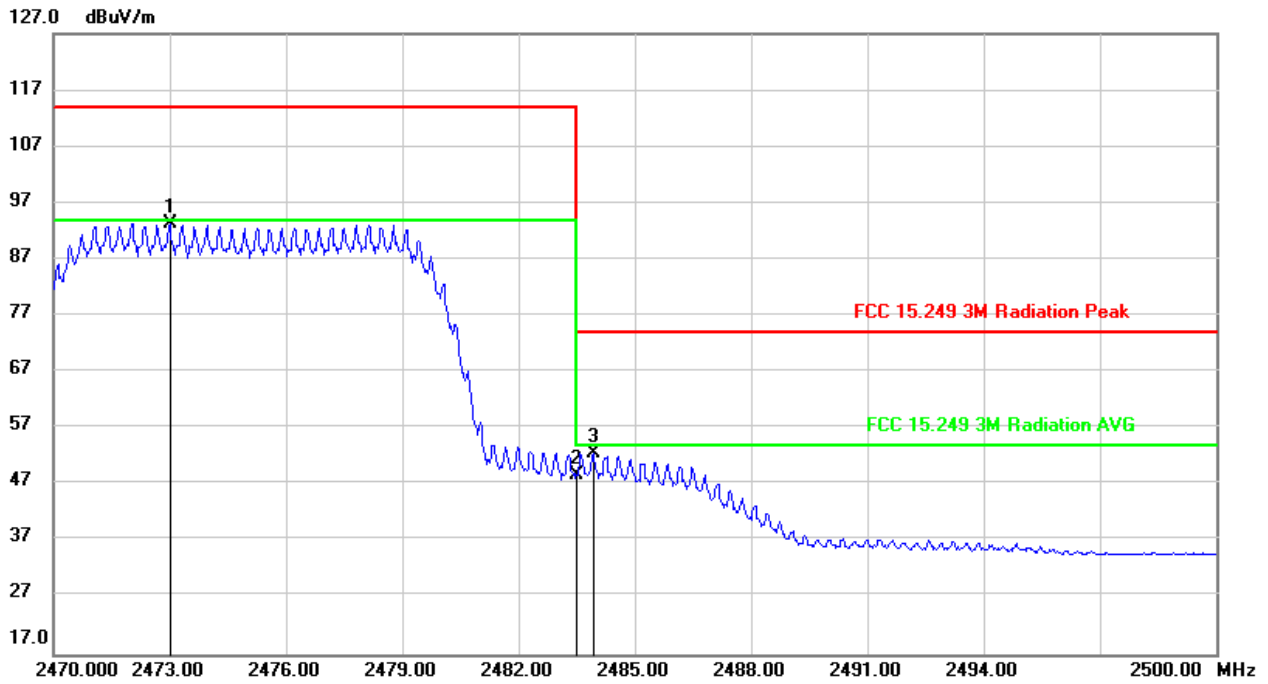

No.	Frequency (MHz)	Reading (dBuV)	Correct (dB/m)	Result (dBuV/m)	Limit (dBuV/m)	Margin (dB)	Remark
1	2473.000	60.44	32.79	93.23	94.00	-0.77	AVG
2	2483.500	15.96	32.78	48.74	54.00	-5.26	AVG
3	2483.920	19.84	32.78	52.62	54.00	-1.38	AVG

- Note: 1. Measurement = Reading Level + Correct Factor.  
 2. If Peak Result complies with AV limit, AV Result is deemed to comply with AV limit.  
 3. Peak: Peak detector.  
 4. AVG: VBW=1/Ton=1K, where: Ton is transmit duration.  
 5. For transmit duration, please refer to clause 7.1.



**RESTRICTED BANDEDGE AND FIELD STRENGTH OF INTENTIONAL EMISSIONS (HIGH CHANNEL, VERTICAL)**

**PEAK**

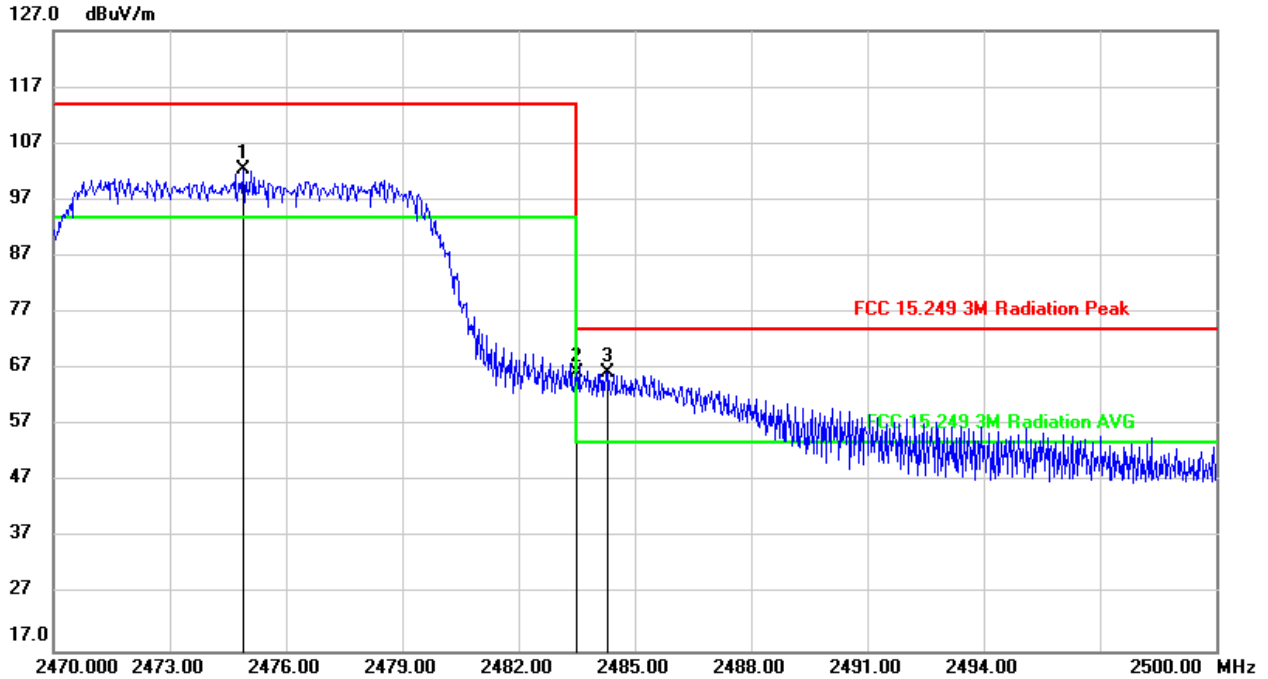

No.	Frequency (MHz)	Reading (dBuV)	Correct (dB/m)	Result (dBuV/m)	Limit (dBuV/m)	Margin (dB)	Remark
1	2474.890	69.58	32.89	102.47	114.00	-11.53	peak
2	2483.500	33.50	32.88	66.38	74.00	-7.62	peak
3	2484.310	33.40	32.88	66.28	74.00	-7.72	peak

Note: 1. Measurement = Reading Level + Correct Factor.

2. Only the worst case emission recorded in the report, if Peak Result complies with AV limit, AV Result is deemed to comply with AV limit.

3. Peak: Peak detector.





**AVG**

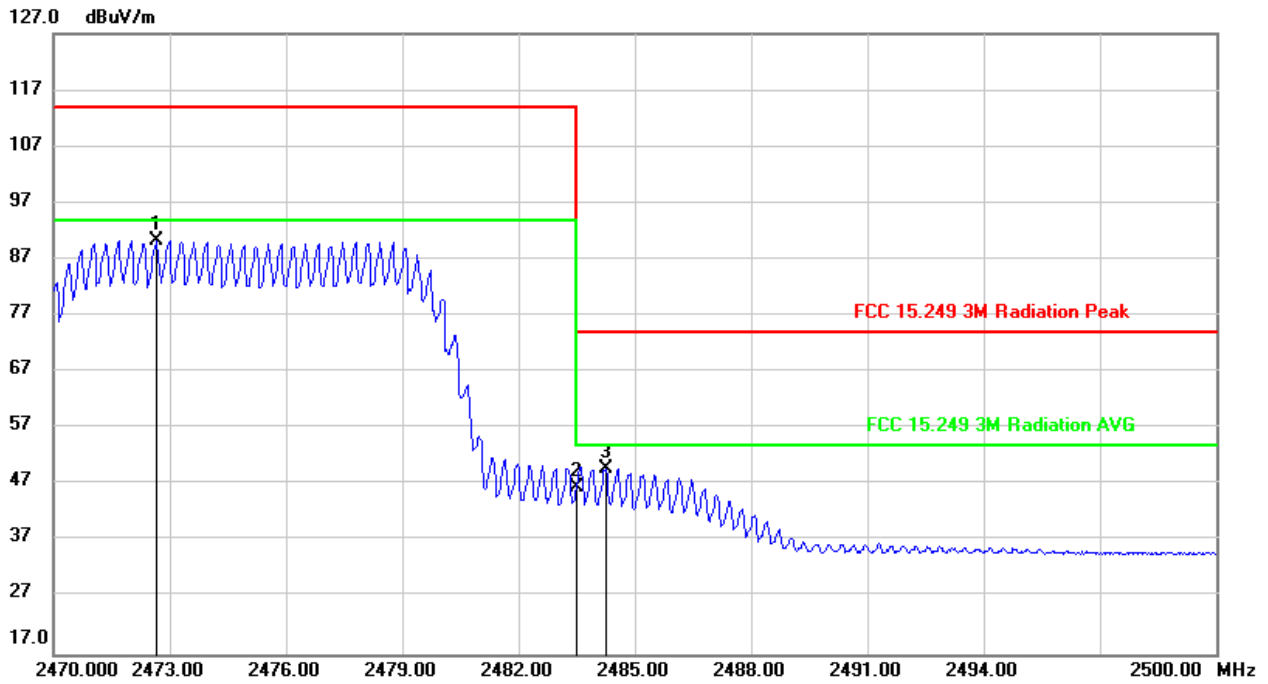

No.	Frequency (MHz)	Reading (dBuV)	Correct (dB/m)	Result (dBuV/m)	Limit (dBuV/m)	Margin (dB)	Remark
1	2472.670	57.36	32.89	90.25	94.00	-3.75	AVG
2	2483.500	13.64	32.88	46.52	54.00	-7.48	AVG
3	2484.250	16.92	32.88	49.80	54.00	-4.20	AVG

- Note: 1. Measurement = Reading Level + Correct Factor.  
 2. If Peak Result complies with AV limit, AV Result is deemed to comply with AV limit.  
 3. Peak: Peak detector.  
 4. AVG:  $VBW=1/Ton=1K$ , where: Ton is transmit duration.  
 5. For transmit duration, please refer to clause 7.1.



OFDM 10MHz Bandwidth Mode

**RESTRICTED BANDEDGE AND FIELD STRENGTH OF INTENTIONAL EMISSIONS (LOW CHANNEL, HORIZONTAL)**

**PEAK**

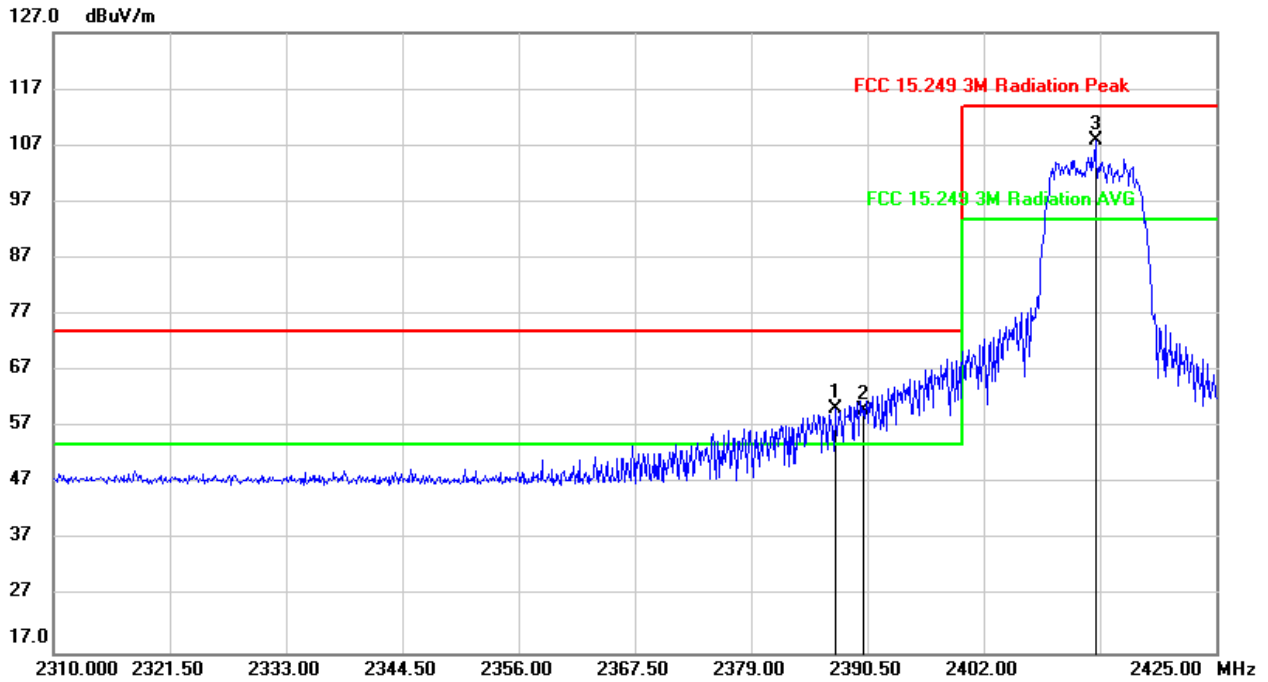

No.	Frequency (MHz)	Reading (dBuV)	Correct (dB/m)	Result (dBuV/m)	Limit (dBuV/m)	Margin (dB)	Remark
1	2387.280	27.27	33.16	60.43	74.00	-13.57	peak
2	2390.000	26.84	33.14	59.98	74.00	-14.02	peak
3	2413.040	74.86	33.00	107.86	114.00	-6.14	peak

Note: 1. Measurement = Reading Level + Correct Factor.  
 2. Only the worst case emission recorded in the report, if Peak Result complies with AV limit, AV Result is deemed to comply with AV limit.  
 3. Peak: Peak detector.



**AVG**

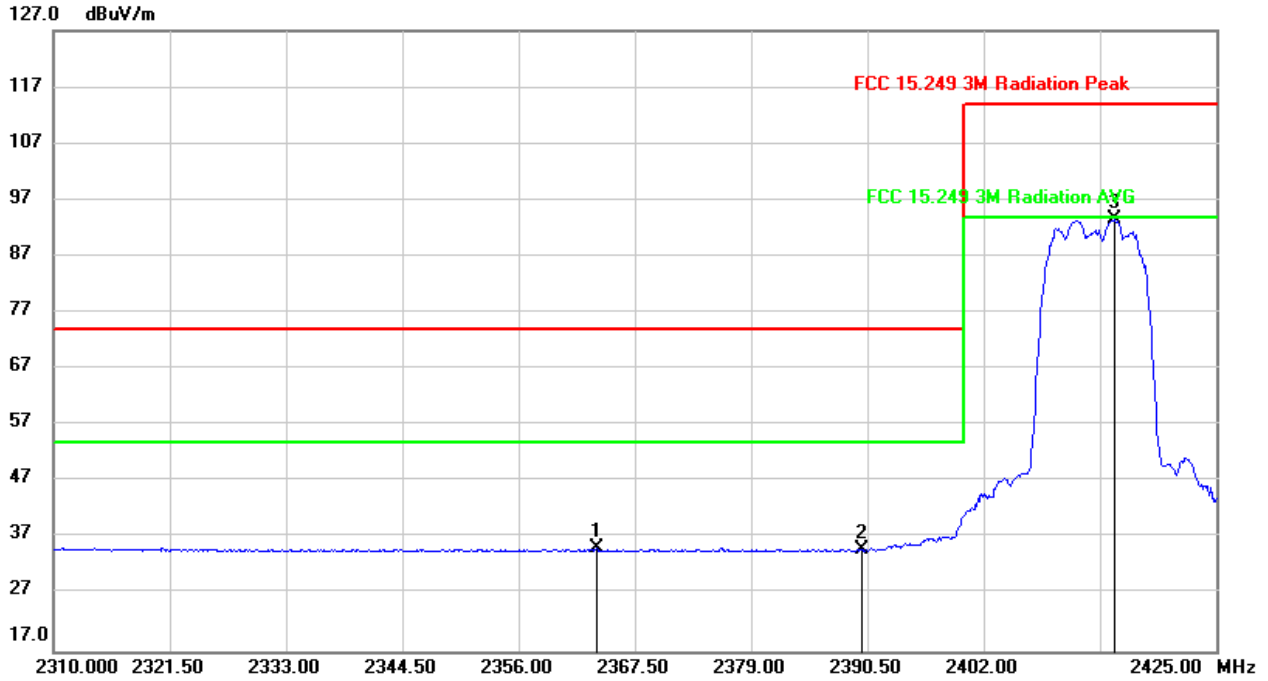

No.	Frequency (MHz)	Reading (dBuV)	Correct (dB/m)	Result (dBuV/m)	Limit (dBuV/m)	Margin (dB)	Remark
1	2363.705	1.94	33.33	35.27	54.00	-18.73	AVG
2	2390.000	1.74	33.14	34.88	54.00	-19.12	AVG
3	2414.995	60.47	32.99	93.46	94.00	-0.54	AVG

- Note:
1. Measurement = Reading Level + Correct Factor.
  2. If Peak Result complies with AV limit, AV Result is deemed to comply with AV limit.
  3. Peak: Peak detector.
  4. AVG:  $VBW=1/T_{on}=1K$ , where:  $T_{on}$  is transmit duration.
  5. For transmit duration, please refer to clause 7.1.



**RESTRICTED BANDEDGE AND FIELD STRENGTH OF INTENTIONAL EMISSIONS (LOW CHANNEL, VERTICAL)**

**PEAK**

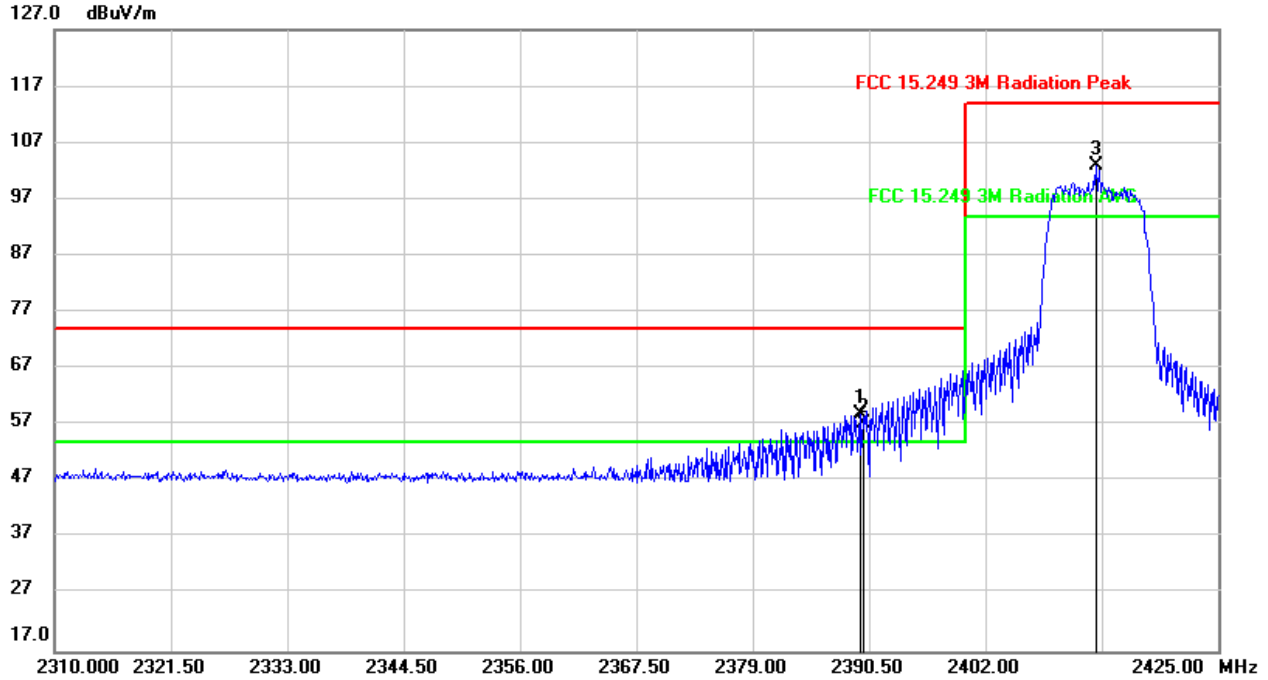

No.	Frequency (MHz)	Reading (dBuV)	Correct (dB/m)	Result (dBuV/m)	Limit (dBuV/m)	Margin (dB)	Remark
1	2389.580	25.60	33.24	58.84	74.00	-15.16	peak
2	2390.000	24.09	33.24	57.33	74.00	-16.67	peak
3	2412.925	69.85	33.10	102.95	114.00	-11.05	peak

Note: 1. Measurement = Reading Level + Correct Factor.

2. Only the worst case emission recorded in the report, if Peak Result complies with AV limit, AV Result is deemed to comply with AV limit.

3. Peak: Peak detector.



**AVG**

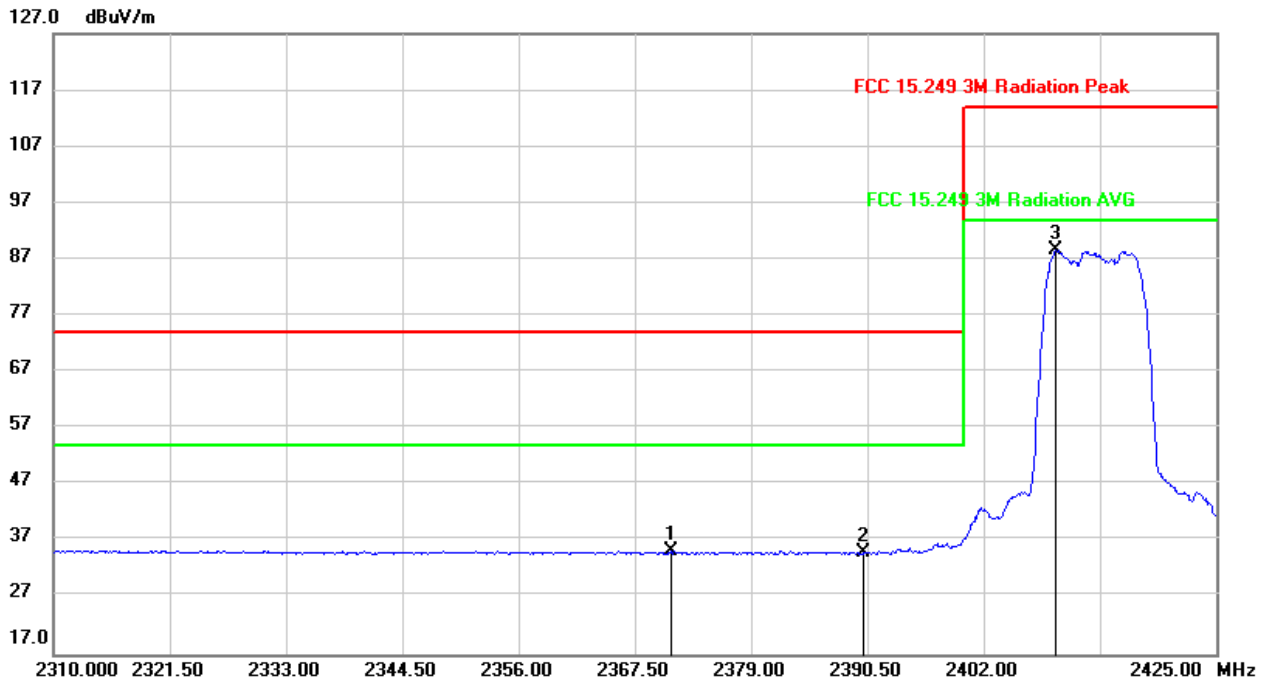

No.	Frequency (MHz)	Reading (dBuV)	Correct (dB/m)	Result (dBuV/m)	Limit (dBuV/m)	Margin (dB)	Remark
1	2371.065	1.87	33.38	35.25	54.00	-18.75	AVG
2	2390.000	1.65	33.24	34.89	54.00	-19.11	AVG
3	2409.130	55.53	33.13	88.66	94.00	-5.34	AVG

- Note:
1. Measurement = Reading Level + Correct Factor.
  2. If Peak Result complies with AV limit, AV Result is deemed to comply with AV limit.
  3. Peak: Peak detector.
  4. AVG: VBW=1/Ton=1K, where: Ton is transmit duration.
  5. For transmit duration, please refer to clause 7.1.



**FIELD STRENGTH OF INTENTIONAL EMISSIONS (MID CHANNEL, HORIZONTAL)**

**PEAK**

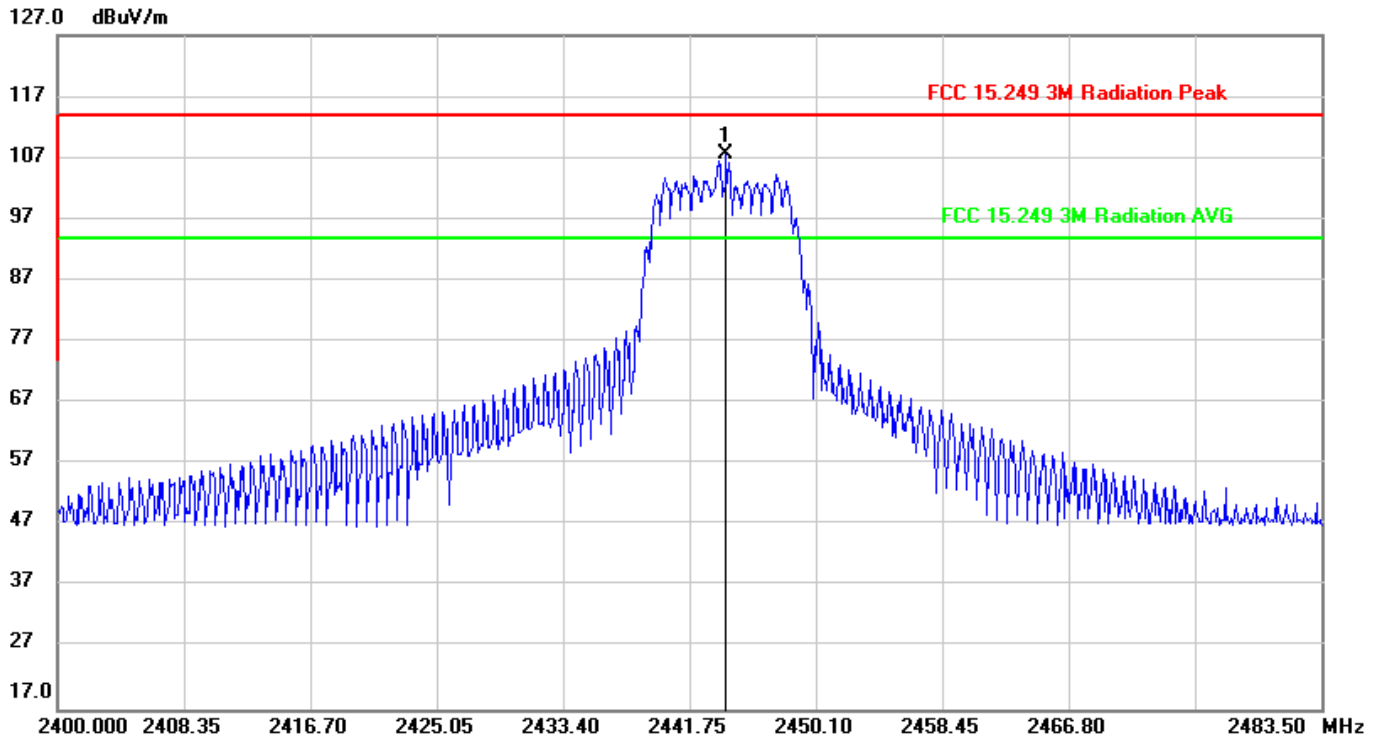

No.	Frequency (MHz)	Reading (dBuV)	Correct (dB/m)	Result (dBuV/m)	Limit (dBuV/m)	Margin (dB)	Remark
1	2444.171	74.78	32.84	107.62	114.00	-6.38	peak

- Note: 1. Measurement = Reading Level + Correct Factor.  
 2. Only the worst case emission recorded in the report, if Peak Result complies with AV limit, AV Result is deemed to comply with AV limit.  
 3. Peak: Peak detector.

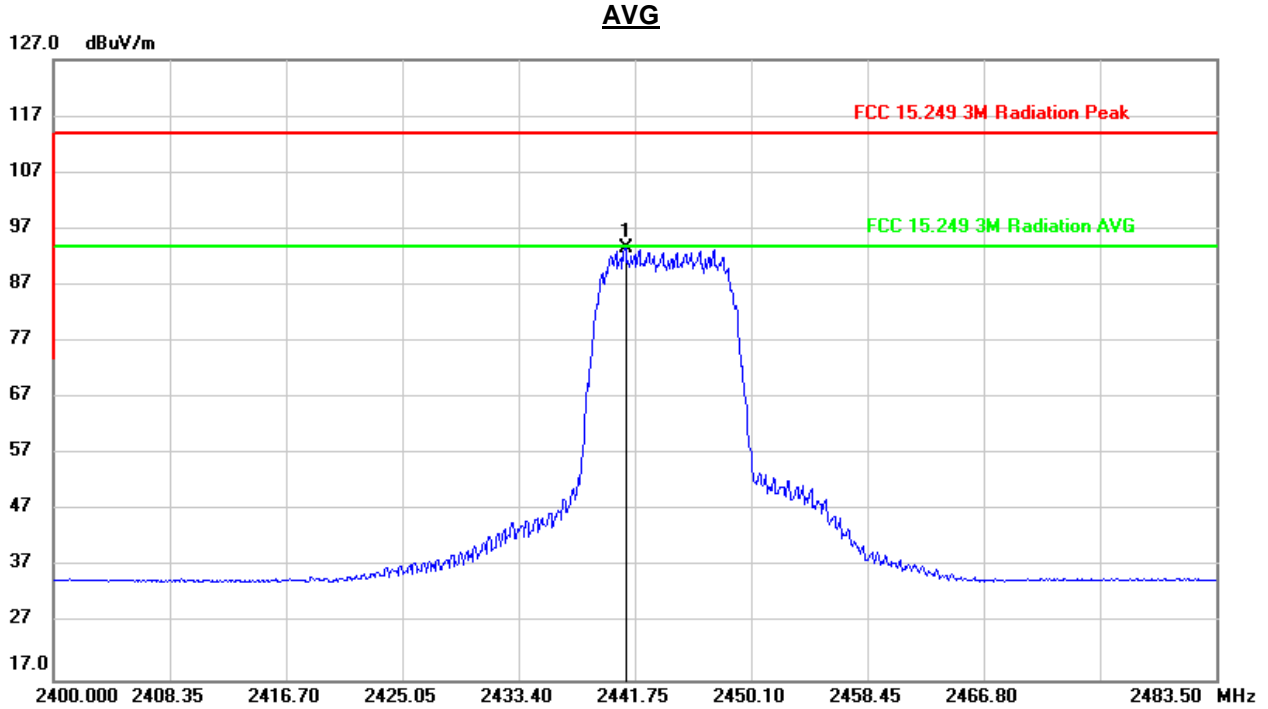

No.	Frequency (MHz)	Reading (dBuV)	Correct (dB/m)	Result (dBuV/m)	Limit (dBuV/m)	Margin (dB)	Remark
1	2441.082	60.78	32.86	93.64	94.00	-0.36	AVG

- Note:
1. Measurement = Reading Level + Correct Factor.
  2. If Peak Result complies with AV limit, AV Result is deemed to comply with AV limit.
  3. Peak: Peak detector.
  4. AVG:  $VBW=1/Ton=1K$ , where: Ton is transmit duration.
  5. For transmit duration, please refer to clause 7.1.



**FIELD STRENGTH OF INTENTIONAL EMISSIONS (MID CHANNEL, VERTICAL)**

**PEAK**

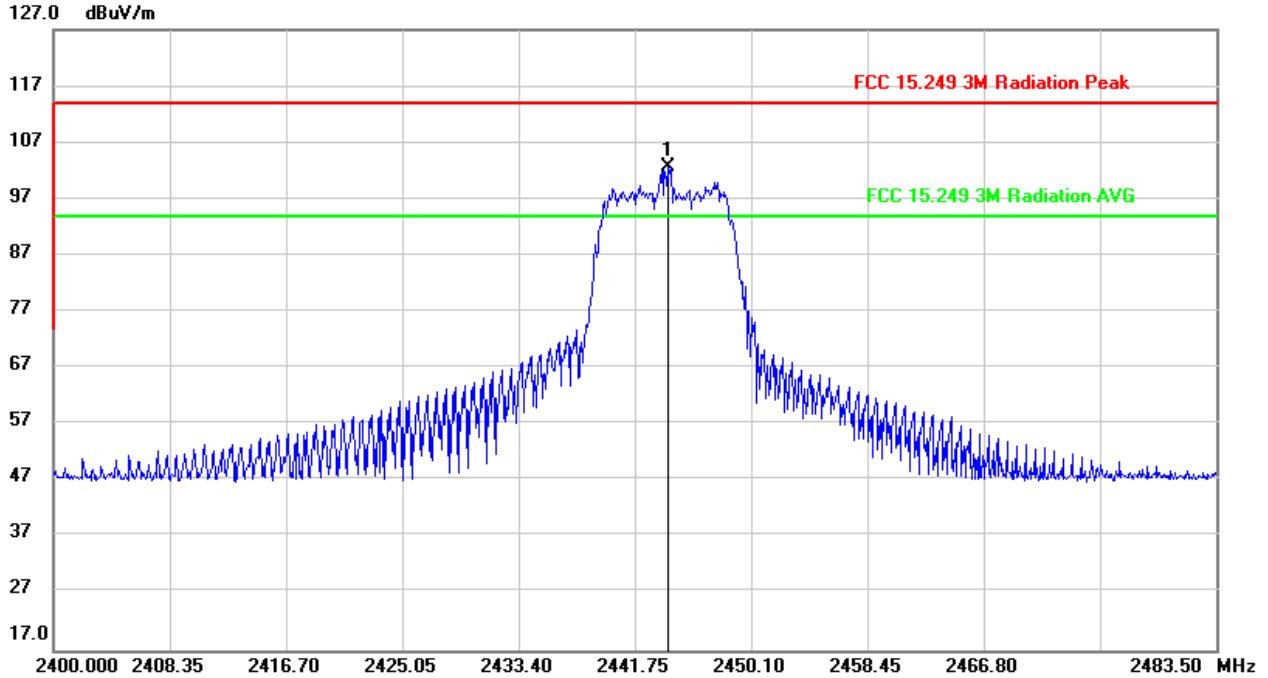

No.	Frequency (MHz)	Reading (dBuV)	Correct (dB/m)	Result (dBuV/m)	Limit (dBuV/m)	Margin (dB)	Remark
1	2444.088	69.68	32.95	102.63	114.00	-11.37	peak

- Note: 1. Measurement = Reading Level + Correct Factor.  
 2. Only the worst case emission recorded in the report, if Peak Result complies with AV limit, AV Result is deemed to comply with AV limit.  
 3. Peak: Peak detector.



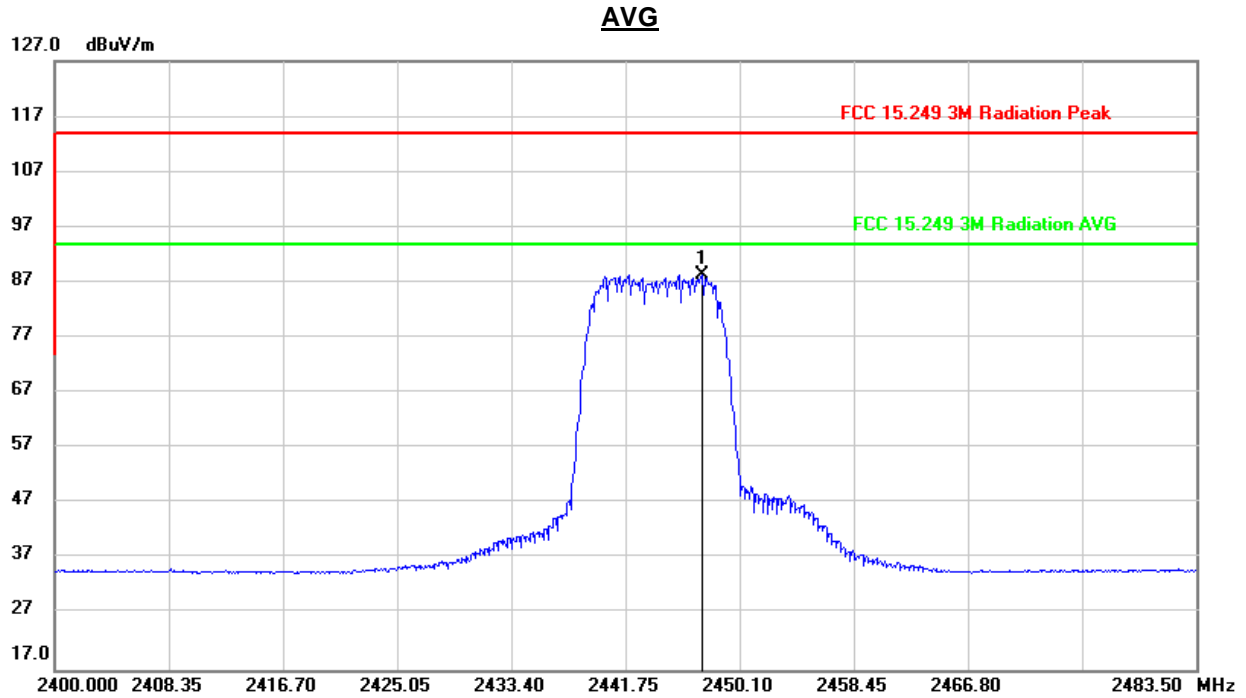

No.	Frequency (MHz)	Reading (dBuV)	Correct (dB/m)	Result (dBuV/m)	Limit (dBuV/m)	Margin (dB)	Remark
1	2447.345	55.42	32.94	88.36	94.00	-5.64	AVG

- Note:
1. Measurement = Reading Level + Correct Factor.
  2. If Peak Result complies with AV limit, AV Result is deemed to comply with AV limit.
  3. Peak: Peak detector.
  4. AVG:  $VBW=1/Ton=1K$ , where:  $Ton$  is transmit duration.
  5. For transmit duration, please refer to clause 7.1.



**RESTRICTED BANDEDGE AND FIELD STRENGTH OF INTENTIONAL EMISSIONS (HIGH CHANNEL, HORIZONTAL)**

**PEAK**

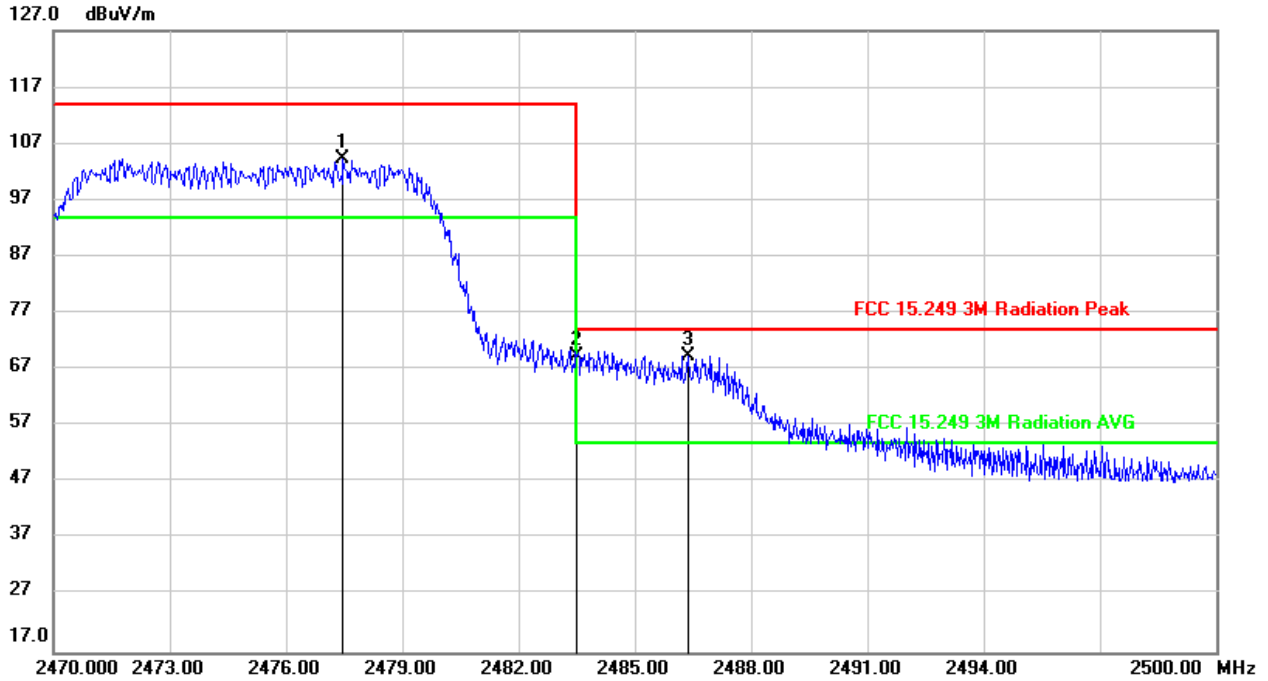

No.	Frequency (MHz)	Reading (dBuV)	Correct (dB/m)	Result (dBuV/m)	Limit (dBuV/m)	Margin (dB)	Remark
1	2477.470	71.54	32.80	104.34	114.00	-9.66	peak
2	2483.500	36.54	32.78	69.32	74.00	-4.68	peak
3	2486.380	36.73	32.79	69.52	74.00	-4.48	peak

- Note: 1. Measurement = Reading Level + Correct Factor.  
 2. Only the worst case emission recorded in the report, if Peak Result complies with AV limit, AV Result is deemed to comply with AV limit.  
 3. Peak: Peak detector.



**AVG**

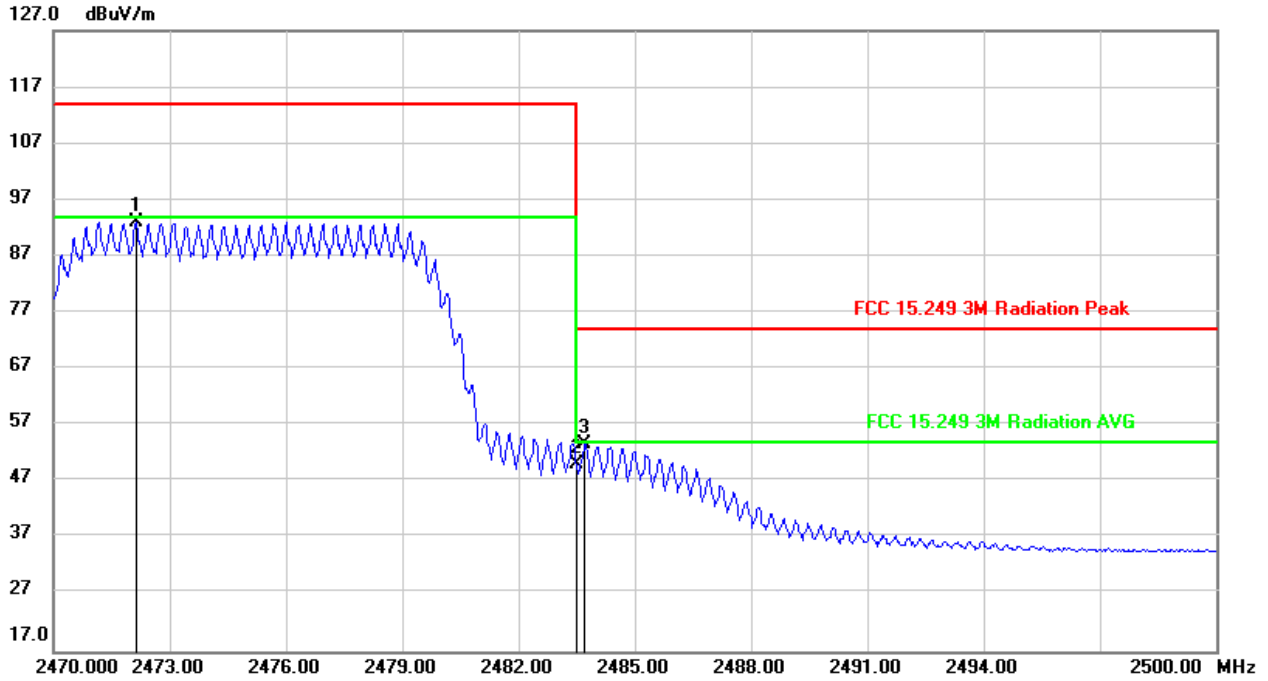

No.	Frequency (MHz)	Reading (dBuV)	Correct (dB/m)	Result (dBuV/m)	Limit (dBuV/m)	Margin (dB)	Remark
1	2472.130	60.32	32.80	93.12	94.00	-0.88	AVG
2	2483.500	17.47	32.78	50.25	54.00	-3.75	AVG
3	2483.710	21.04	32.78	53.82	54.00	-0.18	AVG

- Note:
1. Measurement = Reading Level + Correct Factor.
  2. If Peak Result complies with AV limit, AV Result is deemed to comply with AV limit.
  3. Peak: Peak detector.
  4. AVG: VBW=1/Ton=1K, where: Ton is transmit duration.
  5. For transmit duration, please refer to clause 7.1.



**RESTRICTED BANDEDGE AND FIELD STRENGTH OF INTENTIONAL EMISSIONS (HIGH CHANNEL, VERTICAL)**

**PEAK**

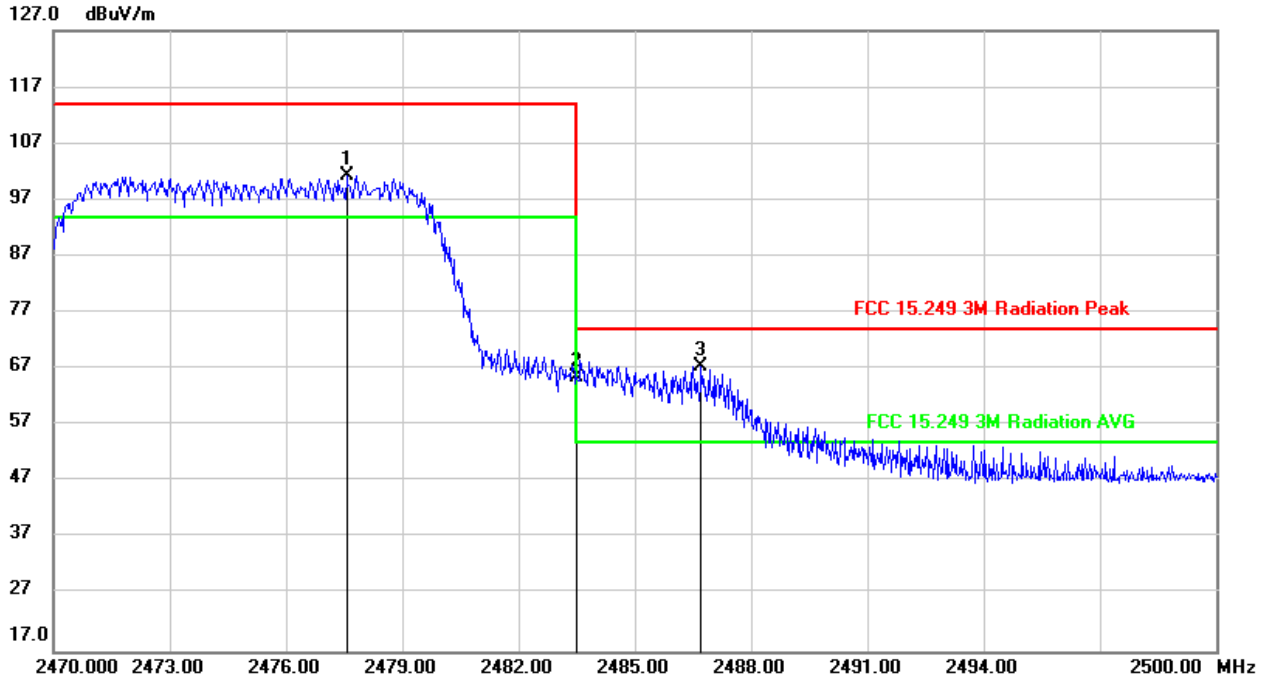

No.	Frequency (MHz)	Reading (dBuV)	Correct (dB/m)	Result (dBuV/m)	Limit (dBuV/m)	Margin (dB)	Remark
1	2477.560	68.41	32.89	101.30	114.00	-12.70	peak
2	2483.500	32.52	32.88	65.40	74.00	-8.60	peak
3	2486.710	34.63	32.89	67.52	74.00	-6.48	peak

Note: 1. Measurement = Reading Level + Correct Factor.

2. Only the worst case emission recorded in the report, if Peak Result complies with AV limit, AV Result is deemed to comply with AV limit.

3. Peak: Peak detector.

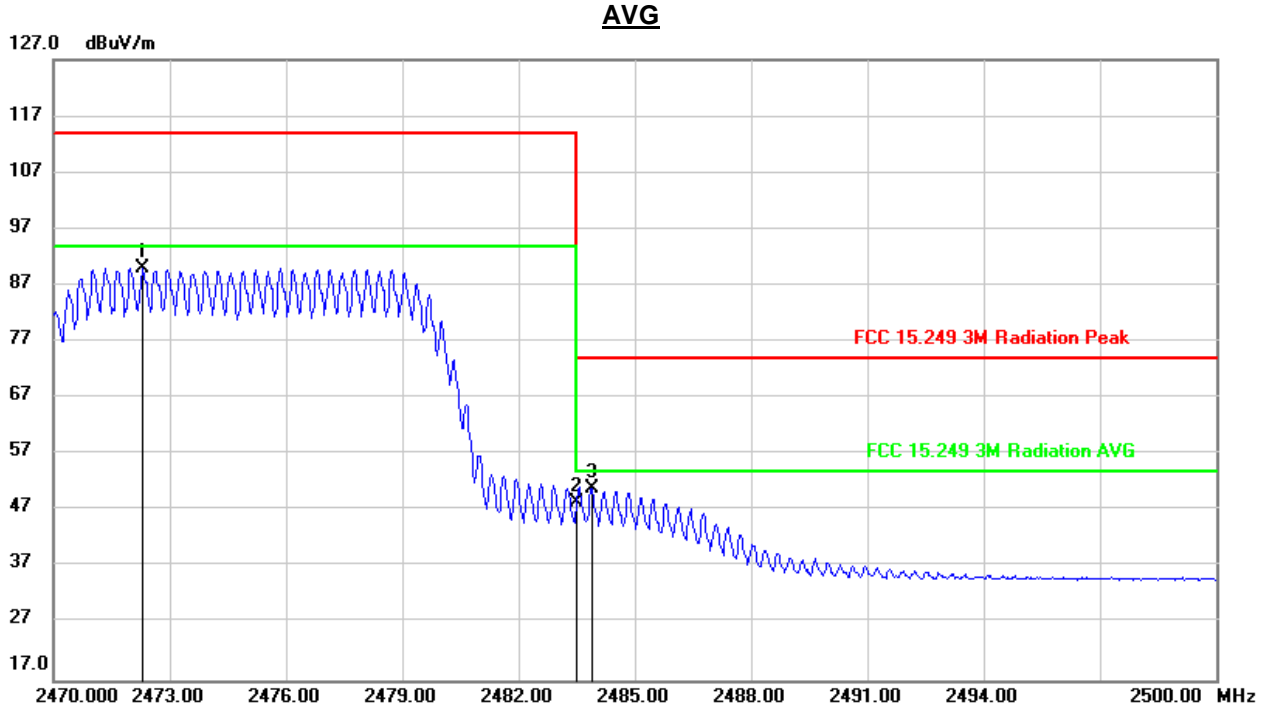

No.	Frequency (MHz)	Reading (dBuV)	Correct (dB/m)	Result (dBuV/m)	Limit (dBuV/m)	Margin (dB)	Remark
1	2472.310	57.17	32.90	90.07	94.00	-3.93	AVG
2	2483.500	15.66	32.88	48.54	54.00	-5.46	AVG
3	2483.890	18.18	32.88	51.06	54.00	-2.94	AVG

- Note: 1. Measurement = Reading Level + Correct Factor.  
 2. If Peak Result complies with AV limit, AV Result is deemed to comply with AV limit.  
 3. Peak: Peak detector.  
 4. AVG:  $VBW=1/Ton=1K$ , where: Ton is transmit duration.  
 5. For transmit duration, please refer to clause 7.1.



QPSK 20MHz Bandwidth Mode

**RESTRICTED BANDEDGE AND FIELD STRENGTH OF INTENTIONAL EMISSIONS (LOW CHANNEL, HORIZONTAL)**

**PEAK**

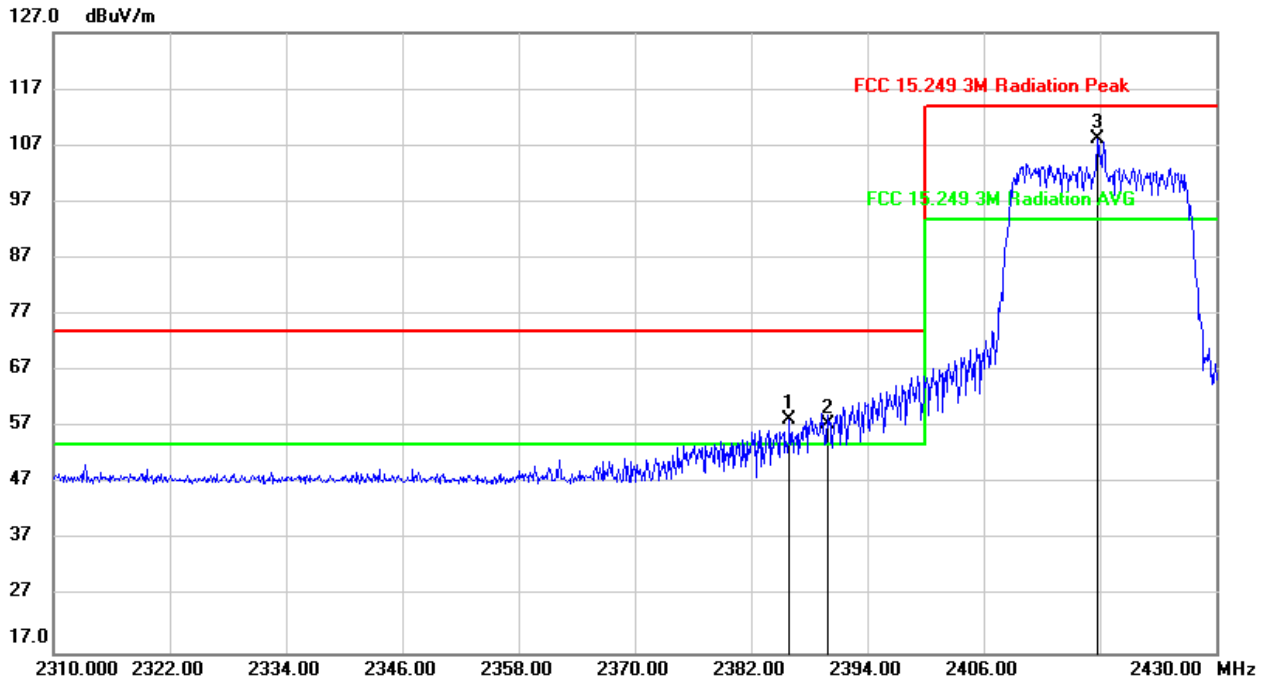

No.	Frequency (MHz)	Reading (dBuV)	Correct (dB/m)	Result (dBuV/m)	Limit (dBuV/m)	Margin (dB)	Remark
1	2385.960	25.10	33.17	58.27	74.00	-15.73	peak
2	2390.000	24.45	33.14	57.59	74.00	-16.41	peak
3	2417.760	75.22	32.98	108.20	114.00	-5.80	peak

Note: 1. Measurement = Reading Level + Correct Factor.

2. Only the worst case emission recorded in the report, if Peak Result complies with AV limit, AV Result is deemed to comply with AV limit.

3. Peak: Peak detector.



**AVG**

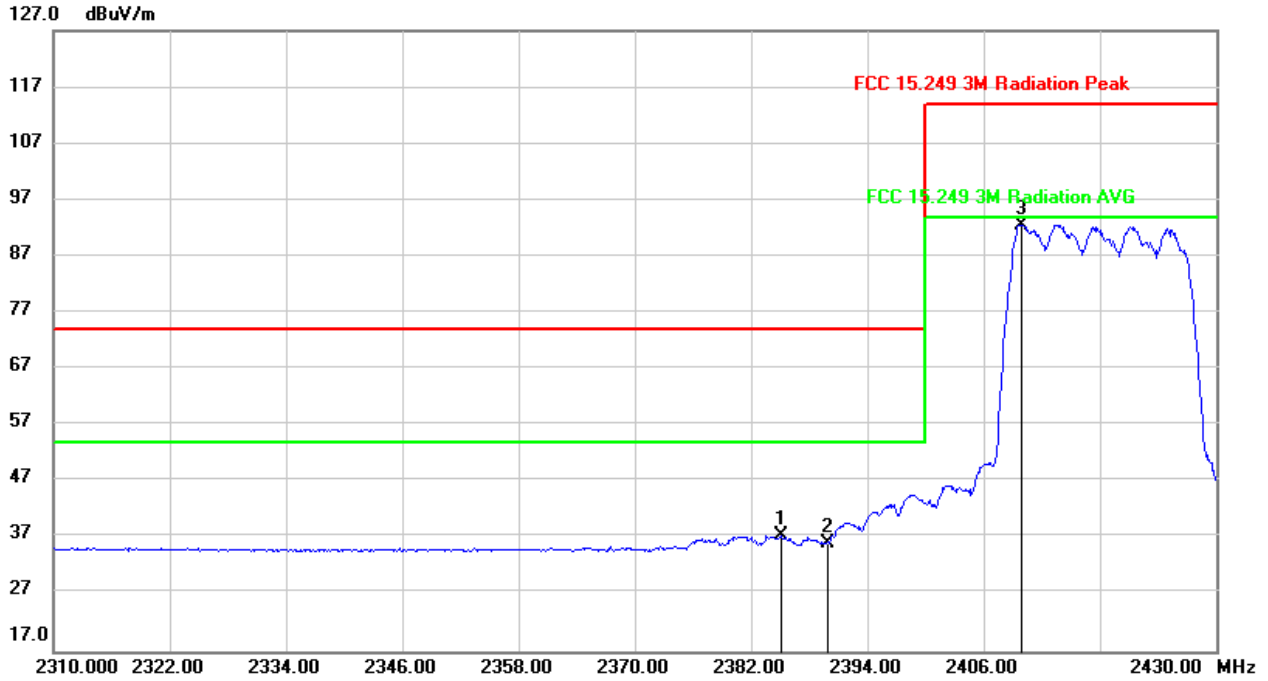

No.	Frequency (MHz)	Reading (dBuV)	Correct (dB/m)	Result (dBuV/m)	Limit (dBuV/m)	Margin (dB)	Remark
1	2385.120	4.19	33.18	37.37	54.00	-16.63	AVG
2	2390.000	2.96	33.14	36.10	54.00	-17.90	AVG
3	2409.840	59.60	33.02	92.62	94.00	-1.38	AVG

- Note:
1. Measurement = Reading Level + Correct Factor.
  2. If Peak Result complies with AV limit, AV Result is deemed to comply with AV limit.
  3. Peak: Peak detector.
  4. AVG: VBW=1/Ton=1K, where: Ton is transmit duration.
  5. For transmit duration, please refer to clause 7.1.



**RESTRICTED BANDEDGE AND FIELD STRENGTH OF INTENTIONAL EMISSIONS (LOW CHANNEL, VERTICAL)**

**PEAK**

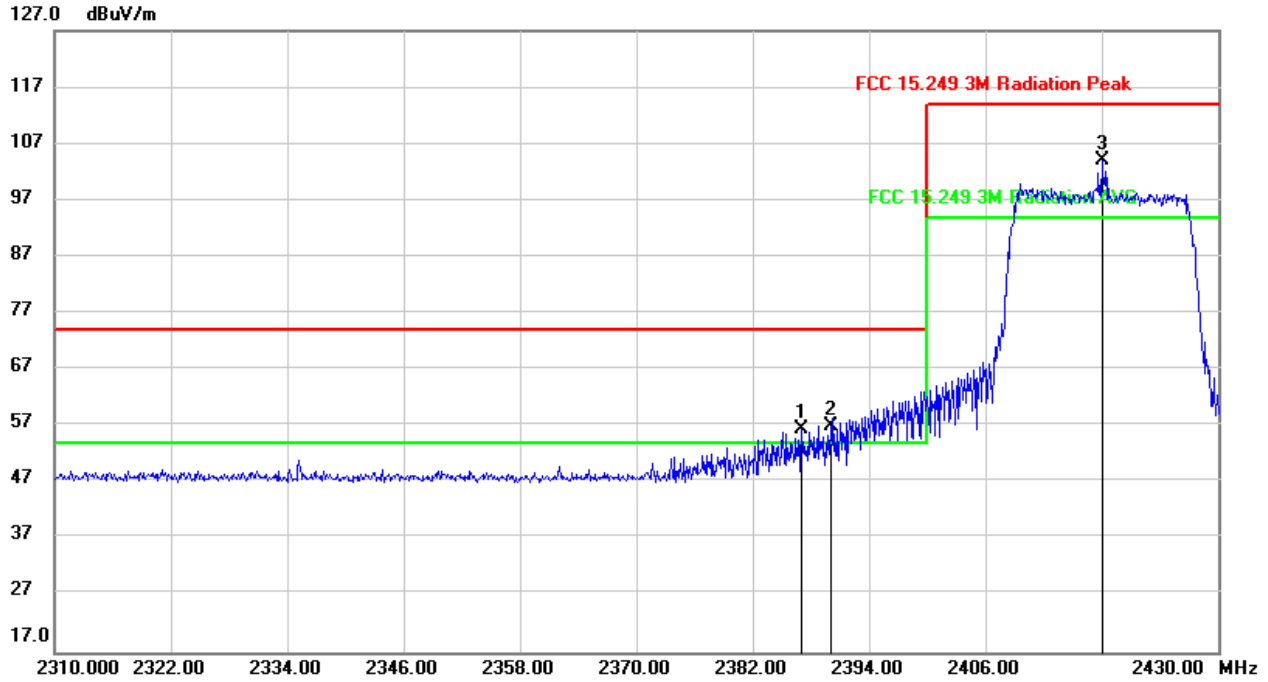

No.	Frequency (MHz)	Reading (dBuV)	Correct (dB/m)	Result (dBuV/m)	Limit (dBuV/m)	Margin (dB)	Remark
1	2387.040	23.14	33.26	56.40	74.00	-17.60	peak
2	2390.000	23.79	33.24	57.03	74.00	-16.97	peak
3	2418.000	71.03	33.08	104.11	114.00	-9.89	peak

- Note: 1. Measurement = Reading Level + Correct Factor.  
 2. Only the worst case emission recorded in the report, if Peak Result complies with AV limit, AV Result is deemed to comply with AV limit.  
 3. Peak: Peak detector.



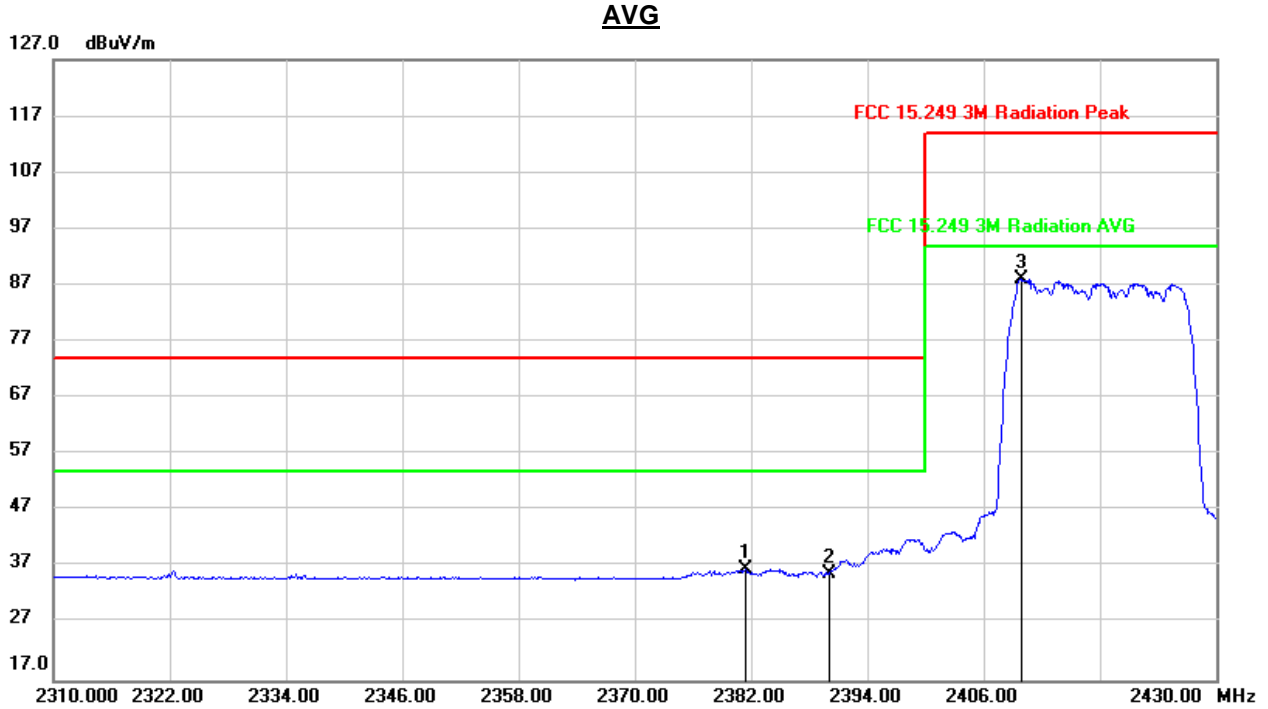

No.	Frequency (MHz)	Reading (dBuV)	Correct (dB/m)	Result (dBuV/m)	Limit (dBuV/m)	Margin (dB)	Remark
1	2381.400	3.39	33.31	36.70	54.00	-17.30	AVG
2	2390.000	2.67	33.24	35.91	54.00	-18.09	AVG
3	2409.840	54.95	33.12	88.07	94.00	-5.93	AVG

- Note:
1. Measurement = Reading Level + Correct Factor.
  2. If Peak Result complies with AV limit, AV Result is deemed to comply with AV limit.
  3. Peak: Peak detector.
  4. AVG:  $VBW=1/Ton=1K$ , where: Ton is transmit duration.
  5. For transmit duration, please refer to clause 7.1.



**FIELD STRENGTH OF INTENTIONAL EMISSIONS (MID CHANNEL, HORIZONTAL)**

**PEAK**

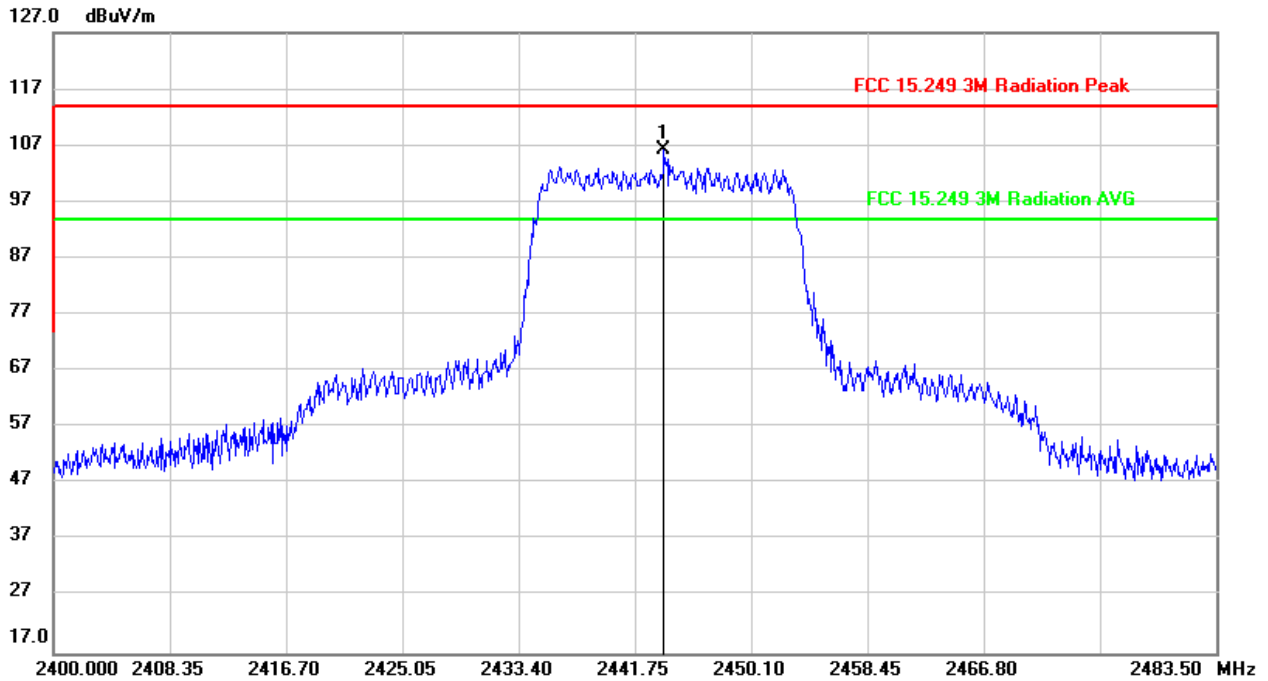

No.	Frequency (MHz)	Reading (dBuV)	Correct (dB/m)	Result (dBuV/m)	Limit (dBuV/m)	Margin (dB)	Remark
1	2443.838	73.26	32.85	106.11	114.00	-7.89	peak

- Note: 1. Measurement = Reading Level + Correct Factor.  
 2. Only the worst case emission recorded in the report, if Peak Result complies with AV limit, AV Result is deemed to comply with AV limit.  
 3. Peak: Peak detector.



**AVG**

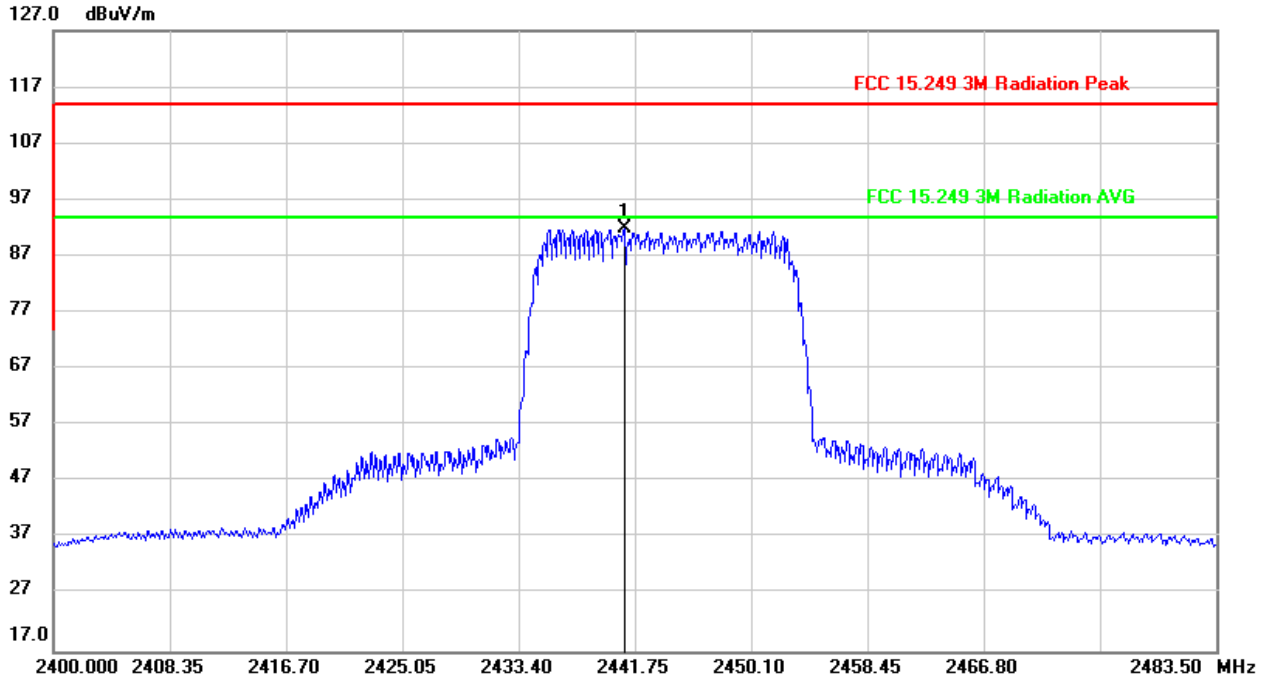

No.	Frequency (MHz)	Reading (dBuV)	Correct (dB/m)	Result (dBuV/m)	Limit (dBuV/m)	Margin (dB)	Remark
1	2440.999	58.97	32.86	91.83	94.00	-2.17	AVG

- Note:
1. Measurement = Reading Level + Correct Factor.
  2. If Peak Result complies with AV limit, AV Result is deemed to comply with AV limit.
  3. Peak: Peak detector.
  4. AVG:  $VBW=1/Ton=1K$ , where: Ton is transmit duration.
  5. For transmit duration, please refer to clause 7.1.



**FIELD STRENGTH OF INTENTIONAL EMISSIONS (MID CHANNEL, VERTICAL)**

**PEAK**

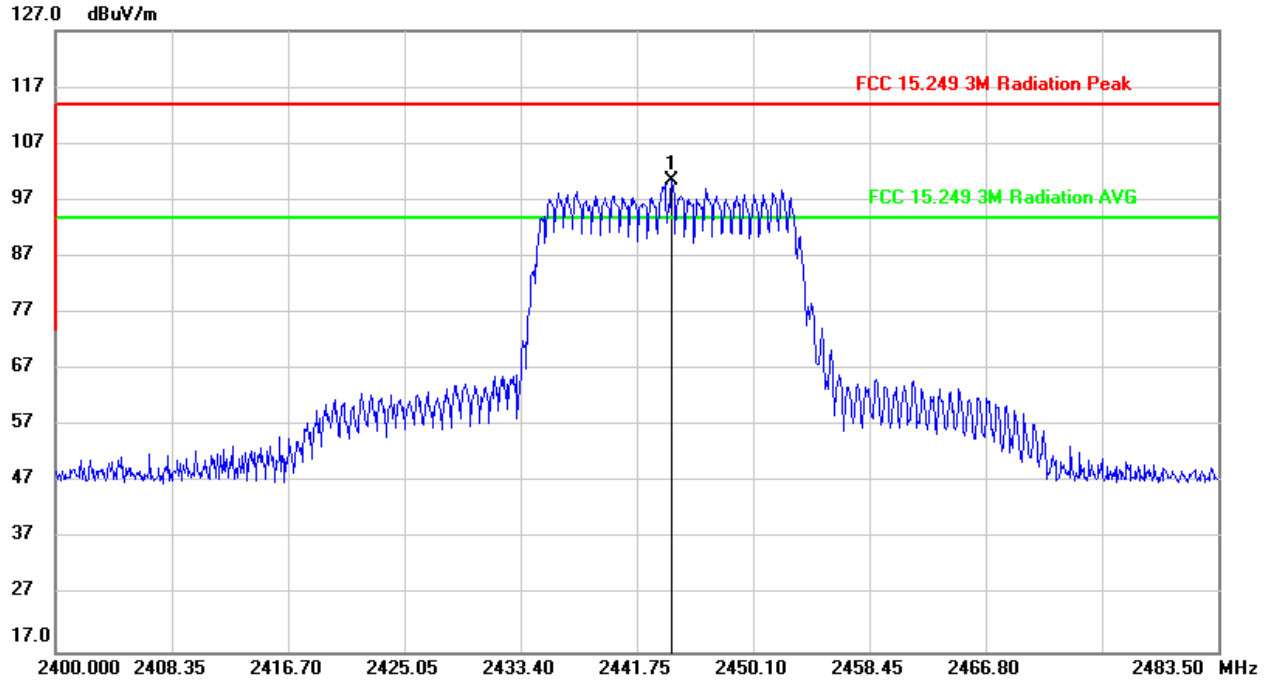

No.	Frequency (MHz)	Reading (dBuV)	Correct (dB/m)	Result (dBuV/m)	Limit (dBuV/m)	Margin (dB)	Remark
1	2444.255	67.44	32.94	100.38	114.00	-13.62	peak

- Note:
1. Measurement = Reading Level + Correct Factor.
  2. If Peak Result complies with AV limit, AV Result is deemed to comply with AV limit.
  3. Peak: Peak detector.

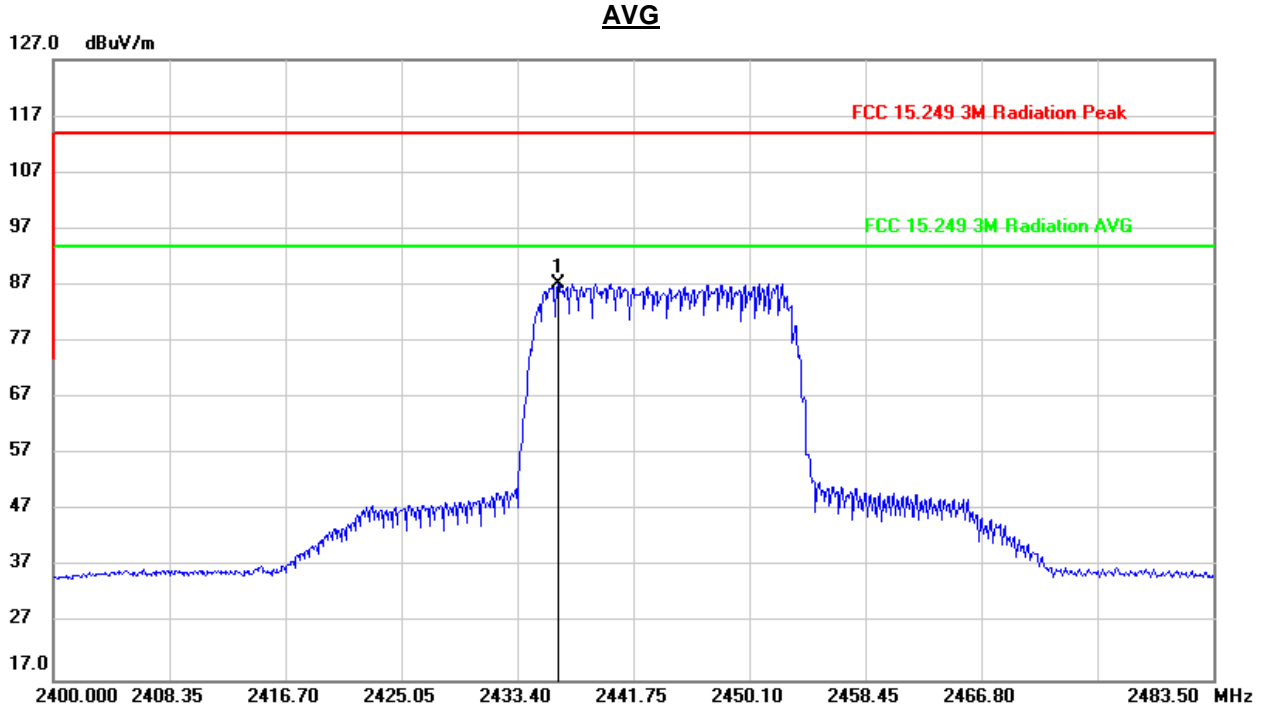

No.	Frequency (MHz)	Reading (dBuV)	Correct (dB/m)	Result (dBuV/m)	Limit (dBuV/m)	Margin (dB)	Remark
1	2436.323	54.38	32.99	87.37	94.00	-6.63	AVG

- Note:
1. Measurement = Reading Level + Correct Factor.
  2. If Peak Result complies with AV limit, AV Result is deemed to comply with AV limit.
  3. Peak: Peak detector.
  4. AVG:  $VBW=1/Ton=1K$ , where: Ton is transmit duration.
  5. For transmit duration, please refer to clause 7.1.



**RESTRICTED BANDEDGE AND FIELD STRENGTH OF INTENTIONAL EMISSIONS (HIGH CHANNEL, HORIZONTAL)**

**PEAK**

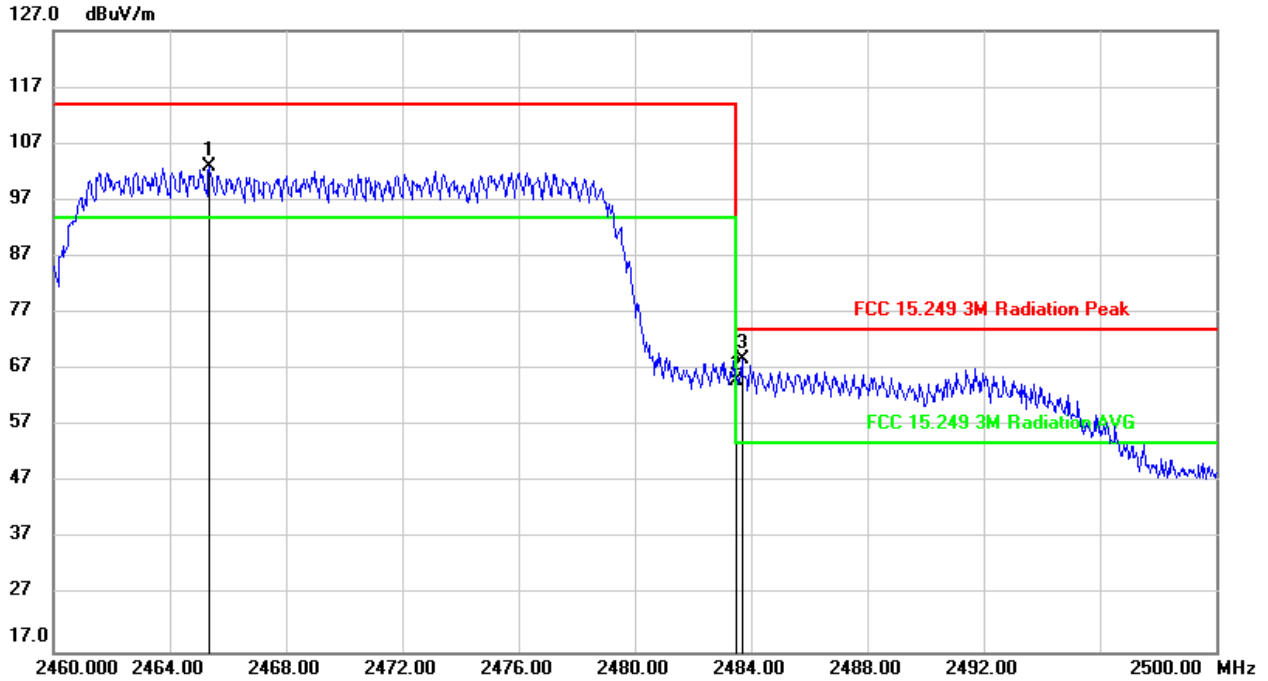

No.	Frequency (MHz)	Reading (dBuV)	Correct (dB/m)	Result (dBuV/m)	Limit (dBuV/m)	Margin (dB)	Remark
1	2465.360	70.01	32.81	102.82	114.00	-11.18	peak
2	2483.500	32.29	32.78	65.07	74.00	-8.93	peak
3	2483.680	35.95	32.78	68.73	74.00	-5.27	peak

- Note: 1. Measurement = Reading Level + Correct Factor.  
 2. If Peak Result complies with AV limit, AV Result is deemed to comply with AV limit.  
 3. Peak: Peak detector.

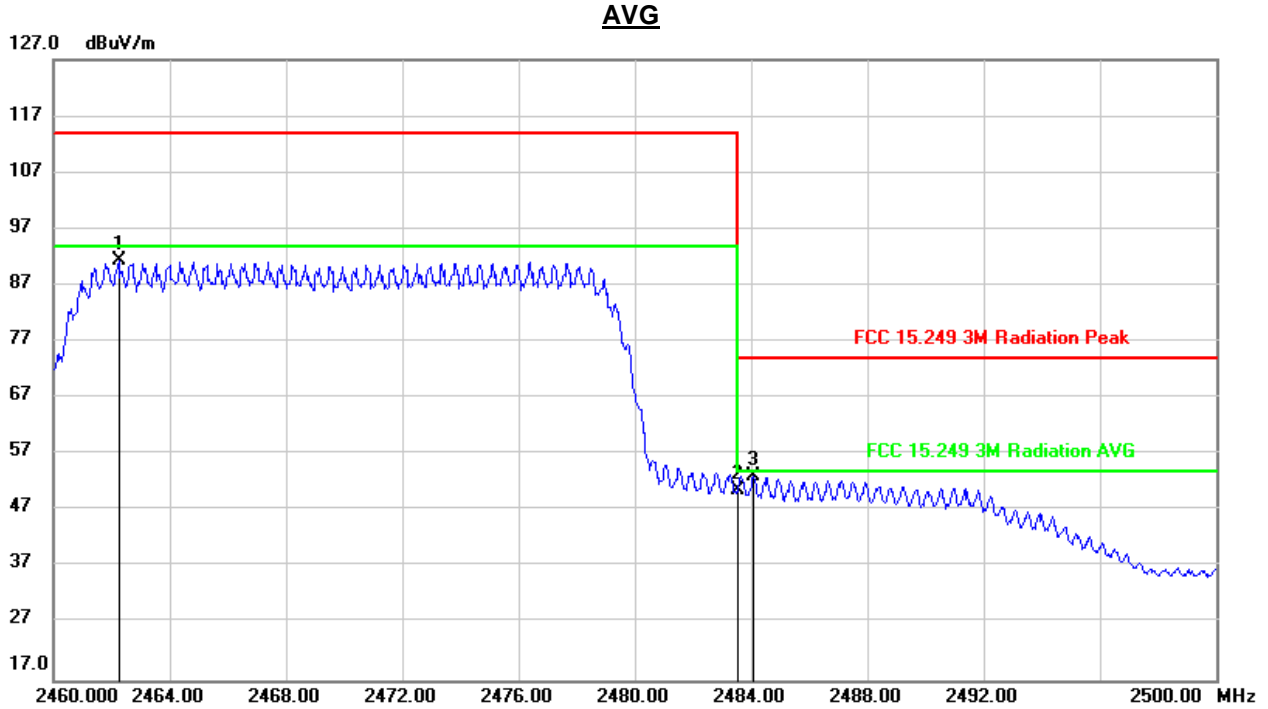

No.	Frequency (MHz)	Reading (dBuV)	Correct (dB/m)	Result (dBuV/m)	Limit (dBuV/m)	Margin (dB)	Remark
1	2462.240	58.47	32.81	91.28	94.00	-2.72	AVG
2	2483.500	17.92	32.78	50.70	54.00	-3.30	AVG
3	2484.080	20.38	32.78	53.16	54.00	-0.84	AVG

- Note:
1. Measurement = Reading Level + Correct Factor.
  2. If Peak Result complies with AV limit, AV Result is deemed to comply with AV limit.
  3. Peak: Peak detector.
  4. AVG:  $VBW=1/Ton=1K$ , where: Ton is transmit duration.
  5. For transmit duration, please refer to clause 7.1.



**RESTRICTED BANDEDGE AND FIELD STRENGTH OF INTENTIONAL EMISSIONS (HIGH CHANNEL, VERTICAL)**

**PEAK**

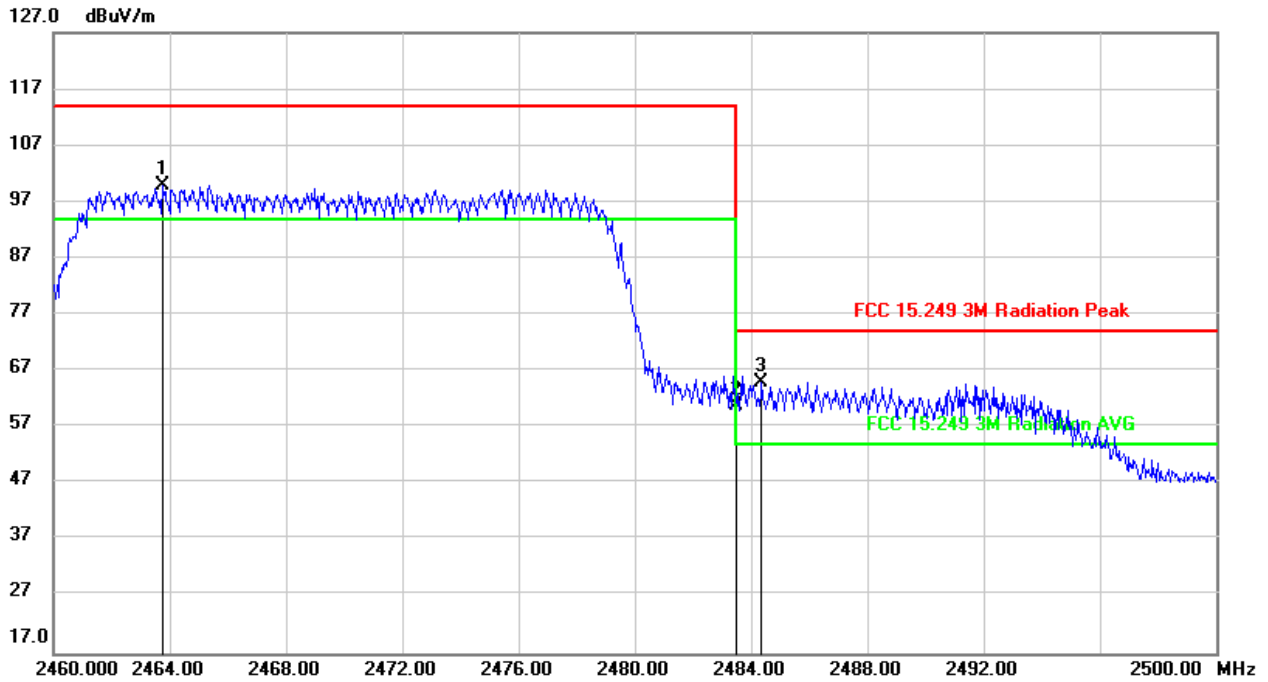

No.	Frequency (MHz)	Reading (dBuV)	Correct (dB/m)	Result (dBuV/m)	Limit (dBuV/m)	Margin (dB)	Remark
1	2463.760	67.05	32.90	99.95	114.00	-14.05	peak
2	2483.500	28.10	32.88	60.98	74.00	-13.02	peak
3	2484.360	31.99	32.88	64.87	74.00	-9.13	peak

- Note: 1. Measurement = Reading Level + Correct Factor.  
 2. If Peak Result complies with AV limit, AV Result is deemed to comply with AV limit.  
 3. Peak: Peak detector.



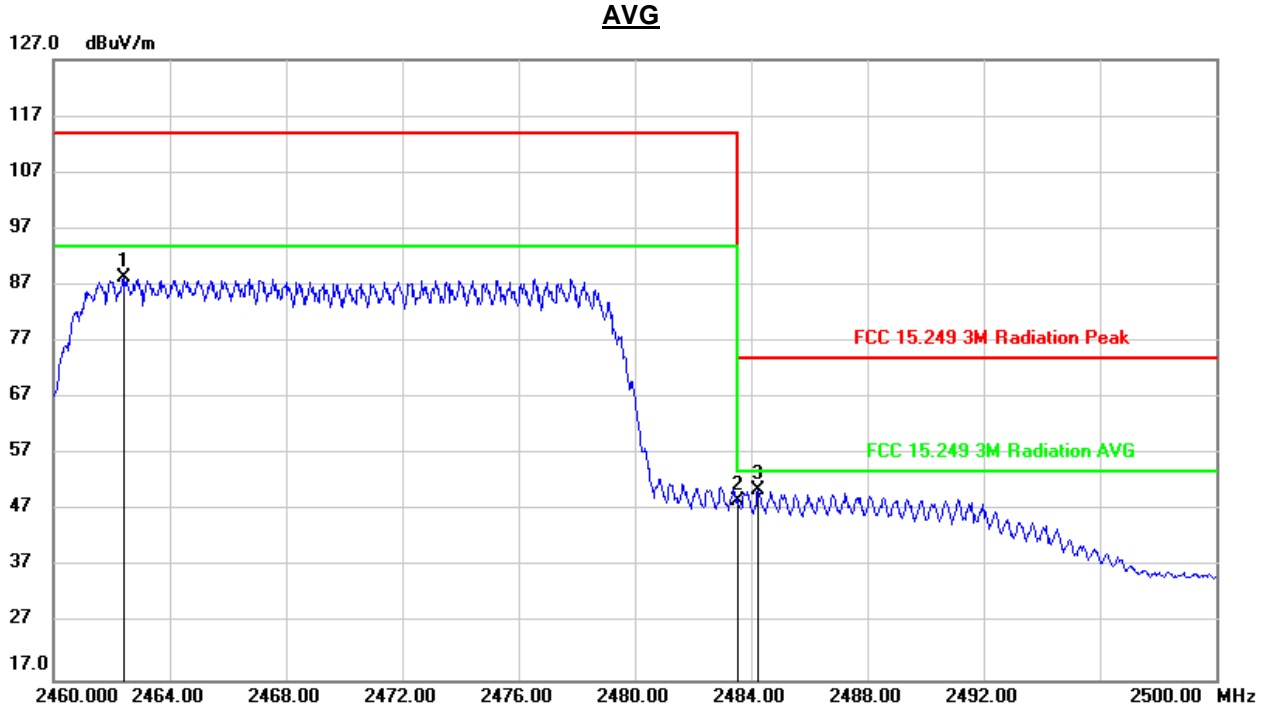

No.	Frequency (MHz)	Reading (dBuV)	Correct (dB/m)	Result (dBuV/m)	Limit (dBuV/m)	Margin (dB)	Remark
1	2462.400	55.35	32.91	88.26	94.00	-5.74	AVG
2	2483.500	16.02	32.88	48.90	54.00	-5.10	AVG
3	2484.240	17.68	32.88	50.56	54.00	-3.44	AVG

- Note:
1. Measurement = Reading Level + Correct Factor.
  2. If Peak Result complies with AV limit, AV Result is deemed to comply with AV limit.
  3. Peak: Peak detector.
  4. AVG: VBW=1/Ton=1K, where: Ton is transmit duration.
  5. For transmit duration, please refer to clause 7.1.



OFDM 20MHz Bandwidth Mode

**RESTRICTED BANDEDGE AND FIELD STRENGTH OF INTENTIONAL EMISSIONS (LOW CHANNEL, HORIZONTAL)**

**PEAK**

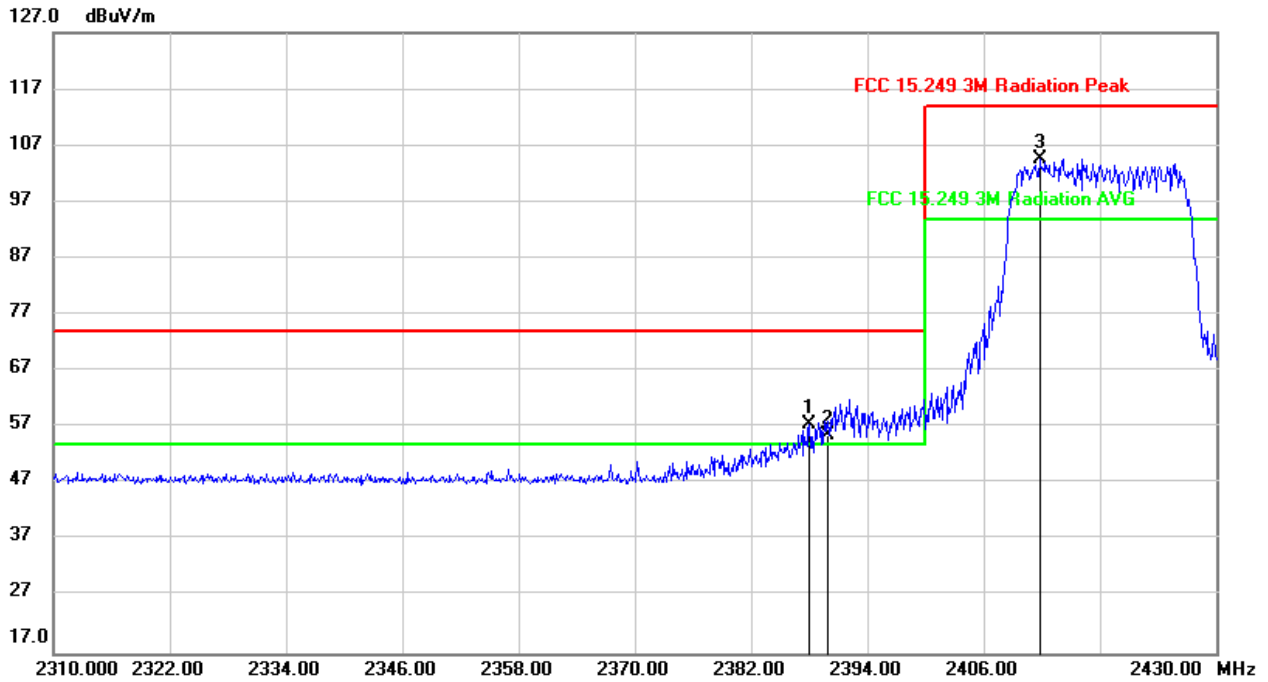

No.	Frequency (MHz)	Reading (dBuV)	Correct (dB/m)	Result (dBuV/m)	Limit (dBuV/m)	Margin (dB)	Remark
1	2388.000	24.46	33.16	57.62	74.00	-16.38	peak
2	2390.000	22.59	33.14	55.73	74.00	-18.27	peak
3	2411.760	71.65	33.01	104.66	114.00	-9.34	peak

Note: 1. Measurement = Reading Level + Correct Factor.  
 2. If Peak Result complies with AV limit, AV Result is deemed to comply with AV limit.  
 3. Peak: Peak detector.

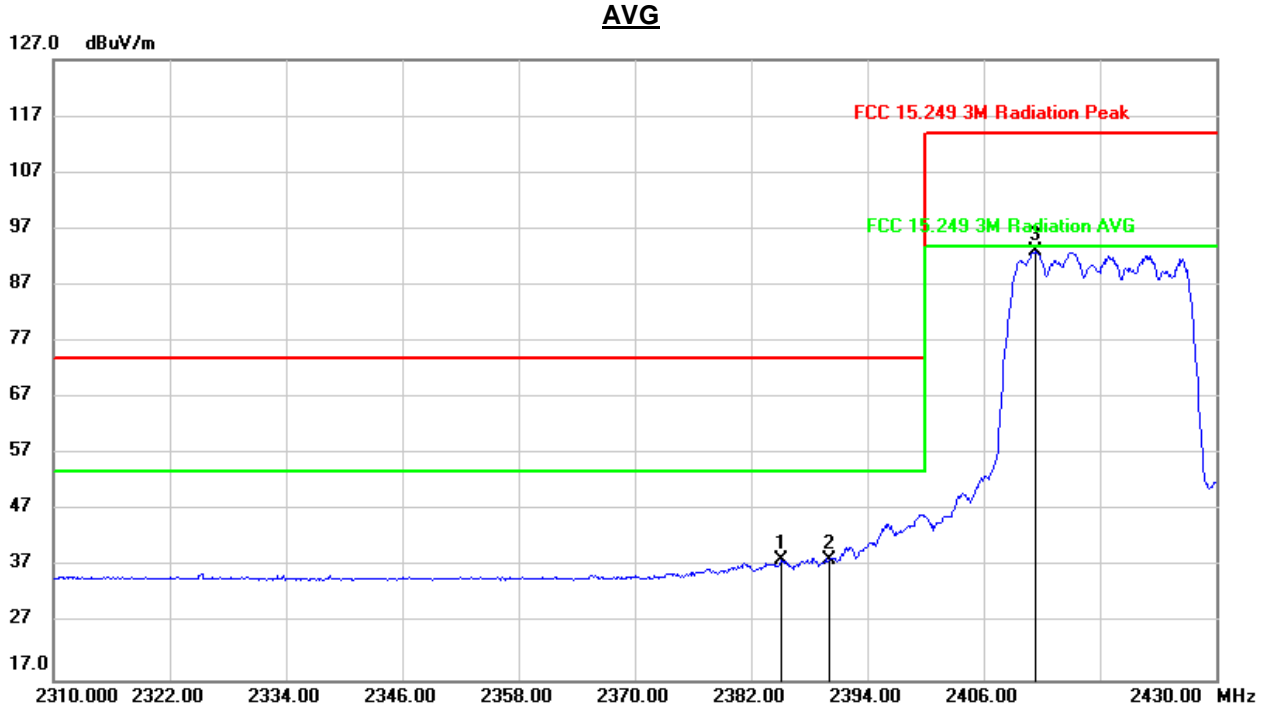

No.	Frequency (MHz)	Reading (dBuV)	Correct (dB/m)	Result (dBuV/m)	Limit (dBuV/m)	Margin (dB)	Remark
1	2385.120	5.05	33.18	38.23	54.00	-15.77	AVG
2	2390.000	5.16	33.14	38.30	54.00	-15.70	AVG
3	2411.280	59.92	33.01	92.93	94.00	-1.07	AVG

- Note:
1. Measurement = Reading Level + Correct Factor.
  2. If Peak Result complies with AV limit, AV Result is deemed to comply with AV limit.
  3. Peak: Peak detector.
  4. AVG:  $VBW=1/Ton=1K$ , where: Ton is transmit duration.
  5. For transmit duration, please refer to clause 7.1.



**RESTRICTED BANDEDGE AND FIELD STRENGTH OF INTENTIONAL EMISSIONS (LOW CHANNEL, VERTICAL)**

**PEAK**

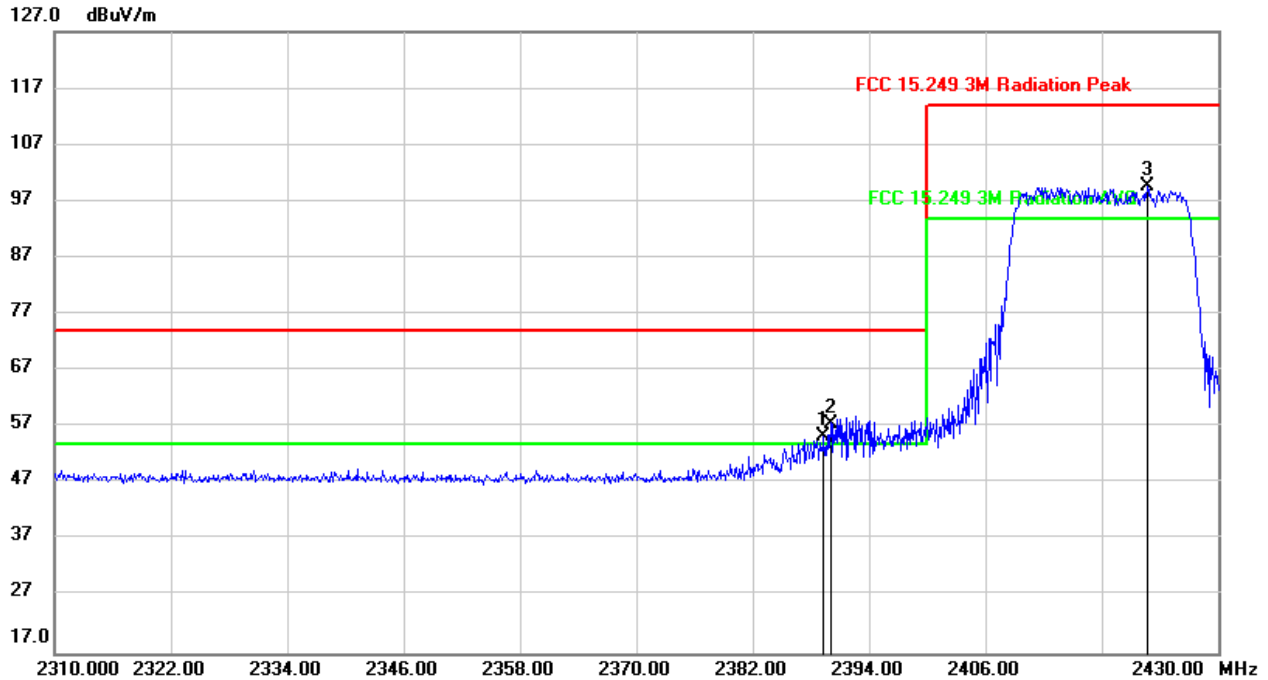

No.	Frequency (MHz)	Reading (dBuV)	Correct (dB/m)	Result (dBuV/m)	Limit (dBuV/m)	Margin (dB)	Remark
1	2389.320	22.12	33.25	55.37	74.00	-18.63	peak
2	2390.000	24.46	33.24	57.70	74.00	-16.30	peak
3	2422.680	66.50	33.05	99.55	114.00	-14.45	peak

Note: 1. Measurement = Reading Level + Correct Factor.  
2. If Peak Result complies with AV limit, AV Result is deemed to comply with AV limit.  
3. Peak: Peak detector.

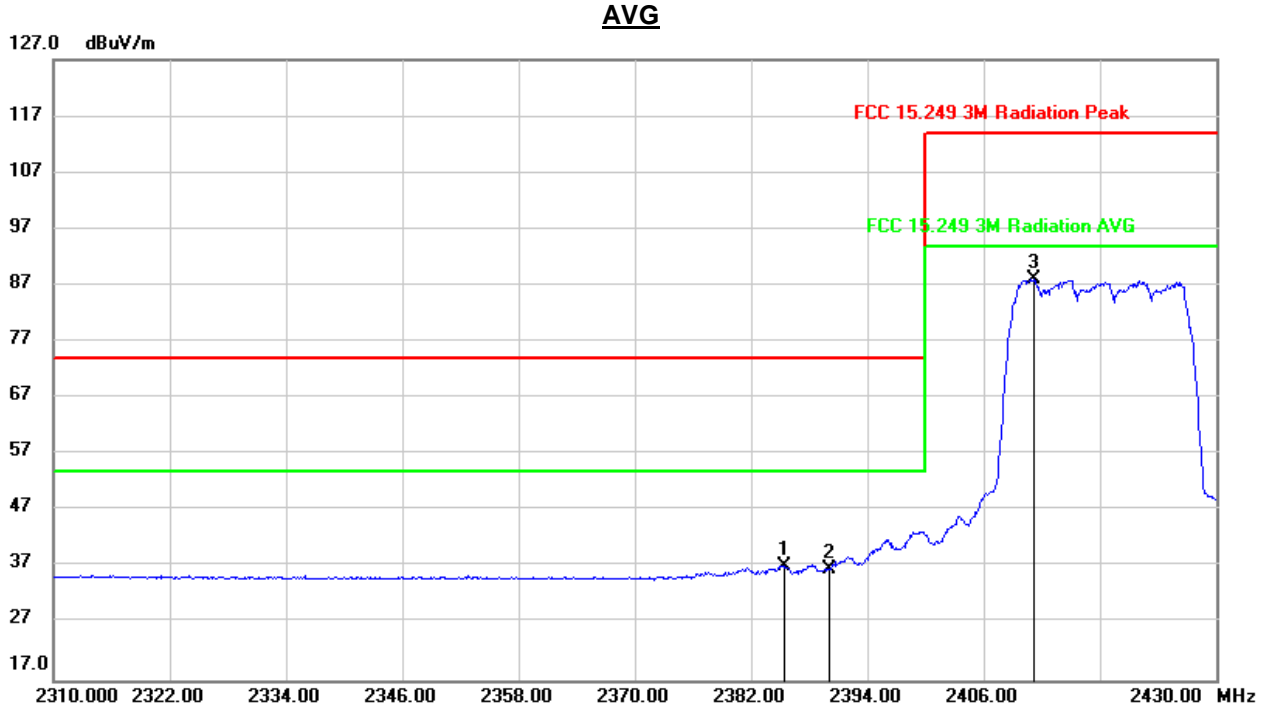

No.	Frequency (MHz)	Reading (dBuV)	Correct (dB/m)	Result (dBuV/m)	Limit (dBuV/m)	Margin (dB)	Remark
1	2385.360	3.95	33.28	37.23	54.00	-16.77	AVG
2	2390.000	3.39	33.24	36.63	54.00	-17.37	AVG
3	2411.160	55.07	33.11	88.18	94.00	-5.82	AVG

- Note:
1. Measurement = Reading Level + Correct Factor.
  2. If Peak Result complies with AV limit, AV Result is deemed to comply with AV limit.
  3. Peak: Peak detector.
  4. AVG:  $VBW=1/Ton=1K$ , where: Ton is transmit duration.
  5. For transmit duration, please refer to clause 7.1.



**FIELD STRENGTH OF INTENTIONAL EMISSIONS (MID CHANNEL, HORIZONTAL)**

**PEAK**

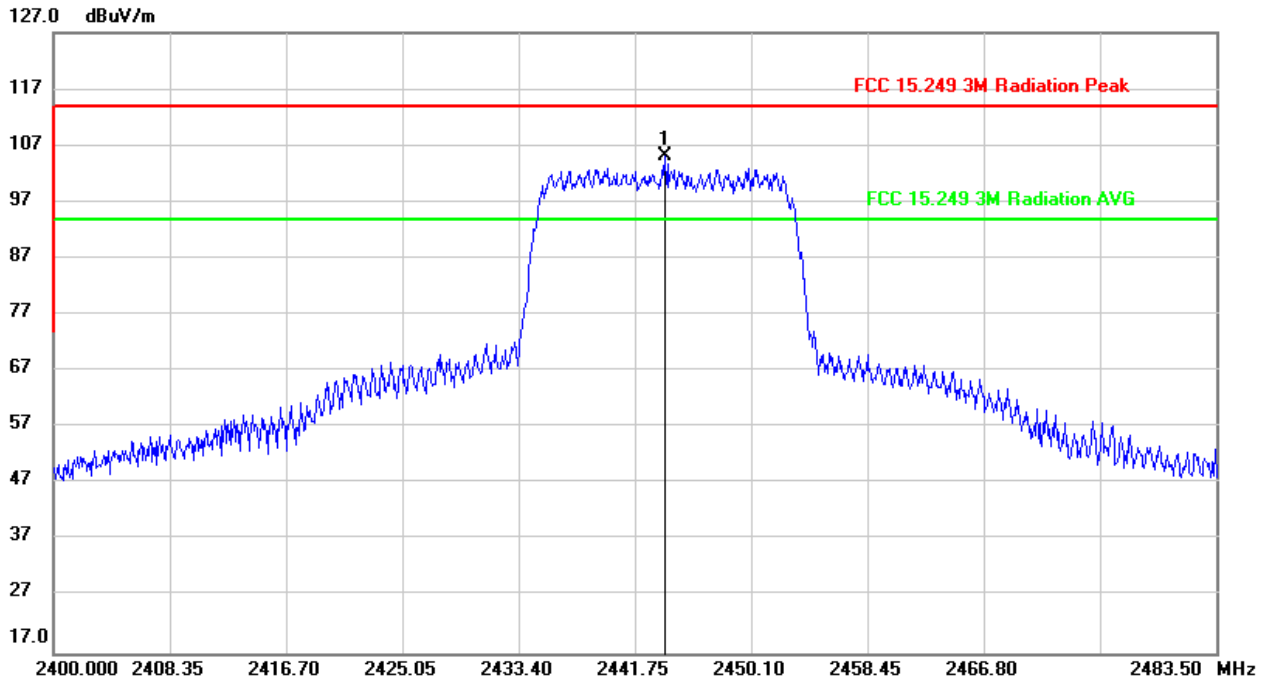

No.	Frequency (MHz)	Reading (dBuV)	Correct (dB/m)	Result (dBuV/m)	Limit (dBuV/m)	Margin (dB)	Remark
1	2443.921	72.28	32.85	105.13	114.00	-8.87	peak

- Note: 1. Measurement = Reading Level + Correct Factor.  
 2. If Peak Result complies with AV limit, AV Result is deemed to comply with AV limit.  
 3. Peak: Peak detector.

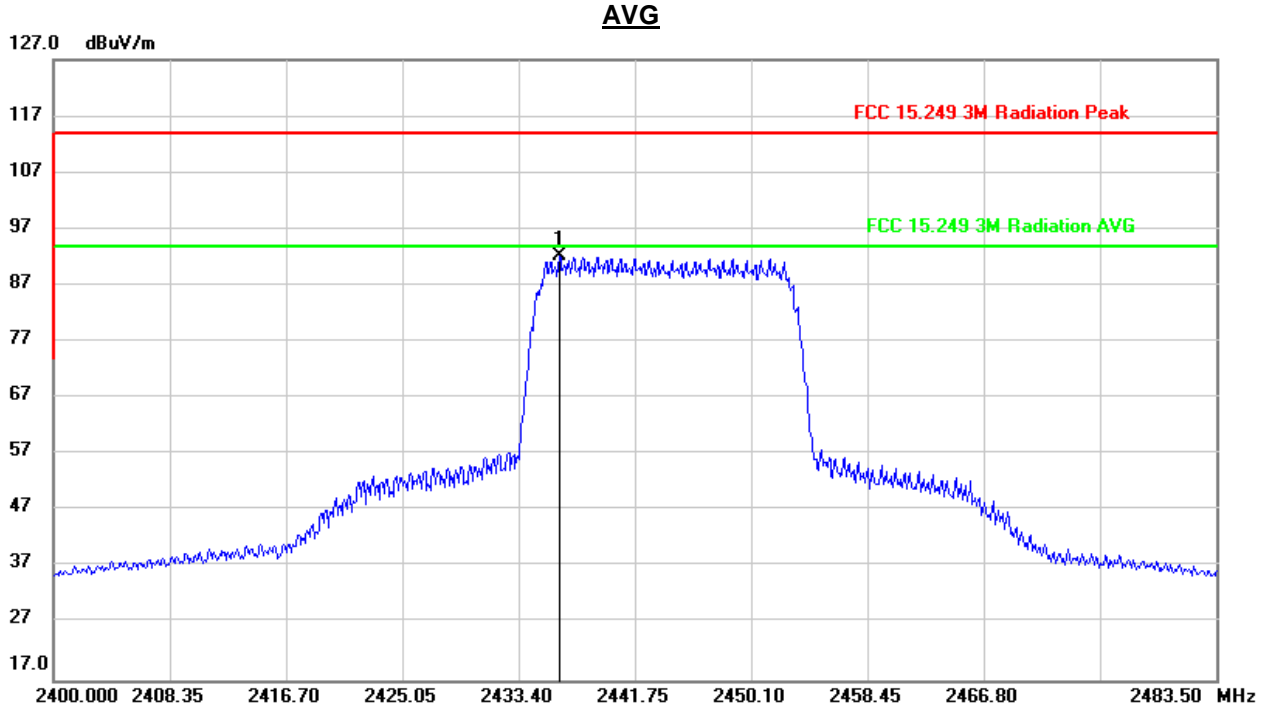

No.	Frequency (MHz)	Reading (dBuV)	Correct (dB/m)	Result (dBuV/m)	Limit (dBuV/m)	Margin (dB)	Remark
1	2436.323	59.23	32.89	92.12	94.00	-1.88	AVG

- Note:
1. Measurement = Reading Level + Correct Factor.
  2. If Peak Result complies with AV limit, AV Result is deemed to comply with AV limit.
  3. Peak: Peak detector.
  4. AVG:  $VBW=1/T_{on}=1K$ , where:  $T_{on}$  is transmit duration.
  5. For transmit duration, please refer to clause 7.1.



**FIELD STRENGTH OF INTENTIONAL EMISSIONS (MID CHANNEL, VERTICAL)**

**PEAK**

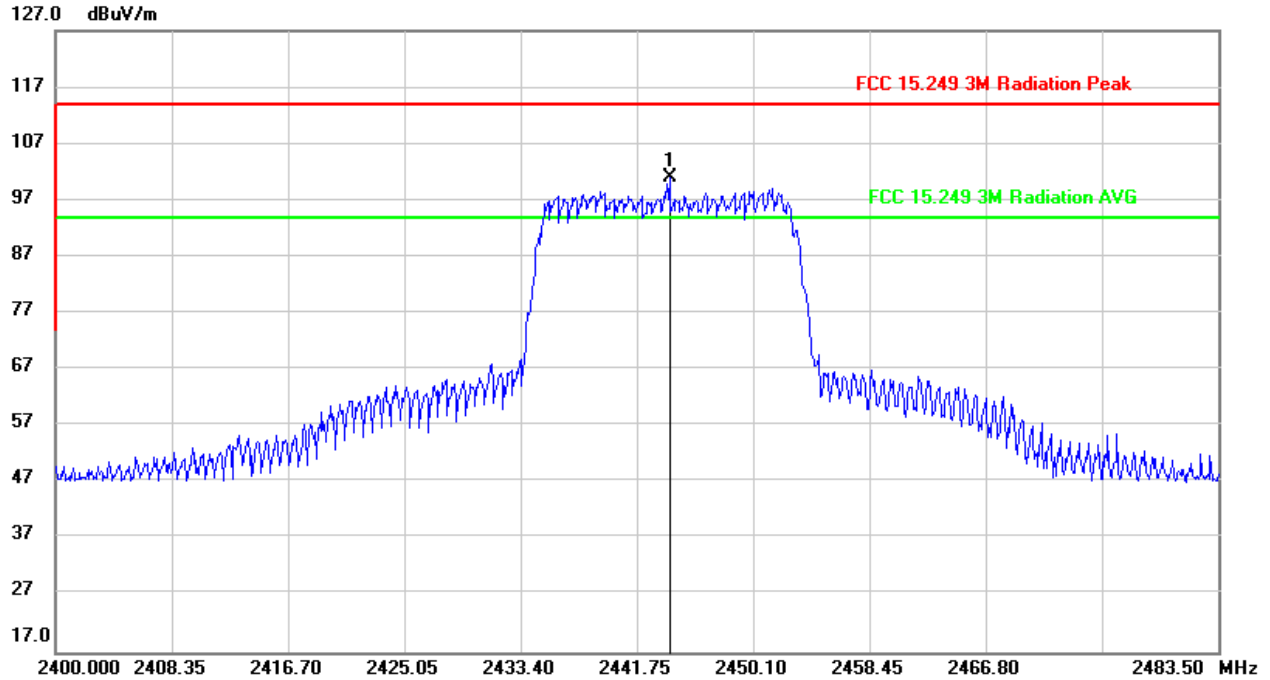

No.	Frequency (MHz)	Reading (dBuV)	Correct (dB/m)	Result (dBuV/m)	Limit (dBuV/m)	Margin (dB)	Remark
1	2444.088	67.93	32.95	100.88	114.00	-13.12	peak

- Note: 1. Measurement = Reading Level + Correct Factor.  
 2. If Peak Result complies with AV limit, AV Result is deemed to comply with AV limit.  
 3. Peak: Peak detector.



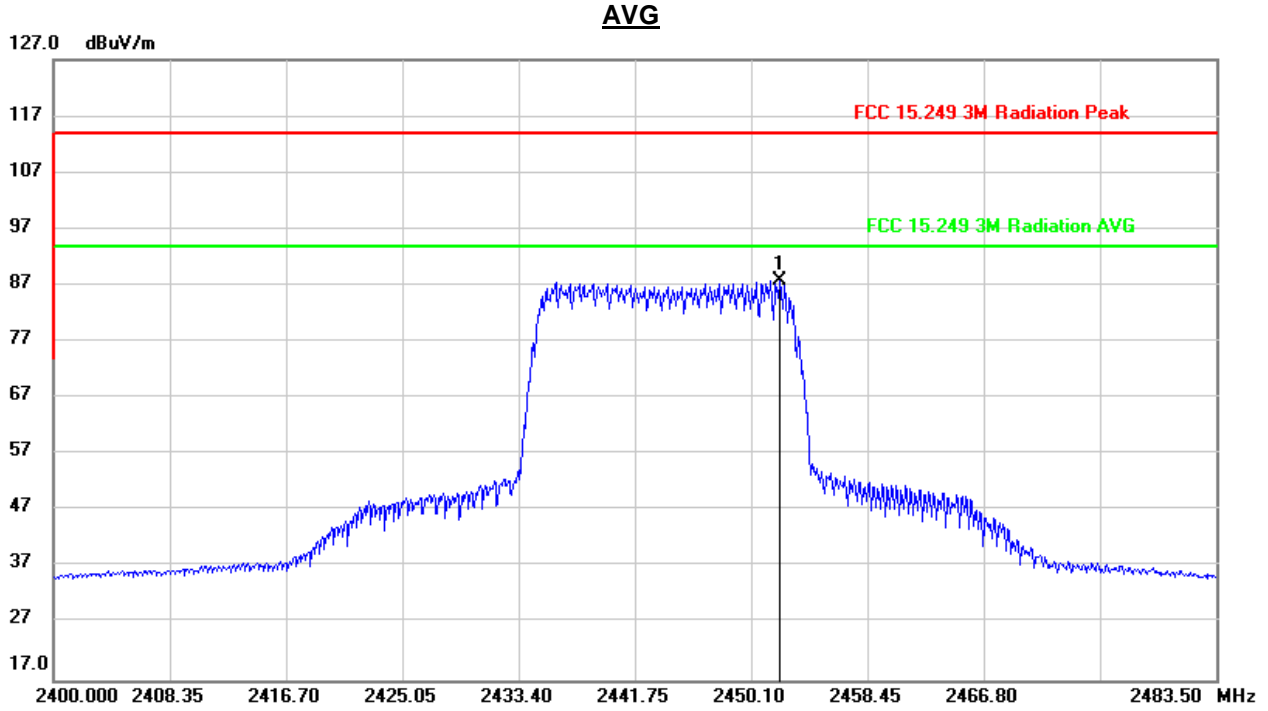

No.	Frequency (MHz)	Reading (dBuV)	Correct (dB/m)	Result (dBuV/m)	Limit (dBuV/m)	Margin (dB)	Remark
1	2452.188	54.81	32.92	87.73	94.00	-6.27	AVG

- Note:
1. Measurement = Reading Level + Correct Factor.
  2. If Peak Result complies with AV limit, AV Result is deemed to comply with AV limit.
  3. Peak: Peak detector.
  4. AVG:  $VBW=1/T_{on}=1K$ , where:  $T_{on}$  is transmit duration.
  5. For transmit duration, please refer to clause 7.1.



**RESTRICTED BANDEDGE AND FIELD STRENGTH OF INTENTIONAL EMISSIONS (HIGH CHANNEL, HORIZONTAL)**

**PEAK**

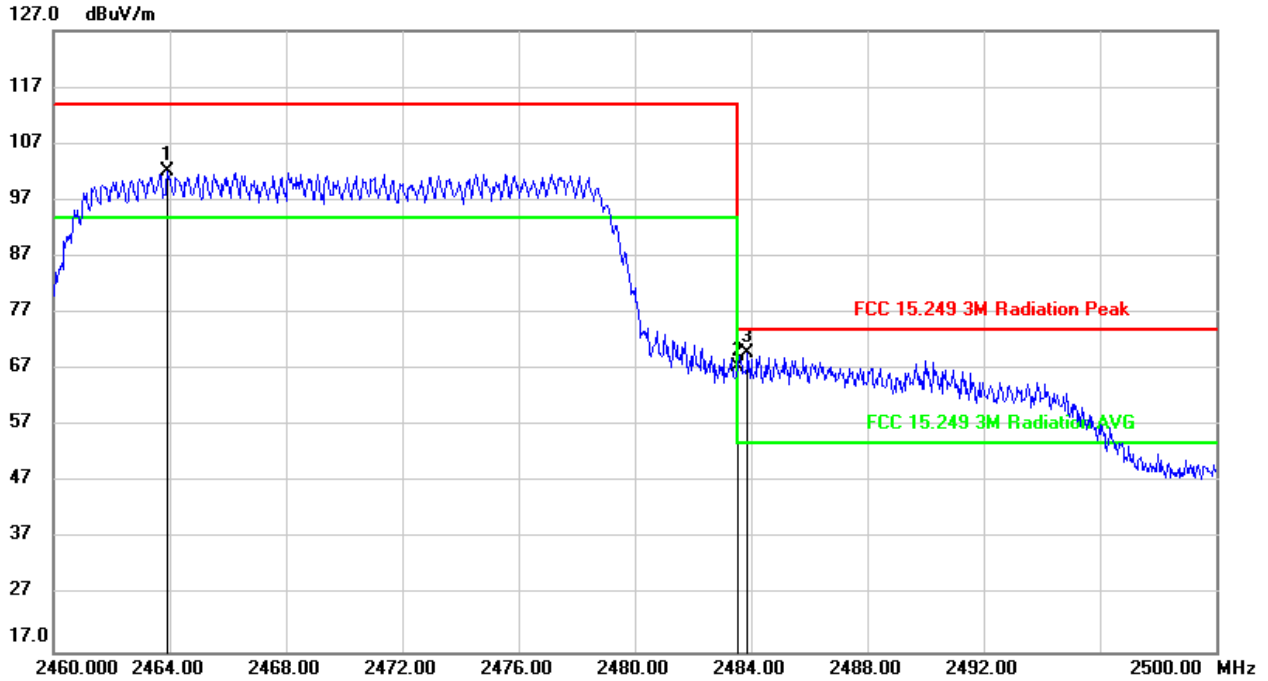

No.	Frequency (MHz)	Reading (dBuV)	Correct (dB/m)	Result (dBuV/m)	Limit (dBuV/m)	Margin (dB)	Remark
1	2463.920	69.31	32.80	102.11	114.00	-11.89	peak
2	2483.500	34.70	32.78	67.48	74.00	-6.52	peak
3	2483.880	37.08	32.78	69.86	74.00	-4.14	peak

- Note: 1. Measurement = Reading Level + Correct Factor.  
 2. If Peak Result complies with AV limit, AV Result is deemed to comply with AV limit.  
 3. Peak: Peak detector.

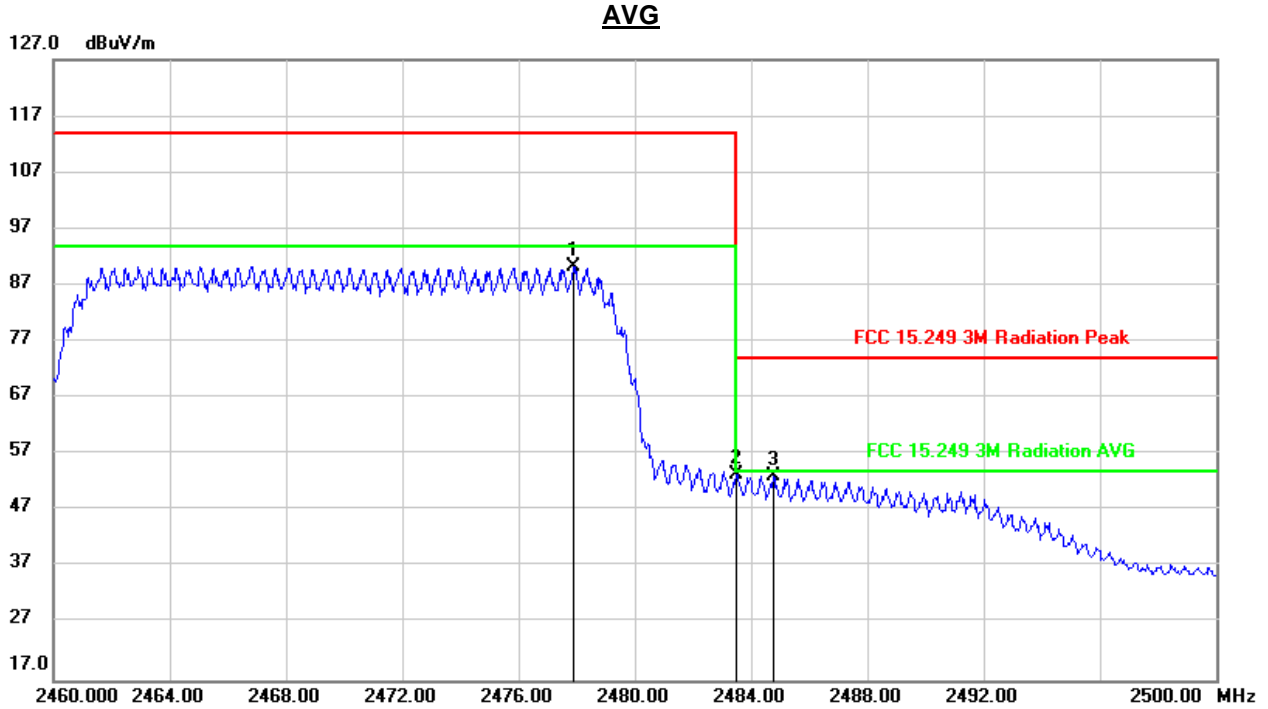

No.	Frequency (MHz)	Reading (dBuV)	Correct (dB/m)	Result (dBuV/m)	Limit (dBuV/m)	Margin (dB)	Remark
1	2477.880	57.61	32.79	90.40	94.00	-3.60	AVG
2	2483.500	20.76	32.78	53.54	54.00	-0.46	AVG
3	2484.760	20.34	32.78	53.12	54.00	-0.88	AVG

- Note:
1. Measurement = Reading Level + Correct Factor.
  2. If Peak Result complies with AV limit, AV Result is deemed to comply with AV limit.
  3. Peak: Peak detector.
  4. AVG: VBW=1/Ton=1K, where: Ton is transmit duration.
  5. For transmit duration, please refer to clause 7.1.



**RESTRICTED BANDEDGE AND FIELD STRENGTH OF INTENTIONAL EMISSIONS (HIGH CHANNEL, VERTICAL)**

**PEAK**

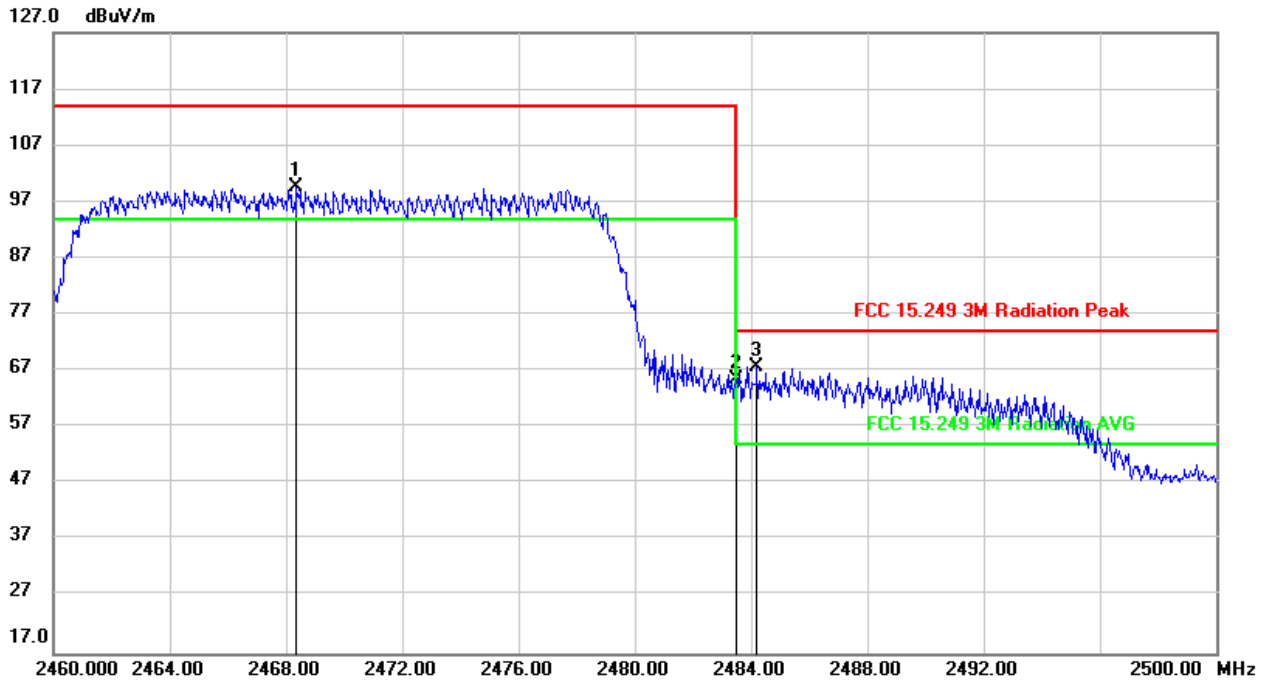

No.	Frequency (MHz)	Reading (dBuV)	Correct (dB/m)	Result (dBuV/m)	Limit (dBuV/m)	Margin (dB)	Remark
1	2468.360	66.81	32.90	99.71	114.00	-14.29	peak
2	2483.500	32.56	32.88	65.44	74.00	-8.56	peak
3	2484.200	34.86	32.88	67.74	74.00	-6.26	peak

Note: 1. Measurement = Reading Level + Correct Factor.  
2. If Peak Result complies with AV limit, AV Result is deemed to comply with AV limit.  
3. Peak: Peak detector.

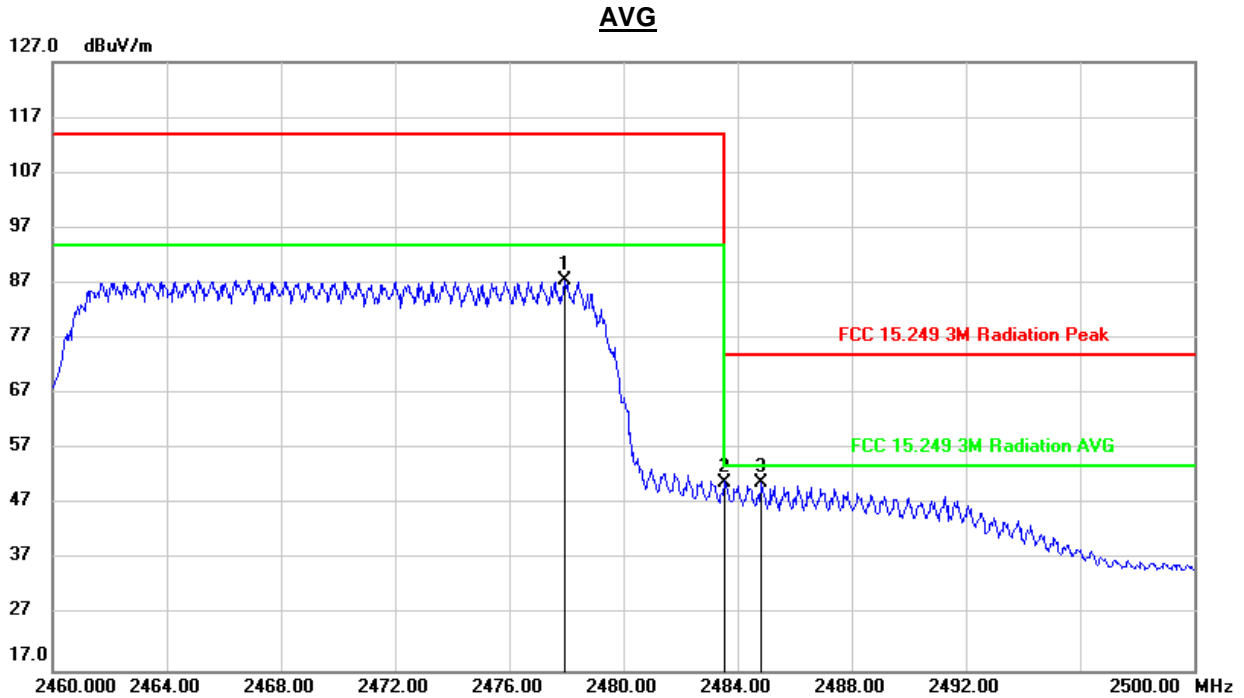

No.	Frequency (MHz)	Reading (dBuV)	Correct (dB/m)	Result (dBuV/m)	Limit (dBuV/m)	Margin (dB)	Remark
1	2477.920	54.64	32.89	87.53	94.00	-6.47	AVG
2	2483.500	18.02	32.88	50.90	54.00	-3.10	AVG
3	2484.840	18.11	32.88	50.99	54.00	-3.01	AVG

- Note: 1. Measurement = Reading Level + Correct Factor.  
 2. If Peak Result complies with AV limit, AV Result is deemed to comply with AV limit.  
 3. Peak: Peak detector.  
 4. AVG:  $VBW=1/T_{on}=1K$ , where:  $T_{on}$  is transmit duration.  
 5. For transmit duration, please refer to clause 7.1.

Note 2: EUT in each of three orthogonal axis emissions had been tested, but only the worst case (X axis) data recorded in the report.



### 8.3. SPURIOUS EMISSIONS BELOW 30M (WORST-CASE CONFIGURATION)

#### SPURIOUS EMISSIONS BELOW 30MHz (QPSK 20MHz LOW CHANNEL, HORIZONTAL)

##### 9K~150KHz

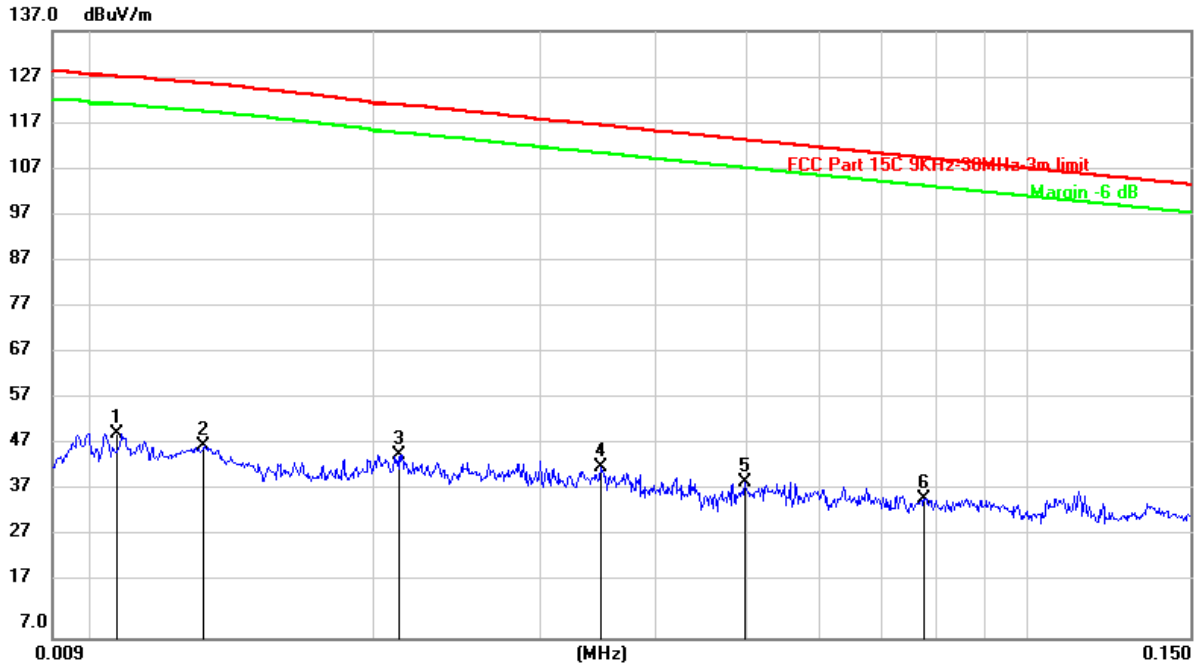

No.	Frequency (MHz)	Reading (dBuV)	Correct (dB/m)	Result (dBuV/m)	Limit (dBuV/m)	Margin (dB)	Remark
1	0.0106	30.48	20.22	50.70	127.24	-76.54	peak
2	0.0131	27.92	20.24	48.16	125.73	-77.57	peak
3	0.0212	25.93	20.31	46.24	121.16	-74.92	peak
4	0.0349	23.17	20.31	43.48	116.84	-73.36	peak
5	0.0497	20.10	20.31	40.41	113.68	-73.27	peak
6	0.0777	16.54	20.30	36.84	109.81	-72.97	peak

Note: 1. Measurement = Reading Level + Correct Factor.  
2. Peak: Peak detector.



**150KHz~30MHz**

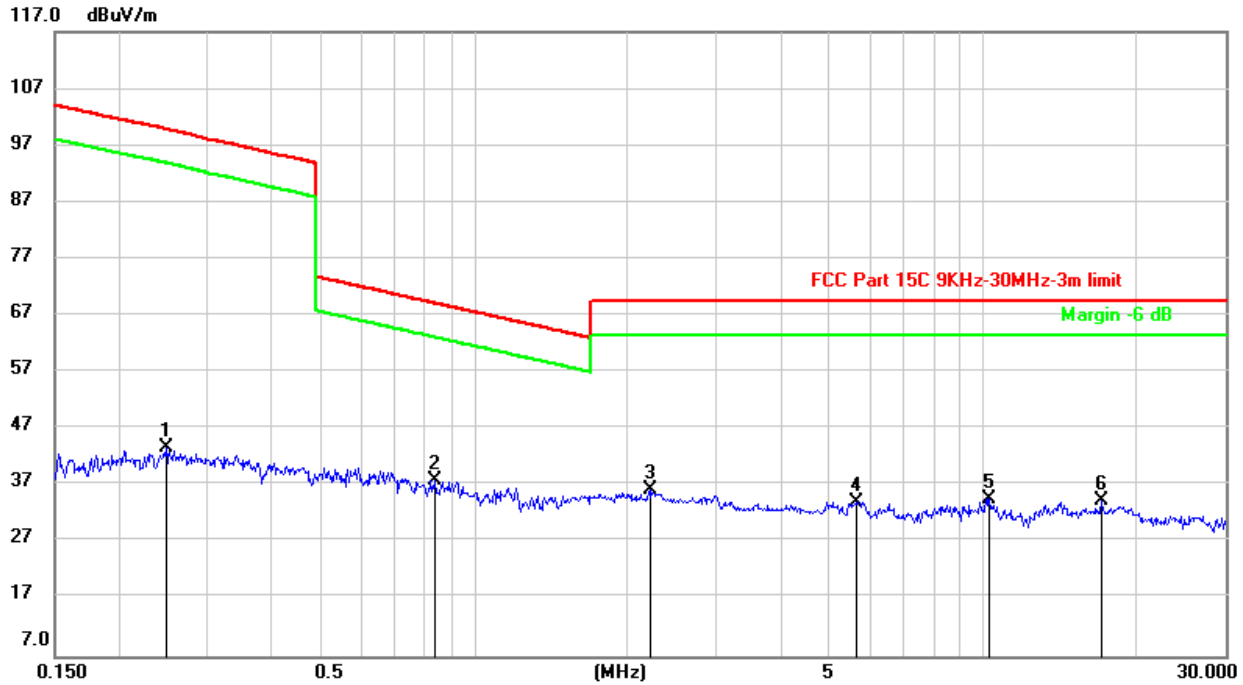

No.	Frequency (MHz)	Reading (dBuV)	Correct (dB/m)	Result (dBuV/m)	Limit (dBuV/m)	Margin (dB)	Remark
1	0.2479	23.41	20.32	43.73	99.89	-56.16	peak
2	0.8393	17.66	20.36	38.02	69.14	-31.12	peak
3	2.2132	15.48	20.77	36.25	69.54	-33.29	peak
4	5.6531	13.35	20.85	34.20	69.54	-35.34	peak
5	10.2873	13.65	21.05	34.70	69.54	-34.84	peak
6	17.1082	13.33	20.98	34.31	69.54	-35.23	peak

Note: 1. Measurement = Reading Level + Correct Factor.  
2. Peak: Peak detector.



**SPURIOUS EMISSIONS BELOW 30MHz (QPSK 20MHZ LOW CHANNEL, VERTICAL)**

**9KHz~150KHz**

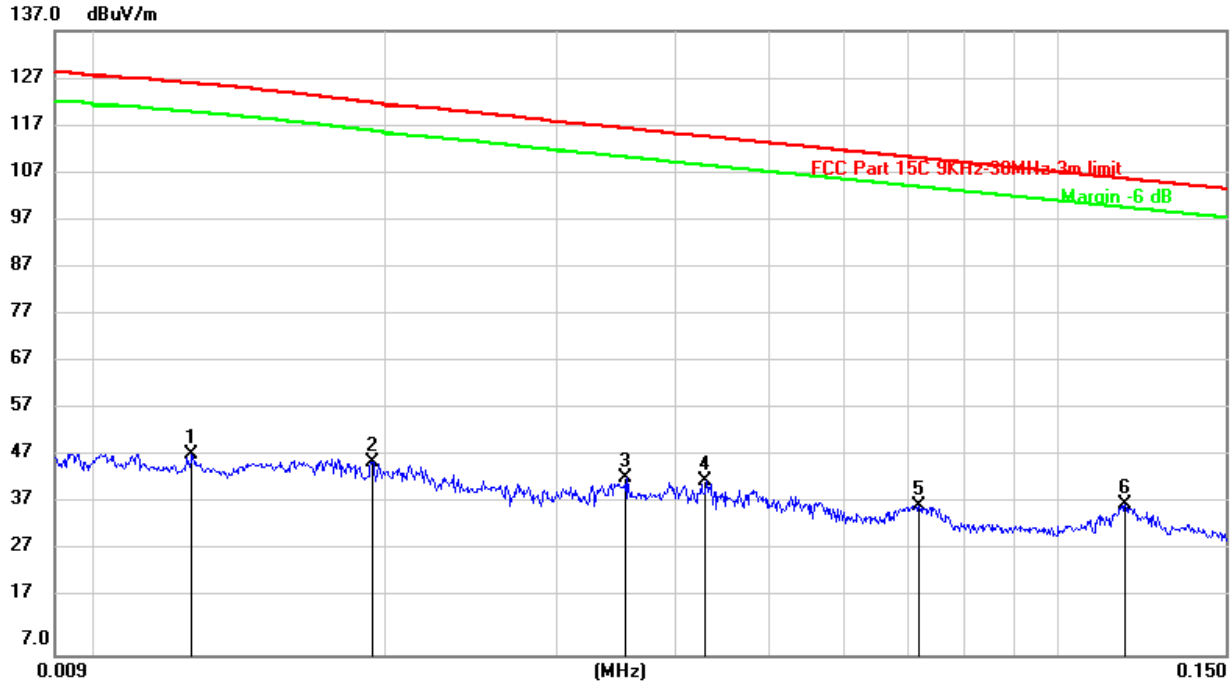

No.	Frequency (KHz)	Reading (dBuV)	Correct (dB/m)	Result (dBuV/m)	Limit (dBuV/m)	Margin (dB)	Remark
1	0.0125	28.41	20.23	48.64	126.09	-77.45	peak
2	0.0193	26.96	20.30	47.26	122.00	-74.74	peak
3	0.0354	23.47	20.31	43.78	116.71	-72.93	peak
4	0.0429	23.03	20.31	43.34	115.00	-71.66	peak
5	0.0718	17.71	20.31	38.02	110.49	-72.47	peak
6	0.1178	17.96	20.29	38.25	106.19	-67.94	peak

Note: 1. Measurement = Reading Level + Correct Factor.  
2. Peak: Peak detector.





**150KHz~30MHz**

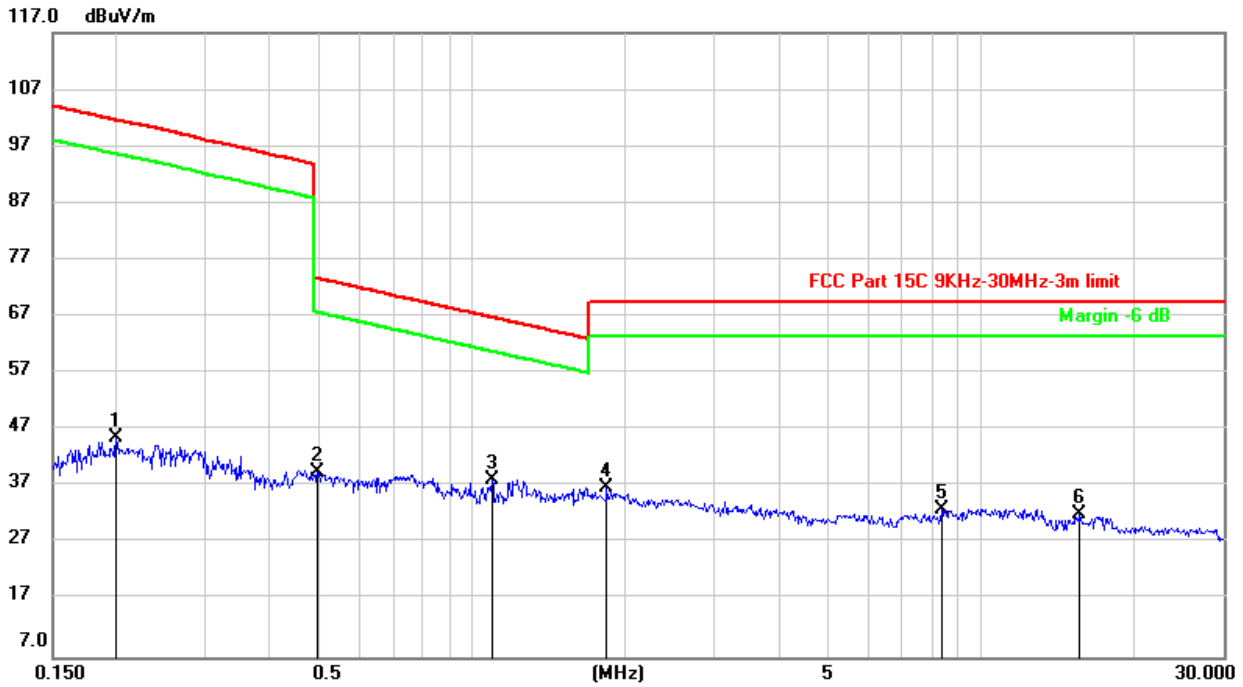

No.	Frequency (MHz)	Reading (dBuV)	Correct (dB/m)	Result (dBuV/m)	Limit (dBuV/m)	Margin (dB)	Remark
1	0.1995	25.35	20.37	45.72	101.60	-55.88	peak
2	0.4964	19.40	20.24	39.64	73.70	-34.06	peak
3	1.0939	17.73	20.41	38.14	66.83	-28.69	peak
4	1.8386	16.28	20.67	36.95	69.54	-32.59	peak
5	8.3671	11.88	20.98	32.86	69.54	-36.68	peak
6	15.6349	11.25	20.94	32.19	69.54	-37.35	peak

Note: 1. Measurement = Reading Level + Correct Factor.  
2. Peak: Peak detector.

Note 2: EUT in each of three orthogonal axis emissions had been tested, but only the worst case (X axis) data recorded in the report.



### 8.4. SPURIOUS EMISSIONS BELOW 1 GHz (WORST-CASE CONFIGURATION)

#### SPURIOUS EMISSIONS BELOW 1GHz (QPSK 20MHz LOW CHANNEL, HORIZONTAL)

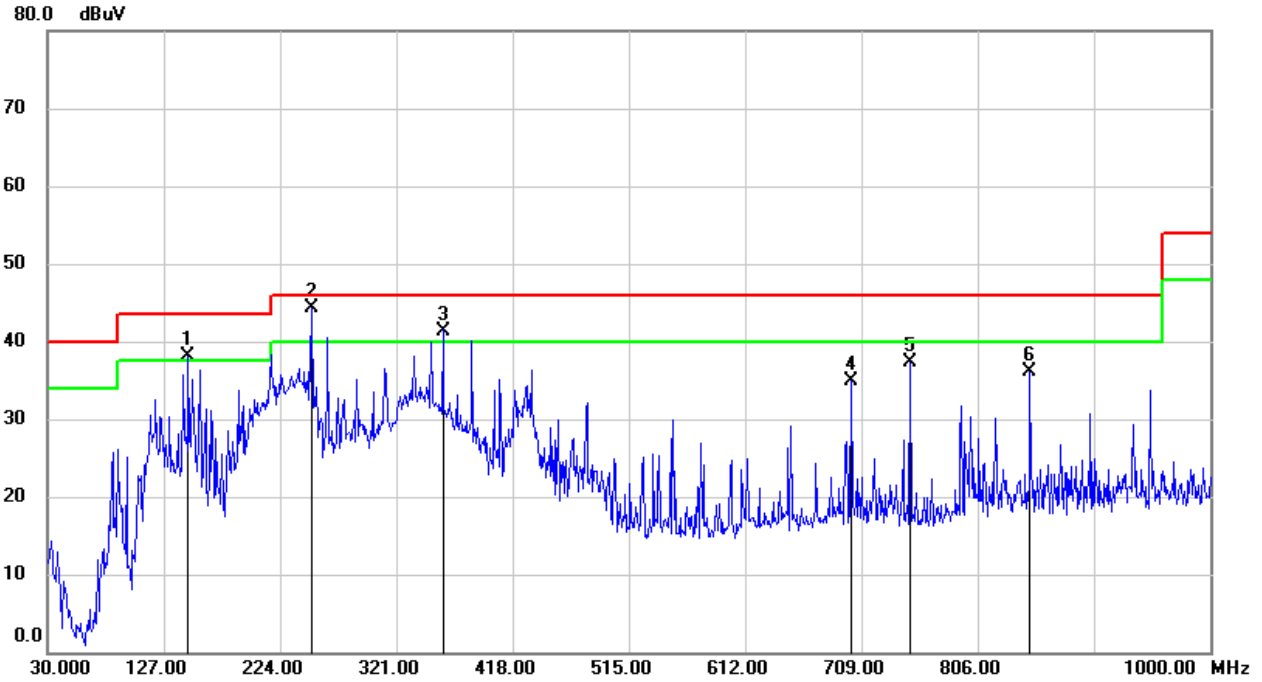

No.	Frequency (MHz)	Reading (dBuV)	Correct (dB)	Result (dBuV)	Limit (dBuV)	Margin (dB)	Remark
1	147.3700	55.64	-17.61	38.03	43.50	-5.47	QP
2	250.1900	62.02	-17.70	44.32	46.00	-1.68	QP
3	359.8000	54.92	-13.52	41.40	46.00	-4.60	QP
4	700.2700	42.73	-7.82	34.91	46.00	-11.09	QP
5	749.7400	44.79	-7.52	37.27	46.00	-8.73	QP
6	849.6500	42.22	-6.21	36.01	46.00	-9.99	QP

- Note: 1. Result Level = Read Level + Antenna Factor + Cable loss.  
 2. If Peak Result complies with QP limit, QP Result is deemed to comply with QP limit.  
 3. Test setup: RBW: 120 kHz, VBW: 300 kHz, Sweep time: auto.



**SPURIOUS EMISSIONS BELOW 1GHz (QPSK 20MHz LOW CHANNEL, VERTICAL)**

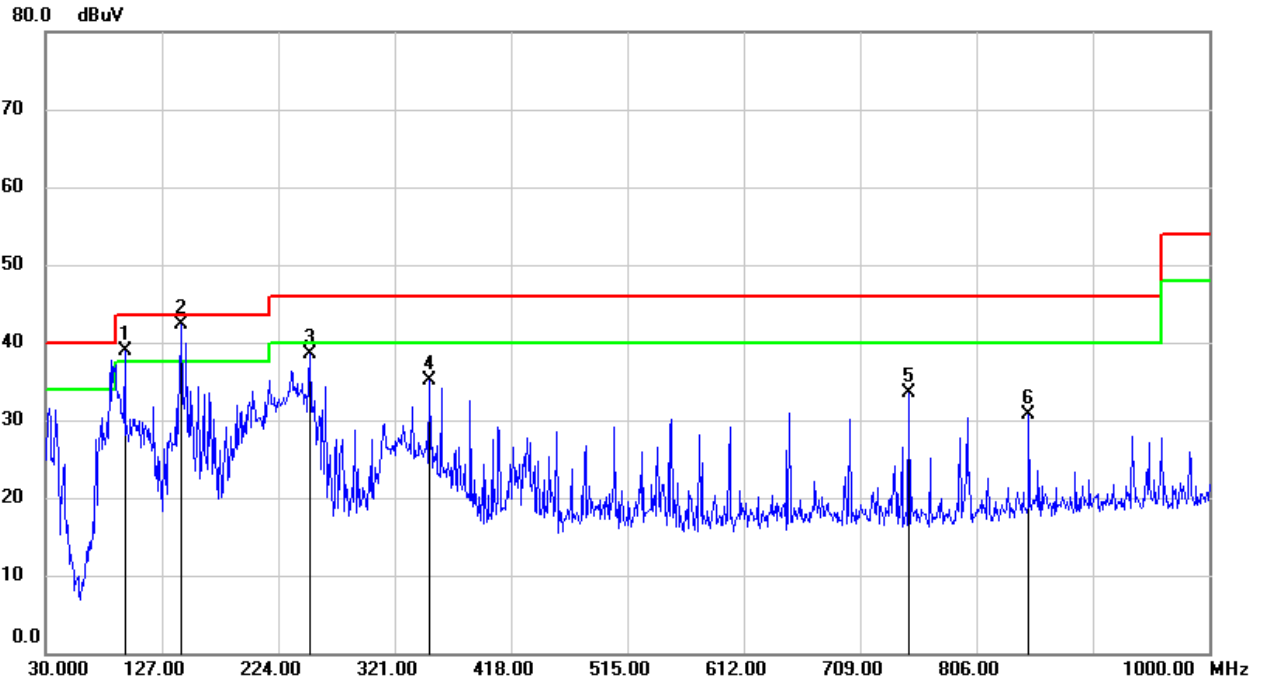

No.	Frequency (MHz)	Reading (dBuV)	Correct (dB)	Result (dBuV)	Limit (dBuV)	Margin (dB)	Remark
1	95.9600	60.74	-21.93	38.81	43.50	-4.69	QP
2	143.4900	60.33	-17.97	42.36	43.50	-1.14	QP
3	250.1900	56.26	-17.70	38.56	46.00	-7.44	QP
4	350.1000	48.90	-13.83	35.07	46.00	-10.93	QP
5	749.7400	41.07	-7.52	33.55	46.00	-12.45	QP
6	849.6500	36.83	-6.21	30.62	46.00	-15.38	QP

Note: 1. Result Level = Read Level + Antenna Factor + Cable loss.  
 2. If Peak Result complies with QP limit, QP Result is deemed to comply with QP limit.  
 3. Test setup: RBW: 120 kHz, VBW: 300 kHz, Sweep time: auto

Note 2: EUT in each of three orthogonal axis emissions had been tested, but only the worst case (X axis) data recorded in the report.



### 8.5. SPURIOUS EMISSIONS 1~18GHz

QPSK 10MHz Bandwidth Mode

#### HARMONICS AND SPURIOUS EMISSIONS 1G~18GHz (LOW CHANNEL, HORIZONTAL)

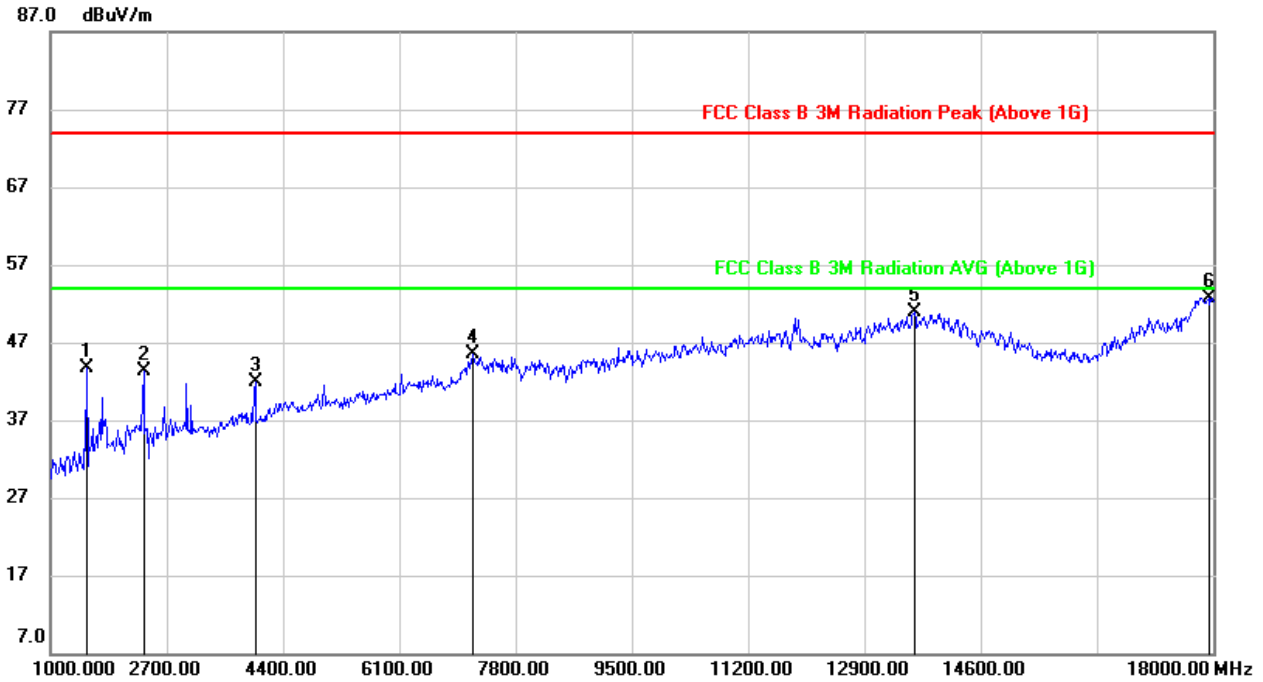

No.	Frequency (MHz)	Reading (dBuV)	Correct (dB/m)	Result (dBuV/m)	Limit (dBuV/m)	Margin (dB)	Remark
1	1527.000	56.39	-12.75	43.64	74.00	-30.36	peak
2	2360.000	52.16	-8.76	43.40	74.00	-30.60	peak
3	3992.000	46.43	-4.54	41.89	74.00	-32.11	peak
4	7171.000	39.15	6.36	45.51	74.00	-28.49	peak
5	13631.000	32.41	18.44	50.85	74.00	-23.15	peak
6	17932.000	28.27	24.50	52.77	74.00	-21.23	peak

Note: 1. Measurement = Reading Level + Correct Factor.  
 2. If Peak Result complies with AV limit, AV Result is deemed to comply with AV limit.  
 3. Peak: Peak detector.



**HARMONICS AND SPURIOUS EMISSIONS 1G~18GHz (LOW CHANNEL, VERTICAL)**

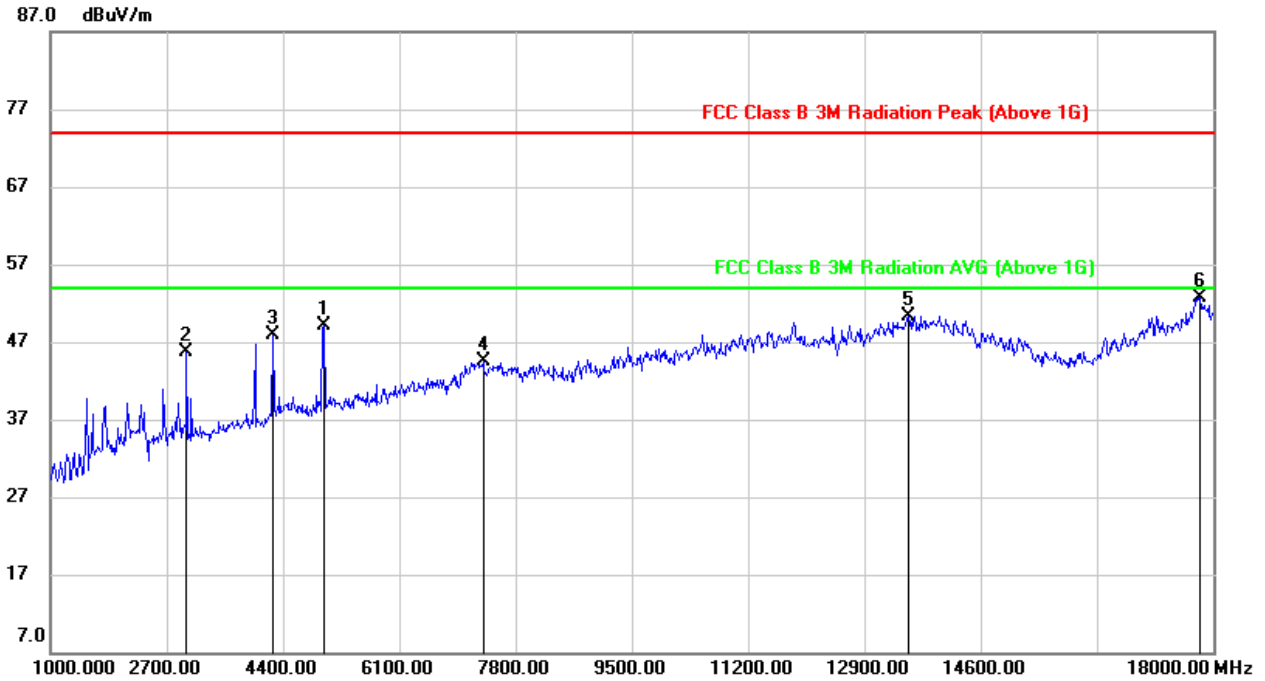

No.	Frequency (MHz)	Reading (dBuV)	Correct (dB/m)	Result (dBuV/m)	Limit (dBuV/m)	Margin (dB)	Remark
1	4995.000	49.79	-0.78	49.01	74.00	-24.99	peak
2	2989.000	53.00	-7.29	45.71	74.00	-28.29	peak
3	4247.000	51.23	-3.35	47.88	74.00	-26.12	peak
4	7324.000	38.26	6.24	44.50	74.00	-29.50	peak
5	13546.000	31.42	18.87	50.29	74.00	-23.71	peak
6	17813.000	28.18	24.44	52.62	74.00	-21.38	peak

Note: 1. Measurement = Reading Level + Correct Factor.  
 2. If Peak Result complies with AV limit, AV Result is deemed to comply with AV limit.  
 3. Peak: Peak detector.



**HARMONICS AND SPURIOUS EMISSIONS 1G~18GHz (MIDDLE CHANNEL, HORIZONTAL)**

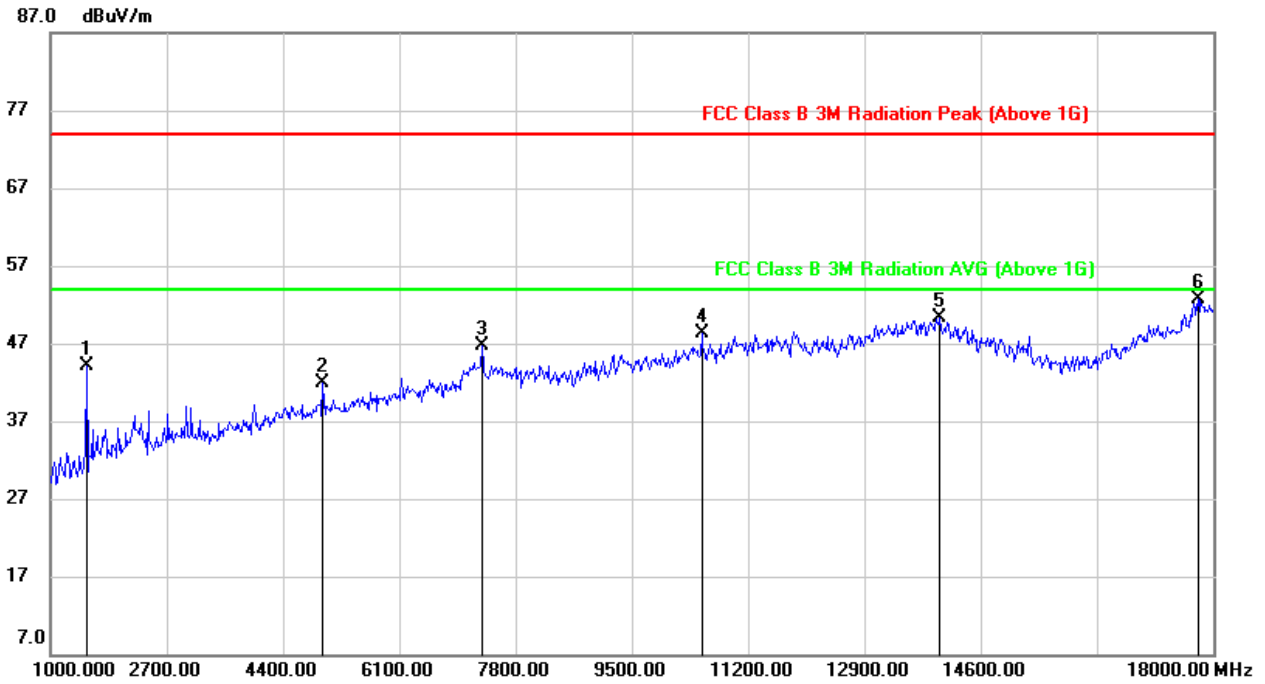

No.	Frequency (MHz)	Reading (dBuV)	Correct (dB/m)	Result (dBuV/m)	Limit (dBuV/m)	Margin (dB)	Remark
1	1527.000	56.87	-12.75	44.12	74.00	-29.88	peak
2	4978.000	42.75	-0.83	41.92	74.00	-32.08	peak
3	7307.000	40.31	6.38	46.69	74.00	-27.31	peak
4	10520.000	36.32	11.94	48.26	74.00	-25.74	peak
5	14005.000	31.86	18.47	50.33	74.00	-23.67	peak
6	17779.000	28.66	23.96	52.62	74.00	-21.38	peak

Note: 1. Measurement = Reading Level + Correct Factor.  
 2. If Peak Result complies with AV limit, AV Result is deemed to comply with AV limit.  
 3. Peak: Peak detector.



**HARMONICS AND SPURIOUS EMISSIONS 1G~18GHz (MIDDLE CHANNEL, VERTICAL)**

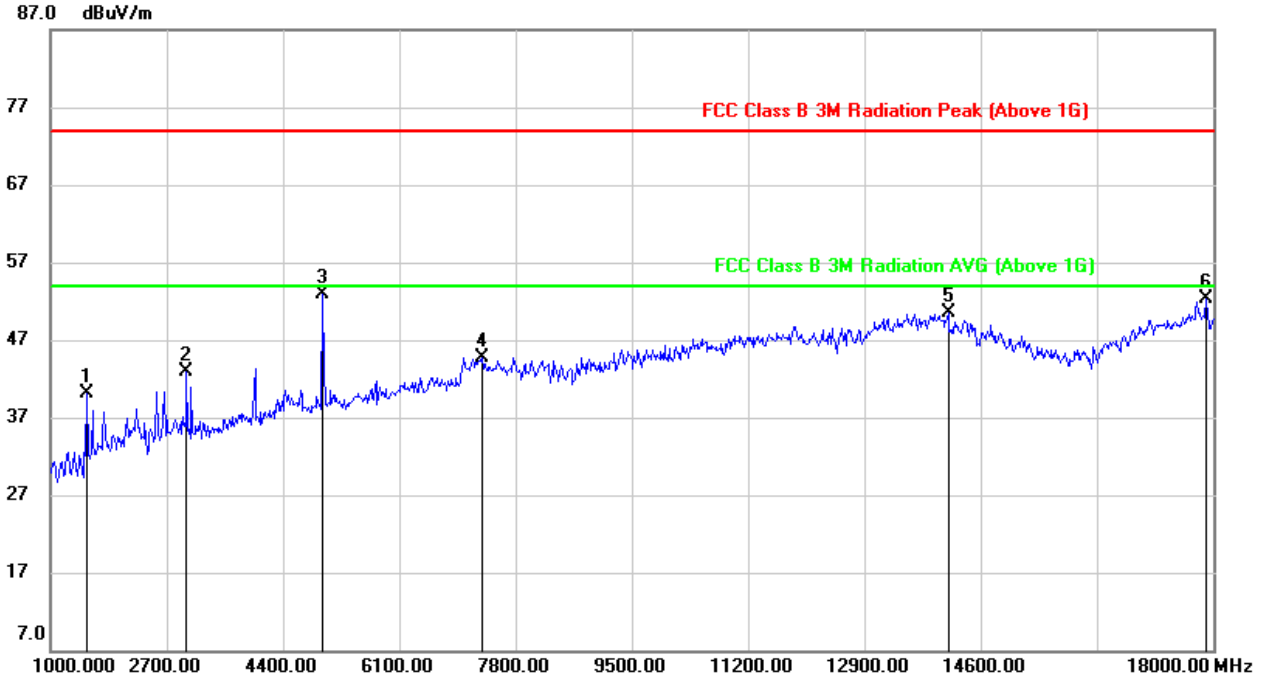

No.	Frequency (MHz)	Reading (dBuV)	Correct (dB/m)	Result (dBuV/m)	Limit (dBuV/m)	Margin (dB)	Remark
1	1527.000	52.76	-12.74	40.02	74.00	-33.98	peak
2	2989.000	50.18	-7.29	42.89	74.00	-31.11	peak
3	4978.000	53.60	-0.77	52.83	74.00	-21.17	peak
4	7307.000	38.28	6.40	44.68	74.00	-29.32	peak
5	14124.000	32.18	18.40	50.58	74.00	-23.42	peak
6	17898.000	28.12	24.26	52.38	74.00	-21.62	peak

Note: 1. Measurement = Reading Level + Correct Factor.  
2. If Peak Result complies with AV limit, AV Result is deemed to comply with AV limit.  
3. Peak: Peak detector.



**HARMONICS AND SPURIOUS EMISSIONS 1G~18GHz (HIGH CHANNEL, HORIZONTAL)**

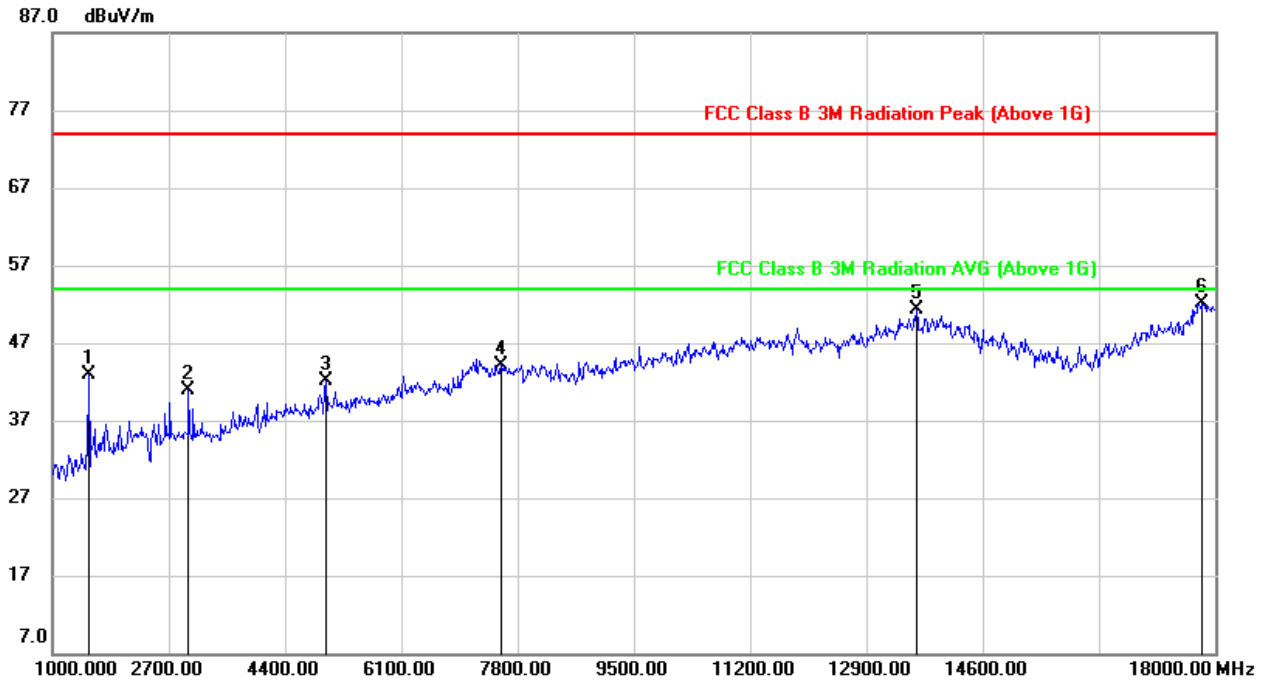

No.	Frequency (MHz)	Reading (dBuV)	Correct (dB/m)	Result (dBuV/m)	Limit (dBuV/m)	Margin (dB)	Remark
1	1527.000	55.58	-12.75	42.83	74.00	-31.17	peak
2	2989.000	48.11	-7.29	40.82	74.00	-33.18	peak
3	4995.000	43.01	-0.87	42.14	74.00	-31.86	peak
4	7562.000	37.56	6.64	44.20	74.00	-29.80	peak
5	13631.000	32.84	18.44	51.28	74.00	-22.72	peak
6	17813.000	27.92	24.25	52.17	74.00	-21.83	peak

Note: 1. Measurement = Reading Level + Correct Factor.  
 2. If Peak Result complies with AV limit, AV Result is deemed to comply with AV limit.  
 3. Peak: Peak detector.





**HARMONICS AND SPURIOUS EMISSIONS 1G~18GHz (HIGH CHANNEL, VERTICAL)**

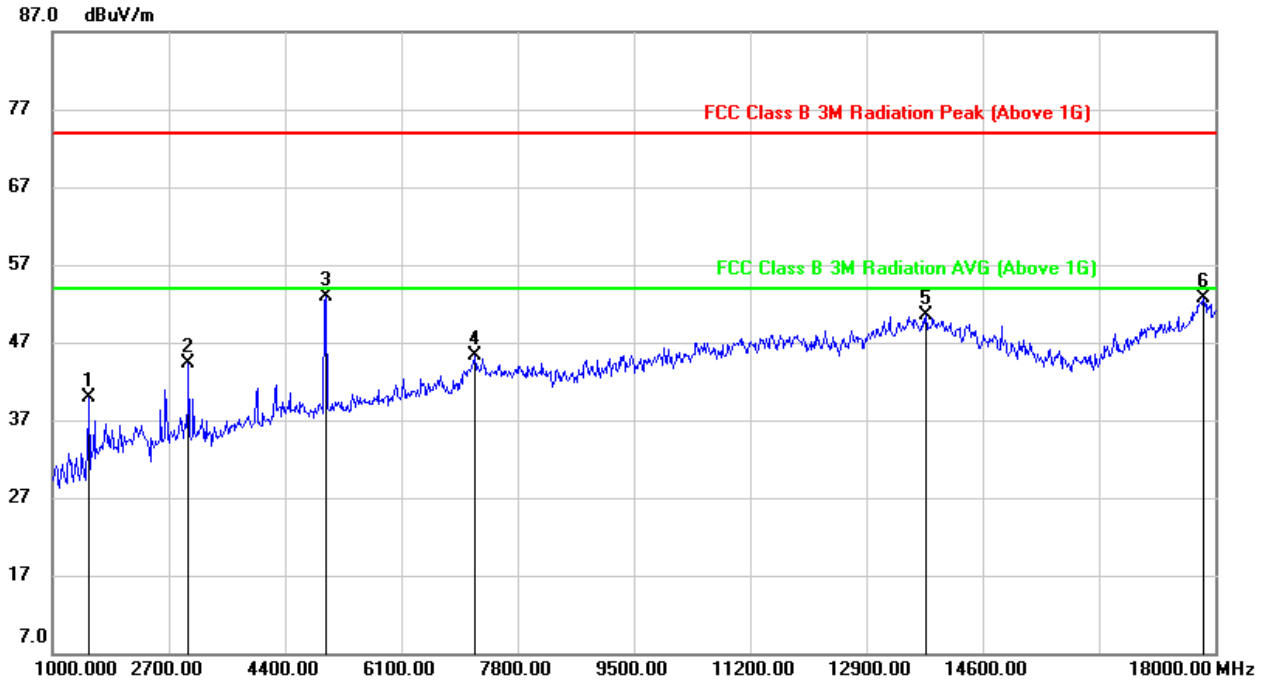

No.	Frequency (MHz)	Reading (dBuV)	Correct (dB/m)	Result (dBuV/m)	Limit (dBuV/m)	Margin (dB)	Remark
1	1527.000	52.62	-12.74	39.88	74.00	-34.12	peak
2	2989.000	51.66	-7.29	44.37	74.00	-29.63	peak
3	4995.000	53.67	-0.78	52.89	74.00	-21.11	peak
4	7171.000	38.77	6.46	45.23	74.00	-28.77	peak
5	13767.000	31.76	18.70	50.46	74.00	-23.54	peak
6	17830.000	28.53	24.17	52.70	74.00	-21.30	peak

Note: 1. Measurement = Reading Level + Correct Factor.  
 2. If Peak Result complies with AV limit, AV Result is deemed to comply with AV limit.  
 3. Peak: Peak detector.



OFDM 10MHz Bandwidth Mode

**HARMONICS AND SPURIOUS EMISSIONS 1G~18GHz (LOW CHANNEL, HORIZONTAL)**

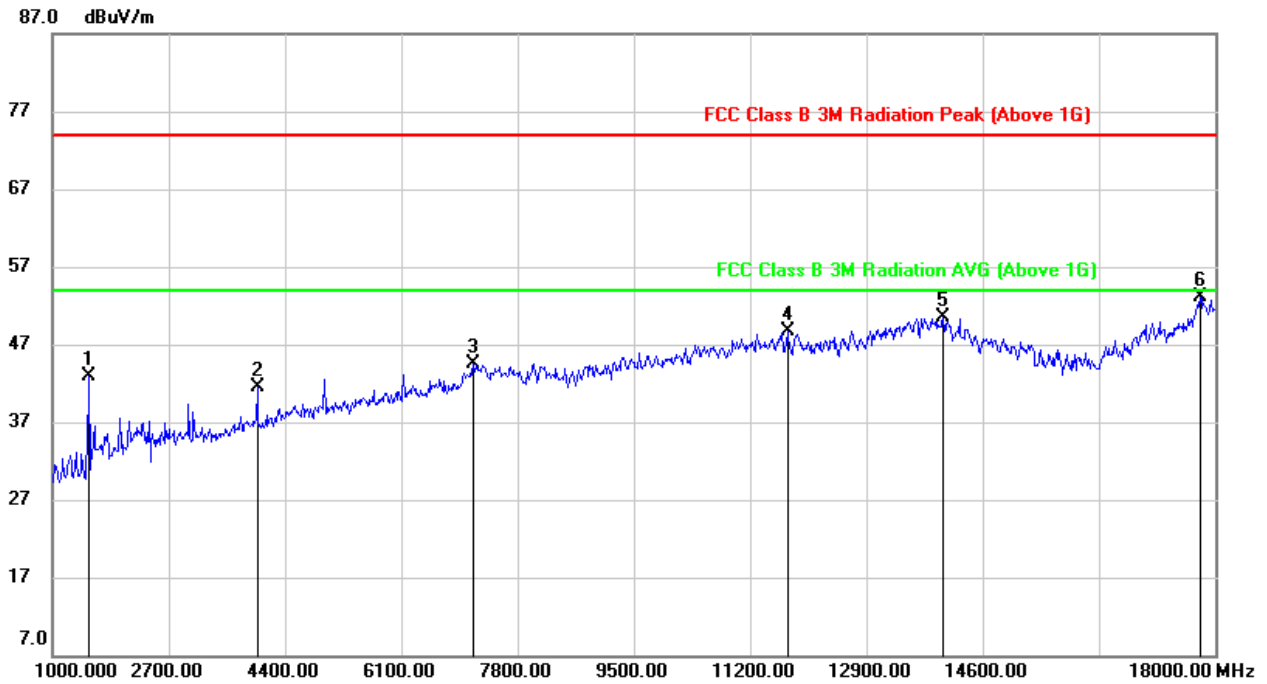

No.	Frequency (MHz)	Reading (dBuV)	Correct (dB/m)	Result (dBuV/m)	Limit (dBuV/m)	Margin (dB)	Remark
1	1527.000	55.65	-12.75	42.90	74.00	-31.10	peak
2	3992.000	46.13	-4.54	41.59	74.00	-32.41	peak
3	7154.000	38.10	6.37	44.47	74.00	-29.53	peak
4	11744.000	34.12	14.57	48.69	74.00	-25.31	peak
5	14022.000	32.06	18.47	50.53	74.00	-23.47	peak
6	17779.000	29.10	23.96	53.06	74.00	-20.94	peak

Note: 1. Measurement = Reading Level + Correct Factor.  
 2. If Peak Result complies with AV limit, AV Result is deemed to comply with AV limit.  
 3. Peak: Peak detector.



**HARMONICS AND SPURIOUS EMISSIONS 1G~18GHz (LOW CHANNEL, VERTICAL)**

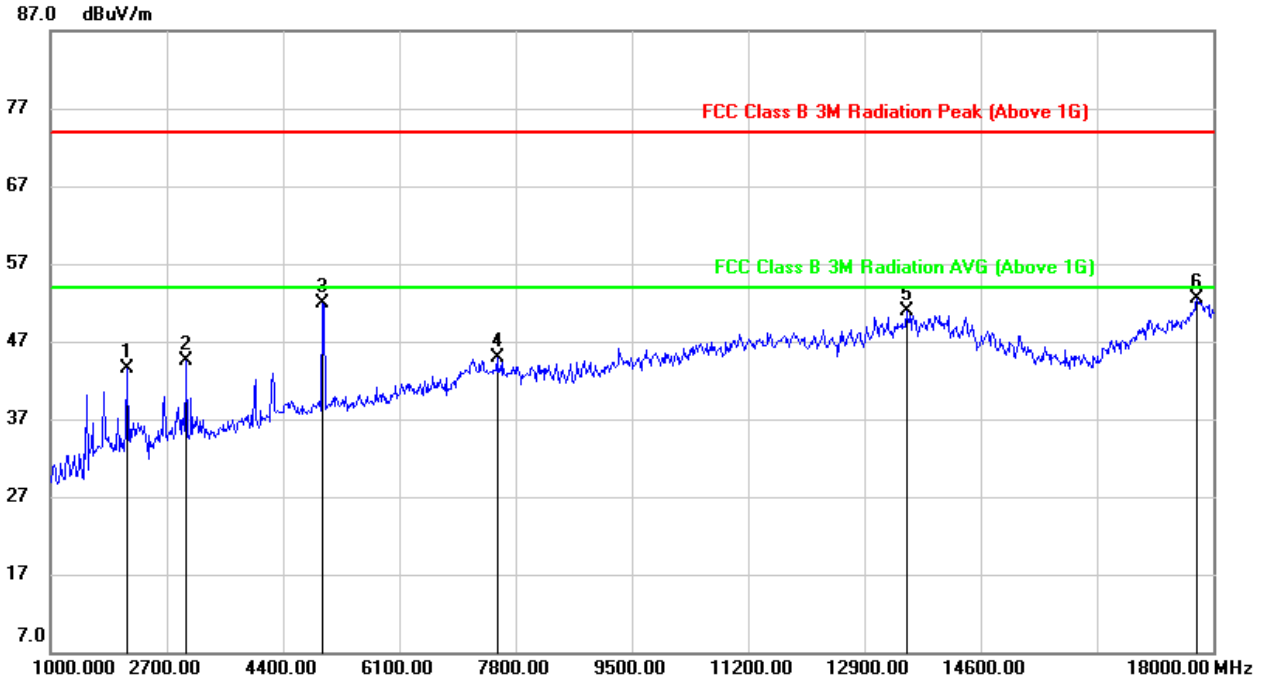

No.	Frequency (MHz)	Reading (dBuV)	Correct (dB/m)	Result (dBuV/m)	Limit (dBuV/m)	Margin (dB)	Remark
1	2122.000	53.53	-10.03	43.50	74.00	-30.50	peak
2	2989.000	51.80	-7.29	44.51	74.00	-29.49	peak
3	4978.000	52.75	-0.77	51.98	74.00	-22.02	peak
4	7528.000	38.08	6.81	44.89	74.00	-29.11	peak
5	13512.000	32.21	18.64	50.85	74.00	-23.15	peak
6	17762.000	28.39	24.14	52.53	74.00	-21.47	peak

Note: 1. Measurement = Reading Level + Correct Factor.  
 2. If Peak Result complies with AV limit, AV Result is deemed to comply with AV limit.  
 3. Peak: Peak detector.



**HARMONICS AND SPURIOUS EMISSIONS 1G~18GHz (MIDDLE CHANNEL, HORIZONTAL)**

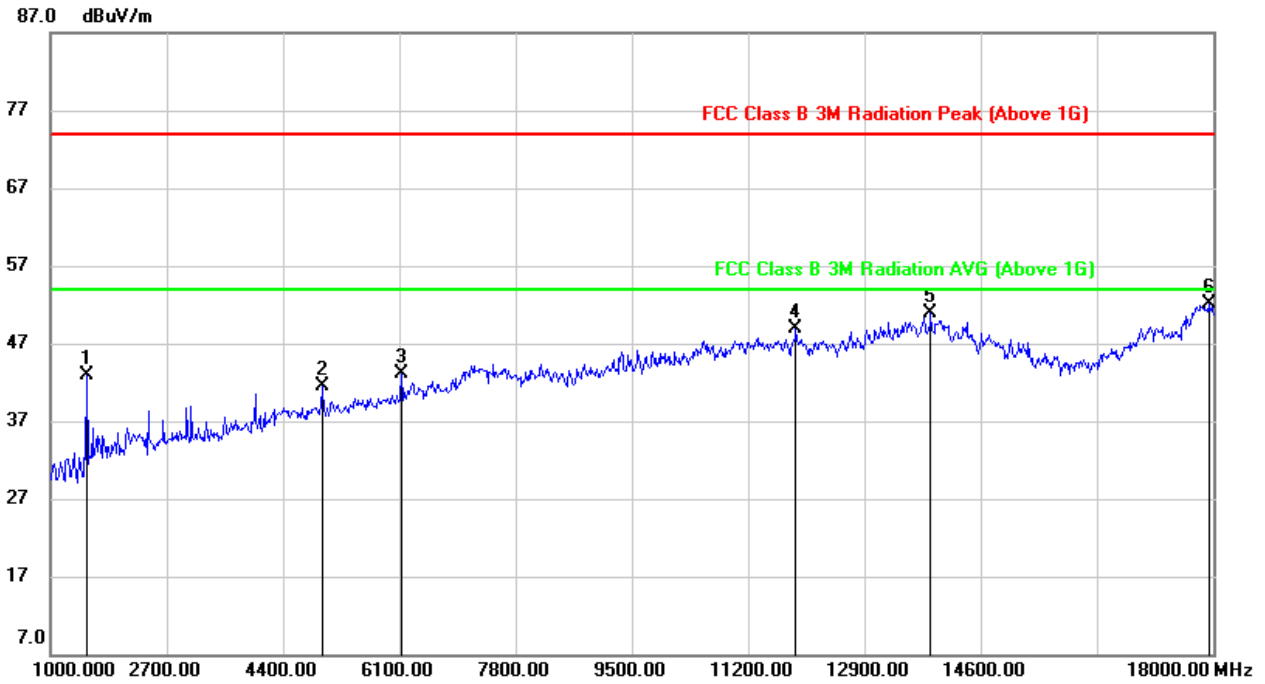

No.	Frequency (MHz)	Reading (dBuV)	Correct (dB/m)	Result (dBuV/m)	Limit (dBuV/m)	Margin (dB)	Remark
1	1527.000	55.73	-12.75	42.98	74.00	-31.02	peak
2	4978.000	42.32	-0.83	41.49	74.00	-32.51	peak
3	6134.000	40.78	2.37	43.15	74.00	-30.85	peak
4	11897.000	33.75	15.19	48.94	74.00	-25.06	peak
5	13869.000	32.24	18.57	50.81	74.00	-23.19	peak
6	17932.000	27.67	24.50	52.17	74.00	-21.83	peak

Note: 1. Measurement = Reading Level + Correct Factor.  
 2. If Peak Result complies with AV limit, AV Result is deemed to comply with AV limit.  
 3. Peak: Peak detector.



**HARMONICS AND SPURIOUS EMISSIONS 1G~18GHz (MIDDLE CHANNEL, VERTICAL)**

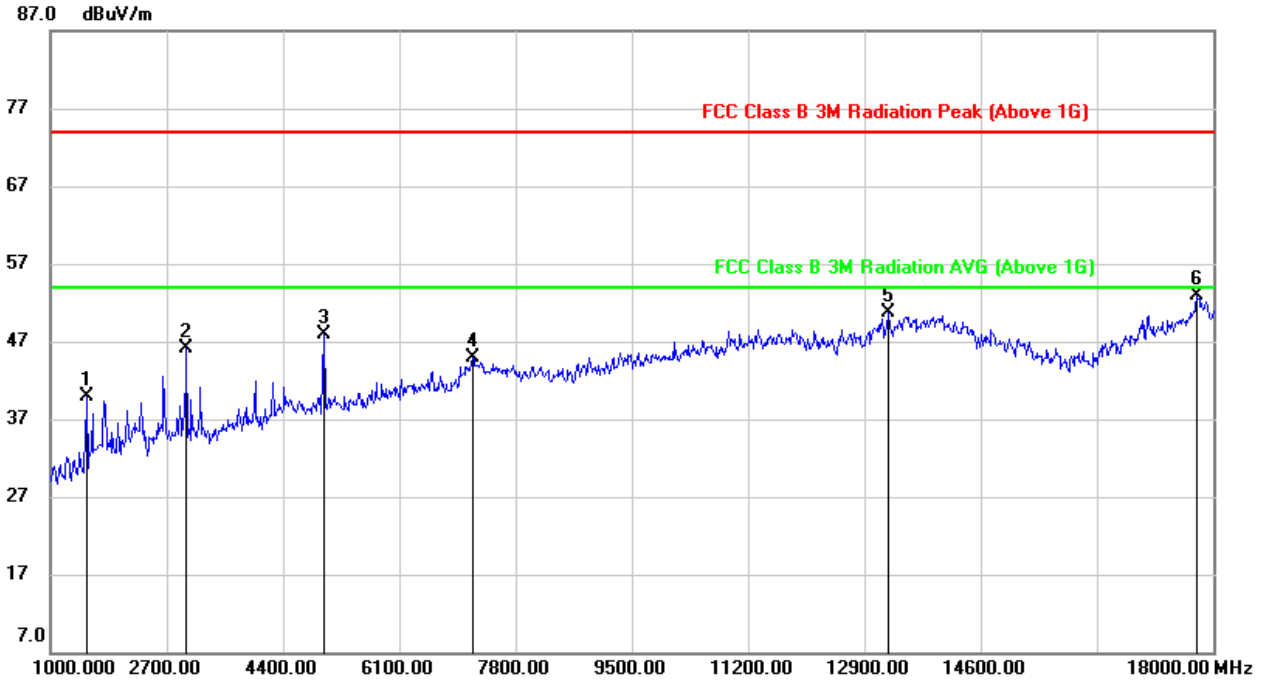

No.	Frequency (MHz)	Reading (dBuV)	Correct (dB/m)	Result (dBuV/m)	Limit (dBuV/m)	Margin (dB)	Remark
1	1527.000	52.63	-12.74	39.89	74.00	-34.11	peak
2	2989.000	53.34	-7.29	46.05	74.00	-27.95	peak
3	4995.000	48.69	-0.78	47.91	74.00	-26.09	peak
4	7171.000	38.40	6.46	44.86	74.00	-29.14	peak
5	13257.000	33.22	17.46	50.68	74.00	-23.32	peak
6	17762.000	28.82	24.14	52.96	74.00	-21.04	peak

Note: 1. Measurement = Reading Level + Correct Factor.  
 2. If Peak Result complies with AV limit, AV Result is deemed to comply with AV limit.  
 3. Peak: Peak detector.



**HARMONICS AND SPURIOUS EMISSIONS 1G~18GHz (HIGH CHANNEL, HORIZONTAL)**

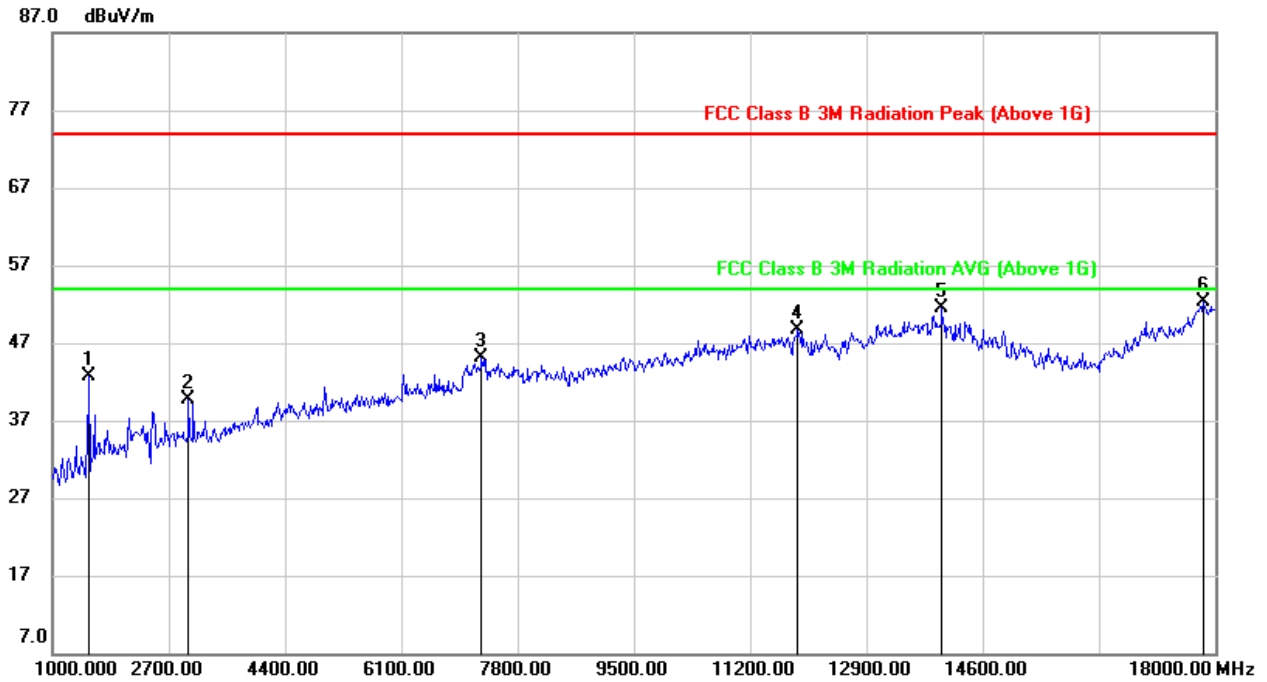

No.	Frequency (MHz)	Reading (dBuV)	Correct (dB/m)	Result (dBuV/m)	Limit (dBuV/m)	Margin (dB)	Remark
1	1527.000	55.37	-12.75	42.62	74.00	-31.38	peak
2	2989.000	47.00	-7.29	39.71	74.00	-34.29	peak
3	7273.000	38.59	6.46	45.05	74.00	-28.95	peak
4	11897.000	33.50	15.19	48.69	74.00	-25.31	peak
5	14005.000	33.01	18.47	51.48	74.00	-22.52	peak
6	17830.000	27.96	24.25	52.21	74.00	-21.79	peak

Note: 1. Measurement = Reading Level + Correct Factor.  
 2. If Peak Result complies with AV limit, AV Result is deemed to comply with AV limit.  
 3. Peak: Peak detector.



**HARMONICS AND SPURIOUS EMISSIONS 1G~18GHz (HIGH CHANNEL, VERTICAL)**

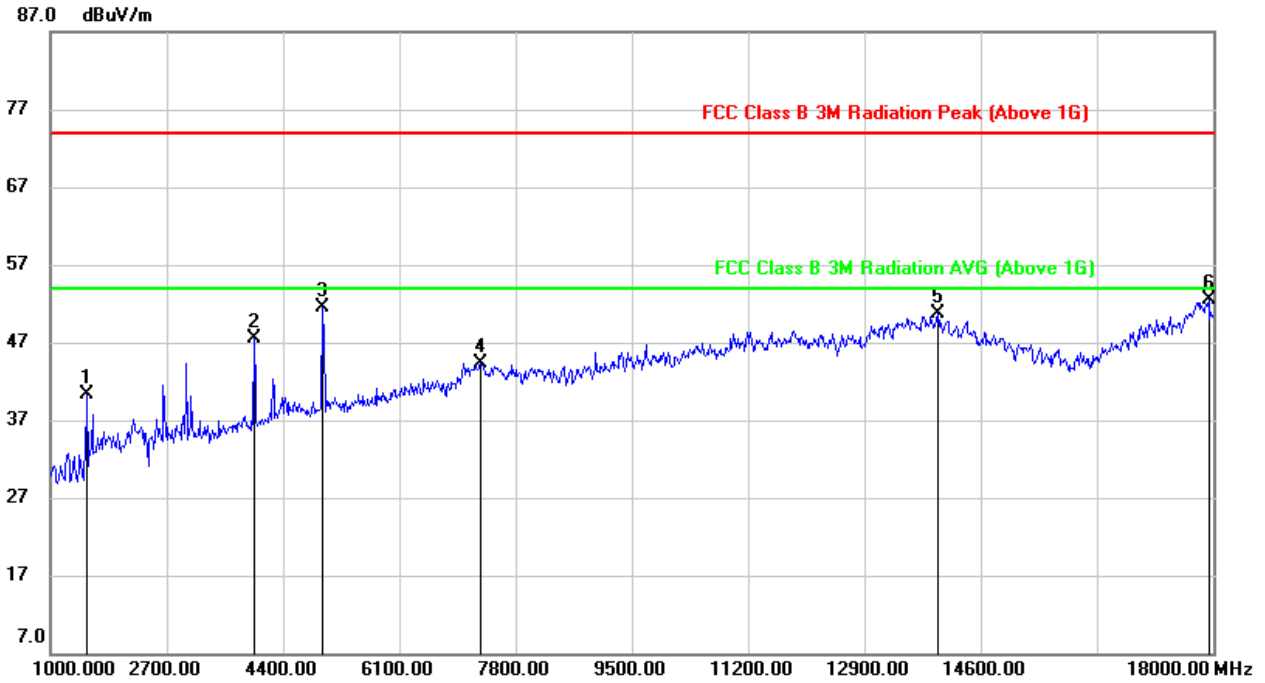

No.	Frequency (MHz)	Reading (dBuV)	Correct (dB/m)	Result (dBuV/m)	Limit (dBuV/m)	Margin (dB)	Remark
1	1527.000	52.98	-12.74	40.24	74.00	-33.76	peak
2	3975.000	52.07	-4.54	47.53	74.00	-26.47	peak
3	4978.000	52.20	-0.77	51.43	74.00	-22.57	peak
4	7290.000	37.91	6.44	44.35	74.00	-29.65	peak
5	13971.000	32.04	18.62	50.66	74.00	-23.34	peak
6	17932.000	28.72	23.84	52.56	74.00	-21.44	peak

Note: 1. Measurement = Reading Level + Correct Factor.  
 2. If Peak Result complies with AV limit, AV Result is deemed to comply with AV limit.  
 3. Peak: Peak detector.



QPSK 20MHz Bandwidth Mode

**HARMONICS AND SPURIOUS EMISSIONS 1G~18GHz (LOW CHANNEL, HORIZONTAL)**

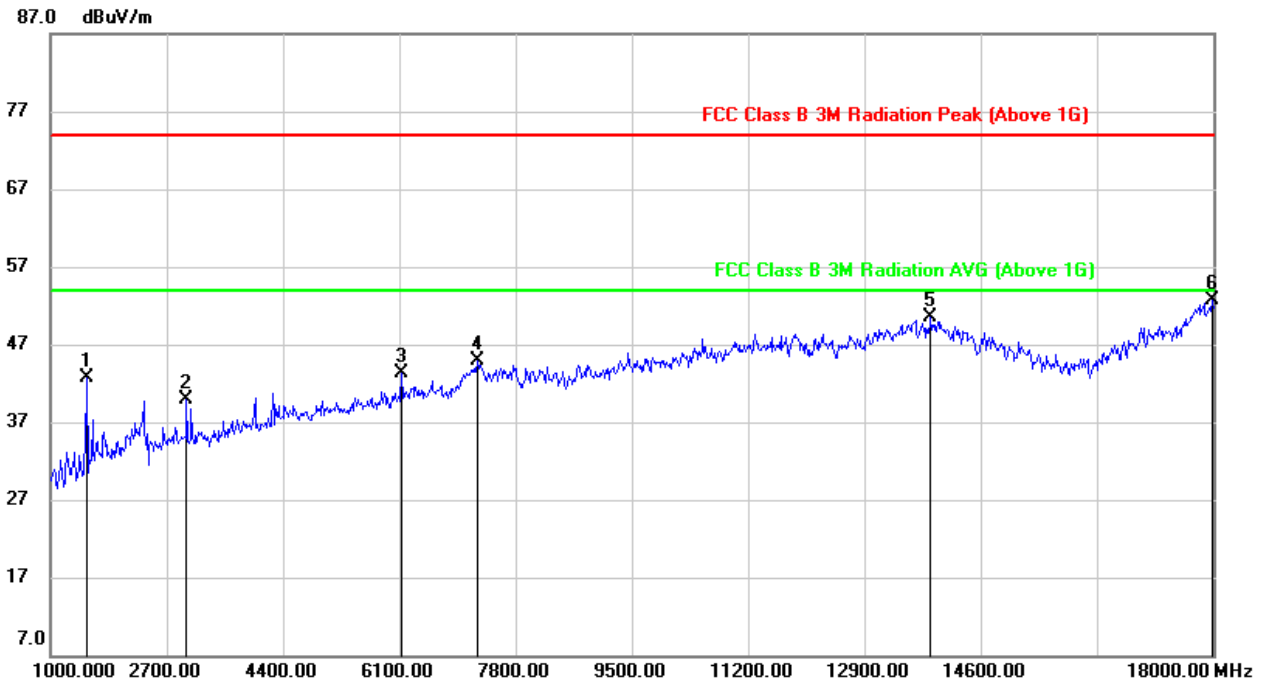

No.	Frequency (MHz)	Reading (dBuV)	Correct (dB/m)	Result (dBuV/m)	Limit (dBuV/m)	Margin (dB)	Remark
1	1527.000	55.53	-12.75	42.78	74.00	-31.22	peak
2	2989.000	47.25	-7.29	39.96	74.00	-34.04	peak
3	6134.000	40.88	2.37	43.25	74.00	-30.75	peak
4	7239.000	38.50	6.42	44.92	74.00	-29.08	peak
5	13869.000	31.84	18.57	50.41	74.00	-23.59	peak
6	17983.000	27.94	24.81	52.75	74.00	-21.25	peak

Note: 1. Measurement = Reading Level + Correct Factor.  
 2. If Peak Result complies with AV limit, AV Result is deemed to comply with AV limit.  
 3. Peak: Peak detector.





**HARMONICS AND SPURIOUS EMISSIONS 1G~18GHz (LOW CHANNEL, VERTICAL)**

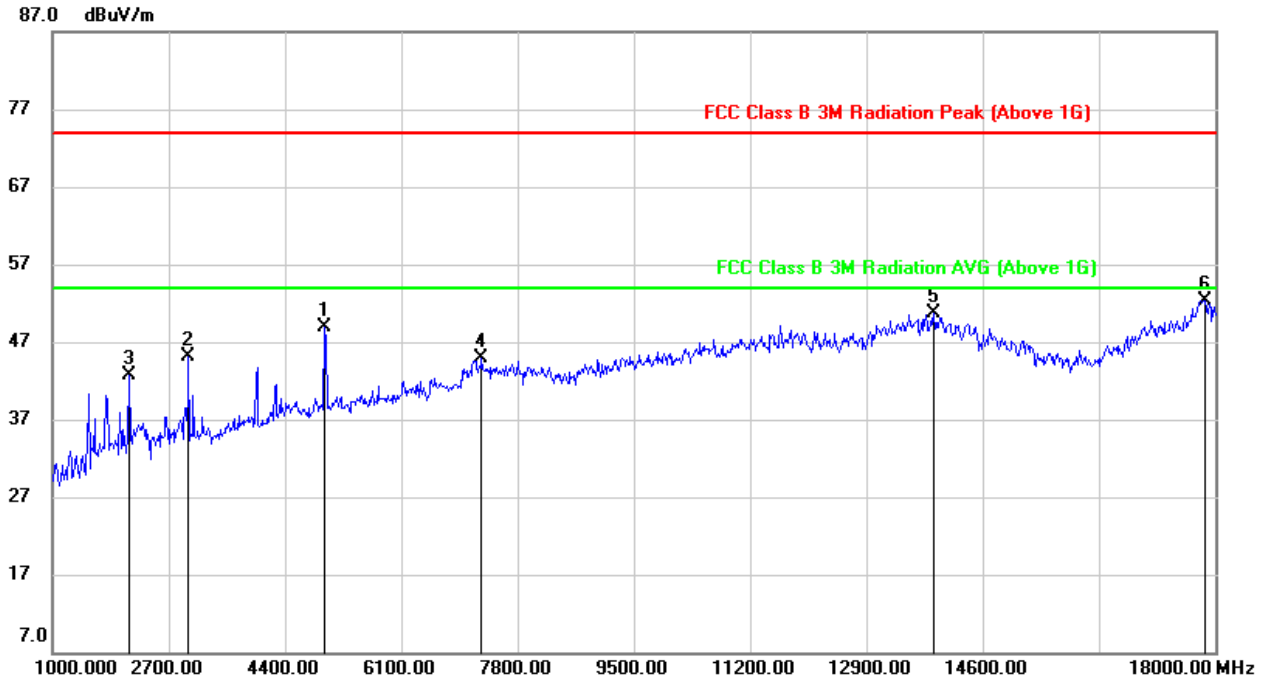

No.	Frequency (MHz)	Reading (dBuV)	Correct (dB/m)	Result (dBuV/m)	Limit (dBuV/m)	Margin (dB)	Remark
1	4978.000	49.65	-0.77	48.88	74.00	-25.12	peak
2	2989.000	52.38	-7.29	45.09	74.00	-28.91	peak
3	2122.000	52.70	-10.03	42.67	74.00	-31.33	peak
4	7273.000	38.49	6.41	44.90	74.00	-29.10	peak
5	13886.000	31.94	18.76	50.70	74.00	-23.30	peak
6	17847.000	28.46	23.90	52.36	74.00	-21.64	peak

Note: 1. Measurement = Reading Level + Correct Factor.  
 2. If Peak Result complies with AV limit, AV Result is deemed to comply with AV limit.  
 3. Peak: Peak detector.



**HARMONICS AND SPURIOUS EMISSIONS 1G~18GHz (MIDDLE CHANNEL, HORIZONTAL)**

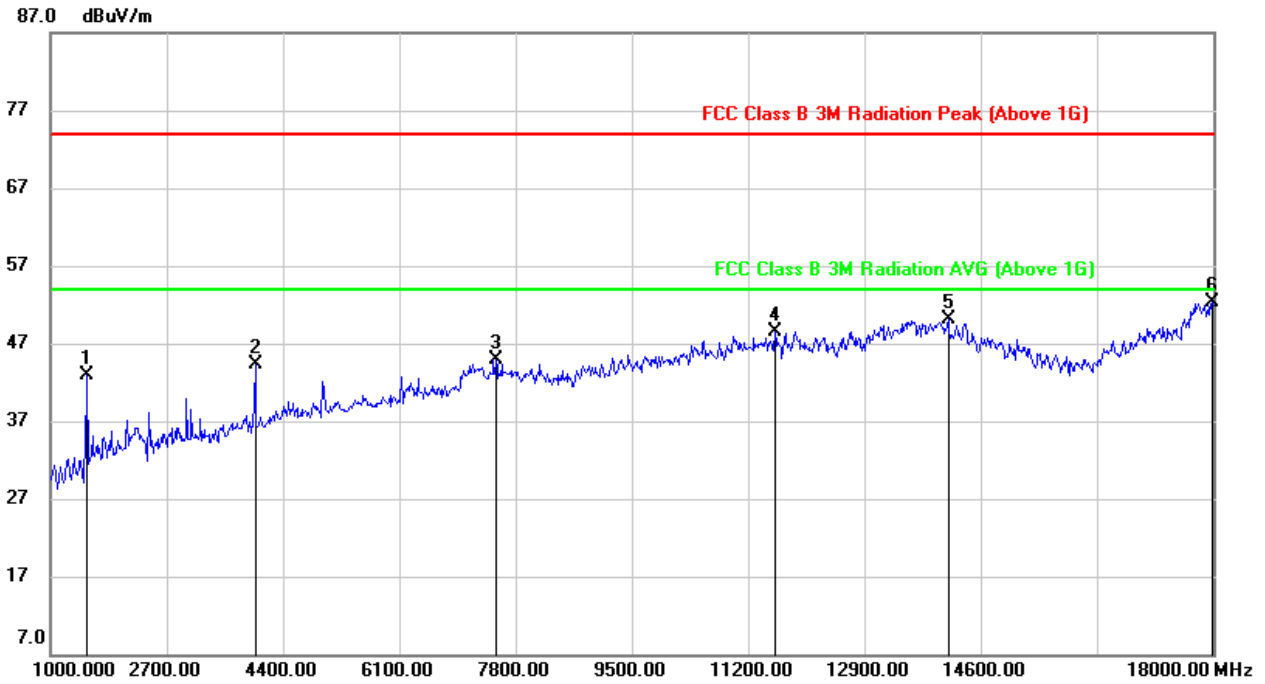

No.	Frequency (MHz)	Reading (dBuV)	Correct (dB/m)	Result (dBuV/m)	Limit (dBuV/m)	Margin (dB)	Remark
1	1527.000	55.63	-12.75	42.88	74.00	-31.12	peak
2	3992.000	48.90	-4.54	44.36	74.00	-29.64	peak
3	7511.000	38.25	6.75	45.00	74.00	-29.00	peak
4	11591.000	34.11	14.36	48.47	74.00	-25.53	peak
5	14124.000	31.66	18.40	50.06	74.00	-23.94	peak
6	17983.000	27.44	24.81	52.25	74.00	-21.75	peak

Note: 1. Measurement = Reading Level + Correct Factor.  
 2. If Peak Result complies with AV limit, AV Result is deemed to comply with AV limit.  
 3. Peak: Peak detector.



**HARMONICS AND SPURIOUS EMISSIONS 1G~18GHz (MIDDLE CHANNEL, VERTICAL)**

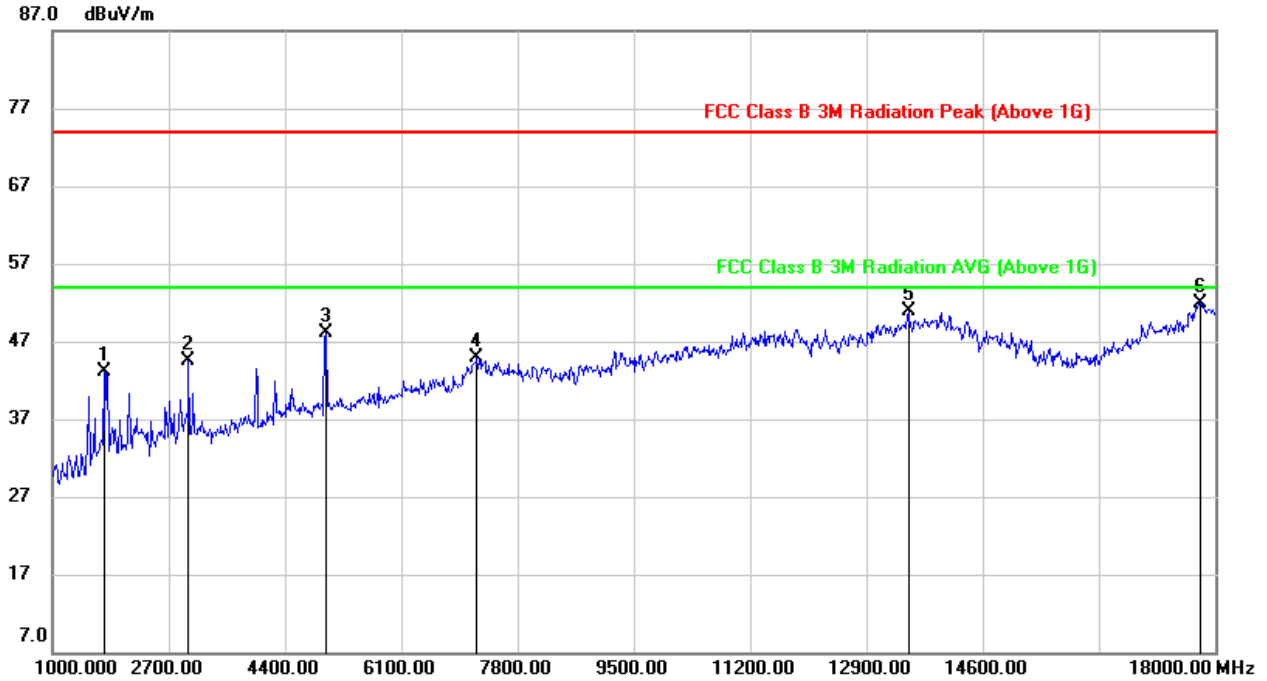

No.	Frequency (MHz)	Reading (dBuV)	Correct (dB/m)	Result (dBuV/m)	Limit (dBuV/m)	Margin (dB)	Remark
1	1748.000	54.91	-11.90	43.01	74.00	-30.99	peak
2	2989.000	51.79	-7.29	44.50	74.00	-29.50	peak
3	4995.000	48.85	-0.78	48.07	74.00	-25.93	peak
4	7205.000	38.41	6.43	44.84	74.00	-29.16	peak
5	13512.000	32.31	18.64	50.95	74.00	-23.05	peak
6	17779.000	27.61	24.36	51.97	74.00	-22.03	peak

Note: 1. Measurement = Reading Level + Correct Factor.  
 2. If Peak Result complies with AV limit, AV Result is deemed to comply with AV limit.  
 3. Peak: Peak detector.



**HARMONICS AND SPURIOUS EMISSIONS 1G~18GHz (HIGH CHANNEL, HORIZONTAL)**

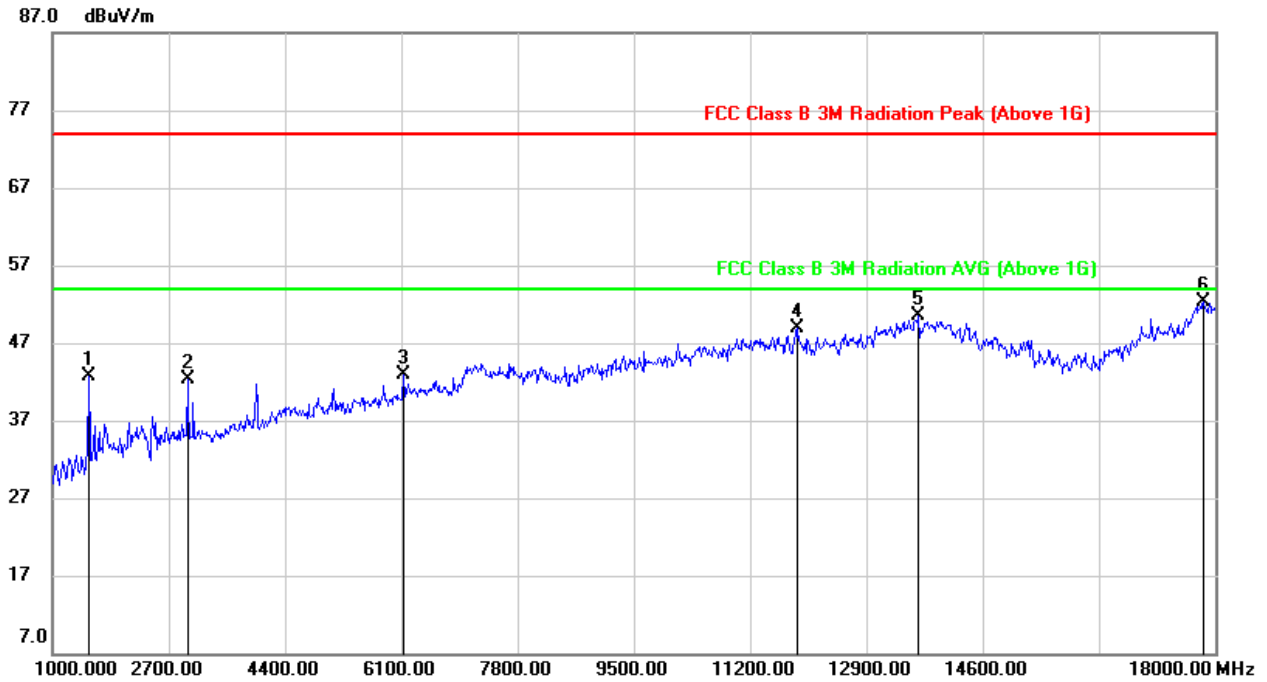

No.	Frequency (MHz)	Reading (dBuV)	Correct (dB/m)	Result (dBuV/m)	Limit (dBuV/m)	Margin (dB)	Remark
1	1527.000	55.51	-12.75	42.76	74.00	-31.24	peak
2	2972.000	49.51	-7.28	42.23	74.00	-31.77	peak
3	6134.000	40.62	2.37	42.99	74.00	-31.01	peak
4	11897.000	33.71	15.19	48.90	74.00	-25.10	peak
5	13665.000	32.06	18.44	50.50	74.00	-23.50	peak
6	17830.000	28.09	24.25	52.34	74.00	-21.66	peak

Note: 1. Measurement = Reading Level + Correct Factor.  
 2. If Peak Result complies with AV limit, AV Result is deemed to comply with AV limit.  
 3. Peak: Peak detector.



**HARMONICS AND SPURIOUS EMISSIONS 1G~18GHz (HIGH CHANNEL, VERTICAL)**

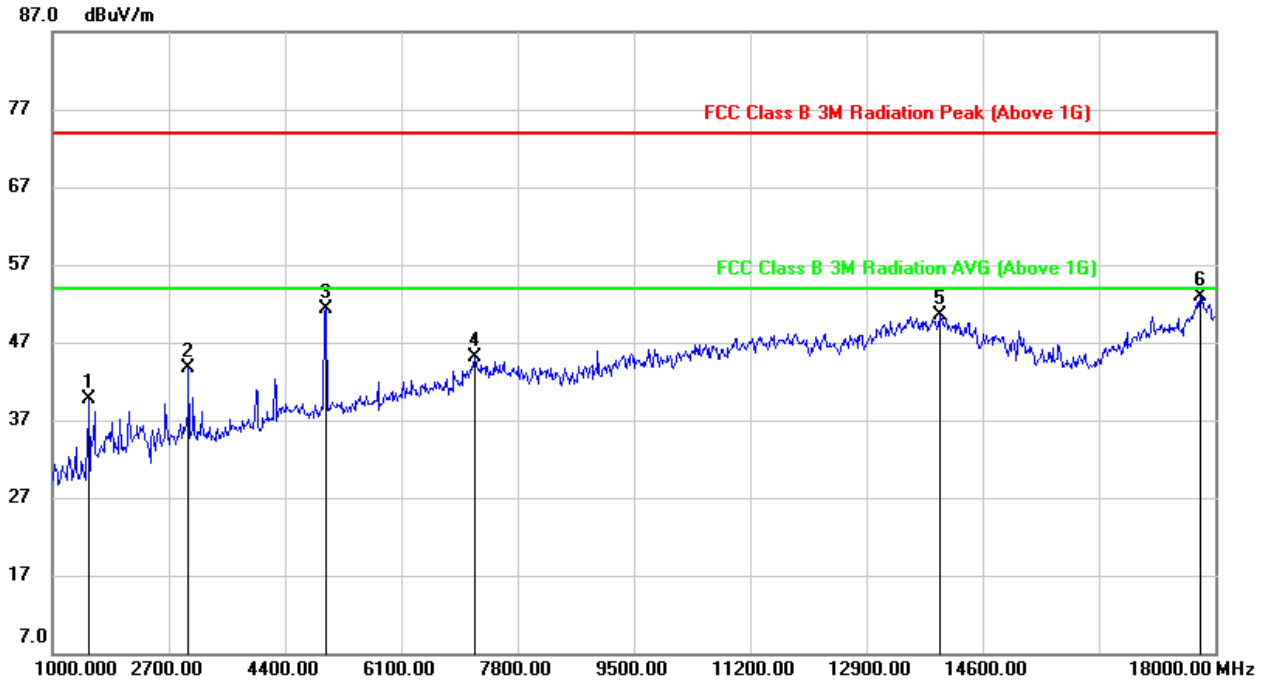

No.	Frequency (MHz)	Reading (dBuV)	Correct (dB/m)	Result (dBuV/m)	Limit (dBuV/m)	Margin (dB)	Remark
1	1527.000	52.35	-12.74	39.61	74.00	-34.39	peak
2	2989.000	51.06	-7.29	43.77	74.00	-30.23	peak
3	4995.000	52.15	-0.78	51.37	74.00	-22.63	peak
4	7171.000	38.73	6.46	45.19	74.00	-28.81	peak
5	13971.000	31.82	18.62	50.44	74.00	-23.56	peak
6	17779.000	28.56	24.36	52.92	74.00	-21.08	peak

Note: 1. Measurement = Reading Level + Correct Factor.  
 2. If Peak Result complies with AV limit, AV Result is deemed to comply with AV limit.  
 3. Peak: Peak detector.



OFDM 20MHz Bandwidth Mode

**HARMONICS AND SPURIOUS EMISSIONS 1G~18GHz (LOW CHANNEL, HORIZONTAL)**

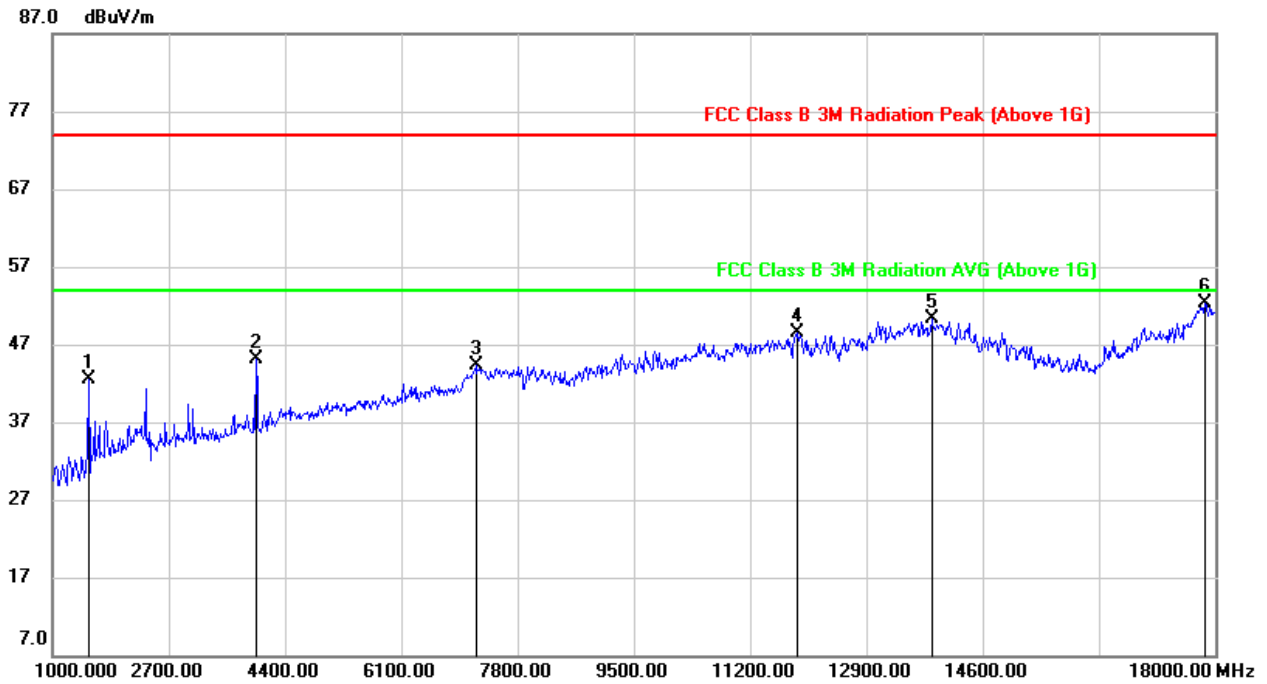

No.	Frequency (MHz)	Reading (dBuV)	Correct (dB/m)	Result (dBuV/m)	Limit (dBuV/m)	Margin (dB)	Remark
1	1527.000	55.23	-12.75	42.48	74.00	-31.52	peak
2	3975.000	49.73	-4.54	45.19	74.00	-28.81	peak
3	7188.000	37.87	6.34	44.21	74.00	-29.79	peak
4	11897.000	33.23	15.19	48.42	74.00	-25.58	peak
5	13852.000	31.70	18.59	50.29	74.00	-23.71	peak
6	17847.000	27.99	24.25	52.24	74.00	-21.76	peak

Note: 1. Measurement = Reading Level + Correct Factor.  
 2. If Peak Result complies with AV limit, AV Result is deemed to comply with AV limit.  
 3. Peak: Peak detector.



**HARMONICS AND SPURIOUS EMISSIONS 1G~18GHz (LOW CHANNEL, VERTICAL)**

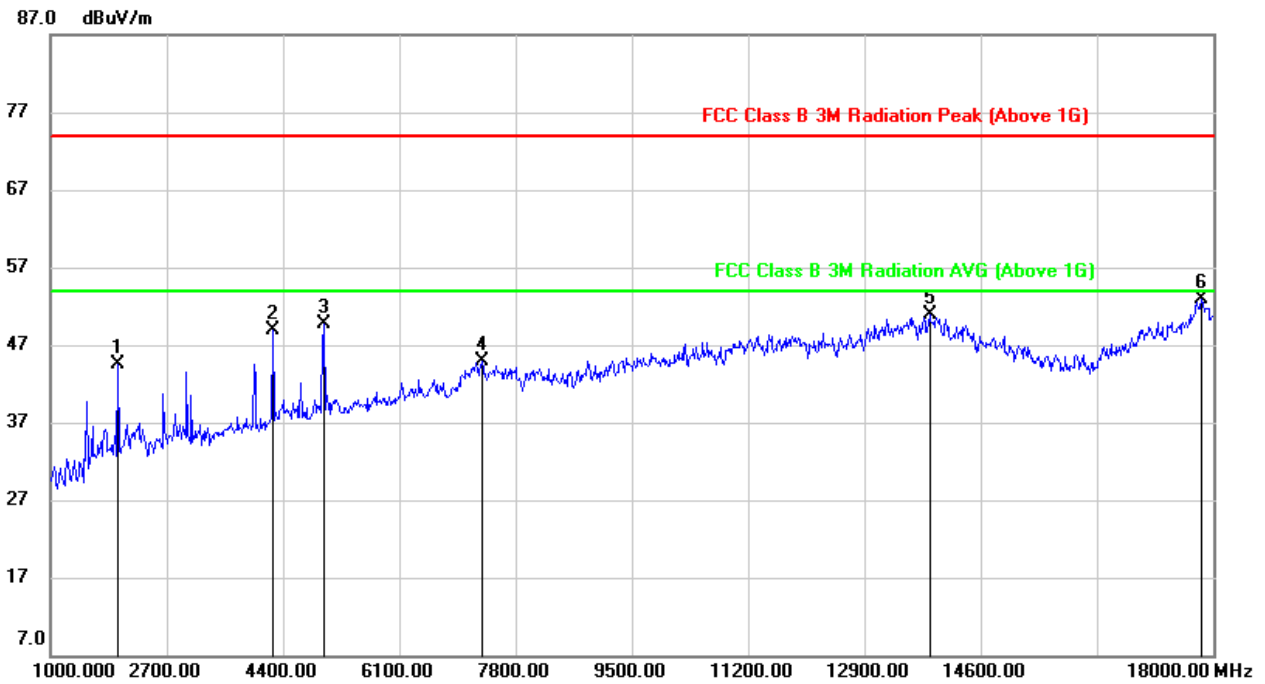

No.	Frequency (MHz)	Reading (dBuV)	Correct (dB/m)	Result (dBuV/m)	Limit (dBuV/m)	Margin (dB)	Remark
1	1986.000	55.85	-11.28	44.57	74.00	-29.43	peak
2	4247.000	52.24	-3.35	48.89	74.00	-25.11	peak
3	4995.000	50.41	-0.78	49.63	74.00	-24.37	peak
4	7307.000	38.58	6.40	44.98	74.00	-29.02	peak
5	13852.000	32.09	18.79	50.88	74.00	-23.12	peak
6	17830.000	28.69	24.17	52.86	74.00	-21.14	peak

Note: 1. Measurement = Reading Level + Correct Factor.  
 2. If Peak Result complies with AV limit, AV Result is deemed to comply with AV limit.  
 3. Peak: Peak detector.



**HARMONICS AND SPURIOUS EMISSIONS 1G~18GHz (MIDDLE CHANNEL, HORIZONTAL)**

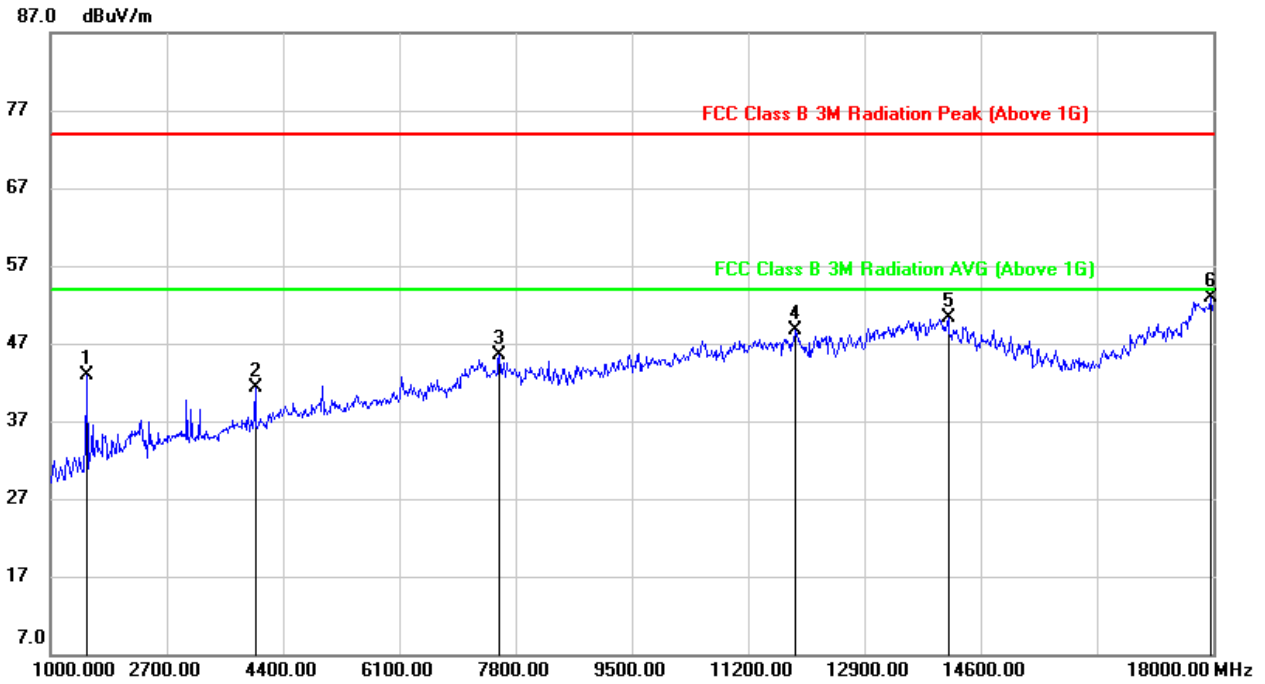

No.	Frequency (MHz)	Reading (dBuV)	Correct (dB/m)	Result (dBuV/m)	Limit (dBuV/m)	Margin (dB)	Remark
1	1527.000	55.66	-12.75	42.91	74.00	-31.09	peak
2	3992.000	45.76	-4.54	41.22	74.00	-32.78	peak
3	7562.000	38.79	6.64	45.43	74.00	-28.57	peak
4	11897.000	33.53	15.19	48.72	74.00	-25.28	peak
5	14124.000	31.83	18.40	50.23	74.00	-23.77	peak
6	17966.000	28.13	24.80	52.93	74.00	-21.07	peak

Note: 1. Measurement = Reading Level + Correct Factor.  
 2. If Peak Result complies with AV limit, AV Result is deemed to comply with AV limit.  
 3. Peak: Peak detector.





**HARMONICS AND SPURIOUS EMISSIONS 1G~18GHz (MIDDLE CHANNEL, VERTICAL)**

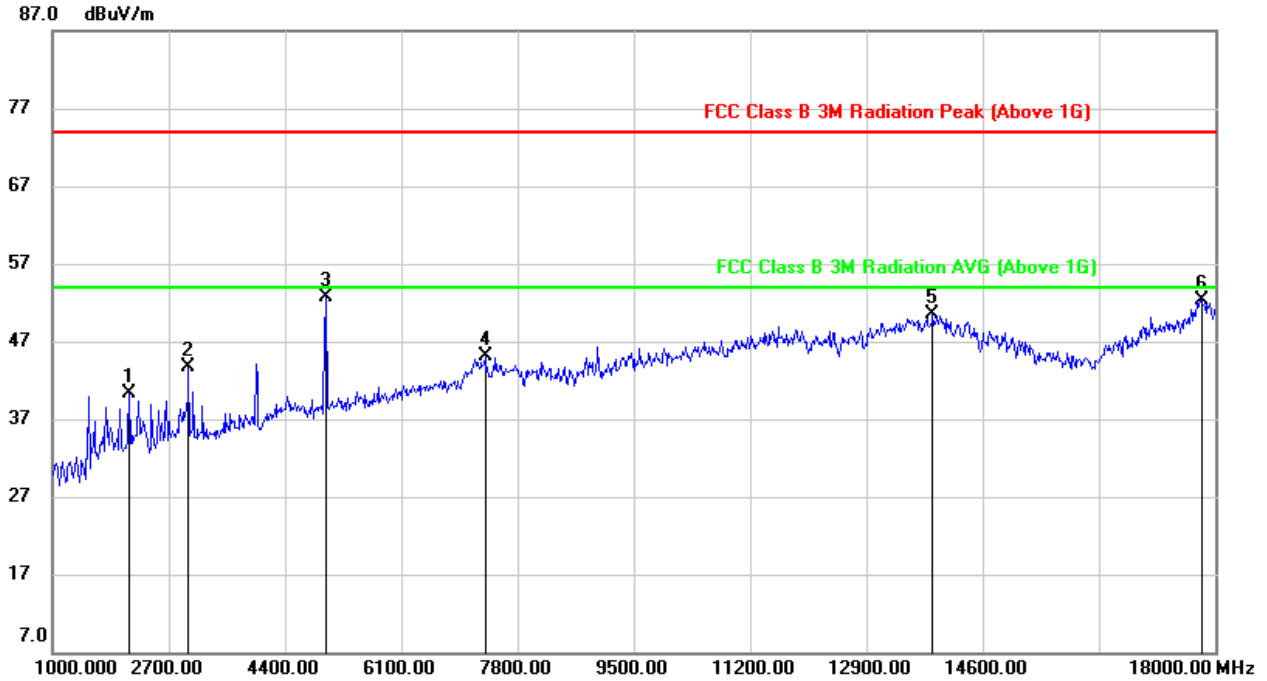

No.	Frequency (MHz)	Reading (dBuV)	Correct (dB/m)	Result (dBuV/m)	Limit (dBuV/m)	Margin (dB)	Remark
1	2122.000	50.40	-10.03	40.37	74.00	-33.63	peak
2	2989.000	51.04	-7.29	43.75	74.00	-30.25	peak
3	4995.000	53.40	-0.78	52.62	74.00	-21.38	peak
4	7324.000	38.82	6.24	45.06	74.00	-28.94	peak
5	13869.000	31.83	18.77	50.60	74.00	-23.40	peak
6	17796.000	27.68	24.59	52.27	74.00	-21.73	peak

Note: 1. Measurement = Reading Level + Correct Factor.  
 2. If Peak Result complies with AV limit, AV Result is deemed to comply with AV limit.  
 3. Peak: Peak detector.



**HARMONICS AND SPURIOUS EMISSIONS 1G~18GHz (HIGH CHANNEL, HORIZONTAL)**

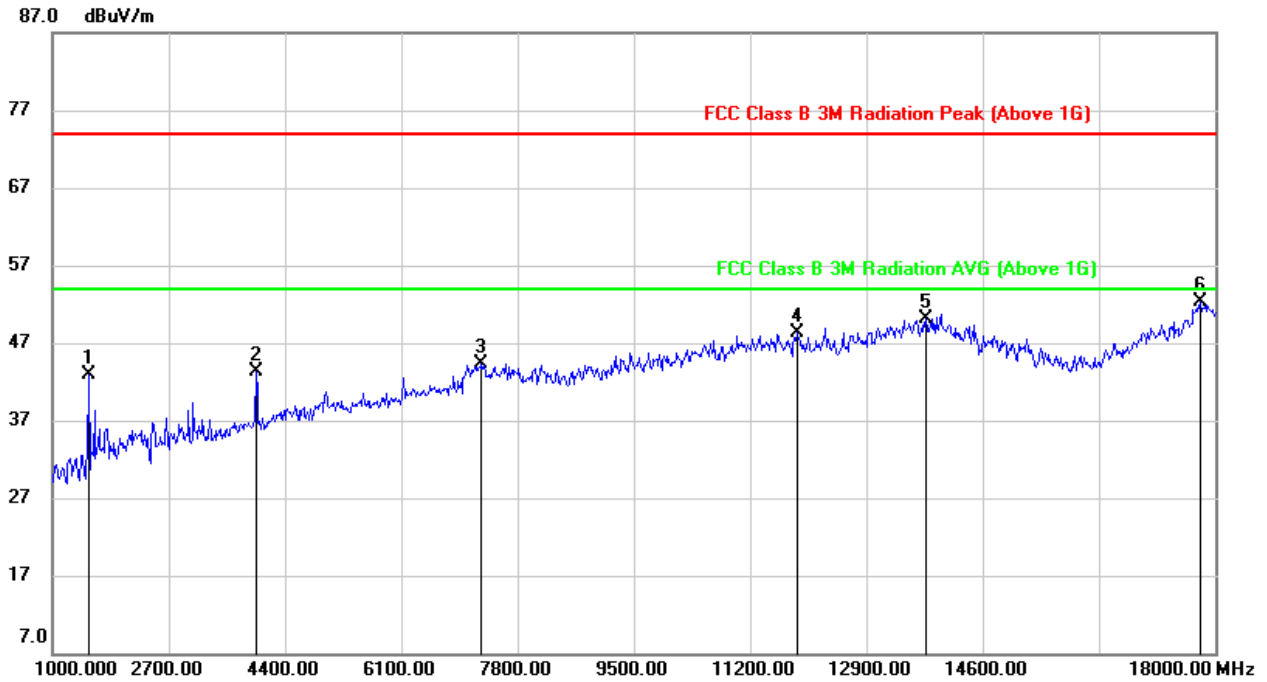

No.	Frequency (MHz)	Reading (dBuV)	Correct (dB/m)	Result (dBuV/m)	Limit (dBuV/m)	Margin (dB)	Remark
1	1527.000	55.62	-12.75	42.87	74.00	-31.13	peak
2	3975.000	47.91	-4.54	43.37	74.00	-30.63	peak
3	7273.000	37.80	6.46	44.26	74.00	-29.74	peak
4	11880.000	33.53	14.84	48.37	74.00	-25.63	peak
5	13767.000	31.47	18.66	50.13	74.00	-23.87	peak
6	17779.000	28.34	23.96	52.30	74.00	-21.70	peak

Note: 1. Measurement = Reading Level + Correct Factor.  
 2. If Peak Result complies with AV limit, AV Result is deemed to comply with AV limit.  
 3. Peak: Peak detector.



**HARMONICS AND SPURIOUS EMISSIONS 1G~18GHz (HIGH CHANNEL, VERTICAL)**

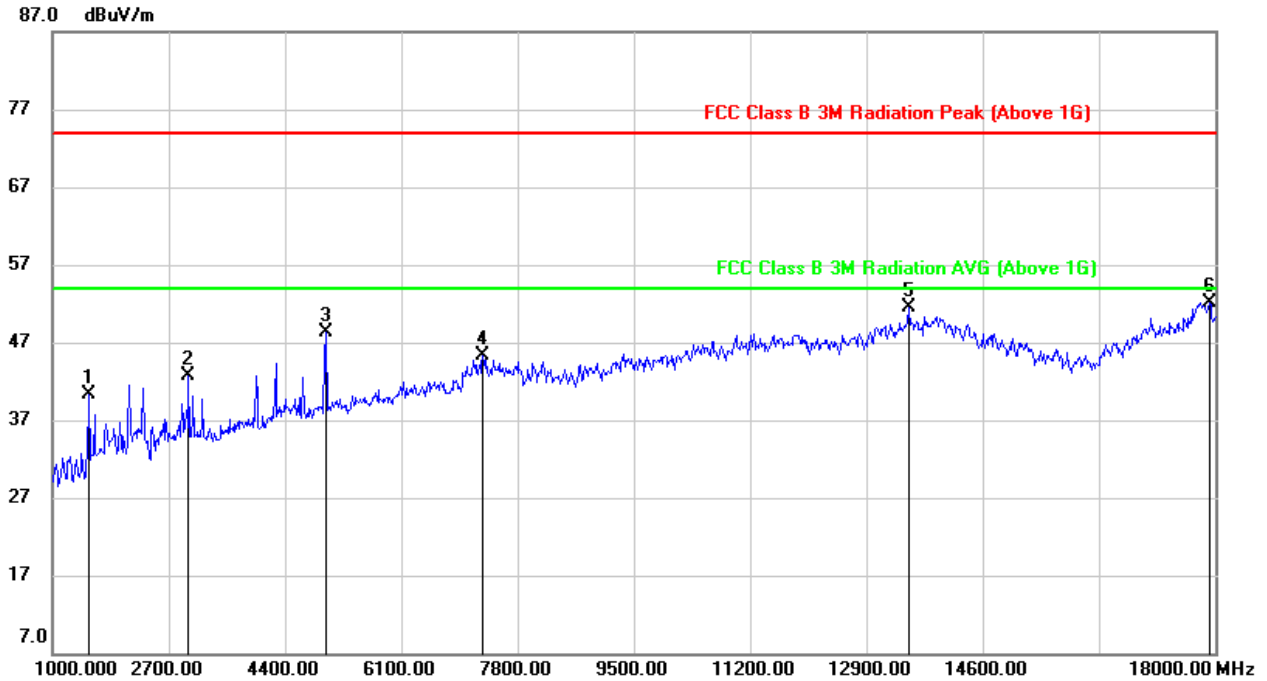

No.	Frequency (MHz)	Reading (dBuV)	Correct (dB/m)	Result (dBuV/m)	Limit (dBuV/m)	Margin (dB)	Remark
1	1527.000	53.12	-12.74	40.38	74.00	-33.62	peak
2	2989.000	49.96	-7.29	42.67	74.00	-31.33	peak
3	4995.000	49.02	-0.78	48.24	74.00	-25.76	peak
4	7290.000	38.79	6.44	45.23	74.00	-28.77	peak
5	13512.000	32.81	18.64	51.45	74.00	-22.55	peak
6	17915.000	28.06	24.07	52.13	74.00	-21.87	peak

Note: 1. Measurement = Reading Level + Correct Factor.  
 2. If Peak Result complies with AV limit, AV Result is deemed to comply with AV limit.  
 3. Peak: Peak detector.

Note: EUT in each of three orthogonal axis emissions had been tested, but only the worst case (X axis) data recorded in the report.



### 8.6. SIMULTANEOUS TRANSMISSION EVALUATION WORST CASE

1G ~ 3GHz (OFDM 20MHZ LOW CHANNEL, 2GFSK LOW CHANNEL, 2.4G WIFI N HT 20 LOW CHANNEL, HORIZONTAL)

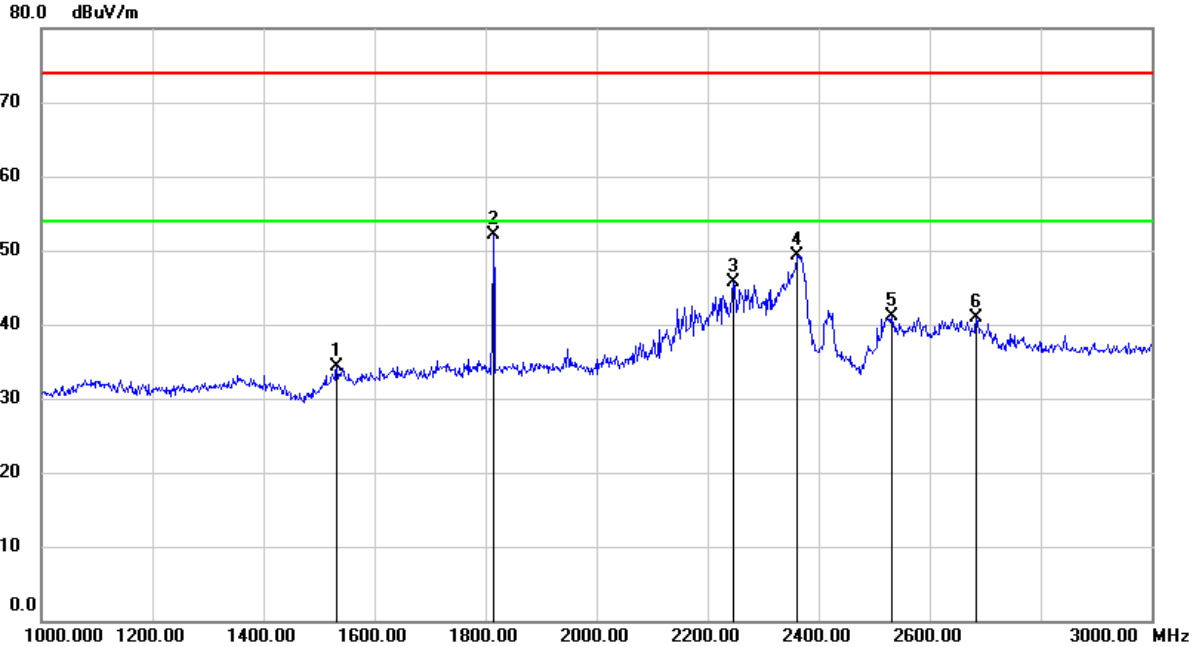

No.	Frequency (MHz)	Reading (dBuV)	Correct (dB/m)	Result (dBuV/m)	Limit (dBuV/m)	Margin (dB)	Remark
1	1532.000	46.53	-12.30	34.23	74.00	-39.77	peak
2	1814.000	63.19	-11.06	52.13	74.00	-21.87	peak
3	2246.000	53.39	-7.65	45.74	74.00	-28.26	peak
4	2360.000	57.19	-7.82	49.37	74.00	-24.63	peak
5	2532.000	49.50	-8.37	41.13	74.00	-32.87	peak
6	2684.000	48.65	-7.68	40.97	74.00	-33.03	peak

- Note: 1. Measurement = Reading Level + Correct Factor.  
 2. If Peak Result complies with AV limit, AV Result is deemed to comply with AV limit.  
 3. Peak: Peak detector.



**1G ~ 3GHz (OFDM 20MHZ LOW CHANNEL, 2GFSK LOW CHANNEL, 2.4G WIFI N HT 20 LOW CHANNEL, VERTICAL)**

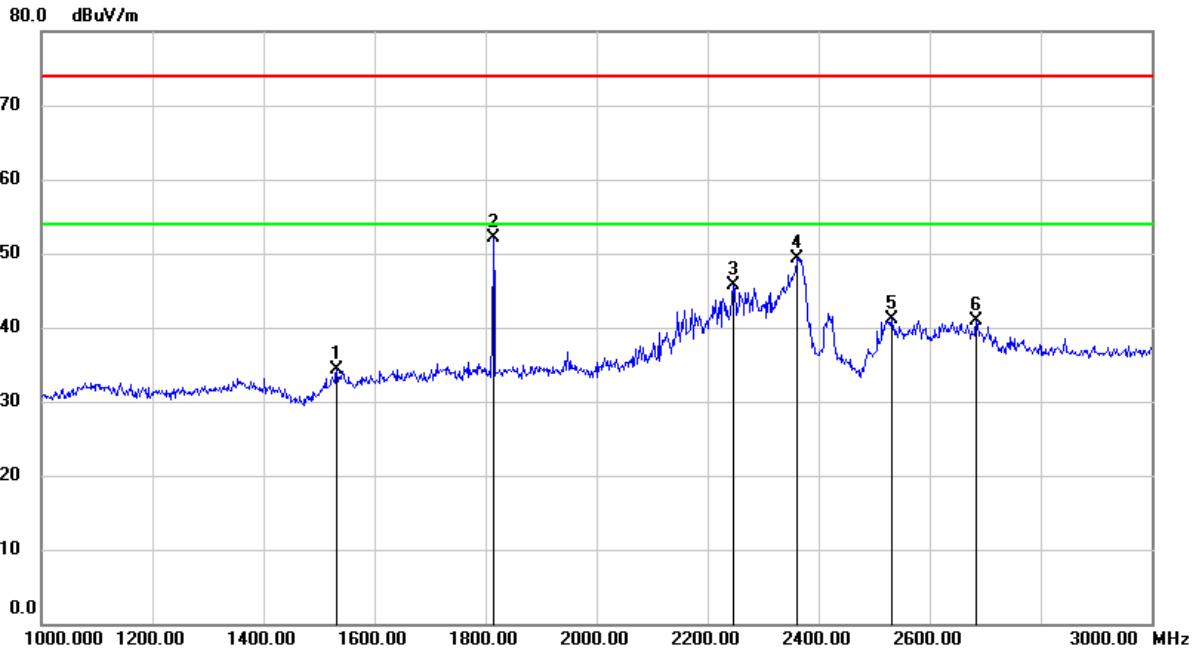

No.	Frequency (MHz)	Reading (dBuV)	Correct (dB/m)	Result (dBuV/m)	Limit (dBuV/m)	Margin (dB)	Remark
1	1532.000	46.53	-12.30	34.23	74.00	-39.77	peak
2	1814.000	63.19	-11.06	52.13	74.00	-21.87	peak
3	2246.000	53.39	-7.65	45.74	74.00	-28.26	peak
4	2360.000	57.19	-7.82	49.37	74.00	-24.63	peak
5	2532.000	49.50	-8.37	41.13	74.00	-32.87	peak
6	2684.000	48.65	-7.68	40.97	74.00	-33.03	peak

- Note: 1. Measurement = Reading Level + Correct Factor.  
 2. If Peak Result complies with AV limit, AV Result is deemed to comply with AV limit.  
 3. Peak: Peak detector.



**3G ~ 18GHz (OFDM 20MHZ LOW CHANNEL, 2GFSK LOW CHANNEL, 2.4G WIFI N HT 20 LOW CHANNEL, HORIZONTAL)**

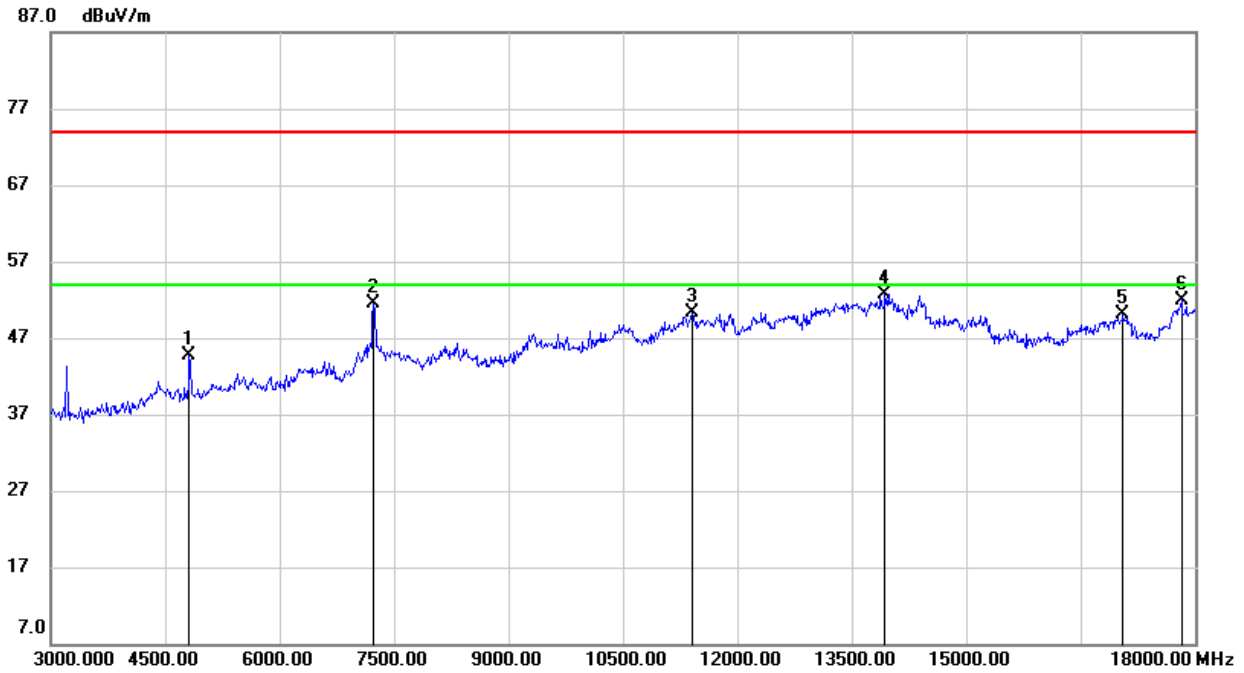

No.	Frequency (MHz)	Reading (dBuV)	Correct (dB/m)	Result (dBuV/m)	Limit (dBuV/m)	Margin (dB)	Remark
1	4815.000	45.07	-0.38	44.69	74.00	-29.31	peak
2	7230.000	43.74	7.81	51.55	74.00	-22.45	peak
3	11415.000	34.59	15.76	50.35	74.00	-23.65	peak
4	13935.000	32.09	20.67	52.76	74.00	-21.24	peak
5	17055.000	27.84	22.17	50.01	74.00	-23.99	peak
6	17820.000	25.52	26.48	52.00	74.00	-22.00	peak

Note: 1. Measurement = Reading Level + Correct Factor.  
 2. If Peak Result complies with AV limit, AV Result is deemed to comply with AV limit.  
 3. Peak: Peak detector.



**3G ~ 18GHz (OFDM 20MHZ LOW CHANNEL, 2GFSK LOW CHANNEL, 2.4G WIFI N HT 20 LOW CHANNEL, VERTICAL)**

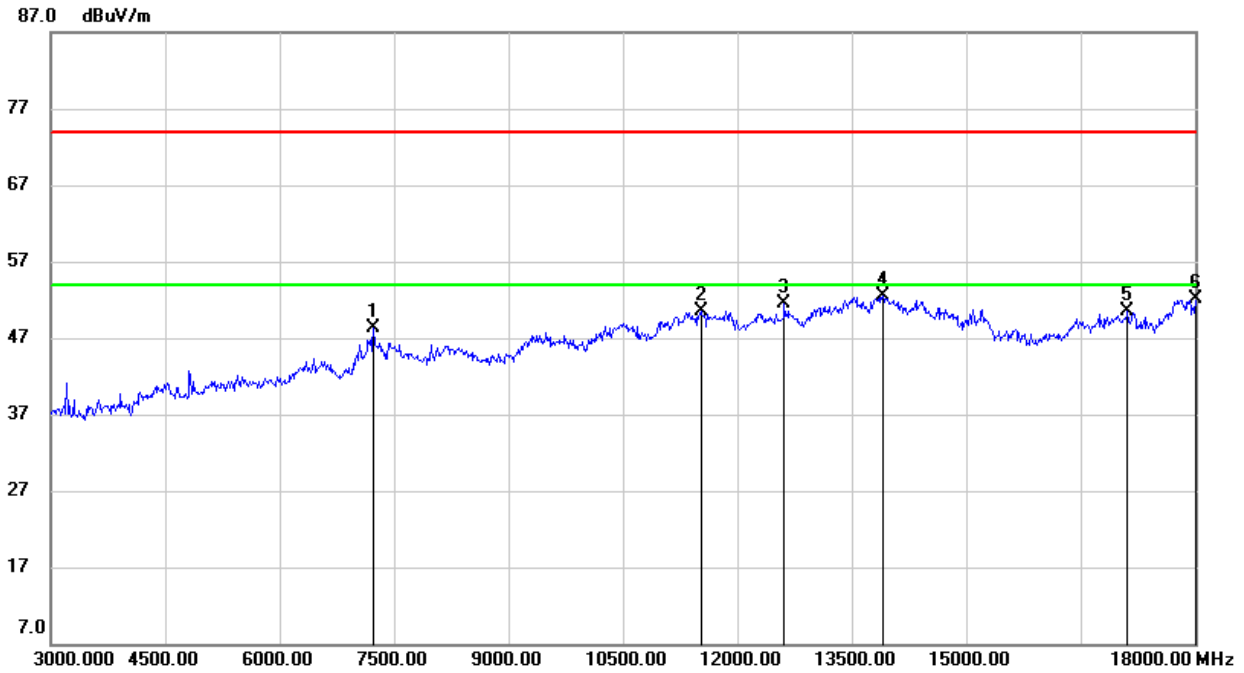

No.	Frequency (MHz)	Reading (dBuV)	Correct (dB/m)	Result (dBuV/m)	Limit (dBuV/m)	Margin (dB)	Remark
1	7230.000	40.60	7.79	48.39	74.00	-25.61	peak
2	11520.000	34.21	16.25	50.46	74.00	-23.54	peak
3	12615.000	34.05	17.39	51.44	74.00	-22.56	peak
4	13905.000	31.58	20.84	52.42	74.00	-21.58	peak
5	17115.000	27.66	22.85	50.51	74.00	-23.49	peak
6	18000.000	25.36	26.66	52.02	74.00	-21.98	peak

Note: 1. Measurement = Reading Level + Correct Factor.  
 2. If Peak Result complies with AV limit, AV Result is deemed to comply with AV limit.  
 3. Peak: Peak detector.



**1G ~ 3GHz (OFDM 20MHZ LOW CHANNEL, 2GFSK LOW CHANNEL, 5.2G WIFI A MIDDLE CHANNEL, HORIZONTAL)**

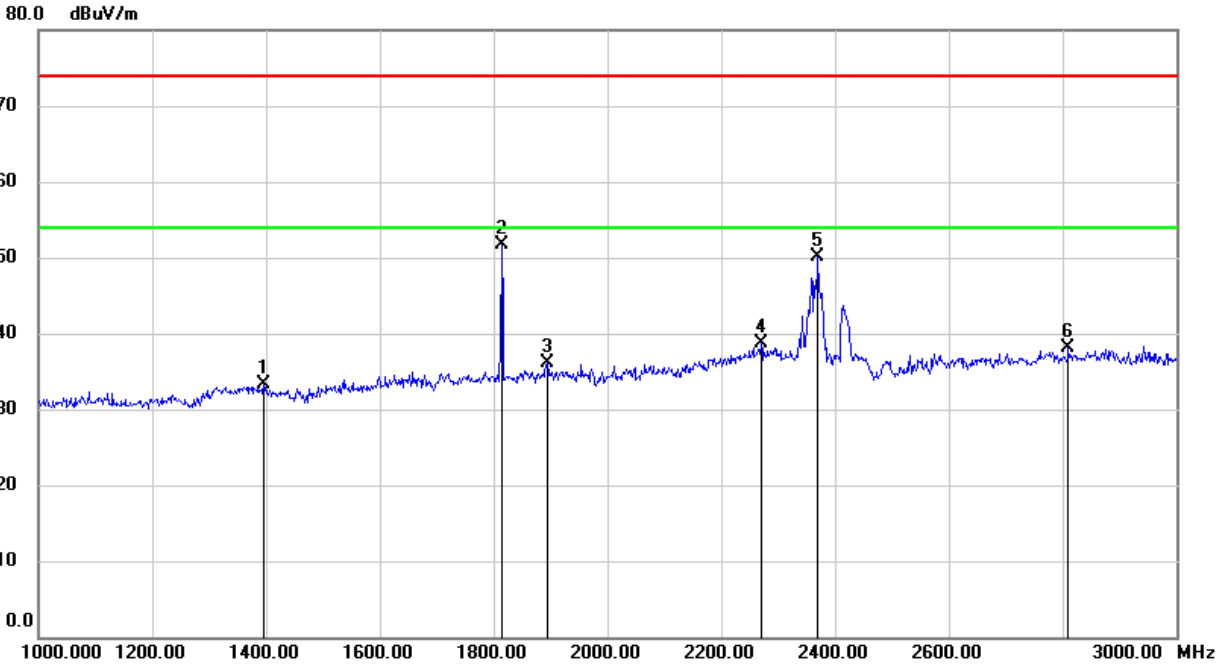

No.	Frequency (MHz)	Reading (dBuV)	Correct (dB/m)	Result (dBuV/m)	Limit (dBuV/m)	Margin (dB)	Remark
1	1396.000	45.45	-12.09	33.36	74.00	-40.64	peak
2	1814.000	62.68	-11.06	51.62	74.00	-22.38	peak
3	1894.000	46.95	-10.76	36.19	74.00	-37.81	peak
4	2270.000	46.21	-7.51	38.70	74.00	-35.30	peak
5	2370.000	57.99	-7.89	50.10	74.00	-23.90	peak
6	2810.000	44.93	-6.90	38.03	74.00	-35.97	peak

Note: 1. Measurement = Reading Level + Correct Factor.  
 2. If Peak Result complies with AV limit, AV Result is deemed to comply with AV limit.  
 3. Peak: Peak detector.





**1G ~ 3GHz (OFDM 20MHZ LOW CHANNEL, 2GFSK LOW CHANNEL, 5.2G WIFI A MIDDLE CHANNEL, VERTICAL)**

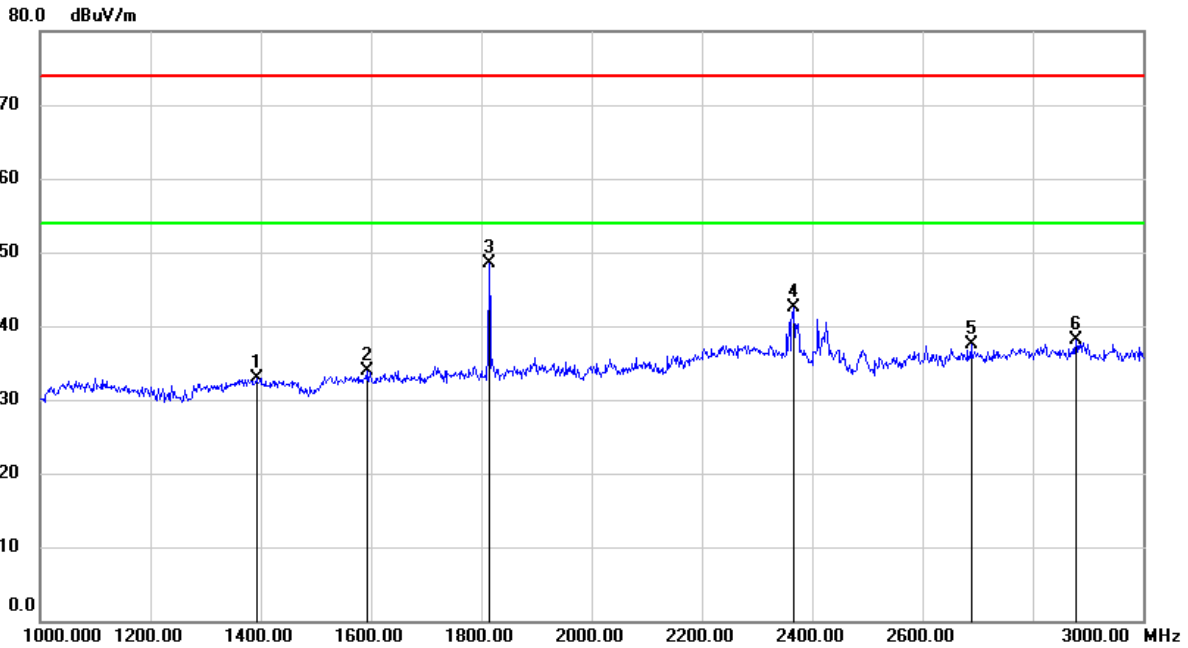

No.	Frequency (MHz)	Reading (dBuV)	Correct (dB/m)	Result (dBuV/m)	Limit (dBuV/m)	Margin (dB)	Remark
1	1392.000	45.43	-12.45	32.98	74.00	-41.02	peak
2	1592.000	45.96	-12.10	33.86	74.00	-40.14	peak
3	1814.000	59.57	-11.06	48.51	74.00	-25.49	peak
4	2366.000	50.29	-7.77	42.52	74.00	-31.48	peak
5	2688.000	45.11	-7.69	37.42	74.00	-36.58	peak
6	2878.000	44.76	-6.60	38.16	74.00	-35.84	peak

- Note: 1. Measurement = Reading Level + Correct Factor.  
 2. If Peak Result complies with AV limit, AV Result is deemed to comply with AV limit.  
 3. Peak: Peak detector.



**3G ~ 7GHz (OFDM 20MHZ LOW CHANNEL, 2GFSK LOW CHANNEL, 5.2G WIFI A MIDDLE CHANNEL, HORIZONTAL)**

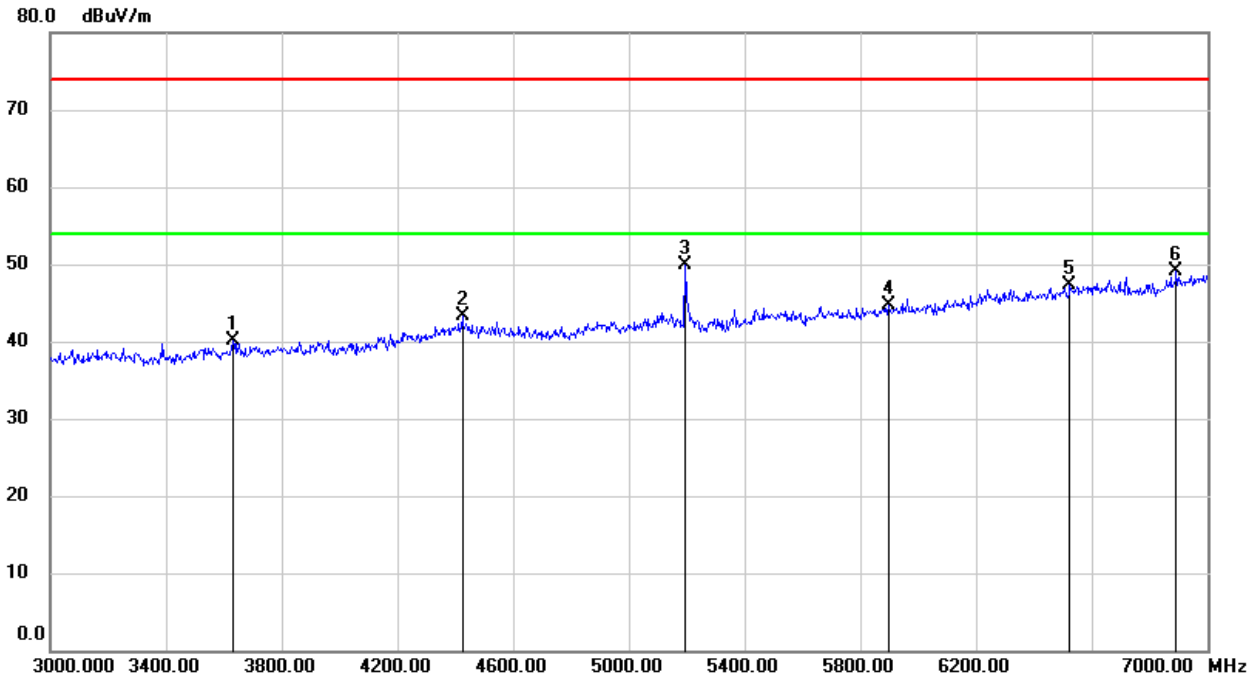

No.	Frequency (MHz)	Reading (dBuV)	Correct (dB/m)	Result (dBuV/m)	Limit (dBuV/m)	Margin (dB)	Remark
1	3632.000	43.96	-3.93	40.03	74.00	-33.97	peak
2	4424.000	44.13	-0.78	43.35	74.00	-30.65	peak
3	5192.000	48.64	1.27	49.91	74.00	-24.09	peak
4	5896.000	41.54	3.08	44.62	74.00	-29.38	peak
5	6524.000	42.13	5.09	47.22	74.00	-26.78	peak
6	6892.000	42.65	6.55	49.20	74.00	-24.80	peak

- Note: 1. Measurement = Reading Level + Correct Factor.  
 2. If Peak Result complies with AV limit, AV Result is deemed to comply with AV limit.  
 3. Peak: Peak detector.



**3G ~ 7GHz (OFDM 20MHZ LOW CHANNEL, 2GFSK LOW CHANNEL, 5.2G WIFI A MIDDLE CHANNEL, VERTICAL)**

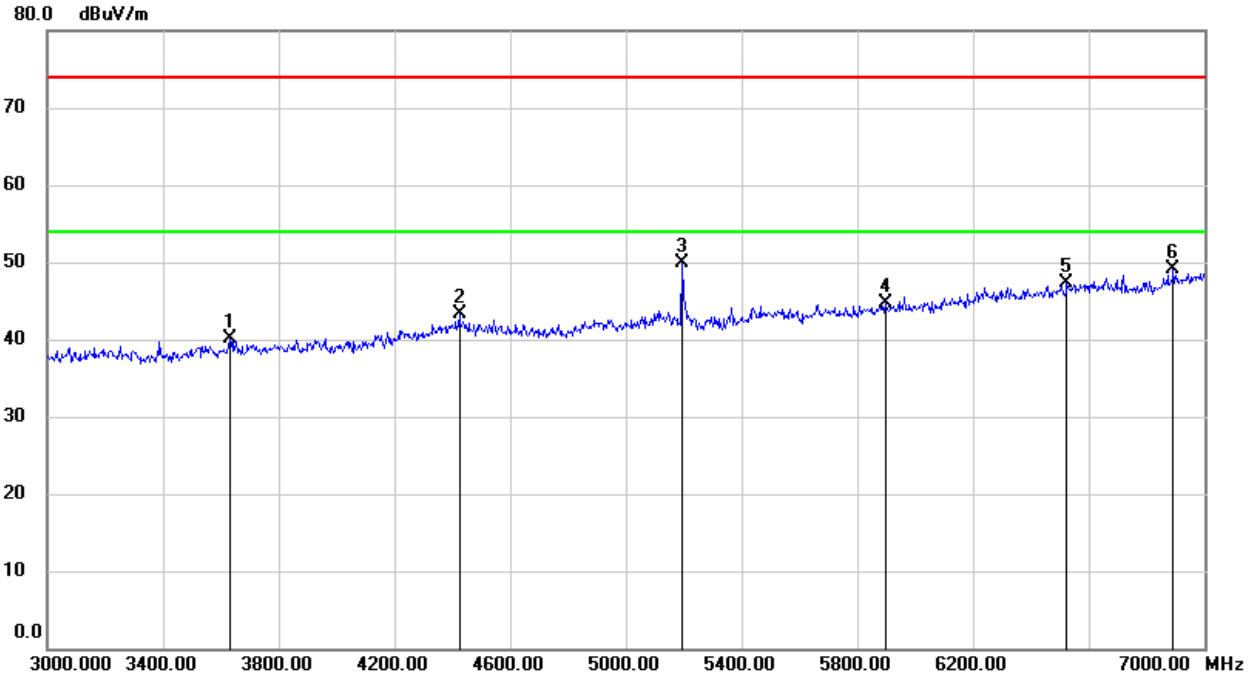

No.	Frequency (MHz)	Reading (dBuV)	Correct (dB/m)	Result (dBuV/m)	Limit (dBuV/m)	Margin (dB)	Remark
1	9684.000	35.93	11.39	47.32	74.00	-26.68	peak
2	10498.000	35.95	13.70	49.65	74.00	-24.35	peak
3	11400.000	35.01	15.69	50.70	74.00	-23.30	peak
4	13545.000	32.16	20.29	52.45	74.00	-21.55	peak
5	17043.000	28.93	22.12	51.05	74.00	-22.95	peak
6	17780.000	26.18	26.24	52.42	74.00	-21.58	peak

Note: 1. Measurement = Reading Level + Correct Factor.  
 2. If Peak Result complies with AV limit, AV Result is deemed to comply with AV limit.  
 3. Peak: Peak detector.



**7G ~ 18GHz (OFDM 20MHZ LOW CHANNEL, 2GFSK LOW CHANNEL, 5.2G WIFI A MIDDLE CHANNEL, HORIZONTAL)**

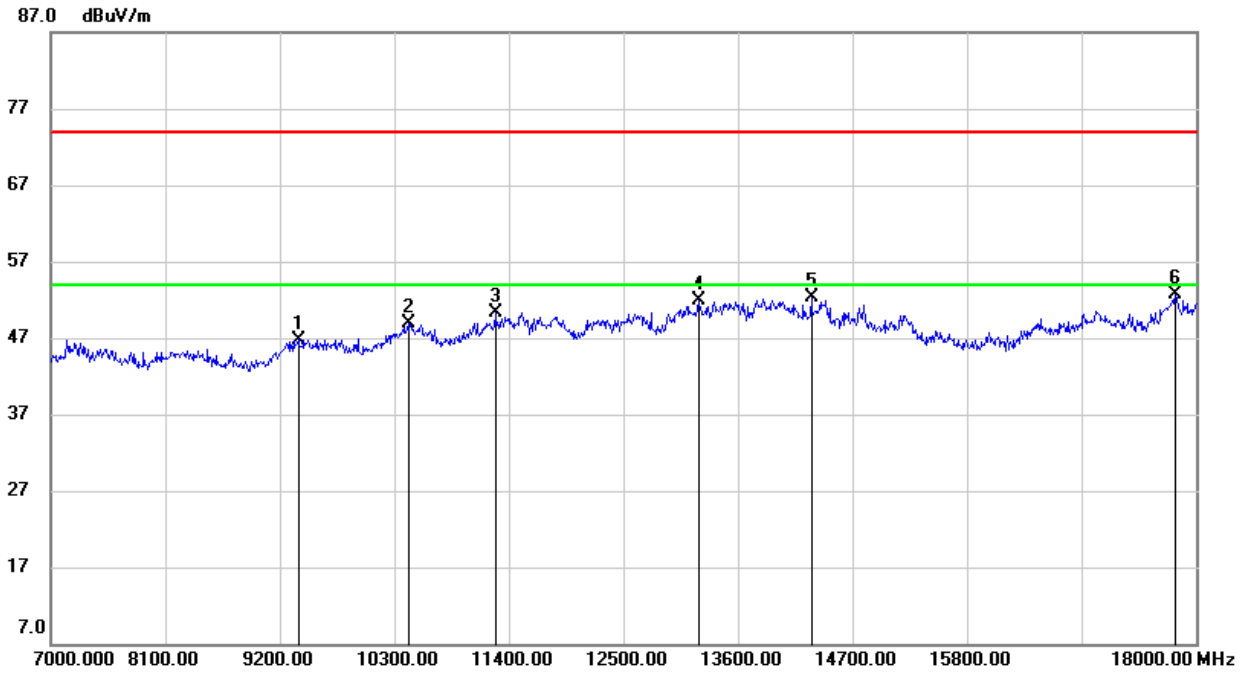

No.	Frequency (MHz)	Reading (dBuV)	Correct (dB/m)	Result (dBuV/m)	Limit (dBuV/m)	Margin (dB)	Remark
1	9376.000	35.92	10.88	46.80	74.00	-27.20	peak
2	10432.000	35.43	13.39	48.82	74.00	-25.18	peak
3	11268.000	35.07	15.25	50.32	74.00	-23.68	peak
4	13226.000	32.56	19.30	51.86	74.00	-22.14	peak
5	14304.000	32.30	20.03	52.33	74.00	-21.67	peak
6	17802.000	25.84	26.85	52.69	74.00	-21.31	peak

Note: 1. Measurement = Reading Level + Correct Factor.  
 2. If Peak Result complies with AV limit, AV Result is deemed to comply with AV limit.  
 3. Peak: Peak detector.



**7G ~ 18GHz (OFDM 20MHZ LOW CHANNEL, 2GFSK LOW CHANNEL, 5.2G WIFI A MIDDLE CHANNEL, VERTICAL)**

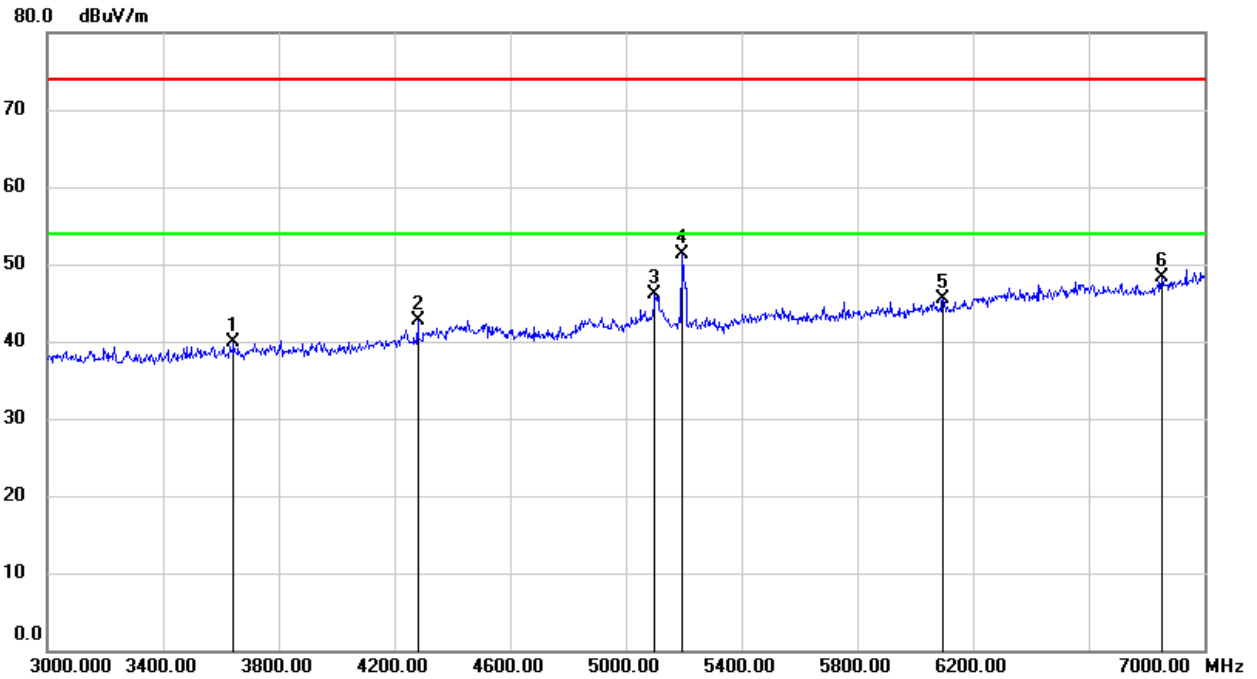

No.	Frequency (MHz)	Reading (dBuV)	Correct (dB/m)	Result (dBuV/m)	Limit (dBuV/m)	Margin (dB)	Remark
1	3644.000	43.70	-3.88	39.82	74.00	-34.18	peak
2	4280.000	44.40	-1.74	42.66	74.00	-31.34	peak
3	5100.000	45.06	1.05	46.11	74.00	-27.89	peak
4	5192.000	50.14	1.07	51.21	74.00	-22.79	peak
5	6096.000	41.94	3.48	45.42	74.00	-28.58	peak
6	6852.000	42.21	6.12	48.33	74.00	-25.67	peak

Note: 1. Measurement = Reading Level + Correct Factor.  
 2. If Peak Result complies with AV limit, AV Result is deemed to comply with AV limit.  
 3. Peak: Peak detector.



### 8.7. SPURIOUS EMISSIONS 18G ~ 26GHz (WORST-CASE CONFIGURATION)

#### SPURIOUS EMISSIONS 18GHz TO 26GHz (OFDM 20MHz LOW CHANNEL, HORIZONTAL)

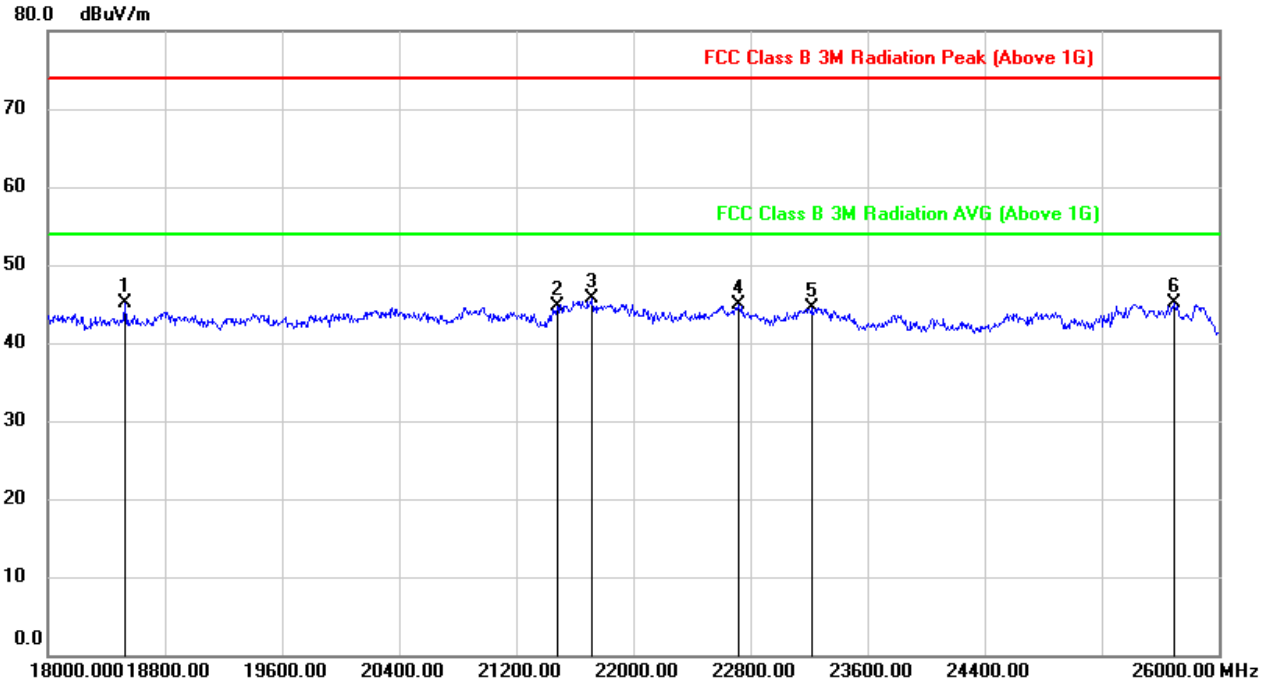

No.	Frequency (MHz)	Reading (dBuV)	Correct (dB/m)	Result (dBuV/m)	Limit (dBuV/m)	Margin (dB)	Remark
1	18528.000	50.41	-5.26	45.15	74.00	-28.85	peak
2	21480.000	49.45	-4.70	44.75	74.00	-29.25	peak
3	21720.000	50.11	-4.37	45.74	74.00	-28.26	peak
4	22720.000	48.59	-3.71	44.88	74.00	-29.12	peak
5	23224.000	47.92	-3.37	44.55	74.00	-29.45	peak
6	25696.000	46.01	-0.86	45.15	74.00	-28.85	peak

- Note: 1. Result Level = Read Level + Antenna Factor + Cable loss - PRM Factor.  
 2. If Peak Result complies with AV limit, AV Result is deemed to comply with AV limit.  
 3. Test setup: RBW: 1 MHz, VBW: 3 MHz, Sweep time: auto.



**SPURIOUS EMISSIONS 18GHz TO 26GHz (OFDM 20MHz LOW CHANNEL, VERTICAL)**

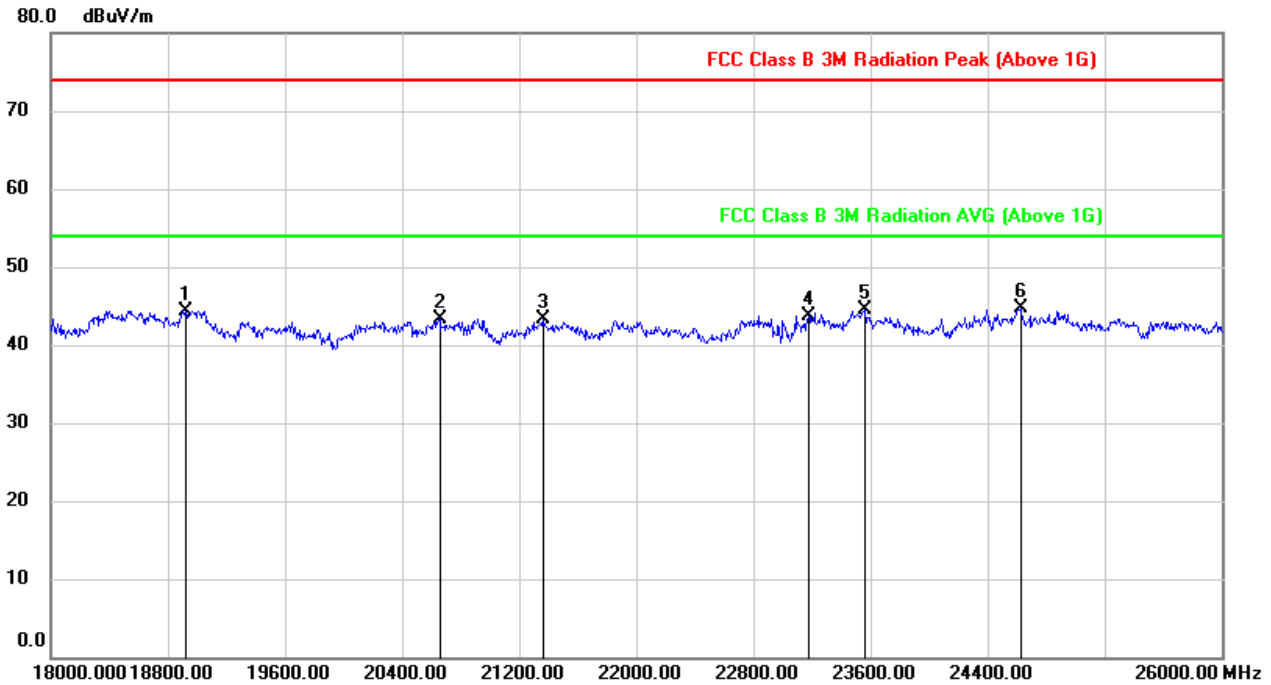

No.	Frequency (MHz)	Reading (dBuV)	Correct (dB/m)	Result (dBuV/m)	Limit (dBuV/m)	Margin (dB)	Remark
1	18920.000	49.67	-5.29	44.38	74.00	-29.62	peak
2	20656.000	48.59	-5.20	43.39	74.00	-30.61	peak
3	21360.000	48.02	-4.73	43.29	74.00	-30.71	peak
4	23176.000	47.03	-3.39	43.64	74.00	-30.36	peak
5	23560.000	47.71	-3.15	44.56	74.00	-29.44	peak
6	24624.000	46.99	-2.33	44.66	74.00	-29.34	peak

Note: 1. Result Level = Read Level + Antenna Factor + Cable loss - PRM Factor.  
 2. If Peak Result complies with AV limit, AV Result is deemed to comply with AV limit.  
 3. Test setup: RBW: 1 MHz, VBW: 3 MHz, Sweep time: auto.

Note: EUT in each of three orthogonal axis emissions had been tested, but only the worst case (X axis) data recorded in the report.

## 9. AC POWER LINE CONDUCTED EMISSIONS

### LIMITS

Please refer to FCC §15.207 (a) and RSS-Gen Clause 8.8.

FREQUENCY (MHz)	Class A (dBuV)		Class B (dBuV)	
	Quasi-peak	Average	Quasi-peak	Average
0.15 -0.5	79.00	66.00	66 - 56 *	56 - 46 *
0.50 -5.0	73.00	60.00	56.00	46.00
5.0 -30.0	73.00	60.00	60.00	50.00

### TEST SETUP AND PROCEDURE

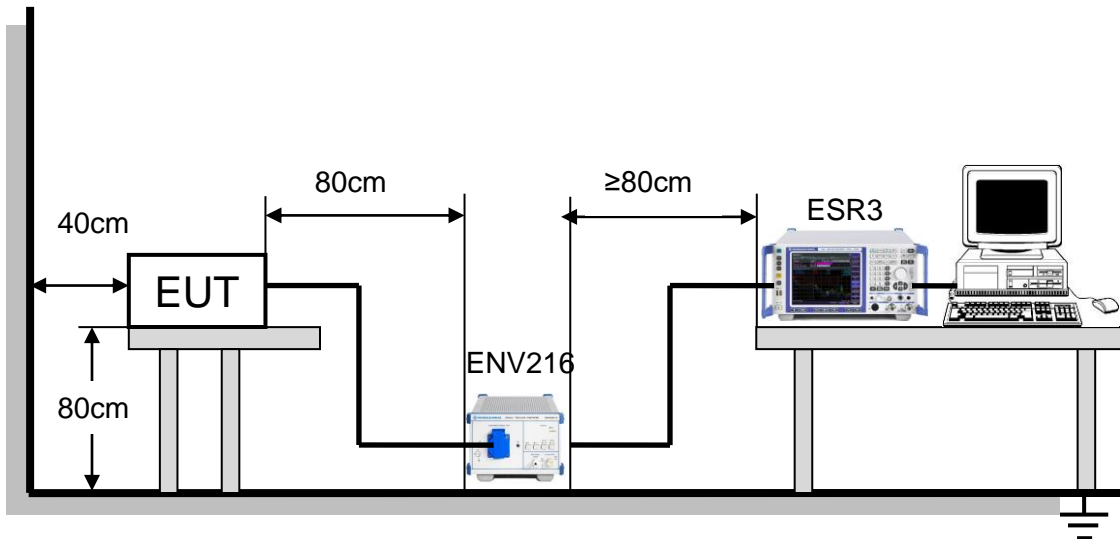

The EUT is put on a table of non-conducting material that is 0.8m high. The vertical conducting wall of shielding is located 40cm to the rear of the EUT. The power line of the EUT is connected to the AC mains through an Artificial Mains Network (A.M.N.). An EMI Measurement Receiver (R&S Test Receiver ESR3) is used to test the emissions from both sides of AC line. According to the requirements in Section 6.2 of ANSI C63.10-2013. Conducted emissions from the EUT measured in the frequency range between 0.15 MHz and 30MHz using CISPR Quasi-Peak and average detector mode. The bandwidth of EMI test receiver is set at 9kHz.

The arrangement of the equipment is installed to meet the standards and operating in a manner, which tends to maximize its emission characteristics in a normal application.





**TEST RESULTS (OFDM 20MHz LOW CHANNEL, WORST-CASE CONFIGURATION)**

**LINE N RESULTS**

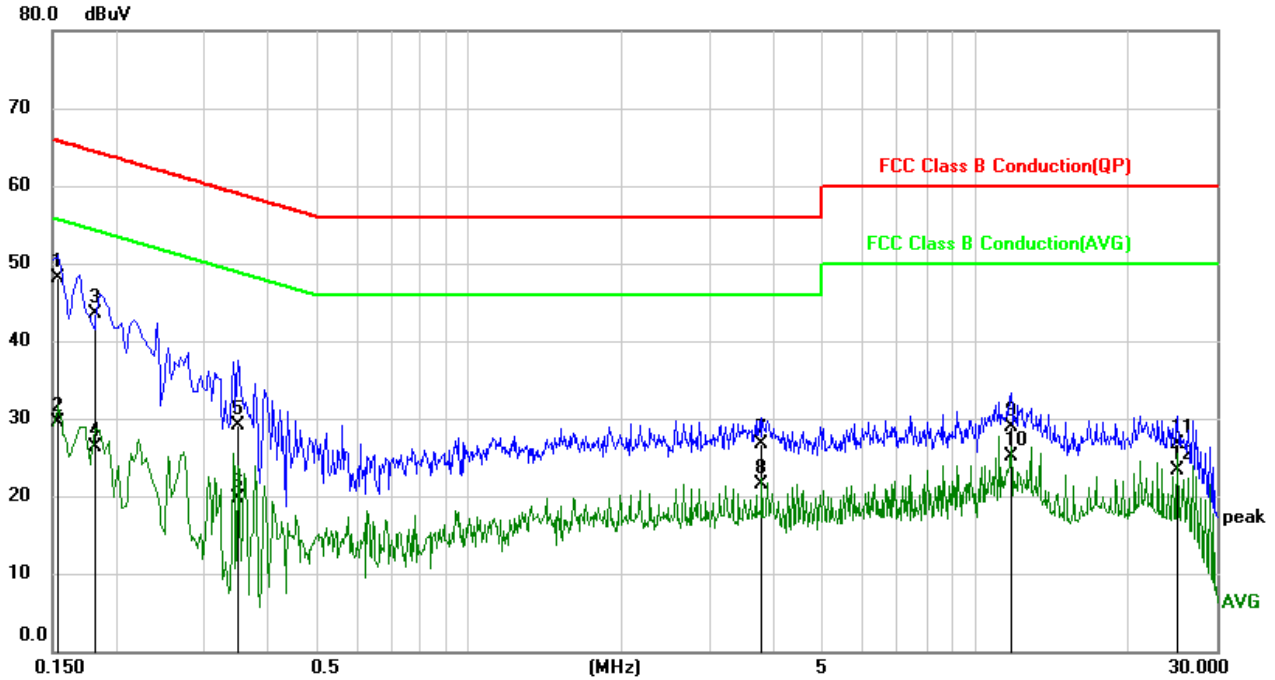

No.	Frequency (MHz)	Reading (dBuV)	Correct (dB)	Result (dBuV)	Limit (dBuV)	Margin (dB)	Remark
1	0.1525	38.44	9.62	48.06	65.86	-17.80	QP
2	0.1525	19.81	9.62	29.43	55.86	-26.43	AVG
3	0.1824	33.94	9.62	43.56	64.38	-20.82	QP
4	0.1824	16.78	9.62	26.40	54.38	-27.98	AVG
5	0.3465	19.53	9.63	29.16	59.05	-29.89	QP
6	0.3465	10.14	9.63	19.77	49.05	-29.28	AVG
7	3.7902	16.95	9.69	26.64	56.00	-29.36	QP
8	3.7902	11.80	9.69	21.49	46.00	-24.51	AVG
9	11.7471	18.93	10.02	28.95	60.00	-31.05	QP
10	11.7471	15.15	10.02	25.17	50.00	-24.83	AVG
11	25.1699	16.69	9.97	26.66	60.00	-33.34	QP
12	25.1699	13.29	9.97	23.26	50.00	-26.74	AVG

- Note: 1. Result = Reading +Correct Factor.  
 2. If QP Result complies with AV limit, AV Result is deemed to comply with AV limit.  
 3. Test setup: RBW: 200 Hz (9 kHz—150 kHz), 9 kHz (150 kHz—30 MHz).  
 4. Step size: 80Hz (0.009MHz-0.15MHz), 4 kHz (0.15MHz-30MHz), Scan time: auto.  
 5. The extension cord/outlet strip was calibrated with the LISN as required by ANSI C63.10:2013 Clause 6.2.2.



**LINE L RESULTS**

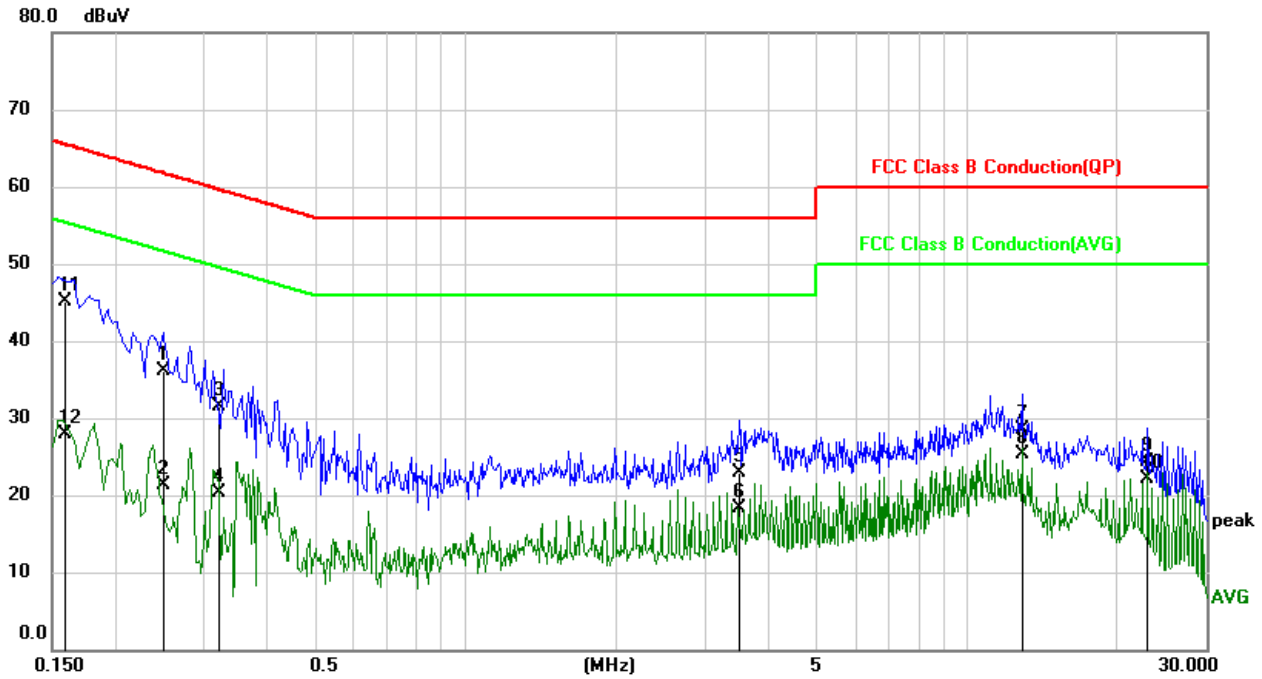

No.	Frequency (MHz)	Reading (dBuV)	Correct (dB)	Result (dBuV)	Limit (dBuV)	Margin (dB)	Remark
1	0.2502	26.44	9.63	36.07	61.75	-25.68	QP
2	0.2502	11.61	9.63	21.24	51.75	-30.51	AVG
3	0.3250	21.82	9.63	31.45	59.58	-28.13	QP
4	0.3250	10.72	9.63	20.35	49.58	-29.23	AVG
5	3.5060	13.30	9.69	22.99	56.00	-33.01	QP
6	3.5060	8.71	9.69	18.40	46.00	-27.60	AVG
7	12.8662	18.54	9.94	28.48	60.00	-31.52	QP
8	12.8662	15.38	9.94	25.32	50.00	-24.68	AVG
9	22.9332	14.48	9.89	24.37	60.00	-35.63	QP
10	22.9332	12.15	9.89	22.04	50.00	-27.96	AVG
11	0.1596	35.54	9.64	45.18	65.48	-20.30	QP
12	0.1596	18.17	9.64	27.81	55.48	-27.67	AVG

- Note: 1. Result = Reading +Correct Factor.  
 2. If QP Result complies with AV limit, AV Result is deemed to comply with AV limit.  
 3. Test setup: RBW: 200 Hz (9 kHz—150 kHz), 9 kHz (150 kHz—30 MHz).  
 4. Step size: 80Hz (0.009MHz-0.15MHz), 4 kHz (0.15MHz-30MHz), Scan time: auto.  
 5. The extension cord/outlet strip was calibrated with the LISN as required by ANSI C63.10:2013 Clause 6.2.2.

Note: All the modulation and channels had been tested, but only the worst data recorded in the report.



## 10. ANTENNA REQUIREMENTS

### APPLICABLE REQUIREMENTS

Please refer to FCC §15.203

If directional gain of transmitting antennas is greater than 6dBi, the power shall be reduced by the same level in dB comparing to gain minus 6dBi. For the fixed point-to-point operation, the power shall be reduced by one dB for every 3 dB that the directional gain of the antenna exceeds 6 dBi. The use of a permanently attached antenna or of an antenna that uses a unique coupling to the intentional radiator shall be considered sufficient to comply with the FCC rule.

### ANTENNA CONNECTOR

EUT has an external antenna with antenna connector.

### ANTENNA GAIN

The antenna gain of EUT is less than 6 dBi.

**END OF REPORT**