



**CFR 47 FCC PART 15 SUBPART C**

**CERTIFICATION TEST REPORT**

*For*

**IP CAMERA**

**MODEL NUMBER: DH-IPC-HFW1430DS1-SAW**

**ADDITIONAL MODELS NUMBER: IPC-HFW1230DS1-SAW,DH-IPC-HFW1230DS1-SAW,IPC-HFW1230DS1-SAW-0280B,DH-IPC-HFW1230DS1-SAW-0280B,IPC-HFW1230DS1-SAW-0360B,DH-IPC-HFW1230DS1-SAW-0360B,DH-IPC-HFW12B0DS1-SAW,IPC-HFW12B0DS1-SAW,IPC-HFW1430DS1-SAW,IPC-HFW1430DS1-SAW-0280B,DH-IPC-HFW1430DS1-SAW-0280B,IPC-HFW1430DS1-SAW-0360B,DH-IPC-HFW1430DS1-SAW-0360B,DH-IPC-HFW14B0DS1-SAW,IPC-HFW142B0DS1-SAW**

**PROJECT NUMBER: 4790401578-3**

**REPORT NUMBER: 4790401578-3-1**

**FCC ID: SVNIPC-HFW1X30**

**ISSUE DATE: May 17, 2022**

*Prepared for*

**Zhejiang Dahua Vision Technology Co., Ltd.**

*Prepared by*

**UL-CCIC COMPANY LIMITED**

**No. 2, Chengwan Road, Suzhou Industrial Park, People's Republic of China**

**Tel: + 86-512-6808 6400**

**Fax: + 86-512-6808 4099**

**Website: www.ul.com**

Form-ULID-008536-9 V1.0

The results reported herein have been performed in accordance with the laboratory's terms of accreditation. This report shall not be reproduced except in full without the written approval of the Laboratory. The results in this report apply to the test sample(s) mentioned above at the time of the testing period only and are not to be used to indicate applicability to other similar products. This report does not imply that the product(s) has met the criteria for certification.



Revision History

<u>Rev.</u>	<u>Issue Date</u>	<u>Revisions</u>	<u>Revised By</u>
V0	05/17/2022	Initial Issue	



## TABLE OF CONTENTS

<b>1. ATTESTATION OF TEST RESULTS .....</b>	<b>4</b>
<b>2. TEST METHODOLOGY .....</b>	<b>6</b>
<b>3. FACILITIES AND ACCREDITATION .....</b>	<b>6</b>
<b>4. CALIBRATION AND UNCERTAINTY .....</b>	<b>7</b>
4.1. <i>MEASURING INSTRUMENT CALIBRATION .....</i>	<i>7</i>
4.2. <i>MEASUREMENT UNCERTAINTY.....</i>	<i>7</i>
<b>5. EQUIPMENT UNDER TEST .....</b>	<b>8</b>
5.1. <i>DESCRIPTION OF EUT .....</i>	<i>8</i>
5.2. <i>MAXIMUM OUTPUT POWER .....</i>	<i>9</i>
5.3. <i>CHANNEL LIST.....</i>	<i>9</i>
5.4. <i>TEST CHANNEL CONFIGURATION.....</i>	<i>10</i>
5.5. <i>THE WORSE CASE POWER SETTING PARAMETER.....</i>	<i>10</i>
5.6. <i>DESCRIPTION OF AVAILABLE ANTENNAS.....</i>	<i>11</i>
5.7. <i>THE WORSE CASE CONFIGURATIONS .....</i>	<i>11</i>
5.8. <i>DESCRIPTION OF TEST SETUP .....</i>	<i>12</i>
5.9. <i>MEASURING INSTRUMENT AND SOFTWARE USED .....</i>	<i>13</i>
<b>6. MEASUREMENT METHODS .....</b>	<b>14</b>
<b>7. ANTENNA PORT TEST RESULTS .....</b>	<b>15</b>
7.1. <i>TEST ENVIRONMENT .....</i>	<i>15</i>
7.2. <i>ON TIME AND DUTY CYCLE.....</i>	<i>16</i>
7.3. <i>6 dB BANDWIDTH .....</i>	<i>19</i>
7.4. <i>CONDUCTED POWER .....</i>	<i>27</i>
7.5. <i>POWER SPECTRAL DENSITY.....</i>	<i>29</i>
7.6. <i>CONDUCTED BANDEDGE AND SPURIOUS EMISSIONS .....</i>	<i>38</i>
7.7. <i>RADIATED TEST RESULTS.....</i>	<i>69</i>
7.7.1. <i>LIMITS AND PROCEDURE .....</i>	<i>69</i>
7.7.2. <i>RESTRICTED BANDEDGE .....</i>	<i>74</i>
7.7.3. <i>SPURIOUS EMISSIONS .....</i>	<i>91</i>
<b>8. AC POWER LINE CONDUCTED EMISSIONS .....</b>	<b>148</b>
<b>9. ANTENNA REQUIREMENTS.....</b>	<b>151</b>



# 1. ATTESTATION OF TEST RESULTS

## Applicant Information

Company Name: Zhejiang Dahua Vision Technology Co., Ltd.  
Address: No.1199, Bin'an road, Binjiang District, Hangzhou, P.R.China.

## Manufacturer Information

Company Name: Zhejiang Dahua Vision Technology Co., Ltd.  
Address: No.1199, Bin'an road, Binjiang District, Hangzhou, P.R.China.

## EUT Description

Product Name: IP CAMERA  
Model Name: DH-IPC-HFW1430DS1-SAW  
Additional Models No. : IPC-HFW1230DS1-SAW,DH-IPC-HFW1230DS1-SAW,IPC-HFW1230DS1-SAW-0280B,DH-IPC-HFW1230DS1-SAW-0280B,IPC-HFW1230DS1-SAW-0360B,DH-IPC-HFW1230DS1-SAW-0360B,DH-IPC-HFW12B0DS1-SAW,IPC-HFW12B0DS1-SAW,IPC-HFW1430DS1-SAW, IPC-HFW1430DS1-SAW-0280B,DH-IPC-HFW1430DS1-SAW-0280B,IPC-HFW1430DS1-SAW-0360B,DH-IPC-HFW1430DS1-SAW-0360B,DH-IPC-HFW14B0DS1-SAW,IPC-HFW142B0DS1-SAW  
Sample Number: 4946911  
Data of Receipt Sample: May 12, 2022  
Date Tested: May 12, 2022~ May 17, 2022

APPLICABLE STANDARDS	
STANDARD	TEST RESULTS
CFR 47 FCC Part 15 Subpart C	PASS



Summary of Test Results			
Clause	Test Items	FCC Rules	Test Results
1	6db DTS Bandwidth	FCC 15.247 (a) (2)	Complied
2	Conducted Power	FCC 15.247 (b) (3)	Complied
3	Power Spectral Density	FCC 15.247 (e)	Complied
4	Conducted Band edge And Spurious emission	FCC 15.247 (d)	Complied
5	Radiated Band edges and Spurious emission	FCC 15.247 (d) FCC 15.209 FCC 15.205	Complied
6	Conducted Emission Test For AC Power Port	FCC 15.207	Complied
7	Antenna Requirement	FCC 15.203	Complied
Remark: 1) The measurement result for the sample received is <Pass> according to < ANSI C63.10-2013, FCC CFR 47 Part 2, FCC CFR 47 Part 15C, ISED RSS-GEN, ISED RSS-247> when <Accuracy Method> decision rule is applied.			

Prepared By:

*Tom Tang*

Tom Tang  
Project Engineer

Reviewed By:

*Leon Wu*

Leon Wu  
Senior Project Engineer

Authorized By:

*Chris Zhong*

Chris Zhong  
Laboratory Leader



## 2. TEST METHODOLOGY

The tests documented in this report were performed in accordance with FCC KDB 558074 D01 15.247 Meas Guidance v05r02, KDB 414788 D01 Radiated Test Site v01r01, ANSI C63.10-2013, CFR 47 FCC Part 2 and CFR 47 FCC Part 15.

## 3. FACILITIES AND ACCREDITATION

Accreditation Certificate	<p><b>A2LA (Certificate No.: 4829.01)</b>  <b>UL-CCIC COMPANY LIMITED has been assessed and proved to be in compliance with A2LA.</b></p> <p><b>FCC (FCC Designation No.: CN1247)</b>  <b>UL-CCIC COMPANY LIMITED has been recognized to perform compliance testing on equipment subject to the Commission's Declaration of Conformity (DoC) and Certification rules.</b></p> <p><b>IC (IC Designation No.: 25056; CAB No.:CN0073)</b>  <b>UL-CCIC COMPANY LIMITED has been recognized to perform compliance testing on equipment subject to the Commission's Declaration of Conformity (DoC) and Certification rules.</b></p>
---------------------------	--------------------------------------------------------------------------------------------------------------------------------------------------------------------------------------------------------------------------------------------------------------------------------------------------------------------------------------------------------------------------------------------------------------------------------------------------------------------------------------------------------------------------------------------------------------------------------------------------------------------------------------------

Note 1: All tests measurement facilities use to collect the measurement data are located at No. 2, Chengwan Road, Suzhou Industrial Park, Suzhou 215122, People's Republic of China

Note 2: For below 30MHz, lab had performed measurements at test anechoic chamber and comparing to measurements obtained on an open field site. These measurements below 30MHz had been correlated to measurements performed on an OFS.

Note 3: The test anechoic chamber in UL-CCIC COMPANY LIMITED had been calibrated and compared to the open field sites and the test anechoic chamber is shown to be equivalent to or worst case from the open field site.



## 4. CALIBRATION AND UNCERTAINTY

### 4.1. MEASURING INSTRUMENT CALIBRATION

The measuring equipment utilized to perform the tests documented in this report has been calibrated in accordance with the manufacturer's recommendations, and is traceable to recognized national standards.

### 4.2. MEASUREMENT UNCERTAINTY

Where relevant, the following measurement uncertainty levels have been estimated for tests performed on the apparatus:

Test Item	Uncertainty
Conduction emission	3.1dB
Radiation Emission test(include Fundamental emission) (9KHz-30MHz)	3.0dB
Radiation Emission test(include Fundamental emission) (30MHz-1GHz)	2.6dB
Radiation Emission test (1GHz to 26GHz)( include Fundamental emission)	3.0dB (1GHz-18Gz)
	3.0dB (18GHz-26.5Gz)
Note: This uncertainty represents an expanded uncertainty expressed at approximately the 95% confidence level using a coverage factor of k=2.	



## 5. EQUIPMENT UNDER TEST

### 5.1. DESCRIPTION OF EUT

Product Name:	IP CAMERA
Model No.:	DH-IPC-HFW1430DS1-SAW
Operating Frequency:	IEEE 802.11b/g/n(HT20): 2412MHz to 2462MHz IEEE 802.11n(HT40): 2422MHz to 2452MHz
Type of Modulation:	IEEE for 802.11b: DSSS (CCK, DQPSK, DBPSK) IEEE for 802.11g: OFDM (64QAM, 16QAM, QPSK, BPSK) IEEE for 802.11n (HT20 and HT40): OFDM (64QAM, 16QAM, QPSK, BPSK)
Channels Step:	Channels with 5MHz step
Test software of EUT:	Secure CRT (manufacturer declare)
Antenna Type:	Integral antenna
Antenna Gain:	2.34 dBi Remark: This data is provided by customer and our lab isn't responsible for this data
Test Voltage	AC120 60Hz

Remark:

Model No.:

Number:	Name:	Number:	Name:	Number:	Name:
1	DH-IPC-HFW1430DS1-SAW	2	IPC-HFW1230DS1-SAW	3	DH-IPC-HFW1230DS1-SAW
4	IPC-HFW1230DS1-SAW-0280B	5	DH-IPC-HFW1230DS1-SAW-0280B	6	IPC-HFW1230DS1-SAW-0360B
7	DH-IPC-HFW1230DS1-SAW-0360B	8	DH-IPC-HFW12B0DS1-SAW	9	IPC-HFW12B0DS1-SAW
10	IPC-HFW1430DS1-SAW	11	DH-IPC-HFW1430DS1-SAW	12	IPC-HFW1430DS1-SAW-0280B
13	DH-IPC-HFW1430DS1-SAW-0280B	14	IPC-HFW1430DS1-SAW-0360B	15	DH-IPC-HFW1430DS1-SAW-0360B
16	DH-IPC-HFW14B0DS1-SAW	17	IPC-HFW1420DS1-SAW		

Only the main model **DH-IPC-HFW1430DS1-SAW** was tested and only the data of this model is shown in this test report. Since Their electrical circuit design, layout, components used and internal wiring are identical, only the name of the models and Color difference.





## 5.2. MAXIMUM OUTPUT POWER

Number of Transmit Chains (NTX)	IEE Std. 802.11	Channel Number	Max AV Conducted Power (dBm)
1	IEEE 802.11B SISO	1-11[11]	16.49
1	IEEE 802.11G SISO	1-11[11]	13.04
1	IEEE 802.11nHT20	1-11[11]	12.85
1	IEEE 802.11nHT40	3-9[7]	13.03

## 5.3. CHANNEL LIST

Channel List for 802.11b/g/n (20 MHz)							
Channel	Frequency (MHz)	Channel	Frequency (MHz)	Channel	Frequency (MHz)	Channel	Frequency (MHz)
1	2412	4	2427	7	2442	10	2457
2	2417	5	2432	8	2447	11	2462
3	2422	6	2437	9	2452		

Channel List for 802.11n (40 MHz)							
Channel	Frequency (MHz)	Channel	Frequency (MHz)	Channel	Frequency (MHz)	Channel	Frequency (MHz)
3	2422	5	2432	7	2442	9	2452
4	2427	6	2437	8	2447		



### 5.4. TEST CHANNEL CONFIGURATION

Test Mode	Test Channel	Frequency
WiFi TX(802.11b)	CH 1, CH 6, CH 11	2412MHz, 2437MHz, 2462MHz
WiFi TX(802.11g)	CH 1, CH 6, CH 11	2412MHz, 2437MHz, 2462MHz
WiFi TX(802.11n HT20)	CH 1, CH 6, CH 11	2412MHz, 2437MHz, 2462MHz
WiFi TX(802.11n HT40)	CH 3, CH 6, CH 9	2422MHz, 2437MHz, 2452MHz

### 5.5. THE WORSE CASE POWER SETTING PARAMETER

The Worst Case Power Setting Parameter under 2400 ~ 2483.5MHz Band							
Test Software		Secure CRT					
Modulation Mode	Transmit Antenna Number	Test Channel					
		NCB: 20MHz			NCB: 40MHz		
		CH 1	CH 6	CH 11	CH 3	CH 6	CH 9
802.11b	1	N/A	N/A	N/A	/		
802.11g	1	N/A	N/A	N/A			
802.11n HT20	1	N/A	N/A	N/A			
802.11n HT40	1	/			N/A	N/A	N/A



## 5.6. DESCRIPTION OF AVAILABLE ANTENNAS

Ant.	Frequency (MHz)	Antenna Type	Antenna Gain (dBi)
1	2400-2483.5	Integral antenna	2.34

Test Mode	Transmit and Receive Mode	Description
IEEE 802.11b	<input checked="" type="checkbox"/> 1TX, 1RX	Antenna1 can be used as transmitting/receiving antenna independently.
IEEE 802.11g	<input checked="" type="checkbox"/> 1TX, 1RX	Antenna1 can be used as transmitting/receiving antenna independently.
IEEE 802.11N (HT20)	<input checked="" type="checkbox"/> 1TX, 1RX	Antenna1 can be used as transmitting/receiving antenna independently.
IEEE 802.11N (HT40)	<input checked="" type="checkbox"/> 1TX, 1RX	Antenna1 can be used as transmitting/receiving antenna independently.

## 5.7. THE WORSE CASE CONFIGURATIONS

For the product, there two transmission antennas, and pre-testing both of them, only the worse data for the antenna is recorded in the report.

Worst-case data rates as provided by the client were:

802.11b mode: 1 Mbps  
802.11g mode: 6 Mbps  
802.11n HT20 mode: MCS0  
802.11n HT40 mode: MCS0

## 5.8. DESCRIPTION OF TEST SETUP

### SUPPORT EQUIPMENT

Item	Equipment	Brand Name	Model Name	Description
1	Laptop	ThinkPad	E590	N/A
2	SD Card	N/A	N/A	Supply by UL Lab
3	Fixed Frequency Board	N/A	N/A	Supply by Customer

### I/O PORT

Cable No	Port	Connector Type	Cable Type	Cable Length(m)	Remarks
1	USB	USB to TTL	USB	100cm Length	N/A
2	LAN	LAN	LAN	100cm Length	N/A

### ACCESSORY

Item	Accessory	Brand Name	Model Name	Description
1	Power Adapter	MASS POWER	ADS-12AM-12 12012-EPCU	INPUT:100-240V~, 50/60Hz, 0.3A OUTPUT:5.0V  1.0A

### TEST SETUP

The EUT can work in an engineer mode with a software through a table PC.

### SETUP DIAGRAM FOR TESTS

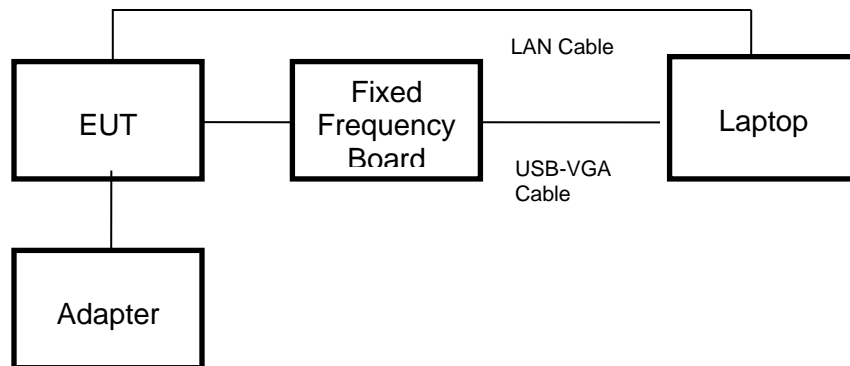

Remark: The EUT has been built one SD card during the testing



### 5.9. MEASURING INSTRUMENT AND SOFTWARE USED

Conducted Emissions (Instrument)							
Used	Equipment	Manufacturer	Model No.	Serial No.	Upper Last Cal.	Last Cal.	Next Cal.
<input checked="" type="checkbox"/>	EMI Test Receiver	R&S	ESR3	126700	2020-12-05	2021-12-04	2022-12-03
<input checked="" type="checkbox"/>	Two-Line V- Network	R&S	ENV216	126701	2020-12-05	2021-12-04	2022-12-03
Software							
Used	Description		Manufacturer	Name	Version		
<input checked="" type="checkbox"/>	Test Software for Conducted disturbance		R&S	EMC32	Ver. 9.25		
Radiated Emissions (Instrument)							
Used	Equipment	Manufacturer	Model No.	Serial No.	Upper Last Cal.	Last Cal.	Next Cal.
<input checked="" type="checkbox"/>	Spectrum Analyzer	Keysight	N9010B	155727	2021-05-09	2022-04-09	2023-04-08
<input checked="" type="checkbox"/>	EMI test receiver	R&S	ESR26	126703	2020-12-05	2021-12-04	2022-12-03
<input checked="" type="checkbox"/>	Receiver Antenna (9kHz-30MHz)	Schwarzbeck	FMZB 1513	155456	2018-06-15	2021-06-03	2024-06-02
<input checked="" type="checkbox"/>	Receiver Antenna (30MHz-1GHz)	SunAR RF Motion	JB1	177821	2019-01-28	2022-01-18	2025-01-17
<input checked="" type="checkbox"/>	Receiver Antenna (1GHz-18GHz)	R&S	HF907	126705	2018-01-29	2022-02-28	2025-02-27
<input checked="" type="checkbox"/>	Receiver Antenna (18GHz-26.5GHz)	ETS	3160-10	155565	2019-01-05	2021-07-15	2024-07-14
<input checked="" type="checkbox"/>	Pre-amplification (To 18GHz)	Compliance Direction System Inc.	PAP-1G18-50	177825	2021-03-18	2022-03-01	2023-02-28
<input checked="" type="checkbox"/>	Pre-amplification (To 26.5GHz)	R&S	SCU-26D	135391	2021-12-05	2022-12-04	2022-12-03
<input checked="" type="checkbox"/>	Band Reject Filter	Wainwright	WRCJV8-2350-2400-2483.5-2533.5-40SS	1	2021-05-09	2022-04-09	2023-04-08
<input checked="" type="checkbox"/>	Highpass Filter	Wainwright	WHKX10-2700-3000-18000-40SS	2	2021-05-09	2022-04-09	2023-04-08
Software							
Used	Description		Manufacturer	Name	Version		
<input checked="" type="checkbox"/>	Test Software for Radiated disturbance		Tonscend	JS36-RSE	4.0.0.1		
Other instruments							
Used	Equipment	Manufacturer	Model No.	Serial No.	Upper Last Cal.	Last Cal.	Next Cal.
<input checked="" type="checkbox"/>	Spectrum Analyzer	Keysight	N9010B	155368	2021-05-09	2022-04-09	2023-04-08
<input checked="" type="checkbox"/>	Power Meter	Keysight	U2021XA	155370	2021-05-09	2022-04-09	2023-04-08



## 6. MEASUREMENT METHODS

No.	Test Item	KDB Name	Section
1	6dB Bandwidth	KDB 558074 D01 15.247 Meas Guidance v05r02	8.2
2	Conducted Output Power	KDB 558074 D01 15.247 Meas Guidance v05r02	8.3.2.3 (Method AVGPM)
3	Power Spectral Density	KDB 558074 D01 15.247 Meas Guidance v05r02	8.4 (Method PKPSD)
4	Out-of-band emissions in non-restricted bands	KDB 558074 D01 15.247 Meas Guidance v05r02	8.5
5	Out-of-band emissions in restricted bands	KDB 558074 D01 15.247 Meas Guidance v05r02	8.6
6	Band-edge	KDB 558074 D01 15.247 Meas Guidance v05r02	8.7
7	Conducted Emission Test For AC Power Port	ANSI C63.10-2013	6.2



## 7. ANTENNA PORT TEST RESULTS

### 7.1. TEST ENVIRONMENT

Environment Parameter	Selected Values During Tests
Relative Humidity	59.0%
Atmospheric Pressure:	102kPa
Temperature	20.8°C

## 7.2. ON TIME AND DUTY CYCLE

### LIMITS

None; for reporting purposes only

### PROCEDURE

FCC KDB 558074 Zero-Span Spectrum Analyzer Method

### TEST SETUP

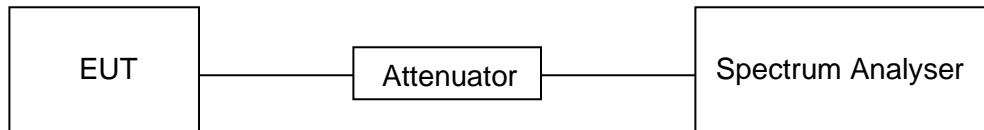

### RESULTS

Mode	On Time (msec)	Period (msec)	Duty Cycle x (Linear)	Duty Cycle (%)	Duty Cycle Correction Factor (db)	1/T Minimum VBW (KHz)	Final Minimum VBW (KHz)
11B	8.38	8.45	0.992	99.2	0.03	0.12	0.01(Note4)
11G	1.39	1.46	0.952	95.2	0.21	0.72	1
11N HT20	5.07	5.14	0.986	98.6	0.06	0.20	0.01(Note4)
11N HT40	2.47	2.53	0.976	97.6	0.11	0.40	1

Note: 1) Duty Cycle Correction Factor= $10\log(1/x)$ .

2) Where: x is Duty Cycle(Linear)

3) Where: T is On Time (transmit duration)

4) The minimum VBW should be 10Hz if the duty cycle is over 98%.



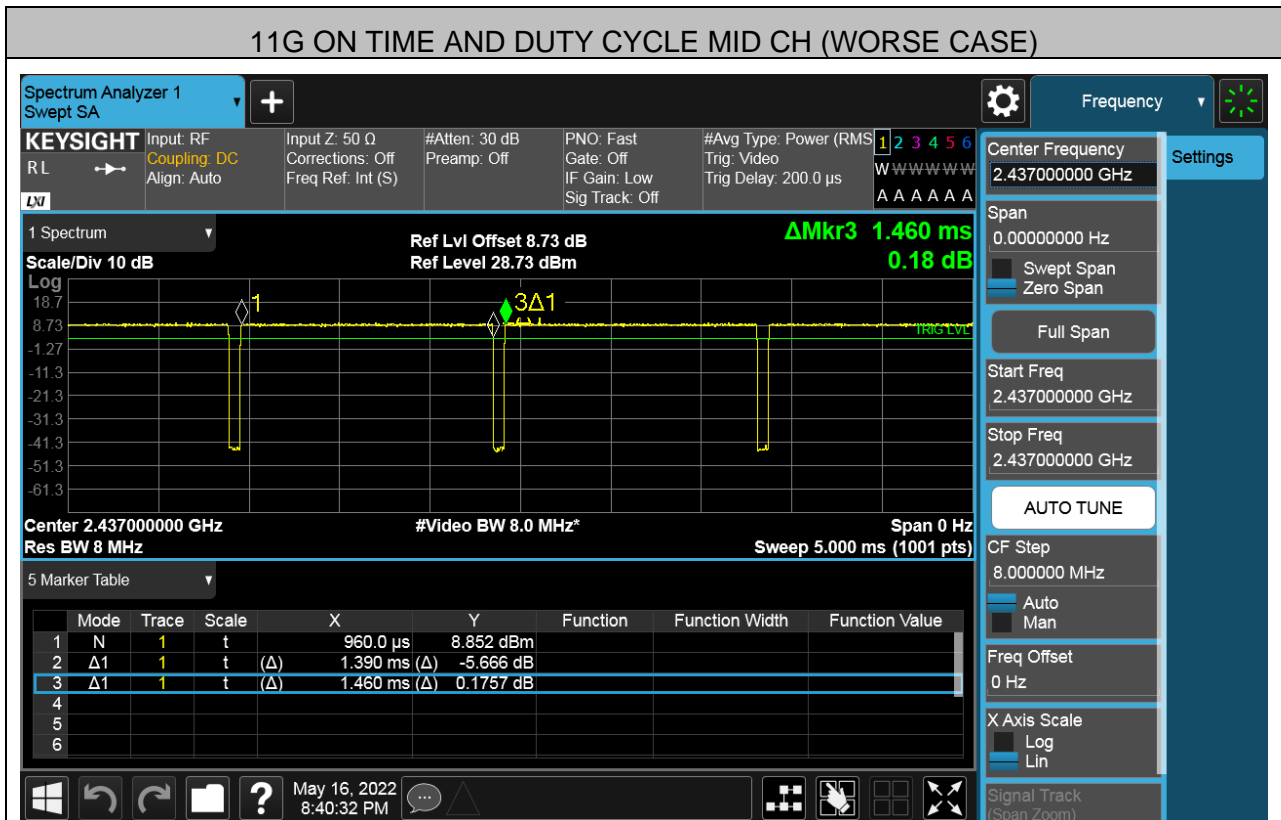
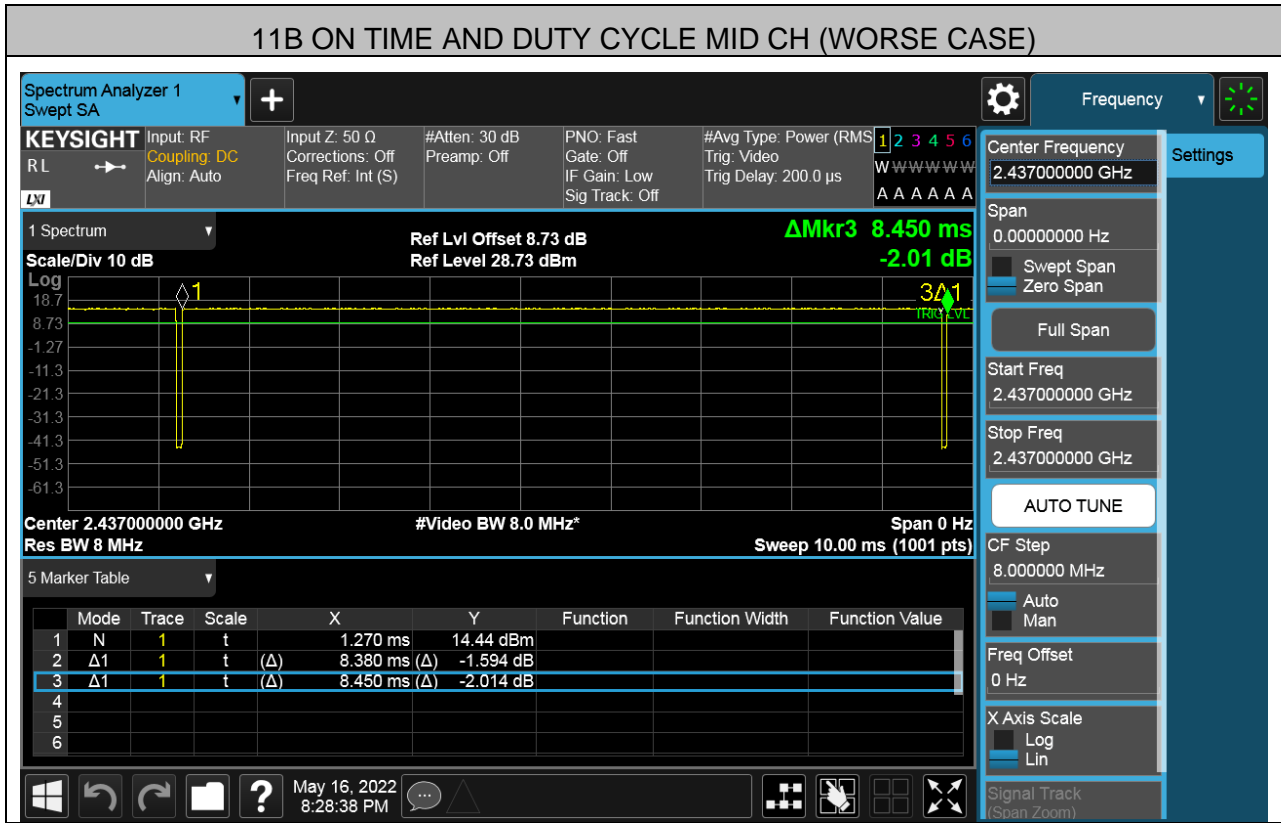

Form-ULID-008536-9 V1.0

UL-CCIC COMPANY LIMITED

This report shall not be reproduced except in full, without the written approval of UL-CCIC COMPANY LIMITED.

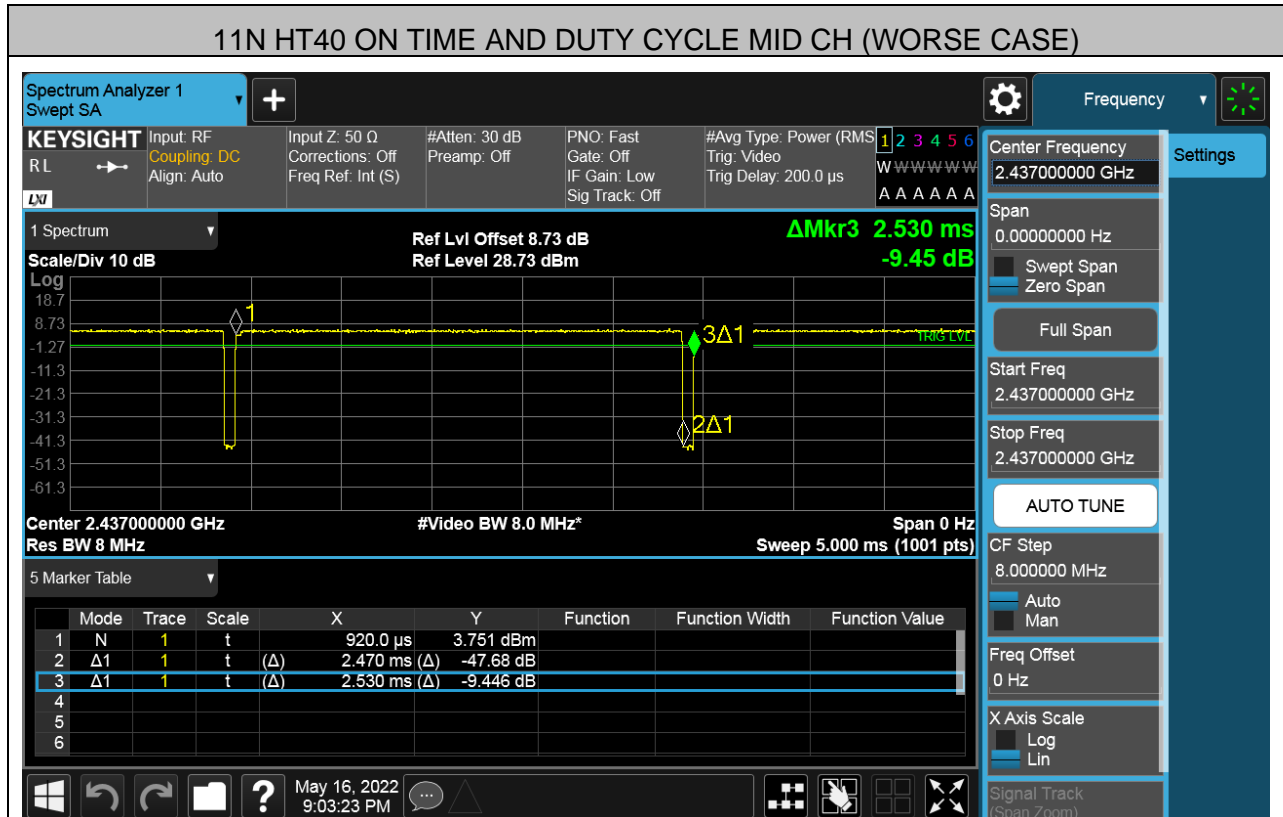
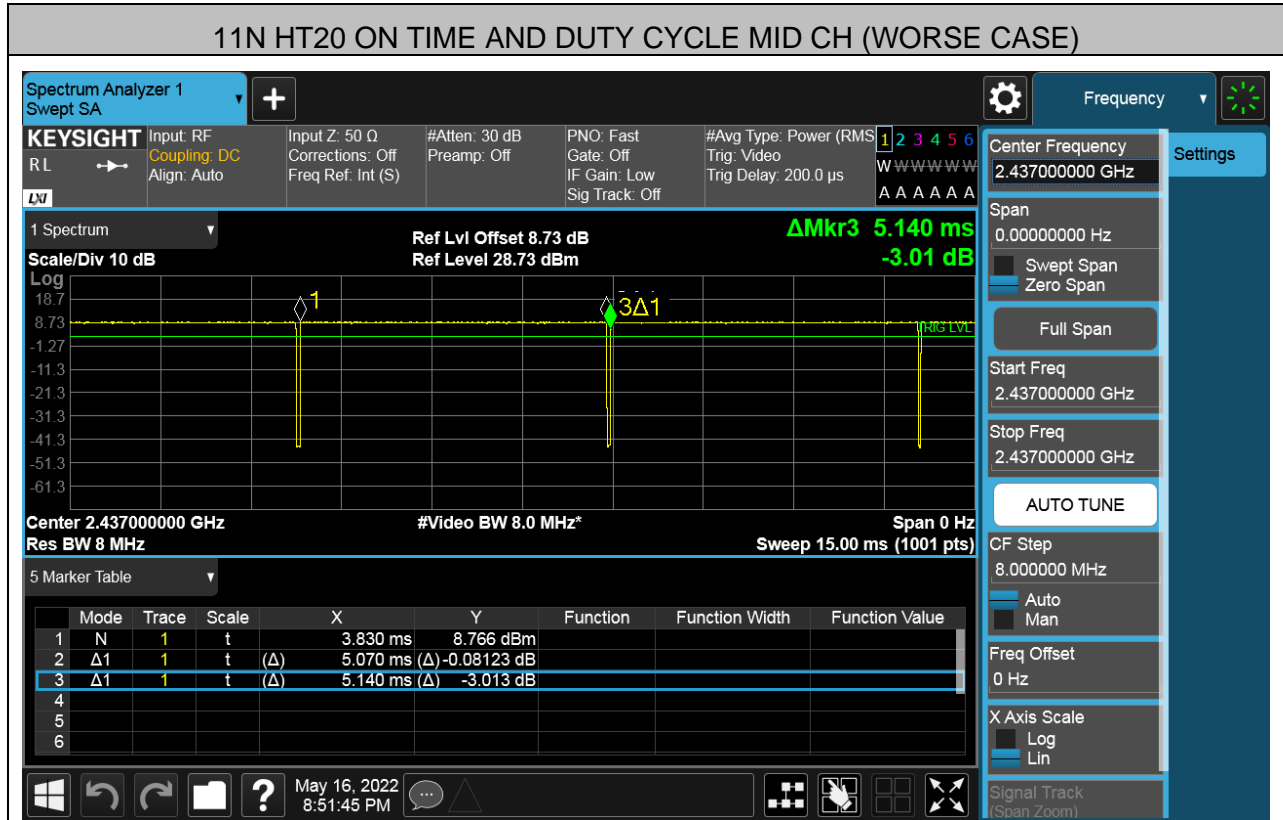



### 7.3. 6 dB BANDWIDTH

#### LIMITS

FCC Part15 (15.247) Subpart C			
Section	Test Item	Limit	Frequency Range (MHz)
FCC 15.247(a)(2)	6dB Bandwidth	$\geq 500\text{KHz}$	2400-2483.5

#### TEST PROCEDURE

Refer to FCC KDB 558074, connect the UUT to the spectrum analyzer and use the following settings:

Center Frequency	The centre frequency of the channel under test
Detector	Peak
RBW	For 6dB Bandwidth :100K
VBW	For 6dB Bandwidth : $\geq 3 \times \text{RBW}$
Trace	Max hold
Sweep	Auto couple

Allow the trace to stabilize and measure the maximum width of the emission that is constrained by the frequencies associated with the two outermost amplitude points (upper and lower frequencies) that are attenuated by 6 dB relative to the maximum level measured in the fundamental emission.

#### TEST SETUP

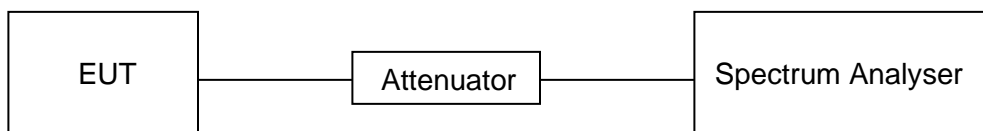



**RESULTS**

Test Mode	Test Channel	6dB bandwidth (MHz)	Result
11B	LCH	10.040	Pass
	MCH	10.040	Pass
	HCH	10.080	Pass
11G	LCH	16.320	Pass
	MCH	16.360	Pass
	HCH	16.320	Pass
11N HT20	LCH	17.600	Pass
	MCH	17.600	Pass
	HCH	17.600	Pass
11N HT40	LCH	36.320	Pass
	MCH	35.920	Pass
	HCH	36.320	Pass



**Test Graphs**  
**For 6dB Bandwidth part:**

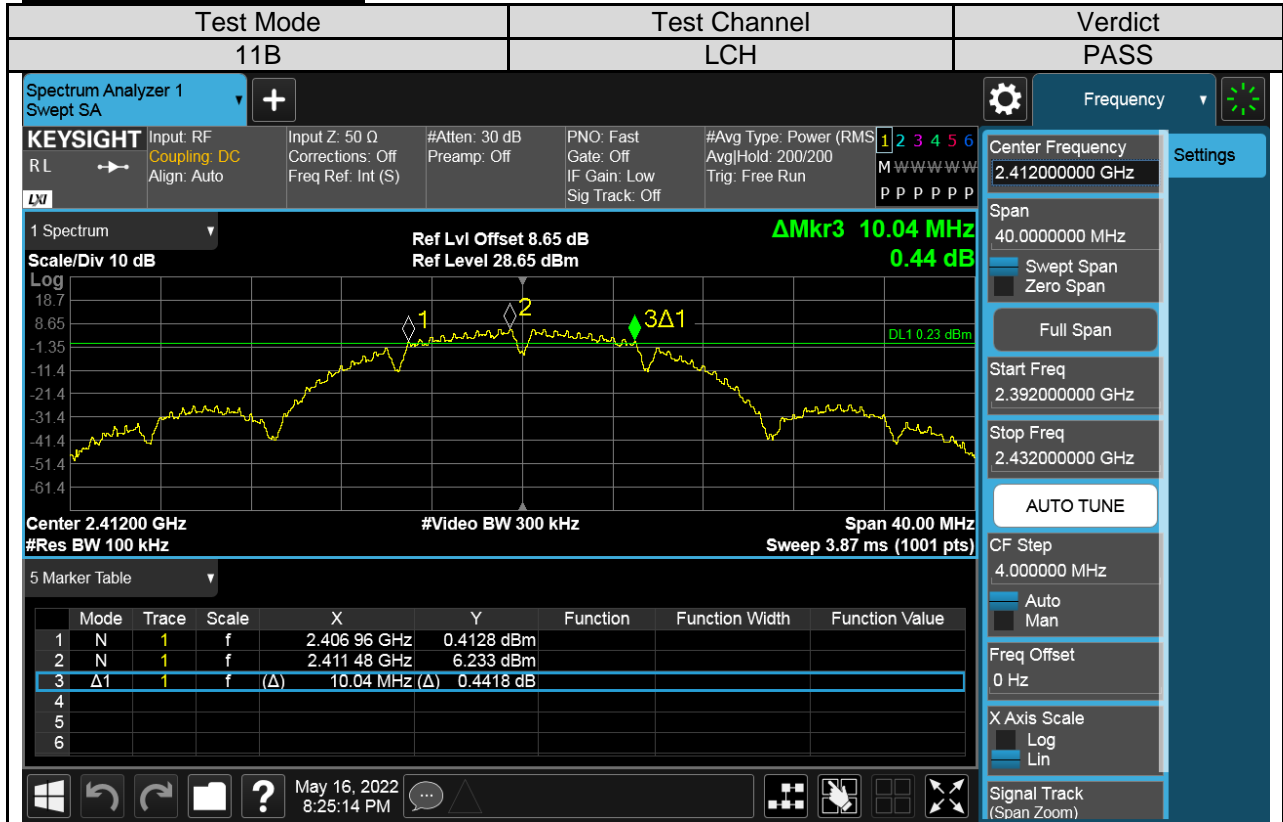

Form-ULID-008536-9 V1.0

UL-CCIC COMPANY LIMITED

This report shall not be reproduced except in full, without the written approval of UL-CCIC COMPANY LIMITED.

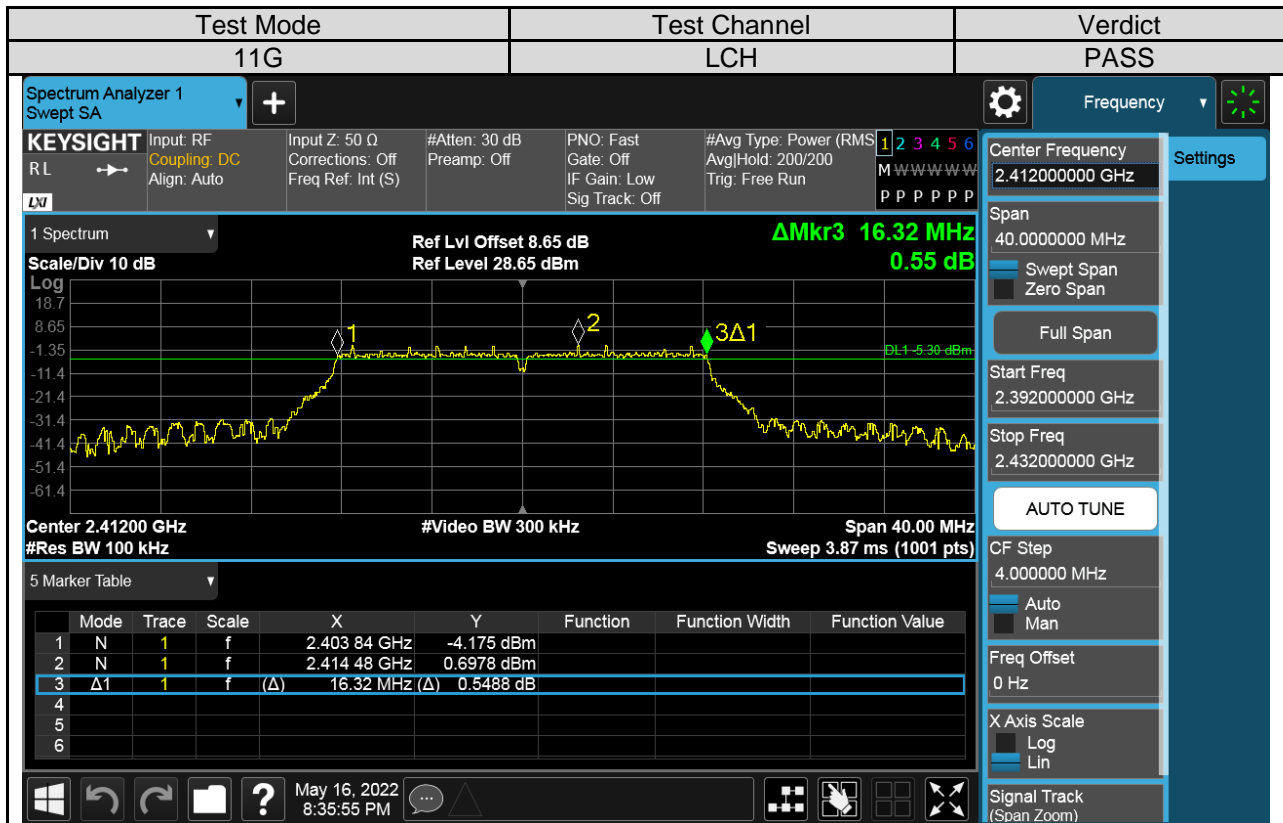
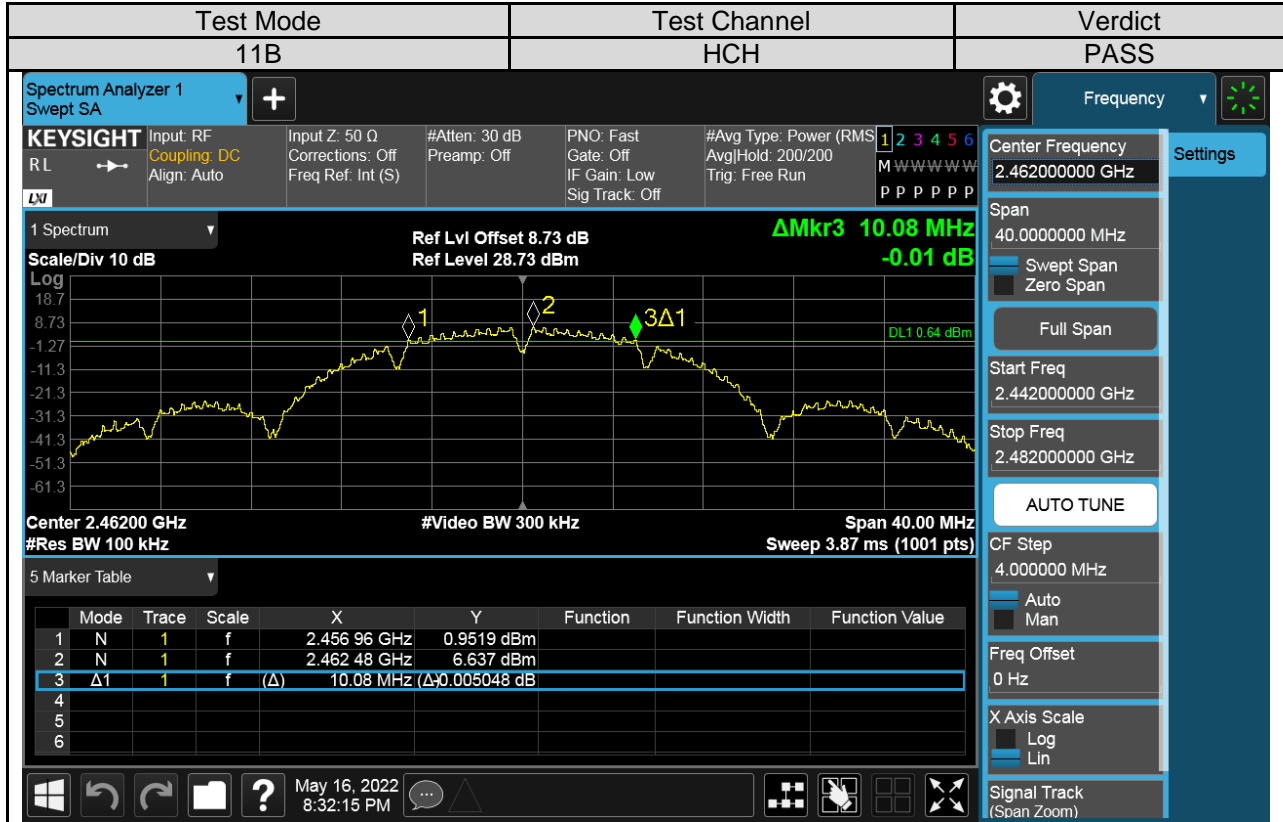

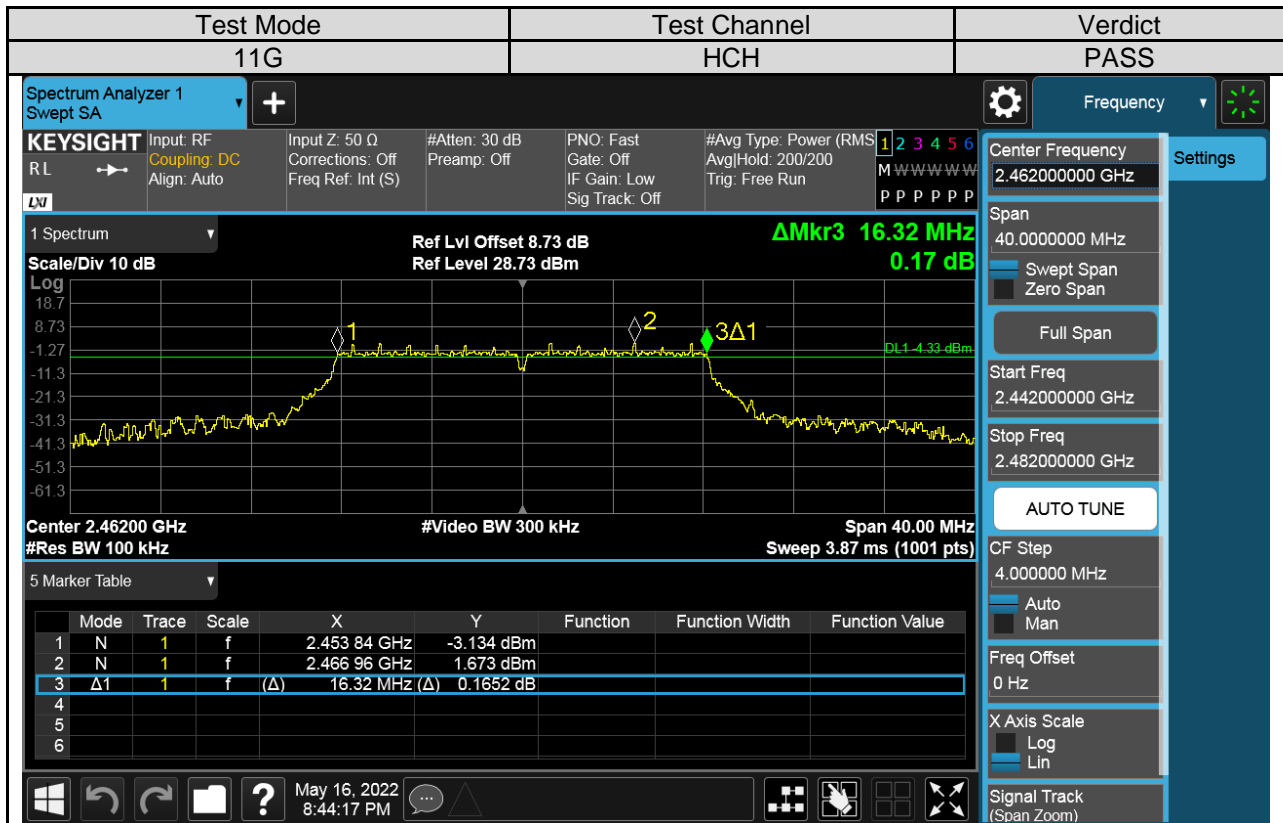
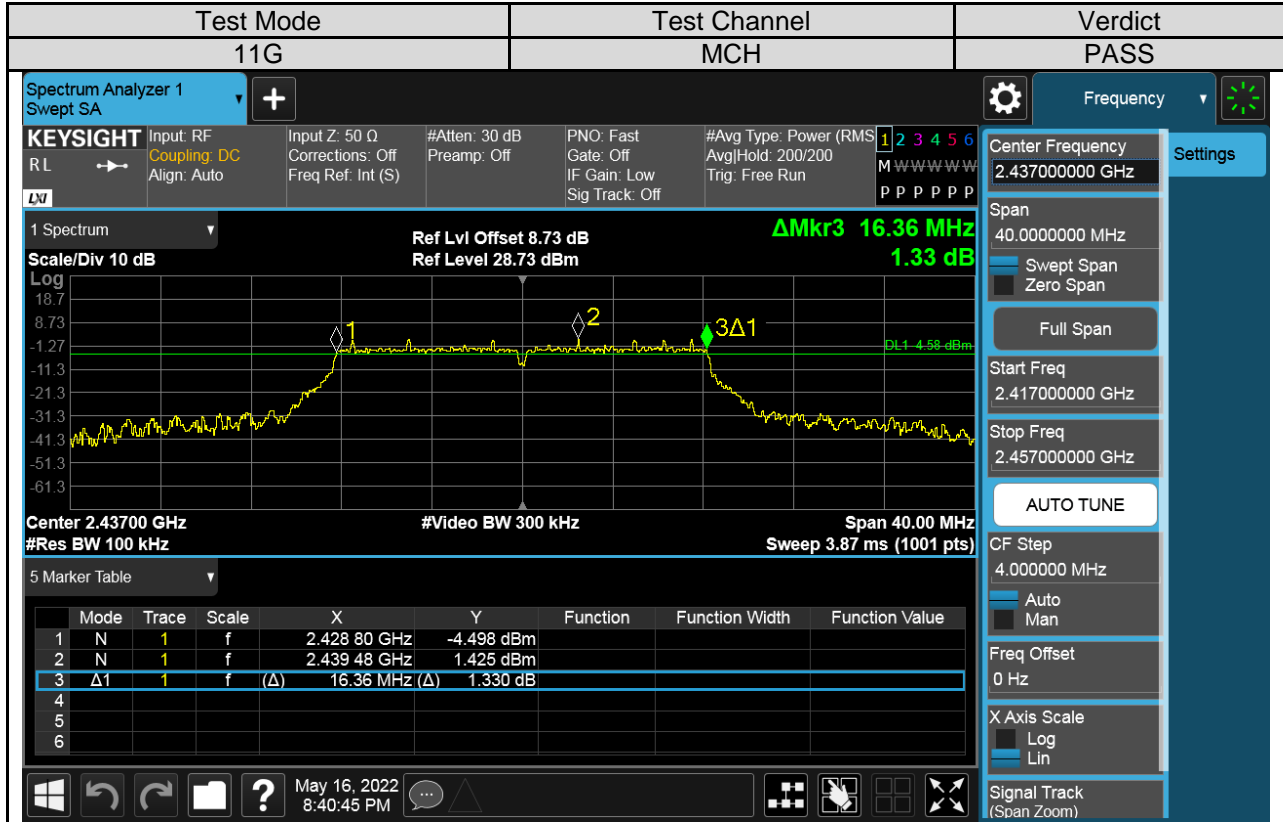

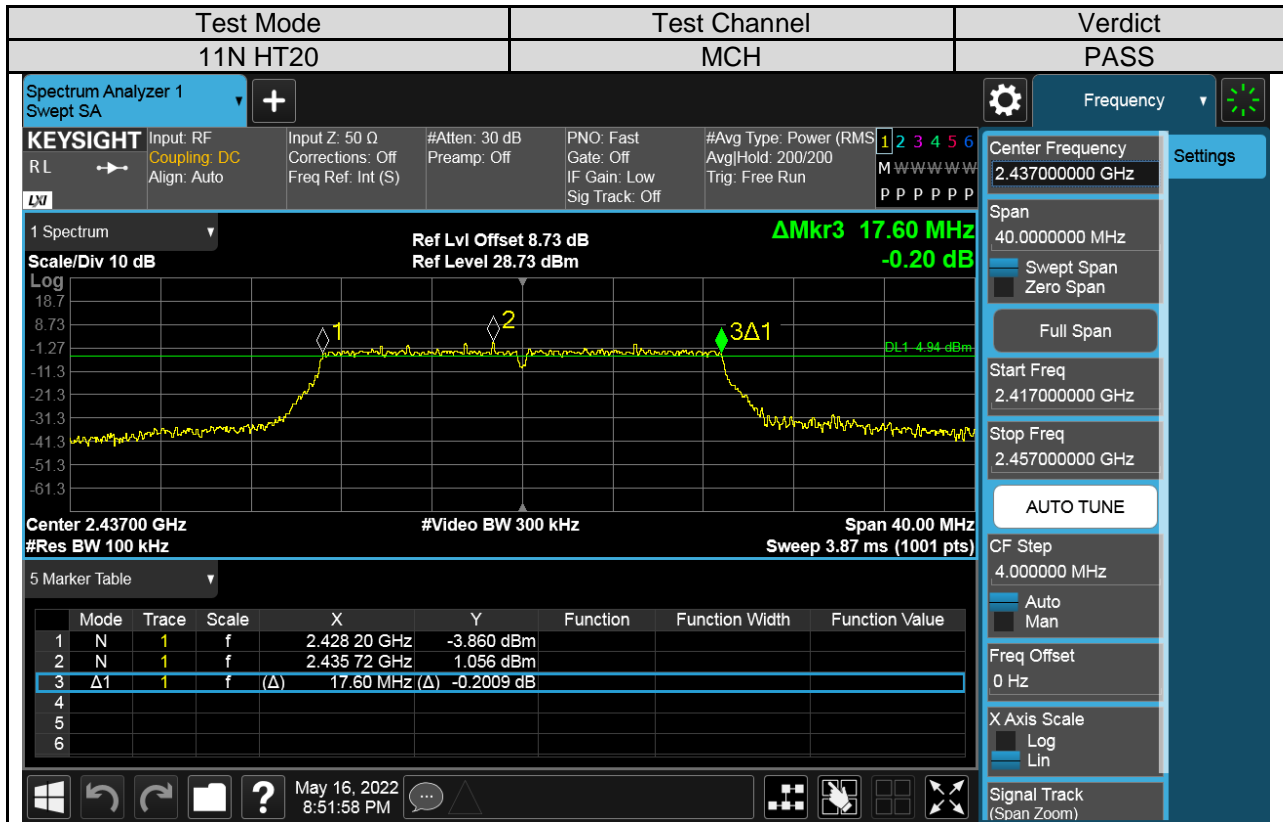
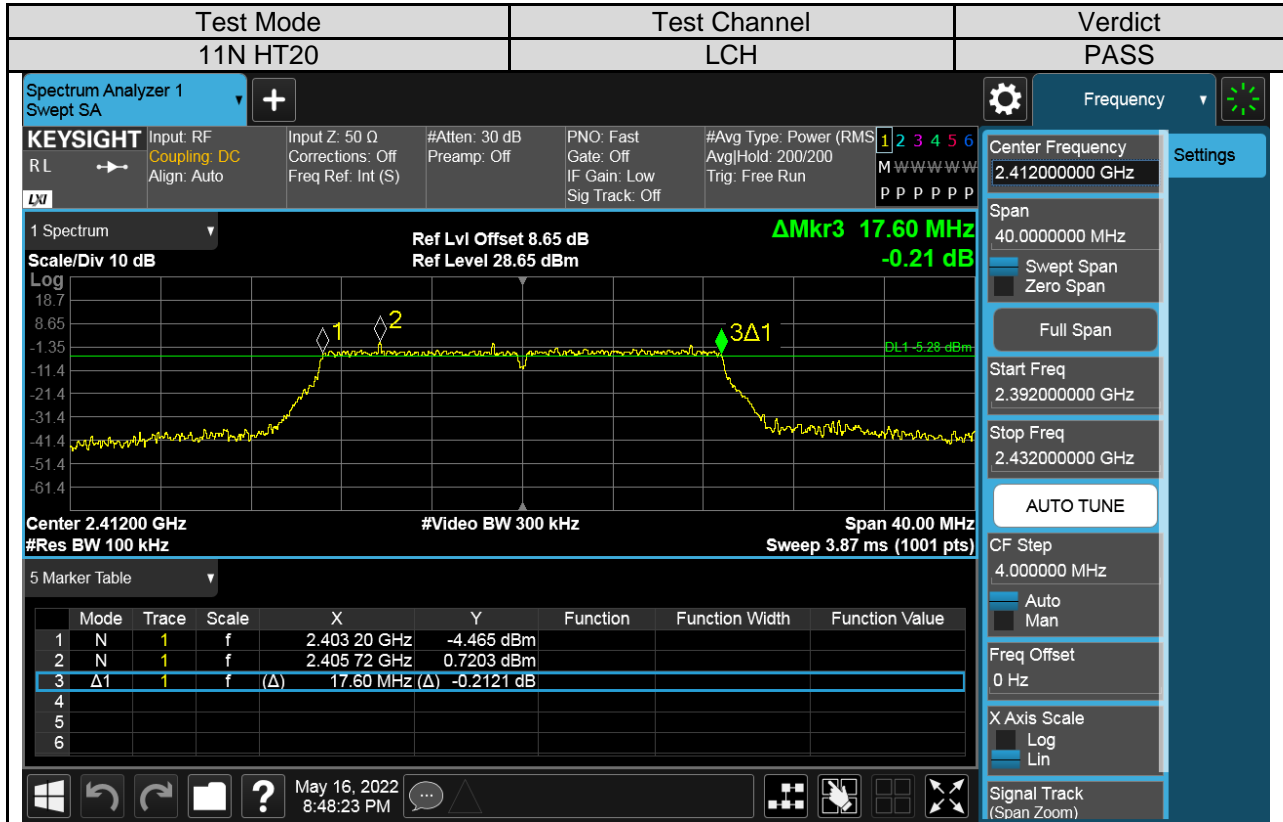



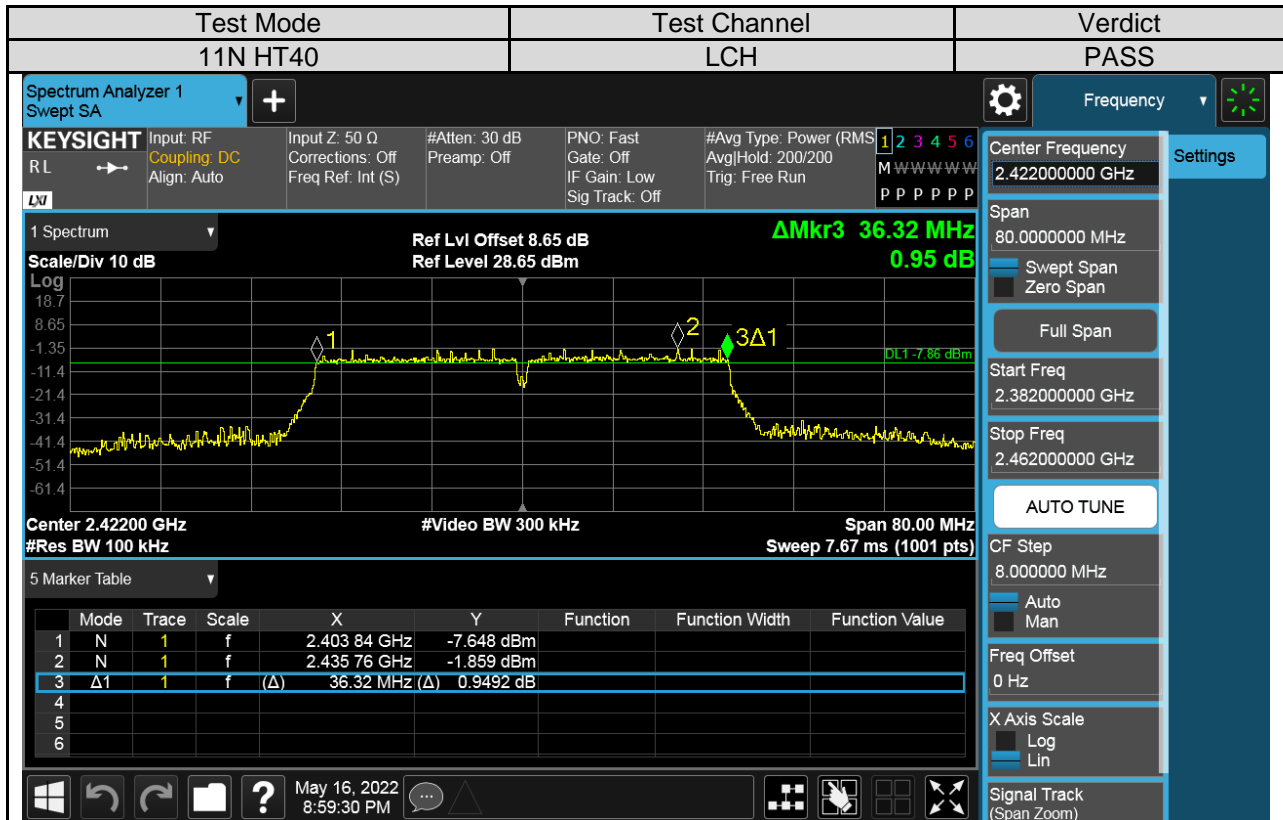
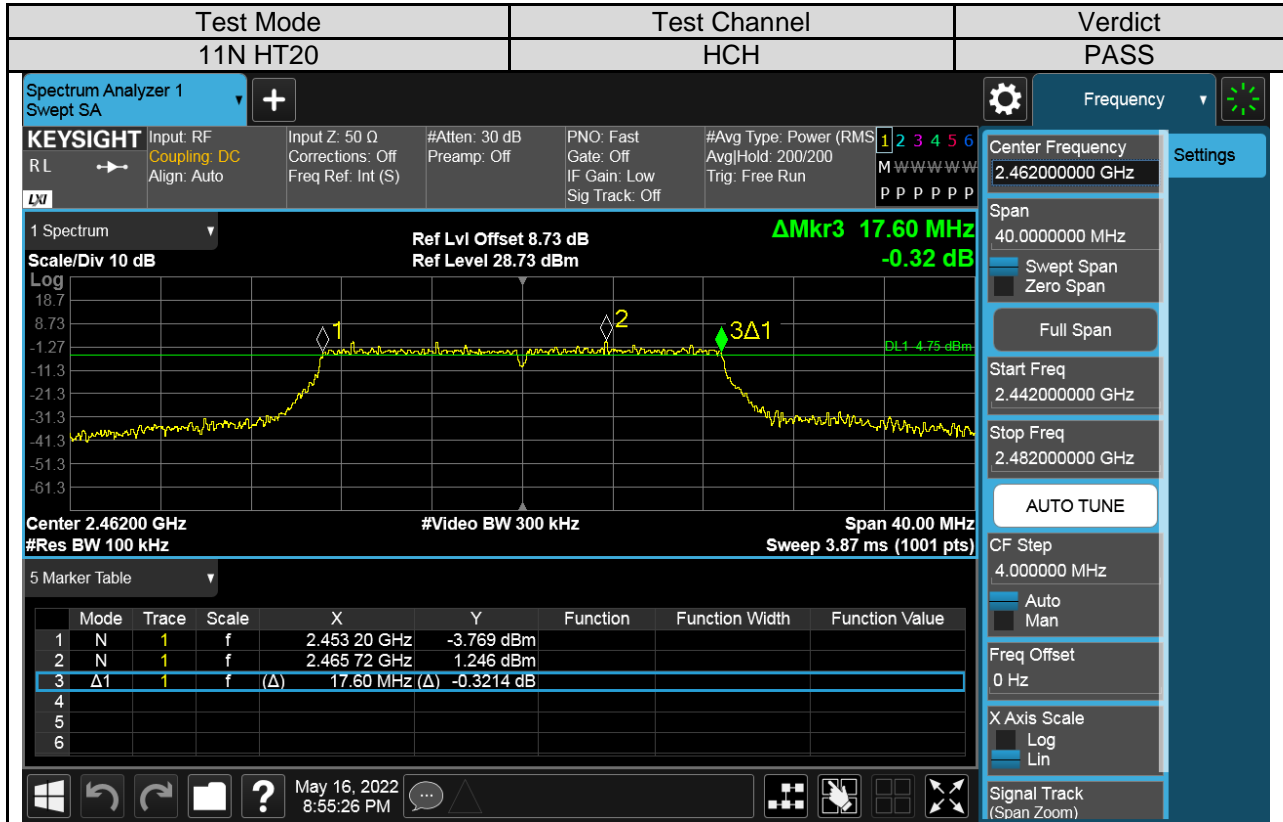

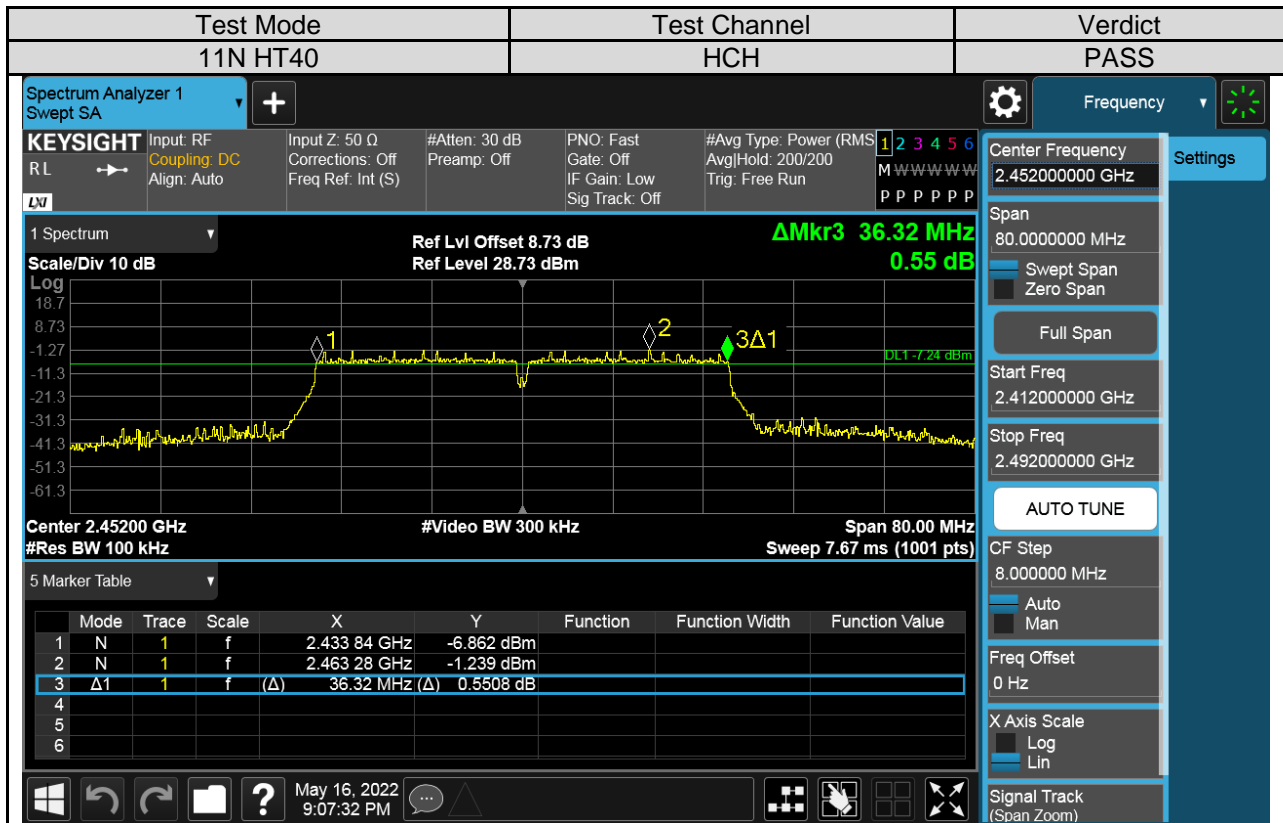
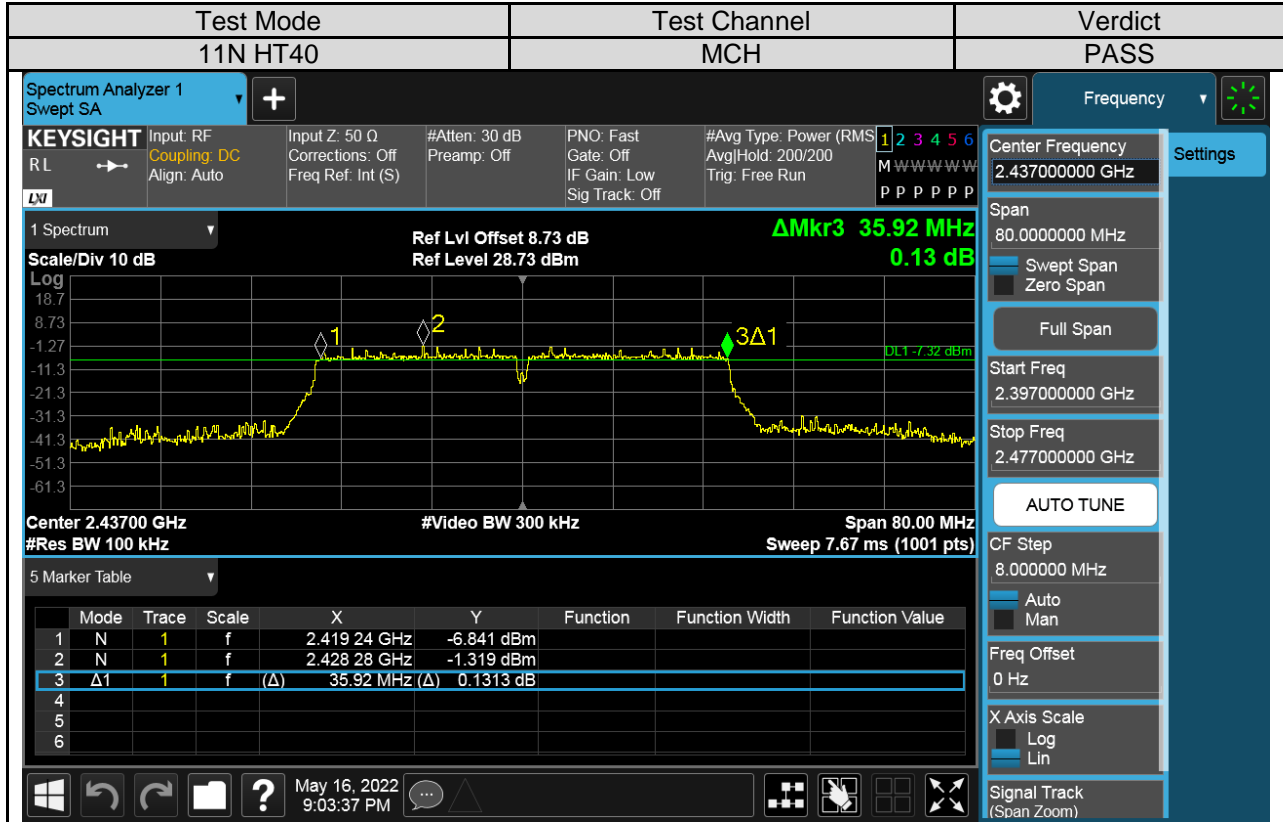



## 7.4. CONDUCTED POWER

### LIMITS

FCC Part15 (15.247) Subpart C			
Section	Test Item	Limit	Frequency Range (MHz)
FCC 15.247(b)(3)	Output Power	1 watt or 30dBm	2400-2483.5

### TEST PROCEDURE

Place the EUT on the table and set it in the transmitting mode.  
Remove the antenna from the EUT and then connect a low loss RF cable from the antenna port to the Power Meter.  
Measure the power of each channel.  
AVG Detector use for AVG result.

### TEST SETUP

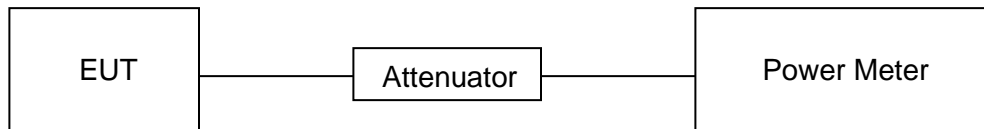



**RESULTS**

Test Mode	Test Channel	Measurement Output Power (AV)	10log(1/x) Factor	Maximum Conducted Output Power (AV)	Result
		dBm	dB	dBm	
11B	LCH	15.93	0.03	15.96	Pass
	MCH	16.46	0.03	16.49	Pass
	HCH	16.42	0.03	16.45	Pass
11G	LCH	12.14	0.21	12.35	Pass
	MCH	12.80	0.21	13.01	Pass
	HCH	12.83	0.21	13.04	Pass
11N HT20	LCH	12.17	0.06	12.23	Pass
	MCH	12.77	0.06	12.83	Pass
	HCH	12.79	0.06	12.85	Pass
11N HT40	LCH	12.51	0.11	12.62	Pass
	MCH	12.79	0.11	12.90	Pass
	HCH	12.92	0.11	13.03	Pass

Remark:

- 1) For all the test results has been adjusted the duty cycle factor.
- 2) For Correction Factor is refer to the result in section 7.2

## 7.5. POWER SPECTRAL DENSITY

### LIMITS

FCC Part15 (15.247) Subpart C			
Section	Test Item	Limit	Frequency Range (MHz)
FCC §15.247 (e)	Power Spectral Density	8 dBm in any 3 kHz band	2400-2483.5

### TEST PROCEDURE

Refer to FCC KDB 558074, connect the UUT to the spectrum analyser and use the following settings:

Center Frequency	The centre frequency of the channel under test
Detector	Peak
RBW	$3 \text{ kHz} \leq \text{RBW} \leq 100 \text{ kHz}$
VBW	$\geq 3 \times \text{RBW}$
Span	1.5 x DTS bandwidth
Trace	Max hold
Sweep time	Auto couple.

Allow trace to fully stabilize and use the peak marker function to determine the maximum amplitude level within the RBW.

If measured value exceeds limit, reduce RBW (no less than 3 kHz) and repeat.

### TEST SETUP

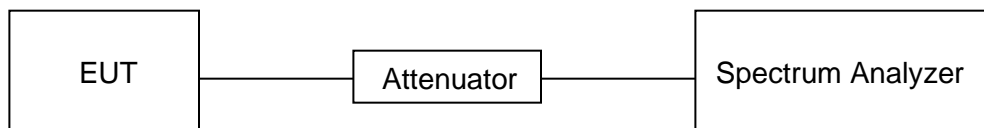



**RESULTS**

Test Mode	Test Channel	Maximum Peak power spectral density (dBm/30kHz)	Result
11B	LCH	1.06	Pass
	MCH	2.22	Pass
	HCH	2.20	Pass
11G	LCH	-4.03	Pass
	MCH	-2.58	Pass
	HCH	-2.50	Pass
11N HT20	LCH	-4.14	Pass
	MCH	-3.85	Pass
	HCH	-4.16	Pass
11N HT40	LCH	-6.38	Pass
	MCH	-6.86	Pass
	HCH	-6.45	Pass



**Test Graphs:**



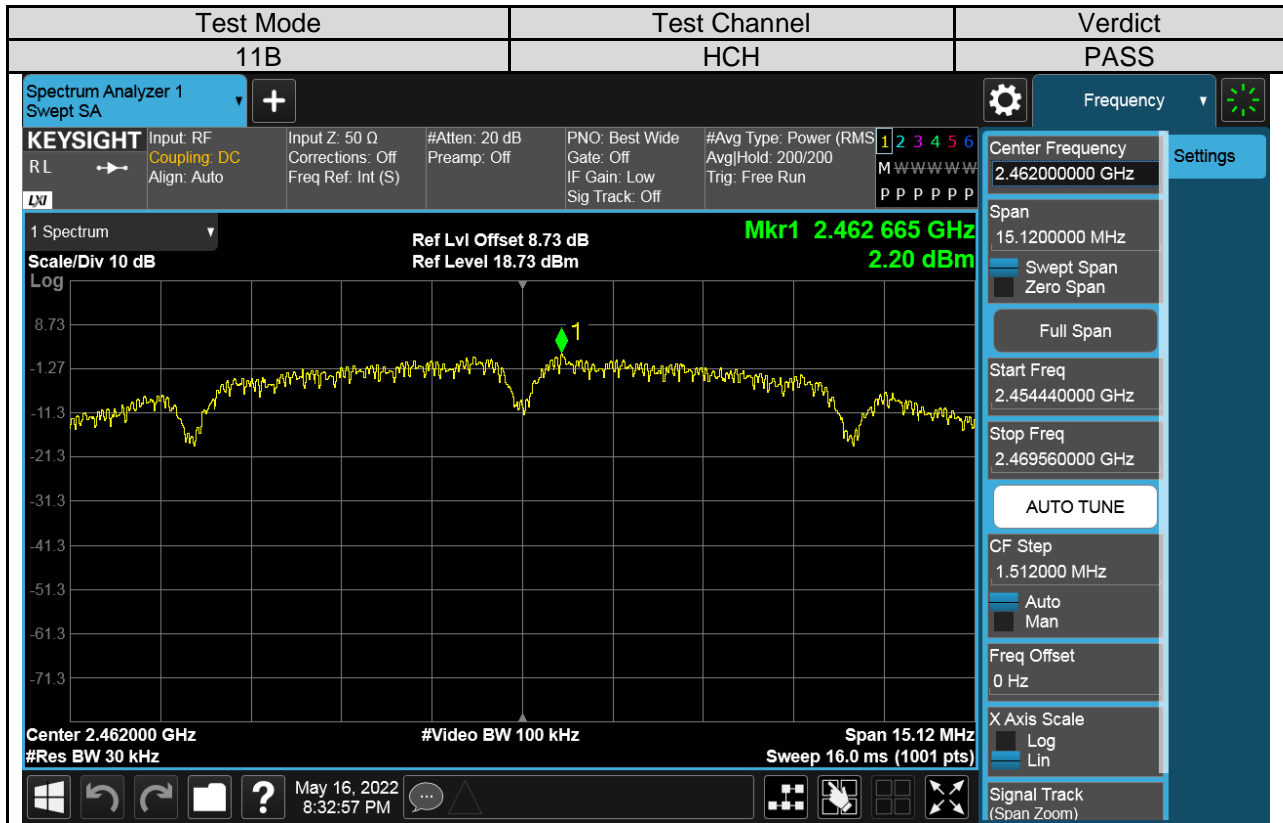

Test Mode	Test Channel	Verdict
11G	LCH	PASS



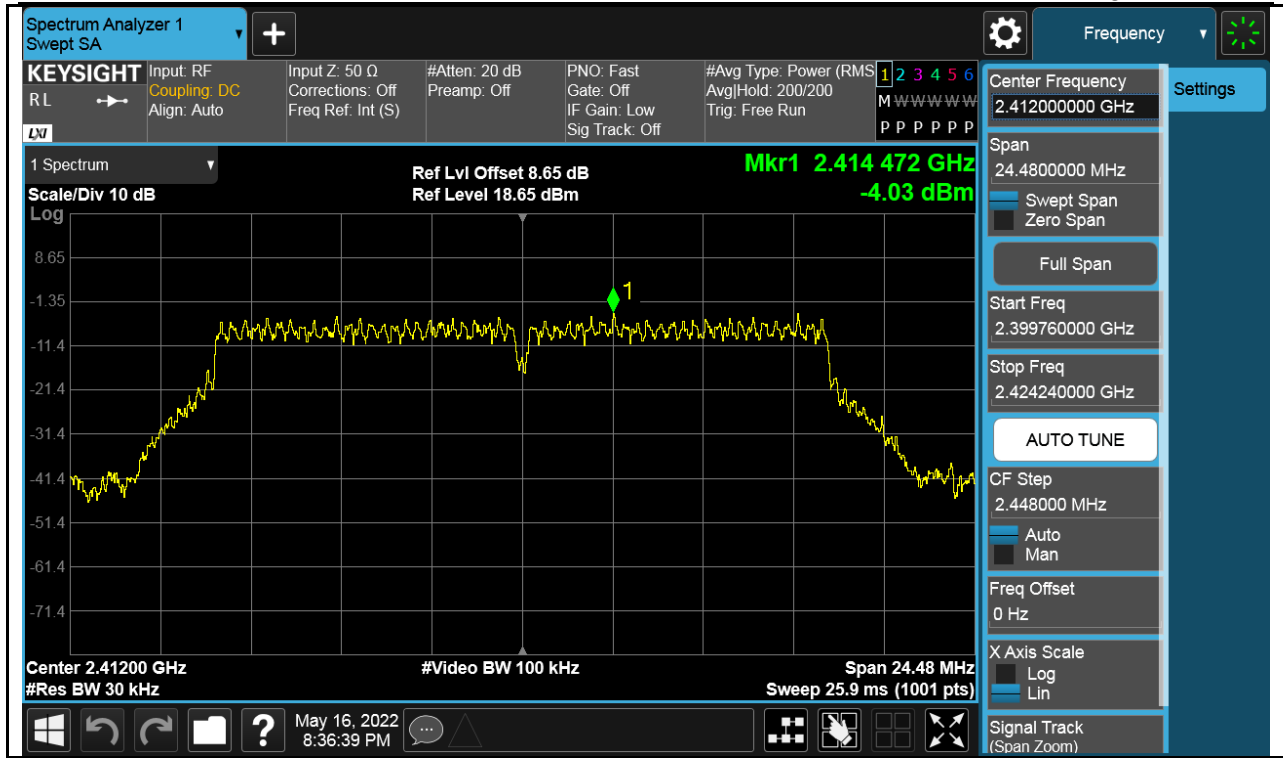

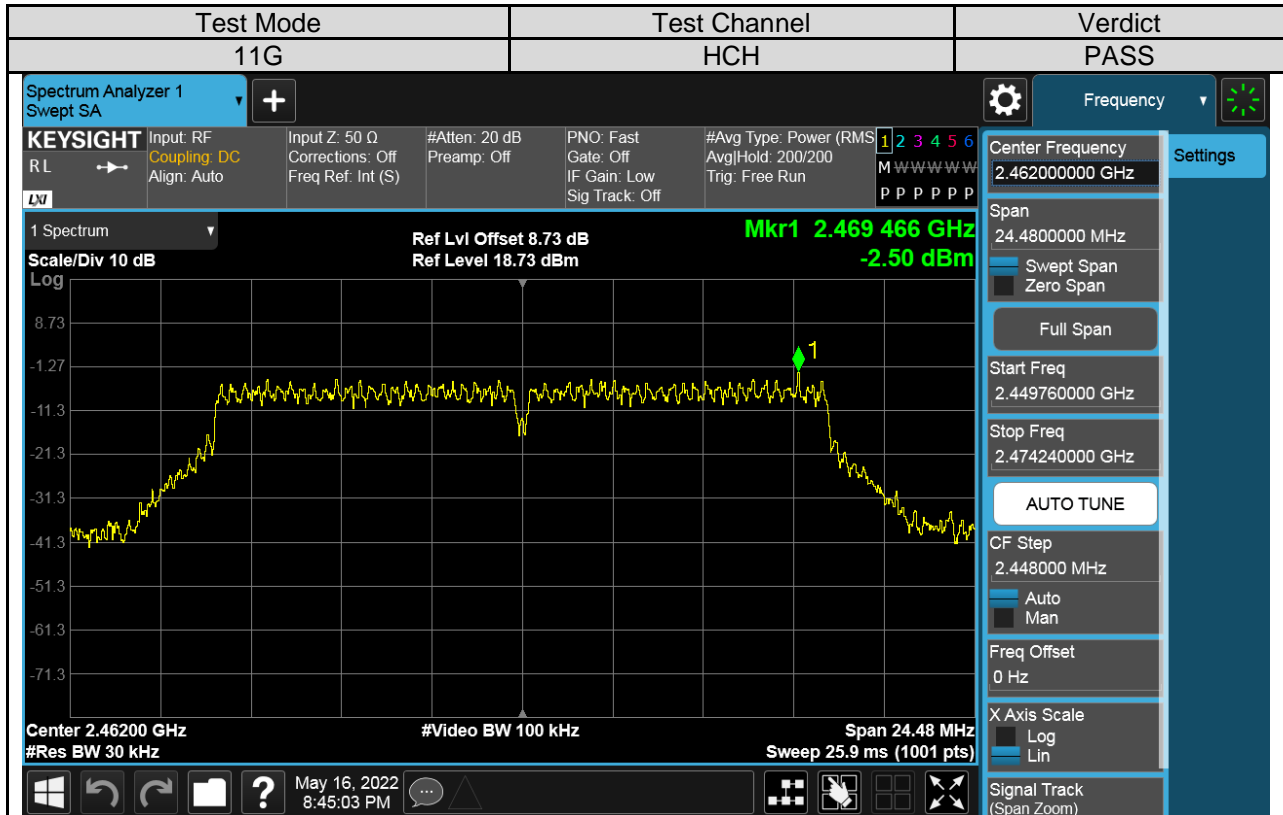
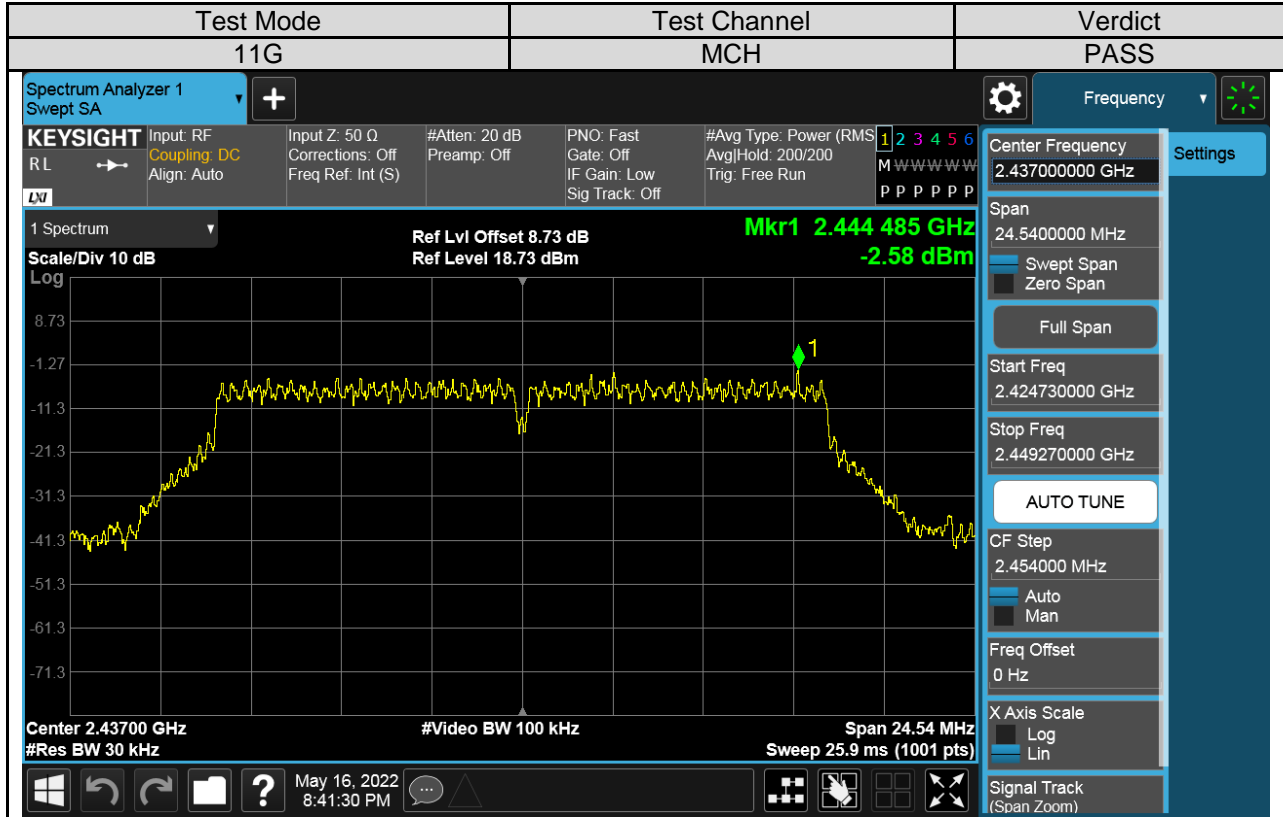

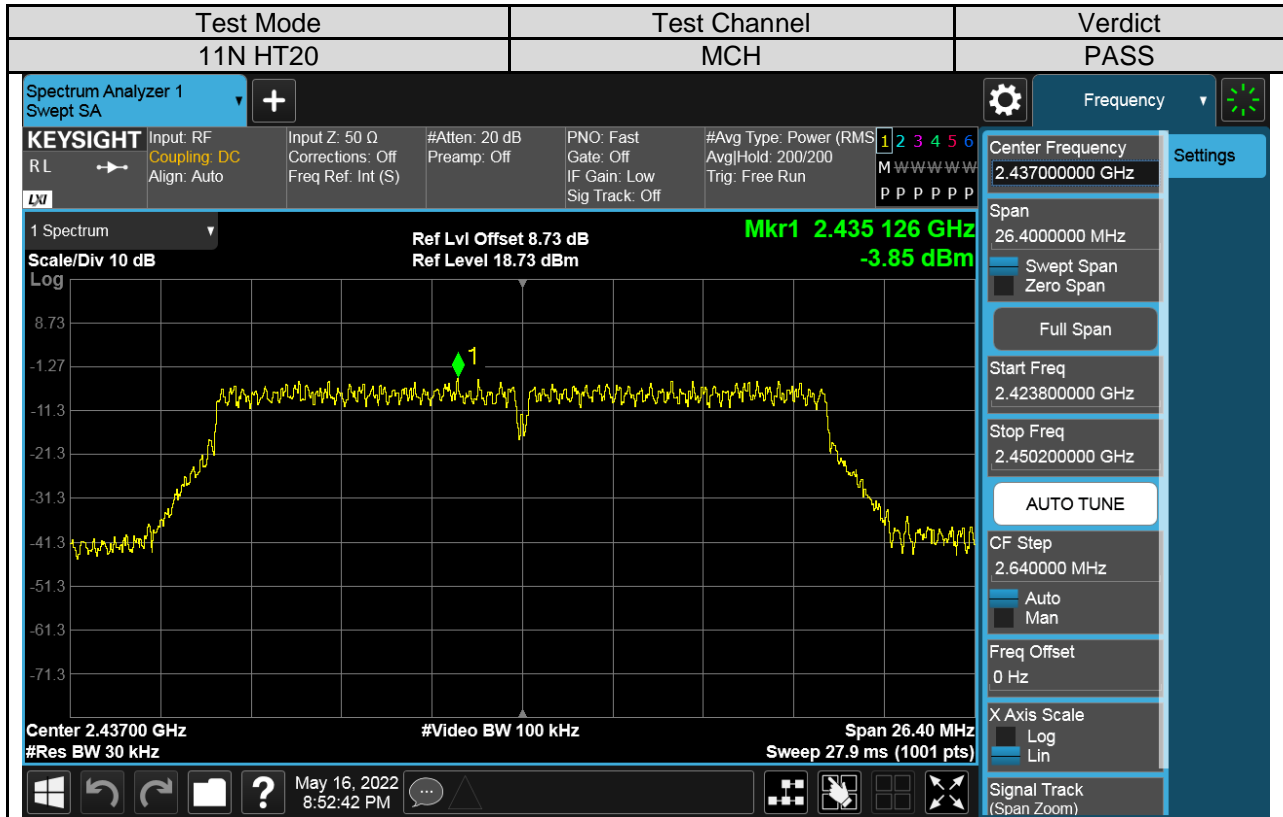
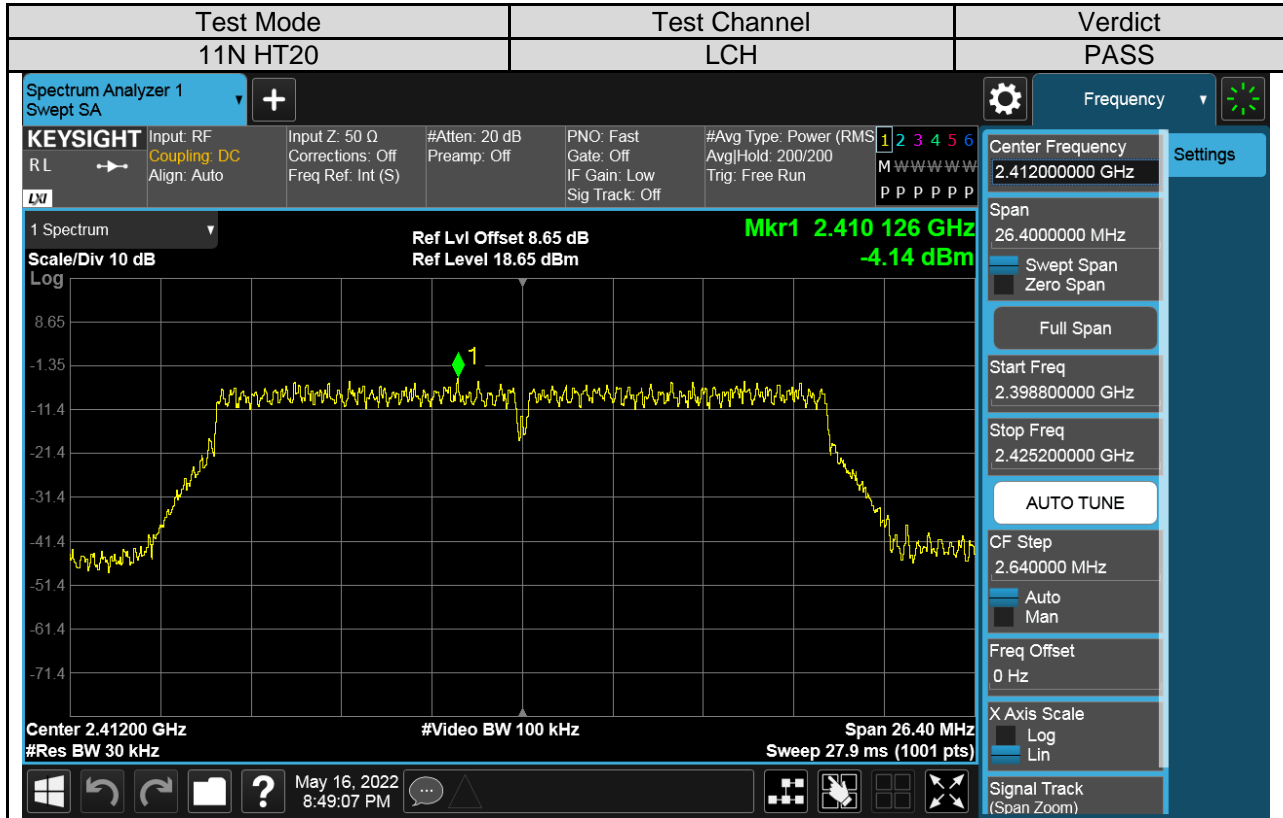

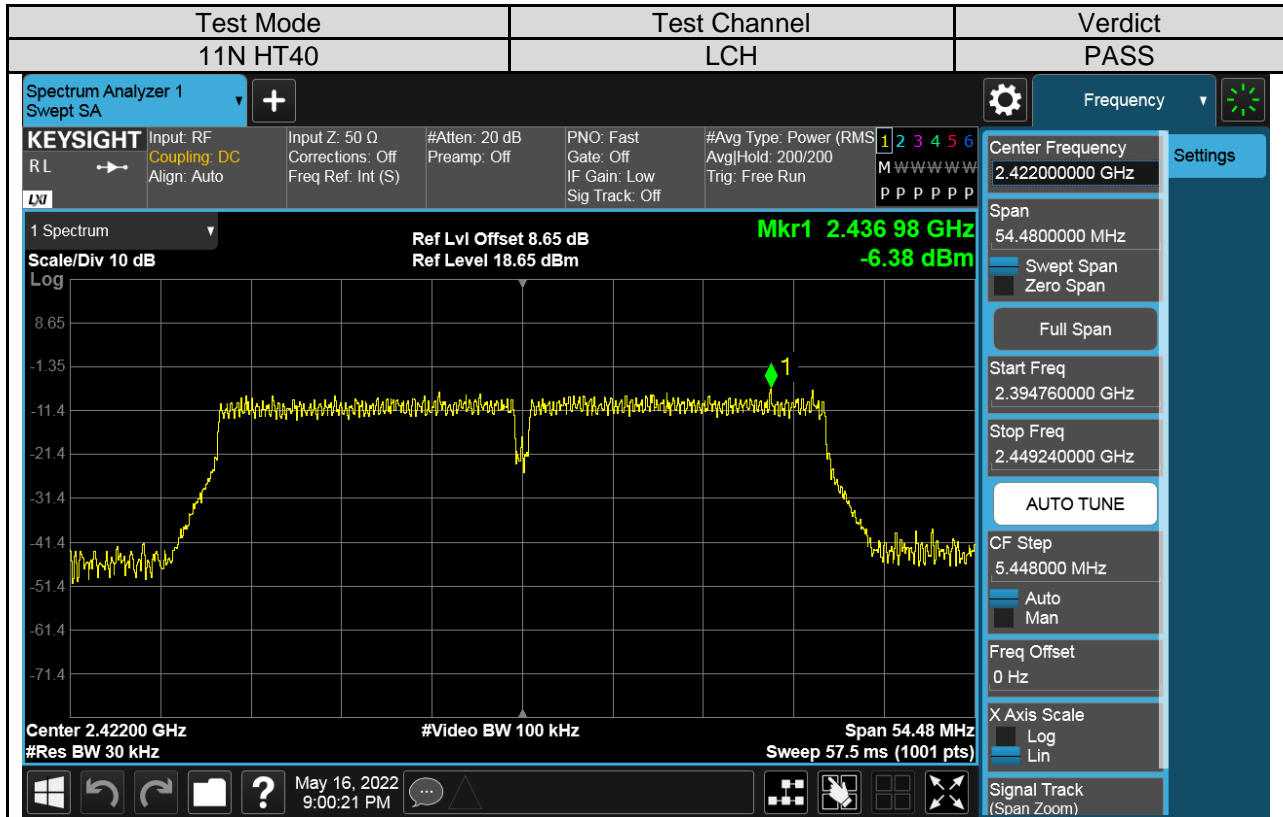
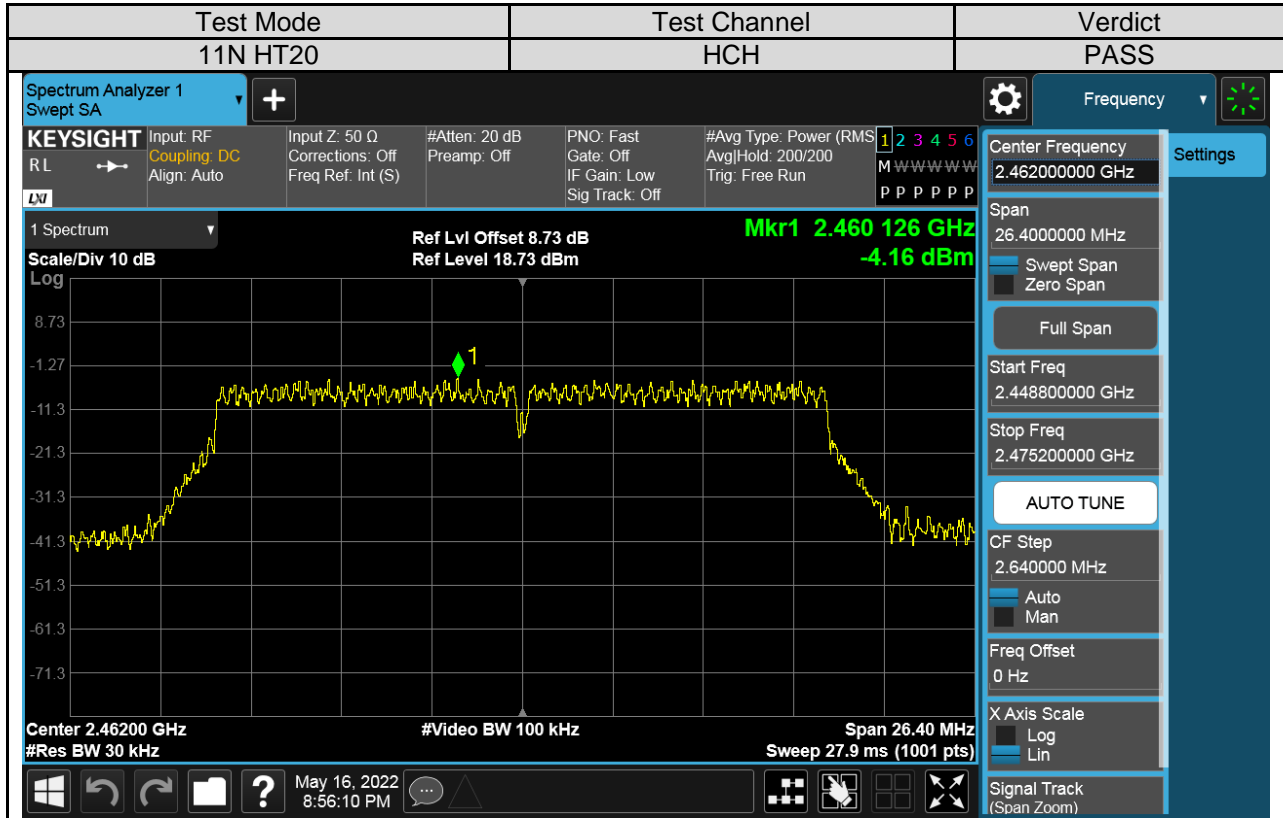

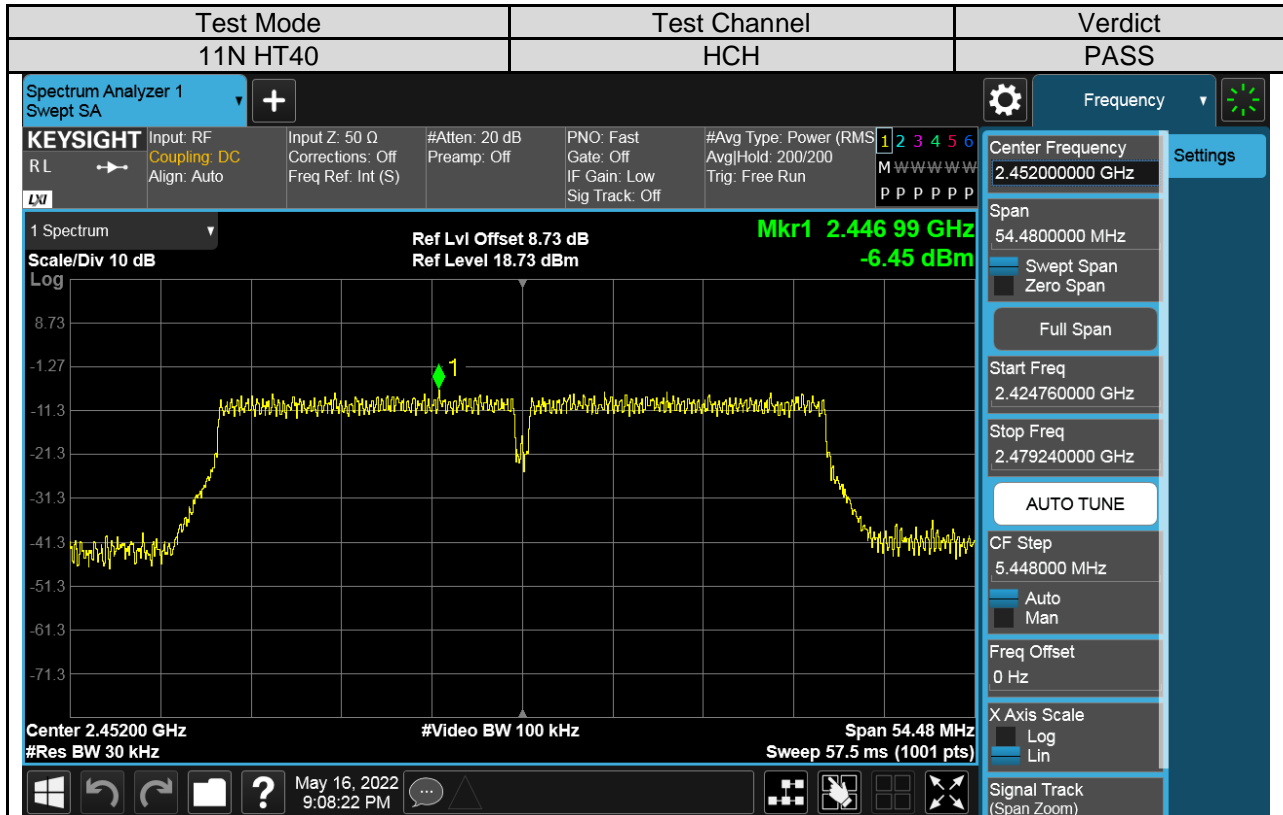
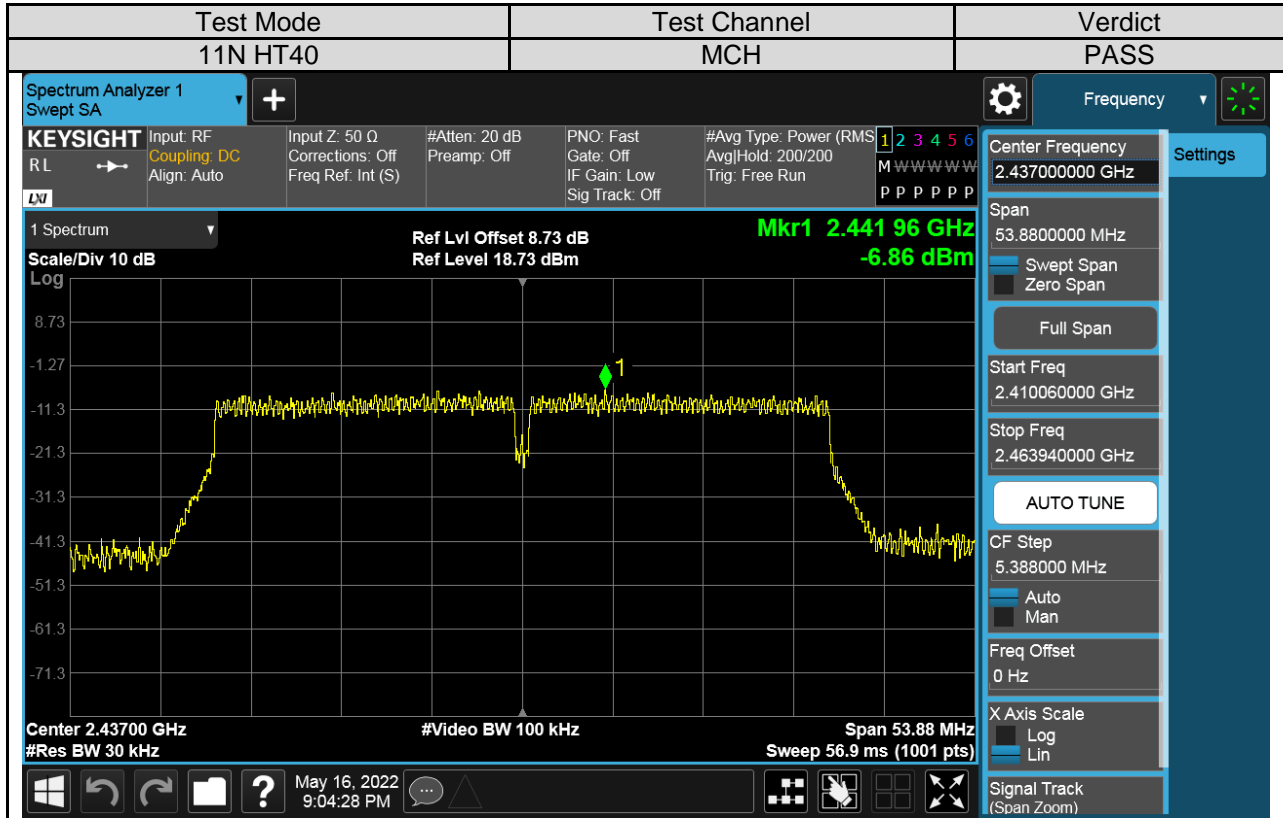

## 7.6. CONDUCTED BANDEDGE AND SPURIOUS EMISSIONS

### LIMITS

FCC Part15 (15.247) Subpart C		
Section	Test Item	Limit
FCC §15.247 (d)	Conducted Bandedge and Spurious Emissions	At least 30 dB below that in the 100 kHz bandwidth within the band that contains the highest level of the desired power

### TEST PROCEDURE

Refer to FCC KDB 558074, connect the UUT to the spectrum analyser and use the following

Center Frequency	The centre frequency of the channel under test
Detector	Peak
RBW	100K
VBW	$\geq 3 \times \text{RBW}$
Span	1.5 x DTS bandwidth
Trace	Max hold
Sweep time	Auto couple.

settings:

Use the peak marker function to determine the maximum PSD level.

Span	Set the center frequency and span to encompass frequency range to be measured
Detector	Peak
RBW	100K
VBW	$\geq 3 \times \text{RBW}$
measurement points	$\geq \text{span}/\text{RBW}$
Trace	Max hold
Sweep time	Auto couple.

Use the peak marker function to determine the maximum amplitude level.

### TEST SETUP

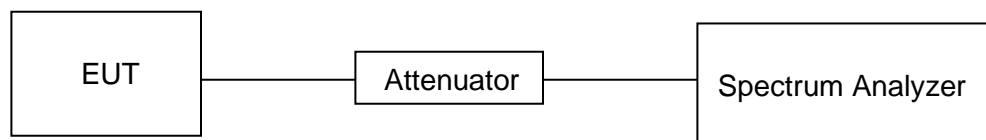

Form-ULID-008536-9 V1.0



**Part I :Conducted Bandedge**

**RESULTS TABLE**

Test Mode	Test Antenna	Test Channel	Test Result	Verdict
11B	Antenna 1	LCH	See the test graphs	PASS
		HCH	See the test graphs	PASS
11G	Antenna 1	LCH	See the test graphs	PASS
		HCH	See the test graphs	PASS
11N HT20	Antenna 1	LCH	See the test graphs	PASS
		HCH	See the test graphs	PASS
11N HT40	Antenna 1	LCH	See the test graphs	PASS
		HCH	See the test graphs	PASS



TEST GRAPHS

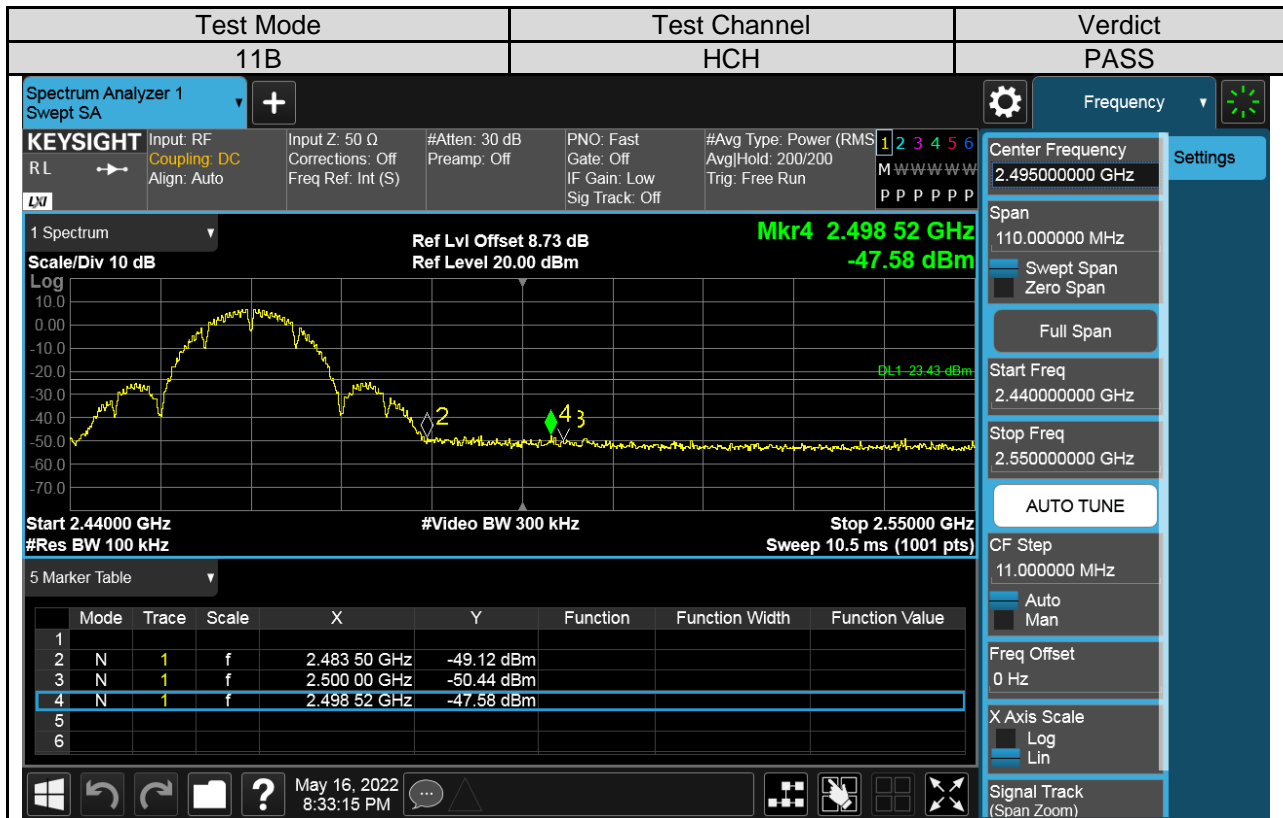
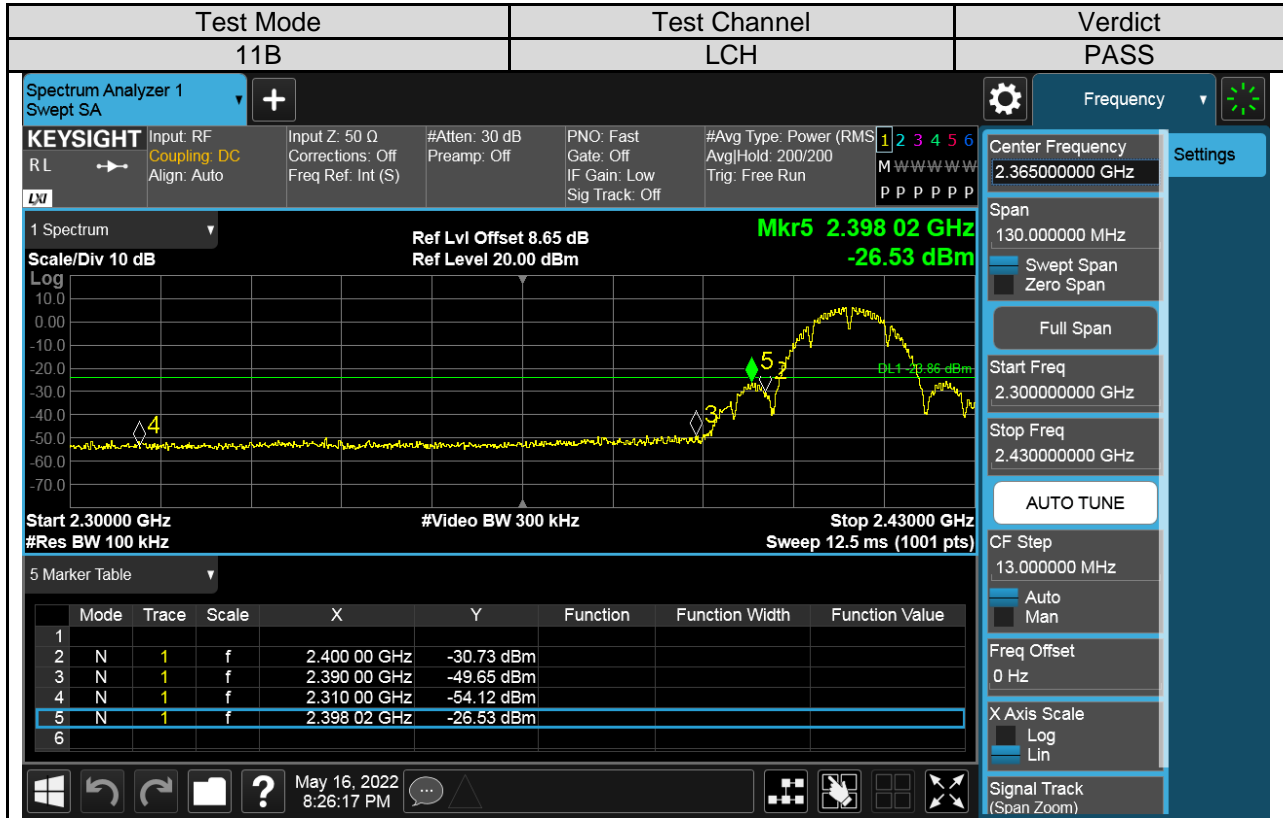

Form-ULID-008536-9 V1.0

UL-CCIC COMPANY LIMITED

This report shall not be reproduced except in full, without the written approval of UL-CCIC COMPANY LIMITED.



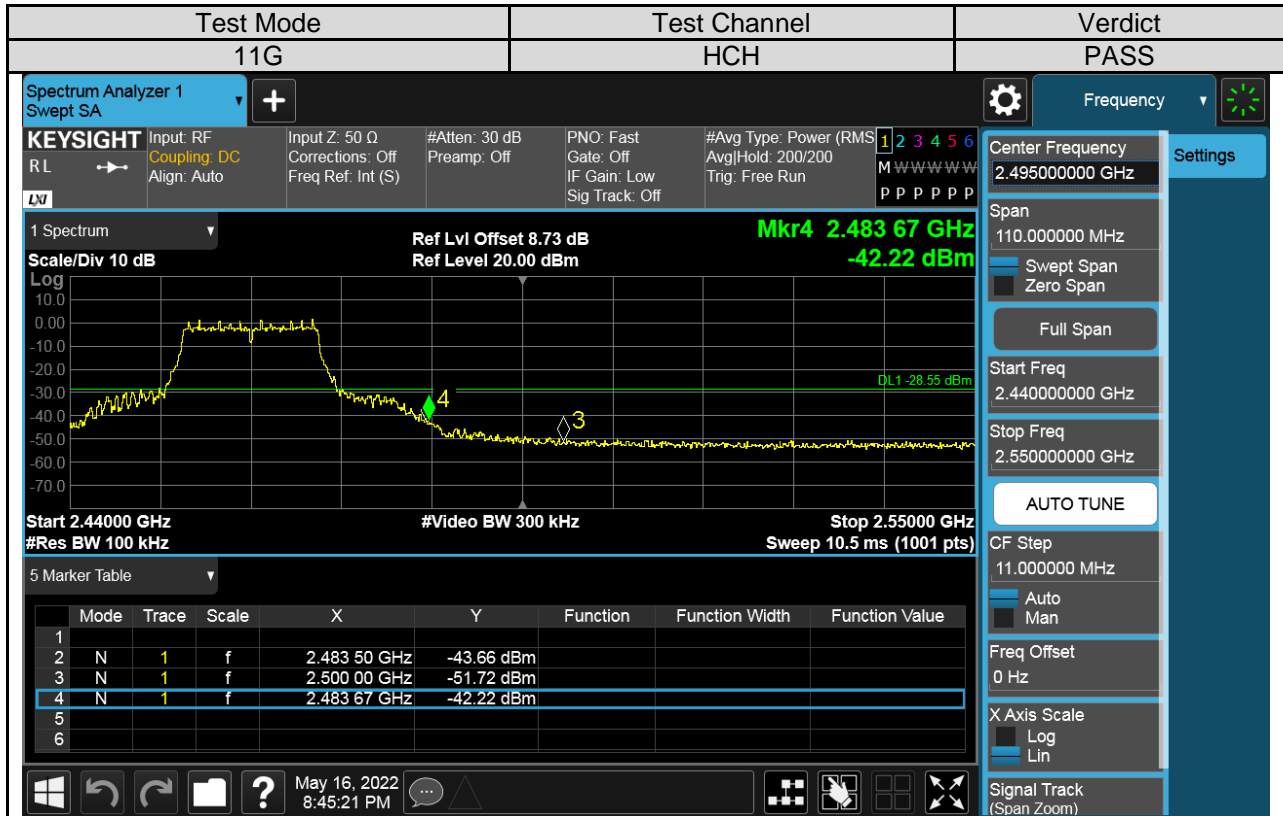

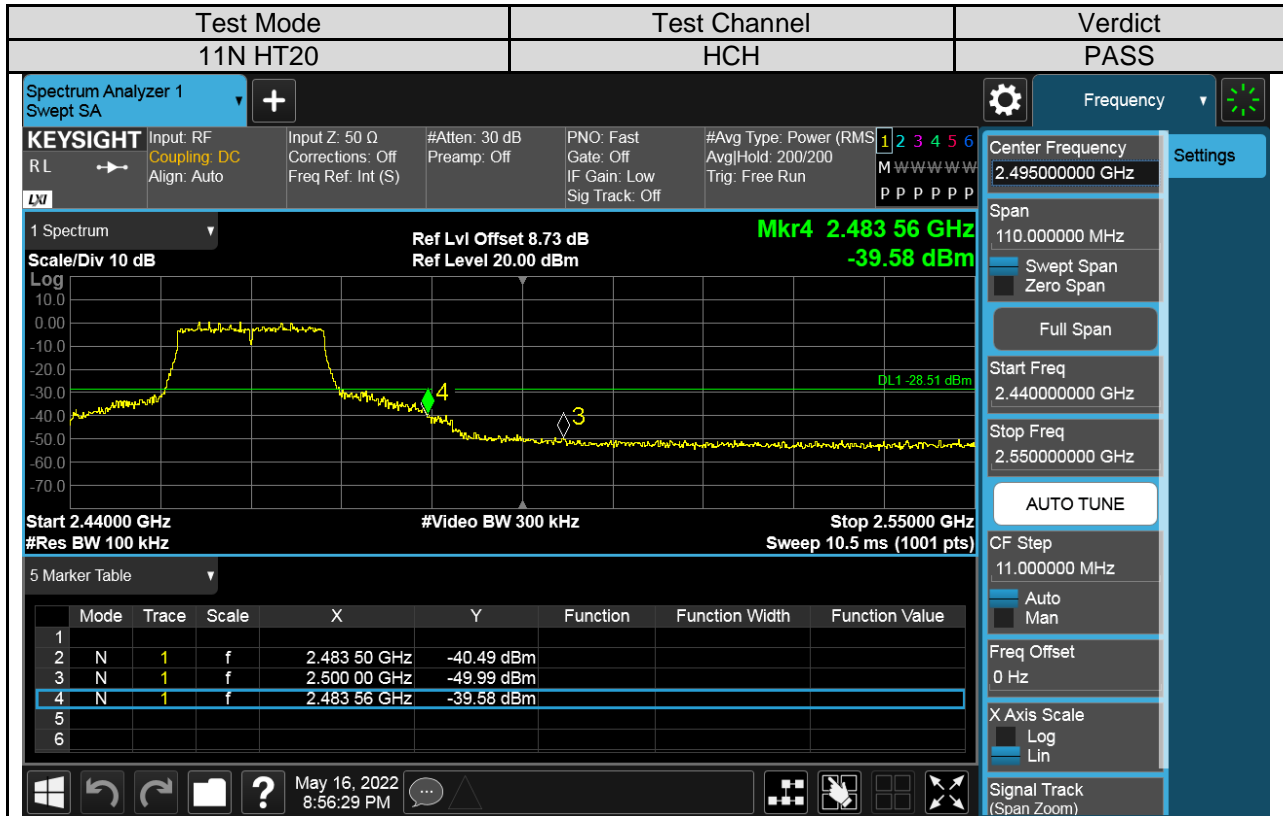
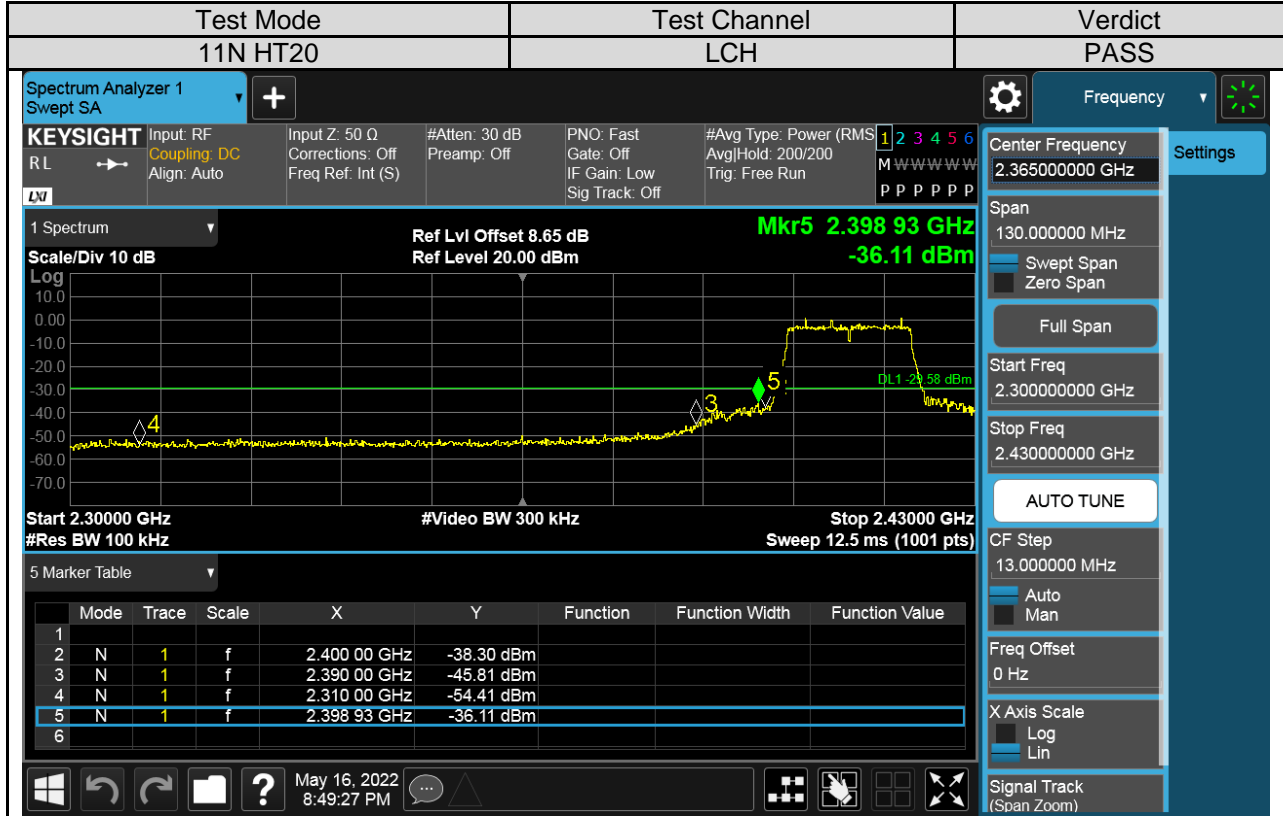

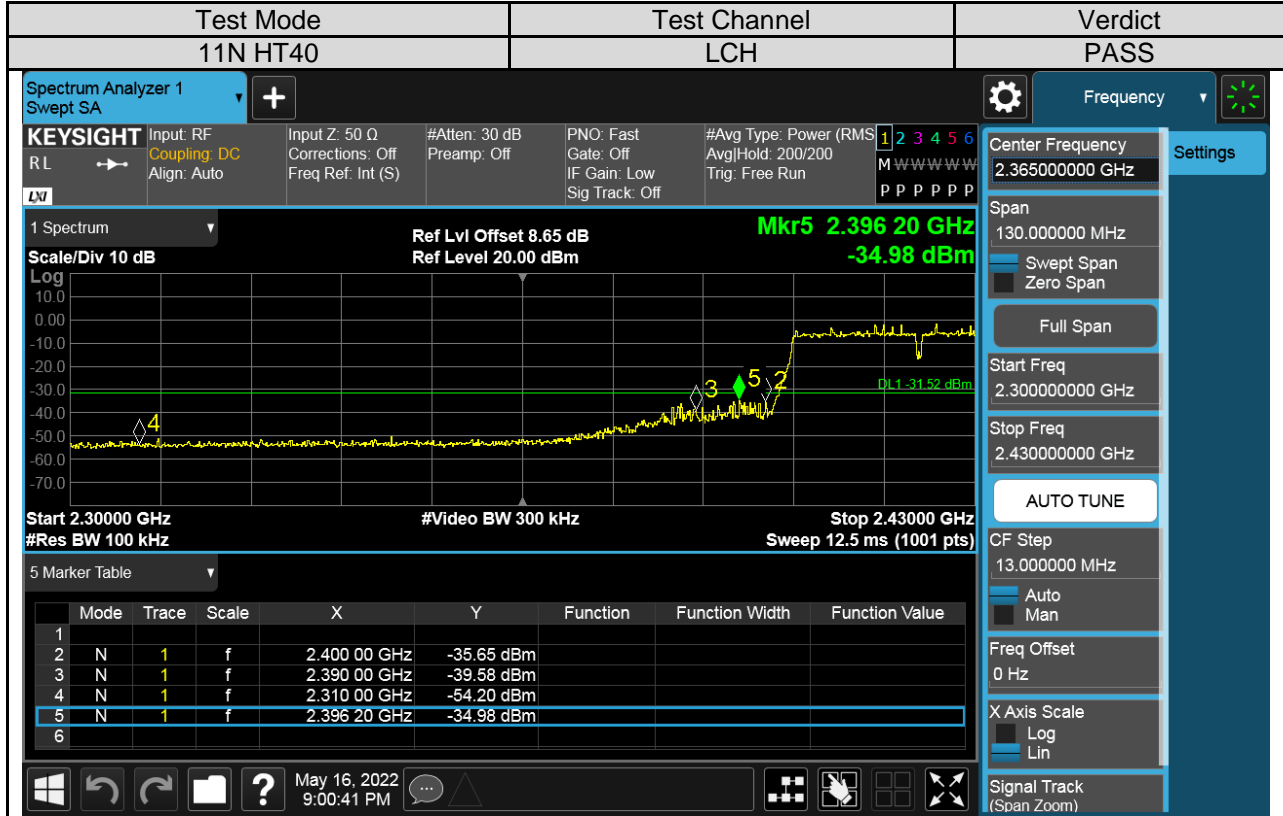

Form-ULID-008536-9 V1.0

UL-CCIC COMPANY LIMITED

This report shall not be reproduced except in full, without the written approval of UL-CCIC COMPANY LIMITED.



**Part II :Conducted Emission**

Test Result Table

Test Mode	Test Antenna	Channel	Pref(dBm)	Puw(dBm)	Verdict
11B SISO	Antenna 1	LCH	See the test graphs	<Limit	PASS
		MCH	See the test graphs	<Limit	PASS
		HCH	See the test graphs	<Limit	PASS
11G SISO	Antenna 1	LCH	See the test graphs	<Limit	PASS
		MCH	See the test graphs	<Limit	PASS
		HCH	See the test graphs	<Limit	PASS
11N HT20	Antenna 1	LCH	See the test graphs	<Limit	PASS
		MCH	See the test graphs	<Limit	PASS
		HCH	See the test graphs	<Limit	PASS
11N HT40	Antenna 1	LCH	See the test graphs	<Limit	PASS
		MCH	See the test graphs	<Limit	PASS
		HCH	See the test graphs	<Limit	PASS



**Test Plots**

Test Mode	Channel	Verdict
11B	LCH	PASS

**Pref test Plot**

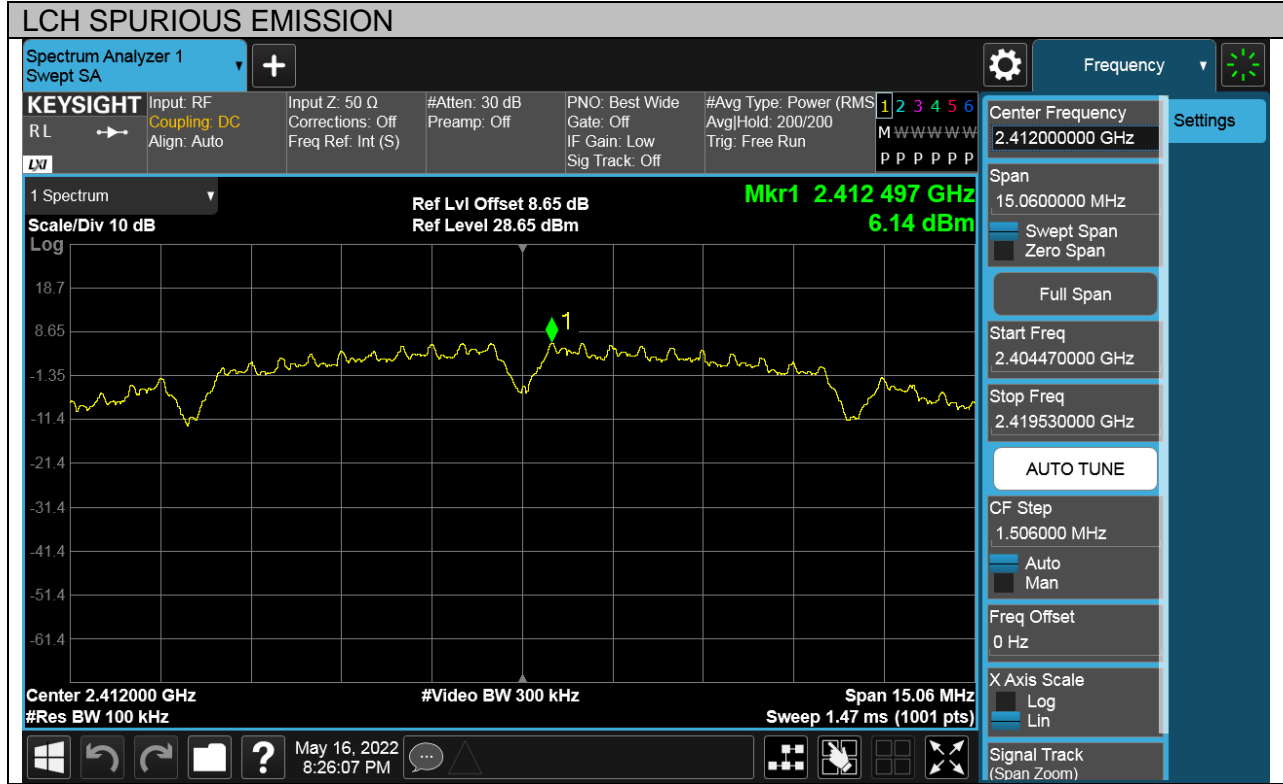



Puw test Plot

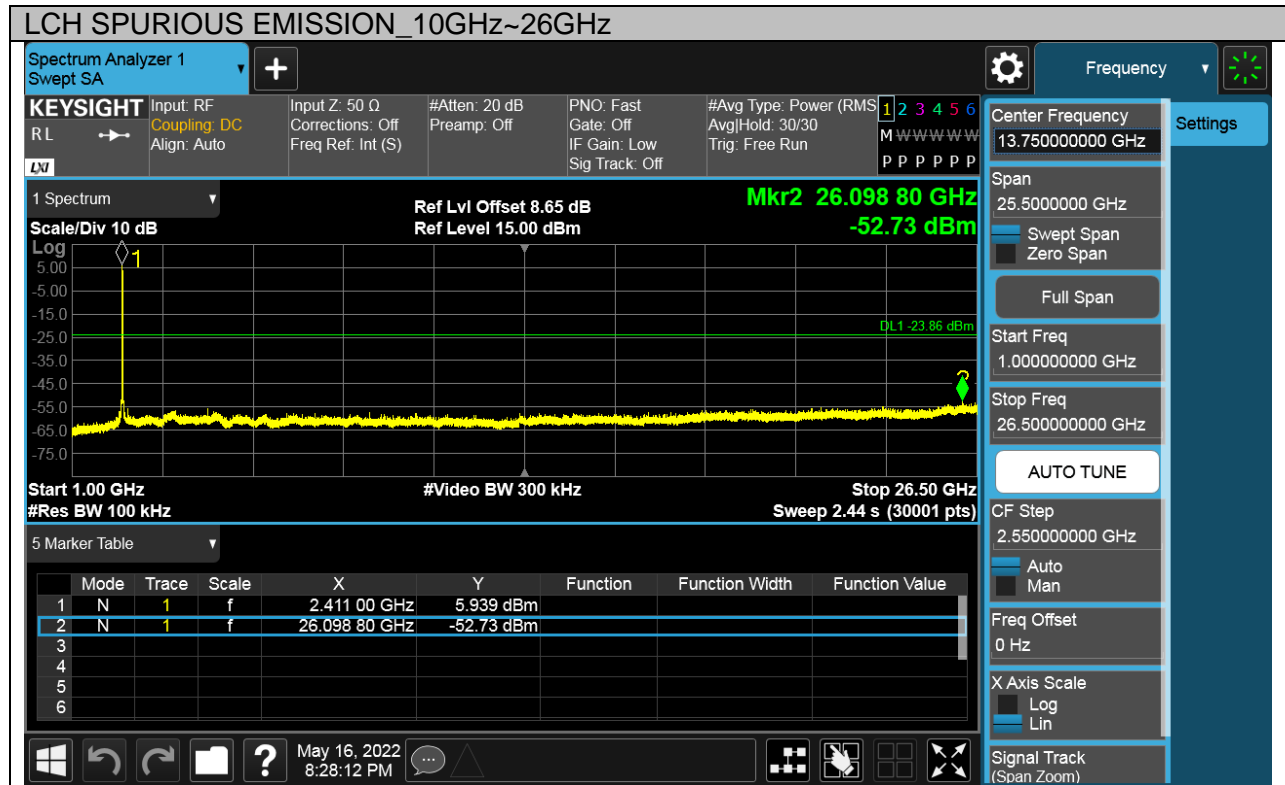
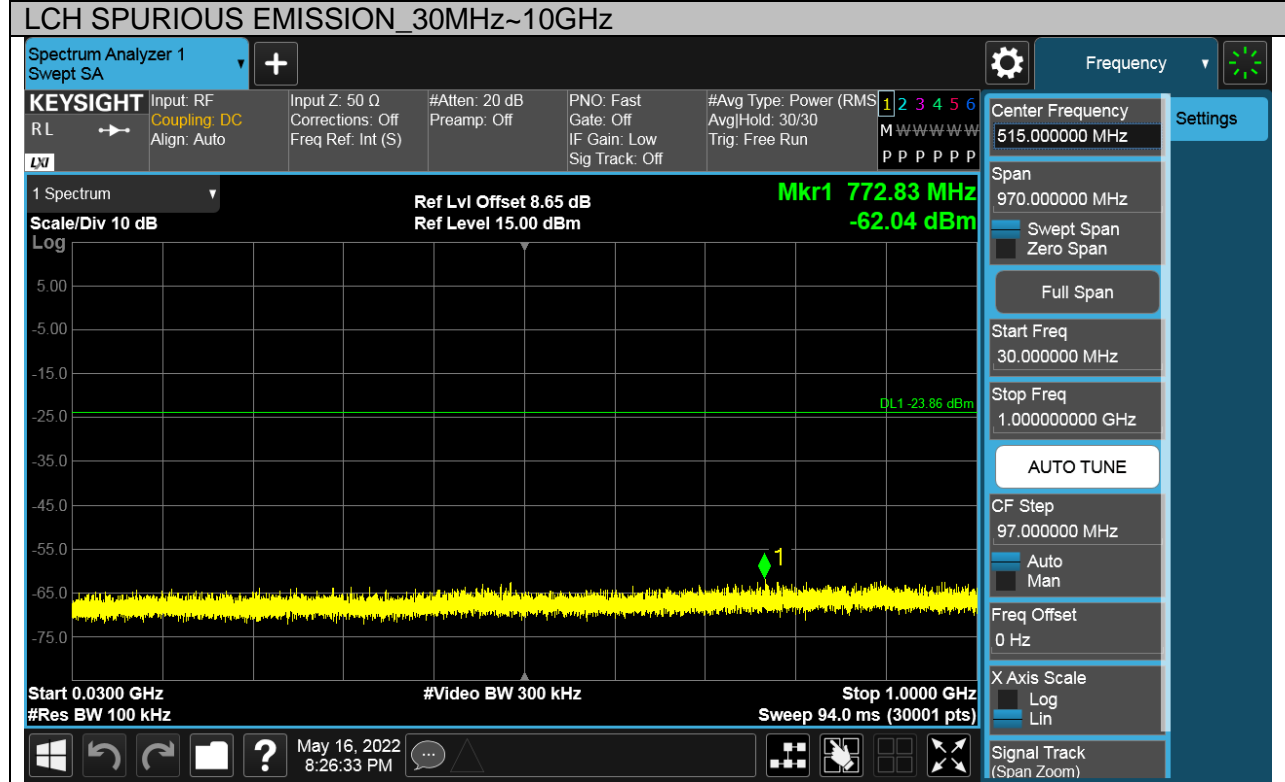



Test Mode	Channel	Verdict
11B	MCH	PASS

Pref test Plot

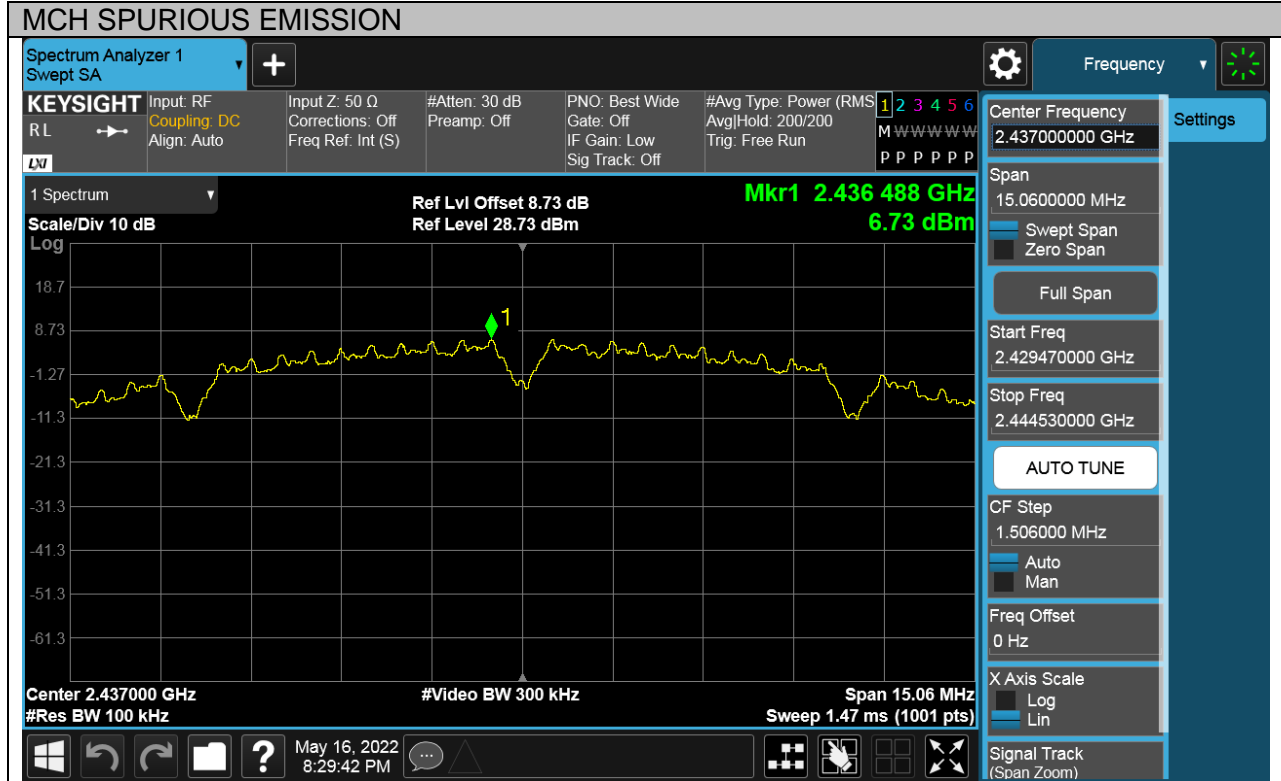



Puw test Plot

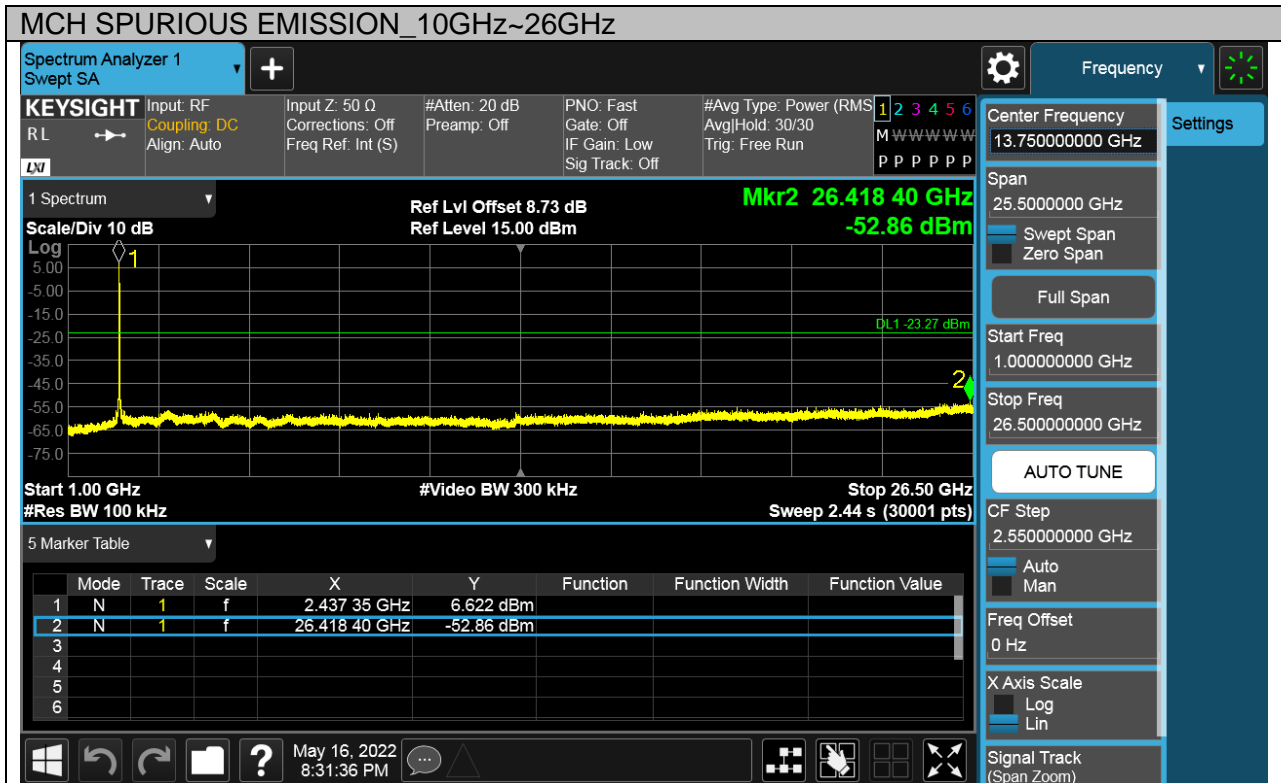
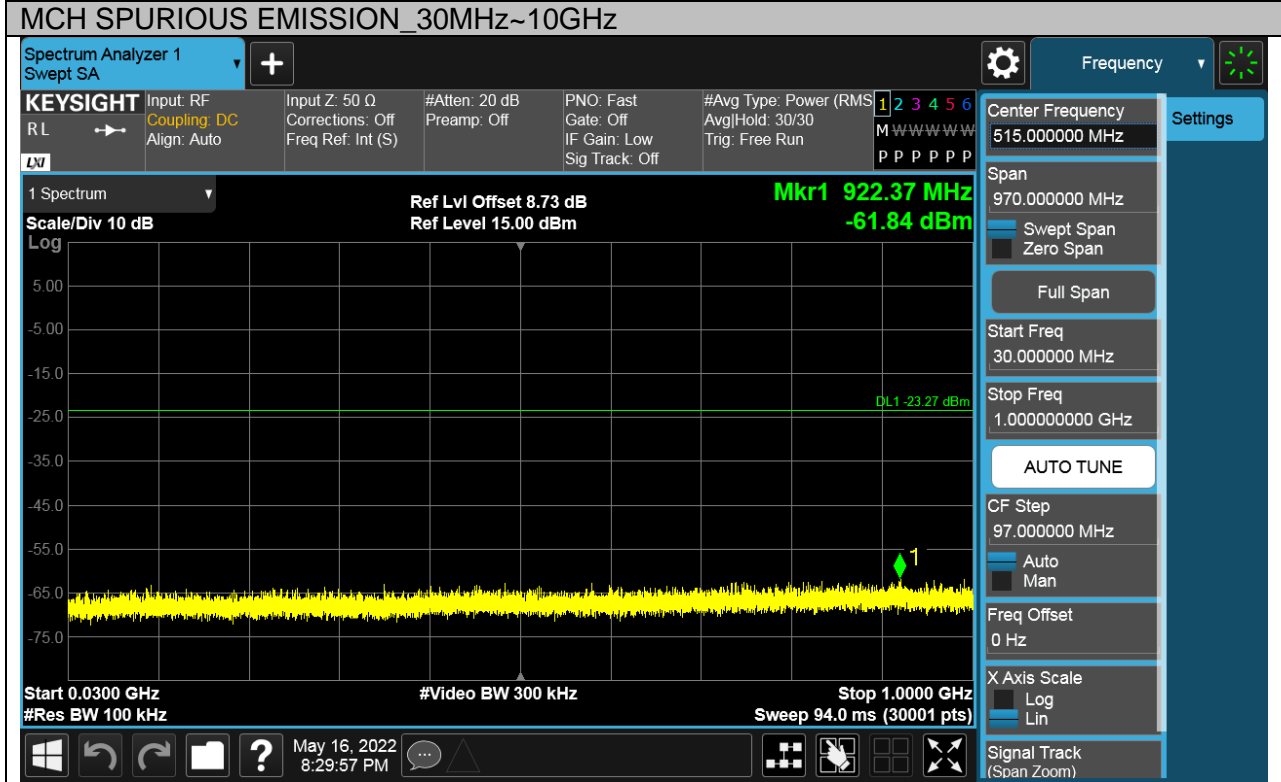





Test Mode	Channel	Verdict
11B	HCH	PASS

Pref test Plot

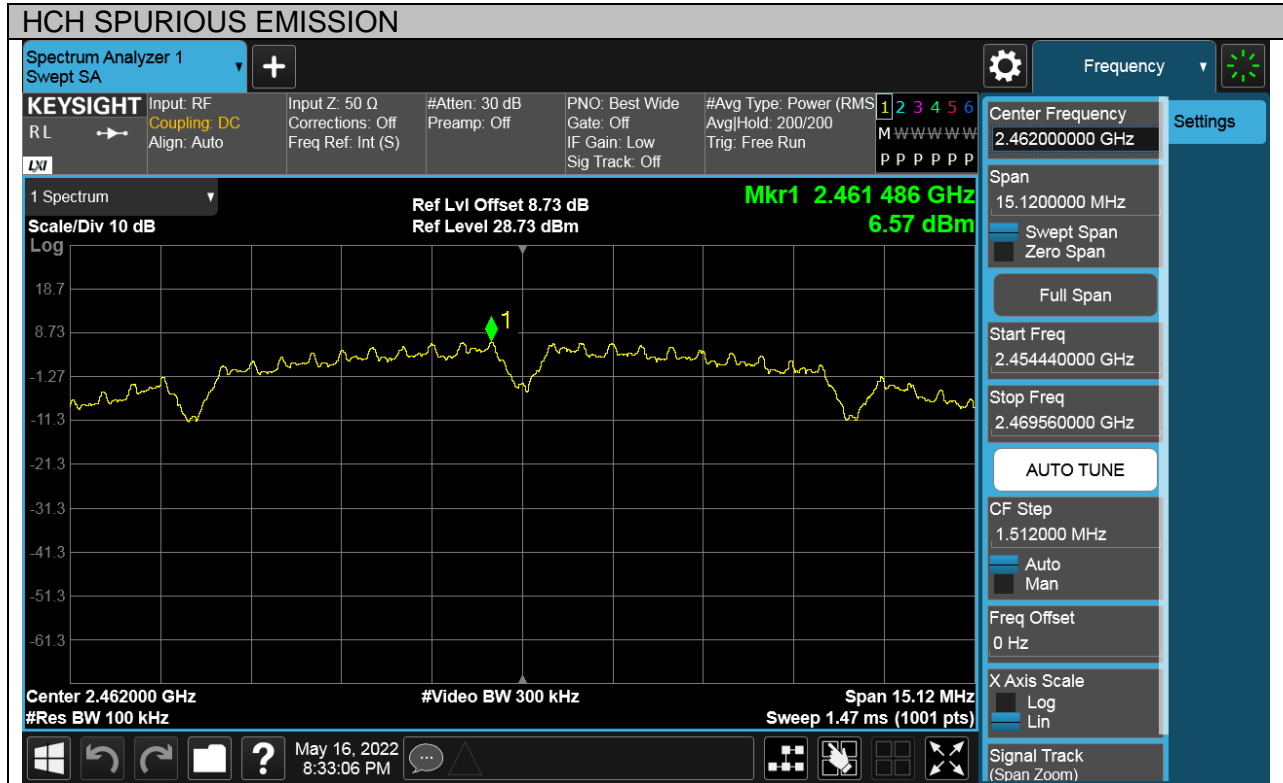



Puw test Plot

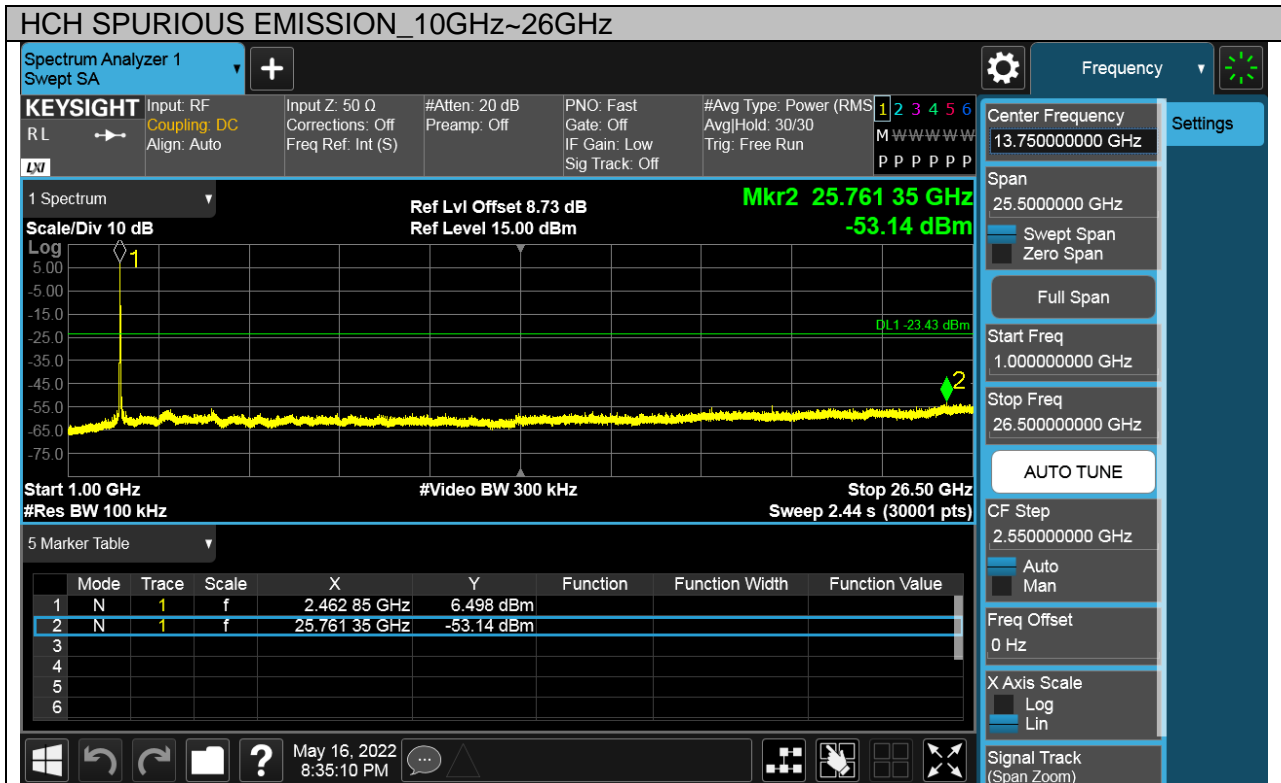
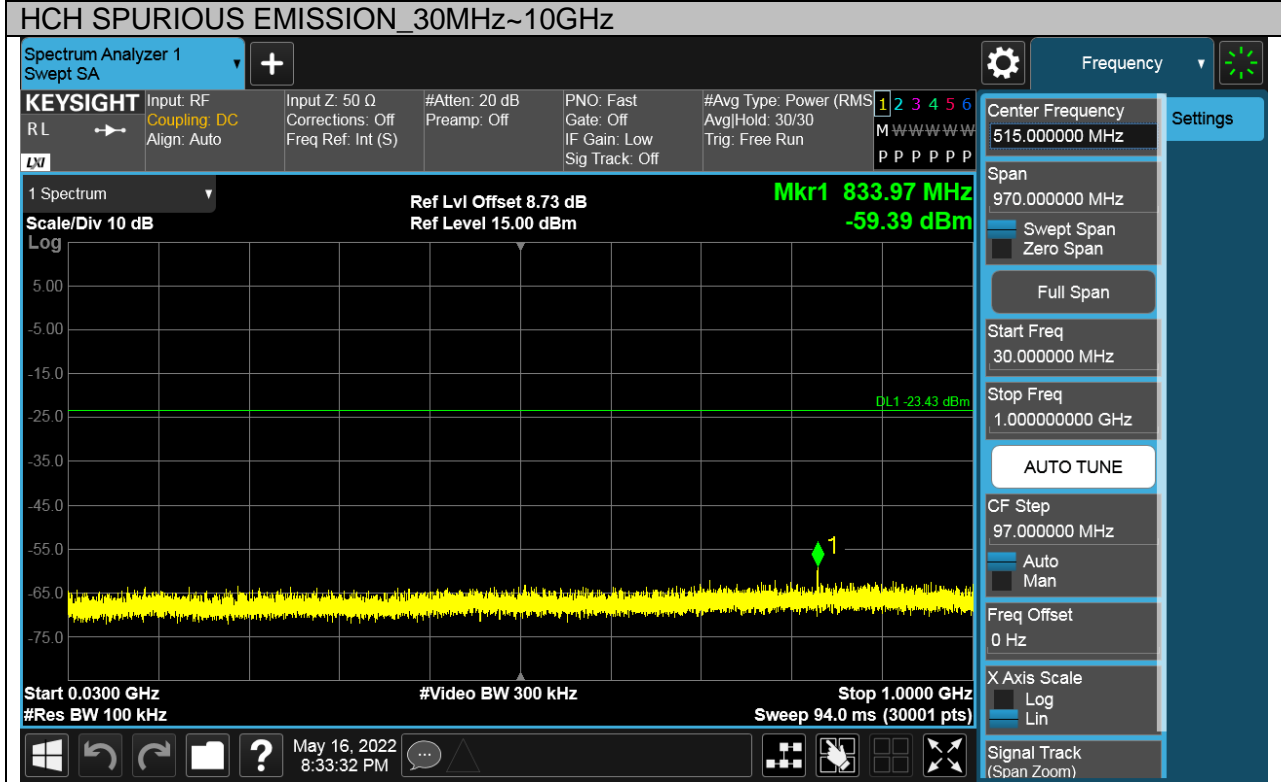



Test Mode	Channel	Verdict
11G	LCH	PASS

Pref test Plot

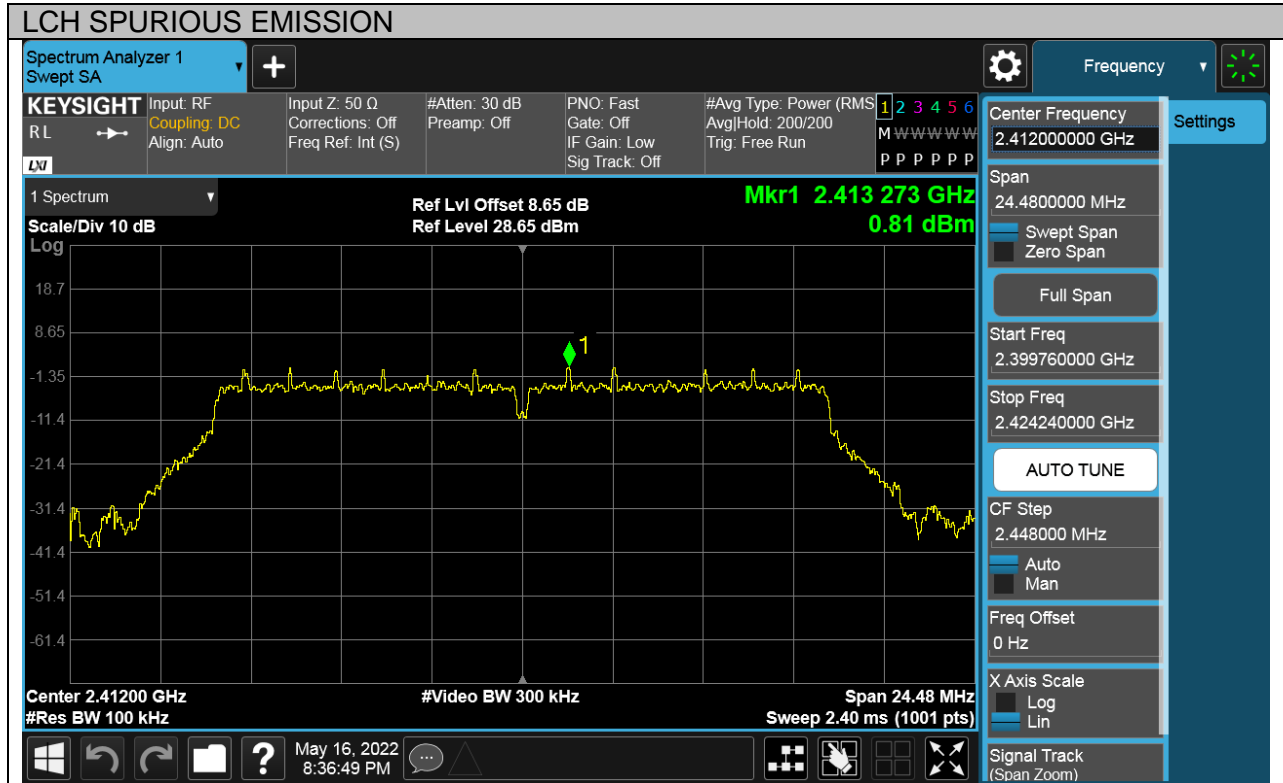



Puw test Plot

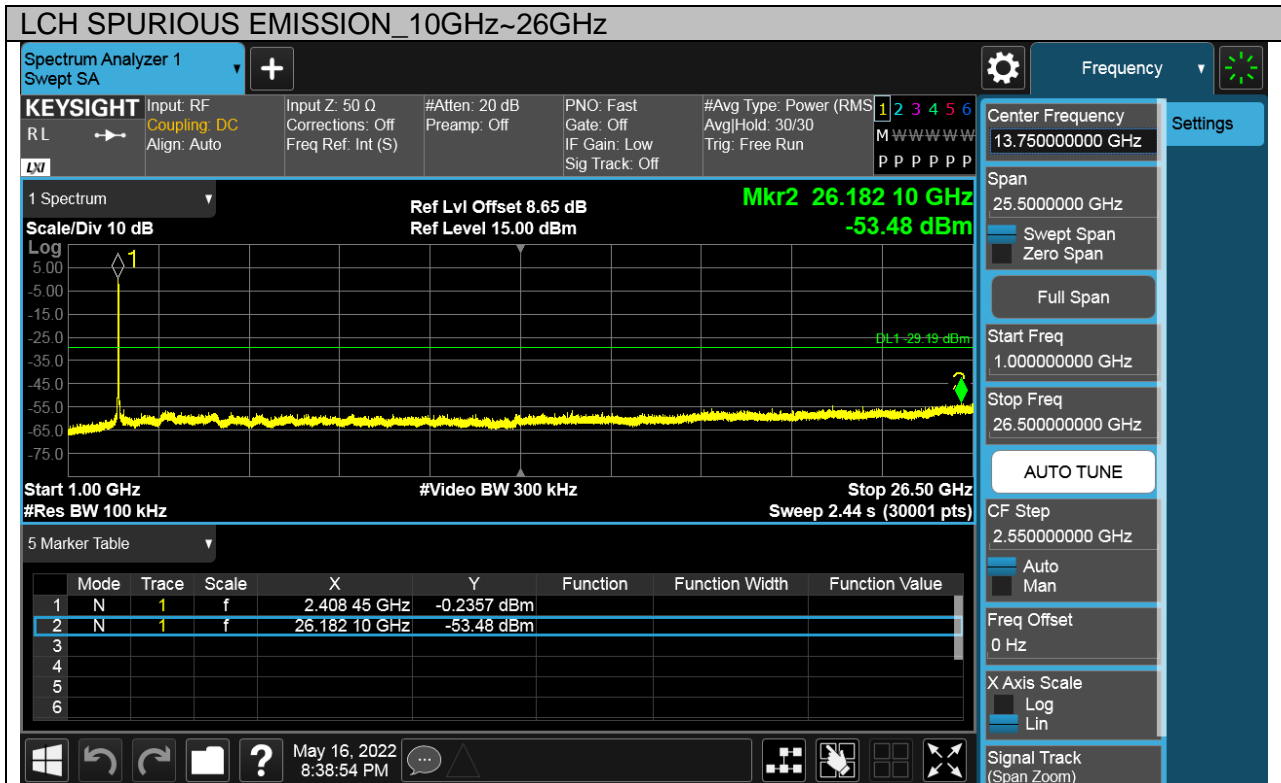
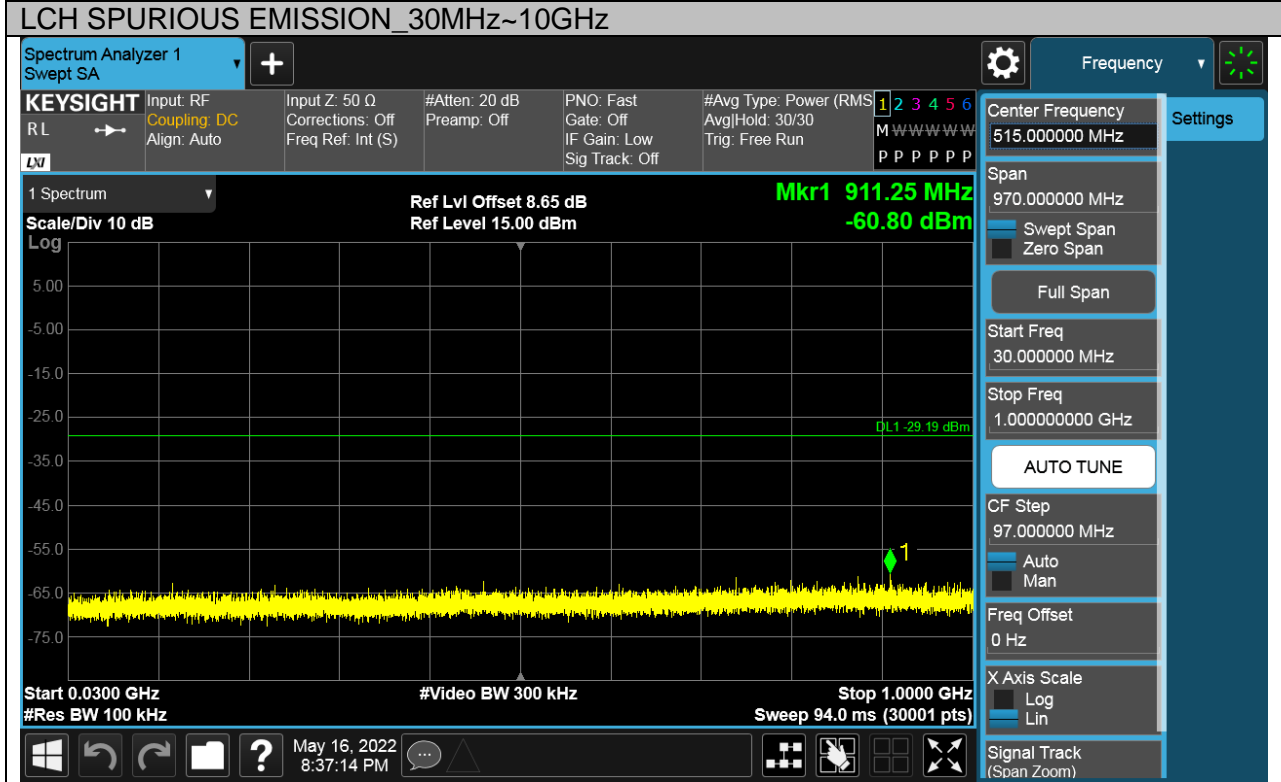



Test Mode	Channel	Verdict
11G	MCH	PASS

Pref test Plot

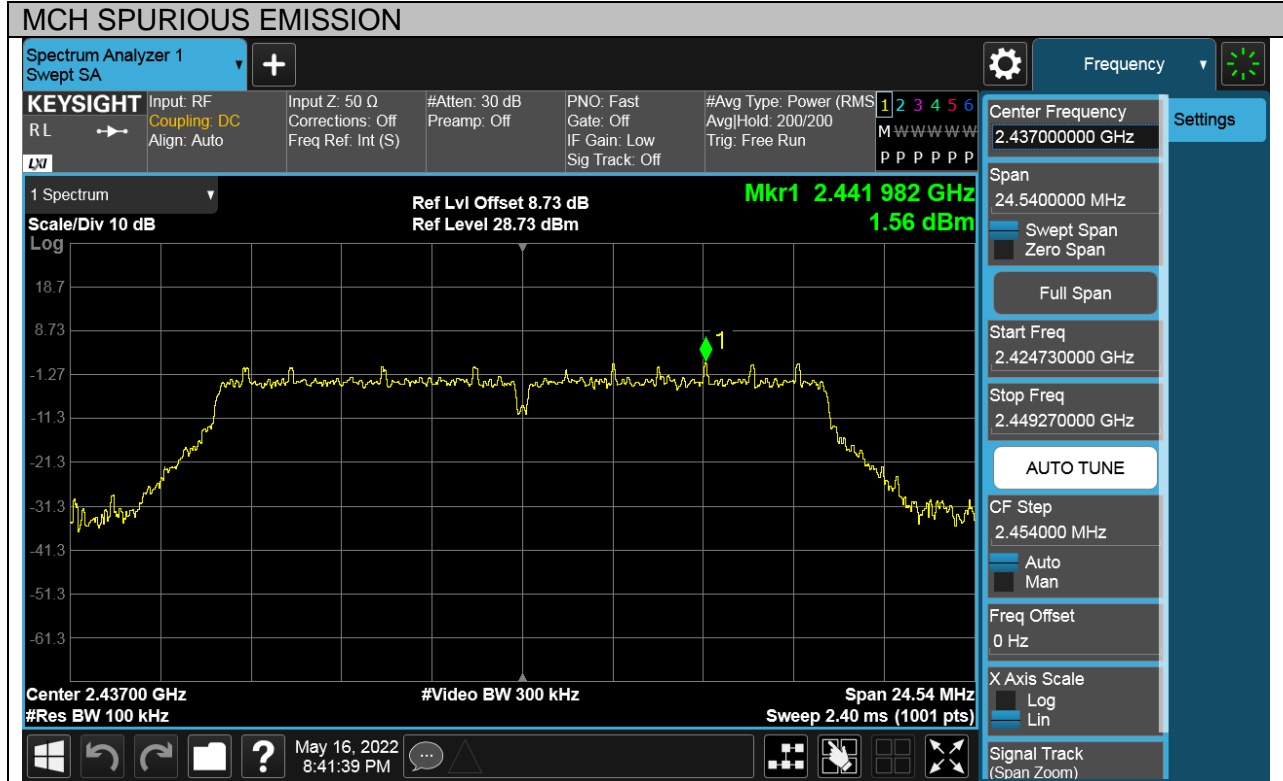



Puw test Plot

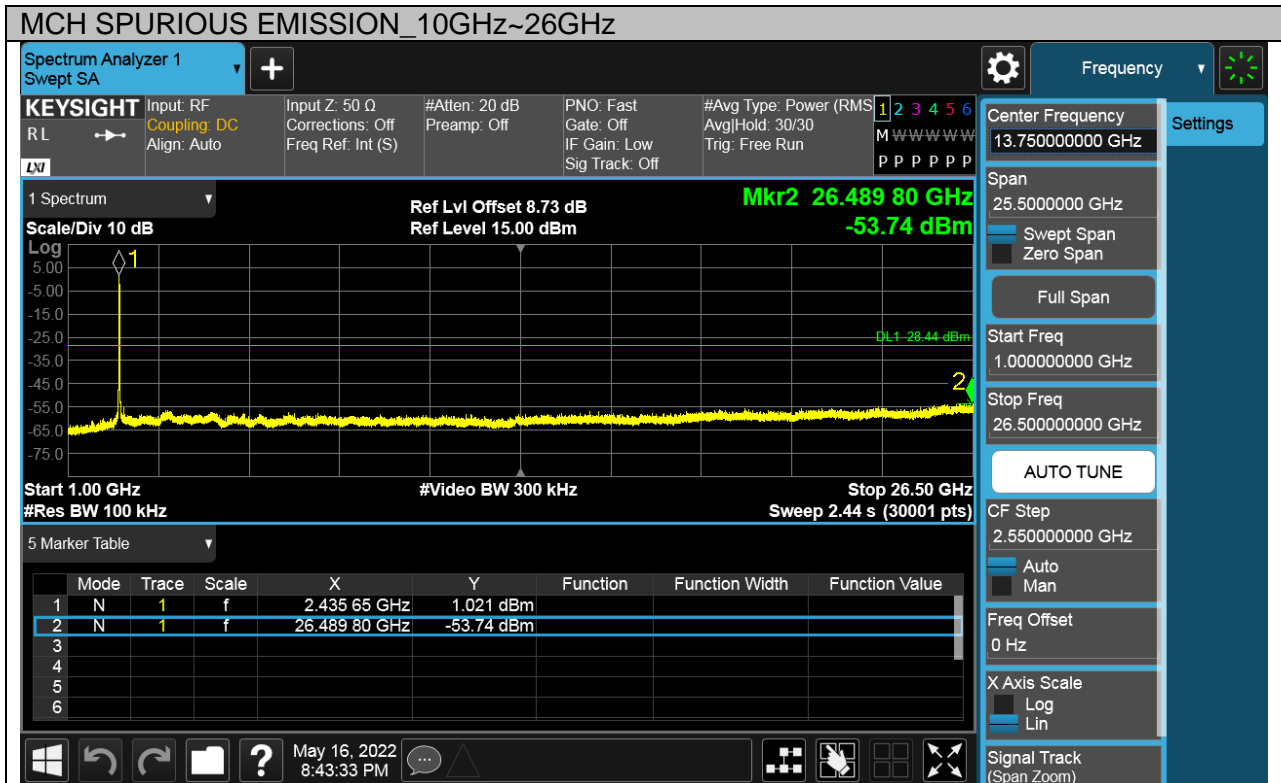
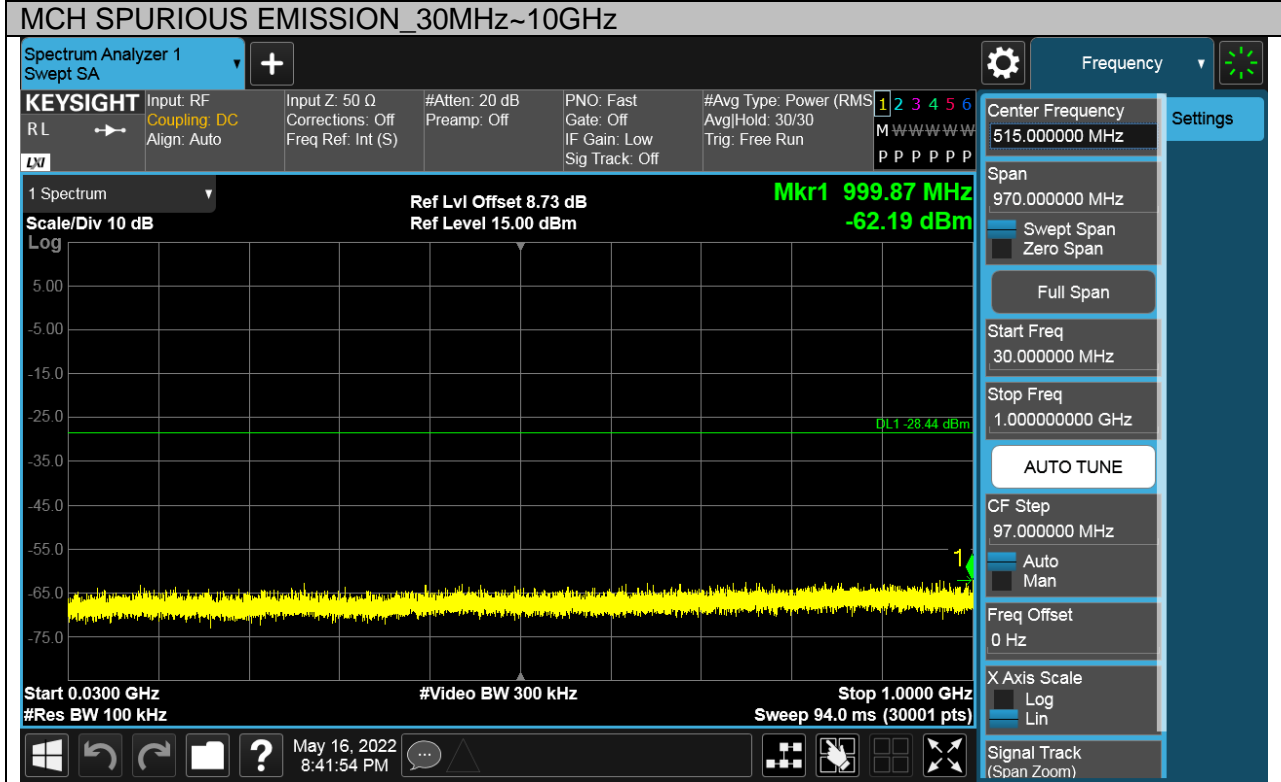



Test Mode	Channel	Verdict
11G	HCH	PASS

Pref test Plot

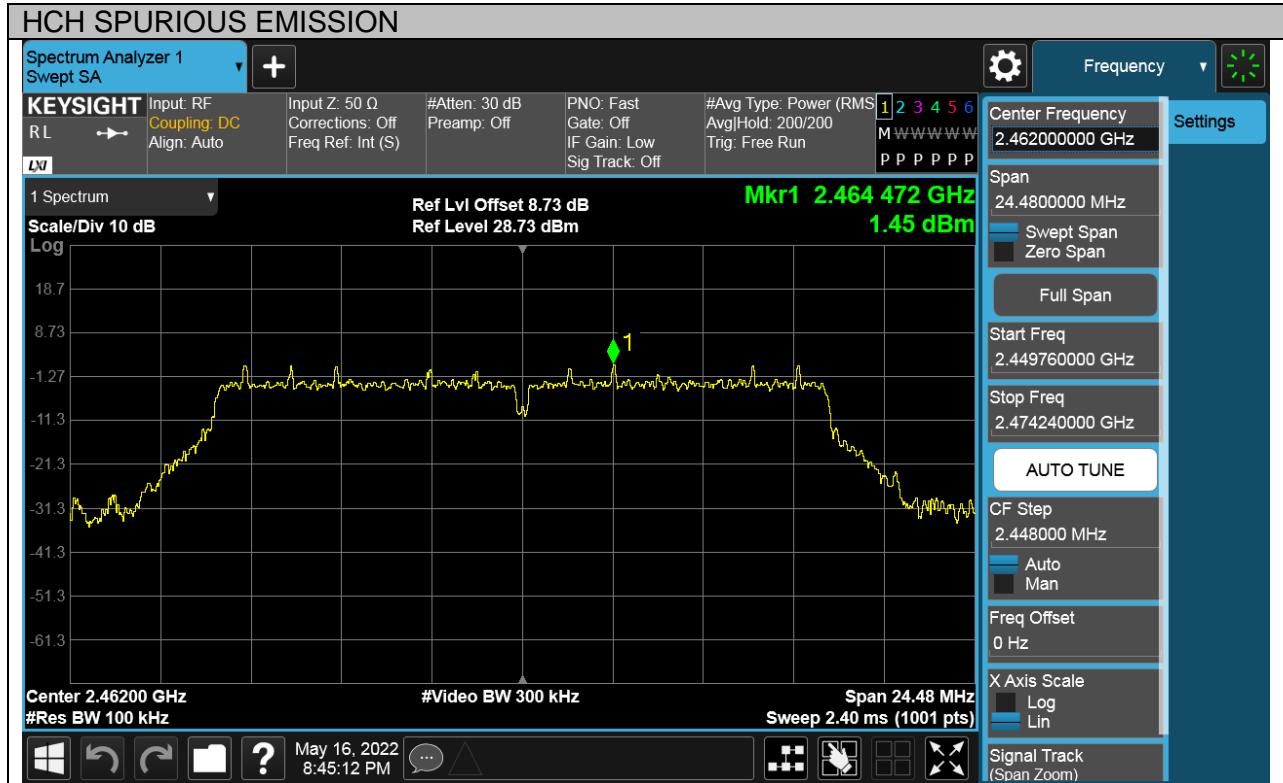



Puw test Plot

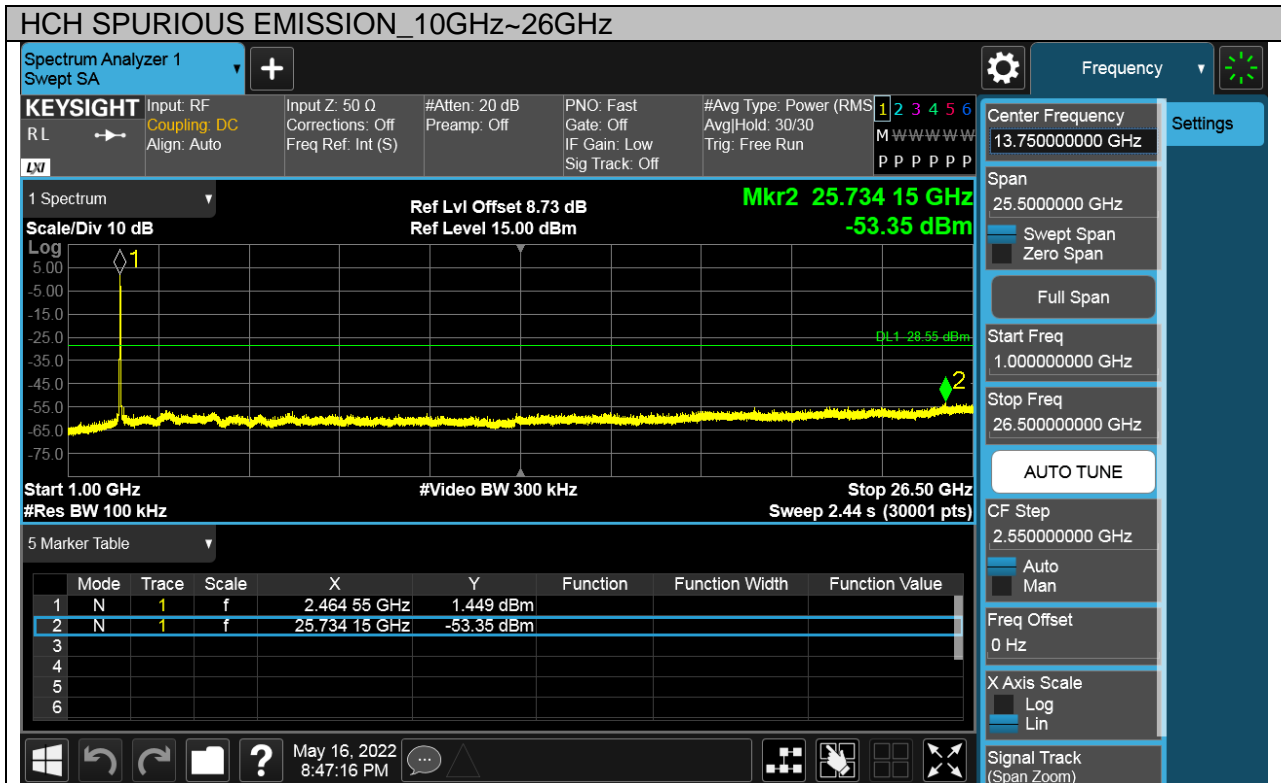
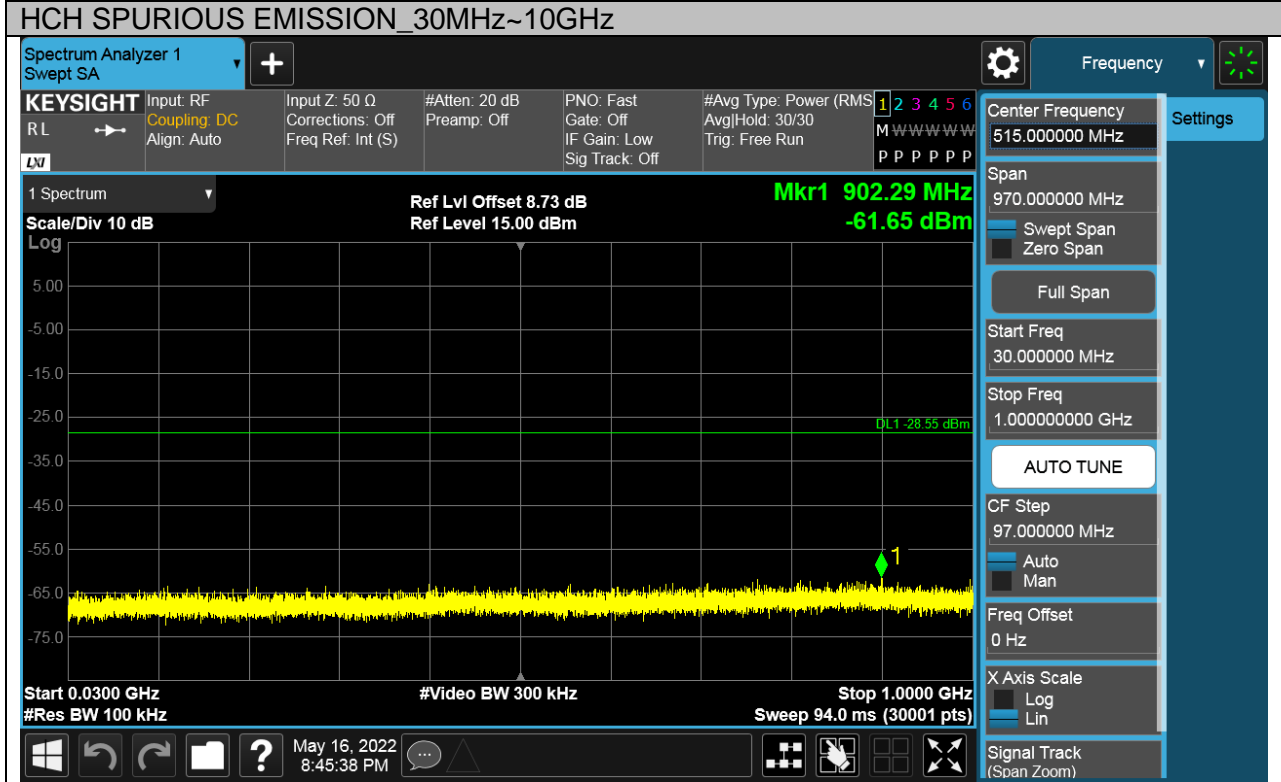





Test Mode	Channel	Verdict
11N HT20	LCH	PASS

Pref test Plot

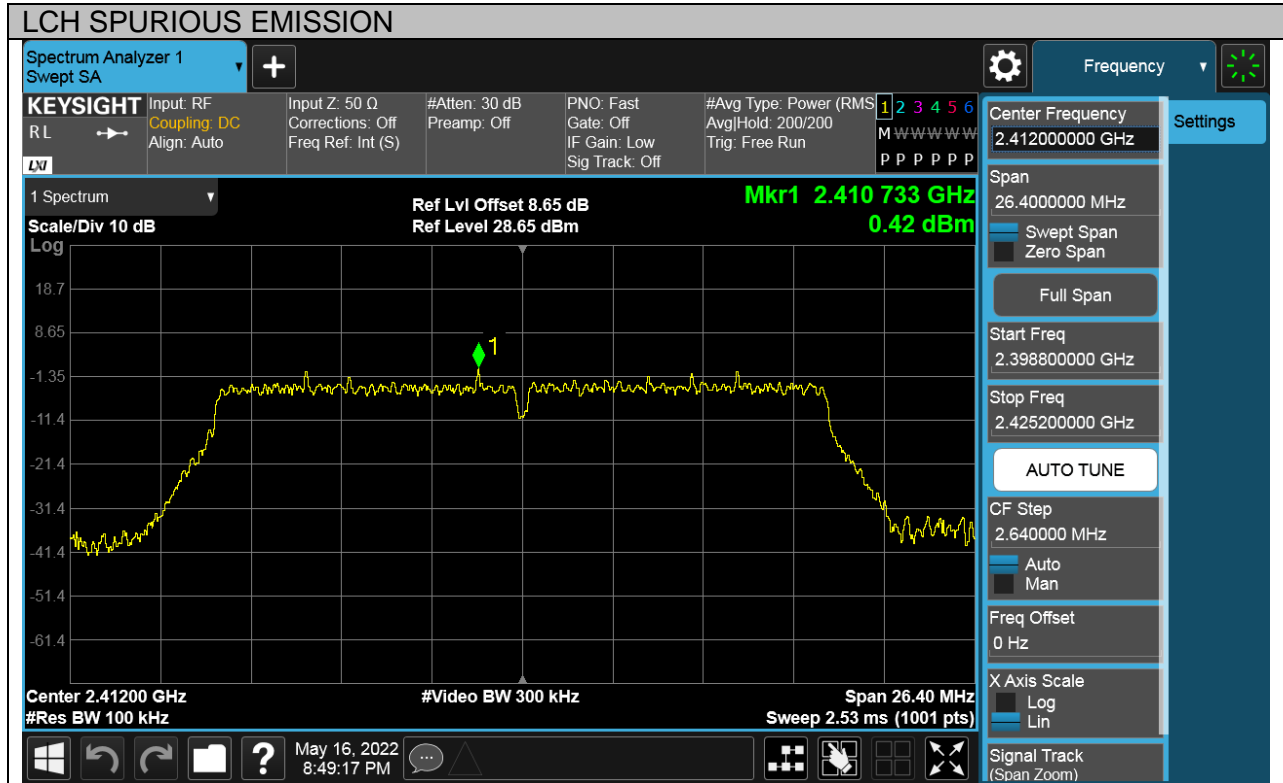



Puw test Plot

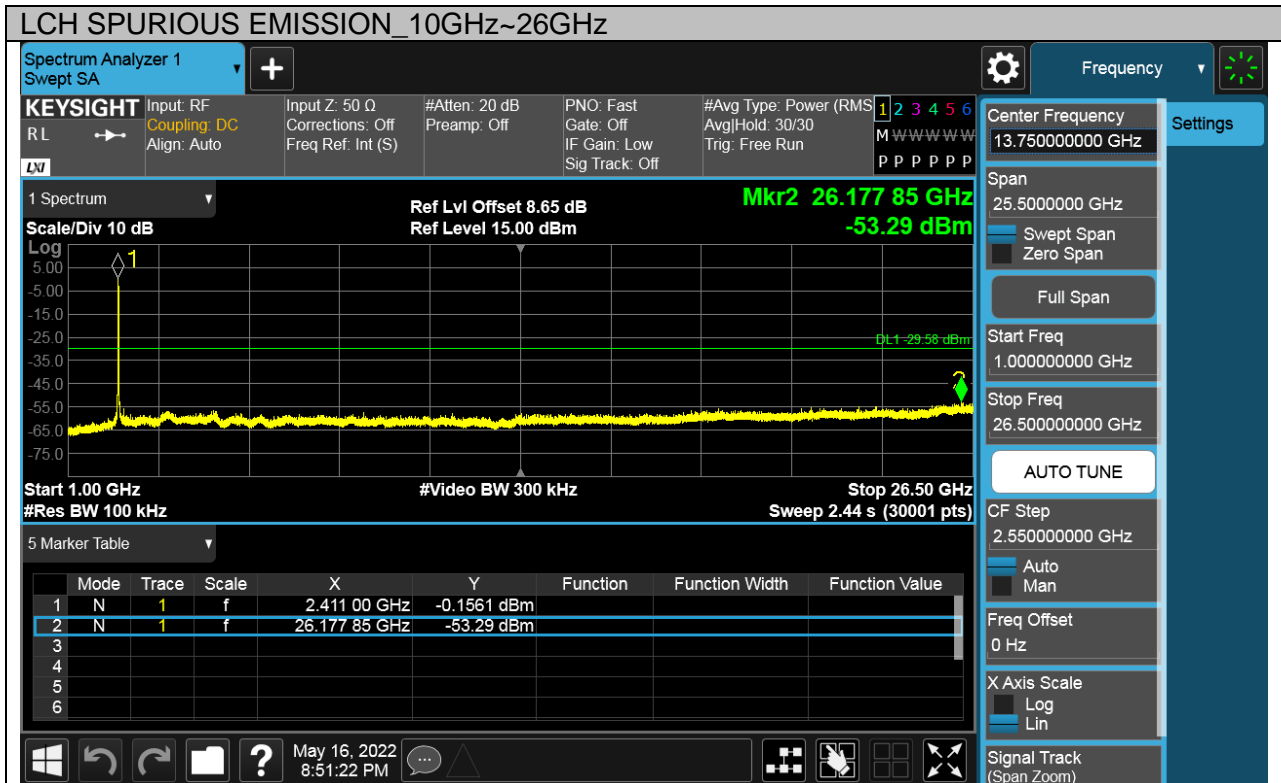
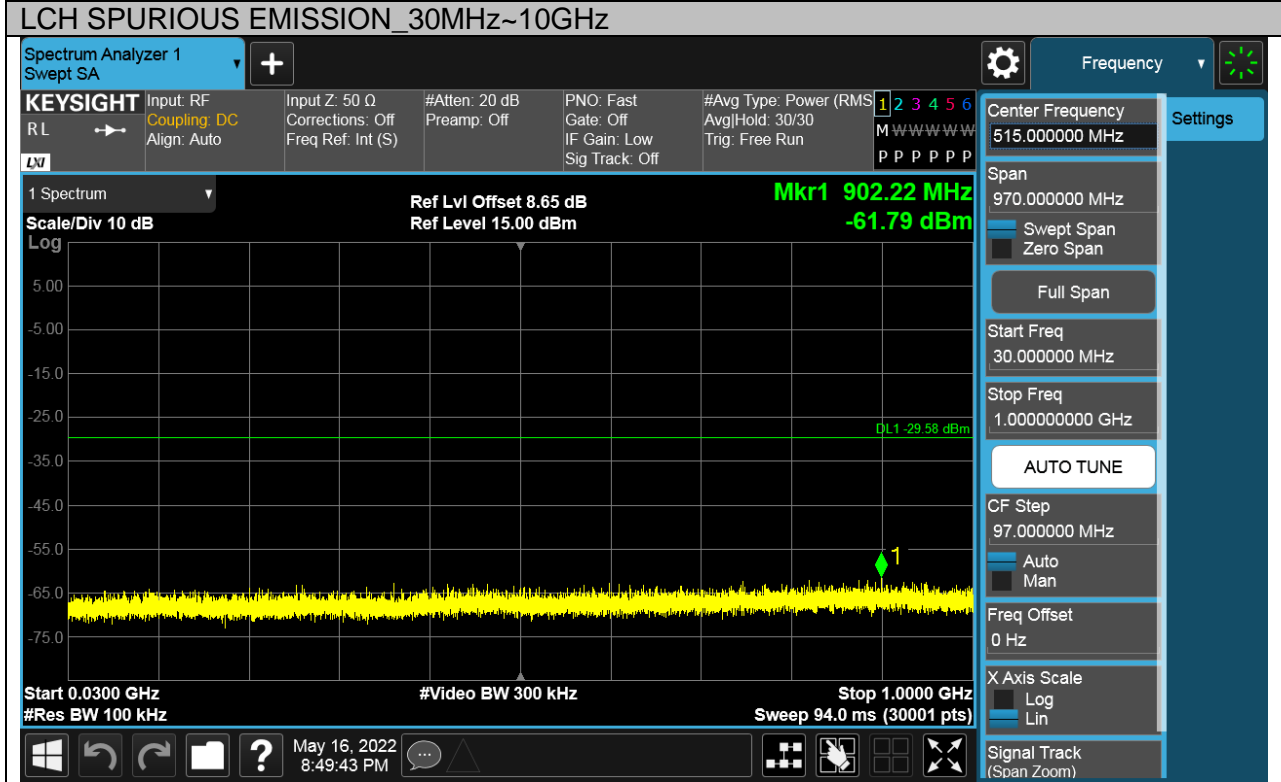



Test Mode	Channel	Verdict
11N HT20	MCH	PASS

Pref test Plot

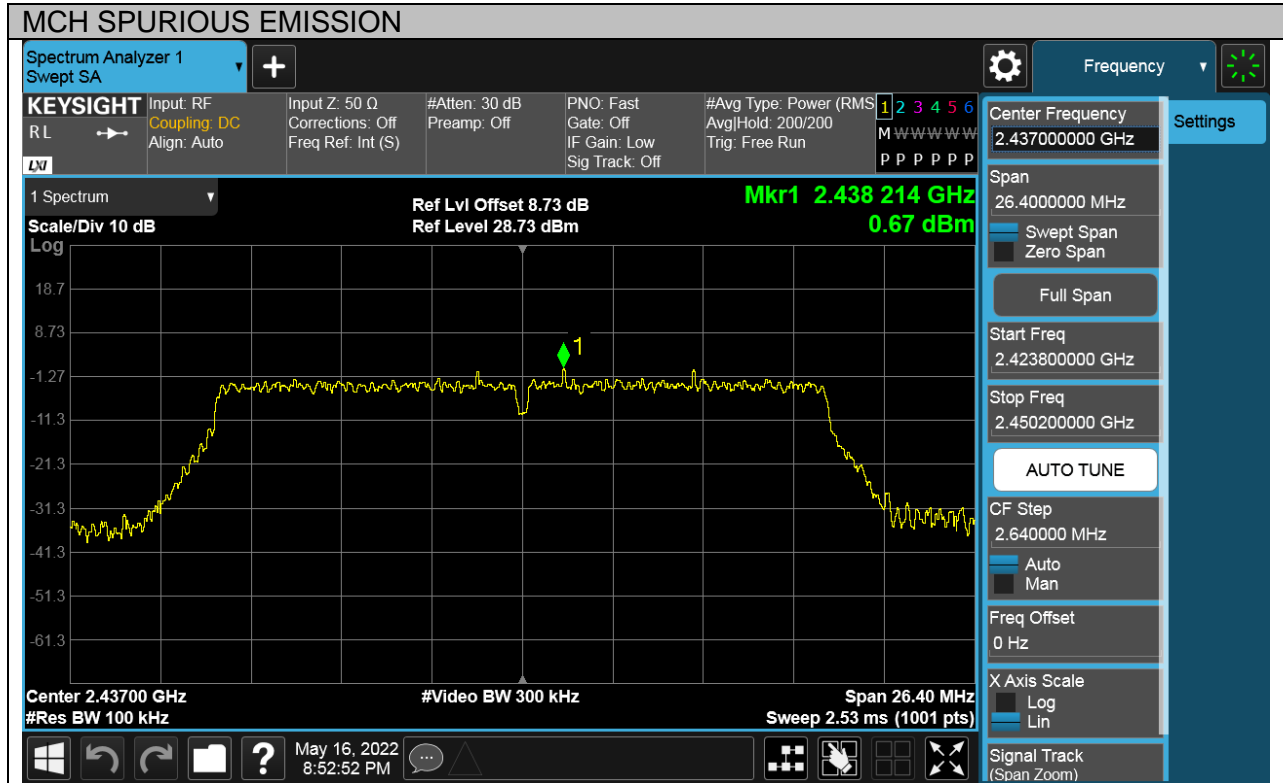



Puw test Plot

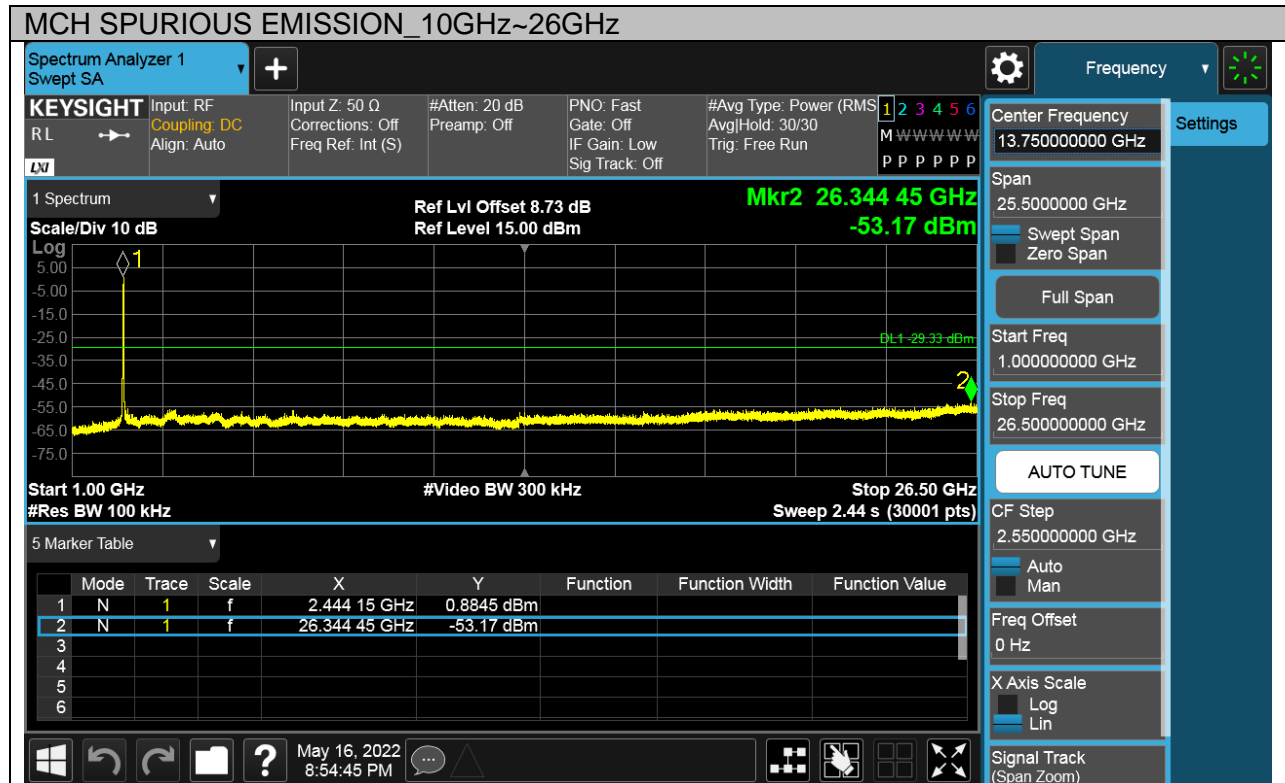
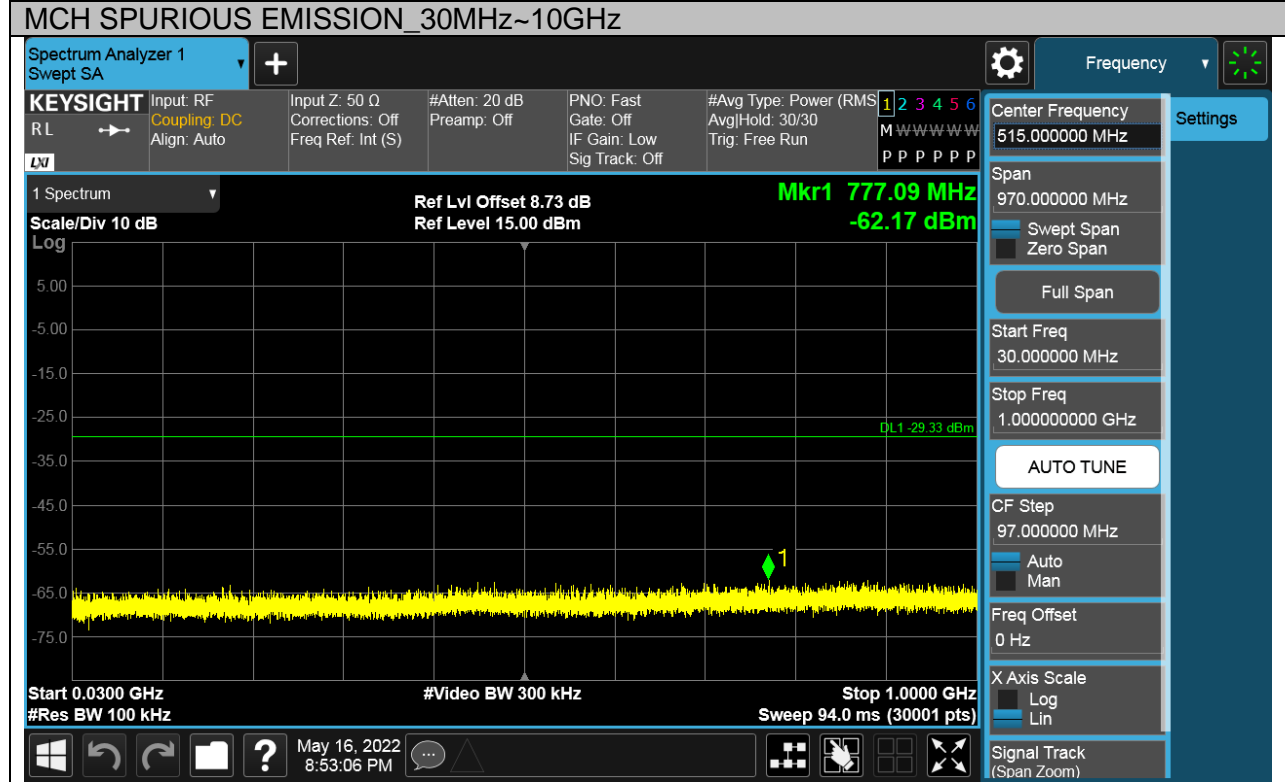



Test Mode	Channel	Verdict
11N HT20	HCH	PASS

Pref test Plot

