



**SGS-CSTC Standards Technical Services Co., Ltd.  
Shenzhen Branch**

No. 1 Workshop, M-10, Middle section, Science & Technology Park,  
Shenzhen, Guangdong, China 518057  
Telephone: +86 (0) 755 2601 2053  
Fax: +86 (0) 755 2671 0594  
Email: ee.shenzhen@sgs.com

Report No.: SZEM170800907501  
Page: 1 of 44

## 1 Cover Page

# RF TEST REPORT

<b>Application No.:</b>	SZEM1708009075CR
<b>Applicant:</b>	ZHEJIANG DAHUA VISION TECHNOLOGY CO., LTD.
<b>FCC ID:</b>	SVNDHIH1C
<b>Equipment Under Test (EUT):</b> <b>NOTE:</b> The following sample(s) was/were submitted and identified by the client as	
<b>Product Name:</b>	NETWORK ATTACHED STORAGE
<b>Model No.(EUT):</b>	DHI-H1C
<b>Add model No.:</b>	DHI-HxC, HxC, DHI-HxC-xT, HxC-xT ("x" can be 1-9)
<b>Standards:</b>	FCC PART 15 Subpart C: 2016
<b>Date of Receipt:</b>	2017-08-11
<b>Date of Test:</b>	2017-08-12 to 2017-08-25
<b>Date of Issue:</b>	2017-08-28
<b>Test Result:</b>	<b>Pass*</b>

\*In the configuration tested, the EUT detailed in this report complied with the standards specified above.



Jack Zhang  
EMC Laboratory Manager

The manufacturer should ensure that all products in series production are in conformity with the product sample detailed in this report. If the product in this report is used in any configuration other than that detailed in the report, the manufacturer must ensure the new system complies with all relevant standards. Any mention of SGS International Electrical Approvals or testing done by SGS International Electrical Approvals in connection with, distribution or use of the product described in this report must be approved by SGS International Electrical Approvals in writing.

This document is issued by the Company subject to its General Conditions of Service printed overleaf, available on request or accessible at [www.sgs.com/terms\\_and\\_conditions.htm](http://www.sgs.com/terms_and_conditions.htm) and, for electronic format documents, subject to Terms and Conditions for Electronic Documents at [www.sgs.com/terms\\_e-document.htm](http://www.sgs.com/terms_e-document.htm). Attention is drawn to the limitation of liability, indemnification and jurisdiction issues defined therein. Any holder of this document is advised that information contained hereon reflects the Company's findings at the time of its intervention only and within the limits of Client's instructions, if any. The Company's sole responsibility is to its Client and this document does not exonerate parties to a transaction from exercising all their rights and obligations under the transaction. documents. This document cannot be reproduced except in full, without prior written approval of the Company. Any unauthorized alteration, forgery or falsification of the content or appearance of this document is unlawful and offenders may be prosecuted to the fullest extent of the law. Unless otherwise stated the results shown in this test report refer only to the sample(s) tested and such sample(s) are retained for 90 days only



Revision Record				
Version	Chapter	Date	Modifier	Remark
00	/	2017-08-28	/	Original

<b>Authorized for issue by:</b>				
				
		<b>Foray Chen /Project Engineer</b>		2017-08-28
				_____
				Date
				
		<b>Eric Fu /Reviewer</b>		2017-08-28
				_____
				Date

## 2 Test Summary

Test Item	FCC Requirement	Test method	Result
Antenna Requirement	FCC Part 15, Subpart C Section 15.203/15.247 (c)	---	PASS
AC Power Line Conducted Emission	FCC Part 15, Subpart C Section 15.207	ANSI C63.10 (2013) Section 6.2	PASS
Minimum 6dB Bandwidth	FCC Part 15, Subpart C Section 15.247 (a)(2)	ANSI C63.10 (2013) Section 11.8.1	PASS
Conducted Peak Output Power	FCC Part 15, Subpart C Section 15.247 (b)(3)	ANSI C63.10 (2013) Section 11.9.1.2	PASS
Power Spectrum Density	FCC Part 15, Subpart C Section 15.247 (e)	ANSI C63.10 (2013) Section 11.10.2	PASS
RF Conducted Spurious Emissions and Band-edge	FCC Part 15, Subpart C Section 15.247(d)	ANSI C63.10 (2013) Section 11.11&11.13.3.2	PASS
Radiated Spurious Emissions and Band-edge	FCC Part 15, Subpart C Section 15.209&15.205	ANSI C63.10 (2013) Section 6.4&6.5&6.6&6.10	PASS

Note: There are series models mentioned in this report, and they are the similar in electrical and electronic characters. Only the model DHI-H1C was tested since their differences were the software version.



### 3 Contents

	Page
<b>1 COVER PAGE</b> .....	<b>1</b>
<b>2 TEST SUMMARY</b> .....	<b>3</b>
<b>3 CONTENTS</b> .....	<b>4</b>
<b>4 GENERAL INFORMATION</b> .....	<b>5</b>
4.1 CLIENT INFORMATION.....	5
4.2 GENERAL DESCRIPTION OF E.U.T. ....	5
4.3 TECHNICAL SPECIFICATIONS.....	5
4.4 TEST MODE.....	5
4.5 TEST CHANNEL .....	6
4.6 DESCRIPTION OF SUPPORT UNITS.....	6
4.7 TEST LOCATION .....	6
4.8 TEST FACILITY .....	7
4.9 MEASUREMENT UNCERTAINTY .....	8
<b>5 EQUIPMENTS USED DURING TEST</b> .....	<b>9</b>
<b>6 TEST RESULTS</b> .....	<b>10</b>
6.1 E.U.T. TEST CONDITIONS .....	10
6.2 ANTENNA REQUIREMENT.....	11
6.3 CONDUCTED EMISSIONS ON MAINS TERMINALS .....	12
6.4 6dB OCCUPIED BANDWIDTH.....	16
6.5 CONDUCTED PEAK OUTPUT POWER .....	17
6.6 PEAK POWER SPECTRAL DENSITY.....	18
6.7 CONDUCTED SPURIOUS EMISSIONS AND BAND-EDGE .....	19
6.7.1 <i>Conducted spurious emission</i> .....	19
6.7.2 <i>Conducted Band-edge</i> .....	19
6.8 RADIATED SPURIOUS EMISSIONS AND BAND-EDGE.....	20
6.8.1 <i>Radiated Spurious Emissions</i> .....	23
6.8.2 <i>Radiated Band edge</i> .....	29
<b>7 TEST SETUP PHOTOGRAPHS</b> .....	<b>44</b>
<b>8 EUT CONSTRUCTIONAL DETAILS</b> .....	<b>44</b>

## 4 General Information

### 4.1 Client Information

Applicant:	ZHEJIANG DAHUA VISION TECHNOLOGY CO., LTD.
Address of Applicant:	No.1199, Bin'an Road, Binjiang District, Hangzhou, P.R. China
Manufacturer:	ZHEJIANG DAHUA VISION TECHNOLOGY CO., LTD.
Address of Manufacturer:	No.1199, Bin'an Road, Binjiang District, Hangzhou, P.R. China
Factory:	1, ZHEJIANG DAHUA VISION TECHNOLOGY CO., LTD. 2, ZHEJIANG DAHUA ZHILIAN CO.,LTD.
Address of Factory:	1, No.1199, Bin'an Road, Binjiang District, Hangzhou, P.R. China 2, No.28, Dongqiao Road, Dongzhou Street, Fuyang District, Hangzhou, P.R.China.

### 4.2 General Description of E.U.T.

Product Name	NETWORK ATTACHED STORAGE
Product Description:	Fixed product with 2.4G WiFi function
Rated Input:	DC 12V 1.5A
Test Voltage:	AC 120V 60Hz for Adapter

Parameter of adapter:

Adapter:	Model No.:	ADS-26SA-12 12018EPG	
	Rated Input:	AC 100~240V, 50/60Hz MAX.1.0A	
	Rated Output:	DC 12V 1.5A	
	Cable length:	AC port:	2 wires
DC port:		150 cm	

### 4.3 Technical Specifications

Operation Frequency:	802.11 b/g/n(HT20): 2412MHz~2462MHz 802.11 n(HT40): 2422MHz~2452MHz
Modulation Technique:	802.11 b: DSSS(CCK, DQPSK, DBPSK) 802.11 g/n(HT20/n(HT40): OFDM(64QAM, 16QAM, QPSK, BPSK)
Data Rate:	802.11 b: 1/2/5.5/11Mbps 802.11 g: 6/9/12/18/24/36/48/54Mbps 802.11 n: MCS0-7
Number of Channel:	802.11 b/g/n(HT20): 11 802.11 n(HT40): 7
Antenna Type:	PCB Antenna
Antenna Gain:	6 dBi

### 4.4 Test Mode

Test Mode	Description of Test Mode
Engineering Mode:	Using test software was control EUT work in continuous transmitter and mode.

#### 4.5 Test Channel

	802.11 b/g/n20(HT20)					802.11 n40(HT40)		
	Channel	Frequency	Data rate			Channel	Frequency	Data rate
			b	g	n(HT20)			
lowest channel	CH01	2412MHz	1Mbps	6Mbps	MCS0	CH03	2422MHz	MCS0
Middle channel	CH06	2437MHz	1Mbps	6Mbps	MCS0	CH06	2437MHz	MCS0
Highest channel	CH11	2462MHz	1Mbps	6Mbps	MCS0	CH09	2452MHz	MCS0

Remark: Preliminary tests were performed in all tests in different data rate and antenna configurations at lowest channel, the data rates of worse case as above were chosen for final test.

#### 4.6 Description of Support Units

The EUT has been tested with support equipments as below.

Description	Manufacturer	Model No.	Supplied By
Laptop	Lenovo	ThinkPad X100e	SGS
Serial port adapter plate	/	Test plate 3	SGS

Software name	Manufacturer	Version	Supplied By
Secure CRT	VanDyke	V6.2.0	SGS

#### 4.7 Test Location

All tests were performed at:

SGS-CSTC Standards Technical Services Co., Ltd., Shenzhen Branch

No. 1 Workshop, M-10, Middle Section, Science & Technology Park, Shenzhen, Guangdong, China.

518057

Tel: +86 755 2601 2053

Fax: +86 755 2671 0594

No tests were sub-contracted.

## 4.8 Test Facility

The test facility is recognized, certified, or accredited by the following organizations:

- **CNAS (No. CNAS L2929)**

CNAS has accredited SGS-CSTC Standards Technical Services Co., Ltd. Shenzhen Branch EMC Lab to ISO/IEC 17025:2005 General Requirements for the Competence of Testing and Calibration Laboratories (CNAS-CL01 Accreditation Criteria for the Competence of Testing and Calibration Laboratories) for the competence in the field of testing.

- **A2LA (Certificate No. 3816.01)**

SGS-CSTC Standards Technical Services Co., Ltd., Shenzhen EMC Laboratory is accredited by the American Association for Laboratory Accreditation(A2LA). Certificate No. 3816.01.

- **VCCI**

The 10m Semi-anechoic chamber and Shielded Room of SGS-CSTC Standards Technical Services Co., Ltd. have been registered in accordance with the Regulations for Voluntary Control Measures with Registration No.: G-823, R-4188, T-1153 and C-2383 respectively.

- **FCC –Designation Number: CN1178**

SGS-CSTC Standards Technical Services Co., Ltd., Shenzhen EMC Laboratory has been recognized as an accredited testing laboratory.

Designation Number: CN1178. Test Firm Registration Number: 406779.

- **Industry Canada (IC)**

Two 3m Semi-anechoic chambers and the 10m Semi-anechoic chamber of SGS-CSTC Standards Technical Services Co., Ltd. Shenzhen Branch EMC Lab have been registered by Certification and Engineering Bureau of Industry Canada for radio equipment testing with Registration No.: 4620C-1, 4620C-2, 4620C-3.

#### 4.9 Measurement Uncertainty

No.	Parameter	Measurement Uncertainty
1	Radio Frequency	$< \pm 1 \times 10^{-5}$
2	Total RF power, conducted	$< \pm 1.5$ dB
3	RF power density, conducted	$< \pm 3$ dB
4	Spurious emissions, conducted	$< \pm 3$ dB
5	All emissions, radiated	$< \pm 6$ dB (Below 1GHz) $< \pm 6$ dB (Above 1GHz)
6	Temperature	$< \pm 1^{\circ}\text{C}$
7	Humidity	$< \pm 5$ %
8	DC and low frequency voltages	$< \pm 3$ %



## 5 Equipments Used during Test

Equipment	Manufacturer	Model No	Inventory No	Cal Date	Cal Due Date
<b>Conducted Emission at AC Power Line</b>					
EMI test receiver	R&S	ESR7	SHEM162-1	2016-12-29	2017-12-28
LISN	Schwarzbeck	NSLK8127	SHEM061-1	2016-12-29	2017-12-28
LISN	EMCO	3816/2	SHEM019-1	2016-12-29	2017-12-28
Pulse limiter	R&S	ESH3-Z2	SHEM029-1	2017-08-12	2018-08-11
CE test Cable	/	CE01	/	2016-12-29	2017-12-28
<b>Conducted Test</b>					
Spectrum Analyzer	R&S	FSP-30	SHEM002-1	2017-04-24	2018-04-23
Spectrum Analyzer	Agilent	N9020A	SHEM181-1	2017-07-03	2018-07-02
Power meter	R&S	NRP	SHEM057-1	2016-12-29	2017-12-28
Power Sensor	R&S	NRP-Z22	SHEM136-1	2017-07-22	2018-07-21
Power Sensor	R&S	NRP-Z91	SHEM057-2	2016-12-29	2017-12-28
Signal Generator	R&S	SMR40	SHEM058-1	2017-07-03	2018-07-02
Signal Generator	Agilent	N5182A	SHEM182-1	2017-07-03	2018-07-02
Communication Tester	R&S	CMW500	SHEM183-1	2017-07-03	2018-07-02
Switcher	Tonscend	JS0806	SHEM184-1	/	/
Splitter	Anritsu	MA1612A	SHEM185-1	/	/
Coupler	e-meca	803-S-1	SHEM186-1	/	/
High-low Temp Cabinet	Suzhou Zhihe	TL-40	SHEM087-1	2017-09-13	2018-09-12
AC Power Stabilizer	WOCEN	6100	SHEM045-1	2017-01-14	2018-01-13
DC Power Supply	QJE	QJ30003SII	SHEM046-1	2017-01-14	2018-01-13
<b>Radiated Test</b>					
EMI test receiver	R&S	ESU40	SHEM051-1	2017-09-26	2018-09-25
Spectrum Analyzer	R&S	FSP-30	SHEM002-1	2017-04-24	2018-04-23
Loop Antenna (9kHz-30MHz)	Schwarzbeck	FMZB1519	SHEM135-1	2017-04-10	2018-04-09
Antenna (25MHz-2GHz)	Schwarzbeck	VULB9168	SHEM048-1	2017-02-28	2018-02-27
Antenna (25MHz-3GHz)	Schwarzbeck	HL562	SHEM010-1	2017-02-28	2018-02-27
Horn Antenna (1-8GHz)	Schwarzbeck	HF906	SHEM009-1	2016-09-24	2018-09-23
Horn Antenna (1-18GHz)	Schwarzbeck	BBHA9120D	SHEM050-1	2017-01-14	2018-01-13
Horn Antenna (14-40GHz)	Schwarzbeck	BBHA 9170	SHEM049-1	2017-02-13	2018-01-15
Pre-amplifier (9kHz-2GHz)	CLAVIIO	BDLNA-0001-412010	SHEM164-1	2017-08-22	2018-08-21
Pre-amplifier (1-26.5GHz)	CLAVIIO	BDLNA-0118-352810	SHEM050-2	2017-08-22	2018-08-21
Band filter	LORCH	9BRX-875/X150-SR	SHEM156-1	/	/
Band filter	LORCH	13BRX-1950/X500-SR	SHEM083-2	/	/
Band filter	LORCH	5BRX-2400/X200-SR	SHEM155-1	/	/
Band filter	LORCH	5BRX-5500/X1000-SR	SHEM157-2	/	/
High pass Filter	Wainwright	WHK3.0/18G-100SS	SHEM157-1	/	/
High pass Filter	Wainwright	WHKS1700-3SS	SHEM157-3	/	/
Semi/Fully Anechoic	ST	11*6*6M	SHEM078-2	2017-07-22	2018-07-21
RE test Cable	/	RE01, RE02, RE06	/	2016-12-29	2017-12-28

## 6 Test Results

### 6.1 E.U.T. test conditions

**Requirements:** 15.31(e) For intentional radiators, measurements of the variation of the input power or the radiated signal level of the fundamental frequency component of the emission, as appropriate, shall be performed with the supply voltage varied between 85% and 115% of the nominal rated supply voltage. For battery operated equipment, the equipment tests shall be performed using a new battery.

<b>Operating Environment:</b>	Temperature:	20.0 -25.0 °C
	Humidity:	35-75 % RH
	Atmospheric Pressure:	99.2 -102 kPa

**Test frequencies:** According to the 15.31(m) Measurements on intentional radiators or receivers, other than TV broadcast receivers, shall be performed and, if required, reported for each band in which the device can be operated with the device operating at the number of frequencies in each band specified in the following table:

Frequency range over which device operates	Number of frequencies	Location in the range of operation
1 MHz or less	1	Middle
1 to 10 MHz	2	1 near top and 1 near bottom
More than 10 MHz	3	1 near top, 1 near middle and 1 near bottom

Pursuant to Part 15.31(c) For swept frequency equipment, measurements shall be made with the frequency sweep stopped at those frequencies chosen for the measurements to be reported.

## 6.2 Antenna Requirement

### Standard requirement:

An intentional radiator shall be designed to ensure that no antenna other than that furnished by the responsible party shall be used with the device. The use of a permanently attached antenna or of an antenna that uses a unique coupling to the intentional radiator, the manufacturer may design the unit so that a broken antenna can be replaced by the user, but the use of a standard antenna jack or electrical connector is prohibited

The conducted output power limit specified in paragraph (b) of this section is based on the use of antennas with directional gains that do not exceed 6 dBi. Except as shown in paragraph (c) of this section, if transmitting antennas of directional gain greater than 6 dBi are used, the conducted output power from the intentional radiator shall be reduced below the stated values in paragraphs (b)(1), (b)(2), and (b)(3) of this section, as appropriate, by the amount in dB that the directional gain of the antenna exceeds 6 dBi.

### EUT Antenna:

The antenna is Integral Antenna and no consideration of replacement. The gain of the antenna is less than 6.0dBi

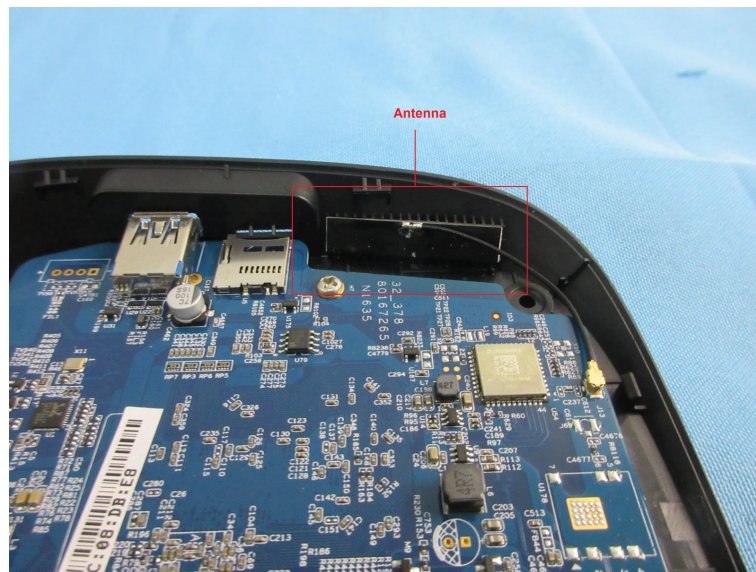

### 6.3 Conducted Emissions on Mains Terminals

**Frequency Range:** 150 KHz to 30 MHz

**Limit:**

Frequency range MHz	Class B Limits: dB (µV)	
	Quasi-peak	Average
0.15 to 0.50	66 to 56	56 to 46
0.50 to 5	56	46
5 to 30	60	50

Note1: The limit decreases linearly with the logarithm of the frequency in the range 0.15 MHz to 0.50MHz.

Note2: The lower limit is applicable at the transition frequency.

#### Test Setup:

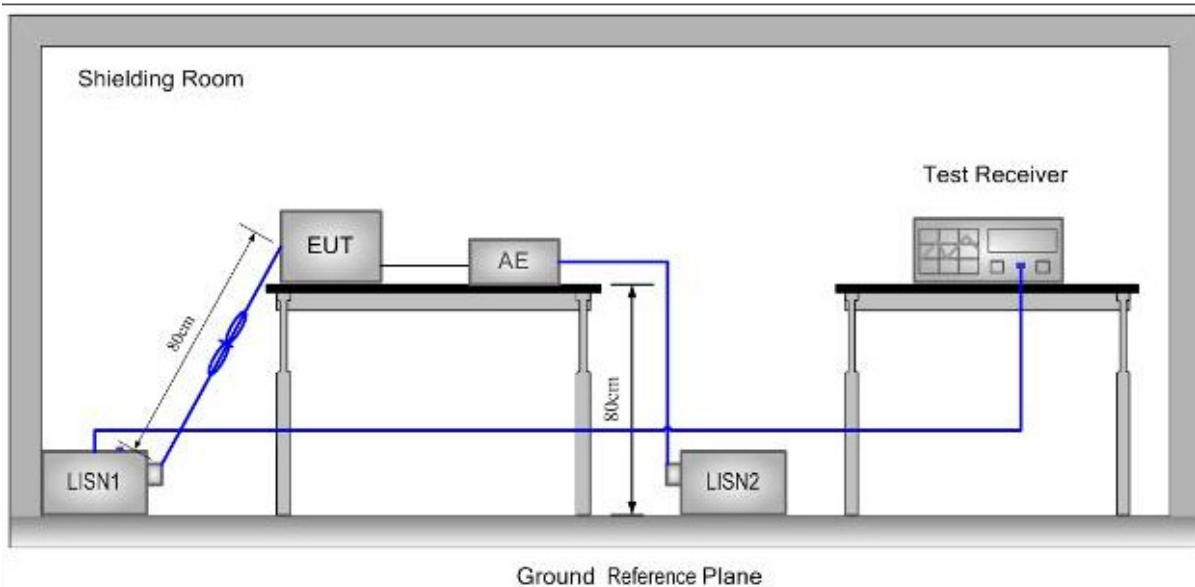

#### Test Procedure:

- 1) The mains terminal disturbance voltage was measured with the EUT in a shielded room.
- 2) The EUT was connected to AC power source through a LISN 1 (Line Impedance Stabilization Network) which provides  $50\Omega/50\mu\text{H} + 5\Omega$  linear impedance. The power cables of all other units of the EUT were connected to a second LISN, which was bonded to the ground reference plane in the same way as the LISN for the unit being measured. A multiple socket outlet strip was used to connect multiple power cables to a single LISN provided the rating of the LISN was not exceeded
- 3) The tabletop EUT was placed upon a non-metallic table 0.8m above the ground reference plane. And for floor-standing arrangement, the EUT was placed on the horizontal ground reference plane, but separated from metallic contact with the ground reference plane by 0.1m of insulation.
- 4) The test was performed with a vertical ground reference plane. The rear of the EUT shall be 0.4 m from the vertical ground reference plane. The vertical ground reference plane was bonded to the horizontal ground reference plane. The LISN was placed 0.8 m from the boundary of the unit under test and bonded to a ground reference plane for LISN mounted on top of the ground reference plane. This distance was between the closest points of the LISN and the EUT. The mains lead of EUT excess 0.8m was folded back and forth parallel to the lead so as to form a



---

horizontal bundle with a length between 0.3m and 0.4m. All other units of the EUT and associated equipment were at least 0.8 m from the LISN.

Remark: Pre-scan was performed with peak detected on all ports, Quasi-peak & average measurements were performed at the frequencies at which maximum peak emission level were detected. Pretest under all modes; choose the worst case mode (802.11b in Middle channel) record on the report. Please see the attached Quasi-peak and Average test results.

**Test Result:** Pass

**Test Data:**

<b>Test Mode:</b>	802.11b	<b>Test Channel:</b>	Middle
<b>Test Port:</b>	AC Live Line		

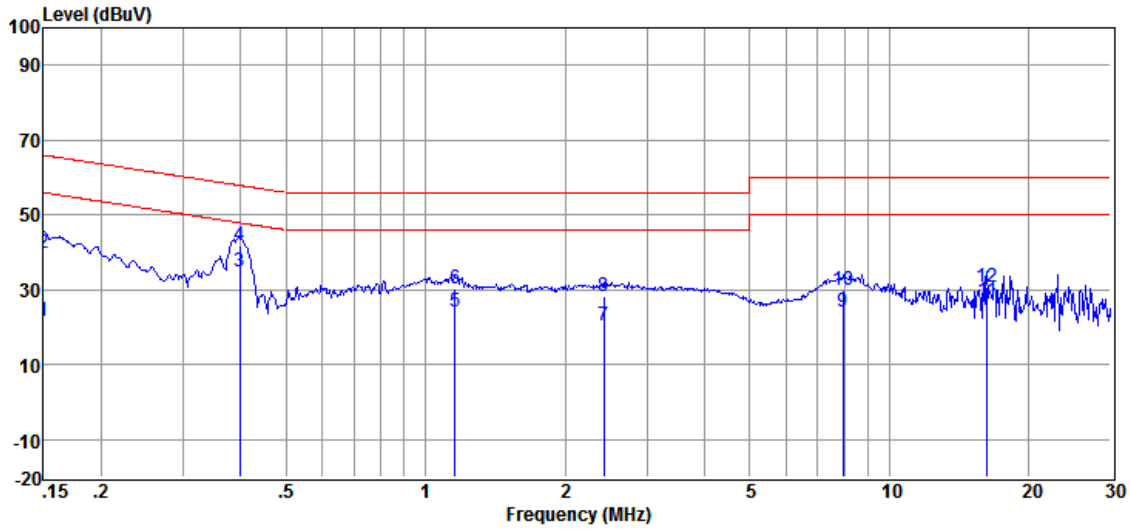

Item	Freq.	Read Level	LISN Factor	Cable Loss	Level	Limit Line	Over Limit	Detector
(Mark)	(MHz)	(dBμV)	(dB)	(dB)	(dBμV)	(dBμV)	(dB)	
1	0.150	11.81	0.11	9.81	21.73	56.00	-34.27	Average
2	0.150	30.02	0.11	9.81	39.94	66.00	-26.06	QP
3	0.398	25.03	0.11	9.81	34.95	47.90	-12.95	Average
4	0.398	31.87	0.11	9.81	41.79	57.90	-16.11	QP
5	1.160	14.21	0.11	9.84	24.16	46.00	-21.84	Average
6	1.160	20.51	0.11	9.84	30.46	56.00	-25.54	QP
7	2.422	10.36	0.12	9.85	20.33	46.00	-25.67	Average
8	2.422	18.30	0.12	9.85	28.27	56.00	-27.73	QP
9	7.935	14.06	0.10	9.86	24.02	50.00	-25.98	Average
10	7.935	19.90	0.10	9.86	29.86	60.00	-30.14	QP
11	16.226	16.88	0.16	10.02	27.06	50.00	-22.94	Average
12	16.226	20.51	0.16	10.02	30.69	60.00	-29.31	QP

**Test Port:** AC Neutral Line

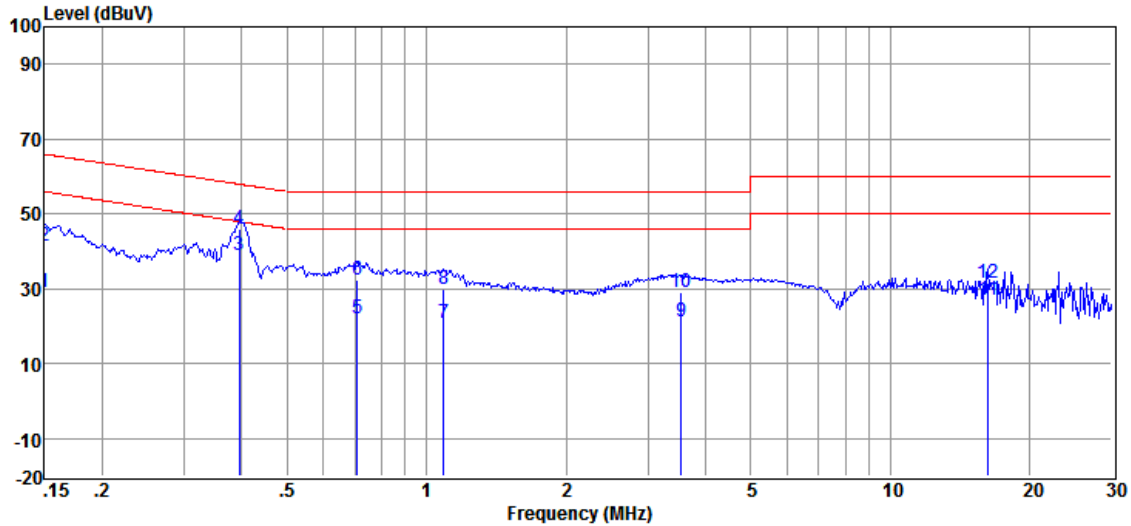

Item	Freq.	Read Level	LISN Factor	Cable Loss	Level	Limit Line	Over Limit	Detector
(Mark)	(MHz)	(dBμV)	(dB)	(dB)	(dBμV)	(dBμV)	(dB)	
1	0.150	19.00	0.12	9.81	28.93	56.00	-27.07	Average
2	0.150	31.63	0.12	9.81	41.56	66.00	-24.44	QP
3	0.396	29.15	0.11	9.81	39.07	47.95	-8.88	Average
4	0.396	36.24	0.11	9.81	46.16	57.95	-11.79	QP
5	0.708	11.92	0.11	9.83	21.86	46.00	-24.14	Average
6	0.708	22.61	0.11	9.83	32.55	56.00	-23.45	QP
7	1.088	10.73	0.11	9.84	20.68	46.00	-25.32	Average
8	1.088	20.08	0.11	9.84	30.03	56.00	-25.97	QP
9	3.547	11.39	0.13	9.85	21.37	46.00	-24.63	Average
10	3.547	18.98	0.13	9.85	28.96	56.00	-27.04	QP
11	16.226	16.86	0.18	10.02	27.06	50.00	-22.94	Average
12	16.226	21.50	0.18	10.02	31.70	60.00	-28.30	QP

Remark: Level = Read Level + LISN/ISN Factor + Cable Loss.

## 6.4 6dB Occupied Bandwidth

**Test Configuration:**

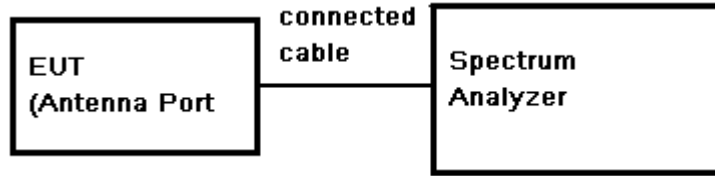

**Test Procedure:**

- 1) Place the EUT on the table and set it in transmitting mode.
- 2) Remove the antenna from the EUT and then connect a low loss RF cable from the antenna port to the spectrum analyzer.
- 3) Set the spectrum analyzer as RBW=100KHz, VBW $\geq$ 3\* RBW, Detector=Peak, Trace mode= Max hold, Sweep=Auto couple.
- 4) Mark the peak frequency and -6dB (upper and lower) frequency.
- 5) Repeat above procedures until all frequency measured was complete.

**Limit:**  $\geq$  500 kHz

**Test Result:** Pass

**Test Data:**

Appendix A for SZEM170800907501



## 6.5 Conducted Peak Output Power

**Test Configuration:**

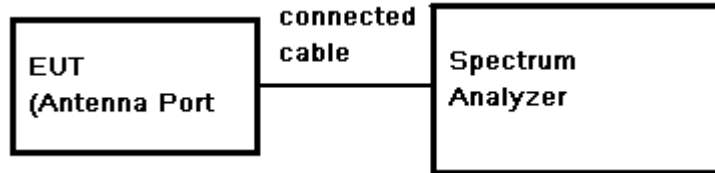

**Test Procedure:**

- 1) Place the EUT on the table and set it in transmitting mode.
- 2) Remove the antenna from the EUT and then connect a low loss RF cable from the antenna port to the spectrum.
- 3) Set the spectrum analyzer as RBW=1MHz, VBW $\geq$ 3\* RBW, Detector=Peak, Span $\geq$ 1.5  $\times$  DTS bandwidth, Trace mode= Max hold, Sweep=Auto couple
- 4) Allow trace to fully stabilize.
- 5) Use the instrument's band/channel power measurement function with the band limits set equal to the DTS bandwidth edges
- 6) Record the max. Power channel reading.
- 7) Repeat above procedures until all the frequency measured were complete.

**Test Limit:** 30dBm

**Test Result:** Pass

**Test Data:**

Appendix A for SZEM170800907501

## 6.6 Peak Power Spectral Density

### Test Configuration:

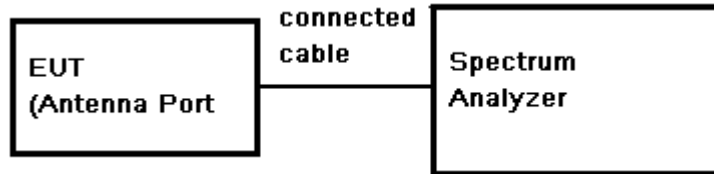

### Test Procedure:

- 1) Remove the antenna from the EUT and then connect a low RF cable from the antenna port to the spectrum.
- 2) Set the spectrum analyzer: Center Frequency= Channel Frequency, RBW = 3 kHz VBW = 10 kHz. Span= 1.5 times the DTS bandwidth, Sweep = auto; Detector = Peak; Trace mode=max hold, Trace=Max hold.
- 3) Use the peak marker function to determine the maximum amplitude level within the RBW.
- 4) Record the marker level for the particular mode.
- 5) Repeat these steps for other channel and modes.

**Test Limit:** 8dBm/3kHz

**Test Result:** Pass

### Test Data:

Appendix A for SZEM170800907501

## 6.7 Conducted Spurious Emissions and Band-edge

**Test Configuration:**

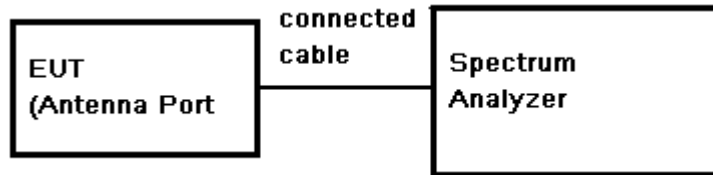

**Test Procedure:**

- 1) Remove the antenna from the EUT and then connect a low RF cable from the antenna port to the spectrum.
- 2) Set the spectrum analyzer: RBW = 100KHz. VBW = 300KHz. Sweep = auto; Detector Function = Peak (Max. hold).

**Limit:**

(d) In any 100 kHz bandwidth outside the frequency band in which the spread spectrum or digitally modulated intentional radiator is operating, the radio frequency power that is produced by the intentional radiator shall be at least 20 dB below that in the 100 kHz bandwidth within the band that contains the Highest level of the desired power, based on either an RF conducted or a radiated measurement, provided the transmitter demonstrates compliance with the peak conducted power limits.

**Test Result:**

Pass

### 6.7.1 Conducted spurious emission

Appendix A for SZEM170800907501

### 6.7.2 Conducted Band-edge

Appendix A for SZEM170800907501

### 6.8 Radiated Spurious Emissions and Band-edge

**Frequency Range:** 9KHz to 25GHz

**Test site/setup:** Measurement Distance: 3m  
 Test instrumentation set-up:

Frequency Range	Detector	RBW	VBW
0.009MHz-0.090MHz	Peak	10kHz	30kHz
0.009MHz-0.090MHz	Average	10kHz	30kHz
0.090MHz-0.110MHz	Quasi-peak	10kHz	30kHz
0.110MHz-0.490MHz	Peak	10kHz	30kHz
0.110MHz-0.490MHz	Average	10kHz	30kHz
0.490MHz -30MHz	Quasi-peak	10kHz	30kHz
30MHz-1GHz	Quasi-peak	100kHz	300kHz
Above 1GHz	Peak	RBW=1MHz	VBW≥RBW
	Average		VBW=10Hz

Sweep=Auto

**15.209 Limit:**

Frequency	Field strength (microvolt/meter)	Limit (dBuV/m)
0.009MHz-0.490MHz	2400/F(KHz)	128.5 ~ 93.8
0.490MHz-1.705MHz	24000/F(KHz)	73.8 ~63.0
1.705MHz-30MHz	30	69.5
30MHz-88MHz	100	40.0
88MHz-216MHz	150	43.5
216MHz-960MHz	200	46.0
960MHz-1GHz	500	54.0
Above 1GHz	500	54.0

Note: 15.35(b), Unless otherwise specified, the limit on peak radio frequency emissions is 20dB above the maximum permitted average emission limit applicable to the equipment under test. This peak limit applies to the total peak emission level radiated by the device.

### Test Configuration:

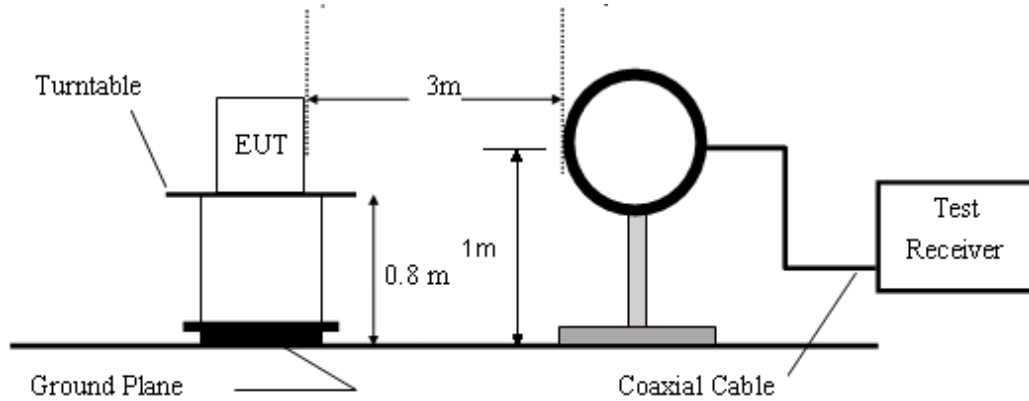

**Figure1. Below 30MHz radiated emissions test configuration**

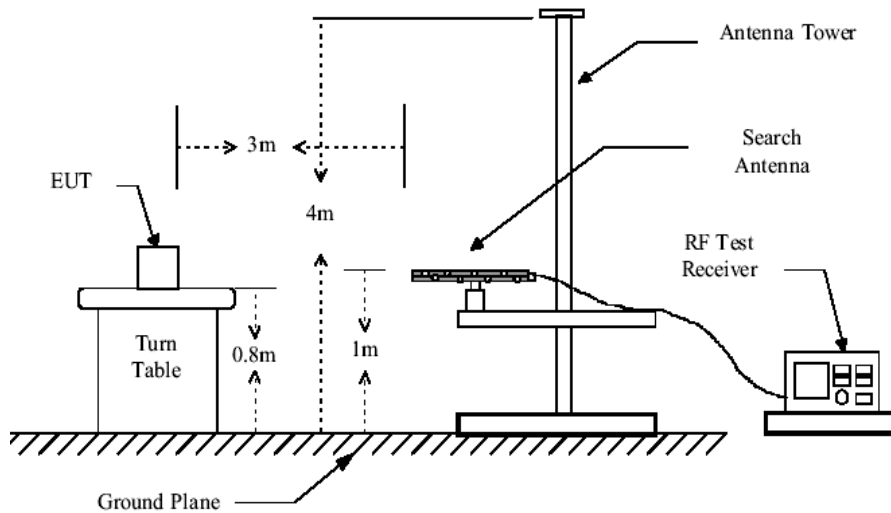

**Figure2. 30MHz to 1GHz radiated emissions test configuration**

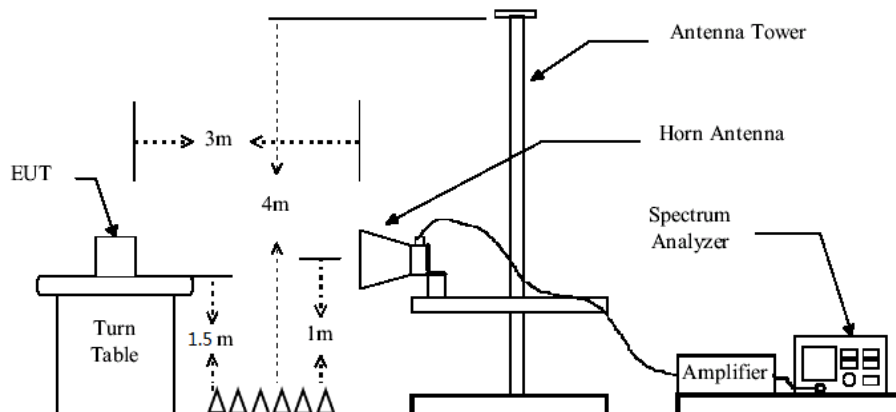

**Figure3. Above 1GHz radiated emissions test configuration**

- Test Procedure:**
- 1) The procedure used was ANSI Standard C63.10. The receiver was scanned from 9 KHz to 25GHz. When an emission was found, the table was rotated to produce the maximum signal strength. An initial pre-scan was performed for in peak detection mode using the receiver. The EUT was measured for both the Horizontal and Vertical polarities and performed a pre-test three orthogonal planes. For intentional radiators, measurements of the variation of the input power or the radiated signal level of the fundamental frequency component of the emission, as appropriate, shall be performed with the supply voltage varied between 85% and 115% of the nominal rated supply voltage. The worst case emissions were reported.
  - 2) Low noise amplifier was used below 1GHz, High pass Filter was used above 3GHz. We did not use any amplifier or filter between 1G and 3GHz.
  - 3) Test were performed for their spatial orthogonal(X, Y, Z), the worst test data (X orthogonal) was submitted.
    - a) For this intentional radiator operates below 25 GHz. the spectrum shall be investigated to the tenth harmonic of the highest fundamental frequency. And above the third harmonic of this intentional radiator, the disturbance is very low. So the test result only displays to 5rd harmonic.
    - b) As shown in Section, for frequencies above 1000MHz. the above field strength limits are based on average limits. However, the peak field strength of any emission shall not exceed the maximum permitted average limits specified above by more than 20 dB under any condition of modulation.
  - 4) Pretest under all modes below 1GHz; choose the worst case mode (802.11b) record on the report.
  - 5) No spurious emissions were detected within 20dB of limit below 30MHz.

**Test Result:** Pass

### 6.8.1 Radiated Spurious Emissions

30MHz-1GHz:

Item	Freq.	Read Level	Antenna Factor	Preamp Factor	Cable Loss	Result Level	Limit Line	Over Limit	Detector	Polarization
(Mark)	(MHz)	(dB $\mu$ V)	(dB/m)	(dB)	(dB)	(dB $\mu$ V/m)	(dB $\mu$ V/m)	(dB)		
1	44.59	59.82	13.54	42.63	0.24	30.97	40.00	-9.03	QP	Horizontal
2	58.20	61.64	12.25	42.65	0.29	31.53	40.00	-8.47	QP	Horizontal
3	80.64	66.52	8.01	42.68	0.38	32.23	40.00	-7.77	QP	Horizontal
4	250.30	73.00	11.50	42.46	0.77	42.81	46.00	-3.19	QP	Horizontal
5	362.98	69.80	14.45	42.20	0.94	42.99	46.00	-3.01	QP	Horizontal
6	411.82	65.43	15.37	42.10	1.02	39.72	46.00	-6.28	QP	Horizontal
1	37.42	63.81	16.07	42.62	0.21	37.47	40.00	-2.53	QP	Vertical
2	44.59	66.29	13.54	42.63	0.24	37.44	40.00	-2.56	QP	Vertical
3	73.36	62.25	10.24	42.67	0.35	30.17	40.00	-9.83	QP	Vertical
4	360.45	71.63	14.40	42.21	0.93	44.75	46.00	-1.25	QP	Vertical
5	413.27	70.18	15.40	42.10	1.02	44.50	46.00	-1.50	QP	Vertical
6	798.98	59.62	21.90	42.45	2.05	41.12	46.00	-4.88	QP	Vertical

Result Level = Read Level + Antenna Factor + Cable loss - Preamp Factor

Test plot as below:  
Vertical:

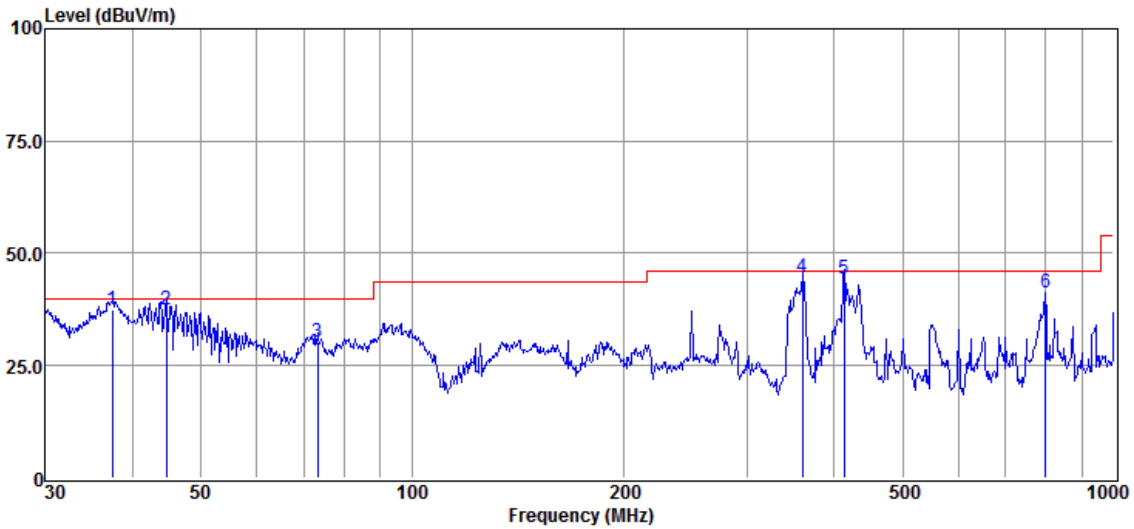

Horizontal:

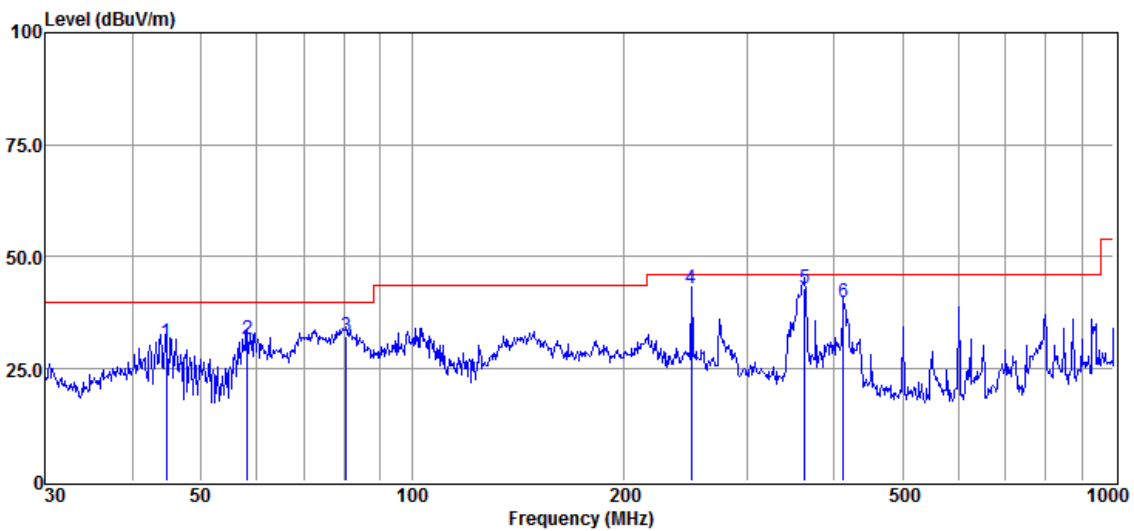



Above 1GHz:

**Test mode: 802.11b**

**Channel: 2412**

Mark	Frequency (MHz)	Reading (dBuV)	Factor (dB)	Emission (dBuV/m)	Limit (dBuV/m)	Over Limit (dB)	Detector	Polarization
1	4824	39.51	6.4	45.91	54	-8.09	peak	Horizontal
2	7236	38.78	10.76	49.54	54	-4.46	peak	Horizontal
3	9648	33.86	14.37	48.23	54	-5.77	peak	Horizontal
4	4824	40.39	6.4	46.79	54	-7.21	peak	Vertical
5	7236	35.65	10.76	46.41	54	-7.59	peak	Vertical
6	9648	35.64	14.37	50.01	54	-3.99	peak	Vertical

**Test mode: 802.11b**

**Channel: 2437**

Mark	Frequency (MHz)	Reading (dBuV)	Factor (dB)	Emission (dBuV/m)	Limit (dBuV/m)	Over Limit (dB)	Detector	Polarization
1	4874	42.43	6.92	49.35	54	-4.65	peak	Horizontal
2	7311	34.88	11.08	45.96	54	-8.04	peak	Horizontal
3	9748	32.03	14.36	46.39	54	-7.61	peak	Horizontal
4	4874	38.59	6.92	45.51	54	-8.49	peak	Vertical
5	7311	38.14	11.08	49.22	54	-4.78	peak	Vertical
6	9748	34.53	14.36	48.89	54	-5.11	peak	Vertical

**Test mode: 802.11b**

**Channel: 2462**

Mark	Frequency (MHz)	Reading (dBuV)	Factor (dB)	Emission (dBuV/m)	Limit (dBuV/m)	Over Limit (dB)	Detector	Polarization
1	4924	39.9	7.31	47.21	54	-6.79	peak	Horizontal
2	7386	39.42	11.41	50.83	54	-3.17	peak	Horizontal
3	9848	36.86	14.38	51.24	54	-2.76	peak	Horizontal
4	4924	38.6	7.31	45.91	54	-8.09	peak	Vertical
5	7386	35.33	11.41	46.74	54	-7.26	peak	Vertical
6	9848	33.82	14.38	48.2	54	-5.8	peak	Vertical

**Test mode: 802.11g**

**Channel: 2412**

Mar k	Frequency (MHz)	Reading (dBuV)	Factor (dB)	Emission (dBuV/m)	Limit (dBuV/m)	Over Limit (dB)	Detector	Polarization
1	4824	40.59	6.4	46.99	54	-7.01	peak	Horizontal
2	7236	40.18	10.76	50.94	54	-3.06	peak	Horizontal
3	9648	34.48	14.37	48.85	54	-5.15	peak	Horizontal
4	4824	38.13	6.4	44.53	54	-9.47	peak	Vertical
5	7236	38.86	10.76	49.62	54	-4.38	peak	Vertical
6	9648	36.79	14.37	51.16	54	-2.84	peak	Vertical

**Test mode: 802.11g**

**Channel: 2437**

Mar k	Frequency (MHz)	Reading (dBuV)	Factor (dB)	Emission (dBuV/m)	Limit (dBuV/m)	Over Limit (dB)	Detector	Polarization
1	4874	41.02	6.92	47.94	54	-6.06	peak	Horizontal
2	7311	37.34	11.08	48.42	54	-5.58	peak	Horizontal
3	9748	36.23	14.36	50.59	54	-3.41	peak	Horizontal
4	4874	39.98	6.92	46.9	54	-7.1	peak	Vertical
5	7311	34.03	11.08	45.11	54	-8.89	peak	Vertical
6	9748	32.26	14.36	46.62	54	-7.38	peak	Vertical

**Test mode: 802.11g**

**Channel: 2462**

Mar k	Frequency (MHz)	Reading (dBuV)	Factor (dB)	Emission (dBuV/m)	Limit (dBuV/m)	Over Limit (dB)	Detector	Polarization
1	4924	42.22	7.31	49.53	54	-4.47	peak	Horizontal
2	7386	39.44	11.41	50.85	54	-3.15	peak	Horizontal
3	9848	33.92	14.38	48.3	54	-5.7	peak	Horizontal
4	4924	43.65	7.31	50.96	54	-3.04	peak	Vertical
5	7386	36.71	11.41	48.12	54	-5.88	peak	Vertical
6	9848	32.34	14.38	46.72	54	-7.28	peak	Vertical

**Test mode: 802.11 n(HT20)**

**Channel: 2412**

Mar k	Frequency (MHz)	Reading (dBuV)	Factor (dB)	Emission (dBuV/m)	Limit (dBuV/m)	Over Limit (dB)	Detector	Polarization
1	4824	41.04	6.4	47.44	54	-6.56	peak	Horizontal
2	7236	36.12	10.76	46.88	54	-7.12	peak	Horizontal
3	9648	36.09	14.37	50.46	54	-3.54	peak	Horizontal
4	4824	43.86	6.4	50.26	54	-3.74	peak	Vertical
5	7236	37.8	10.76	48.56	54	-5.44	peak	Vertical
6	9648	30.84	14.37	45.21	54	-8.79	peak	Vertical

**Test mode: 802.11 n(HT20)**

**Channel: 2437**

Mar k	Frequency (MHz)	Reading (dBuV)	Factor (dB)	Emission (dBuV/m)	Limit (dBuV/m)	Over Limit (dB)	Detector	Polarization
1	4874	40.5	6.92	47.42	54	-6.58	peak	Horizontal
2	7311	36.12	11.08	47.2	54	-6.8	peak	Horizontal
3	9748	32.34	14.36	46.7	54	-7.3	peak	Horizontal
4	4874	42.7	6.92	49.62	54	-4.38	peak	Vertical
5	7311	36.41	11.08	47.49	54	-6.51	peak	Vertical
6	9748	32.5	14.36	46.86	54	-7.14	peak	Vertical

**Test mode: 802.11 n(HT20)**

**Channel: 2462**

Mar k	Frequency (MHz)	Reading (dBuV)	Factor (dB)	Emission (dBuV/m)	Limit (dBuV/m)	Over Limit (dB)	Detector	Polarization
1	4924	41.56	7.31	48.87	54	-5.13	peak	Horizontal
2	7386	36.28	11.41	47.69	54	-6.31	peak	Horizontal
3	9848	31.76	14.38	46.14	54	-7.86	peak	Horizontal
4	4924	38.02	7.31	45.33	54	-8.67	peak	Vertical
5	7386	35.76	11.41	47.17	54	-6.83	peak	Vertical
6	9848	34.24	14.38	48.62	54	-5.38	peak	Vertical

**Test mode: 802.11 n(HT40)**

**Channel: 2422**

Mar k	Frequency (MHz)	Reading (dBuV)	Factor (dB)	Emission (dBuV/m)	Limit (dBuV/m)	Over Limit (dB)	Detector	Polarization
1	4844	38.43	6.6	45.03	54	-8.97	peak	Horizontal
2	7266	37.2	10.89	48.09	54	-5.91	peak	Horizontal
3	9688	32.61	14.35	46.96	54	-7.04	peak	Horizontal
4	4844	41.53	6.6	48.13	54	-5.87	peak	Vertical
5	7266	36.5	10.89	47.39	54	-6.61	peak	Vertical
6	9688	32.79	14.35	47.14	54	-6.86	peak	Vertical

**Test mode: 802.11 n(HT40)**

**Channel: 2437**

Mar k	Frequency (MHz)	Reading (dBuV)	Factor (dB)	Emission (dBuV/m)	Limit (dBuV/m)	Over Limit (dB)	Detector	Polarization
1	4874	38.02	6.92	44.94	54	-9.06	peak	Horizontal
2	7311	36.77	11.08	47.85	54	-6.15	peak	Horizontal
3	9748	35.32	14.36	49.68	54	-4.32	peak	Horizontal
4	4874	43.03	6.92	49.95	54	-4.05	peak	Vertical
5	7311	36.37	11.08	47.45	54	-6.55	peak	Vertical
6	9748	31.73	14.36	46.09	54	-7.91	peak	Vertical

**Test mode: 802.11 n(HT40)**

**Channel: 2452**

Mar k	Frequency (MHz)	Reading (dBuV)	Factor (dB)	Emission (dBuV/m)	Limit (dBuV/m)	Over Limit (dB)	Detector	Polarization
1	4904	39.76	7.22	46.98	54	-7.02	peak	Horizontal
2	7356	37.4	11.28	48.68	54	-5.32	peak	Horizontal
3	9808	32.82	14.37	47.19	54	-6.81	peak	Horizontal
4	4904	38.58	7.22	45.8	54	-8.2	peak	Vertical
5	7356	35.62	11.28	46.9	54	-7.1	peak	Vertical
6	9808	31.08	14.37	45.45	54	-8.55	peak	Vertical

- Remark: 1) Emission = Receiver Reading + Factor  
 2) Factor = Antenna Factor + Cable Loss + Pre-amplifier Factor.  
 3) If the Peak value below the AV Limit, the AV test doesn't perform for this submission.

### 6.8.2 Radiated Band edge

Test Mode: 802.11b

Channel: 2412

MK	Frequency (MHz)	Reading (dBuV/m)	Corrected factor(dB)	Result (dBuV/m)	Limit (dBuV/m)	Over Limit (dB)	Detector	Polarization
1	2340.96	52.02	-3.75	48.27	54	-5.73	Peak	Horizontal
2	2390	48.49	-3.89	44.6	54	-9.4	Peak	Horizontal
3	2413.08	102.5	-3.93	98.57	54	44.57	Peak	Horizontal
1	2389.68	52.91	-3.88	49.03	54	-4.97	Peak	Vertical
2	2390	52.15	-3.89	48.26	54	-5.74	Peak	Vertical
3	2413.08	101.93	-3.93	98	54	44	Peak	Vertical

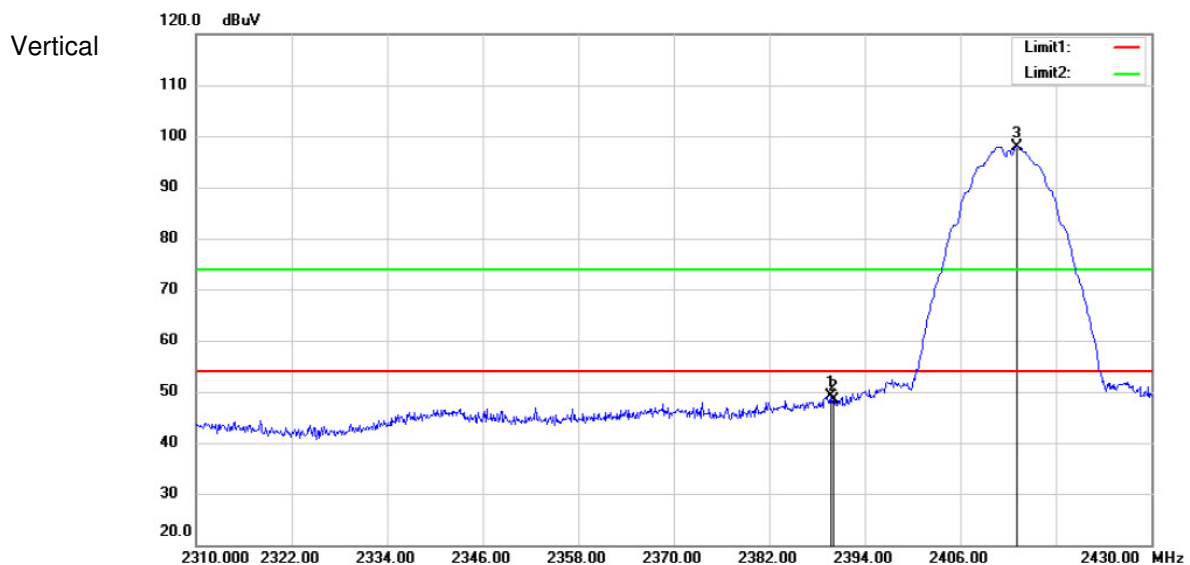
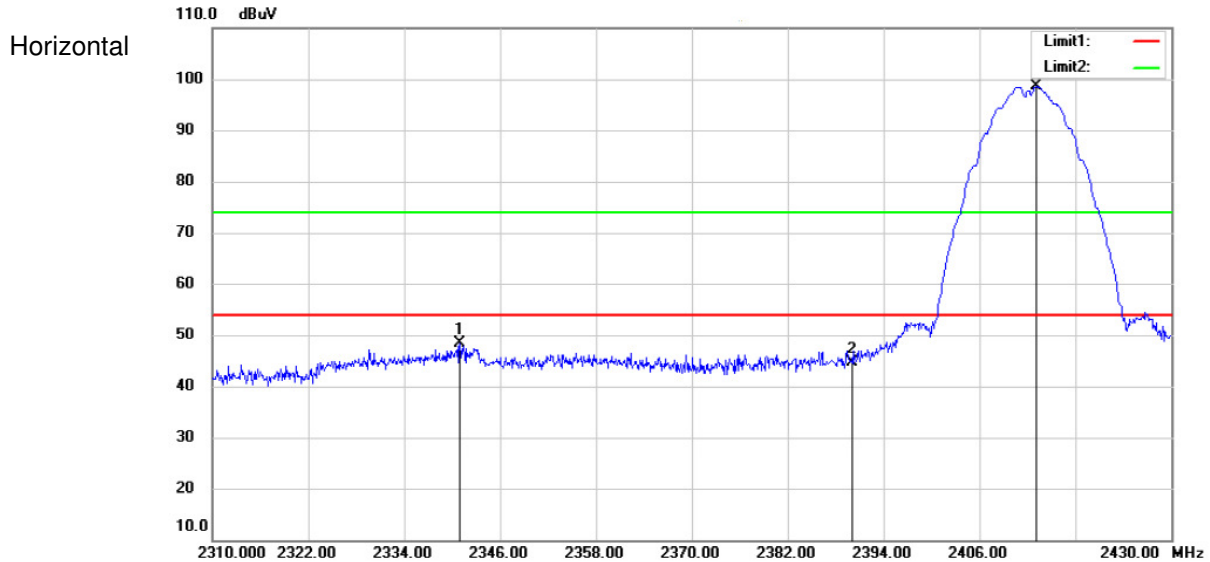

**Test Mode: 802.11b**

**Channel: 2462**

MK	Frequency (MHz)	Reading (dBuV/m)	Corrected factor(dB)	Result (dBuV/m)	Limit (dBuV/m)	Over Limit (dB)	Detector	Polarization
1	2463	104.03	-3.99	100.04	54	46.04	Peak	Horizontal
2	2483.5	52.18	-4.01	48.17	54	-5.83	Peak	Horizontal
3	2488.8	53.67	-4.02	49.65	54	-4.35	Peak	Horizontal
1	2463.1	94.92	-3.98	90.94	54	36.94	Peak	Vertical
2	2483.5	45.31	-4.01	41.3	54	-12.7	Peak	Vertical
3	2493.9	50.12	-4.03	46.09	54	-7.91	Peak	Vertical

Horizontal

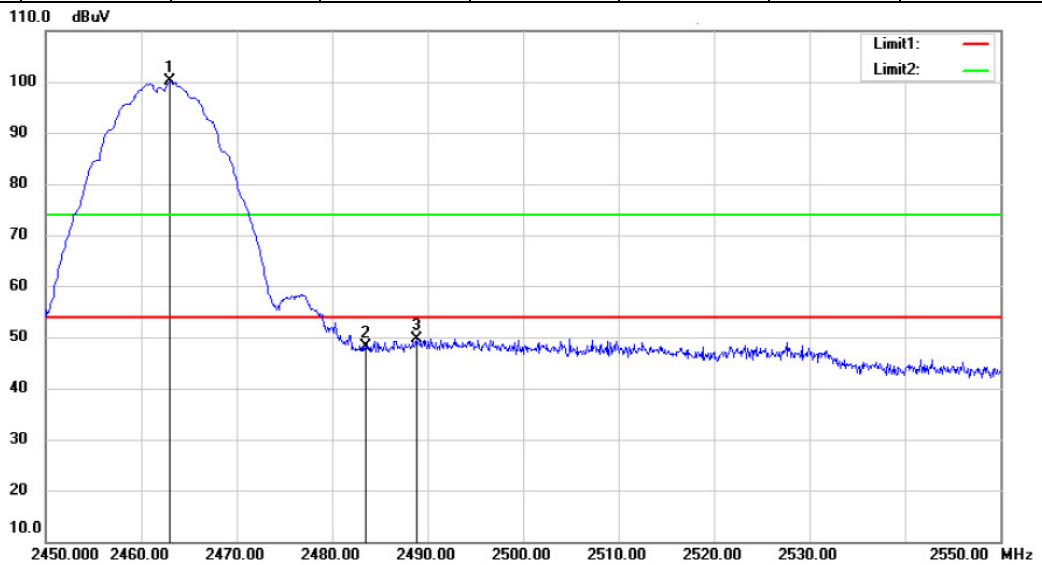

Vertical

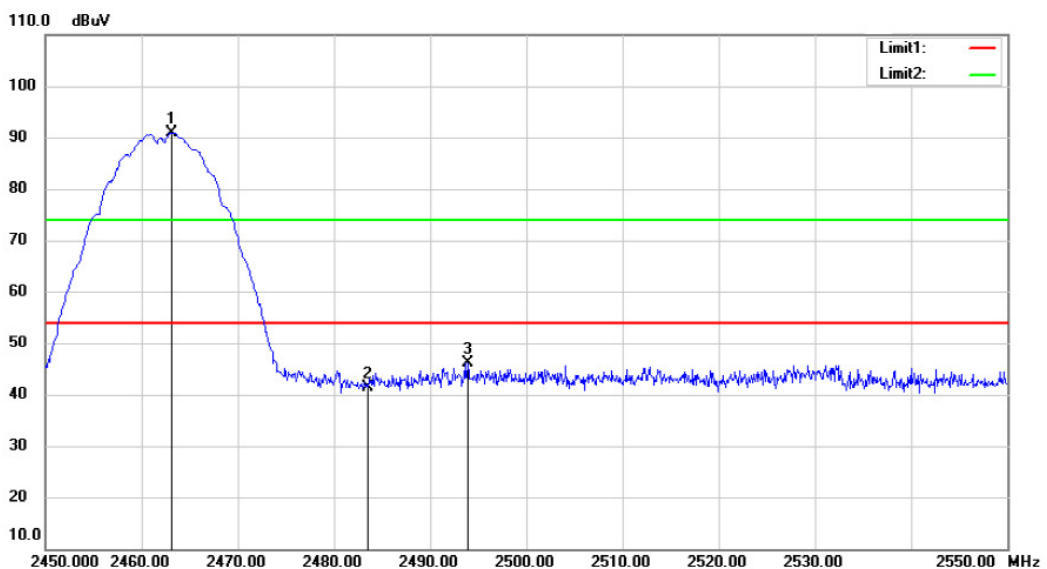

**Test Mode: 802.11g**

**Channel: 2412**

MK.	Frequency (MHz)	Reading (dBuV/m)	Corrected factor(dB)	Result (dBuV/m)	Limit (dBuV/m)	Over Limit (dB)	Detector	Polarization
1	2389.8	61.69	-3.89	57.8	74	-16.2	Peak	Horizontal
2	2390	61.85	-3.89	57.96	74	-16.04	Peak	Horizontal
3	2415	105.42	-3.94	101.48	74	27.48	Peak	Horizontal
1	2388.96	44.55	-3.89	40.66	54	-13.34	Average	Horizontal
2	2390	47.13	-3.89	43.24	54	-10.76	Average	Horizontal
3	2414.76	95.47	-3.94	91.53	54	37.53	Average	Horizontal

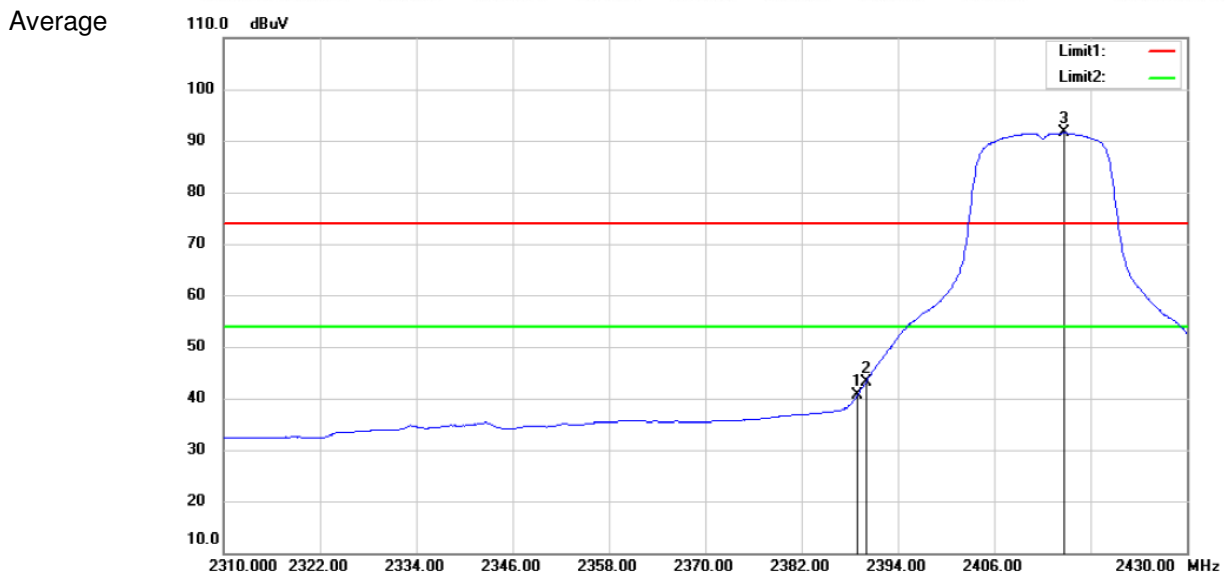
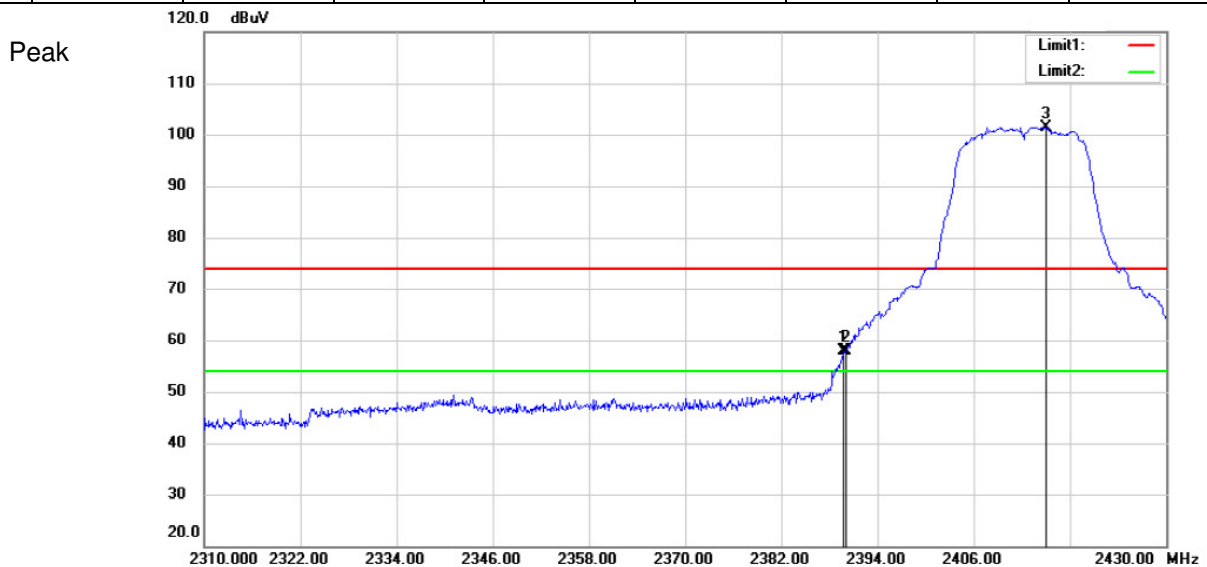

**Test Mode: 802.11g**

**Channel: 2412**

MK.	Frequency (MHz)	Reading (dBuV/m)	Corrected factor(dB)	Result (dBuV/m)	Limit (dBuV/m)	Over Limit (dB)	Detector	Polarization
1	2388.72	52.83	-3.89	48.94	54	-5.06	Peak	Vertical
2	2390	50.18	-3.89	46.29	54	-7.71	Peak	Vertical
3	2409.24	100.66	-3.93	96.73	54	42.73	Peak	Vertical

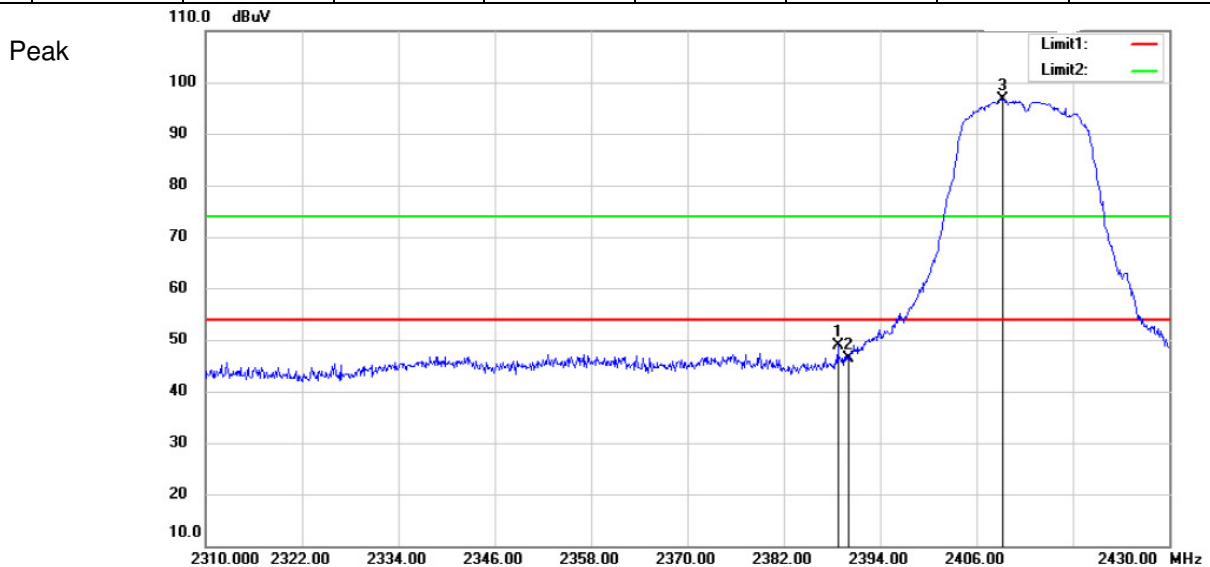



**Test Mode: 802.11g**

**Channel: 2462**

MK.	Frequency (MHz)	Reading (dBuV/m)	Corrected factor(dB)	Result (dBuV/m)	Limit (dBuV/m)	Over Limit (dB)	Detector	Polarization
1	2465	107.09	-4	103.09	74	29.09	Peak	Horizontal
2	2483.5	69.31	-4.01	65.3	74	-8.7	Peak	Horizontal
3	2484.7	68.26	-4.01	64.25	74	-9.75	Peak	Horizontal
1	2464.9	97.09	-4	93.09	54	39.09	Average	Horizontal
2	2483.5	55.57	-4.01	51.56	54	-2.44	Average	Horizontal
3	2484.3	52.96	-4.02	48.94	54	-5.06	Average	Horizontal

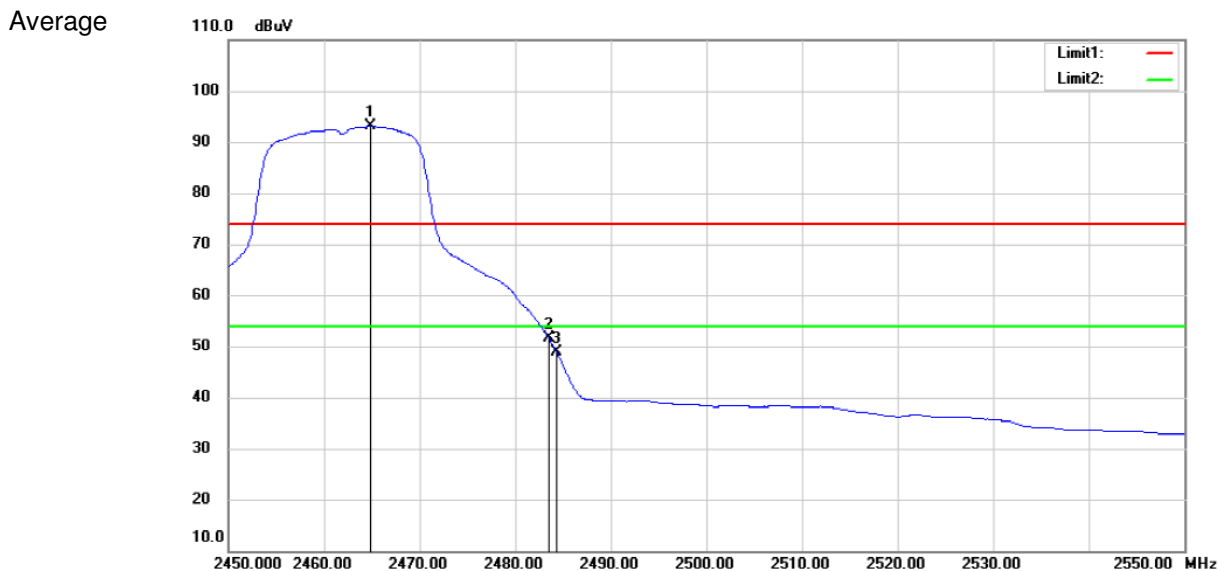
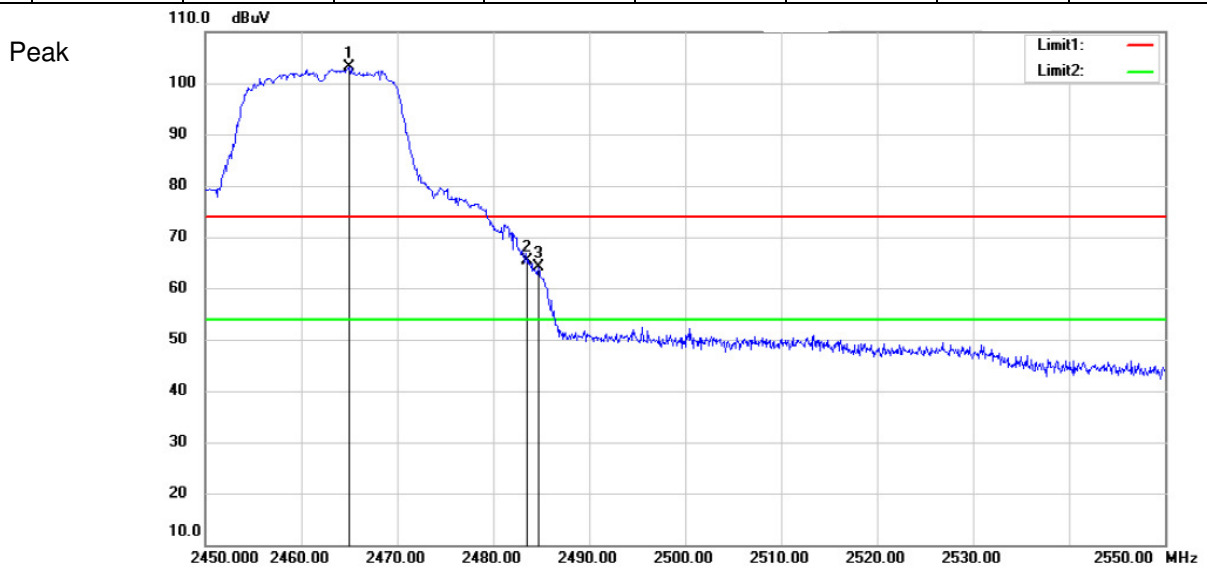

**Test Mode: 802.11 g**

**Channel: 2462**

MK	Frequency (MHz)	Reading (dBuV/m)	Corrected factor(dB)	Result (dBuV/m)	Limit (dBuV/m)	Over Limit (dB)	Detector	Polarization
1	2465	98.04	-4	94.04	54	40.04	Peak	Vertical
2	2483.5	49.42	-4.01	45.41	54	-8.59	Peak	Vertical
3	2502.7	51.21	-4	47.21	54	-6.79	Peak	Vertical

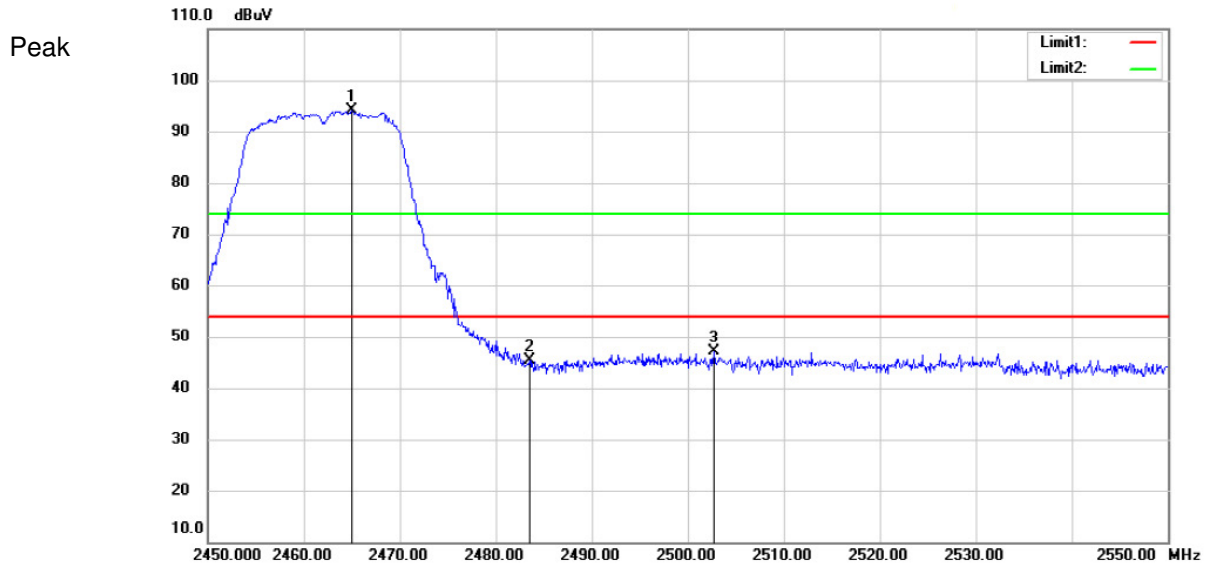

**Test Mode: 802.11 n(HT20)**

**Channel: 2412**

MK	Frequency (MHz)	Reading (dBuV/m)	Corrected factor(dB)	Result (dBuV/m)	Limit (dBuV/m)	Over Limit (dB)	Detector	Polarization
1	2389.08	59.65	-3.89	55.76	74	-18.24	Peak	Horizontal
2	2390	61.31	-3.89	57.42	74	-16.58	Peak	Horizontal
3	2413.32	104.13	-3.93	100.2	74	26.2	Peak	Horizontal
1	2388.96	45.16	-3.89	41.27	54	-12.73	Average	Horizontal
2	2390	47.05	-3.89	43.16	54	-10.84	Average	Horizontal
3	2415	94.1	-3.94	90.16	54	36.16	Average	Horizontal

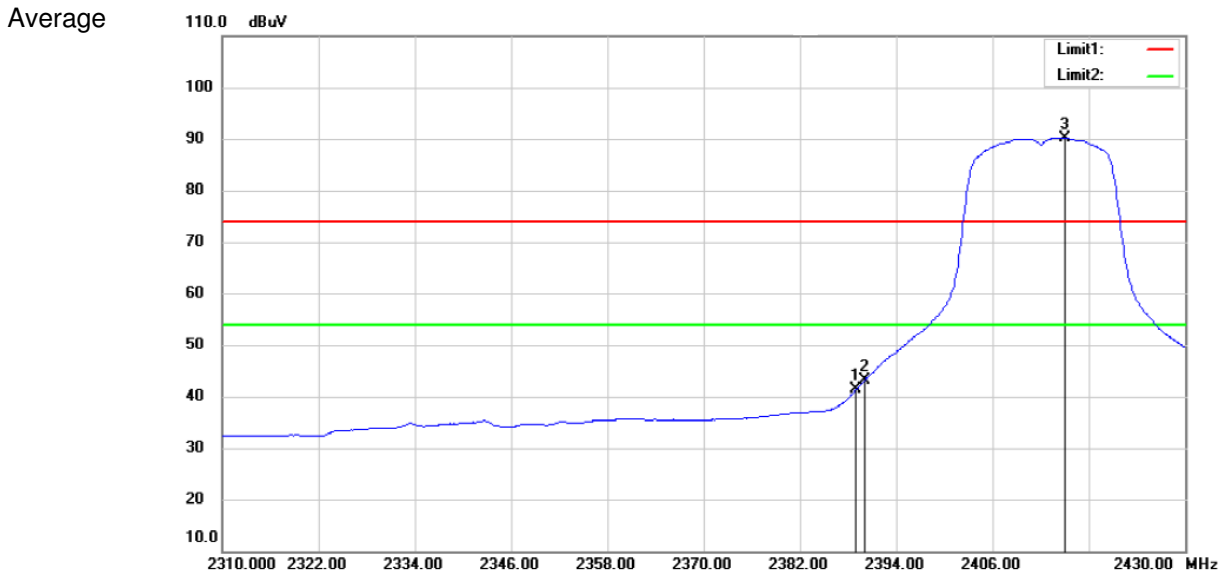
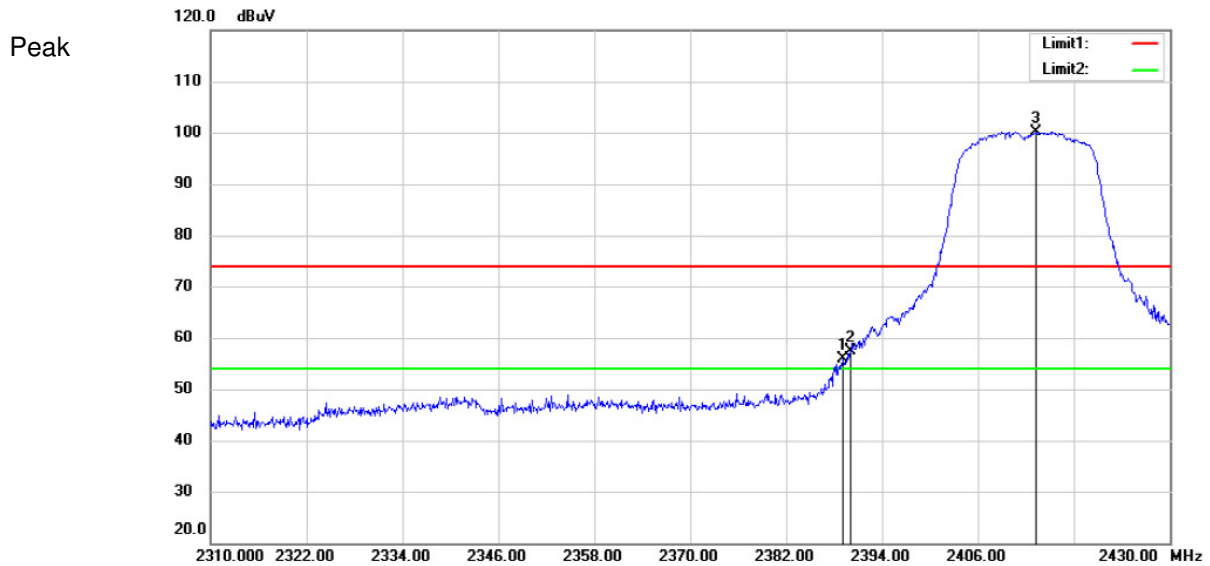

**Test Mode: 802.11 n(HT20)**

**Channel: 2412**

MK	Frequency (MHz)	Reading (dBuV/m)	Corrected factor(dB)	Result (dBuV/m)	Limit (dBuV/m)	Over Limit (dB)	Detector	Polarization
1	2359.08	50.76	-3.79	46.97	54	-7.03	Peak	Vertical
2	2390	50.4	-3.89	46.51	54	-7.49	Peak	Vertical
3	2409.6	100.18	-3.93	96.25	54	42.25	Peak	Vertical

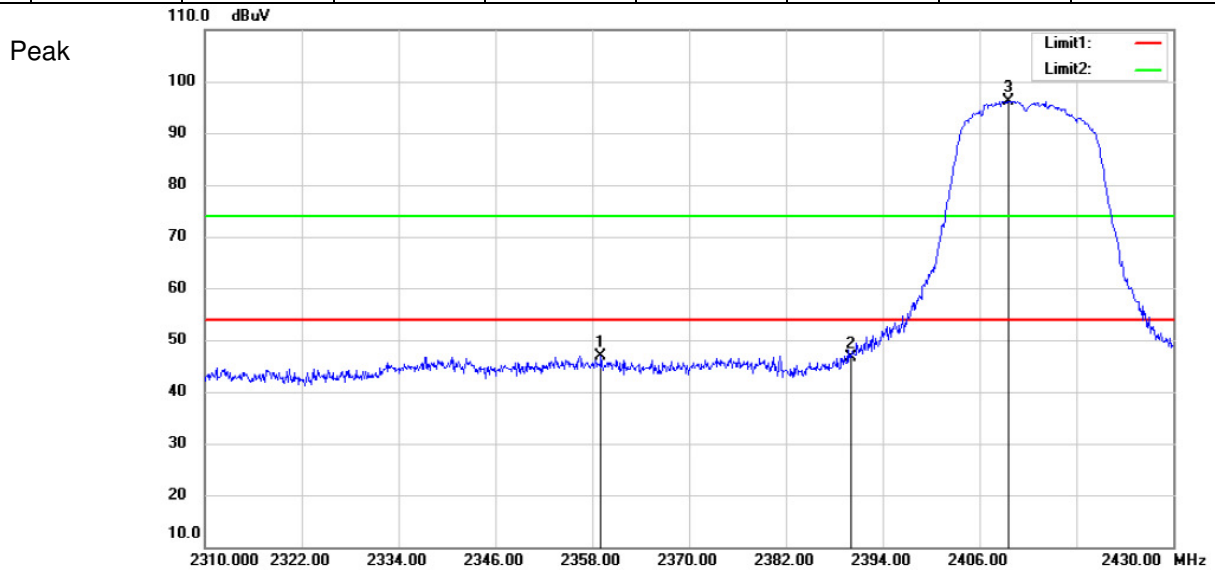



**Test Mode: 802.11 n(HT20)**

**Channel: 2462**

MK	Frequency (MHz)	Reading (dBuV/m)	Corrected factor(dB)	Result (dBuV/m)	Limit (dBuV/m)	Over Limit (dB)	Detector	Polarization
1	2464.9	106.08	-4	102.08	74	28.08	Peak	Horizontal
2	2483.5	70.28	-4.01	66.27	74	-7.73	Peak	Horizontal
3	2484.3	68.21	-4.02	64.19	74	-9.81	Peak	Horizontal
1	2464.9	96.32	-4	92.32	54	38.32	Average	Horizontal
2	2483.5	55.08	-4.01	51.07	54	-2.93	Average	Horizontal
3	2484.3	53.37	-4.02	49.35	54	-4.65	Average	Horizontal

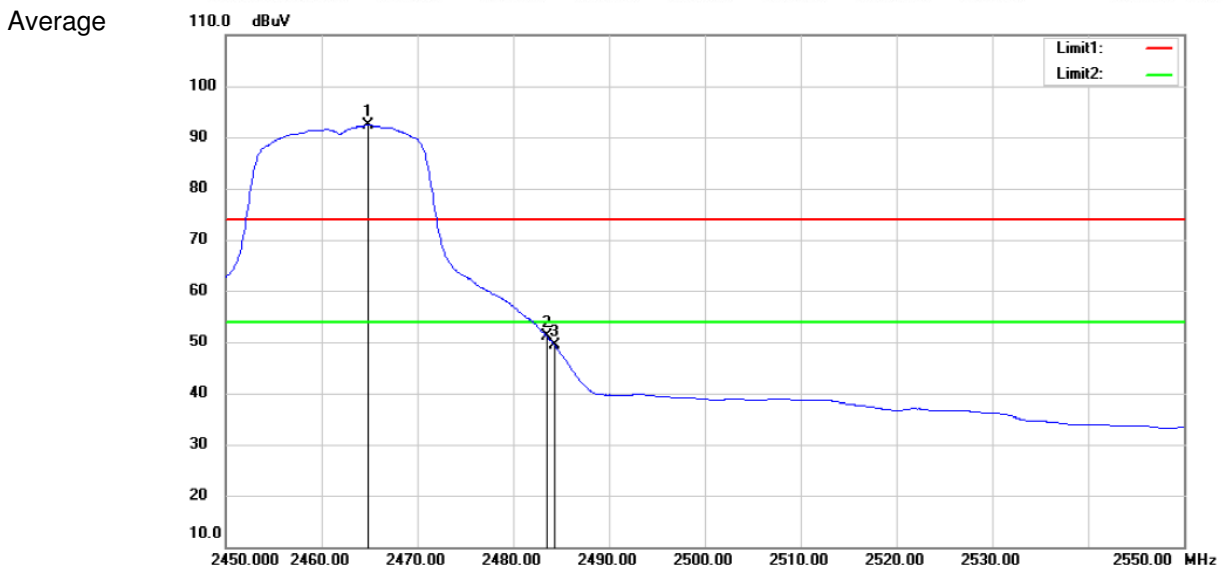
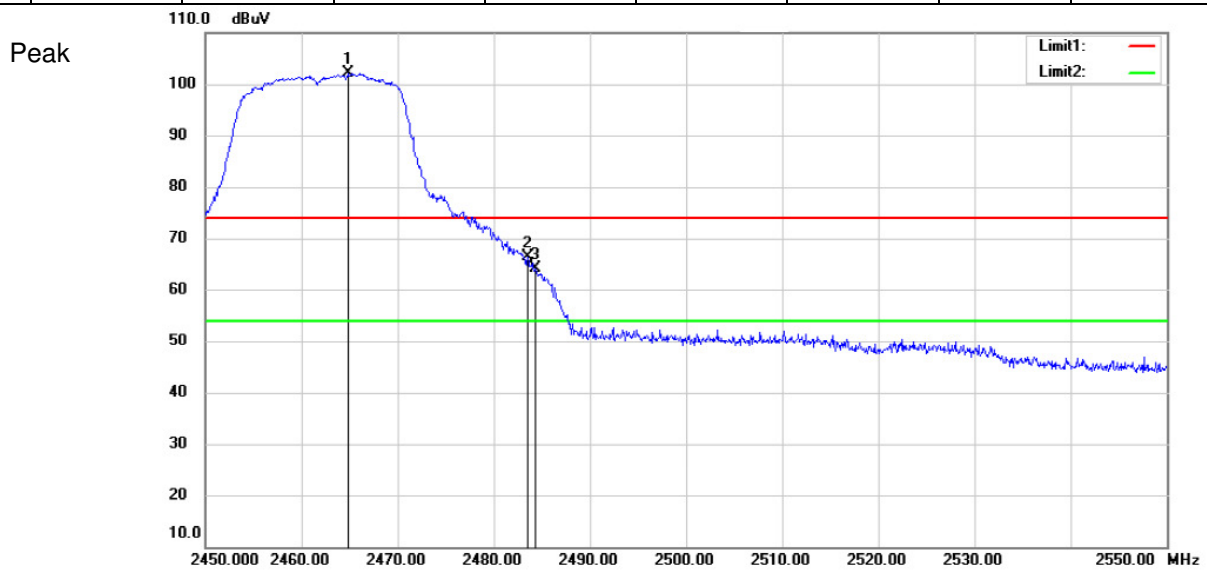

**Test Mode: 802.11 n(HT20)**

**Channel: 2462**

MK	Frequency (MHz)	Reading (dBuV/m)	Corrected factor(dB)	Result (dBuV/m)	Limit (dBuV/m)	Over Limit (dB)	Detector	Polarization
1	2464.5	97.84	-3.99	93.85	54	39.85	Peak	Vertical
2	2483.5	49.06	-4.01	45.05	54	-8.95	Peak	Vertical
3	2532.2	51.12	-3.67	47.45	54	-6.55	Peak	Vertical

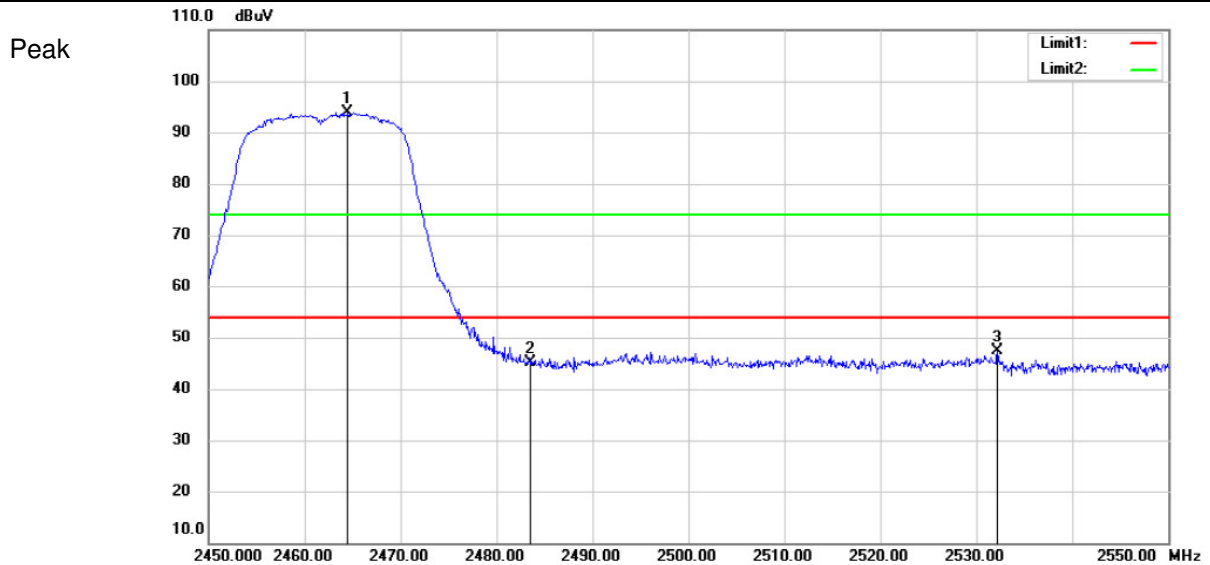

**Test Mode: 802.11 n(HT40)**

**Channel: 2422**

MK	Frequency (MHz)	Reading (dBuV/m)	Corrected factor(dB)	Result (dBuV/m)	Limit (dBuV/m)	Over Limit (dB)	Detector	Polarization
1	2388.4	65.64	-3.88	61.76	74	-12.24	Peak	Horizontal
2	2390	64.52	-3.89	60.63	74	-13.37	Peak	Horizontal
3	2431.8	102.02	-3.96	98.06	74	24.06	Peak	Horizontal
1	2389.1	51.16	-3.89	47.27	54	-6.73	Average	Horizontal
2	2390	51.72	-3.89	47.83	54	-6.17	Average	Horizontal
3	2428.72	90.75	-3.95	86.8	54	32.8	Average	Horizontal

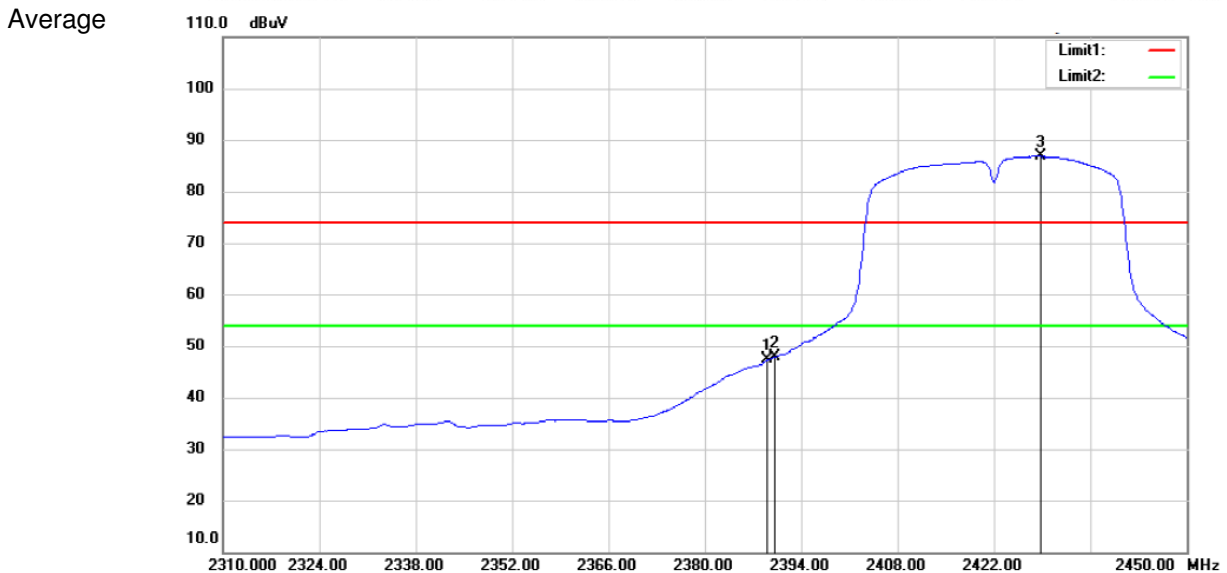
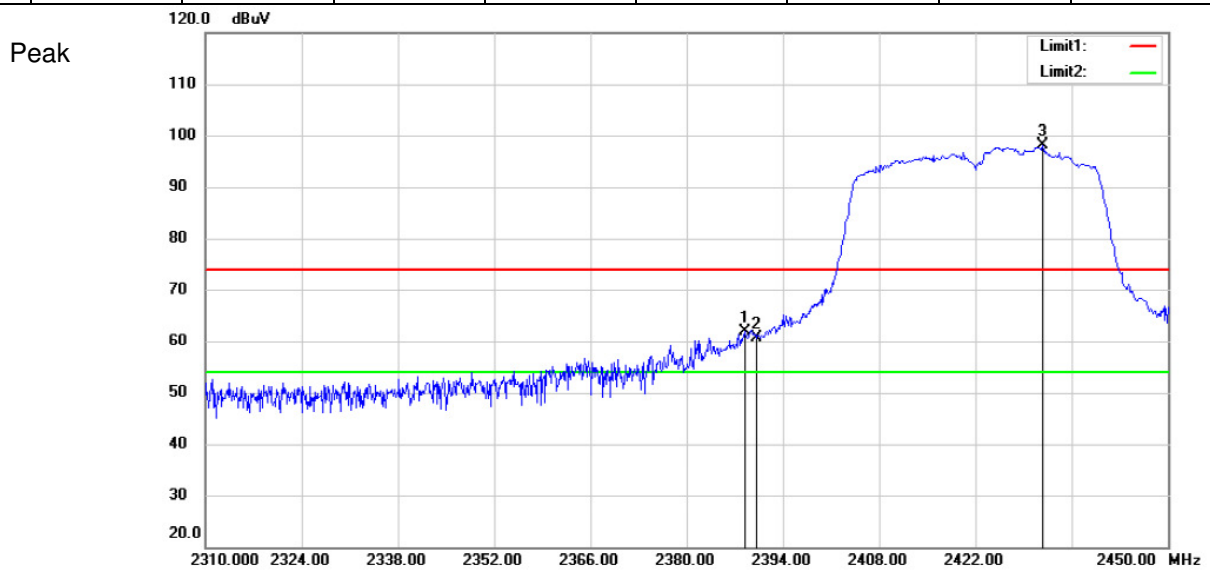

**Test Mode: 802.11 n(HT40)**

**Channel: 2422**

MK	Frequency (MHz)	Reading (dBuV/m)	Corrected factor(dB)	Result (dBuV/m)	Limit (dBuV/m)	Over Limit (dB)	Detector	Polarization
1	2387.84	62.87	-3.88	58.99	74	-15.01	Peak	Vertical
2	2390	60.21	-3.89	56.32	74	-17.68	Peak	Vertical
3	2412.34	97.7	-3.94	93.76	74	19.76	Peak	Vertical
1	2388.68	44.37	-3.89	40.48	54	-13.52	Average	Vertical
2	2390	45.13	-3.89	41.24	54	-12.76	Average	Vertical
3	2413.04	86.78	-3.93	82.85	54	28.85	Average	Vertical

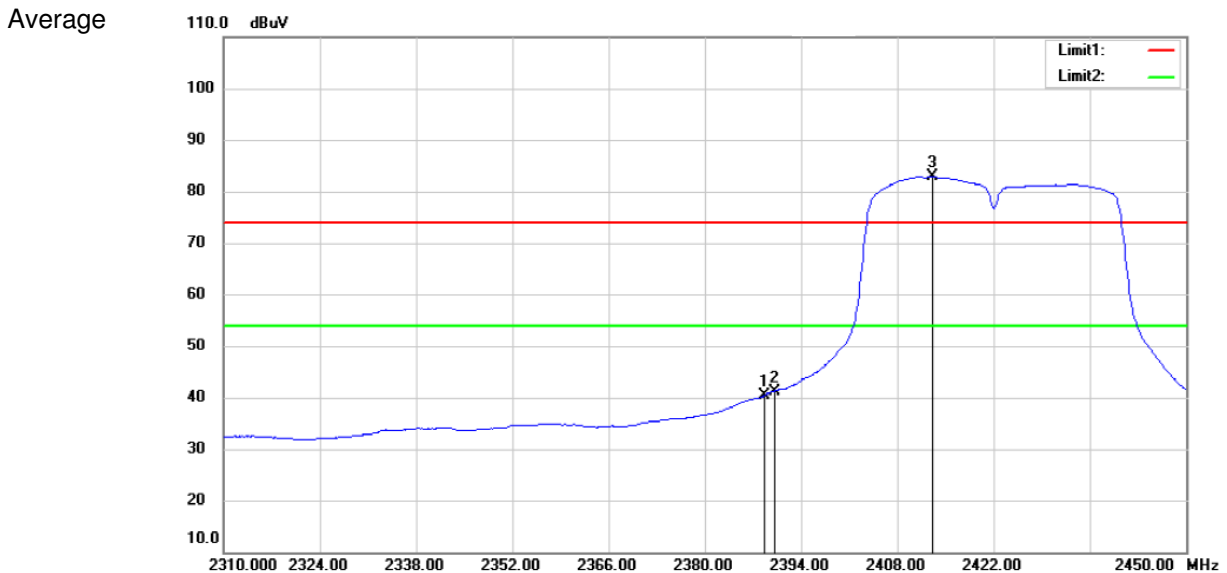
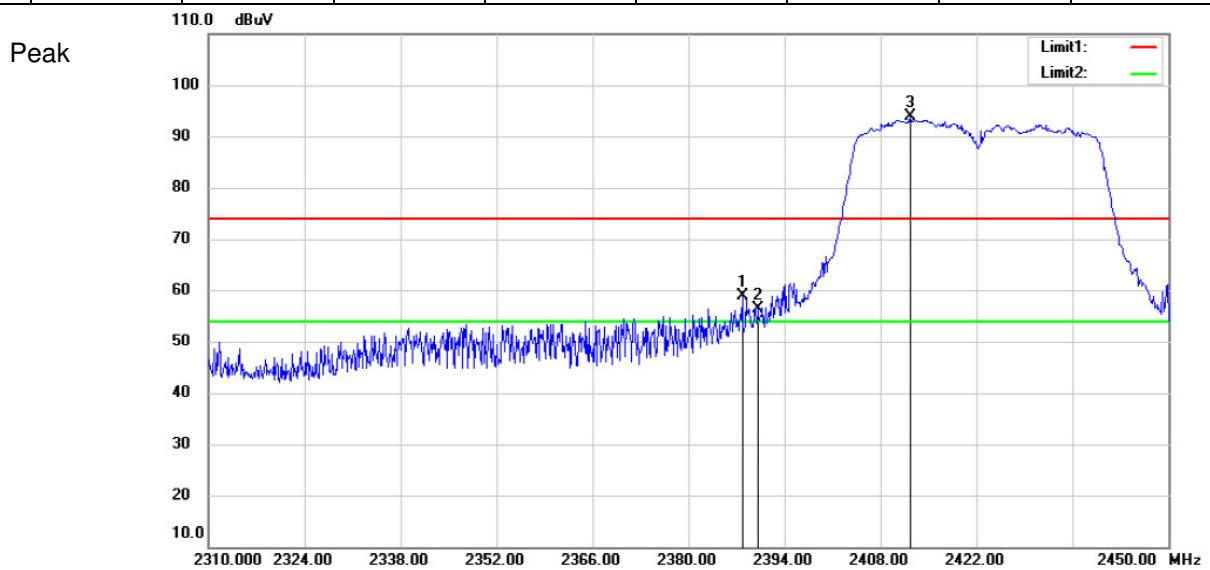



**Test Mode: 802.11 n(HT40)**

**Channel: 2452**

MK	Frequency (MHz)	Reading (dBuV/m)	Corrected factor(dB)	Result (dBuV/m)	Limit (dBuV/m)	Over Limit (dB)	Detector	Polarization
1	2460.96	103.37	-3.98	99.39	74	25.39	Peak	Horizontal
2	2483.5	73.78	-4.01	69.77	74	-4.23	Peak	Horizontal
3	2484.6	74.08	-4.01	70.07	74	-3.93	Peak	Horizontal
1	2460.96	91.43	-3.98	87.45	54	33.45	Average	Horizontal
2	2483.5	57.32	-4.01	53.31	54	-0.69	Average	Horizontal
3	2484.6	56.75	-4.01	52.74	54	-1.26	Average	Horizontal

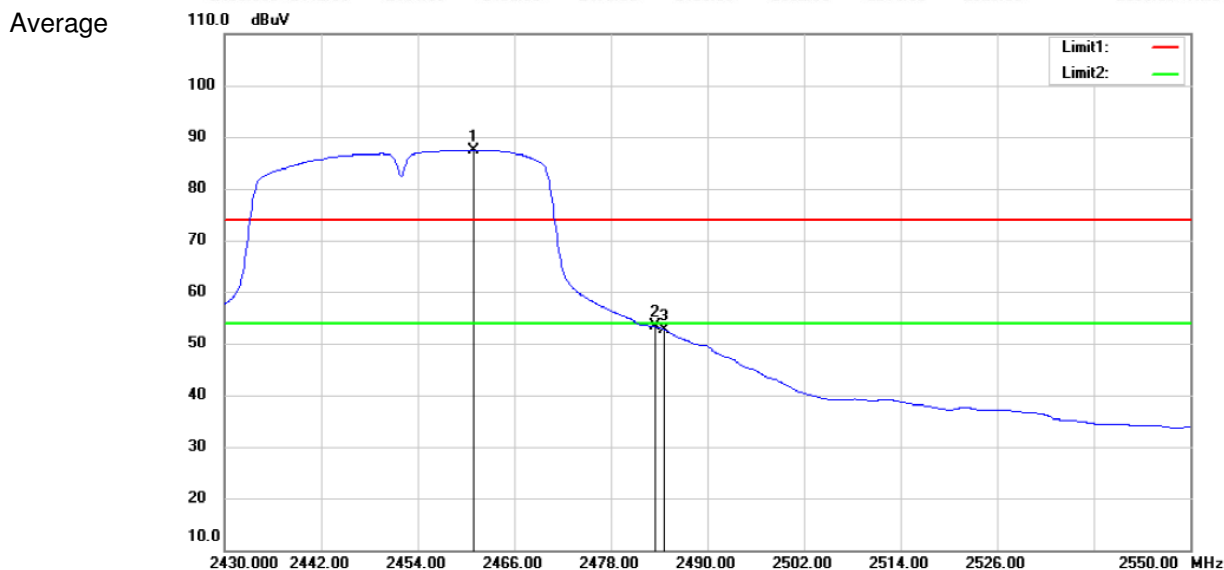
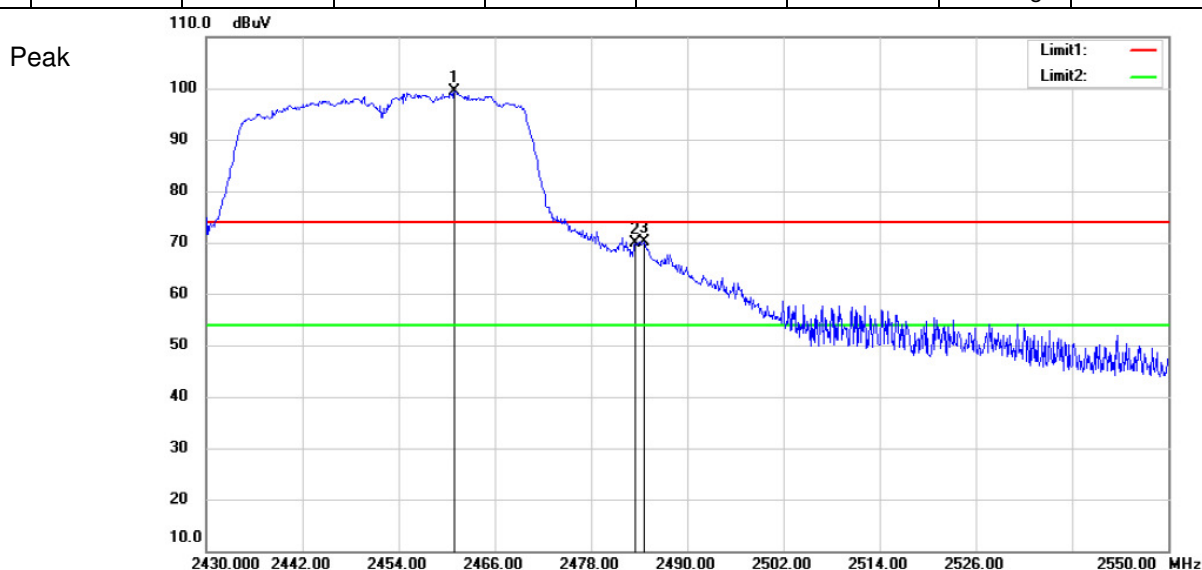

**Test Mode: 802.11 n(HT40)**

**Channel: 2452**

MK	Frequency (MHz)	Reading (dBuV/m)	Corrected factor(dB)	Result (dBuV/m)	Limit (dBuV/m)	Over Limit (dB)	Detector	Polarization
1	2444.52	97.18	-3.96	93.22	74	19.22	Peak	Vertical
2	2483.5	53.92	-4.01	49.91	74	-24.09	Peak	Vertical
3	2497.32	58.52	-4.03	54.49	74	-19.51	Peak	Vertical
1	2445.24	86.78	-3.97	82.81	54	28.81	Average	Vertical
2	2483.5	41.64	-4.01	37.63	54	-16.37	Average	Vertical
3	2484.36	41.42	-4.02	37.4	54	-16.6	Average	Vertical

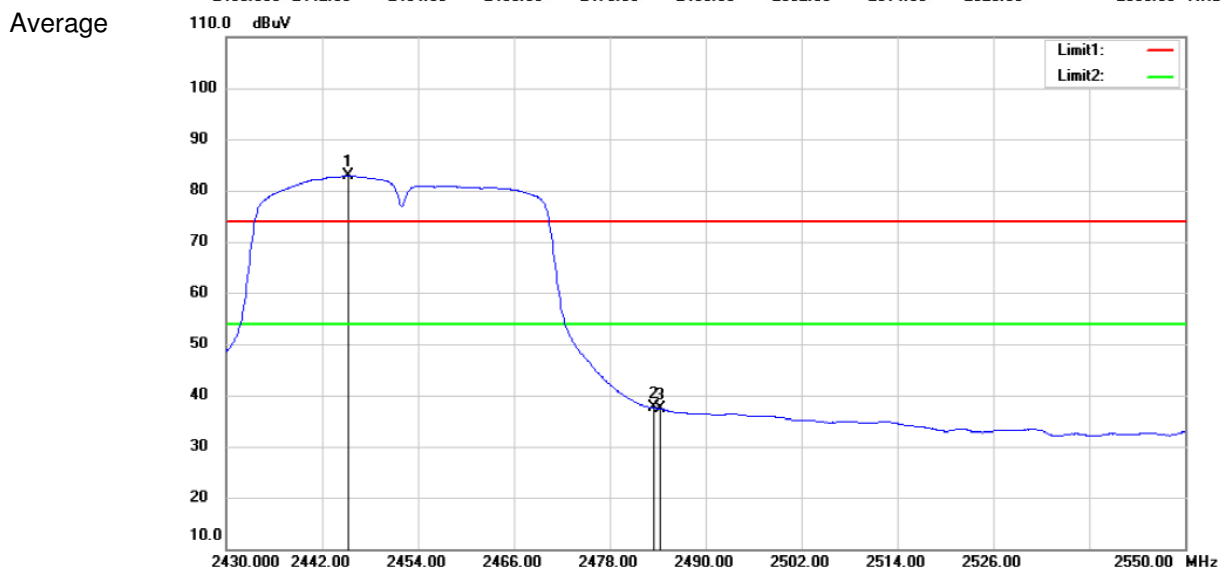
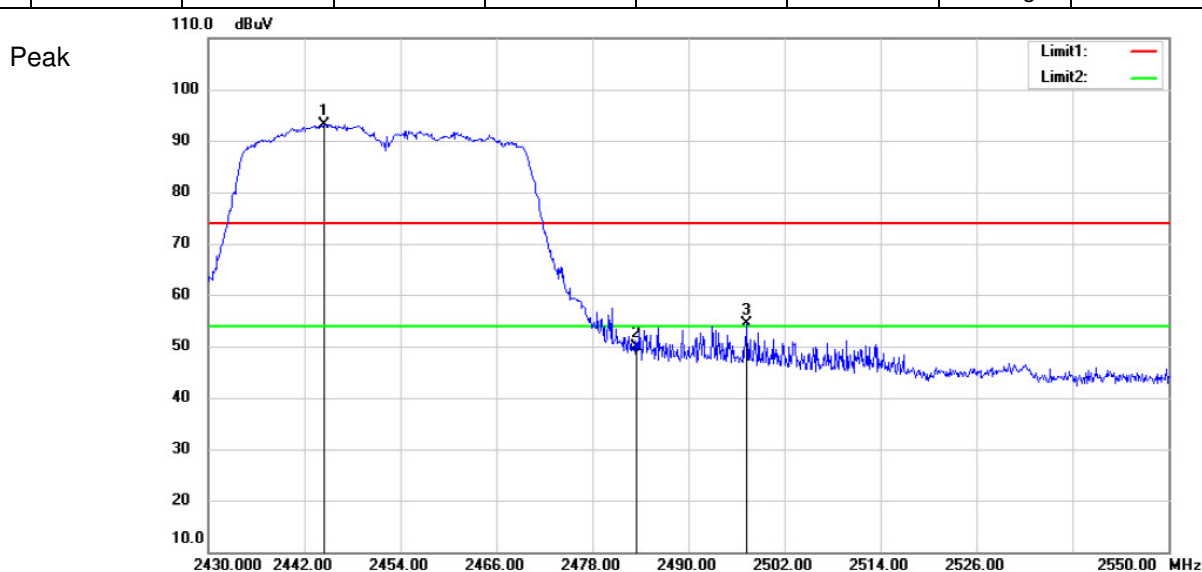



Remark: 1). Test Level = Receiver Reading + Antenna Factor + Cable Loss- Preamplifier Factor  
2). If the Peak value below the AV Limit, the AV test doesn't perform for this submission.

All frequencies within the "Restricted bands" have been evaluated to compliance. Except as shown in paragraph of this section, only spurious emissions are permitted in any of the frequency bands listed below:

a. FCC Part 15, Subpart C Section 15.205 Restricted bands of operation.

MHz	MHz	MHz	GHz
0.090 - 0.110	16.42 - 16.423	399.9 - 410	4.5 - 5.15
10.495 - 0.505	16.69475 - 16.69525	608 - 614	5.35 - 5.46
2.1735 - 2.1905	16.80425 - 16.80475	960 - 1240	7.25 - 7.75
4.125 - 4.128	25.5 - 25.67	1300 - 1427	8.025 - 8.5
4.17725 - 4.17775	37.5 - 38.25	1435 - 1626.5	9.0 - 9.2
4.20725 - 4.20775	73 - 74.6	1645.5 - 1646.5	9.3 - 9.5
6.215 - 6.218	74.8 - 75.2	1660 - 1710	10.5 - 12.7
6.26775 - 6.26825	108 - 121.94	1718.8 - 1722.2	13.25 - 13.4
6.31175 - 6.31225	123 - 138	2200 - 2300	14.47 - 14.5
8.291 - 8.294	149.9 - 150.05	2310 - 2390	15.35 - 16.2
8.362 - 8.366	156.52475 - 156.52525	2483.5 - 2500	17.7 - 21.4
8.37625 - 8.38675	156.7 - 156.9	2655 - 2900	22.01 - 23.12
8.41425 - 8.41475	162.0125 - 167.17	3260 - 3267	23.6 - 24.0
12.29 - 12.293	167.72 - 173.2	3332 - 3339	31.2 - 31.8
12.51975 - 12.52025	240 - 285	3345.8 - 3358	36.43 - 36.5
12.57675 - 12.57725	322 - 335.4	3600 - 4400	
13.36 - 13.41			



## **7 Test Setup Photographs**

Refer to the < Test Setup photos-FCC>.

## **8 EUT Constructional Details**

Refer to the < External Photos > & < Internal Photos >.

**--End of the Report--**