

# TEST REPORT

**Application No.:** KSCR2210001890AT  
**FCC ID:** SVNDH-DB86I  
**Applicant:** Zhejiang Dahua Vision Technology Co., Ltd  
**Address of Applicant:** No.1199, Bin'an Road, Binjiang District, Hangzhou, P.R. China  
**Manufacturer:** Zhejiang Dahua Vision Technology Co., Ltd  
**Address of Manufacturer:** No.1199, Bin'an Road, Binjiang District, Hangzhou, P.R. China  
**Equipment Under Test (EUT):**  
**EUT Name:** Doorbell  
**Model No.:** DH-DB86I-USA; DH-DB86I-CAN; DB86I-USA; DB86I-CAN; DB86I ♣  
♣ Please refer to section 2 of this report which indicates which model was actually tested and which were electrically identical.  
**Standard(s) :** 47 CFR Part 15, Subpart E 15.407  
**Date of Receipt:** 2022-10-10  
**Date of Test:** 2022-10-12 to 2022-10-18  
**Date of Issue:** 2022-10-20

<b>Test Result:</b>	<b>Pass*</b>
---------------------	--------------

\* In the configuration tested, the EUT complied with the standards specified above.

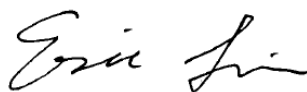

Eric Lin  
Laboratory Manager



Unless otherwise agreed in writing, this document is issued by the Company subject to its General Conditions of Service printed overleaf, available on request or accessible at <http://www.sgs.com/en/Terms-and-Conditions.aspx> and, for electronic format documents, subject to Terms and Conditions for Electronic Documents at <http://www.sgs.com/en/Terms-and-Conditions/Terms-e-Document.aspx>. Attention is drawn to the limitation of liability, indemnification and jurisdiction issues defined therein. Any holder of this document is advised that information contained hereon reflects the Company's findings at the time of its intervention only and within the limits of Client's instructions, if any. The Company's sole responsibility is to its Client and this document does not exonerate parties to a transaction from exercising all their rights and obligations under the transaction documents. This document cannot be reproduced except in full, without prior written approval of the Company. Any unauthorized alteration, forgery or falsification of the content or appearance of this document is unlawful and offenders may be prosecuted to the fullest extent of the law. Unless otherwise stated the results shown in this test report refer only to the sample(s) tested and such sample(s) are retained for 30 days only.  
**Attention: To check the authenticity of testing /inspection report & certificate, please contact us at telephone: (86-755) 8307 1443, or email: CN.Doccheck@sgs.com**  
No.10, Weiye Road, Innovation Park, Kunshan, Jiangsu, China 215300      t(86-512)57355888      f(86-512)57370818      www.sgsgroup.com.cn  
中国·江苏·昆山市留学生创业园伟业路10号 邮编 215300      t(86-512)57355888      f(86-512)57370818      sgs.china@sgs.com

Revision Record			
Version	Description	Date	Remark
00	Original	2022-10-20	/

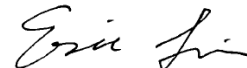
Authorized for issue by:			
			
		Eric Liu /Project Engineer	
			
		Eric Lin /Reviewer	



Unless otherwise agreed in writing, this document is issued by the Company subject to its General Conditions of Service printed overleaf, available on request or accessible at <http://www.sgs.com/en/Terms-and-Conditions.aspx> and, for electronic format documents, subject to Terms and Conditions for Electronic Documents at <http://www.sgs.com/en/Terms-and-Conditions/Terms-e-Documents.aspx>. Attention is drawn to the limitation of liability, indemnification and jurisdiction issues defined therein. Any holder of this document is advised that information contained hereon reflects the Company's findings at the time of its intervention only and within the limits of Client's instructions, if any. The Company's sole responsibility is to its Client and this document does not exonerate parties to a transaction from exercising all their rights and obligations under the transaction documents. This document cannot be reproduced except in full, without prior written approval of the Company. Any unauthorized alteration, forgery or falsification of the content or appearance of this document is unlawful and offenders may be prosecuted to the fullest extent of the law. Unless otherwise stated the results shown in this test report refer only to the sample(s) tested and such sample(s) are retained for 30 days only.

**Attention: To check the authenticity of testing /inspection report & certificate, please contact us at telephone: (86-755) 8307 1443, or email: CN.Doccheck@sgs.com**

No.10, Weiye Road, Innovation Park, Kunshan, Jiangsu, China 215300      t(86-512)57355888      f(86-512)57370818      www.sgs.com.cn  
 中国·江苏·昆山市留学生创业园伟业路10号 邮编 215300      t(86-512)57355888      f(86-512)57370818      sgs.china@sgs.com

## 2 Test Summary

Radio Spectrum Technical Requirement				
Item	Standard	Method	Requirement	Result
Antenna Requirement	47 CFR Part 15, Subpart E 15.407	N/A	47 CFR Part 15, Subpart C 15.203	Pass
Transmission in the Absence of Data		N/A	47 CFR Part 15, Subpart E 15.407 (c)	Pass

Radio Spectrum Matter Part				
Item	Standard	Method	Requirement	Result
Conducted Emissions at AC Power Line (150kHz-30MHz)	47 CFR Part 15, Subpart E 15.407	ANSI C63.10 (2013) Section 6.2	47 CFR Part 15, Subpart C 15.207 & Subpart E 15.407 b(9)	Pass
Duty Cycle		KDB 789033 II B 1	KDB 789033 D02 II B 1	Pass
99% Bandwidth		KDB 789033 II D	N/A	Pass
26dB Emission bandwidth		KDB 789033 D02 II C 1	47 CFR Part 15, Subpart E 15.407 (a)	Pass
Minimum 6 dB bandwidth (5.725-5.85 GHz band )		KDB 789033 D02 II C 2	47 CFR Part 15, Subpart E 15.407 (e)	Pass
Maximum Conducted output power		KDB 789033 D02 II E	47 CFR Part 15, Subpart E 15.407 (a)	Pass
Peak Power spectrum density		KDB 789033 D02 II F	47 CFR Part 15, Subpart E 15.407 (a)	Pass
Radiated Emissions (Above 1GHz)		KDB 789033 D02 II G	47 CFR Part 15, Subpart C 15.209 & Subpart E 15.407(b)	Pass
Radiated Emissions which fall in the restricted bands		KDB 789033 D02 II G	47 CFR Part 15, Subpart C 15.209 & Subpart E 15.407(b)	Pass
Frequency Stability		ANSI C63.10 (2013) Section 6.8	47 CFR Part 15, Subpart E 15.407 (g)	Pass
Non-occupancy period		KDB 905462 D02 Section 7.8.3	KDB 905462 D02 Section 5.1	Pass
Channel Move Time		KDB 905462 D02 Section 7.8.3	KDB 905462 D02 Section 5.1	Pass
Channel Closing Transmission Time		KDB 905462 D02 Section 7.8.3	KDB 905462 D02 Section 5.1	Pass
Radiated Emissions (Below 1GHz)		KDB 789033 D02 II G	47 CFR Part 15, Subpart C 15.209 & Subpart E 15.407(b)	Pass



Unless otherwise agreed in writing, this document is issued by the Company subject to its General Conditions of Service printed overleaf, available on request or accessible at <http://www.sgs.com/en/Terms-and-Conditions.aspx> and, for electronic format documents, subject to Terms and Conditions for Electronic Documents at <http://www.sgs.com/en/Terms-and-Conditions/Terms-e-Documents.aspx>. Attention is drawn to the limitation of liability, indemnification and jurisdiction issues defined therein. Any holder of this document is advised that information contained hereon reflects the Company's findings at the time of its intervention only and within the limits of Client's instructions, if any. The Company's sole responsibility is to its Client and this document does not exonerate parties to a transaction from exercising all their rights and obligations under the transaction documents. This document cannot be reproduced except in full, without prior written approval of the Company. Any unauthorized alteration, forgery or falsification of the content or appearance of this document is unlawful and offenders may be prosecuted to the fullest extent of the law. Unless otherwise stated the results shown in this test report refer only to the sample(s) tested and such sample(s) are retained for 30 days only.

**Attention: To check the authenticity of testing /inspection report & certificate, please contact us at telephone: (86-755) 8307 1443, or email: CN.Doccheck@sgs.com**

No.10, Weiye Road, Innovation Park, Kunshan, Jiangsu, China 215300  
 中国·江苏·昆山市留学生创业园伟业路10号 邮编 215300

t(86-512)57355888 f(86-512)57370818 www.sgsgroup.com.cn  
 t(86-512)57355888 f(86-512)57370818 sgs.china@sgs.com

## Compliance Certification Services (Kunshan) Inc.

Report No.: KSCR221000189002

Page: 4 of 607

### Declaration of EUT Family Grouping:

Note: There are series models mentioned in this report, and they are the Identical in electrical and electronic characters. Only the model DH-DB86I-USA was tested since their differences were the model number and appearance.



Unless otherwise agreed in writing, this document is issued by the Company subject to its General Conditions of Service printed overleaf, available on request or accessible at <http://www.sgs.com/en/Terms-and-Conditions.aspx> and, for electronic format documents, subject to Terms and Conditions for Electronic Documents at <http://www.sgs.com/en/Terms-and-Conditions/Terms-e-Documents.aspx>. Attention is drawn to the limitation of liability, indemnification and jurisdiction issues defined therein. Any holder of this document is advised that information contained hereon reflects the Company's findings at the time of its intervention only and within the limits of Client's instructions, if any. The Company's sole responsibility is to its Client and this document does not exonerate parties to a transaction from exercising all their rights and obligations under the transaction documents. This document cannot be reproduced except in full, without prior written approval of the Company. Any unauthorized alteration, forgery or falsification of the content or appearance of this document is unlawful and offenders may be prosecuted to the fullest extent of the law. Unless otherwise stated the results shown in this test report refer only to the sample(s) tested and such sample(s) are retained for 30 days only.  
**Attention: To check the authenticity of testing / inspection report & certificate, please contact us at telephone: (86-755) 8307 1443, or email: [CN.Doccheck@sgs.com](mailto:CN.Doccheck@sgs.com)**

No.10, Weiye Road, Innovation Park, Kunshan, Jiangsu, China 215300  
中国·江苏·昆山市留学生创业园伟业路10号 邮编 215300

t(86-512)57355888 f(86-512)57370818 www.sgsgroup.com.cn  
t(86-512)57355888 f(86-512)57370818 sgs.china@sgs.com

### 3 Contents

	Page
1 COVER PAGE .....	1
2 TEST SUMMARY .....	3
3 CONTENTS .....	5
4 GENERAL INFORMATION .....	8
4.1 DETAILS OF E.U.T. ....	8
4.2 DESCRIPTION OF SUPPORT UNITS .....	9
4.3 MEASUREMENT UNCERTAINTY .....	9
4.4 TEST LOCATION .....	10
4.5 TEST FACILITY .....	10
4.6 DEVIATION FROM STANDARDS .....	10
4.7 ABNORMALITIES FROM STANDARD CONDITIONS .....	10
5 EQUIPMENT LIST .....	11
6 RADIO SPECTRUM TECHNICAL REQUIREMENT .....	12
6.1 ANTENNA REQUIREMENT .....	12
6.1.1 Test Requirement: .....	12
6.1.2 Conclusion .....	12
6.2 TRANSMISSION IN THE ABSENCE OF DATA .....	13
6.2.1 Test Requirement: .....	13
6.2.2 Conclusion .....	13
7 RADIO SPECTRUM MATTER TEST RESULTS .....	14
7.1 CONDUCTED EMISSIONS AT AC POWER LINE (150KHZ-30MHZ) .....	14
7.1.1 E.U.T. Operation .....	14
7.1.2 Test Mode Description .....	14
7.1.3 Test Setup Diagram .....	15
7.1.4 Measurement Procedure and Data .....	16
7.2 DUTY CYCLE .....	19
7.2.1 E.U.T. Operation .....	19
7.2.2 Test Mode Description .....	19
7.2.3 Test Setup Diagram .....	20
7.2.4 Measurement Procedure and Data .....	20
7.3 99% BANDWIDTH .....	21
7.3.1 E.U.T. Operation .....	21
7.3.2 Test Mode Description .....	21
7.3.3 Test Setup Diagram .....	22
7.3.4 Measurement Procedure and Data .....	22
7.4 26dB EMISSION BANDWIDTH .....	23
7.4.1 E.U.T. Operation .....	23
7.4.2 Test Mode Description .....	23



Unless otherwise agreed in writing, this document is issued by the Company subject to its General Conditions of Service printed overleaf, available on request or accessible at <http://www.sgs.com/en/Terms-and-Conditions.aspx> and, for electronic format documents, subject to Terms and Conditions for Electronic Documents at <http://www.sgs.com/en/Terms-and-Conditions/Terms-e-Documents.aspx>. Attention is drawn to the limitation of liability, indemnification and jurisdiction issues defined therein. Any holder of this document is advised that information contained hereon reflects the Company's findings at the time of its intervention only and within the limits of Client's instructions, if any. The Company's sole responsibility is to its Client and this document does not exonerate parties to a transaction from exercising all their rights and obligations under the transaction documents. This document cannot be reproduced except in full, without prior written approval of the Company. Any unauthorized alteration, forgery or falsification of the content or appearance of this document is unlawful and offenders may be prosecuted to the fullest extent of the law. Unless otherwise stated the results shown in this test report refer only to the sample(s) tested and such sample(s) are retained for 30 days only.

**Attention: To check the authenticity of testing /inspection report & certificate, please contact us at telephone: (86-755) 8307 1443, or email: CN.Doccheck@sgs.com**

No.10, Weiye Road, Innovation Park, Kunshan, Jiangsu, China 215300  
 中国·江苏·昆山市留学生创业园伟业路10号 邮编 215300

t(86-512)57355888 f(86-512)57370818 www.sgs.com.cn  
 t(86-512)57355888 f(86-512)57370818 sgs.china@sgs.com



7.4.3	Test Setup Diagram .....	24
7.4.4	Measurement Procedure and Data .....	24
7.5	MINIMUM 6 dB BANDWIDTH (5.725-5.85 GHz BAND) .....	25
7.5.1	E.U.T. Operation .....	25
7.5.2	Test Mode Description .....	25
7.5.3	Test Setup Diagram .....	25
7.5.4	Measurement Procedure and Data .....	26
7.6	MAXIMUM CONDUCTED OUTPUT POWER .....	27
7.6.1	E.U.T. Operation .....	27
7.6.2	Test Mode Description .....	27
7.6.3	Test Setup Diagram .....	28
7.6.4	Measurement Procedure and Data .....	28
7.7	PEAK POWER SPECTRUM DENSITY .....	29
7.7.1	E.U.T. Operation .....	29
7.7.2	Test Mode Description .....	29
7.7.3	Test Setup Diagram .....	30
7.7.4	Measurement Procedure and Data .....	30
7.8	RADIATED EMISSIONS (ABOVE 1GHz) .....	31
7.8.1	E.U.T. Operation .....	31
7.8.2	Test Mode Description .....	31
7.8.3	Test Setup Diagram .....	32
7.8.4	Measurement Procedure and Data .....	33
7.9	RADIATED EMISSIONS WHICH FALL IN THE RESTRICTED BANDS .....	153
7.9.1	E.U.T. Operation .....	153
7.9.2	Test Mode Description .....	154
7.9.3	Test Setup Diagram .....	155
7.9.4	Measurement Procedure and Data .....	156
7.10	FREQUENCY STABILITY .....	244
7.10.1	E.U.T. Operation .....	244
7.10.2	Test Mode Description .....	244
7.10.3	Test Setup Diagram .....	245
7.10.4	Measurement Procedure and Data .....	245
7.11	NON-OCCUPANCY PERIOD .....	246
7.11.1	E.U.T. Operation .....	246
7.11.2	Test Mode Description .....	247
7.11.3	Test Setup Diagram .....	247
7.11.4	Measurement Procedure and Data .....	248
7.12	CHANNEL MOVE TIME .....	249
7.12.1	E.U.T. Operation .....	249
7.12.2	Test Mode Description .....	250
7.12.3	Test Setup Diagram .....	250
7.12.4	Measurement Procedure and Data .....	251
7.13	CHANNEL CLOSING TRANSMISSION TIME .....	252
7.13.1	E.U.T. Operation .....	252
7.13.2	Test Mode Description .....	253
7.13.3	Test Setup Diagram .....	253
7.13.4	Measurement Procedure and Data .....	254
7.14	RADIATED EMISSIONS (BELOW 1GHz) .....	255
7.14.1	E.U.T. Operation .....	255



Unless otherwise agreed in writing, this document is issued by the Company subject to its General Conditions of Service printed overleaf, available on request or accessible at <http://www.sgs.com/en/Terms-and-Conditions.aspx> and, for electronic format documents, subject to Terms and Conditions for Electronic Documents at <http://www.sgs.com/en/Terms-and-Conditions/Terms-e-Documents.aspx>. Attention is drawn to the limitation of liability, indemnification and jurisdiction issues defined therein. Any holder of this document is advised that information contained hereon reflects the Company's findings at the time of its intervention only and within the limits of Client's instructions, if any. The Company's sole responsibility is to its Client and this document does not exonerate parties to a transaction from exercising all their rights and obligations under the transaction documents. This document cannot be reproduced except in full, without prior written approval of the Company. Any unauthorized alteration, forgery or falsification of the content or appearance of this document is unlawful and offenders may be prosecuted to the fullest extent of the law. Unless otherwise stated the results shown in this test report refer only to the sample(s) tested and such sample(s) are retained for 30 days only.

Attention: To check the authenticity of testing /inspection report & certificate, please contact us at telephone: (86-755) 8307 1443, or email: [CN.Doccheck@sgs.com](mailto:CN.Doccheck@sgs.com)  
 No.10, Weiye Road, Innovation Park, Kunshan, Jiangsu, China 215300      t(86-512)57355888      f(86-512)57370818      www.sgsgroup.com.cn  
 中国·江苏·昆山市留学生创业园伟业路10号 邮编 215300      t(86-512)57355888      f(86-512)57370818      sgs.china@sgs.com

## Compliance Certification Services (Kunshan) Inc.

Report No.: KSCR221000189002

Page: 7 of 607

7.14.2	Test Mode Description .....	255
7.14.3	Test Setup Diagram .....	256
7.14.4	Measurement Procedure and Data .....	257
8	TEST SETUP PHOTO .....	260
9	EUT CONSTRUCTIONAL DETAILS (EUT PHOTOS) .....	260
10	APPENDIX .....	261



Unless otherwise agreed in writing, this document is issued by the Company subject to its General Conditions of Service printed overleaf, available on request or accessible at <http://www.sgs.com/en/Terms-and-Conditions.aspx> and, for electronic format documents, subject to Terms and Conditions for Electronic Documents at <http://www.sgs.com/en/Terms-and-Conditions/Terms-e-Documents.aspx>. Attention is drawn to the limitation of liability, indemnification and jurisdiction issues defined therein. Any holder of this document is advised that information contained hereon reflects the Company's findings at the time of its intervention only and within the limits of Client's instructions, if any. The Company's sole responsibility is to its Client and this document does not exonerate parties to a transaction from exercising all their rights and obligations under the transaction documents. This document cannot be reproduced except in full, without prior written approval of the Company. Any unauthorized alteration, forgery or falsification of the content or appearance of this document is unlawful and offenders may be prosecuted to the fullest extent of the law. Unless otherwise stated the results shown in this test report refer only to the sample(s) tested and such sample(s) are retained for 30 days only. Attention: To check the authenticity of testing / inspection report & certificate, please contact us at telephone: (86-755) 8307 1443, or email: [CN.Doccheck@sgs.com](mailto:CN.Doccheck@sgs.com)

Compliance Certification Services (Kunshan) Inc.  
EMC Laboratory

No.10, Weiye Road, Innovation Park, Kunshan, Jiangsu, China 215300  
中国·江苏·昆山市留学生创业园伟业路10号 邮编 215300

t(86-512)57355888 f(86-512)57370818 www.sgsgroup.com.cn  
t(86-512)57355888 f(86-512)57370818 sgs.china@sgs.com

## 4 General Information

### 4.1 Details of E.U.T.

Power supply:	DC 3.7V by rechargeable lithium battery charged by 16-24 VAC or DC 5V 2A by USB port Battery Model: 1S1P 652023P Rated Voltage: 3.7V Capacity: 0.2Ah Energy: 0.74Wh Charging Voltage: 4.2V
Operation Frequency (20MHz):	U-NII-1: 5180-5240MHz; U-NII-2A: 5260-5320MHz; U-NII-2C: 5500-5700MHz; U-NII-3: 5745-5825MHz
Operation Frequency (40MHz):	U-NII-1: 5190-5230MHz; U-NII-2A: 5270-5310MHz; U-NII-2C: 5510-5670MHz; U-NII-3: 5755-5795MHz
Operation Frequency (80MHz):	U-NII-1: 5210MHz; U-NII-2A: 5290MHz; U-NII-2C: 5530-5610MHz; U-NII-3: 5775MHz
Modulation Type:	802.11a: OFDM (64QAM, 16QAM, QPSK, BPSK); 802.11n: OFDM (BPSK, QPSK, 16QAM, 64QAM); 802.11ac: OFDM (BPSK, QPSK, 16QAM, 64QAM, 256QAM)
Channel Spacing:	802.11a/n(HT20)/ac(HT20): 20MHz; 802.11n(HT40)/ac(VHT40): 40MHz; 802.11ac(VHT80): 80MHz
DFS Function:	Slave without Radar detection
TPC Function:	Without TPC function
Antenna Type:	FPC antenna
Antenna Gain:	Antenna 1 U-NII-1:1.31dBi; (Provided by manufacturer) U-NII-2A:1.64dBi; (Provided by manufacturer) U-NII-2C: 2.99dBi; (Provided by manufacturer) U-NII-3:1.31dBi; (Provided by manufacturer) Antenna 2; U-NII-1: 1.41dBi (Provided by manufacturer) U-NII-2A: 2.63dBi (Provided by manufacturer) U-NII-2C: 2.33dBi (Provided by manufacturer) U-NII-3: -1.67dBi (Provided by manufacturer) Directional gain U-NII-1:4.37dBi(Provided by manufacturer) Directional gain U-NII-2A: 5.16dBi (Provided by manufacturer) Directional gain U-NII-2C:5.68dBi (Provided by manufacturer) Directional gain U-NII-3:2.96dBi (Provided by manufacturer)
Remark:	Two antennas can simultaneous transmission



Unless otherwise agreed in writing, this document is issued by the Company subject to its General Conditions of Service printed overleaf, available on request or accessible at <http://www.sgs.com/en/Terms-and-Conditions.aspx> and, for electronic format documents, subject to Terms and Conditions for Electronic Documents at <http://www.sgs.com/en/Terms-and-Conditions/Terms-e-Documents.aspx>. Attention is drawn to the limitation of liability, indemnification and jurisdiction issues defined therein. Any holder of this document is advised that information contained hereon reflects the Company's findings at the time of its intervention only and within the limits of Client's instructions, if any. The Company's sole responsibility is to its Client and this document does not exonerate parties to a transaction from exercising all their rights and obligations under the transaction documents. This document cannot be reproduced except in full, without prior written approval of the Company. Any unauthorized alteration, forgery or falsification of the content or appearance of this document is unlawful and offenders may be prosecuted to the fullest extent of the law. Unless otherwise stated the results shown in this test report refer only to the sample(s) tested and such sample(s) are retained for 30 days only.  
**Attention: To check the authenticity of testing /inspection report & certificate, please contact us at telephone: (86-755) 8307 1443, or email: CN.Doccheck@sgs.com**

No.10, Weiye Road, Innovation Park, Kunshan, Jiangsu, China 215300  
中国·江苏·昆山市留学院创业园伟业路10号 邮编 215300

t(86-512)57355888 f(86-512)57370818 www.sgsgroup.com.cn  
t(86-512)57355888 f(86-512)57370818 sgs.china@sgs.com



**4.2 Description of Support Units**

Description	Manufacturer	Model No.	Serial No.
Notebook	LENOVO	K27	EB24537645
Adapter	/	A12-3A-10	/
Router	ASUS	RT-AC88U	J1CGW00078

**4.3 Measurement Uncertainty**

No.	Item	Measurement Uncertainty
1	Radio Frequency	8.4 x 10 <sup>-8</sup>
2	Timeout	2s
3	Duty Cycle	0.37%
4	Occupied Bandwidth	3%
5	RF Conducted Power	0.6dB
6	RF Power Density	2.9dB
7	Conducted Spurious Emissions	0.75dB
8	RF Radiated Power	5.2dB (Below 1GHz)
		5.9dB (Above 1GHz)
9	Radiated Spurious Emission Test	4.2dB (Below 30MHz)
		4.5dB (30MHz-1GHz)
		5.1dB (1GHz-18GHz)
		5.4dB (Above 18GHz)
10	Temperature Test	1°C
11	Humidity Test	3%
12	Supply Voltages	1.5%
13	Time	3%

Note: The measurement uncertainty represents an expanded uncertainty expressed at approximately the 95% confidence level using a coverage factor of k=2.



Unless otherwise agreed in writing, this document is issued by the Company subject to its General Conditions of Service printed overleaf, available on request or accessible at <http://www.sgs.com/en/Terms-and-Conditions.aspx> and, for electronic format documents, subject to Terms and Conditions for Electronic Documents at <http://www.sgs.com/en/Terms-and-Conditions/Terms-e-Documents.aspx>. Attention is drawn to the limitation of liability, indemnification and jurisdiction issues defined therein. Any holder of this document is advised that information contained hereon reflects the Company's findings at the time of its intervention only and within the limits of Client's instructions, if any. The Company's sole responsibility is to its Client and this document does not exonerate parties to a transaction from exercising all their rights and obligations under the transaction documents. This document cannot be reproduced except in full, without prior written approval of the Company. Any unauthorized alteration, forgery or falsification of the content or appearance of this document is unlawful and offenders may be prosecuted to the fullest extent of the law. Unless otherwise stated the results shown in this test report refer only to the sample(s) tested and such sample(s) are retained for 30 days only.  
**Attention: To check the authenticity of testing /inspection report & certificate, please contact us at telephone: (86-755) 8307 1443, or email: CN.Doccheck@sgs.com**

No.10, Weiye Road, Innovation Park, Kunshan, Jiangsu, China 215300  
 中国·江苏·昆山市留学院创业园伟业路10号 邮编 215300

t(86-512)57355888 f(86-512)57370818 www.sgsgroup.com.cn  
 t(86-512)57355888 f(86-512)57370818 sgs.china@sgs.com

## Compliance Certification Services (Kunshan) Inc.

Report No.: KSCR221000189002

Page: 10 of 607

### 4.4 Test Location

All tests were performed at:

Compliance Certification Services (Kunshan) Inc.

No.10 Weiye Rd, Innovation park, Eco&Tec, Development Zone, Kunshan City, Jiangsu, China.

Tel: +86 512 5735 5888 Fax: +86 512 5737 0818

No tests were sub-contracted.

Note:

1. SGS is not responsible for wrong test results due to incorrect information (e.g., max. internal working frequency, antenna gain, cable loss, etc) is provided by the applicant. (If applicable).
2. SGS is not responsible for the authenticity, integrity and the validity of the conclusion based on results of the data provided by applicant. (If applicable).

### 4.5 Test Facility

The test facility is recognized, certified, or accredited by the following organizations:

#### • CNAS

Compliance Certification Services (Kunshan) Inc. is accredited by the China National Accreditation Service for Conformity Assessment (CNAS). Registration No. CNAS L4354

#### • A2LA

Compliance Certification Services (Kunshan) Inc. is accredited by the American Association for Laboratory Accreditation (A2LA). Certificate No. 2541.01.

#### • FCC

Compliance Certification Services (Kunshan) Inc. has been recognized as an accredited testing laboratory. Designation Number: CN1172.

#### • ISED

Compliance Certification Services (Kunshan) Inc. has been recognized by Innovation, Science and Economic Development Canada (ISED) as an accredited testing laboratory. Company Number: 2324E

#### • VCCI

The 3m and 10m Semi-anechoic chamber and Shielded Room of Compliance Certification Services (Kunshan) Inc. has been registered in accordance with the Regulations for Voluntary Control Measures with Registration No.: R-20134, R-11600, C-11707, T-11499, G-10216 respectively.

### 4.6 Deviation from Standards

None

### 4.7 Abnormalities from Standard Conditions

None



Unless otherwise agreed in writing, this document is issued by the Company subject to its General Conditions of Service printed overleaf, available on request or accessible at <http://www.sgs.com/en/Terms-and-Conditions.aspx> and, for electronic format documents, subject to Terms and Conditions for Electronic Documents at <http://www.sgs.com/en/Terms-and-Conditions/Terms-e-Documents.aspx>. Attention is drawn to the limitation of liability, indemnification and jurisdiction issues defined therein. Any holder of this document is advised that information contained hereon reflects the Company's findings at the time of its intervention only and within the limits of Client's instructions, if any. The Company's sole responsibility is to its Client and this document does not exonerate parties to a transaction from exercising all their rights and obligations under the transaction documents. This document cannot be reproduced except in full, without prior written approval of the Company. Any unauthorized alteration, forgery or falsification of the content or appearance of this document is unlawful and offenders may be prosecuted to the fullest extent of the law. Unless otherwise stated the results shown in this test report refer only to the sample(s) tested and such sample(s) are retained for 30 days only.  
**Attention: To check the authenticity of testing / inspection report & certificate, please contact us at telephone: (86-755) 8307 1443, or email: CN.Doccheck@sgs.com**

No.10, Weiye Road, Innovation Park, Kunshan, Jiangsu, China 215300

中国·江苏·昆山市留学生创业园伟业路10号 邮编 215300

t(86-512)57355888 f(86-512)57370818 www.sgsgroup.com.cn

t(86-512)57355888 f(86-512)57370818 sgs.china@sgs.com

## 5 Equipment List

Item	Equipment	Manufacturer	Model	Inventory No	Cal Date	Cal. Due Date
<b>Conducted Emission at Mains Terminals (150kHz-30MHz)</b>						
1	EMI Test Receive	R&S	ESCI	KS301101	01/22/2022	01/21/2023
2	LISN	R&S	ENV216	KS301197	01/22/2022	01/21/2023
3	LISN	Schwarzbeck	NNLK 8129	KS301091	01/22/2022	01/21/2023
4	Pulse Limiter	R&S	ESH3-Z2	KUS1902E001	01/22/2022	01/21/2023
5	CE test Cable	Thermax	/	CZ301102	11/14/2021	11/13/2022
6	Test Software	Farad	EZ-EMC	/	N.C.R	N.C.R
<b>RF Conducted Test</b>						
1	Spectrum Analyzer	Keysight	N9020A	KUS1911E004-2	08/22/2022	08/21/2023
2	Spectrum Analyzer	Keysight	N9020A	KUS2001M001-2	08/22/2022	08/21/2023
3	Spectrum Analyzer	Keysight	N9030B	KSEM021-1	01/22/2022	01/21/2023
4	Signal Generator	R&S	SMW200A	KSEM020-1	08/22/2022	08/21/2023
5	Signal Generator	Agilent	N5182A	KUS2001M001-1	08/22/2022	08/21/2023
6	Radio Communication Test Station	Anritsu	MT8000A	KSEM001-1	08/22/2022	08/21/2023
7	Radio Communication Analyzer	Anritsu	MT8821C	KSEM002-1	04/01/2022	03/31/2023
8	Universal Radio Communication Tester	R&S	CMW500	KUS1911E004-1	08/22/2022	08/21/2023
9	Switcher	CCSRF	FY562	KUS2001M001-3	08/22/2022	08/21/2023
10	AC Power Source	EXTECH	6605	KS301178	N.C.R	N.C.R
11	DC Power Supply	Aglient	E3632A	KS301180	N.C.R	N.C.R
12	Conducted Test Cable	Thermax	RF01-RF04	CZ301111-CZ301120	01/16/2022	01/15/2023
13	Temp. / Humidity Chamber	TERCHY	MHK-120AK	KS301190	04/01/2021	03/31/2023
14	Temperature & Humidity Recorder	Renke Control	RS-WS-N01-6J	KSEM024-5	04/14/2022	04/13/2023
15	Software	BST	TST-PASS	/	N/A	N/A
<b>RF Radiated Test</b>						
1	Spectrum Analyzer	R&S	FSV40	KUS1806E003	08/22/2022	08/21/2023
2	Universal Radio Communication Tester	R&S	CMW500	KSEM009-1	04/01/2022	03/31/2023
3	Signal Generator	Agilent	E8257C	KS301066	08/22/2022	08/21/2023
4	Loop Antenna	COM-POWER	AL-130R	KUS1806E001	04/13/2021	04/12/2023
5	Bilog Antenna	TESEQ	CBL 6112D	KUS1806E005	06/29/2021	06/28/2023
6	Bilog Antenna	SCHWARZBECK	VULB9160	CZ301016	04/13/2021	04/12/2024
7	Horn-antenna(1-18GHz)	Schwarzbeck	BBHA9120D	KS301079	04/02/2022	04/01/2024
8	Horn-antenna(1-18GHz)	ETS-LINDGREN	3117	KS301186	02/22/2021	02/21/2023
9	Horn Antenna(18-40GHz)	Schwarzbeck	BBHA9170	CZ301058	03/17/2022	03/16/2023
10	Amplifier(30MHz~18GHz)	PANSHAN TECHNOLOGY	LNA:1~18G	KSEM010-1	01/22/2022	01/21/2023
11	Amplifier(18~40GHz)	COM-POWER	PAM-840A	KUS1710E001	01/22/2022	01/21/2023
12	RE Test Cable	REBES MICROWAVE	/	CZ301097	11/14/2021	11/13/2022
13	Temperature & Humidity Recorder	Renke Control	RS-WS-N01-6J	KSEM024-4	01/04/2022	31/03/2023
14	Software	Faratronic	EZ_EMC-v 3A1	/	N/A	N/A



Unless otherwise agreed in writing, this document is issued by the Company subject to its General Conditions of Service printed overleaf, available on request or accessible at <http://www.sgs.com/en/Terms-and-Conditions.aspx> and, for electronic format documents, subject to Terms and Conditions for Electronic Documents at <http://www.sgs.com/en/Terms-and-Conditions/Terms-e-Documents.aspx>. Attention is drawn to the limitation of liability, indemnification and jurisdiction issues defined therein. Any holder of this document is advised that information contained hereon reflects the Company's findings at the time of its intervention only and within the limits of Client's instructions, if any. The Company's sole responsibility is to its Client and this document does not exonerate parties to a transaction from exercising all their rights and obligations under the transaction documents. This document cannot be reproduced except in full, without prior written approval of the Company. Any unauthorized alteration, forgery or falsification of the content or appearance of this document is unlawful and offenders may be prosecuted to the fullest extent of the law. Unless otherwise stated the results shown in this test report refer only to the sample(s) tested and such sample(s) are retained for 30 days only.  
**Attention: To check the authenticity of testing / inspection report & certificate, please contact us at telephone: (86-755) 8307 1443, or email: CN.Doccheck@sgs.com**

No.10, Weiye Road, Innovation Park, Kunshan, Jiangsu, China 215300  
 中国·江苏·昆山市留学院创业园伟业路10号 邮编 215300

t(86-512)57355888 f(86-512)57370818 www.sgsgroup.com.cn  
 t(86-512)57355888 f(86-512)57370818 sgs.china@sgs.com

## 6 Radio Spectrum Technical Requirement

### 6.1 Antenna Requirement

#### 6.1.1 Test Requirement:

47 CFR Part 15, Subpart C 15.203

#### 6.1.2 Conclusion

Standard Requirement:

An intentional radiator shall be designed to ensure that no antenna other than that furnished by the responsible party shall be used with the device. The use of a antenna that uses a unique coupling to the intentional radiator, the manufacturer may design the unit permanently attached antenna or of an so that a broken antenna can be replaced by the user, but the use of a standard antenna jack or electrical connector is prohibited.

EUT Antenna:

The antenna 1 is FPC antenna and antenna 2 is FPC antenna, and all no consideration of replacement. The best case gain of the antenna 1 is 1.31dBi for U-NII-1, 1.64dBi for U-NII-2A: 2.99dBi for U-NII-2C, 1.31dBi for U-NII-3 and antenna 2 is 1.41dBi for U-NII-1, 2.63dBi for U-NII-2A: -0.06dBi for U-NII-2C, -1.67dBi for U-NII-3

Antenna location: Refer to internal photo.



Unless otherwise agreed in writing, this document is issued by the Company subject to its General Conditions of Service printed overleaf, available on request or accessible at <http://www.sgs.com/en/Terms-and-Conditions.aspx> and, for electronic format documents, subject to Terms and Conditions for Electronic Documents at <http://www.sgs.com/en/Terms-and-Conditions/Terms-e-Documents.aspx>. Attention is drawn to the limitation of liability, indemnification and jurisdiction issues defined therein. Any holder of this document is advised that information contained hereon reflects the Company's findings at the time of its intervention only and within the limits of Client's instructions, if any. The Company's sole responsibility is to its Client and this document does not exonerate parties to a transaction from exercising all their rights and obligations under the transaction documents. This document cannot be reproduced except in full, without prior written approval of the Company. Any unauthorized alteration, forgery or falsification of the content or appearance of this document is unlawful and offenders may be prosecuted to the fullest extent of the law. Unless otherwise stated the results shown in this test report refer only to the sample(s) tested and such sample(s) are retained for 30 days only.  
**Attention: To check the authenticity of testing /inspection report & certificate, please contact us at telephone: (86-755) 8307 1443, or email: CN.Doccheck@sgs.com**

No.10, Weiye Road, Innovation Park, Kunshan, Jiangsu, China 215300

中国·江苏·昆山市留学生创业园伟业路10号 邮编 215300

t(86-512)57355888 f(86-512)57370818 www.sgs.com.cn

t(86-512)57355888 f(86-512)57370818 sgs.china@sgs.com



### 6.2 Transmission in the Absence of Data

#### 6.2.1 Test Requirement:

47 CFR Part 15, Subpart E 15.407 (c)

#### 6.2.2 Conclusion

6.2.2 Conclusion

Standard Requirement:

The device shall automatically discontinue transmission in case of either absence of information to transmit or operational failure. These provisions are not intended to preclude the transmission of control or signalling information or the use of repetitive codes used by certain digital technologies to complete frame or burst intervals.

Applicants shall include in their application for equipment authorization a description of how this requirement is met.

EUT Details:

WIFI chip support automatically discontinue transmission in case of either absence of information to transmit or operational failure, if the chip detect absence of information to transmit or operational failure, it will be automatically shut off.



Unless otherwise agreed in writing, this document is issued by the Company subject to its General Conditions of Service printed overleaf, available on request or accessible at <http://www.sgs.com/en/Terms-and-Conditions.aspx> and, for electronic format documents, subject to Terms and Conditions for Electronic Documents at <http://www.sgs.com/en/Terms-and-Conditions/Terms-e-Documents.aspx>. Attention is drawn to the limitation of liability, indemnification and jurisdiction issues defined therein. Any holder of this document is advised that information contained hereon reflects the Company's findings at the time of its intervention only and within the limits of Client's instructions, if any. The Company's sole responsibility is to its Client and this document does not exonerate parties to a transaction from exercising all their rights and obligations under the transaction documents. This document cannot be reproduced except in full, without prior written approval of the Company. Any unauthorized alteration, forgery or falsification of the content or appearance of this document is unlawful and offenders may be prosecuted to the fullest extent of the law. Unless otherwise stated the results shown in this test report refer only to the sample(s) tested and such sample(s) are retained for 30 days only.  
**Attention: To check the authenticity of testing / inspection report & certificate, please contact us at telephone: (86-755) 8307 1443, or email: CN.Doccheck@sgs.com**

No.10, Weiye Road, Innovation Park, Kunshan, Jiangsu, China 215300

t(86-512)57355888 f(86-512)57370818 www.sgs.com.cn

中国·江苏·昆山市留学生创业园伟业路10号 邮编 215300

t(86-512)57355888 f(86-512)57370818 sgs.china@sgs.com

## 7 Radio Spectrum Matter Test Results

### 7.1 Conducted Emissions at AC Power Line (150kHz-30MHz)

Test Requirement 47 CFR Part 15, Subpart C 15.207 & Subpart E 15.407 b(9)

Test Method: ANSI C63.10 (2013) Section 6.2

Limit:

Frequency of emission(MHz)	Conducted limit(dB $\mu$ V)	
	Quasi-peak	Average
0.15-0.5	66 to 56*	56 to 46*
0.5-5	56	46
5-30	60	50

\*Decreases with the logarithm of the frequency.

#### 7.1.1 E.U.T. Operation

Operating Environment:

Temperature: 34.3 °C Humidity: 39.7 % RH Atmospheric Pressure: 1010 mbar

#### 7.1.2 Test Mode Description

Pre-scan / Final test	Mode Code	Description
Final test	01	Charge + TX mode (U-NII-1)_Keep the EUT in charging and continuously transmitting mode with all modulation types. All data rates for each modulation type have been tested and found the data rate @ 6Mbps is the worst case of IEEE 802.11a; data rate @ MCS0 is the worst case of IEEE 802.11n(HT20); data rate @ MCS0 is the worst case of IEEE 802.11n(HT40); data rate @ MCS0 is the worst case of IEEE 802.11ac(VHT20); data rate @ MCS0 is the worst case of IEEE 802.11ac(VHT40); data rate @ MCS0 is the worst case of IEEE 802.11ac(VHT80), Only the data of worst case is recorded in the report.
Pre- test	02	Charge + TX mode (U-NII-2A)_Keep the EUT in charging and continuously transmitting mode with all modulation types. All data rates for each modulation type have been tested and found the data rate @ 6Mbps is the worst case of IEEE 802.11a; data rate @ MCS0 is the worst case of IEEE 802.11n(HT20); data rate @ MCS0 is the worst case of IEEE 802.11n(HT40); data rate @ MCS0 is the worst case of IEEE 802.11ac(VHT20); data rate @ MCS0 is the worst case of IEEE 802.11ac(VHT40); data rate @ MCS0 is the worst case of IEEE 802.11ac(VHT80), final test modes are considering the modulation and worse data rates. Only the data of worst case is recorded in the report.
Pre- test	03	Charge + TX mode (U-NII-2C)_Keep the EUT in charging and continuously



Unless otherwise agreed in writing, this document is issued by the Company subject to its General Conditions of Service printed overleaf, available on request or accessible at <http://www.sgs.com/en/Terms-and-Conditions.aspx> and, for electronic format documents, subject to Terms and Conditions for Electronic Documents at <http://www.sgs.com/en/Terms-and-Conditions/Terms-e-Documents.aspx>. Attention is drawn to the limitation of liability, indemnification and jurisdiction issues defined therein. Any holder of this document is advised that information contained hereon reflects the Company's findings at the time of its intervention only and within the limits of Client's instructions, if any. The Company's sole responsibility is to its Client and this document does not exonerate parties to a transaction from exercising all their rights and obligations under the transaction documents. This document cannot be reproduced except in full, without prior written approval of the Company. Any unauthorized alteration, forgery or falsification of the content or appearance of this document is unlawful and offenders may be prosecuted to the fullest extent of the law. Unless otherwise stated the results shown in this test report refer only to the sample(s) tested and such sample(s) are retained for 30 days only.  
**Attention: To check the authenticity of testing /inspection report & certificate, please contact us at telephone: (86-755) 8307 1443, or email: CN.Doccheck@sgs.com**

No.10, Weiye Road, Innovation Park, Kunshan, Jiangsu, China 215300  
 中国·江苏·昆山市留学生创业园伟业路10号 邮编 215300

t(86-512)57355888 f(86-512)57370818 www.sgsgroup.com.cn  
 t(86-512)57355888 f(86-512)57370818 sgs.china@sgs.com

		transmitting mode with all modulation types. All data rates for each modulation type have been tested and found the data rate @ 6Mbps is the worst case of IEEE 802.11a; data rate @ MCS0 is the worst case of IEEE 802.11n(HT20); data rate @ MCS0 is the worst case of IEEE 802.11n(HT40); data rate @ MCS0 is the worst case of IEEE 802.11ac(VHT20); data rate @ MCS0 is the worst case of IEEE 802.11ac(VHT40); data rate @ MCS0 is the worst case of IEEE 802.11ac(VHT80), Only the data of worst case is recorded in the report.
Pre- test	04	Charge + TX mode (U-NII-3)_Keep the EUT in charging and continuously transmitting mode with all modulation types. All data rates for each modulation type have been tested and found the data rate @ 6Mbps is the worst case of IEEE 802.11a; data rate @ MCS0 is the worst case of IEEE 802.11n(HT20); data rate @ MCS0 is the worst case of IEEE 802.11n(HT40); data rate @ MCS0 is the worst case of IEEE 802.11ac(VHT20); data rate @ MCS0 is the worst case of IEEE 802.11ac(VHT40); data rate @ MCS0 is the worst case of IEEE 802.11ac(VHT80), data rates. Only the data of worst case is recorded in the report.

### 7.1.3 Test Setup Diagram

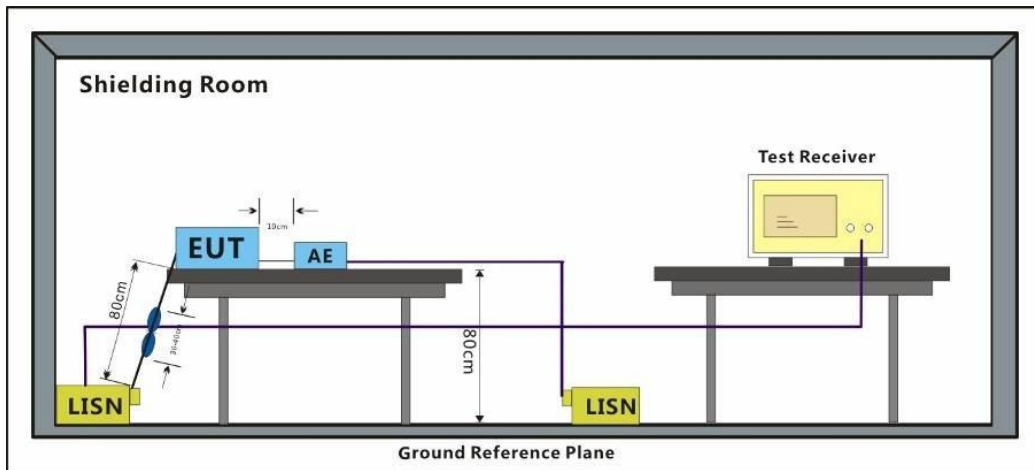

Unless otherwise agreed in writing, this document is issued by the Company subject to its General Conditions of Service printed overleaf, available on request or accessible at <http://www.sgs.com/en/Terms-and-Conditions.aspx> and, for electronic format documents, subject to Terms and Conditions for Electronic Documents at <http://www.sgs.com/en/Terms-and-Conditions/Terms-e-Documents.aspx>. Attention is drawn to the limitation of liability, indemnification and jurisdiction issues defined therein. Any holder of this document is advised that information contained hereon reflects the Company's findings at the time of its intervention only and within the limits of Client's instructions, if any. The Company's sole responsibility is to its Client and this document does not exonerate parties to a transaction from exercising all their rights and obligations under the transaction documents. This document cannot be reproduced except in full, without prior written approval of the Company. Any unauthorized alteration, forgery or falsification of the content or appearance of this document is unlawful and offenders may be prosecuted to the fullest extent of the law. Unless otherwise stated the results shown in this test report refer only to the sample(s) tested and such sample(s) are retained for 30 days only.  
**Attention: To check the authenticity of testing /inspection report & certificate, please contact us at telephone: (86-755) 8307 1443, or email: CN.Doccheck@sgs.com**

No.10, Weiye Road, Innovation Park, Kunshan, Jiangsu, China 215300  
中国·江苏·昆山市留学生创业园伟业路10号 邮编 215300

t(86-512)57355888 f(86-512)57370818 www.sgsgroup.com.cn  
t(86-512)57355888 f(86-512)57370818 sgs.china@sgs.com

### 7.1.4 Measurement Procedure and Data

- 1) The mains terminal disturbance voltage test was conducted in a shielded room.
- 2) The EUT was connected to AC power source through a LISN 1 (Line Impedance Stabilization Network) which provides a 50ohm/50μH + 5ohm linear impedance. The power cables of all other units of the EUT were connected to a second LISN 2, which was bonded to the ground reference plane in the same way as the LISN 1 for the unit being measured. A multiple socket outlet strip was used to connect multiple power cables to a single LISN provided the rating of the LISN was not exceeded.
- 3) The tabletop EUT was placed upon a non-metallic table 0.8m above the ground reference plane. And for floor-standing arrangement, the EUT was placed on the horizontal ground reference plane,
- 4) The test was performed with a vertical ground reference plane. The rear of the EUT shall be 0.4 m from the vertical ground reference plane. The vertical ground reference plane was bonded to the horizontal ground reference plane. The LISN 1 was placed 0.8 m from the boundary of the unit under test and bonded to a ground reference plane for LISNs mounted on top of the ground reference plane. This distance was between the closest points of the LISN 1 and the EUT. All other units of the EUT and associated equipment was at least 0.8 m from the LISN 2.
- 5) In order to find the maximum emission, the relative positions of equipment and all of the interface cables must be changed according to ANSI C63.10 on conducted measurement.

Remark: Level=Read Level+ Cable Loss+ LISN Factor



Unless otherwise agreed in writing, this document is issued by the Company subject to its General Conditions of Service printed overleaf, available on request or accessible at <http://www.sgs.com/en/Terms-and-Conditions.aspx> and, for electronic format documents, subject to Terms and Conditions for Electronic Documents at <http://www.sgs.com/en/Terms-and-Conditions/Terms-e-Documents.aspx>. Attention is drawn to the limitation of liability, indemnification and jurisdiction issues defined therein. Any holder of this document is advised that information contained hereon reflects the Company's findings at the time of its intervention only and within the limits of Client's instructions, if any. The Company's sole responsibility is to its Client and this document does not exonerate parties to a transaction from exercising all their rights and obligations under the transaction documents. This document cannot be reproduced except in full, without prior written approval of the Company. Any unauthorized alteration, forgery or falsification of the content or appearance of this document is unlawful and offenders may be prosecuted to the fullest extent of the law. Unless otherwise stated the results shown in this test report refer only to the sample(s) tested and such sample(s) are retained for 30 days only.  
**Attention: To check the authenticity of testing / inspection report & certificate, please contact us at telephone: (86-755) 8307 1443, or email: CN.Doccheck@sgs.com**

No.10, Weiye Road, Innovation Park, Kunshan, Jiangsu, China 215300  
中国·江苏·昆山市留学生创业园伟业路10号 邮编 215300

t(86-512)57355888 f(86-512)57370818 www.sgsgroup.com.cn  
t(86-512)57355888 f(86-512)57370818 sgs.china@sgs.com



Test Mode: 01; Line: Live line

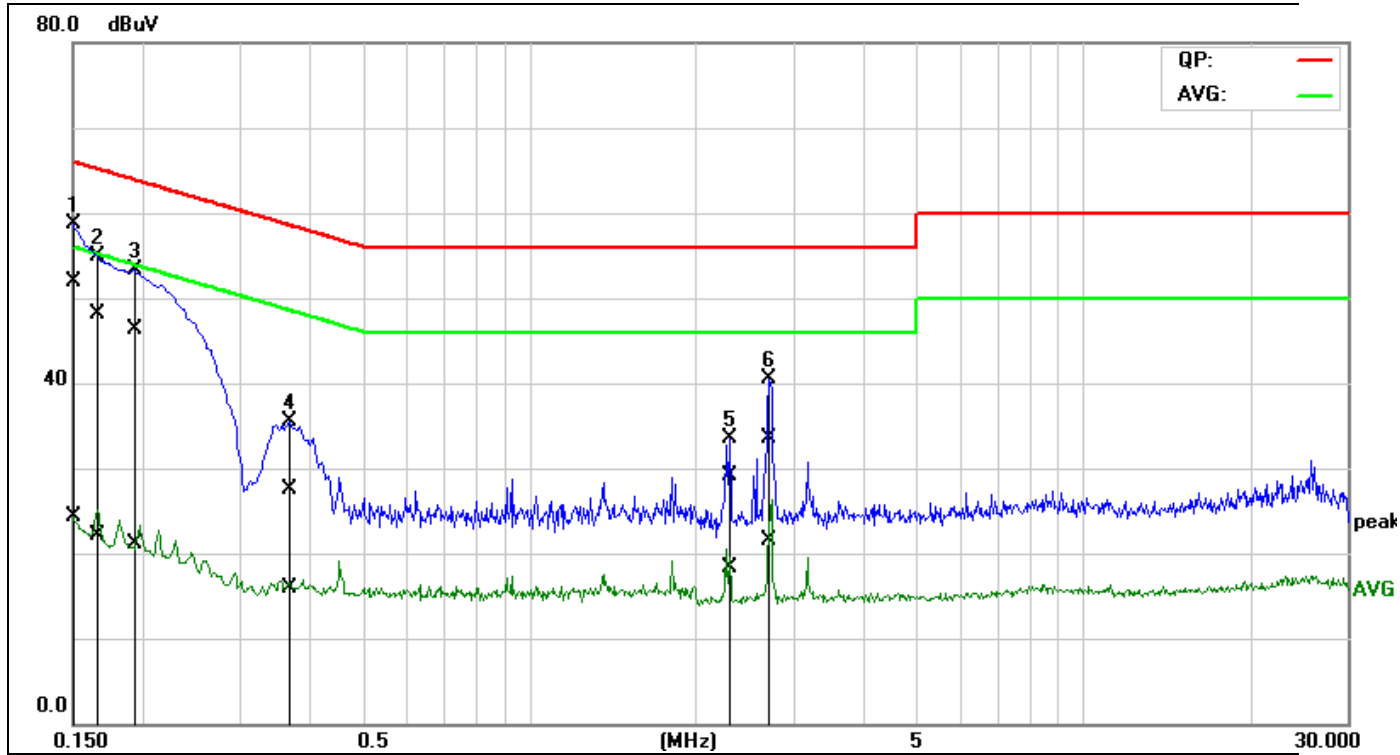

No.	Frequency (MHz)	QuasiPeak reading (dBuV)	Average reading (dBuV)	Correction factor (dB)	QuasiPeak result (dBuV)	Average result (dBuV)	QuasiPeak limit (dBuV)	Average limit (dBuV)	QuasiPeak margin (dB)	Average margin (dB)	Remark
1*	0.1500	32.44	4.89	19.50	51.94	24.39	65.99	56.00	-14.05	-31.61	Pass
2	0.1675	28.54	2.58	19.50	48.04	22.08	65.08	55.08	-17.04	-33.00	Pass
3	0.1910	26.72	1.55	19.50	46.22	21.05	63.99	53.99	-17.77	-32.94	Pass
4	0.3673	8.07	-3.68	19.53	27.60	15.85	58.56	48.56	-30.96	-32.71	Pass
5	2.2702	9.35	-1.29	19.67	29.02	18.38	56.00	46.00	-26.98	-27.62	Pass
6	2.7180	13.78	1.89	19.69	33.47	21.58	56.00	46.00	-22.53	-24.42	Pass



Unless otherwise agreed in writing, this document is issued by the Company subject to its General Conditions of Service printed overleaf, available on request or accessible at <http://www.sgs.com/en/Terms-and-Conditions.aspx> and, for electronic format documents, subject to Terms and Conditions for Electronic Documents at <http://www.sgs.com/en/Terms-and-Conditions/Terms-e-Documents.aspx>. Attention is drawn to the limitation of liability, indemnification and jurisdiction issues defined therein. Any holder of this document is advised that information contained hereon reflects the Company's findings at the time of its intervention only and within the limits of Client's instructions, if any. The Company's sole responsibility is to its Client and this document does not exonerate parties to a transaction from exercising all their rights and obligations under the transaction documents. This document cannot be reproduced except in full, without prior written approval of the Company. Any unauthorized alteration, forgery or falsification of the content or appearance of this document is unlawful and offenders may be prosecuted to the fullest extent of the law. Unless otherwise stated the results shown in this test report refer only to the sample(s) tested and such sample(s) are retained for 30 days only.  
Attention: To check the authenticity of testing / inspection report & certificate, please contact us at telephone: (86-755) 8307 1443, or email: [CN.Doccheck@sgs.com](mailto:CN.Doccheck@sgs.com)

No.10, Weiye Road, Innovation Park, Kunshan, Jiangsu, China 215300  
中国·江苏·昆山市留学生创业园伟业路10号 邮编 215300

t(86-512)57355888 f(86-512)57370818 www.sgsgroup.com.cn  
t(86-512)57355888 f(86-512)57370818 sgs.china@sgs.com

Test Mode: 01; Line: Neutral Line

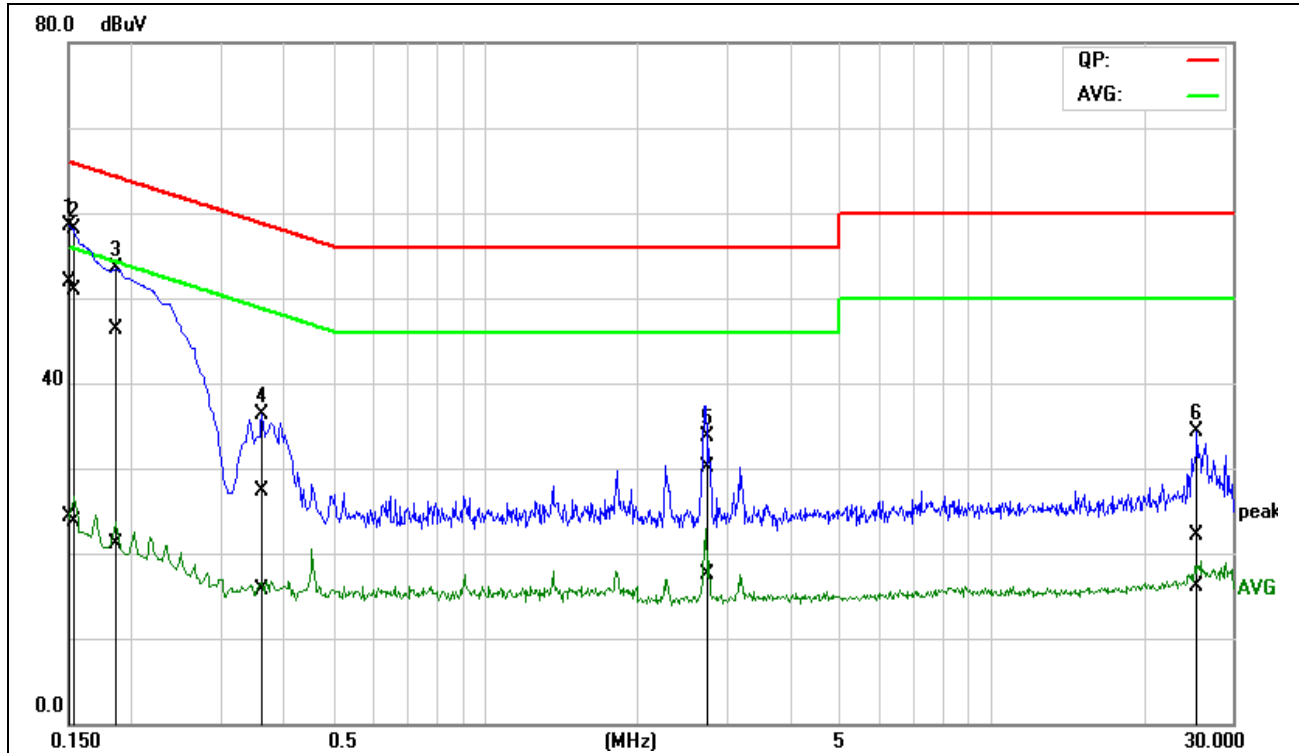

No.	Frequency (MHz)	QuasiPeak reading (dBuV)	Average reading (dBuV)	Correction factor (dB)	QuasiPeak result (dBuV)	Average result (dBuV)	QuasiPeak limit (dBuV)	Average limit (dBuV)	QuasiPeak margin (dB)	Average margin (dB)	Remark
1*	0.1500	32.49	4.91	19.48	51.97	24.39	66.00	56.00	-14.03	-31.61	Pass
2	0.1542	31.33	4.27	19.48	50.81	23.75	65.77	55.77	-14.96	-32.02	Pass
3	0.1854	26.88	1.68	19.49	46.37	21.17	64.24	54.24	-17.87	-33.07	Pass
4	0.3610	7.78	-3.72	19.52	27.30	15.80	58.71	48.71	-31.41	-32.91	Pass
5	2.7519	10.49	-2.14	19.70	30.19	17.56	56.00	46.00	-25.81	-28.44	Pass
6	25.5474	1.86	-4.09	20.27	22.13	16.18	60.00	50.00	-37.87	-33.82	Pass



Unless otherwise agreed in writing, this document is issued by the Company subject to its General Conditions of Service printed overleaf, available on request or accessible at <http://www.sgs.com/en/Terms-and-Conditions.aspx> and, for electronic format documents, subject to Terms and Conditions for Electronic Documents at <http://www.sgs.com/en/Terms-and-Conditions/Terms-e-Documents.aspx>. Attention is drawn to the limitation of liability, indemnification and jurisdiction issues defined therein. Any holder of this document is advised that information contained hereon reflects the Company's findings at the time of its intervention only and within the limits of Client's instructions, if any. The Company's sole responsibility is to its Client and this document does not exonerate parties to a transaction from exercising all their rights and obligations under the transaction documents. This document cannot be reproduced except in full, without prior written approval of the Company. Any unauthorized alteration, forgery or falsification of the content or appearance of this document is unlawful and offenders may be prosecuted to the fullest extent of the law. Unless otherwise stated the results shown in this test report refer only to the sample(s) tested and such sample(s) are retained for 30 days only.  
**Attention: To check the authenticity of testing / inspection report & certificate, please contact us at telephone: (86-755) 8307 1443, or email: CN.Doccheck@sgs.com**

No.10, Weiye Road, Innovation Park, Kunshan, Jiangsu, China 215300  
 中国·江苏·昆山市留学生创业园伟业路10号 邮编 215300

t(86-512)57355888 f(86-512)57370818 www.sgsgroup.com.cn  
 t(86-512)57355888 f(86-512)57370818 sgs.china@sgs.com

**7.2 Duty Cycle**

Test Requirement KDB 789033 D02 II B 1  
 Test Method: KDB 789033 II B 1

**7.2.1 E.U.T. Operation**

Operating Environment:  
 Temperature: 34.3 °C Humidity: 39.7 % RH Atmospheric Pressure: 1010 mbar

**7.2.2 Test Mode Description**

Pre-scan / Final test	Mode Code	Description
Final test	01	Charge + TX mode (U-NII-1)_Keep the EUT in charging and continuously transmitting mode with all modulation types. All data rates for each modulation type have been tested and found the data rate @ 6Mbps is the worst case of IEEE 802.11a; data rate @ MCS0 is the worst case of IEEE 802.11n(HT20); data rate @ MCS0 is the worst case of IEEE 802.11n(HT40); data rate @ MCS0 is the worst case of IEEE 802.11ac(VHT20); data rate @ MCS0 is the worst case of IEEE 802.11ac(VHT40); data rate @ MCS0 is the worst case of IEEE 802.11ac(VHT80), Only the data of worst case is recorded in the report.
Final test	02	Charge + TX mode (U-NII-2A)_Keep the EUT in charging and continuously transmitting mode with all modulation types. All data rates for each modulation type have been tested and found the data rate @ 6Mbps is the worst case of IEEE 802.11a; data rate @ MCS0 is the worst case of IEEE 802.11n(HT20); data rate @ MCS0 is the worst case of IEEE 802.11n(HT40); data rate @ MCS0 is the worst case of IEEE 802.11ac(VHT20); data rate @ MCS0 is the worst case of IEEE 802.11ac(VHT40); data rate @ MCS0 is the worst case of IEEE 802.11ac(VHT80), final test modes are considering the modulation and worst data rates. Only the data of worst case is recorded in the report.
Final test	03	Charge + TX mode (U-NII-2C)_Keep the EUT in charging and continuously transmitting mode with all modulation types. All data rates for each modulation type have been tested and found the data rate @ 6Mbps is the worst case of IEEE 802.11a; data rate @ MCS0 is the worst case of IEEE 802.11n(HT20); data rate @ MCS0 is the worst case of IEEE 802.11n(HT40); data rate @ MCS0 is the worst case of IEEE 802.11ac(VHT20); data rate @ MCS0 is the worst case of IEEE 802.11ac(VHT40); data rate @ MCS0 is the worst case of IEEE 802.11ac(VHT80), Only the data of worst case is recorded in the report.
Final test	04	Charge + TX mode (U-NII-3)_Keep the EUT in charging and continuously transmitting mode with all modulation types. All data rates for each modulation type have been tested and found the data rate @ 6Mbps is the worst case of IEEE 802.11a; data rate @ MCS0 is the worst case of IEEE 802.11n(HT20); data rate @ MCS0 is the worst case of IEEE 802.11n(HT40); data rate @ MCS0 is the worst case of IEEE 802.11ac(VHT20); data rate @ MCS0 is the worst case of IEEE 802.11ac(VHT40); data rate @ MCS0 is the worst case of IEEE 802.11ac(VHT80), data rates. Only the data of worst case is recorded in the report.



Unless otherwise agreed in writing, this document is issued by the Company subject to its General Conditions of Service printed overleaf, available on request or accessible at <http://www.sgs.com/en/Terms-and-Conditions.aspx> and, for electronic format documents, subject to Terms and Conditions for Electronic Documents at <http://www.sgs.com/en/Terms-and-Conditions/Terms-e-Documents.aspx>. Attention is drawn to the limitation of liability, indemnification and jurisdiction issues defined therein. Any holder of this document is advised that information contained hereon reflects the Company's findings at the time of its intervention only and within the limits of Client's instructions, if any. The Company's sole responsibility is to its Client and this document does not exonerate parties to a transaction from exercising all their rights and obligations under the transaction documents. This document cannot be reproduced except in full, without prior written approval of the Company. Any unauthorized alteration, forgery or falsification of the content or appearance of this document is unlawful and offenders may be prosecuted to the fullest extent of the law. Unless otherwise stated the results shown in this test report refer only to the sample(s) tested and such sample(s) are retained for 30 days only.  
**Attention: To check the authenticity of testing /inspection report & certificate, please contact us at telephone: (86-755) 8307 1443, or email: CN.Doccheck@sgs.com**

No.10, Weiye Road, Innovation Park, Kunshan, Jiangsu, China 215300 t(86-512)57355888 f(86-512)57370818 www.sgsgroup.com.cn  
 中国·江苏·昆山市留学生创业园伟业路10号 邮编 215300 t(86-512)57355888 f(86-512)57370818 sgs.china@sgs.com

### 7.2.3 Test Setup Diagram

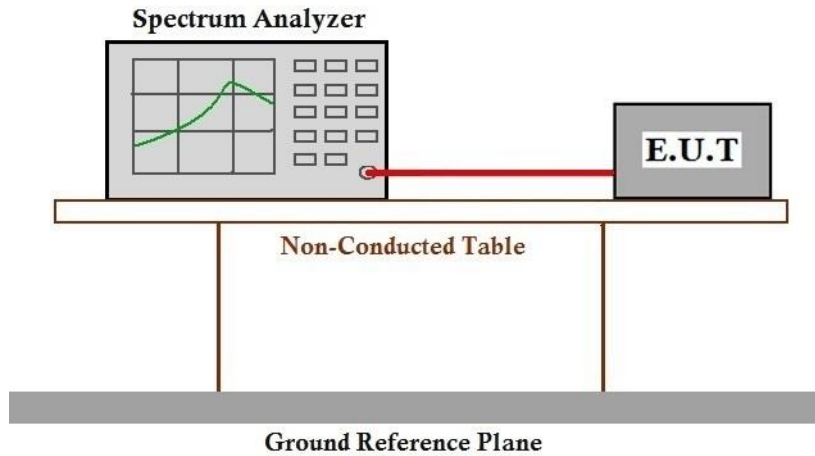

### 7.2.4 Measurement Procedure and Data

Please Refer to Appendix for Details



Unless otherwise agreed in writing, this document is issued by the Company subject to its General Conditions of Service printed overleaf, available on request or accessible at <http://www.sgs.com/en/Terms-and-Conditions.aspx> and, for electronic format documents, subject to Terms and Conditions for Electronic Documents at <http://www.sgs.com/en/Terms-and-Conditions/Terms-e-Documents.aspx>. Attention is drawn to the limitation of liability, indemnification and jurisdiction issues defined therein. Any holder of this document is advised that information contained hereon reflects the Company's findings at the time of its intervention only and within the limits of Client's instructions, if any. The Company's sole responsibility is to its Client and this document does not exonerate parties to a transaction from exercising all their rights and obligations under the transaction documents. This document cannot be reproduced except in full, without prior written approval of the Company. Any unauthorized alteration, forgery or falsification of the content or appearance of this document is unlawful and offenders may be prosecuted to the fullest extent of the law. Unless otherwise stated the results shown in this test report refer only to the sample(s) tested and such sample(s) are retained for 30 days only.  
**Attention: To check the authenticity of testing / inspection report & certificate, please contact us at telephone: (86-755) 8307 1443, or email: CN\_Doccheck@sgs.com**

No.10, Weiye Road, Innovation Park, Kunshan, Jiangsu, China 215300  
 中国·江苏·昆山市留学生创业园伟业路10号 邮编 215300

t(86-512)57355888 f(86-512)57370818 www.sgs.com.cn  
 t(86-512)57355888 f(86-512)57370818 sgs.china@sgs.com



**7.3 99% Bandwidth**

Test Requirement N/A  
 Test Method: KDB 789033 II D

**7.3.1 E.U.T. Operation**

Operating Environment:  
 Temperature: 34.3 °C Humidity: 39.7 % RH Atmospheric Pressure: 1010 mbar

**7.3.2 Test Mode Description**

Pre-scan / Final test	Mode Code	Description
Final test	01	Charge + TX mode (U-NII-1)_Keep the EUT in charging and continuously transmitting mode with all modulation types. All data rates for each modulation type have been tested and found the data rate @ 6Mbps is the worst case of IEEE 802.11a; data rate @ MCS0 is the worst case of IEEE 802.11n(HT20); data rate @ MCS0 is the worst case of IEEE 802.11n(HT40); data rate @ MCS0 is the worst case of IEEE 802.11ac(VHT20); data rate @ MCS0 is the worst case of IEEE 802.11ac(VHT40); data rate @ MCS0 is the worst case of IEEE 802.11ac(VHT80), Only the data of worst case is recorded in the report.
Final test	02	Charge + TX mode (U-NII-2A)_Keep the EUT in charging and continuously transmitting mode with all modulation types. All data rates for each modulation type have been tested and found the data rate @ 6Mbps is the worst case of IEEE 802.11a; data rate @ MCS0 is the worst case of IEEE 802.11n(HT20); data rate @ MCS0 is the worst case of IEEE 802.11n(HT40); data rate @ MCS0 is the worst case of IEEE 802.11ac(VHT20); data rate @ MCS0 is the worst case of IEEE 802.11ac(VHT40); data rate @ MCS0 is the worst case of IEEE 802.11ac(VHT80), final test modes are considering the modulation and worse data rates. Only the data of worst case is recorded in the report.
Final test	03	Charge + TX mode (U-NII-2C)_Keep the EUT in charging and continuously transmitting mode with all modulation types. All data rates for each modulation type have been tested and found the data rate @ 6Mbps is the worst case of IEEE 802.11a; data rate @ MCS0 is the worst case of IEEE 802.11n(HT20); data rate @ MCS0 is the worst case of IEEE 802.11n(HT40); data rate @ MCS0 is the worst case of IEEE 802.11ac(VHT20); data rate @ MCS0 is the worst case of IEEE 802.11ac(VHT40); data rate @ MCS0 is the worst case of IEEE 802.11ac(VHT80), Only the data of worst case is recorded in the report.
Final test	04	Charge + TX mode (U-NII-3)_Keep the EUT in charging and continuously transmitting mode with all modulation types. All data rates for each modulation type have been tested and found the data rate @ 6Mbps is the worst case of IEEE 802.11a; data rate @ MCS0 is the worst case of IEEE 802.11n(HT20); data rate @ MCS0 is the worst case of IEEE 802.11n(HT40); data rate @ MCS0 is the worst case of IEEE 802.11ac(VHT20); data rate @ MCS0 is the worst case of IEEE 802.11ac(VHT40); data rate @ MCS0 is the worst case of IEEE 802.11ac(VHT80), data rates. Only the data of worst case is recorded in the report.



Unless otherwise agreed in writing, this document is issued by the Company subject to its General Conditions of Service printed overleaf, available on request or accessible at <http://www.sgs.com/en/Terms-and-Conditions.aspx> and, for electronic format documents, subject to Terms and Conditions for Electronic Documents at <http://www.sgs.com/en/Terms-and-Conditions/Terms-e-Documents.aspx>. Attention is drawn to the limitation of liability, indemnification and jurisdiction issues defined therein. Any holder of this document is advised that information contained hereon reflects the Company's findings at the time of its intervention only and within the limits of Client's instructions, if any. The Company's sole responsibility is to its Client and this document does not exonerate parties to a transaction from exercising all their rights and obligations under the transaction documents. This document cannot be reproduced except in full, without prior written approval of the Company. Any unauthorized alteration, forgery or falsification of the content or appearance of this document is unlawful and offenders may be prosecuted to the fullest extent of the law. Unless otherwise stated the results shown in this test report refer only to the sample(s) tested and such sample(s) are retained for 30 days only.  
**Attention: To check the authenticity of testing /inspection report & certificate, please contact us at telephone: (86-755) 8307 1443, or email: CN.Doccheck@sgs.com**  
 No.10, Weiye Road, Innovation Park, Kunshan, Jiangsu, China 215300 t(86-512)57355888 f(86-512)57370818 www.sgsgroup.com.cn  
 中国·江苏·昆山市留学生创业园伟业路10号 邮编 215300 t(86-512)57355888 f(86-512)57370818 sgs.china@sgs.com

### 7.3.3 Test Setup Diagram

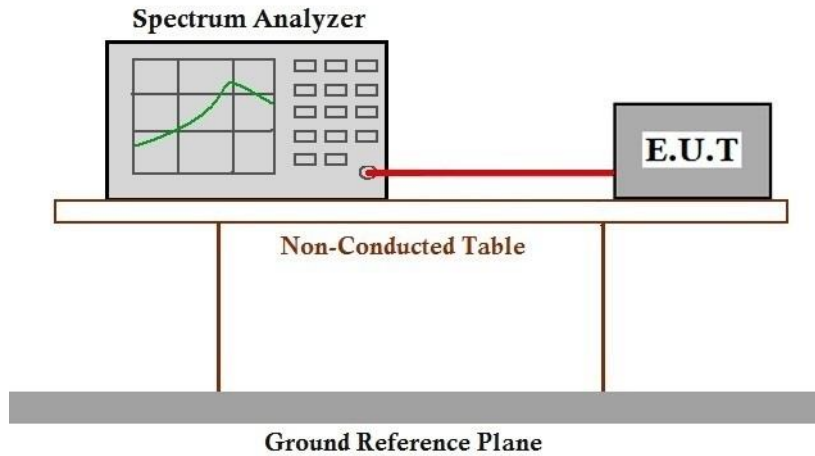

### 7.3.4 Measurement Procedure and Data

Please Refer to Appendix for Details



Unless otherwise agreed in writing, this document is issued by the Company subject to its General Conditions of Service printed overleaf, available on request or accessible at <http://www.sgs.com/en/Terms-and-Conditions.aspx> and, for electronic format documents, subject to Terms and Conditions for Electronic Documents at <http://www.sgs.com/en/Terms-and-Conditions/Terms-e-Documents.aspx>. Attention is drawn to the limitation of liability, indemnification and jurisdiction issues defined therein. Any holder of this document is advised that information contained hereon reflects the Company's findings at the time of its intervention only and within the limits of Client's instructions, if any. The Company's sole responsibility is to its Client and this document does not exonerate parties to a transaction from exercising all their rights and obligations under the transaction documents. This document cannot be reproduced except in full, without prior written approval of the Company. Any unauthorized alteration, forgery or falsification of the content or appearance of this document is unlawful and offenders may be prosecuted to the fullest extent of the law. Unless otherwise stated the results shown in this test report refer only to the sample(s) tested and such sample(s) are retained for 30 days only.  
**Attention: To check the authenticity of testing / inspection report & certificate, please contact us at telephone: (86-755) 8307 1443, or email: CN\_Doccheck@sgs.com**

No.10, Weiye Road, Innovation Park, Kunshan, Jiangsu, China 215300  
 中国·江苏·昆山市留学生创业园伟业路10号 邮编 215300

t(86-512)57355888 f(86-512)57370818 www.sgsgroup.com.cn  
 t(86-512)57355888 f(86-512)57370818 sgs.china@sgs.com

**7.4 26dB Emission bandwidth**

Test Requirement 47 CFR Part 15, Subpart E 15.407 (a)

Test Method: KDB 789033 D02 II C 1

**7.4.1 E.U.T. Operation**

Operating Environment:

Temperature: 34.3 °C Humidity: 39.7 % RH Atmospheric Pressure: 1010 mbar

**7.4.2 Test Mode Description**

Pre-scan / Final test	Mode Code	Description
Final test	01	Charge + TX mode (U-NII-1)_Keep the EUT in charging and continuously transmitting mode with all modulation types. All data rates for each modulation type have been tested and found the data rate @ 6Mbps is the worst case of IEEE 802.11a; data rate @ MCS0 is the worst case of IEEE 802.11n(HT20); data rate @ MCS0 is the worst case of IEEE 802.11n(HT40); data rate @ MCS0 is the worst case of IEEE 802.11ac(VHT20); data rate @ MCS0 is the worst case of IEEE 802.11ac(VHT40); data rate @ MCS0 is the worst case of IEEE 802.11ac(VHT80), Only the data of worst case is recorded in the report.
Final test	02	Charge + TX mode (U-NII-2A)_Keep the EUT in charging and continuously transmitting mode with all modulation types. All data rates for each modulation type have been tested and found the data rate @ 6Mbps is the worst case of IEEE 802.11a; data rate @ MCS0 is the worst case of IEEE 802.11n(HT20); data rate @ MCS0 is the worst case of IEEE 802.11n(HT40); data rate @ MCS0 is the worst case of IEEE 802.11ac(VHT20); data rate @ MCS0 is the worst case of IEEE 802.11ac(VHT40); data rate @ MCS0 is the worst case of IEEE 802.11ac(VHT80), final test modes are considering the modulation and worse data rates. Only the data of worst case is recorded in the report.
Final test	03	Charge + TX mode (U-NII-2C)_Keep the EUT in charging and continuously transmitting mode with all modulation types. All data rates for each modulation type have been tested and found the data rate @ 6Mbps is the worst case of IEEE 802.11a; data rate @ MCS0 is the worst case of IEEE 802.11n(HT20); data rate @ MCS0 is the worst case of IEEE 802.11n(HT40); data rate @ MCS0 is the worst case of IEEE 802.11ac(VHT20); data rate @ MCS0 is the worst case of IEEE 802.11ac(VHT40); data rate @ MCS0 is the worst case of IEEE 802.11ac(VHT80), Only the data of worst case is recorded in the report.



Unless otherwise agreed in writing, this document is issued by the Company subject to its General Conditions of Service printed overleaf, available on request or accessible at <http://www.sgs.com/en/Terms-and-Conditions.aspx> and, for electronic format documents, subject to Terms and Conditions for Electronic Documents at <http://www.sgs.com/en/Terms-and-Conditions/Terms-e-Documents.aspx>. Attention is drawn to the limitation of liability, indemnification and jurisdiction issues defined therein. Any holder of this document is advised that information contained hereon reflects the Company's findings at the time of its intervention only and within the limits of Client's instructions, if any. The Company's sole responsibility is to its Client and this document does not exonerate parties to a transaction from exercising all their rights and obligations under the transaction documents. This document cannot be reproduced except in full, without prior written approval of the Company. Any unauthorized alteration, forgery or falsification of the content or appearance of this document is unlawful and offenders may be prosecuted to the fullest extent of the law. Unless otherwise stated the results shown in this test report refer only to the sample(s) tested and such sample(s) are retained for 30 days only.  
**Attention: To check the authenticity of testing /inspection report & certificate, please contact us at telephone: (86-755) 8307 1443, or email: CN.Doccheck@sgs.com**

No.10, Weiye Road, Innovation Park, Kunshan, Jiangsu, China 215300  
 中国·江苏·昆山市留学院创业园伟业路10号 邮编 215300

t(86-512)57355888 f(86-512)57370818 www.sgsgroup.com.cn  
 t(86-512)57355888 f(86-512)57370818 sgs.china@sgs.com

### 7.4.3 Test Setup Diagram

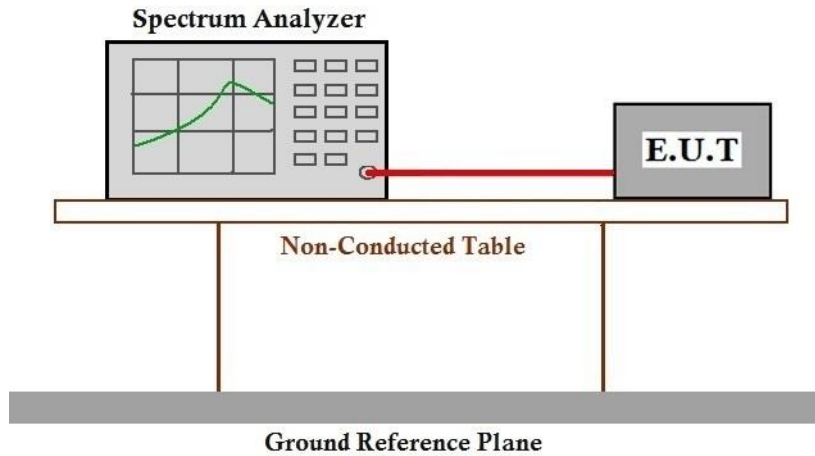

### 7.4.4 Measurement Procedure and Data

Please Refer to Appendix for Details



Unless otherwise agreed in writing, this document is issued by the Company subject to its General Conditions of Service printed overleaf, available on request or accessible at <http://www.sgs.com/en/Terms-and-Conditions.aspx> and, for electronic format documents, subject to Terms and Conditions for Electronic Documents at <http://www.sgs.com/en/Terms-and-Conditions/Terms-e-Documents.aspx>. Attention is drawn to the limitation of liability, indemnification and jurisdiction issues defined therein. Any holder of this document is advised that information contained hereon reflects the Company's findings at the time of its intervention only and within the limits of Client's instructions, if any. The Company's sole responsibility is to its Client and this document does not exonerate parties to a transaction from exercising all their rights and obligations under the transaction documents. This document cannot be reproduced except in full, without prior written approval of the Company. Any unauthorized alteration, forgery or falsification of the content or appearance of this document is unlawful and offenders may be prosecuted to the fullest extent of the law. Unless otherwise stated the results shown in this test report refer only to the sample(s) tested and such sample(s) are retained for 30 days only.

**Attention: To check the authenticity of testing / inspection report & certificate, please contact us at telephone: (86-755) 8307 1443, or email: CN\_Doccheck@sgs.com**

No.10, Weiye Road, Innovation Park, Kunshan, Jiangsu, China 215300  
 中国·江苏·昆山市留学生创业园伟业路10号 邮编 215300

t(86-512)57355888 f(86-512)57370818 www.sgsgroup.com.cn  
 t(86-512)57355888 f(86-512)57370818 sgs.china@sgs.com



### 7.5 Minimum 6 dB bandwidth (5.725-5.85 GHz band )

Test Requirement 47 CFR Part 15, Subpart E 15.407 (e)

Test Method: KDB 789033 D02 II C 2

Limit:

Frequency band(MHz)	Limit
5725-5850	≥500 kHz

#### 7.5.1 E.U.T. Operation

Operating Environment:

Temperature: 34.3 °C Humidity: 39.7 % RH Atmospheric Pressure: 1010 mbar

#### 7.5.2 Test Mode Description

Pre-scan / Final test	Mode Code	Description
Final test	04	Charge + TX mode (U-NII-3)_Keep the EUT in charging and continuously transmitting mode with all modulation types. All data rates for each modulation type have been tested and found the data rate @ 6Mbps is the worst case of IEEE 802.11a; data rate @ MCS0 is the worst case of IEEE 802.11n(HT20); data rate @ MCS0 is the worst case of IEEE 802.11n(HT40); data rate @ MCS0 is the worst case of IEEE 802.11ac(VHT20); data rate @ MCS0 is the worst case of IEEE 802.11ac(VHT40); data rate @ MCS0 is the worst case of IEEE 802.11ac(VHT80), Only the data of worst case is recorded in the report.

#### 7.5.3 Test Setup Diagram

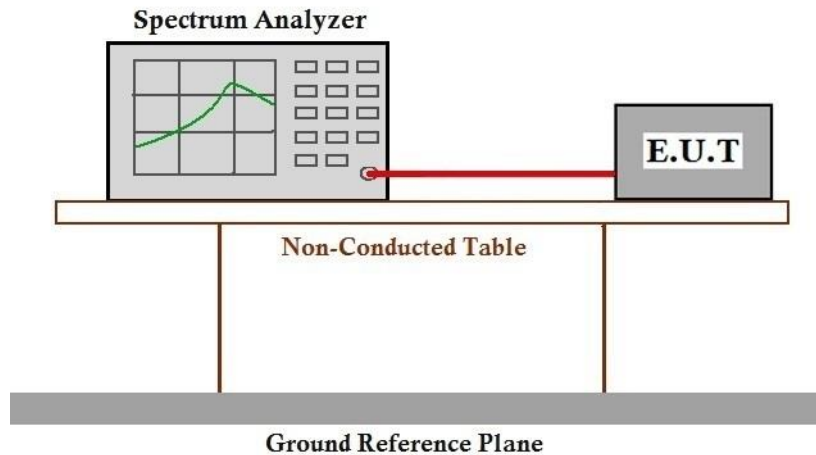

Unless otherwise agreed in writing, this document is issued by the Company subject to its General Conditions of Service printed overleaf, available on request or accessible at <http://www.sgs.com/en/Terms-and-Conditions.aspx> and, for electronic format documents, subject to Terms and Conditions for Electronic Documents at <http://www.sgs.com/en/Terms-and-Conditions/Terms-e-Documents.aspx>. Attention is drawn to the limitation of liability, indemnification and jurisdiction issues defined therein. Any holder of this document is advised that information contained hereon reflects the Company's findings at the time of its intervention only and within the limits of Client's instructions, if any. The Company's sole responsibility is to its Client and this document does not exonerate parties to a transaction from exercising all their rights and obligations under the transaction documents. This document cannot be reproduced except in full, without prior written approval of the Company. Any unauthorized alteration, forgery or falsification of the content or appearance of this document is unlawful and offenders may be prosecuted to the fullest extent of the law. Unless otherwise stated the results shown in this test report refer only to the sample(s) tested and such sample(s) are retained for 30 days only.  
**Attention: To check the authenticity of testing /inspection report & certificate, please contact us at telephone: (86-755) 8307 1443, or email: CN.Doccheck@sgs.com**

No.10, Weiye Road, Innovation Park, Kunshan, Jiangsu, China 215300  
中国·江苏·昆山市留学生创业园伟业路10号 邮编 215300

t(86-512)57355888 f(86-512)57370818 www.sgs.com.cn  
t(86-512)57355888 f(86-512)57370818 sgs.china@sgs.com

## Compliance Certification Services (Kunshan) Inc.

Report No.: KSCR221000189002

Page: 26 of 607

### 7.5.4 Measurement Procedure and Data

Please Refer to Appendix for Details



Unless otherwise agreed in writing, this document is issued by the Company subject to its General Conditions of Service printed overleaf, available on request or accessible at <http://www.sgs.com/en/Terms-and-Conditions.aspx> and, for electronic format documents, subject to Terms and Conditions for Electronic Documents at <http://www.sgs.com/en/Terms-and-Conditions/Terms-e-Documents.aspx>. Attention is drawn to the limitation of liability, indemnification and jurisdiction issues defined therein. Any holder of this document is advised that information contained hereon reflects the Company's findings at the time of its intervention only and within the limits of Client's instructions, if any. The Company's sole responsibility is to its Client and this document does not exonerate parties to a transaction from exercising all their rights and obligations under the transaction documents. This document cannot be reproduced except in full, without prior written approval of the Company. Any unauthorized alteration, forgery or falsification of the content or appearance of this document is unlawful and offenders may be prosecuted to the fullest extent of the law. Unless otherwise stated the results shown in this test report refer only to the sample(s) tested and such sample(s) are retained for 30 days only.  
**Attention: To check the authenticity of testing / inspection report & certificate, please contact us at telephone: (86-755) 8307 1443, or email: CN.Doccheck@sgs.com**

No.10, Weiye Road, Innovation Park, Kunshan, Jiangsu, China 215300  
中国·江苏·昆山市留学生创业园伟业路10号 邮编 215300

t(86-512)57355888 f(86-512)57370818 www.sgs.com.cn  
t(86-512)57355888 f(86-512)57370818 sgs.china@sgs.com

**7.6 Maximum Conducted output power**

Test Requirement 47 CFR Part 15, Subpart E 15.407 (a)

Test Method: KDB 789033 D02 II E

Limit:

Frequency band(MHz)	Limit
5150-5250	≤1W(30dBm) for master device
	≤250mW(24dBm) for client device
5250-5350	≤250mW(24dBm) for client device or 11dBm+10logB*
5470-5725	≤250mW(24dBm) for client device or 11dBm+10logB*
5725-5850	≤1W(30dBm)
Remark:	* Where B is the 26dB emission bandwidth in MHz. The maximum conducted output power must be measured over any interval of continuous transmission using instrumentation calibrated in terms of an rms-equivalent voltage.

**7.6.1 E.U.T. Operation**

Operating Environment:

Temperature: 34.3 °C Humidity: 39.6 % RH Atmospheric Pressure: 1010 mbar

**7.6.2 Test Mode Description**

Pre-scan / Final test	Mode Code	Description
Final test	01	Charge + TX mode (U-NII-1)_Keep the EUT in charging and continuously transmitting mode with all modulation types. All data rates for each modulation type have been tested and found the data rate @ 6Mbps is the worst case of IEEE 802.11a; data rate @ MCS0 is the worst case of IEEE 802.11n(HT20); data rate @ MCS0 is the worst case of IEEE 802.11n(HT40); data rate @ MCS0 is the worst case of IEEE 802.11ac(VHT20); data rate @ MCS0 is the worst case of IEEE 802.11ac(VHT40); data rate @ MCS0 is the worst case of IEEE 802.11ac(VHT80), Only the data of worst case is recorded in the report.
Final test	02	Charge + TX mode (U-NII-2A)_Keep the EUT in charging and continuously transmitting mode with all modulation types. All data rates for each modulation type have been tested and found the data rate @ 6Mbps is the worst case of IEEE 802.11a; data rate @ MCS0 is the worst case of IEEE 802.11n(HT20); data rate @ MCS0 is the worst case of IEEE 802.11n(HT40); data rate @ MCS0 is the worst case of IEEE 802.11ac(VHT20); data rate @ MCS0 is the worst case of IEEE 802.11ac(VHT40); data rate @ MCS0 is the worst case of IEEE 802.11ac(VHT80), final test modes are considering the modulation and worse data rates. Only the data



Unless otherwise agreed in writing, this document is issued by the Company subject to its General Conditions of Service printed overleaf, available on request or accessible at <http://www.sgs.com/en/Terms-and-Conditions.aspx> and, for electronic format documents, subject to Terms and Conditions for Electronic Documents at <http://www.sgs.com/en/Terms-and-Conditions/Terms-e-Documents.aspx>. Attention is drawn to the limitation of liability, indemnification and jurisdiction issues defined therein. Any holder of this document is advised that information contained hereon reflects the Company's findings at the time of its intervention only and within the limits of Client's instructions, if any. The Company's sole responsibility is to its Client and this document does not exonerate parties to a transaction from exercising all their rights and obligations under the transaction documents. This document cannot be reproduced except in full, without prior written approval of the Company. Any unauthorized alteration, forgery or falsification of the content or appearance of this document is unlawful and offenders may be prosecuted to the fullest extent of the law. Unless otherwise stated the results shown in this test report refer only to the sample(s) tested and such sample(s) are retained for 30 days only.  
Attention: To check the authenticity of testing /inspection report & certificate, please contact us at telephone: (86-755) 8307 1443, or email: CN.Doccheck@sgs.com

No.10, Weiye Road, Innovation Park, Kunshan, Jiangsu, China 215300  
中国·江苏·昆山市留学院创业园伟业路10号 邮编 215300

t(86-512)57355888 f(86-512)57370818 www.sgs.com.cn  
t(86-512)57355888 f(86-512)57370818 sgs.china@sgs.com

		of worst case is recorded in the report.
Final test	03	Charge + TX mode (U-NII-2C)_Keep the EUT in charging and continuously transmitting mode with all modulation types. All data rates for each modulation type have been tested and found the data rate @ 6Mbps is the worst case of IEEE 802.11a; data rate @ MCS0 is the worst case of IEEE 802.11n(HT20); data rate @ MCS0 is the worst case of IEEE 802.11n(HT40); data rate @ MCS0 is the worst case of IEEE 802.11ac(VHT20); data rate @ MCS0 is the worst case of IEEE 802.11ac(VHT40); data rate @ MCS0 is the worst case of IEEE 802.11ac(VHT80), Only the data of worst case is recorded in the report.
Final test	04	Charge + TX mode (U-NII-3)_Keep the EUT in charging and continuously transmitting mode with all modulation types. All data rates for each modulation type have been tested and found the data rate @ 6Mbps is the worst case of IEEE 802.11a; data rate @ MCS0 is the worst case of IEEE 802.11n(HT20); data rate @ MCS0 is the worst case of IEEE 802.11n(HT40); data rate @ MCS0 is the worst case of IEEE 802.11ac(VHT20); data rate @ MCS0 is the worst case of IEEE 802.11ac(VHT40); data rate @ MCS0 is the worst case of IEEE 802.11ac(VHT80), Only the data of worst case is recorded in the report.

### 7.6.3 Test Setup Diagram

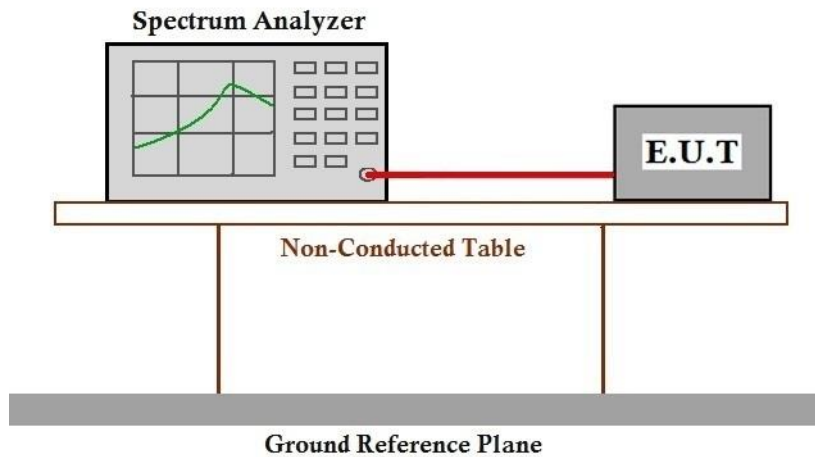

### 7.6.4 Measurement Procedure and Data

Note: Since the verify power the same operating range bandwidth and smaller power can be covered by the higher power.

Please Refer to Appendix for Details



Unless otherwise agreed in writing, this document is issued by the Company subject to its General Conditions of Service printed overleaf, available on request or accessible at <http://www.sgs.com/en/Terms-and-Conditions.aspx> and, for electronic format documents, subject to Terms and Conditions for Electronic Documents at <http://www.sgs.com/en/Terms-and-Conditions/Terms-e-Documents.aspx>. Attention is drawn to the limitation of liability, indemnification and jurisdiction issues defined therein. Any holder of this document is advised that information contained hereon reflects the Company's findings at the time of its intervention only and within the limits of Client's instructions, if any. The Company's sole responsibility is to its Client and this document does not exonerate parties to a transaction from exercising all their rights and obligations under the transaction documents. This document cannot be reproduced except in full, without prior written approval of the Company. Any unauthorized alteration, forgery or falsification of the content or appearance of this document is unlawful and offenders may be prosecuted to the fullest extent of the law. Unless otherwise stated the results shown in this test report refer only to the sample(s) tested and such sample(s) are retained for 30 days only.  
**Attention: To check the authenticity of testing /inspection report & certificate, please contact us at telephone: (86-755) 8307 1443, or email: CN.Doccheck@sgs.com**  
 No.10, Weiye Road, Innovation Park, Kunshan, Jiangsu, China 215300 t(86-512)57355888 f(86-512)57370818 www.sgsgroup.com.cn  
 中国·江苏·昆山市留学生创业园伟业路10号 邮编 215300 t(86-512)57355888 f(86-512)57370818 sgs.china@sgs.com



**7.7 Peak Power spectrum density**

Test Requirement 47 CFR Part 15, Subpart E 15.407 (a)

Test Method: KDB 789033 D02 II F

Limit:

Frequency band(MHz)	Limit
5150-5250	≤17dBm in 1MHz for master device
	≤11dBm in 1MHz for client device
5250-5350	≤11dBm in 1MHz for client device
5470-5725	≤11dBm in 1MHz for client device
5725-5850	≤30dBm in 500 kHz
Remark:	The maximum power spectral density is measured as a conducted emission by direct connection of a calibrated test instrument to the equipment under test.

**7.7.1 E.U.T. Operation**

Operating Environment:

Temperature: 34.3 °C Humidity: 39.6 % RH Atmospheric Pressure: 1010 mbar

**7.7.2 Test Mode Description**

Pre-scan / Final test	Mode Code	Description
Final test	01	Charge + TX mode (U-NII-1)_Keep the EUT in charging and continuously transmitting mode with all modulation types. All data rates for each modulation type have been tested and found the data rate @ 6Mbps is the worst case of IEEE 802.11a; data rate @ MCS0 is the worst case of IEEE 802.11n(HT20); data rate @ MCS0 is the worst case of IEEE 802.11n(HT40); data rate @ MCS0 is the worst case of IEEE 802.11ac(VHT20); data rate @ MCS0 is the worst case of IEEE 802.11ac(VHT40); data rate @ MCS0 is the worst case of IEEE 802.11ac(VHT80), Only the data of worst case is recorded in the report.
Final test	02	Charge + TX mode (U-NII-2A)_Keep the EUT in charging and continuously transmitting mode with all modulation types. All data rates for each modulation type have been tested and found the data rate @ 6Mbps is the worst case of IEEE 802.11a; data rate @ MCS0 is the worst case of IEEE 802.11n(HT20); data rate @ MCS0 is the worst case of IEEE 802.11n(HT40); data rate @ MCS0 is the worst case of IEEE 802.11ac(VHT20); data rate @ MCS0 is the worst case of IEEE 802.11ac(VHT40); data rate @ MCS0 is the worst case of IEEE 802.11ac(VHT80), final test modes are considering the modulation and worse data rates. Only the data of worst case is recorded in the report.
Final test	03	Charge + TX mode (U-NII-2C)_Keep the EUT in charging and continuously transmitting mode with all modulation types. All data rates for each modulation type have been tested and found the data rate @ 6Mbps is the worst case of IEEE



Unless otherwise agreed in writing, this document is issued by the Company subject to its General Conditions of Service printed overleaf, available on request or accessible at <http://www.sgs.com/en/Terms-and-Conditions.aspx> and, for electronic format documents, subject to Terms and Conditions for Electronic Documents at <http://www.sgs.com/en/Terms-and-Conditions/Terms-e-Documents.aspx>. Attention is drawn to the limitation of liability, indemnification and jurisdiction issues defined therein. Any holder of this document is advised that information contained hereon reflects the Company's findings at the time of its intervention only and within the limits of Client's instructions, if any. The Company's sole responsibility is to its Client and this document does not exonerate parties to a transaction from exercising all their rights and obligations under the transaction documents. This document cannot be reproduced except in full, without prior written approval of the Company. Any unauthorized alteration, forgery or falsification of the content or appearance of this document is unlawful and offenders may be prosecuted to the fullest extent of the law. Unless otherwise stated the results shown in this test report refer only to the sample(s) tested and such sample(s) are retained for 30 days only.  
**Attention: To check the authenticity of testing /inspection report & certificate, please contact us at telephone: (86-755) 8307 1443, or email: CN.Doccheck@sgs.com**

No.10, Weiye Road, Innovation Park, Kunshan, Jiangsu, China 215300  
 中国·江苏·昆山市留学生创业园伟业路10号 邮编 215300

t(86-512)57355888 f(86-512)57370818 www.sgsgroup.com.cn  
 t(86-512)57355888 f(86-512)57370818 sgs.china@sgs.com

		802.11a; data rate @ MCS0 is the worst case of IEEE 802.11n(HT20); data rate @ MCS0 is the worst case of IEEE 802.11n(HT40); data rate @ MCS0 is the worst case of IEEE 802.11ac(VHT20); data rate @ MCS0 is the worst case of IEEE 802.11ac(VHT40); data rate @ MCS0 is the worst case of IEEE 802.11ac(VHT80), Only the data of worst case is recorded in the report.
Final test	04	Charge + TX mode (U-NII-3)_Keep the EUT in charging and continuously transmitting mode with all modulation types. All data rates for each modulation type have been tested and found the data rate @ 6Mbps is the worst case of IEEE 802.11a; data rate @ MCS0 is the worst case of IEEE 802.11n(HT20); data rate @ MCS0 is the worst case of IEEE 802.11n(HT40); data rate @ MCS0 is the worst case of IEEE 802.11ac(VHT20); data rate @ MCS0 is the worst case of IEEE 802.11ac(VHT40); data rate @ MCS0 is the worst case of IEEE 802.11ac(VHT80), Only the data of worst case is recorded in the report.

### 7.7.3 Test Setup Diagram

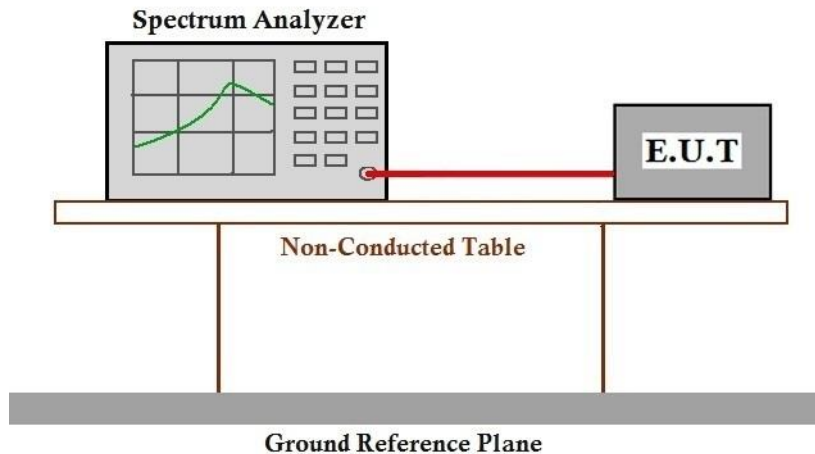

### 7.7.4 Measurement Procedure and Data

Please Refer to Appendix for Details



Unless otherwise agreed in writing, this document is issued by the Company subject to its General Conditions of Service printed overleaf, available on request or accessible at <http://www.sgs.com/en/Terms-and-Conditions.aspx> and, for electronic format documents, subject to Terms and Conditions for Electronic Documents at <http://www.sgs.com/en/Terms-and-Conditions/Terms-e-Documents.aspx>. Attention is drawn to the limitation of liability, indemnification and jurisdiction issues defined therein. Any holder of this document is advised that information contained hereon reflects the Company's findings at the time of its intervention only and within the limits of Client's instructions, if any. The Company's sole responsibility is to its Client and this document does not exonerate parties to a transaction from exercising all their rights and obligations under the transaction documents. This document cannot be reproduced except in full, without prior written approval of the Company. Any unauthorized alteration, forgery or falsification of the content or appearance of this document is unlawful and offenders may be prosecuted to the fullest extent of the law. Unless otherwise stated the results shown in this test report refer only to the sample(s) tested and such sample(s) are retained for 30 days only.  
**Attention: To check the authenticity of testing / inspection report & certificate, please contact us at telephone: (86-755) 8307 1443, or email: CN.Doccheck@sgs.com**

No.10, Weiye Road, Innovation Park, Kunshan, Jiangsu, China 215300  
 中国·江苏·昆山市留学生创业园伟业路10号 邮编 215300

t(86-512)57355888 f(86-512)57370818 www.sgsgroup.com.cn  
 t(86-512)57355888 f(86-512)57370818 sgs.china@sgs.com

**7.8 Radiated Emissions (Above 1GHz)**

Test Requirement 47 CFR Part 15, Subpart C 15.209 & Subpart E 15.407(b)

Test Method: KDB 789033 D02 II G

Limit:

Frequency(MHz)	Field strength(microvolts/meter)	Measurement distance(meters)
Above 1GHz	500	3
<p>*(1) For transmitters operating in the 5.15-5.25 GHz band: All emissions outside of the 5.15-5.35 GHz band shall not exceed an e.i.r.p. of -27 dBm/MHz.</p> <p>(2) For transmitters operating in the 5.25-5.35 GHz band: All emissions outside of the 5.15-5.35 GHz band shall not exceed an e.i.r.p. of -27 dBm/MHz.</p> <p>(3) For transmitters operating in the 5.47-5.725 GHz band: All emissions outside of the 5.47-5.725 GHz band shall not exceed an e.i.r.p. of -27 dBm/MHz.</p> <p>(4) For transmitters operating in the 5.725-5.85 GHz band:</p> <p>(i) All emissions shall be limited to a level of -27 dBm/MHz at 75 MHz or more above or below the band edge increasing linearly to 10 dBm/MHz at 25 MHz above or below the band edge, and from 25 MHz above or below the band edge increasing linearly to a level of 15.6 dBm/MHz at 5 MHz above or below the band edge, and from 5 MHz above or below the band edge increasing linearly to a level of 27 dBm/MHz at the band edge.</p> <p>Remark: The emission limits shown in the above table are based on measurements employing a CISPR quasi-peak detector except for the frequency bands 9-90kHz, 110-490kHz and above 1000 MHz. Radiated emission limits in these three bands are based on measurements employing an average detector, the peak field strength of any emission shall not exceed the maximum permitted average limits specified above by more than 20 dB under any condition of modulation.</p>		

**7.8.1 E.U.T. Operation**

Operating Environment:

Temperature: 23.5 °C

Humidity: 58.5 % RH

Atmospheric Pressure: 1010 mbar

**7.8.2 Test Mode Description**

Pre-scan / Final test	Mode Code	Description
Final test	01	Charge + TX mode (U-NII-1)_Keep the EUT in charging and continuously transmitting mode with all modulation types. All data rates for each modulation type have been tested and found the data rate @ 6Mbps is the worst case of IEE



Unless otherwise agreed in writing, this document is issued by the Company subject to its General Conditions of Service printed overleaf, available on request or accessible at <http://www.sgs.com/en/Terms-and-Conditions.aspx> and, for electronic format documents, subject to Terms and Conditions for Electronic Documents at <http://www.sgs.com/en/Terms-and-Conditions/Terms-e-Documents.aspx>. Attention is drawn to the limitation of liability, indemnification and jurisdiction issues defined therein. Any holder of this document is advised that information contained hereon reflects the Company's findings at the time of its intervention only and within the limits of Client's instructions, if any. The Company's sole responsibility is to its Client and this document does not exonerate parties to a transaction from exercising all their rights and obligations under the transaction documents. This document cannot be reproduced except in full, without prior written approval of the Company. Any unauthorized alteration, forgery or falsification of the content or appearance of this document is unlawful and offenders may be prosecuted to the fullest extent of the law. Unless otherwise stated the results shown in this test report refer only to the sample(s) tested and such sample(s) are retained for 30 days only.  
**Attention: To check the authenticity of testing /inspection report & certificate, please contact us at telephone: (86-755) 8307 1443, or email: CN.Doccheck@sgs.com**  
 No.10, Weiye Road, Innovation Park, Kunshan, Jiangsu, China 215300 t(86-512)57355888 f(86-512)57370818 www.sgsgroup.com.cn  
 中国·江苏·昆山市留学生创业园伟业路10号 邮编 215300 t(86-512)57355888 f(86-512)57370818 sgs.china@sgs.com

		802.11a; data rate @ MCS0 is the worst case of IEEE 802.11n(HT20); data rate @ MCS0 is the worst case of IEEE 802.11n(HT40); data rate @ MCS0 is the worst case of IEEE 802.11ac(VHT20); data rate @ MCS0 is the worst case of IEEE 802.11ac(VHT40); data rate @ MCS0 is the worst case of IEEE 802.11ac(VHT80), Only the data of worst case is recorded in the report.
Final test	02	Charge + TX mode (U-NII-2A)_Keep the EUT in charging and continuously transmitting mode with all modulation types. All data rates for each modulation type have been tested and found the data rate @ 6Mbps is the worst case of IEEE 802.11a; data rate @ MCS0 is the worst case of IEEE 802.11n(HT20); data rate @ MCS0 is the worst case of IEEE 802.11n(HT40); data rate @ MCS0 is the worst case of IEEE 802.11ac(VHT20); data rate @ MCS0 is the worst case of IEEE 802.11ac(VHT40); data rate @ MCS0 is the worst case of IEEE 802.11ac(VHT80), final test modes are considering the modulation and worse data rates. Only the data of worst case is recorded in the report.
Final test	03	Charge + TX mode (U-NII-2C)_Keep the EUT in charging and continuously transmitting mode with all modulation types. All data rates for each modulation type have been tested and found the data rate @ 6Mbps is the worst case of IEEE 802.11a; data rate @ MCS0 is the worst case of IEEE 802.11n(HT20); data rate @ MCS0 is the worst case of IEEE 802.11n(HT40); data rate @ MCS0 is the worst case of IEEE 802.11ac(VHT20); data rate @ MCS0 is the worst case of IEEE 802.11ac(VHT40); data rate @ MCS0 is the worst case of IEEE 802.11ac(VHT80), Only the data of worst case is recorded in the report.
Final test	04	Charge + TX mode (U-NII-3)_Keep the EUT in charging and continuously transmitting mode with all modulation types. All data rates for each modulation type have been tested and found the data rate @ 6Mbps is the worst case of IEEE 802.11a; data rate @ MCS0 is the worst case of IEEE 802.11n(HT20); data rate @ MCS0 is the worst case of IEEE 802.11n(HT40); data rate @ MCS0 is the worst case of IEEE 802.11ac(VHT20); data rate @ MCS0 is the worst case of IEEE 802.11ac(VHT40); data rate @ MCS0 is the worst case of IEEE 802.11ac(VHT80), Only the data of worst case is recorded in the report.

### 7.8.3 Test Setup Diagram

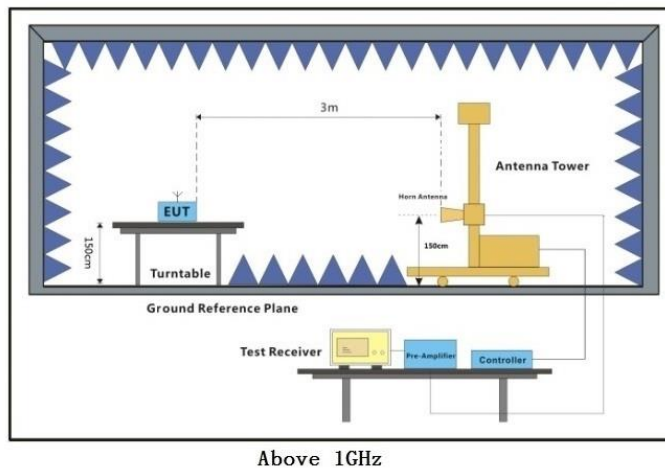

Unless otherwise agreed in writing, this document is issued by the Company subject to its General Conditions of Service printed overleaf, available on request or accessible at <http://www.sgs.com/en/Terms-and-Conditions.aspx> and, for electronic format documents, subject to Terms and Conditions for Electronic Documents at <http://www.sgs.com/en/Terms-and-Conditions/Terms-e-Documents.aspx>. Attention is drawn to the limitation of liability, indemnification and jurisdiction issues defined therein. Any holder of this document is advised that information contained hereon reflects the Company's findings at the time of its intervention only and within the limits of Client's instructions, if any. The Company's sole responsibility is to its Client and this document does not exonerate parties to a transaction from exercising all their rights and obligations under the transaction documents. This document cannot be reproduced except in full, without prior written approval of the Company. Any unauthorized alteration, forgery or falsification of the content or appearance of this document is unlawful and offenders may be prosecuted to the fullest extent of the law. Unless otherwise stated the results shown in this test report refer only to the sample(s) tested and such sample(s) are retained for 30 days only.

Attention: To check the authenticity of testing /inspection report & certificate, please contact us at telephone: (86-755) 8307 1443, or email: [CN.Doccheck@sgs.com](mailto:CN.Doccheck@sgs.com)

No.10, Weiye Road, Innovation Park, Kunshan, Jiangsu, China 215300

中国·江苏·昆山市留学生创业园伟业路10号 邮编 215300

t(86-512)57355888 f(86-512)57370818 [www.sgsgroup.com.cn](http://www.sgsgroup.com.cn)

t(86-512)57355888 f(86-512)57370818 [sgs.china@sgs.com](mailto:sgs.china@sgs.com)



## Compliance Certification Services (Kunshan) Inc.

Report No.: KSCR221000189002

Page: 33 of 607

### 7.8.4 Measurement Procedure and Data



Unless otherwise agreed in writing, this document is issued by the Company subject to its General Conditions of Service printed overleaf, available on request or accessible at <http://www.sgs.com/en/Terms-and-Conditions.aspx> and, for electronic format documents, subject to Terms and Conditions for Electronic Documents at <http://www.sgs.com/en/Terms-and-Conditions/Terms-e-Documents.aspx>. Attention is drawn to the limitation of liability, indemnification and jurisdiction issues defined therein. Any holder of this document is advised that information contained hereon reflects the Company's findings at the time of its intervention only and within the limits of Client's instructions, if any. The Company's sole responsibility is to its Client and this document does not exonerate parties to a transaction from exercising all their rights and obligations under the transaction documents. This document cannot be reproduced except in full, without prior written approval of the Company. Any unauthorized alteration, forgery or falsification of the content or appearance of this document is unlawful and offenders may be prosecuted to the fullest extent of the law. Unless otherwise stated the results shown in this test report refer only to the sample(s) tested and such sample(s) are retained for 30 days only.  
**Attention: To check the authenticity of testing / inspection report & certificate, please contact us at telephone: (86-755) 8307 1443, or email: CN.Doccheck@sgs.com**

No.10, Weiye Road, Innovation Park, Kunshan, Jiangsu, China 215300  
中国·江苏·昆山市留学生创业园伟业路10号 邮编 215300

t(86-512)57355888 f(86-512)57370818 www.sgs.com.cn  
t(86-512)57355888 f(86-512)57370818 sgs.china@sgs.com

- a. For above 1GHz, the EUT was placed on the top of a rotating table 1.5 meters above the ground at a 3 meter fully-anechoic chamber. The table was rotated 360 degrees to determine the position of the highest radiation.
- b. The EUT was set 3 meters away from the interference-receiving antenna, which was mounted on the top of a variable-height antenna tower.
- c. The antenna height is varied from one meter to four meters above the ground to determine the maximum value of the field strength. Both horizontal and vertical polarizations of the antenna are set to make the measurement.
- d. For each suspected emission, the EUT was arranged to its worst case and then the antenna was tuned to heights from 1 meter to 4 meters (for the test frequency of below 30MHz, the antenna was tuned to heights 1 meter) and the rotatable table was turned from 0 degrees to 360 degrees to find the maximum reading.
- e. The test-receiver system was set to Peak Detect Function and Specified Bandwidth with Maximum Hold Mode.
- f. If the emission level of the EUT in peak mode was 10dB lower than the limit specified, then testing could be stopped and the peak values of the EUT would be reported. Otherwise the emissions that did not have 10dB margin would be re-tested one by one using peak or average method as specified and then reported in a data sheet.
- g. Test the EUT in the lowest channel, the middle channel, the Highest channel.
- h. The radiation measurements are performed in X, Y, Z axis positioning for Transmitting mode, and found the X axis positioning which it is the worst case.
- i. Repeat above procedures until all frequencies measured was complete.

**Remark:**

1. Level= Read Level+ Cable Loss+ Antenna Factor- Preamp Factor
2. Scan from 18GHz to 40GHz, the disturbance above 18GHz was very low. The points marked on above plots are the highest emissions could be found when testing, so only above points had been displayed. The amplitude of spurious emissions from the radiator which are attenuated more than 20dB below the limit need not be reported.
3. As shown in this section, for frequencies above 1GHz, the field strength limits are based on average limits. However, the peak field strength of any emission shall not exceed the maximum permitted average limits specified above by more than 20 dB under any condition of modulation. For the emissions whose peak level is lower than the average limit, only the peak measurement is shown in the report.
4. The disturbance above 18GHz were very low and the harmonics were the highest point could be found when testing, so only the above harmonics had been displayed.
5. For devices with multiple operating modes, measurements on the middle channel is used to determine the worst-case mode(s). Only the worst case mode with the highest output power and the mode with the highest output power spectral density for each modulation family (e.g., OFDM and direct sequence spread spectrum) is recorded in the test report.
6. This test item was investigated while operating in SISO and MIMO mode, however, it was determined that SISO antenna 1 operation for a modulation and MIMO antenna operation for n/ac modulation produced the worst emissions. So the emissions produced from other operation are not recorded in report.



Unless otherwise agreed in writing, this document is issued by the Company subject to its General Conditions of Service printed overleaf, available on request or accessible at <http://www.sgs.com/en/Terms-and-Conditions.aspx> and, for electronic format documents, subject to Terms and Conditions for Electronic Documents at <http://www.sgs.com/en/Terms-and-Conditions/Terms-e-Documents.aspx>. Attention is drawn to the limitation of liability, indemnification and jurisdiction issues defined therein. Any holder of this document is advised that information contained hereon reflects the Company's findings at the time of its intervention only and within the limits of Client's instructions, if any. The Company's sole responsibility is to its Client and this document does not exonerate parties to a transaction from exercising all their rights and obligations under the transaction documents. This document cannot be reproduced except in full, without prior written approval of the Company. Any unauthorized alteration, forgery or falsification of the content or appearance of this document is unlawful and offenders may be prosecuted to the fullest extent of the law. Unless otherwise stated the results shown in this test report refer only to the sample(s) tested and such sample(s) are retained for 30 days only.  
**Attention: To check the authenticity of testing /inspection report & certificate, please contact us at telephone: (86-755) 8307 1443, or email: CN.Doccheck@sgs.com**

No.10, Weiye Road, Innovation Park, Kunshan, Jiangsu, China 215300      t(86-512)57355888      f(86-512)57370818      www.sgsgroup.com.cn  
 中国·江苏·昆山市留学院创业园伟业路10号 邮编 215300      t(86-512)57355888      f(86-512)57370818      sgs.china@sgs.com

Test Mode: 01; Polarity: Horizontal; Modulation:802.11a; Bandwidth:20MHz; Channel:Low

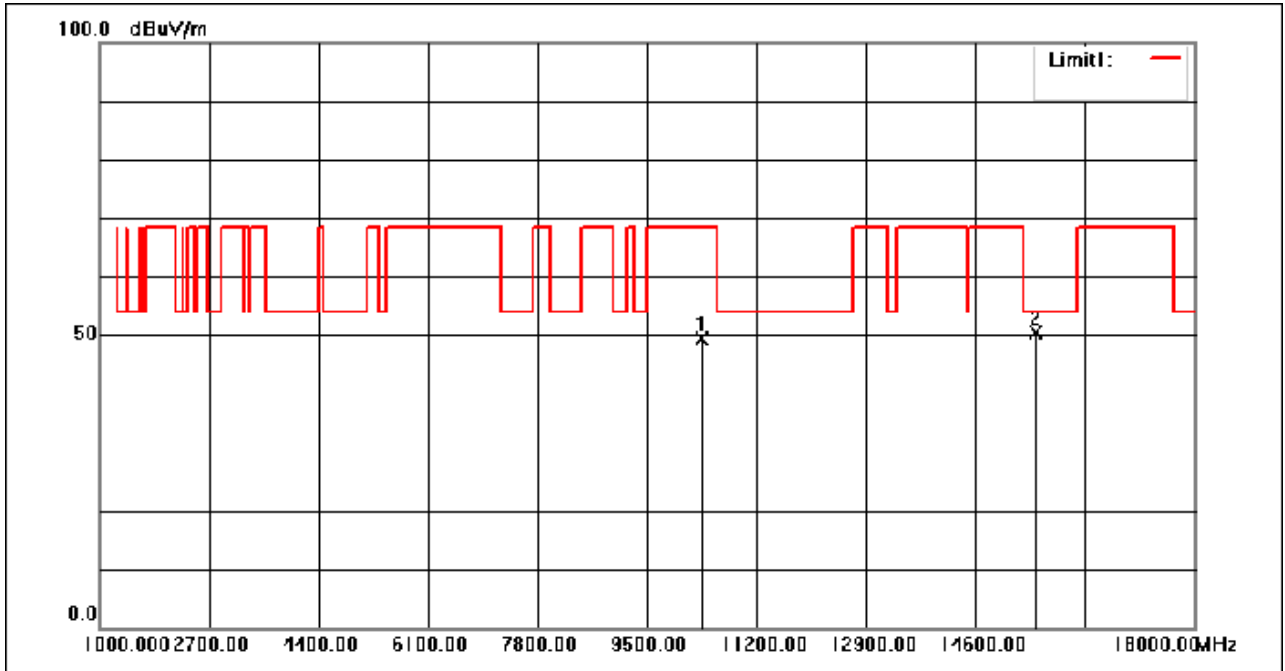

No.	Frequency (MHz)	Reading (dBuV)	Correction factor(dB/m)	Result (dBuV/m)	Limit (dBuV/m)	Margin (dB)	Remark
1	10360.000	49.23	0.16	49.39	68.30	-18.91	peak
2	15540.000	44.73	5.73	50.46	54.00	-3.54	peak



Unless otherwise agreed in writing, this document is issued by the Company subject to its General Conditions of Service printed overleaf, available on request or accessible at <http://www.sgs.com/en/Terms-and-Conditions.aspx> and, for electronic format documents, subject to Terms and Conditions for Electronic Documents at <http://www.sgs.com/en/Terms-and-Conditions/Terms-e-Documents.aspx>. Attention is drawn to the limitation of liability, indemnification and jurisdiction issues defined therein. Any holder of this document is advised that information contained hereon reflects the Company's findings at the time of its intervention only and within the limits of Client's instructions, if any. The Company's sole responsibility is to its Client and this document does not exonerate parties to a transaction from exercising all their rights and obligations under the transaction documents. This document cannot be reproduced except in full, without prior written approval of the Company. Any unauthorized alteration, forgery or falsification of the content or appearance of this document is unlawful and offenders may be prosecuted to the fullest extent of the law. Unless otherwise stated the results shown in this test report refer only to the sample(s) tested and such sample(s) are retained for 30 days only.  
Attention: To check the authenticity of testing /inspection report & certificate, please contact us at telephone: (86-755) 8307 1443, or email: [CN.Doccheck@sgs.com](mailto:CN.Doccheck@sgs.com)

No.10, Weiye Road, Innovation Park, Kunshan, Jiangsu, China 215300  
中国·江苏·昆山市留学生创业园伟业路10号 邮编 215300

t(86-512)57355888 f(86-512)57370818 www.sgs.com.cn  
t(86-512)57355888 f(86-512)57370818 sgs.china@sgs.com

Test Mode: 01; Polarity: Vertical; Modulation:802.11a; Bandwidth:20MHz; Channel:Low

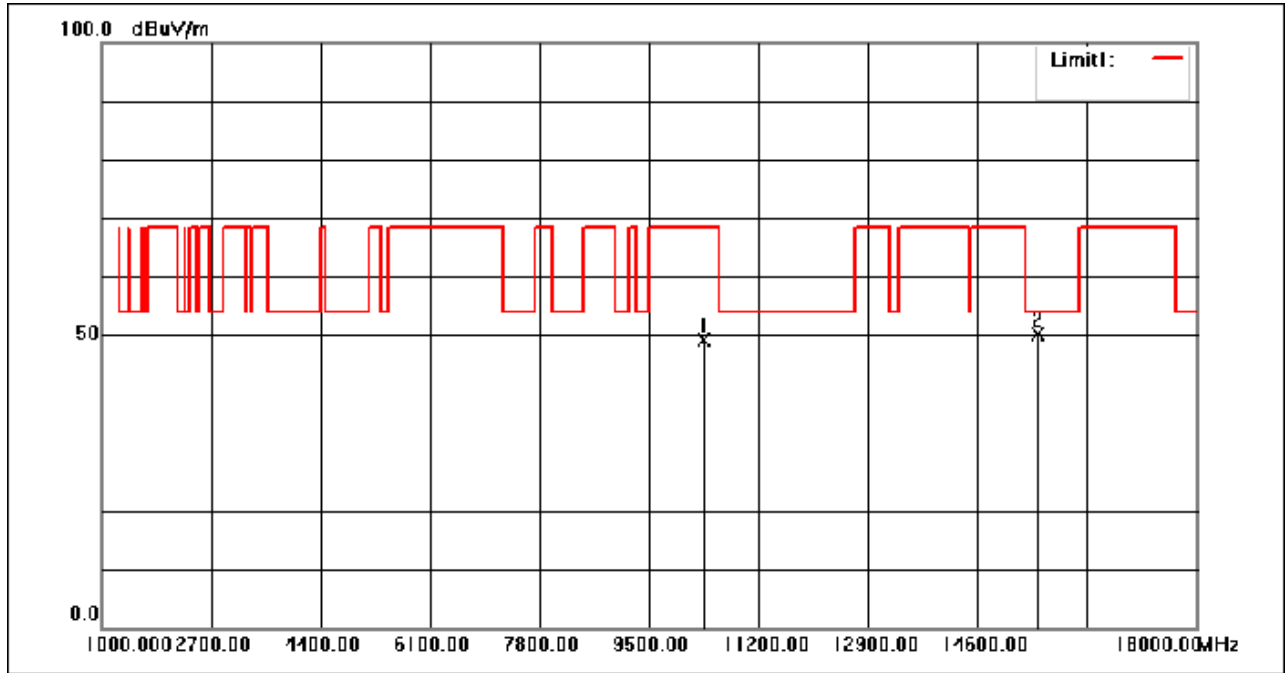

No.	Frequency (MHz)	Reading (dBuV)	Correction factor(dB/m)	Result (dBuV/m)	Limit (dBuV/m)	Margin (dB)	Remark
1	10360.000	49.00	0.16	49.16	68.30	-19.14	peak
2	15540.000	44.30	5.73	50.03	54.00	-3.97	peak



Unless otherwise agreed in writing, this document is issued by the Company subject to its General Conditions of Service printed overleaf, available on request or accessible at <http://www.sgs.com/en/Terms-and-Conditions.aspx> and, for electronic format documents, subject to Terms and Conditions for Electronic Documents at <http://www.sgs.com/en/Terms-and-Conditions/Terms-e-Documents.aspx>. Attention is drawn to the limitation of liability, indemnification and jurisdiction issues defined therein. Any holder of this document is advised that information contained hereon reflects the Company's findings at the time of its intervention only and within the limits of Client's instructions, if any. The Company's sole responsibility is to its Client and this document does not exonerate parties to a transaction from exercising all their rights and obligations under the transaction documents. This document cannot be reproduced except in full, without prior written approval of the Company. Any unauthorized alteration, forgery or falsification of the content or appearance of this document is unlawful and offenders may be prosecuted to the fullest extent of the law. Unless otherwise stated the results shown in this test report refer only to the sample(s) tested and such sample(s) are retained for 30 days only.  
**Attention: To check the authenticity of testing /inspection report & certificate, please contact us at telephone: (86-755) 8307 1443, or email: CN.Doccheck@sgs.com**

No.10, Weiye Road, Innovation Park, Kunshan, Jiangsu, China 215300  
 中国·江苏·昆山市留学生创业园伟业路10号 邮编 215300

t(86-512)57355888 f(86-512)57370818 www.sgs.com.cn  
 t(86-512)57355888 f(86-512)57370818 sgs.china@sgs.com



Test Mode: 01; Polarity: Horizontal; Modulation:802.11a; Bandwidth:20MHz; Channel:middle

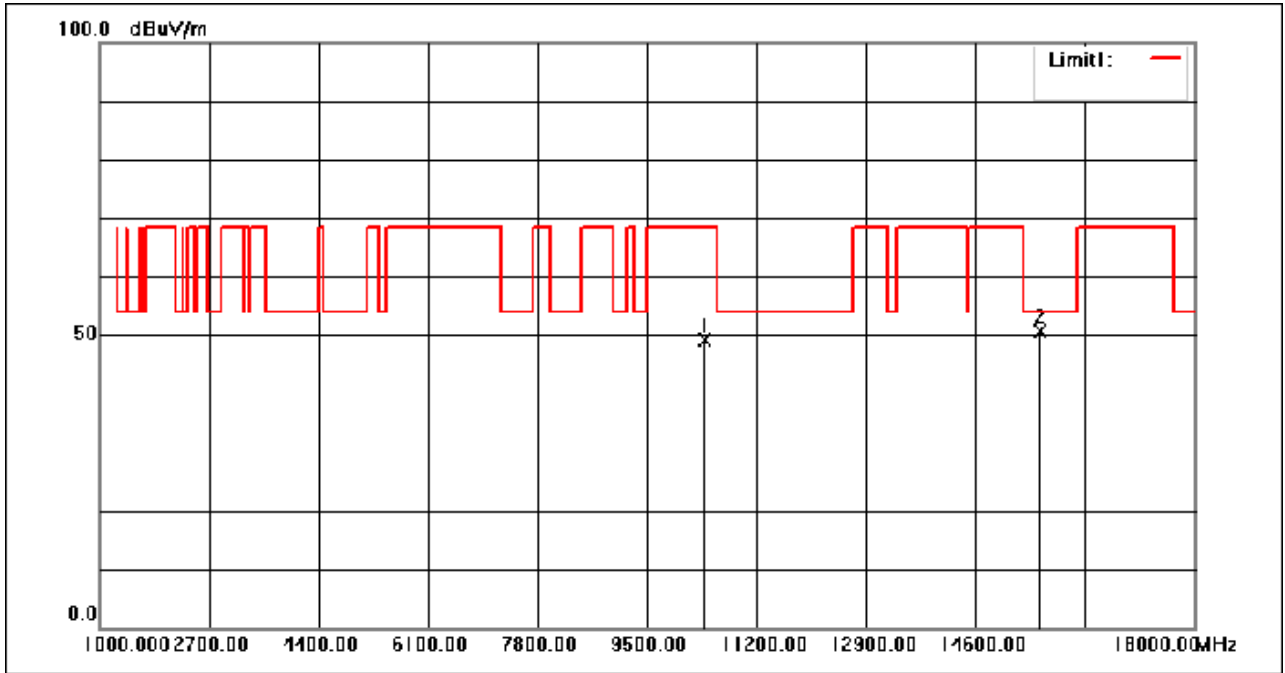

No.	Frequency (MHz)	Reading (dBuV)	Correction factor(dB/m)	Result (dBuV/m)	Limit (dBuV/m)	Margin (dB)	Remark
1	10400.000	48.96	0.24	49.20	68.30	-19.10	peak
2	15600.000	44.78	5.85	50.63	54.00	-3.37	peak



Unless otherwise agreed in writing, this document is issued by the Company subject to its General Conditions of Service printed overleaf, available on request or accessible at <http://www.sgs.com/en/Terms-and-Conditions.aspx> and, for electronic format documents, subject to Terms and Conditions for Electronic Documents at <http://www.sgs.com/en/Terms-and-Conditions/Terms-e-Documents.aspx>. Attention is drawn to the limitation of liability, indemnification and jurisdiction issues defined therein. Any holder of this document is advised that information contained hereon reflects the Company's findings at the time of its intervention only and within the limits of Client's instructions, if any. The Company's sole responsibility is to its Client and this document does not exonerate parties to a transaction from exercising all their rights and obligations under the transaction documents. This document cannot be reproduced except in full, without prior written approval of the Company. Any unauthorized alteration, forgery or falsification of the content or appearance of this document is unlawful and offenders may be prosecuted to the fullest extent of the law. Unless otherwise stated the results shown in this test report refer only to the sample(s) tested and such sample(s) are retained for 30 days only.  
**Attention: To check the authenticity of testing /inspection report & certificate, please contact us at telephone: (86-755) 8307 1443, or email: CN.Doccheck@sgs.com**

No.10, Weiye Road, Innovation Park, Kunshan, Jiangsu, China 215300  
 中国·江苏·昆山市留学生创业园伟业路10号 邮编 215300

t(86-512)57355888 f(86-512)57370818 www.sgsgroup.com.cn  
 t(86-512)57355888 f(86-512)57370818 sgs.china@sgs.com

Test Mode: 01; Polarity: Vertical; Modulation:802.11a; Bandwidth:20MHz; Channel:middle

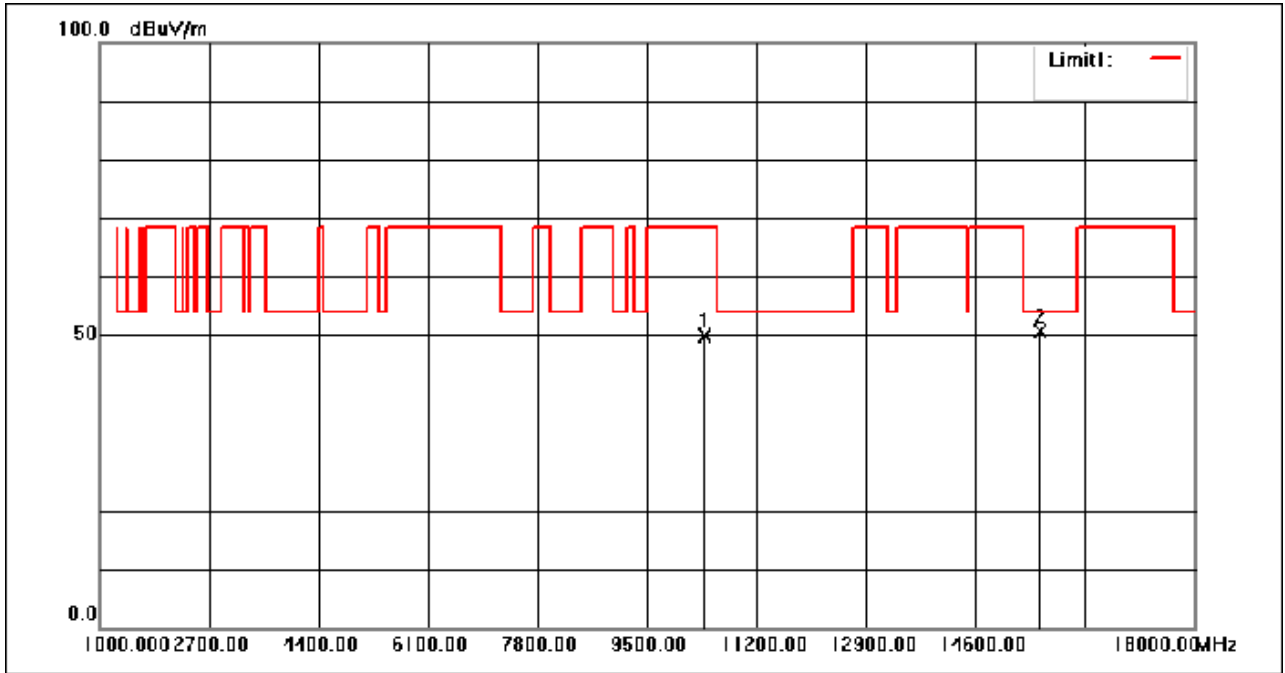

No.	Frequency (MHz)	Reading (dBuV)	Correction factor(dB/m)	Result (dBuV/m)	Limit (dBuV/m)	Margin (dB)	Remark
1	10400.000	49.72	0.24	49.96	68.30	-18.34	peak
2	15600.000	44.69	5.85	50.54	54.00	-3.46	peak



Unless otherwise agreed in writing, this document is issued by the Company subject to its General Conditions of Service printed overleaf, available on request or accessible at <http://www.sgs.com/en/Terms-and-Conditions.aspx> and, for electronic format documents, subject to Terms and Conditions for Electronic Documents at <http://www.sgs.com/en/Terms-and-Conditions/Terms-e-Documents.aspx>. Attention is drawn to the limitation of liability, indemnification and jurisdiction issues defined therein. Any holder of this document is advised that information contained hereon reflects the Company's findings at the time of its intervention only and within the limits of Client's instructions, if any. The Company's sole responsibility is to its Client and this document does not exonerate parties to a transaction from exercising all their rights and obligations under the transaction documents. This document cannot be reproduced except in full, without prior written approval of the Company. Any unauthorized alteration, forgery or falsification of the content or appearance of this document is unlawful and offenders may be prosecuted to the fullest extent of the law. Unless otherwise stated the results shown in this test report refer only to the sample(s) tested and such sample(s) are retained for 30 days only.  
Attention: To check the authenticity of testing /inspection report & certificate, please contact us at telephone: (86-755) 8307 1443, or email: [CN.Doccheck@sgs.com](mailto:CN.Doccheck@sgs.com)

No.10, Weiye Road, Innovation Park, Kunshan, Jiangsu, China 215300  
中国·江苏·昆山市留学生创业园伟业路10号 邮编 215300

t(86-512)57355888 f(86-512)57370818 www.sgs.com.cn  
t(86-512)57355888 f(86-512)57370818 sgs.china@sgs.com

Test Mode: 01; Polarity: Horizontal; Modulation:802.11a; Bandwidth:20MHz; Channel:High

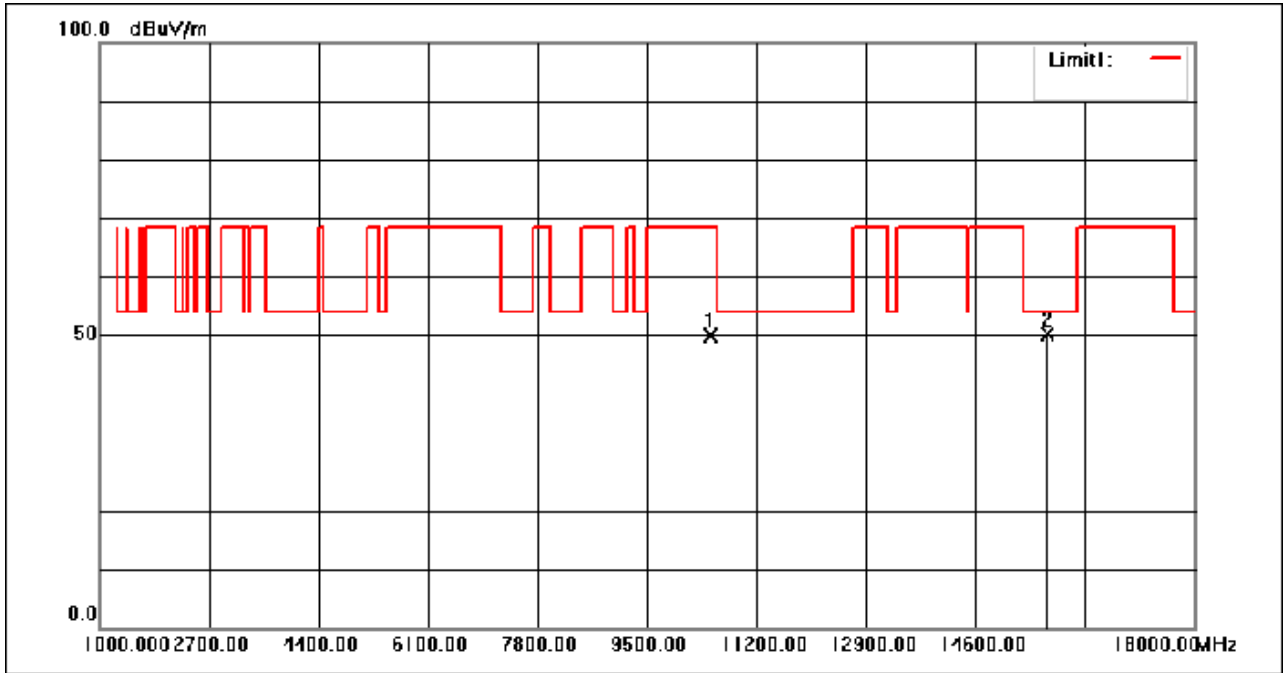

No.	Frequency (MHz)	Reading (dBuV)	Correction factor(dB/m)	Result (dBuV/m)	Limit (dBuV/m)	Margin (dB)	Remark
1	10480.000	49.51	0.40	49.91	68.30	-18.39	peak
2	15720.000	44.09	6.10	50.19	54.00	-3.81	peak



Unless otherwise agreed in writing, this document is issued by the Company subject to its General Conditions of Service printed overleaf, available on request or accessible at <http://www.sgs.com/en/Terms-and-Conditions.aspx> and, for electronic format documents, subject to Terms and Conditions for Electronic Documents at <http://www.sgs.com/en/Terms-and-Conditions/Terms-e-Documents.aspx>. Attention is drawn to the limitation of liability, indemnification and jurisdiction issues defined therein. Any holder of this document is advised that information contained hereon reflects the Company's findings at the time of its intervention only and within the limits of Client's instructions, if any. The Company's sole responsibility is to its Client and this document does not exonerate parties to a transaction from exercising all their rights and obligations under the transaction documents. This document cannot be reproduced except in full, without prior written approval of the Company. Any unauthorized alteration, forgery or falsification of the content or appearance of this document is unlawful and offenders may be prosecuted to the fullest extent of the law. Unless otherwise stated the results shown in this test report refer only to the sample(s) tested and such sample(s) are retained for 30 days only.  
**Attention: To check the authenticity of testing /inspection report & certificate, please contact us at telephone: (86-755) 8307 1443, or email: CN.Doccheck@sgs.com**

No.10, Weiye Road, Innovation Park, Kunshan, Jiangsu, China 215300  
 中国·江苏·昆山市留学生创业园伟业路10号 邮编 215300

t(86-512)57355888 f(86-512)57370818 www.sgsgroup.com.cn  
 t(86-512)57355888 f(86-512)57370818 sgs.china@sgs.com

Test Mode: 01; Polarity: Vertical; Modulation:802.11a; Bandwidth:20MHz; Channel:High

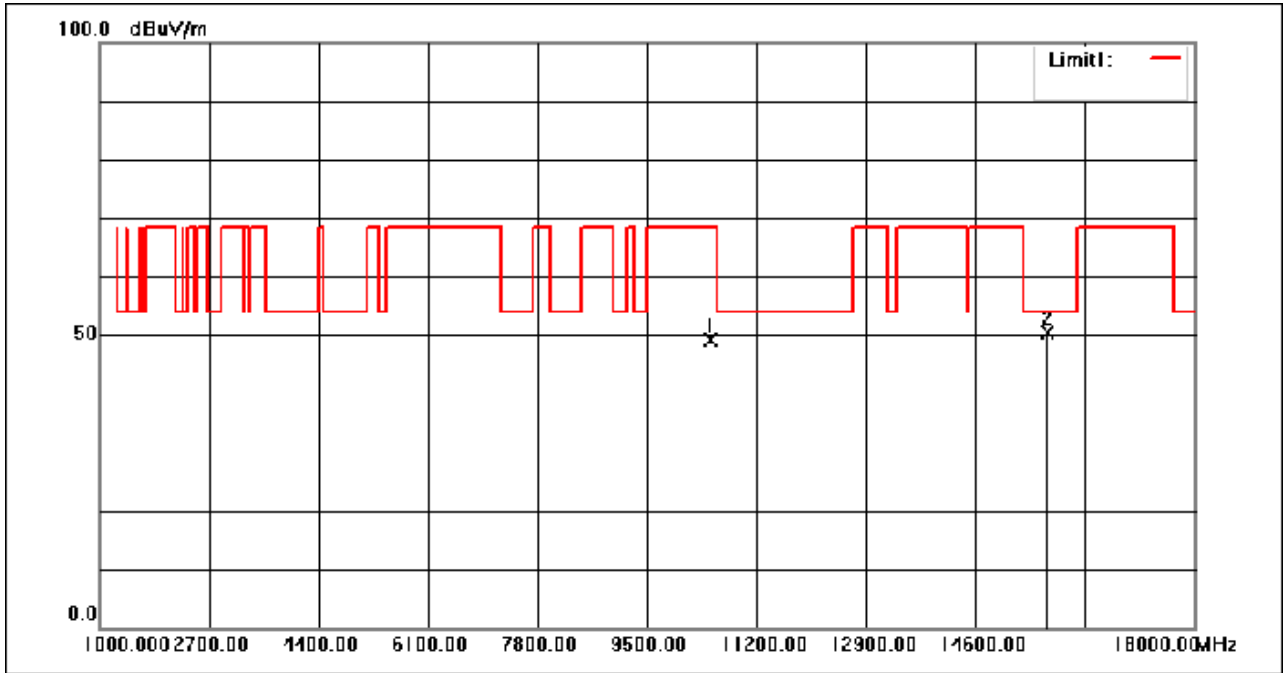

No.	Frequency (MHz)	Reading (dBuV)	Correction factor(dB/m)	Result (dBuV/m)	Limit (dBuV/m)	Margin (dB)	Remark
1	10480.000	48.82	0.40	49.22	68.30	-19.08	peak
2	15720.000	44.19	6.10	50.29	54.00	-3.71	peak



Unless otherwise agreed in writing, this document is issued by the Company subject to its General Conditions of Service printed overleaf, available on request or accessible at <http://www.sgs.com/en/Terms-and-Conditions.aspx> and, for electronic format documents, subject to Terms and Conditions for Electronic Documents at <http://www.sgs.com/en/Terms-and-Conditions/Terms-e-Documents.aspx>. Attention is drawn to the limitation of liability, indemnification and jurisdiction issues defined therein. Any holder of this document is advised that information contained hereon reflects the Company's findings at the time of its intervention only and within the limits of Client's instructions, if any. The Company's sole responsibility is to its Client and this document does not exonerate parties to a transaction from exercising all their rights and obligations under the transaction documents. This document cannot be reproduced except in full, without prior written approval of the Company. Any unauthorized alteration, forgery or falsification of the content or appearance of this document is unlawful and offenders may be prosecuted to the fullest extent of the law. Unless otherwise stated the results shown in this test report refer only to the sample(s) tested and such sample(s) are retained for 30 days only.  
**Attention: To check the authenticity of testing /inspection report & certificate, please contact us at telephone: (86-755) 8307 1443, or email: CN.Doccheck@sgs.com**

Compliance Certification Services (Kunshan) Inc.  
 EMC Laboratory

No.10, Weiye Road, Innovation Park, Kunshan, Jiangsu, China 215300  
 中国·江苏·昆山市留学生创业园伟业路10号 邮编 215300

t(86-512)57355888 f(86-512)57370818 www.sgsgroup.com.cn  
 t(86-512)57355888 f(86-512)57370818 sgs.china@sgs.com



Test Mode: 01; Polarity: Horizontal; Modulation:802.11n; Bandwidth:20MHz; Channel:Low

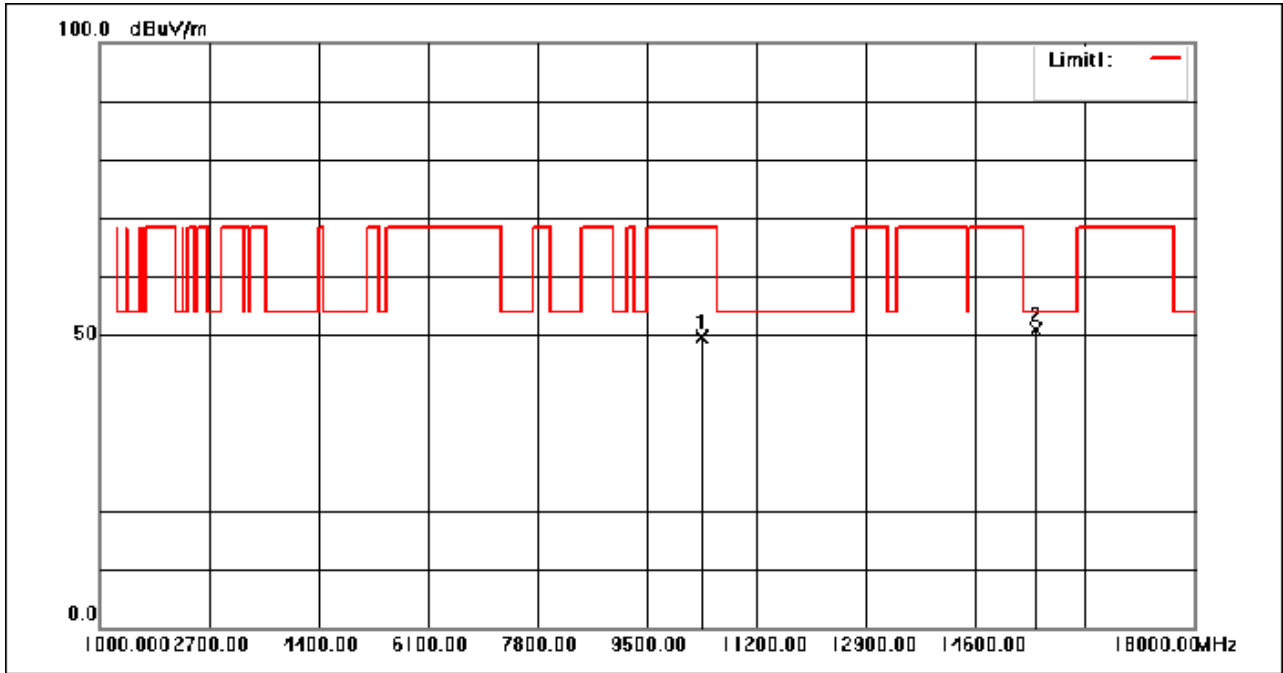

No.	Frequency (MHz)	Reading (dBuV)	Correction factor(dB/m)	Result (dBuV/m)	Limit (dBuV/m)	Margin (dB)	Remark
1	10360.000	49.46	0.16	49.62	68.30	-18.68	peak
2	15540.000	45.20	5.73	50.93	54.00	-3.07	peak



Unless otherwise agreed in writing, this document is issued by the Company subject to its General Conditions of Service printed overleaf, available on request or accessible at <http://www.sgs.com/en/Terms-and-Conditions.aspx> and, for electronic format documents, subject to Terms and Conditions for Electronic Documents at <http://www.sgs.com/en/Terms-and-Conditions/Terms-e-Documents.aspx>. Attention is drawn to the limitation of liability, indemnification and jurisdiction issues defined therein. Any holder of this document is advised that information contained hereon reflects the Company's findings at the time of its intervention only and within the limits of Client's instructions, if any. The Company's sole responsibility is to its Client and this document does not exonerate parties to a transaction from exercising all their rights and obligations under the transaction documents. This document cannot be reproduced except in full, without prior written approval of the Company. Any unauthorized alteration, forgery or falsification of the content or appearance of this document is unlawful and offenders may be prosecuted to the fullest extent of the law. Unless otherwise stated the results shown in this test report refer only to the sample(s) tested and such sample(s) are retained for 30 days only.  
**Attention: To check the authenticity of testing /inspection report & certificate, please contact us at telephone: (86-755) 8307 1443, or email: CN.Doccheck@sgs.com**

No.10, Weiye Road, Innovation Park, Kunshan, Jiangsu, China 215300  
 中国·江苏·昆山市留学生创业园伟业路10号 邮编 215300

t(86-512)57355888 f(86-512)57370818 www.sgs.com.cn  
 t(86-512)57355888 f(86-512)57370818 sgs.china@sgs.com

Test Mode: 01; Polarity: Vertical; Modulation:802.11n; Bandwidth:20MHz; Channel:Low

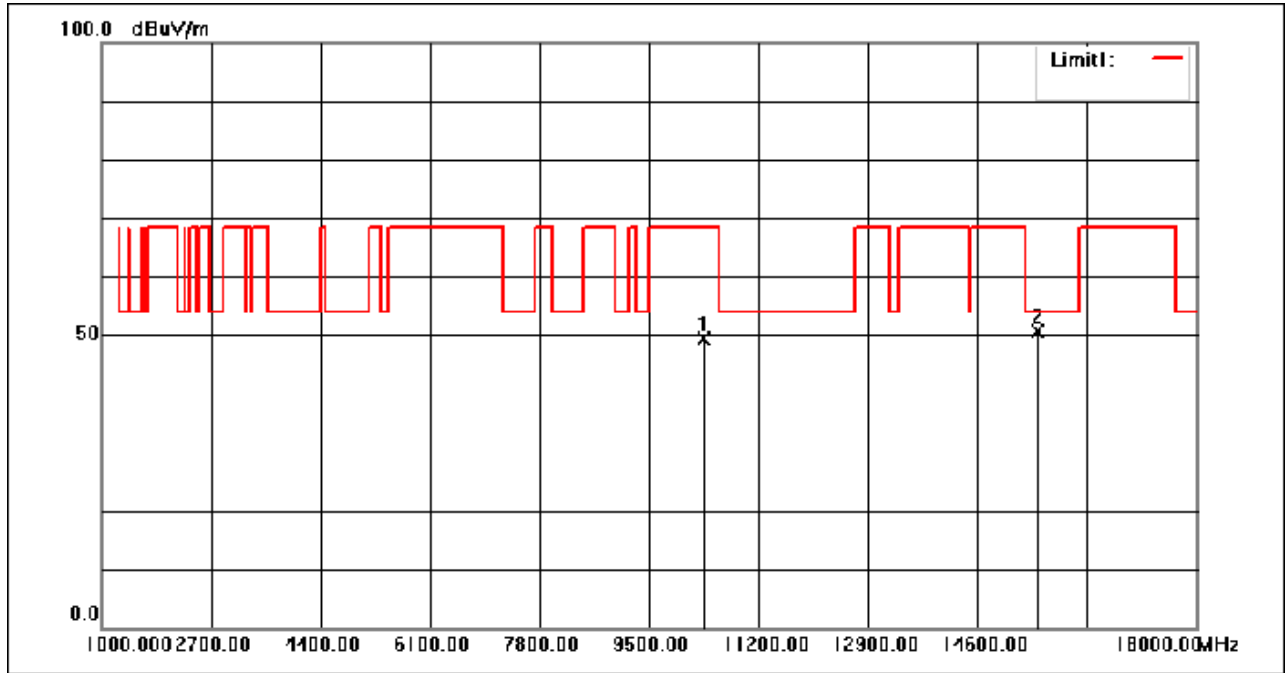

No.	Frequency (MHz)	Reading (dBuV)	Correction factor(dB/m)	Result (dBuV/m)	Limit (dBuV/m)	Margin (dB)	Remark
1	10360.000	49.19	0.16	49.35	68.30	-18.95	peak
2	15540.000	44.92	5.73	50.65	54.00	-3.35	peak



Unless otherwise agreed in writing, this document is issued by the Company subject to its General Conditions of Service printed overleaf, available on request or accessible at <http://www.sgs.com/en/Terms-and-Conditions.aspx> and, for electronic format documents, subject to Terms and Conditions for Electronic Documents at <http://www.sgs.com/en/Terms-and-Conditions/Terms-e-Documents.aspx>. Attention is drawn to the limitation of liability, indemnification and jurisdiction issues defined therein. Any holder of this document is advised that information contained hereon reflects the Company's findings at the time of its intervention only and within the limits of Client's instructions, if any. The Company's sole responsibility is to its Client and this document does not exonerate parties to a transaction from exercising all their rights and obligations under the transaction documents. This document cannot be reproduced except in full, without prior written approval of the Company. Any unauthorized alteration, forgery or falsification of the content or appearance of this document is unlawful and offenders may be prosecuted to the fullest extent of the law. Unless otherwise stated the results shown in this test report refer only to the sample(s) tested and such sample(s) are retained for 30 days only.  
**Attention: To check the authenticity of testing /inspection report & certificate, please contact us at telephone: (86-755) 8307 1443, or email: CN.Doccheck@sgs.com**

No.10, Weiye Road, Innovation Park, Kunshan, Jiangsu, China 215300  
 中国·江苏·昆山市留学生创业园伟业路10号 邮编 215300

t(86-512)57355888 f(86-512)57370818 www.sgsgroup.com.cn  
 t(86-512)57355888 f(86-512)57370818 sgs.china@sgs.com

Test Mode: 01; Polarity: Horizontal; Modulation:802.11n; Bandwidth:20MHz; Channel:middle

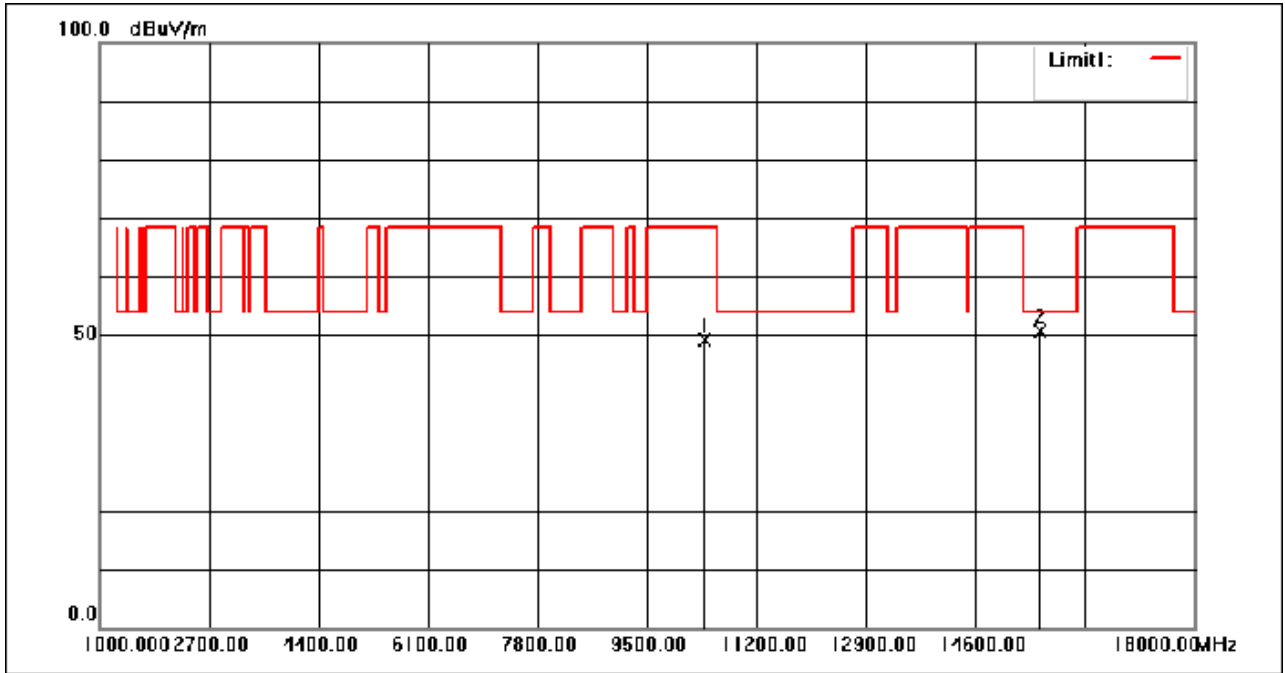

No.	Frequency (MHz)	Reading (dBuV)	Correction factor(dB/m)	Result (dBuV/m)	Limit (dBuV/m)	Margin (dB)	Remark
1	10400.000	48.95	0.24	49.19	68.30	-19.11	peak
2	15600.000	44.75	5.85	50.60	54.00	-3.40	peak



Unless otherwise agreed in writing, this document is issued by the Company subject to its General Conditions of Service printed overleaf, available on request or accessible at <http://www.sgs.com/en/Terms-and-Conditions.aspx> and, for electronic format documents, subject to Terms and Conditions for Electronic Documents at <http://www.sgs.com/en/Terms-and-Conditions/Terms-e-Documents.aspx>. Attention is drawn to the limitation of liability, indemnification and jurisdiction issues defined therein. Any holder of this document is advised that information contained hereon reflects the Company's findings at the time of its intervention only and within the limits of Client's instructions, if any. The Company's sole responsibility is to its Client and this document does not exonerate parties to a transaction from exercising all their rights and obligations under the transaction documents. This document cannot be reproduced except in full, without prior written approval of the Company. Any unauthorized alteration, forgery or falsification of the content or appearance of this document is unlawful and offenders may be prosecuted to the fullest extent of the law. Unless otherwise stated the results shown in this test report refer only to the sample(s) tested and such sample(s) are retained for 30 days only.  
**Attention: To check the authenticity of testing /inspection report & certificate, please contact us at telephone: (86-755) 8307 1443, or email: CN.Doccheck@sgs.com**

No.10, Weiye Road, Innovation Park, Kunshan, Jiangsu, China 215300  
 中国·江苏·昆山市留学生创业园伟业路10号 邮编 215300

t(86-512)57355888 f(86-512)57370818 www.sgs.com.cn  
 t(86-512)57355888 f(86-512)57370818 sgs.china@sgs.com

Test Mode: 01; Polarity: Vertical; Modulation:802.11n; Bandwidth:20MHz; Channel:middle

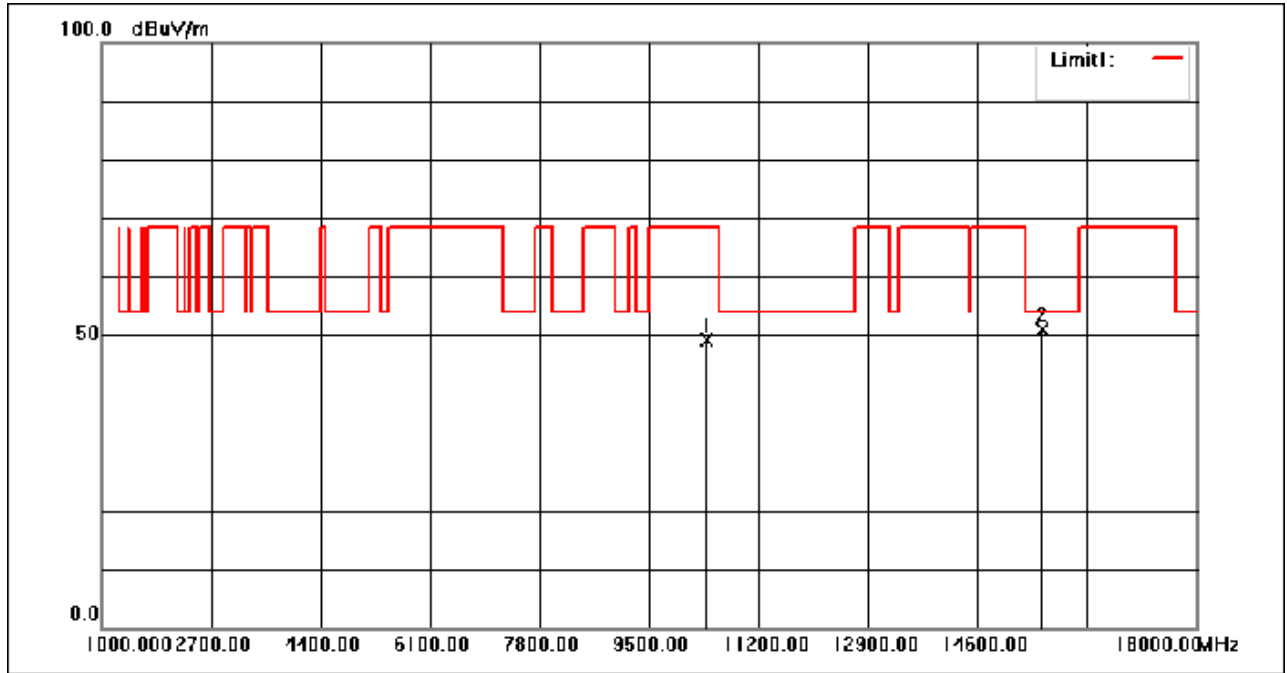

No.	Frequency (MHz)	Reading (dBuV)	Correction factor(dB/m)	Result (dBuV/m)	Limit (dBuV/m)	Margin (dB)	Remark
1	10400.000	48.80	0.24	49.04	68.30	-19.26	peak
2	15600.000	45.14	5.85	50.99	54.00	-3.01	peak



Unless otherwise agreed in writing, this document is issued by the Company subject to its General Conditions of Service printed overleaf, available on request or accessible at <http://www.sgs.com/en/Terms-and-Conditions.aspx> and, for electronic format documents, subject to Terms and Conditions for Electronic Documents at <http://www.sgs.com/en/Terms-and-Conditions/Terms-e-Documents.aspx>. Attention is drawn to the limitation of liability, indemnification and jurisdiction issues defined therein. Any holder of this document is advised that information contained hereon reflects the Company's findings at the time of its intervention only and within the limits of Client's instructions, if any. The Company's sole responsibility is to its Client and this document does not exonerate parties to a transaction from exercising all their rights and obligations under the transaction documents. This document cannot be reproduced except in full, without prior written approval of the Company. Any unauthorized alteration, forgery or falsification of the content or appearance of this document is unlawful and offenders may be prosecuted to the fullest extent of the law. Unless otherwise stated the results shown in this test report refer only to the sample(s) tested and such sample(s) are retained for 30 days only.  
**Attention: To check the authenticity of testing /inspection report & certificate, please contact us at telephone: (86-755) 8307 1443, or email: CN.Doccheck@sgs.com**

No.10, Weiye Road, Innovation Park, Kunshan, Jiangsu, China 215300  
 中国·江苏·昆山市留学生创业园伟业路10号 邮编 215300

t(86-512)57355888 f(86-512)57370818 www.sgs.com.cn  
 t(86-512)57355888 f(86-512)57370818 sgs.china@sgs.com



Test Mode: 01; Polarity: Horizontal; Modulation:802.11n; Bandwidth:20MHz; Channel:High

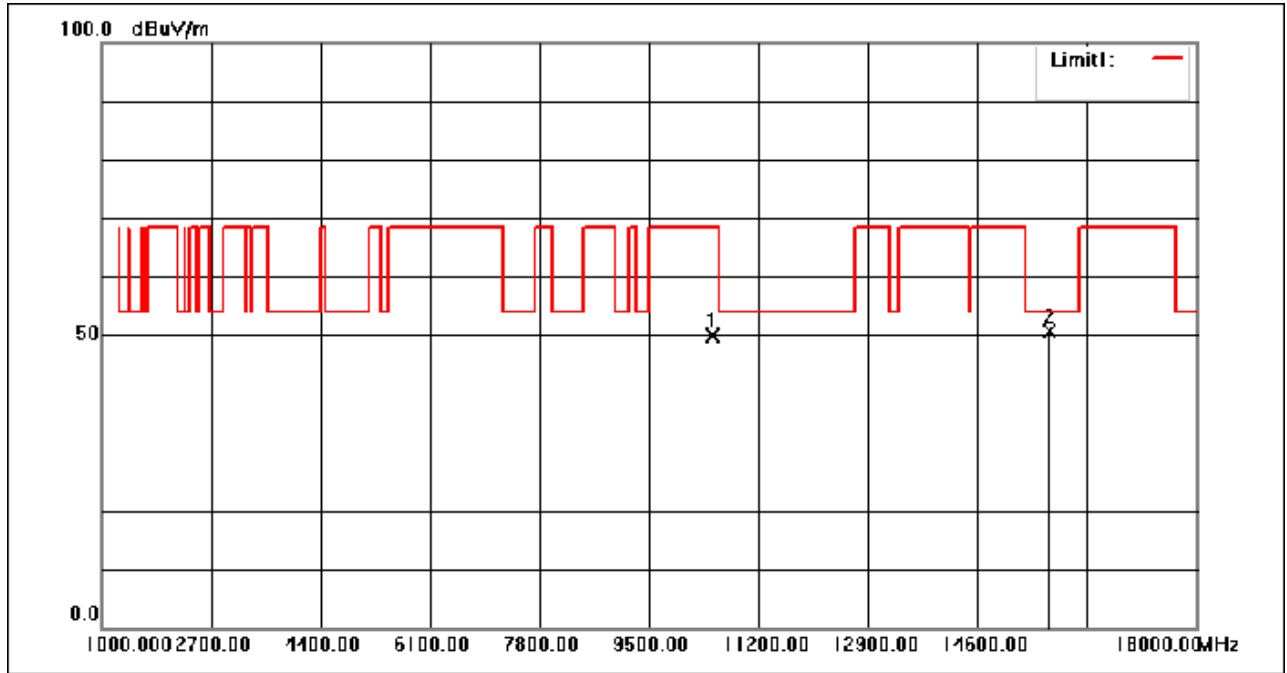

No.	Frequency (MHz)	Reading (dBuV)	Correction factor(dB/m)	Result (dBuV/m)	Limit (dBuV/m)	Margin (dB)	Remark
1	10480.000	49.49	0.40	49.89	68.30	-18.41	peak
2	15720.000	44.46	6.10	50.56	54.00	-3.44	peak



Unless otherwise agreed in writing, this document is issued by the Company subject to its General Conditions of Service printed overleaf, available on request or accessible at <http://www.sgs.com/en/Terms-and-Conditions.aspx> and, for electronic format documents, subject to Terms and Conditions for Electronic Documents at <http://www.sgs.com/en/Terms-and-Conditions/Terms-e-Documents.aspx>. Attention is drawn to the limitation of liability, indemnification and jurisdiction issues defined therein. Any holder of this document is advised that information contained hereon reflects the Company's findings at the time of its intervention only and within the limits of Client's instructions, if any. The Company's sole responsibility is to its Client and this document does not exonerate parties to a transaction from exercising all their rights and obligations under the transaction documents. This document cannot be reproduced except in full, without prior written approval of the Company. Any unauthorized alteration, forgery or falsification of the content or appearance of this document is unlawful and offenders may be prosecuted to the fullest extent of the law. Unless otherwise stated the results shown in this test report refer only to the sample(s) tested and such sample(s) are retained for 30 days only.  
**Attention: To check the authenticity of testing /inspection report & certificate, please contact us at telephone: (86-755) 8307 1443, or email: CN.Doccheck@sgs.com**

No.10, Weiye Road, Innovation Park, Kunshan, Jiangsu, China 215300  
 中国·江苏·昆山市留学生创业园伟业路10号 邮编 215300

t(86-512)57355888 f(86-512)57370818 www.sgsgroup.com.cn  
 t(86-512)57355888 f(86-512)57370818 sgs.china@sgs.com

Test Mode: 01; Polarity: Vertical; Modulation:802.11n; Bandwidth:20MHz; Channel:High

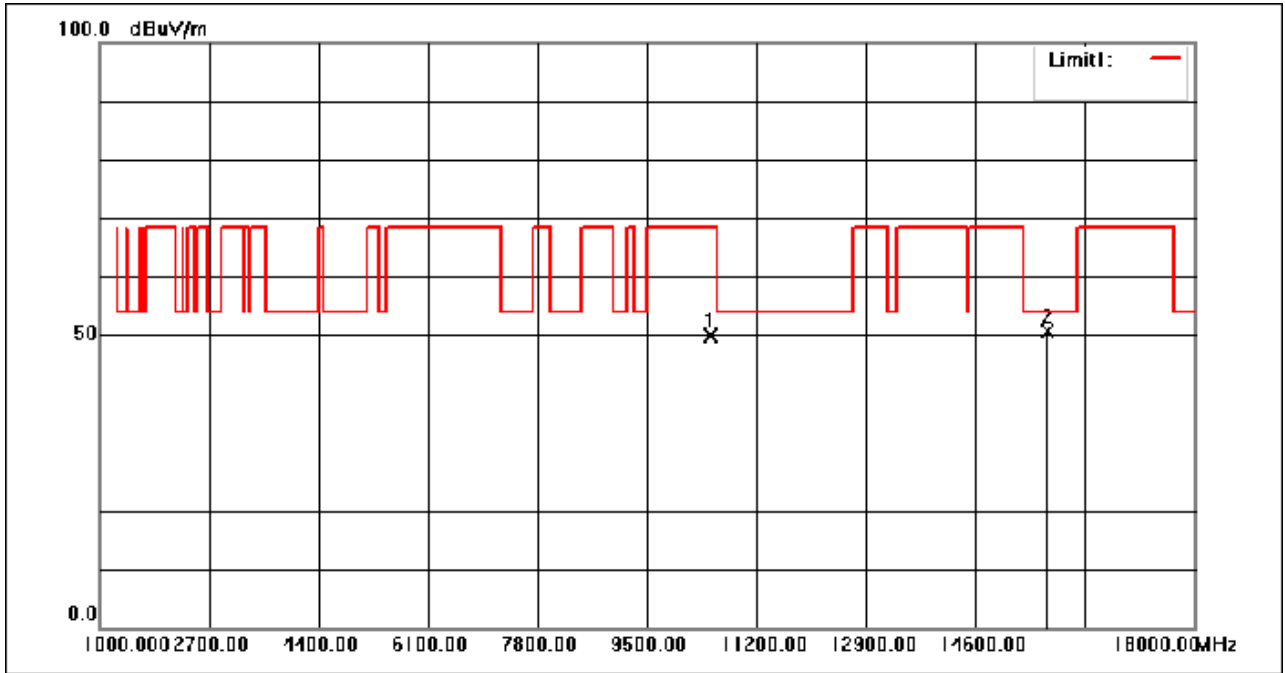

No.	Frequency (MHz)	Reading (dBuV)	Correction factor(dB/m)	Result (dBuV/m)	Limit (dBuV/m)	Margin (dB)	Remark
1	10480.000	49.38	0.40	49.78	68.30	-18.52	peak
2	15720.000	44.45	6.10	50.55	54.00	-3.45	peak



Unless otherwise agreed in writing, this document is issued by the Company subject to its General Conditions of Service printed overleaf, available on request or accessible at <http://www.sgs.com/en/Terms-and-Conditions.aspx> and, for electronic format documents, subject to Terms and Conditions for Electronic Documents at <http://www.sgs.com/en/Terms-and-Conditions/Terms-e-Documents.aspx>. Attention is drawn to the limitation of liability, indemnification and jurisdiction issues defined therein. Any holder of this document is advised that information contained hereon reflects the Company's findings at the time of its intervention only and within the limits of Client's instructions, if any. The Company's sole responsibility is to its Client and this document does not exonerate parties to a transaction from exercising all their rights and obligations under the transaction documents. This document cannot be reproduced except in full, without prior written approval of the Company. Any unauthorized alteration, forgery or falsification of the content or appearance of this document is unlawful and offenders may be prosecuted to the fullest extent of the law. Unless otherwise stated the results shown in this test report refer only to the sample(s) tested and such sample(s) are retained for 30 days only.  
**Attention: To check the authenticity of testing /inspection report & certificate, please contact us at telephone: (86-755) 8307 1443, or email: CN.Doccheck@sgs.com**

No.10, Weiye Road, Innovation Park, Kunshan, Jiangsu, China 215300  
 中国·江苏·昆山市留学生创业园伟业路10号 邮编 215300

t(86-512)57355888 f(86-512)57370818 www.sgsgroup.com.cn  
 t(86-512)57355888 f(86-512)57370818 sgs.china@sgs.com

Test Mode: 01; Polarity: Horizontal; Modulation:802.11n; Bandwidth:40MHz; Channel:Low

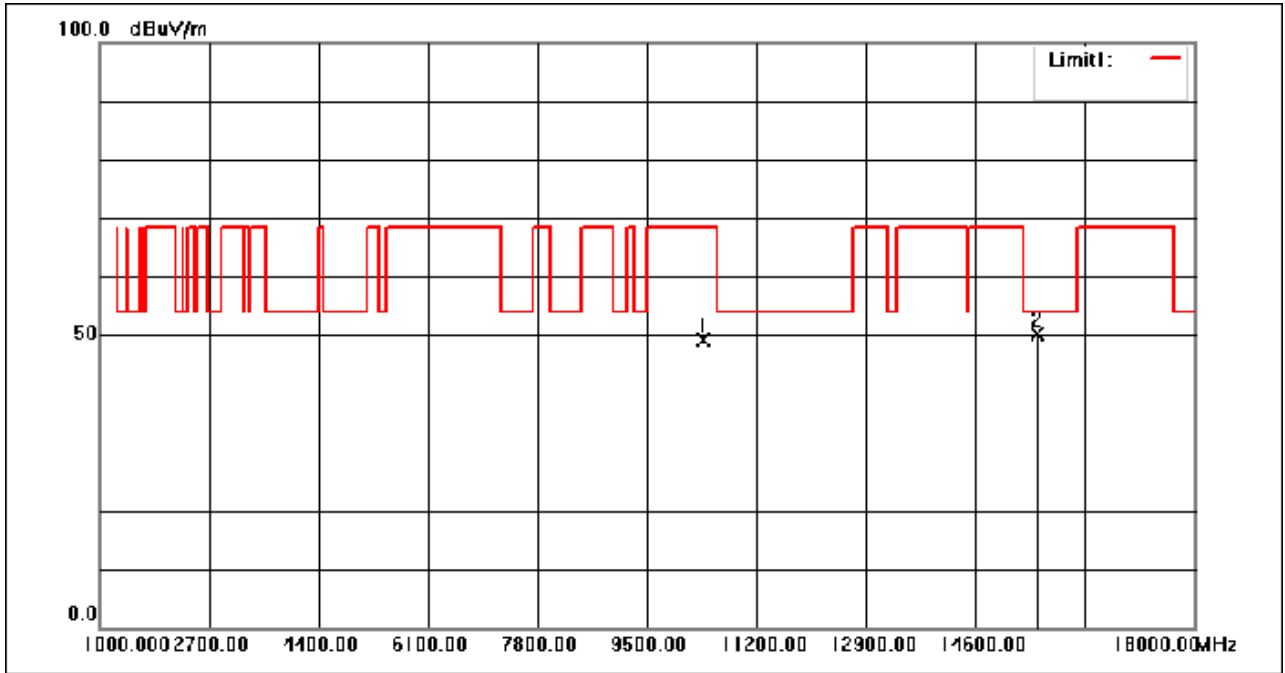

No.	Frequency (MHz)	Reading (dBuV)	Correction factor(dB/m)	Result (dBuV/m)	Limit (dBuV/m)	Margin (dB)	Remark
1	10380.000	48.92	0.20	49.12	68.30	-19.18	peak
2	15570.000	44.35	5.79	50.14	54.00	-3.86	peak



Unless otherwise agreed in writing, this document is issued by the Company subject to its General Conditions of Service printed overleaf, available on request or accessible at <http://www.sgs.com/en/Terms-and-Conditions.aspx> and, for electronic format documents, subject to Terms and Conditions for Electronic Documents at <http://www.sgs.com/en/Terms-and-Conditions/Terms-e-Document.aspx>. Attention is drawn to the limitation of liability, indemnification and jurisdiction issues defined therein. Any holder of this document is advised that information contained hereon reflects the Company's findings at the time of its intervention only and within the limits of Client's instructions, if any. The Company's sole responsibility is to its Client and this document does not exonerate parties to a transaction from exercising all their rights and obligations under the transaction documents. This document cannot be reproduced except in full, without prior written approval of the Company. Any unauthorized alteration, forgery or falsification of the content or appearance of this document is unlawful and offenders may be prosecuted to the fullest extent of the law. Unless otherwise stated the results shown in this test report refer only to the sample(s) tested and such sample(s) are retained for 30 days only.  
**Attention: To check the authenticity of testing /inspection report & certificate, please contact us at telephone: (86-755) 8307 1443, or email: CN\_Doccheck@sgs.com**

No.10, Weiye Road, Innovation Park, Kunshan, Jiangsu, China 215300  
 中国·江苏·昆山市留学生创业园伟业路10号 邮编 215300

t(86-512)57355888 f(86-512)57370818 www.sgs.com.cn  
 t(86-512)57355888 f(86-512)57370818 sgs.china@sgs.com

Test Mode: 01; Polarity: Vertical; Modulation:802.11n; Bandwidth:40MHz; Channel:Low

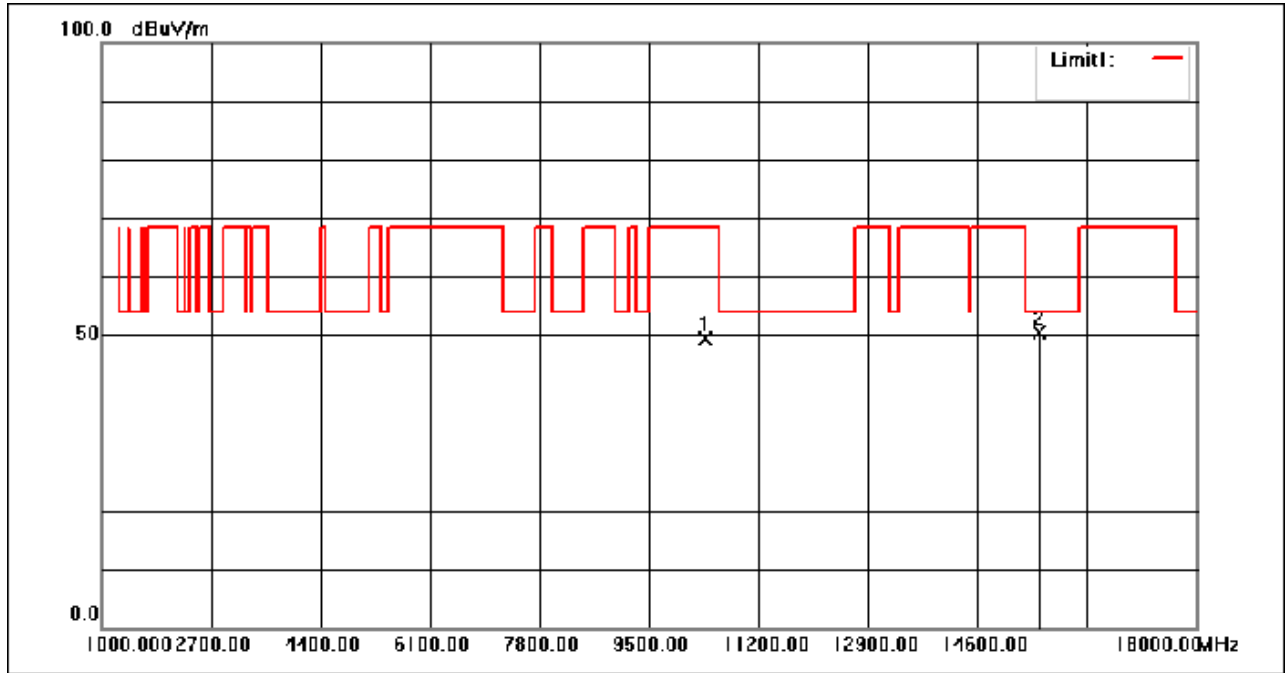

No.	Frequency (MHz)	Reading (dBuV)	Correction factor(dB/m)	Result (dBuV/m)	Limit (dBuV/m)	Margin (dB)	Remark
1	10380.000	49.27	0.20	49.47	68.30	-18.83	peak
2	15570.000	44.49	5.79	50.28	54.00	-3.72	peak



Unless otherwise agreed in writing, this document is issued by the Company subject to its General Conditions of Service printed overleaf, available on request or accessible at <http://www.sgs.com/en/Terms-and-Conditions.aspx> and, for electronic format documents, subject to Terms and Conditions for Electronic Documents at <http://www.sgs.com/en/Terms-and-Conditions/Terms-e-Documents.aspx>. Attention is drawn to the limitation of liability, indemnification and jurisdiction issues defined therein. Any holder of this document is advised that information contained hereon reflects the Company's findings at the time of its intervention only and within the limits of Client's instructions, if any. The Company's sole responsibility is to its Client and this document does not exonerate parties to a transaction from exercising all their rights and obligations under the transaction documents. This document cannot be reproduced except in full, without prior written approval of the Company. Any unauthorized alteration, forgery or falsification of the content or appearance of this document is unlawful and offenders may be prosecuted to the fullest extent of the law. Unless otherwise stated the results shown in this test report refer only to the sample(s) tested and such sample(s) are retained for 30 days only.  
**Attention: To check the authenticity of testing /inspection report & certificate, please contact us at telephone: (86-755) 8307 1443, or email: CN.Doccheck@sgs.com**

No.10, Weiye Road, Innovation Park, Kunshan, Jiangsu, China 215300  
 中国·江苏·昆山市留学生创业园伟业路10号 邮编 215300

t(86-512)57355888 f(86-512)57370818 www.sgs.com.cn  
 t(86-512)57355888 f(86-512)57370818 sgs.china@sgs.com



Test Mode: 01; Polarity: Horizontal; Modulation:802.11n; Bandwidth:40MHz; Channel:High

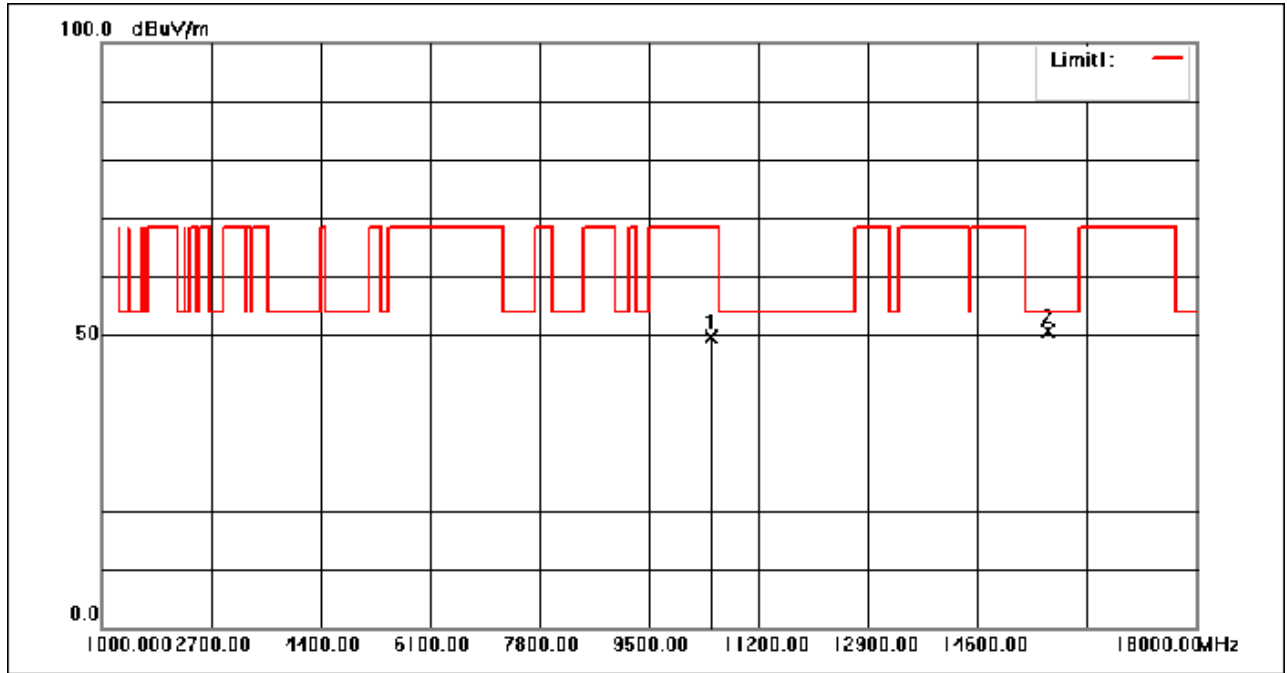

No.	Frequency (MHz)	Reading (dBuV)	Correction factor(dB/m)	Result (dBuV/m)	Limit (dBuV/m)	Margin (dB)	Remark
1	10460.000	49.36	0.36	49.72	68.30	-18.58	peak
2	15690.000	44.61	6.04	50.65	54.00	-3.35	peak



Unless otherwise agreed in writing, this document is issued by the Company subject to its General Conditions of Service printed overleaf, available on request or accessible at <http://www.sgs.com/en/Terms-and-Conditions.aspx> and, for electronic format documents, subject to Terms and Conditions for Electronic Documents at <http://www.sgs.com/en/Terms-and-Conditions/Terms-e-Documents.aspx>. Attention is drawn to the limitation of liability, indemnification and jurisdiction issues defined therein. Any holder of this document is advised that information contained hereon reflects the Company's findings at the time of its intervention only and within the limits of Client's instructions, if any. The Company's sole responsibility is to its Client and this document does not exonerate parties to a transaction from exercising all their rights and obligations under the transaction documents. This document cannot be reproduced except in full, without prior written approval of the Company. Any unauthorized alteration, forgery or falsification of the content or appearance of this document is unlawful and offenders may be prosecuted to the fullest extent of the law. Unless otherwise stated the results shown in this test report refer only to the sample(s) tested and such sample(s) are retained for 30 days only.  
**Attention: To check the authenticity of testing /inspection report & certificate, please contact us at telephone: (86-755) 8307 1443, or email: CN.Doccheck@sgs.com**

No.10, Weiye Road, Innovation Park, Kunshan, Jiangsu, China 215300  
 中国·江苏·昆山市留学生创业园伟业路10号 邮编 215300

t(86-512)57355888 f(86-512)57370818 www.sgs.com.cn  
 t(86-512)57355888 f(86-512)57370818 sgs.china@sgs.com

Test Mode: 01; Polarity: Vertical; Modulation:802.11n; Bandwidth:40MHz; Channel:High

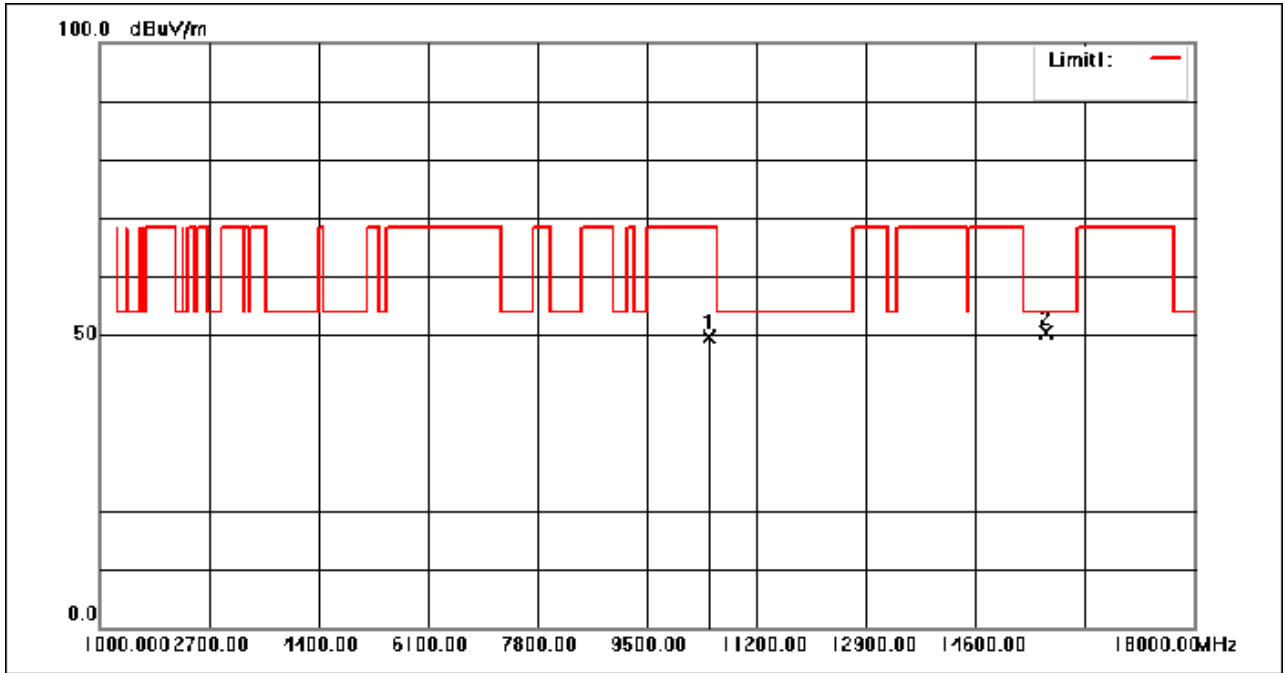

No.	Frequency (MHz)	Reading (dBuV)	Correction factor(dB/m)	Result (dBuV/m)	Limit (dBuV/m)	Margin (dB)	Remark
1	10460.000	49.31	0.36	49.67	68.30	-18.63	peak
2	15690.000	44.40	6.04	50.44	54.00	-3.56	peak



Unless otherwise agreed in writing, this document is issued by the Company subject to its General Conditions of Service printed overleaf, available on request or accessible at <http://www.sgs.com/en/Terms-and-Conditions.aspx> and, for electronic format documents, subject to Terms and Conditions for Electronic Documents at <http://www.sgs.com/en/Terms-and-Conditions/Terms-e-Documents.aspx>. Attention is drawn to the limitation of liability, indemnification and jurisdiction issues defined therein. Any holder of this document is advised that information contained hereon reflects the Company's findings at the time of its intervention only and within the limits of Client's instructions, if any. The Company's sole responsibility is to its Client and this document does not exonerate parties to a transaction from exercising all their rights and obligations under the transaction documents. This document cannot be reproduced except in full, without prior written approval of the Company. Any unauthorized alteration, forgery or falsification of the content or appearance of this document is unlawful and offenders may be prosecuted to the fullest extent of the law. Unless otherwise stated the results shown in this test report refer only to the sample(s) tested and such sample(s) are retained for 30 days only.  
**Attention: To check the authenticity of testing /inspection report & certificate, please contact us at telephone: (86-755) 8307 1443, or email: CN.Doccheck@sgs.com**

No.10, Weiye Road, Innovation Park, Kunshan, Jiangsu, China 215300  
 中国·江苏·昆山市留学生创业园伟业路10号 邮编 215300

t(86-512)57355888 f(86-512)57370818 www.sgs.com.cn  
 t(86-512)57355888 f(86-512)57370818 sgs.china@sgs.com

Test Mode: 01; Polarity: Horizontal; Modulation:802.11ac; Bandwidth:20MHz; Channel:Low

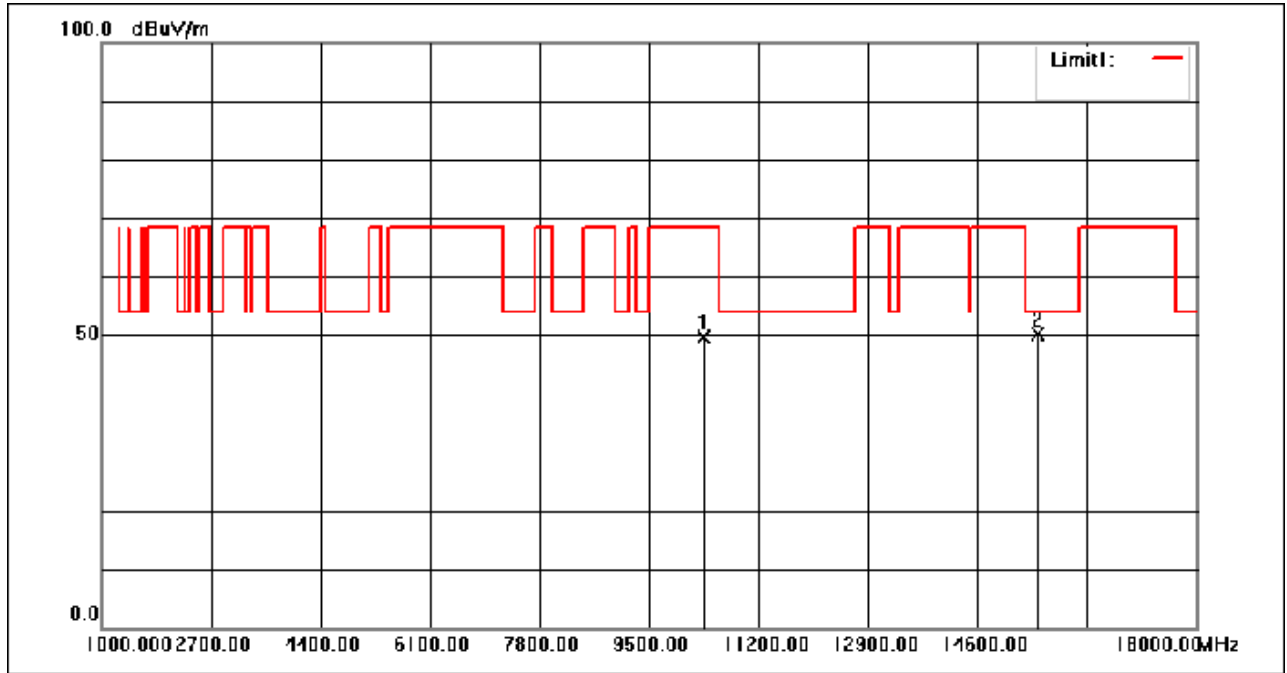

No.	Frequency (MHz)	Reading (dBuV)	Correction factor(dB/m)	Result (dBuV/m)	Limit (dBuV/m)	Margin (dB)	Remark
1	10360.000	49.54	0.16	49.70	68.30	-18.60	peak
2	15540.000	44.48	5.73	50.21	54.00	-3.79	peak



Unless otherwise agreed in writing, this document is issued by the Company subject to its General Conditions of Service printed overleaf, available on request or accessible at <http://www.sgs.com/en/Terms-and-Conditions.aspx> and, for electronic format documents, subject to Terms and Conditions for Electronic Documents at <http://www.sgs.com/en/Terms-and-Conditions/Terms-e-Documents.aspx>. Attention is drawn to the limitation of liability, indemnification and jurisdiction issues defined therein. Any holder of this document is advised that information contained hereon reflects the Company's findings at the time of its intervention only and within the limits of Client's instructions, if any. The Company's sole responsibility is to its Client and this document does not exonerate parties to a transaction from exercising all their rights and obligations under the transaction documents. This document cannot be reproduced except in full, without prior written approval of the Company. Any unauthorized alteration, forgery or falsification of the content or appearance of this document is unlawful and offenders may be prosecuted to the fullest extent of the law. Unless otherwise stated the results shown in this test report refer only to the sample(s) tested and such sample(s) are retained for 30 days only.  
**Attention: To check the authenticity of testing /inspection report & certificate, please contact us at telephone: (86-755) 8307 1443, or email: CN.Doccheck@sgs.com**

No.10, Weiye Road, Innovation Park, Kunshan, Jiangsu, China 215300  
 中国·江苏·昆山市留学生创业园伟业路10号 邮编 215300

t(86-512)57355888 f(86-512)57370818 www.sgs.com.cn  
 t(86-512)57355888 f(86-512)57370818 sgs.china@sgs.com

Test Mode: 01; Polarity: Vertical; Modulation:802.11ac; Bandwidth:20MHz; Channel:Low

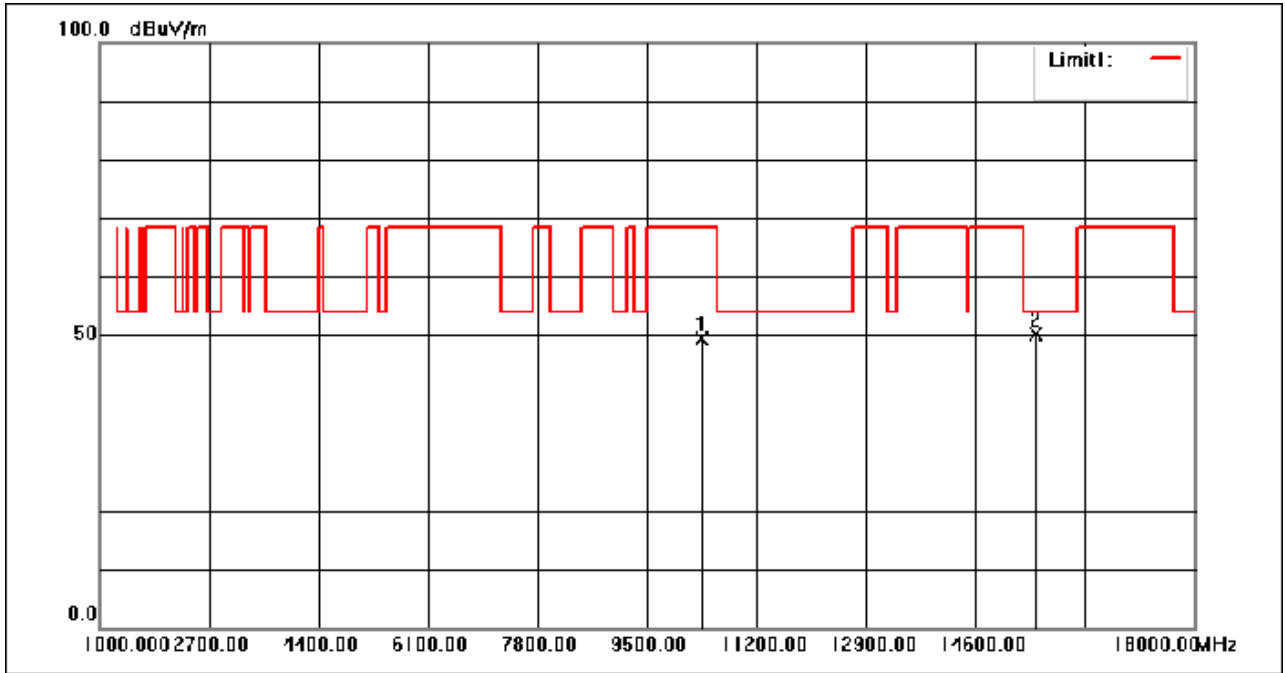

No.	Frequency (MHz)	Reading (dBuV)	Correction factor(dB/m)	Result (dBuV/m)	Limit (dBuV/m)	Margin (dB)	Remark
1	10360.000	49.34	0.16	49.50	68.30	-18.80	peak
2	15540.000	44.45	5.73	50.18	54.00	-3.82	peak



Unless otherwise agreed in writing, this document is issued by the Company subject to its General Conditions of Service printed overleaf, available on request or accessible at <http://www.sgs.com/en/Terms-and-Conditions.aspx> and, for electronic format documents, subject to Terms and Conditions for Electronic Documents at <http://www.sgs.com/en/Terms-and-Conditions/Terms-e-Documents.aspx>. Attention is drawn to the limitation of liability, indemnification and jurisdiction issues defined therein. Any holder of this document is advised that information contained hereon reflects the Company's findings at the time of its intervention only and within the limits of Client's instructions, if any. The Company's sole responsibility is to its Client and this document does not exonerate parties to a transaction from exercising all their rights and obligations under the transaction documents. This document cannot be reproduced except in full, without prior written approval of the Company. Any unauthorized alteration, forgery or falsification of the content or appearance of this document is unlawful and offenders may be prosecuted to the fullest extent of the law. Unless otherwise stated the results shown in this test report refer only to the sample(s) tested and such sample(s) are retained for 30 days only.  
Attention: To check the authenticity of testing /inspection report & certificate, please contact us at telephone: (86-755) 8307 1443, or email: [CN.Doccheck@sgs.com](mailto:CN.Doccheck@sgs.com)

No.10, Weiye Road, Innovation Park, Kunshan, Jiangsu, China 215300  
中国·江苏·昆山市留学生创业园伟业路10号 邮编 215300

t(86-512)57355888 f(86-512)57370818 www.sgsgroup.com.cn  
t(86-512)57355888 f(86-512)57370818 sgs.china@sgs.com



Test Mode: 01; Polarity: Horizontal; Modulation:802.11ac; Bandwidth:20MHz; Channel:middle

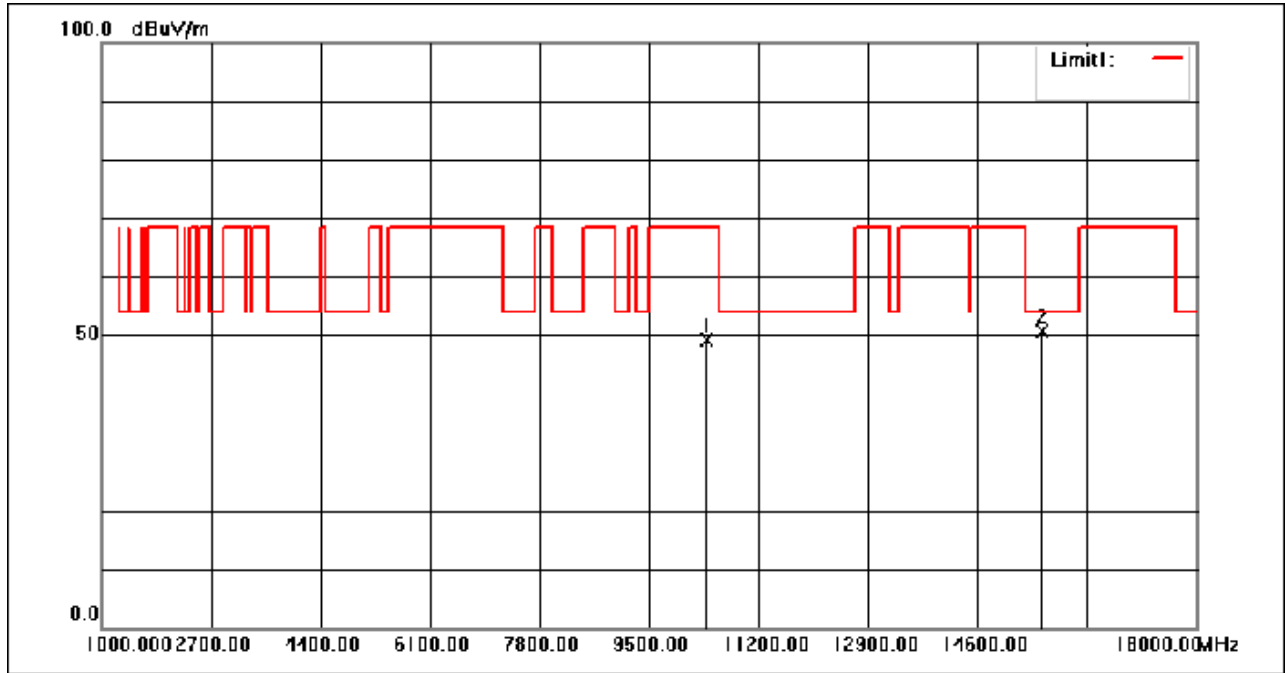

No.	Frequency (MHz)	Reading (dBuV)	Correction factor(dB/m)	Result (dBuV/m)	Limit (dBuV/m)	Margin (dB)	Remark
1	10400.000	48.86	0.24	49.10	68.30	-19.20	peak
2	15600.000	44.71	5.85	50.56	54.00	-3.44	peak



Unless otherwise agreed in writing, this document is issued by the Company subject to its General Conditions of Service printed overleaf, available on request or accessible at <http://www.sgs.com/en/Terms-and-Conditions.aspx> and, for electronic format documents, subject to Terms and Conditions for Electronic Documents at <http://www.sgs.com/en/Terms-and-Conditions/Terms-e-Documents.aspx>. Attention is drawn to the limitation of liability, indemnification and jurisdiction issues defined therein. Any holder of this document is advised that information contained hereon reflects the Company's findings at the time of its intervention only and within the limits of Client's instructions, if any. The Company's sole responsibility is to its Client and this document does not exonerate parties to a transaction from exercising all their rights and obligations under the transaction documents. This document cannot be reproduced except in full, without prior written approval of the Company. Any unauthorized alteration, forgery or falsification of the content or appearance of this document is unlawful and offenders may be prosecuted to the fullest extent of the law. Unless otherwise stated the results shown in this test report refer only to the sample(s) tested and such sample(s) are retained for 30 days only.  
**Attention: To check the authenticity of testing /inspection report & certificate, please contact us at telephone: (86-755) 8307 1443, or email: CN.Doccheck@sgs.com**

No.10, Weiye Road, Innovation Park, Kunshan, Jiangsu, China 215300  
 中国·江苏·昆山市留学生创业园伟业路10号 邮编 215300

t(86-512)57355888 f(86-512)57370818 www.sgs.com.cn  
 t(86-512)57355888 f(86-512)57370818 sgs.china@sgs.com

Test Mode: 01; Polarity: Vertical; Modulation:802.11ac; Bandwidth:20MHz; Channel:middle

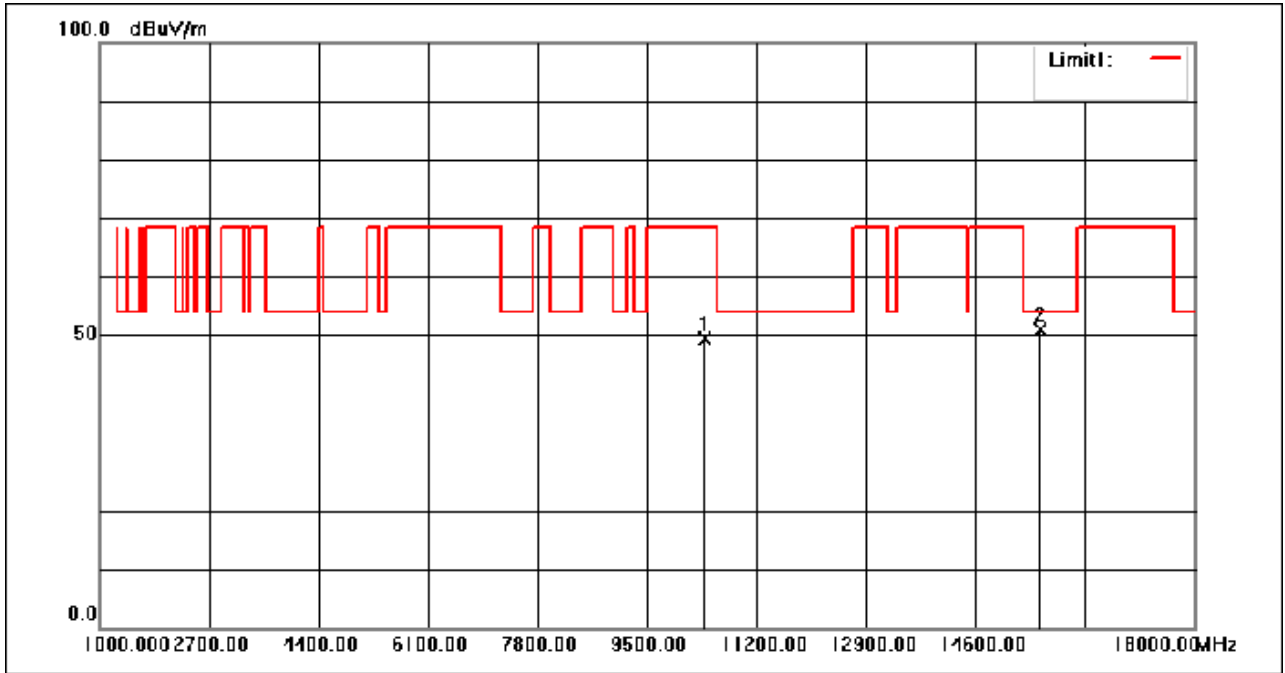

No.	Frequency (MHz)	Reading (dBuV)	Correction factor(dB/m)	Result (dBuV/m)	Limit (dBuV/m)	Margin (dB)	Remark
1	10400.000	49.12	0.24	49.36	68.30	-18.94	peak
2	15600.000	44.96	5.85	50.81	54.00	-3.19	peak



Unless otherwise agreed in writing, this document is issued by the Company subject to its General Conditions of Service printed overleaf, available on request or accessible at <http://www.sgs.com/en/Terms-and-Conditions.aspx> and, for electronic format documents, subject to Terms and Conditions for Electronic Documents at <http://www.sgs.com/en/Terms-and-Conditions/Terms-e-Documents.aspx>. Attention is drawn to the limitation of liability, indemnification and jurisdiction issues defined therein. Any holder of this document is advised that information contained hereon reflects the Company's findings at the time of its intervention only and within the limits of Client's instructions, if any. The Company's sole responsibility is to its Client and this document does not exonerate parties to a transaction from exercising all their rights and obligations under the transaction documents. This document cannot be reproduced except in full, without prior written approval of the Company. Any unauthorized alteration, forgery or falsification of the content or appearance of this document is unlawful and offenders may be prosecuted to the fullest extent of the law. Unless otherwise stated the results shown in this test report refer only to the sample(s) tested and such sample(s) are retained for 30 days only.  
Attention: To check the authenticity of testing /inspection report & certificate, please contact us at telephone: (86-755) 8307 1443, or email: [CN.Doccheck@sgs.com](mailto:CN.Doccheck@sgs.com)

No.10, Weiye Road, Innovation Park, Kunshan, Jiangsu, China 215300  
中国·江苏·昆山市留学生创业园伟业路10号 邮编 215300

t(86-512)57355888 f(86-512)57370818 www.sgsgroup.com.cn  
t(86-512)57355888 f(86-512)57370818 sgs.china@sgs.com

## Compliance Certification Services (Kunshan) Inc.

Report No.: KSCR221000189002

Page: 55 of 607

Test Mode: 01; Polarity: Horizontal; Modulation:802.11ac; Bandwidth:20MHz; Channel:High

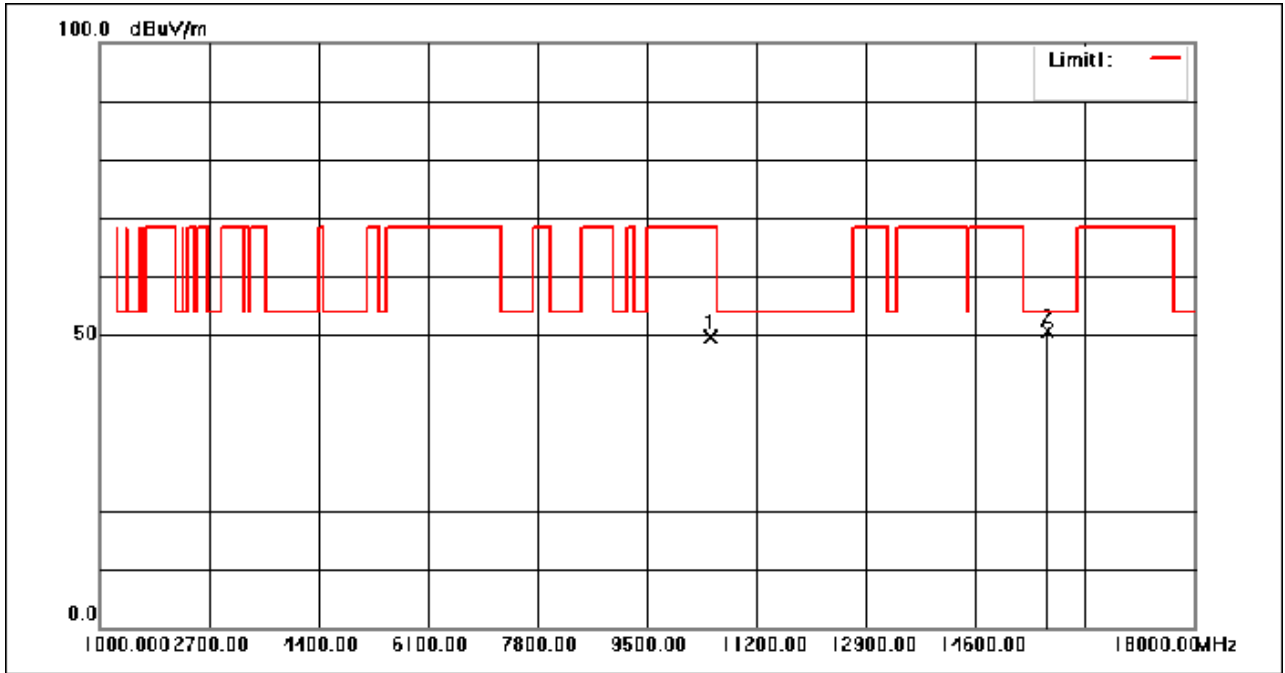

No.	Frequency (MHz)	Reading (dBuV)	Correction factor(dB/m)	Result (dBuV/m)	Limit (dBuV/m)	Margin (dB)	Remark
1	10480.000	49.18	0.40	49.58	68.30	-18.72	peak
2	15720.000	44.46	6.10	50.56	54.00	-3.44	peak



Unless otherwise agreed in writing, this document is issued by the Company subject to its General Conditions of Service printed overleaf, available on request or accessible at <http://www.sgs.com/en/Terms-and-Conditions.aspx> and, for electronic format documents, subject to Terms and Conditions for Electronic Documents at <http://www.sgs.com/en/Terms-and-Conditions/Terms-e-Documents.aspx>. Attention is drawn to the limitation of liability, indemnification and jurisdiction issues defined therein. Any holder of this document is advised that information contained hereon reflects the Company's findings at the time of its intervention only and within the limits of Client's instructions, if any. The Company's sole responsibility is to its Client and this document does not exonerate parties to a transaction from exercising all their rights and obligations under the transaction documents. This document cannot be reproduced except in full, without prior written approval of the Company. Any unauthorized alteration, forgery or falsification of the content or appearance of this document is unlawful and offenders may be prosecuted to the fullest extent of the law. Unless otherwise stated the results shown in this test report refer only to the sample(s) tested and such sample(s) are retained for 30 days only.  
Attention: To check the authenticity of testing /inspection report & certificate, please contact us at telephone: (86-755) 8307 1443, or email: [CN\\_Doccheck@sgs.com](mailto:CN_Doccheck@sgs.com)

No.10, Weiye Road, Innovation Park, Kunshan, Jiangsu, China 215300  
中国·江苏·昆山市留学生创业园伟业路10号 邮编 215300

t(86-512)57355888 f(86-512)57370818 www.sgsgroup.com.cn  
t(86-512)57355888 f(86-512)57370818 sgs.china@sgs.com

Test Mode: 01; Polarity: Vertical; Modulation:802.11ac; Bandwidth:20MHz; Channel:High

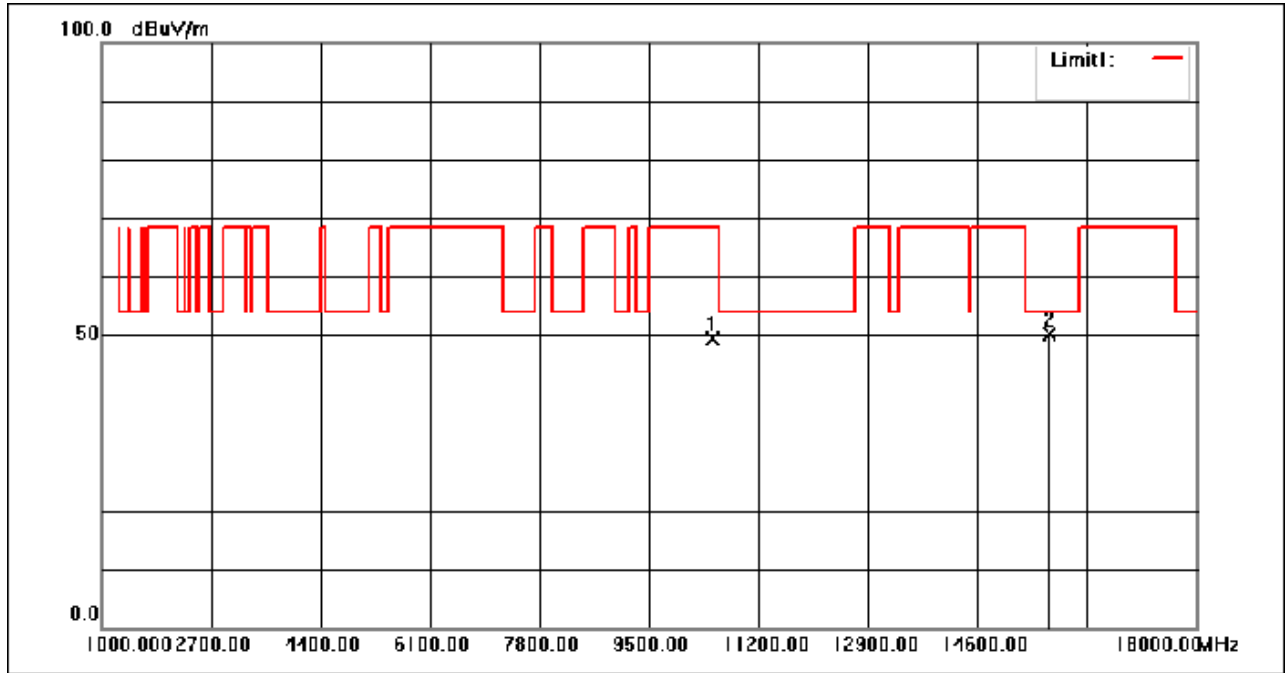

No.	Frequency (MHz)	Reading (dBuV)	Correction factor(dB/m)	Result (dBuV/m)	Limit (dBuV/m)	Margin (dB)	Remark
1	10480.000	49.10	0.40	49.50	68.30	-18.80	peak
2	15720.000	43.96	6.10	50.06	54.00	-3.94	peak



Unless otherwise agreed in writing, this document is issued by the Company subject to its General Conditions of Service printed overleaf, available on request or accessible at <http://www.sgs.com/en/Terms-and-Conditions.aspx> and, for electronic format documents, subject to Terms and Conditions for Electronic Documents at <http://www.sgs.com/en/Terms-and-Conditions/Terms-e-Document.aspx>. Attention is drawn to the limitation of liability, indemnification and jurisdiction issues defined therein. Any holder of this document is advised that information contained hereon reflects the Company's findings at the time of its intervention only and within the limits of Client's instructions, if any. The Company's sole responsibility is to its Client and this document does not exonerate parties to a transaction from exercising all their rights and obligations under the transaction documents. This document cannot be reproduced except in full, without prior written approval of the Company. Any unauthorized alteration, forgery or falsification of the content or appearance of this document is unlawful and offenders may be prosecuted to the fullest extent of the law. Unless otherwise stated the results shown in this test report refer only to the sample(s) tested and such sample(s) are retained for 30 days only.  
**Attention: To check the authenticity of testing /inspection report & certificate, please contact us at telephone: (86-755) 8307 1443, or email: CN.Doccheck@sgs.com**

No.10, Weiye Road, Innovation Park, Kunshan, Jiangsu, China 215300  
 中国·江苏·昆山市留学生创业园伟业路10号 邮编 215300

t(86-512)57355888 f(86-512)57370818 www.sgsgroup.com.cn  
 t(86-512)57355888 f(86-512)57370818 sgs.china@sgs.com



Test Mode: 01; Polarity: Horizontal; Modulation:802.11ac; Bandwidth:40MHz; Channel:Low

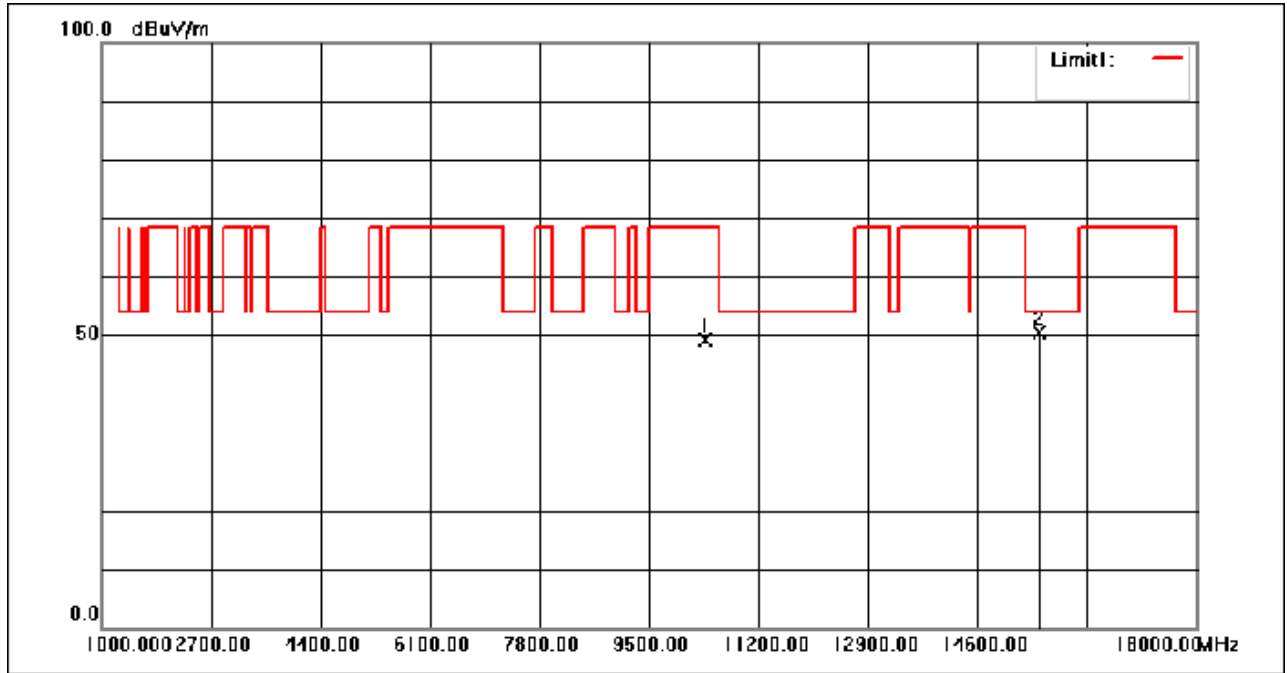

No.	Frequency (MHz)	Reading (dBuV)	Correction factor(dB/m)	Result (dBuV/m)	Limit (dBuV/m)	Margin (dB)	Remark
1	10380.000	48.98	0.20	49.18	68.30	-19.12	peak
2	15570.000	44.53	5.79	50.32	54.00	-3.68	peak



Unless otherwise agreed in writing, this document is issued by the Company subject to its General Conditions of Service printed overleaf, available on request or accessible at <http://www.sgs.com/en/Terms-and-Conditions.aspx> and, for electronic format documents, subject to Terms and Conditions for Electronic Documents at <http://www.sgs.com/en/Terms-and-Conditions/Terms-e-Documents.aspx>. Attention is drawn to the limitation of liability, indemnification and jurisdiction issues defined therein. Any holder of this document is advised that information contained hereon reflects the Company's findings at the time of its intervention only and within the limits of Client's instructions, if any. The Company's sole responsibility is to its Client and this document does not exonerate parties to a transaction from exercising all their rights and obligations under the transaction documents. This document cannot be reproduced except in full, without prior written approval of the Company. Any unauthorized alteration, forgery or falsification of the content or appearance of this document is unlawful and offenders may be prosecuted to the fullest extent of the law. Unless otherwise stated the results shown in this test report refer only to the sample(s) tested and such sample(s) are retained for 30 days only.  
**Attention: To check the authenticity of testing /inspection report & certificate, please contact us at telephone: (86-755) 8307 1443, or email: CN.Doccheck@sgs.com**

No.10, Weiye Road, Innovation Park, Kunshan, Jiangsu, China 215300  
 中国·江苏·昆山市留学生创业园伟业路10号 邮编 215300

t(86-512)57355888 f(86-512)57370818 www.sgsgroup.com.cn  
 t(86-512)57355888 f(86-512)57370818 sgs.china@sgs.com

## Compliance Certification Services (Kunshan) Inc.

Report No.: KSCR221000189002

Page: 58 of 607

Test Mode: 01; Polarity: Vertical; Modulation:802.11ac; Bandwidth:40MHz; Channel:Low

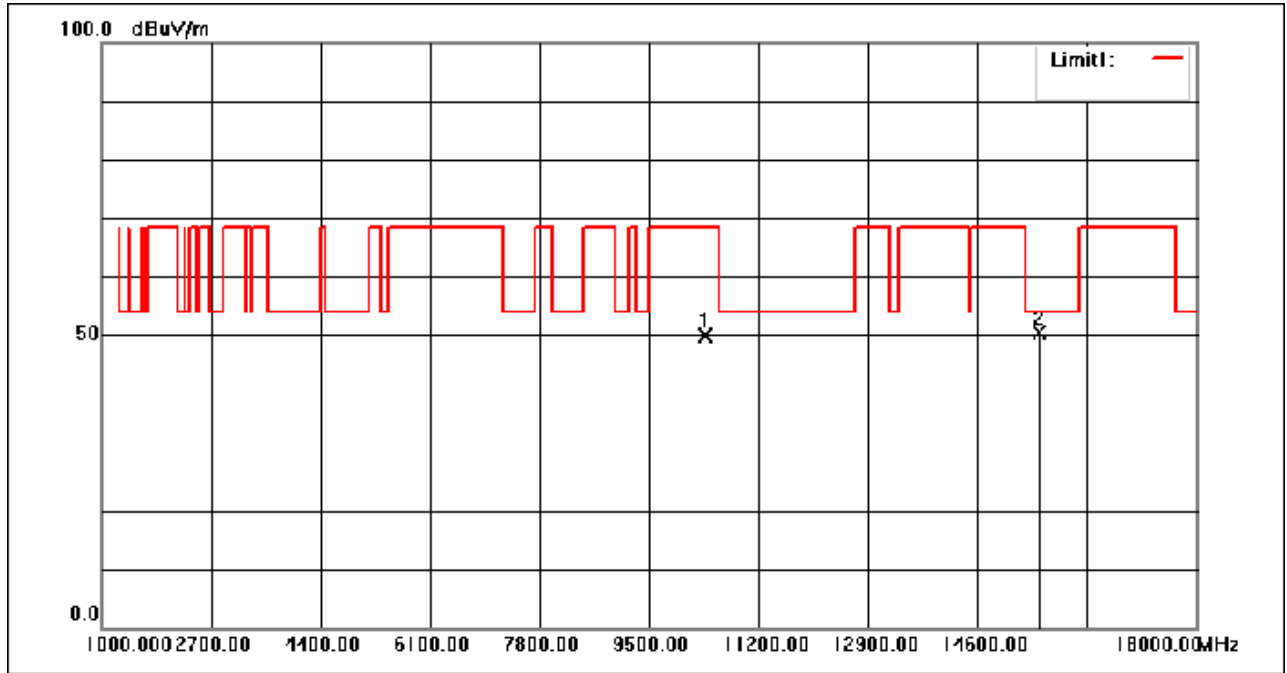

No.	Frequency (MHz)	Reading (dBuV)	Correction factor(dB/m)	Result (dBuV/m)	Limit (dBuV/m)	Margin (dB)	Remark
1	10380.000	49.56	0.20	49.76	68.30	-18.54	peak
2	15570.000	44.67	5.79	50.46	54.00	-3.54	peak



Unless otherwise agreed in writing, this document is issued by the Company subject to its General Conditions of Service printed overleaf, available on request or accessible at <http://www.sgs.com/en/Terms-and-Conditions.aspx> and, for electronic format documents, subject to Terms and Conditions for Electronic Documents at <http://www.sgs.com/en/Terms-and-Conditions/Terms-e-Documents.aspx>. Attention is drawn to the limitation of liability, indemnification and jurisdiction issues defined therein. Any holder of this document is advised that information contained hereon reflects the Company's findings at the time of its intervention only and within the limits of Client's instructions, if any. The Company's sole responsibility is to its Client and this document does not exonerate parties to a transaction from exercising all their rights and obligations under the transaction documents. This document cannot be reproduced except in full, without prior written approval of the Company. Any unauthorized alteration, forgery or falsification of the content or appearance of this document is unlawful and offenders may be prosecuted to the fullest extent of the law. Unless otherwise stated the results shown in this test report refer only to the sample(s) tested and such sample(s) are retained for 30 days only.  
**Attention: To check the authenticity of testing /inspection report & certificate, please contact us at telephone: (86-755) 8307 1443, or email: CN.Doccheck@sgs.com**

No.10, Weiye Road, Innovation Park, Kunshan, Jiangsu, China 215300  
 中国·江苏·昆山市留学生创业园伟业路10号 邮编 215300

t(86-512)57355888 f(86-512)57370818 www.sgs.com.cn  
 t(86-512)57355888 f(86-512)57370818 sgs.china@sgs.com

Test Mode: 01; Polarity: Horizontal; Modulation:802.11ac; Bandwidth:40MHz; Channel:High

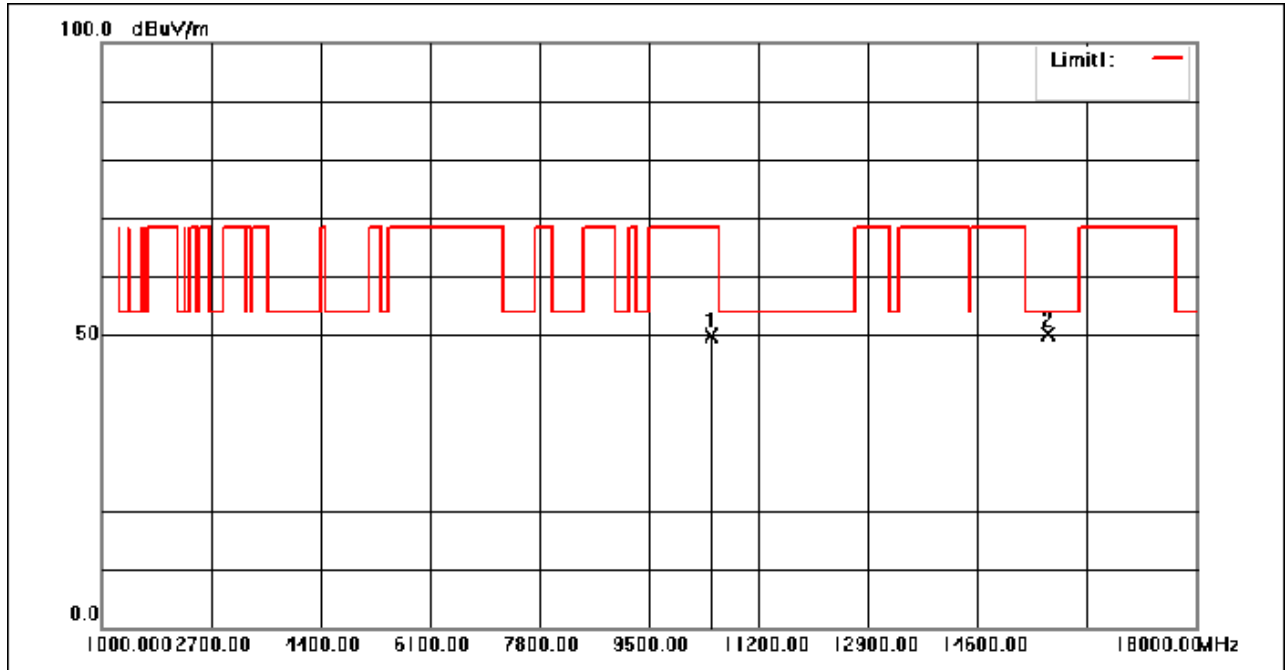

No.	Frequency (MHz)	Reading (dBuV)	Correction factor(dB/m)	Result (dBuV/m)	Limit (dBuV/m)	Margin (dB)	Remark
1	10460.000	49.42	0.36	49.78	68.30	-18.52	peak
2	15690.000	43.98	6.04	50.02	54.00	-3.98	peak



Unless otherwise agreed in writing, this document is issued by the Company subject to its General Conditions of Service printed overleaf, available on request or accessible at <http://www.sgs.com/en/Terms-and-Conditions.aspx> and, for electronic format documents, subject to Terms and Conditions for Electronic Documents at <http://www.sgs.com/en/Terms-and-Conditions/Terms-e-Documents.aspx>. Attention is drawn to the limitation of liability, indemnification and jurisdiction issues defined therein. Any holder of this document is advised that information contained hereon reflects the Company's findings at the time of its intervention only and within the limits of Client's instructions, if any. The Company's sole responsibility is to its Client and this document does not exonerate parties to a transaction from exercising all their rights and obligations under the transaction documents. This document cannot be reproduced except in full, without prior written approval of the Company. Any unauthorized alteration, forgery or falsification of the content or appearance of this document is unlawful and offenders may be prosecuted to the fullest extent of the law. Unless otherwise stated the results shown in this test report refer only to the sample(s) tested and such sample(s) are retained for 30 days only.  
**Attention: To check the authenticity of testing /inspection report & certificate, please contact us at telephone: (86-755) 8307 1443, or email: CN.Doccheck@sgs.com**

No.10, Weiye Road, Innovation Park, Kunshan, Jiangsu, China 215300  
 中国·江苏·昆山市留学生创业园伟业路10号 邮编 215300

t(86-512)57355888 f(86-512)57370818 www.sgsgroup.com.cn  
 t(86-512)57355888 f(86-512)57370818 sgs.china@sgs.com

Test Mode: 01; Polarity: Vertical; Modulation:802.11ac; Bandwidth:40MHz; Channel:High

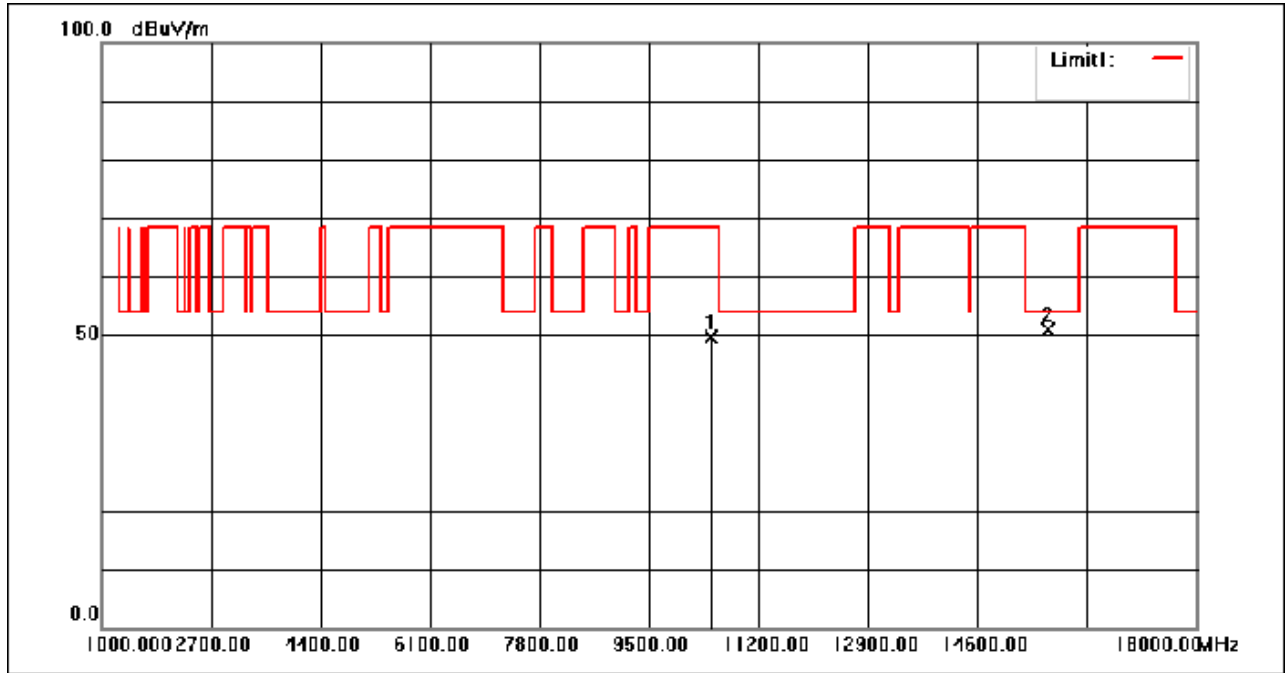

No.	Frequency (MHz)	Reading (dBuV)	Correction factor(dB/m)	Result (dBuV/m)	Limit (dBuV/m)	Margin (dB)	Remark
1	10460.000	49.15	0.36	49.51	68.30	-18.79	peak
2	15690.000	44.90	6.04	50.94	54.00	-3.06	peak



Unless otherwise agreed in writing, this document is issued by the Company subject to its General Conditions of Service printed overleaf, available on request or accessible at <http://www.sgs.com/en/Terms-and-Conditions.aspx> and, for electronic format documents, subject to Terms and Conditions for Electronic Documents at <http://www.sgs.com/en/Terms-and-Conditions/Terms-e-Documents.aspx>. Attention is drawn to the limitation of liability, indemnification and jurisdiction issues defined therein. Any holder of this document is advised that information contained hereon reflects the Company's findings at the time of its intervention only and within the limits of Client's instructions, if any. The Company's sole responsibility is to its Client and this document does not exonerate parties to a transaction from exercising all their rights and obligations under the transaction documents. This document cannot be reproduced except in full, without prior written approval of the Company. Any unauthorized alteration, forgery or falsification of the content or appearance of this document is unlawful and offenders may be prosecuted to the fullest extent of the law. Unless otherwise stated the results shown in this test report refer only to the sample(s) tested and such sample(s) are retained for 30 days only.  
**Attention: To check the authenticity of testing /inspection report & certificate, please contact us at telephone: (86-755) 8307 1443, or email: CN.Doccheck@sgs.com**

No.10, Weiye Road, Innovation Park, Kunshan, Jiangsu, China 215300  
 中国·江苏·昆山市留学生创业园伟业路10号 邮编 215300

t(86-512)57355888 f(86-512)57370818 www.sgsgroup.com.cn  
 t(86-512)57355888 f(86-512)57370818 sgs.china@sgs.com

Test Mode: 01; Polarity: Horizontal; Modulation:802.11ac; Bandwidth:80MHz; Channel:middle

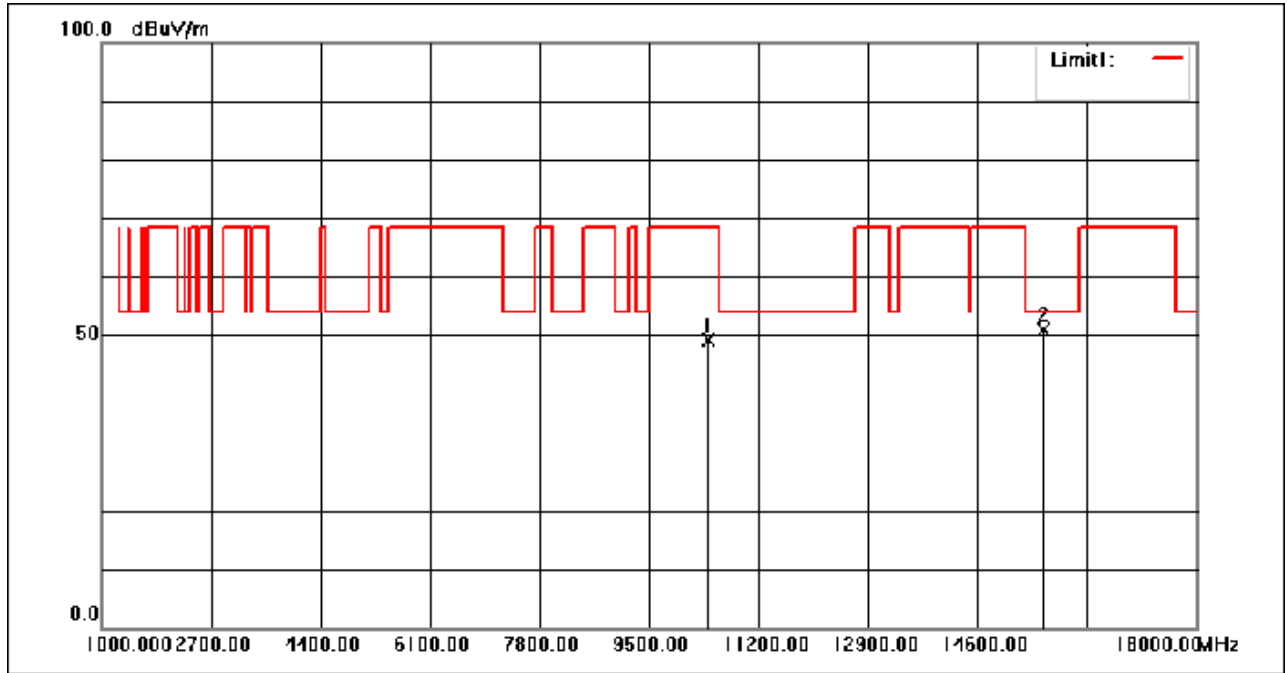

No.	Frequency (MHz)	Reading (dBuV)	Correction factor(dB/m)	Result (dBuV/m)	Limit (dBuV/m)	Margin (dB)	Remark
1	10420.000	48.93	0.28	49.21	68.30	-19.09	peak
2	15630.000	45.01	5.92	50.93	54.00	-3.07	peak



Unless otherwise agreed in writing, this document is issued by the Company subject to its General Conditions of Service printed overleaf, available on request or accessible at <http://www.sgs.com/en/Terms-and-Conditions.aspx> and, for electronic format documents, subject to Terms and Conditions for Electronic Documents at <http://www.sgs.com/en/Terms-and-Conditions/Terms-e-Documents.aspx>. Attention is drawn to the limitation of liability, indemnification and jurisdiction issues defined therein. Any holder of this document is advised that information contained hereon reflects the Company's findings at the time of its intervention only and within the limits of Client's instructions, if any. The Company's sole responsibility is to its Client and this document does not exonerate parties to a transaction from exercising all their rights and obligations under the transaction documents. This document cannot be reproduced except in full, without prior written approval of the Company. Any unauthorized alteration, forgery or falsification of the content or appearance of this document is unlawful and offenders may be prosecuted to the fullest extent of the law. Unless otherwise stated the results shown in this test report refer only to the sample(s) tested and such sample(s) are retained for 30 days only.  
**Attention: To check the authenticity of testing /inspection report & certificate, please contact us at telephone: (86-755) 8307 1443, or email: CN.Doccheck@sgs.com**

No.10, Weiye Road, Innovation Park, Kunshan, Jiangsu, China 215300  
 中国·江苏·昆山市留学生创业园伟业路10号 邮编 215300

t(86-512)57355888 f(86-512)57370818 www.sgs.com.cn  
 t(86-512)57355888 f(86-512)57370818 sgs.china@sgs.com



Test Mode: 01; Polarity: Vertical; Modulation:802.11 ac; Bandwidth:80MHz; Channel:middle

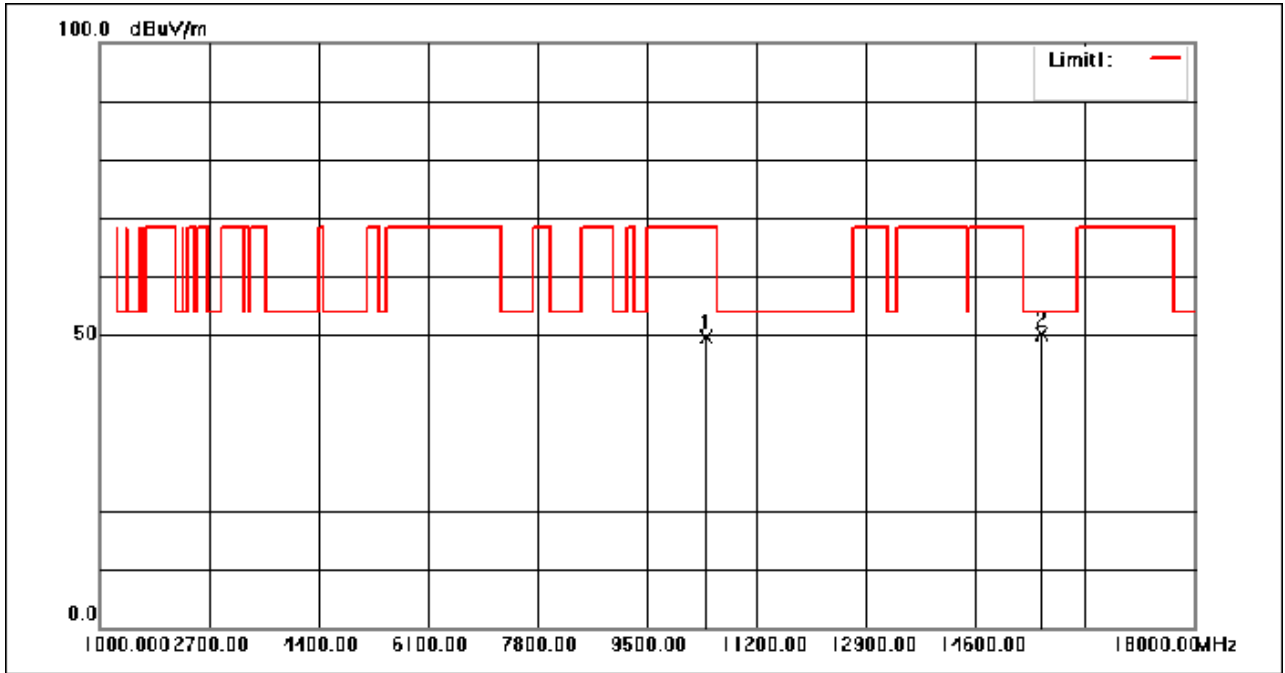

No.	Frequency (MHz)	Reading (dBuV)	Correction factor(dB/m)	Result (dBuV/m)	Limit (dBuV/m)	Margin (dB)	Remark
1	10420.000	49.36	0.28	49.64	68.30	-18.66	peak
2	15630.000	44.14	5.92	50.06	54.00	-3.94	peak



Unless otherwise agreed in writing, this document is issued by the Company subject to its General Conditions of Service printed overleaf, available on request or accessible at <http://www.sgs.com/en/Terms-and-Conditions.aspx> and, for electronic format documents, subject to Terms and Conditions for Electronic Documents at <http://www.sgs.com/en/Terms-and-Conditions/Terms-e-Documents.aspx>. Attention is drawn to the limitation of liability, indemnification and jurisdiction issues defined therein. Any holder of this document is advised that information contained hereon reflects the Company's findings at the time of its intervention only and within the limits of Client's instructions, if any. The Company's sole responsibility is to its Client and this document does not exonerate parties to a transaction from exercising all their rights and obligations under the transaction documents. This document cannot be reproduced except in full, without prior written approval of the Company. Any unauthorized alteration, forgery or falsification of the content or appearance of this document is unlawful and offenders may be prosecuted to the fullest extent of the law. Unless otherwise stated the results shown in this test report refer only to the sample(s) tested and such sample(s) are retained for 30 days only.  
**Attention: To check the authenticity of testing /inspection report & certificate, please contact us at telephone: (86-755) 8307 1443, or email: CN.Doccheck@sgs.com**

No.10, Weiye Road, Innovation Park, Kunshan, Jiangsu, China 215300  
 中国·江苏·昆山市留学生创业园伟业路10号 邮编 215300

t(86-512)57355888 f(86-512)57370818 www.sgsgroup.com.cn  
 t(86-512)57355888 f(86-512)57370818 sgs.china@sgs.com

Test Mode: 02; Polarity: Horizontal; Modulation:802.11a; Bandwidth:20MHz; Channel:Low

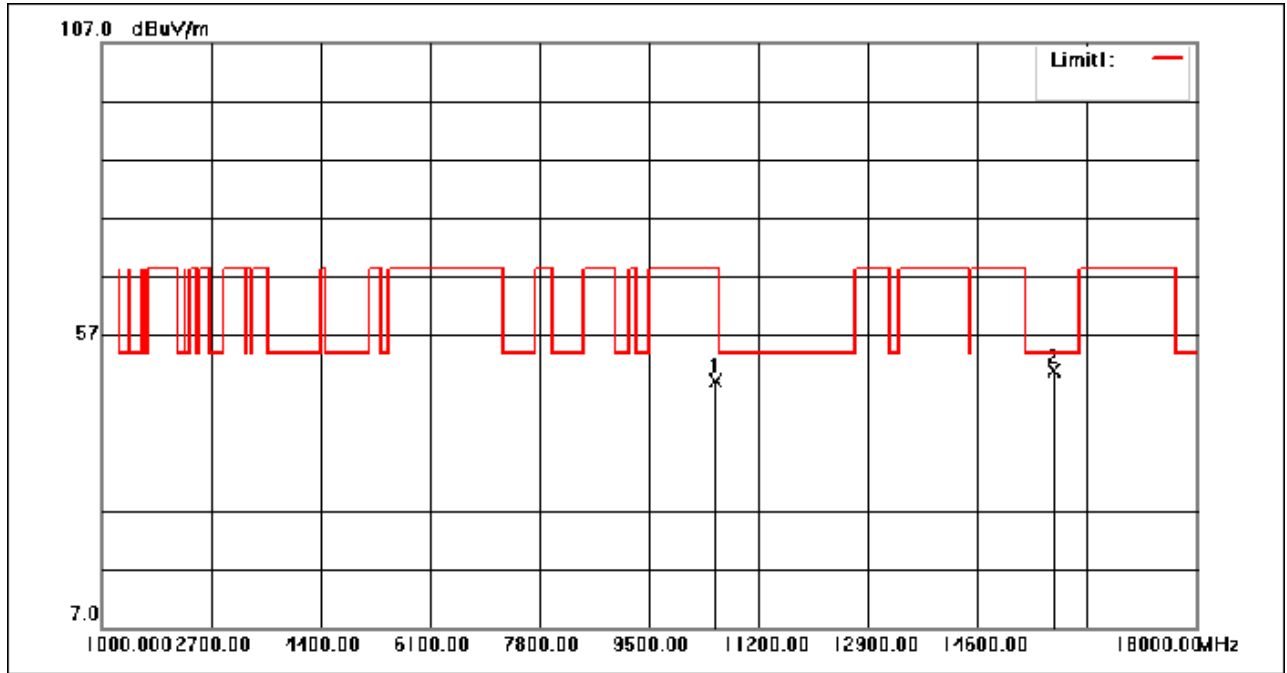

No.	Frequency (MHz)	Reading (dBuV)	Correction factor(dB/m)	Result (dBuV/m)	Limit (dBuV/m)	Margin (dB)	Remark
1	10520.000	48.58	0.44	49.02	68.30	-19.28	peak
2	15780.000	44.70	6.23	50.93	54.00	-3.07	peak



Unless otherwise agreed in writing, this document is issued by the Company subject to its General Conditions of Service printed overleaf, available on request or accessible at <http://www.sgs.com/en/Terms-and-Conditions.aspx> and, for electronic format documents, subject to Terms and Conditions for Electronic Documents at <http://www.sgs.com/en/Terms-and-Conditions/Terms-e-Documents.aspx>. Attention is drawn to the limitation of liability, indemnification and jurisdiction issues defined therein. Any holder of this document is advised that information contained hereon reflects the Company's findings at the time of its intervention only and within the limits of Client's instructions, if any. The Company's sole responsibility is to its Client and this document does not exonerate parties to a transaction from exercising all their rights and obligations under the transaction documents. This document cannot be reproduced except in full, without prior written approval of the Company. Any unauthorized alteration, forgery or falsification of the content or appearance of this document is unlawful and offenders may be prosecuted to the fullest extent of the law. Unless otherwise stated the results shown in this test report refer only to the sample(s) tested and such sample(s) are retained for 30 days only.  
**Attention: To check the authenticity of testing /inspection report & certificate, please contact us at telephone: (86-755) 8307 1443, or email: CN\_Doccheck@sgs.com**

No.10, Weiye Road, Innovation Park, Kunshan, Jiangsu, China 215300  
 中国·江苏·昆山市留学生创业园伟业路10号 邮编 215300

t(86-512)57355888 f(86-512)57370818 www.sgsgroup.com.cn  
 t(86-512)57355888 f(86-512)57370818 sgs.china@sgs.com

Test Mode: 02; Polarity: Vertical; Modulation:802.11a; Bandwidth:20MHz; Channel:Low

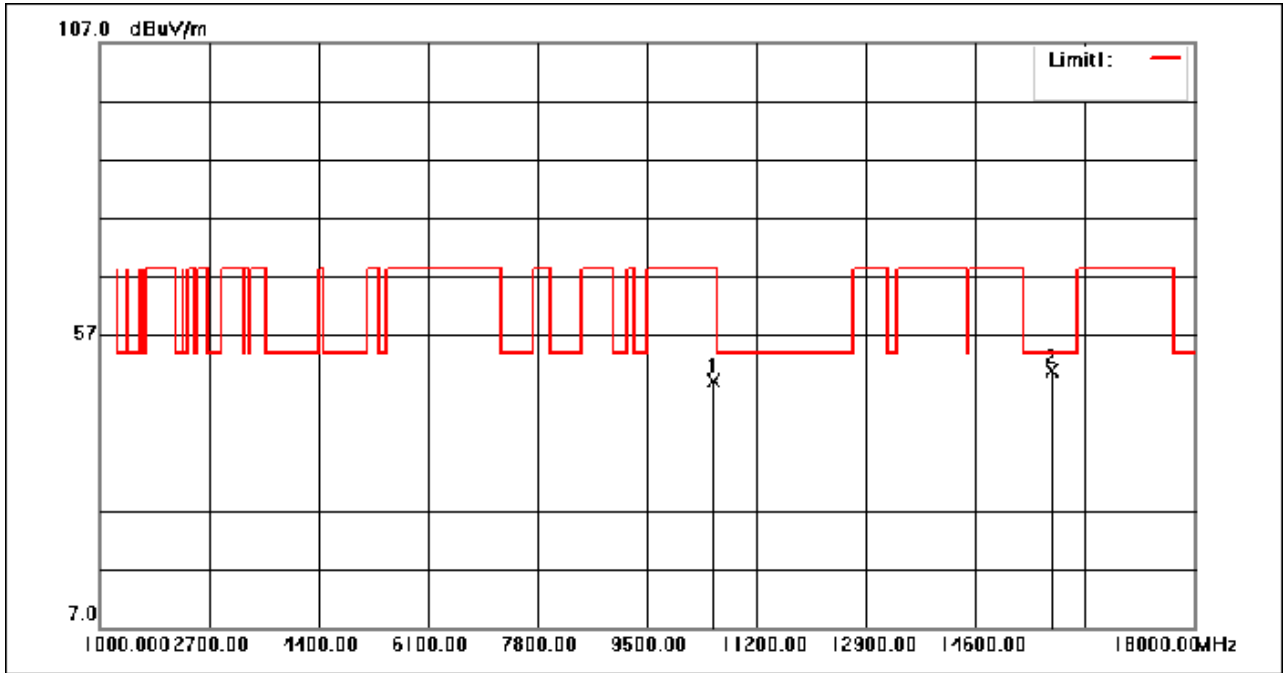

No.	Frequency (MHz)	Reading (dBuV)	Correction factor(dB/m)	Result (dBuV/m)	Limit (dBuV/m)	Margin (dB)	Remark
1	10520.000	48.63	0.44	49.07	68.30	-19.23	peak
2	15780.000	44.66	6.23	50.89	54.00	-3.11	peak



Unless otherwise agreed in writing, this document is issued by the Company subject to its General Conditions of Service printed overleaf, available on request or accessible at <http://www.sgs.com/en/Terms-and-Conditions.aspx> and, for electronic format documents, subject to Terms and Conditions for Electronic Documents at <http://www.sgs.com/en/Terms-and-Conditions/Terms-e-Documents.aspx>. Attention is drawn to the limitation of liability, indemnification and jurisdiction issues defined therein. Any holder of this document is advised that information contained hereon reflects the Company's findings at the time of its intervention only and within the limits of Client's instructions, if any. The Company's sole responsibility is to its Client and this document does not exonerate parties to a transaction from exercising all their rights and obligations under the transaction documents. This document cannot be reproduced except in full, without prior written approval of the Company. Any unauthorized alteration, forgery or falsification of the content or appearance of this document is unlawful and offenders may be prosecuted to the fullest extent of the law. Unless otherwise stated the results shown in this test report refer only to the sample(s) tested and such sample(s) are retained for 30 days only.  
**Attention: To check the authenticity of testing /inspection report & certificate, please contact us at telephone: (86-755) 8307 1443, or email: CN.Doccheck@sgs.com**

No.10, Weiye Road, Innovation Park, Kunshan, Jiangsu, China 215300  
 中国·江苏·昆山市留学生创业园伟业路10号 邮编 215300

t(86-512)57355888 f(86-512)57370818 www.sgsgroup.com.cn  
 t(86-512)57355888 f(86-512)57370818 sgs.china@sgs.com

Test Mode: 02; Polarity: Horizontal; Modulation:802.11a; Bandwidth:20MHz; Channel:middle

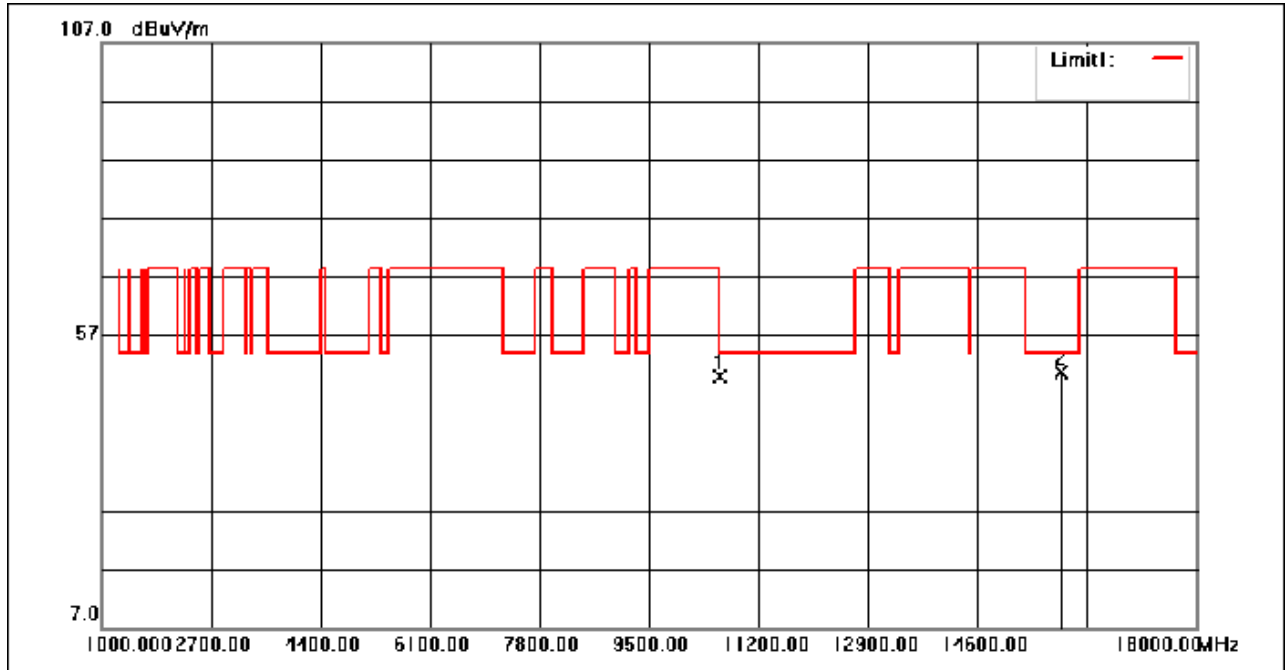

No.	Frequency (MHz)	Reading (dBuV)	Correction factor(dB/m)	Result (dBuV/m)	Limit (dBuV/m)	Margin (dB)	Remark
1	10600.000	49.34	0.46	49.80	54.00	-4.20	peak
2	15900.000	44.23	6.48	50.71	54.00	-3.29	peak



Unless otherwise agreed in writing, this document is issued by the Company subject to its General Conditions of Service printed overleaf, available on request or accessible at <http://www.sgs.com/en/Terms-and-Conditions.aspx> and, for electronic format documents, subject to Terms and Conditions for Electronic Documents at <http://www.sgs.com/en/Terms-and-Conditions/Terms-e-Documents.aspx>. Attention is drawn to the limitation of liability, indemnification and jurisdiction issues defined therein. Any holder of this document is advised that information contained hereon reflects the Company's findings at the time of its intervention only and within the limits of Client's instructions, if any. The Company's sole responsibility is to its Client and this document does not exonerate parties to a transaction from exercising all their rights and obligations under the transaction documents. This document cannot be reproduced except in full, without prior written approval of the Company. Any unauthorized alteration, forgery or falsification of the content or appearance of this document is unlawful and offenders may be prosecuted to the fullest extent of the law. Unless otherwise stated the results shown in this test report refer only to the sample(s) tested and such sample(s) are retained for 30 days only.  
**Attention: To check the authenticity of testing /inspection report & certificate, please contact us at telephone: (86-755) 8307 1443, or email: CN.Doccheck@sgs.com**

No.10, Weiye Road, Innovation Park, Kunshan, Jiangsu, China 215300  
 中国·江苏·昆山市留学生创业园伟业路10号 邮编 215300

t(86-512)57355888 f(86-512)57370818 www.sgsgroup.com.cn  
 t(86-512)57355888 f(86-512)57370818 sgs.china@sgs.com

Test Mode: 02; Polarity: Vertical; Modulation:802.11a; Bandwidth:20MHz; Channel:middle

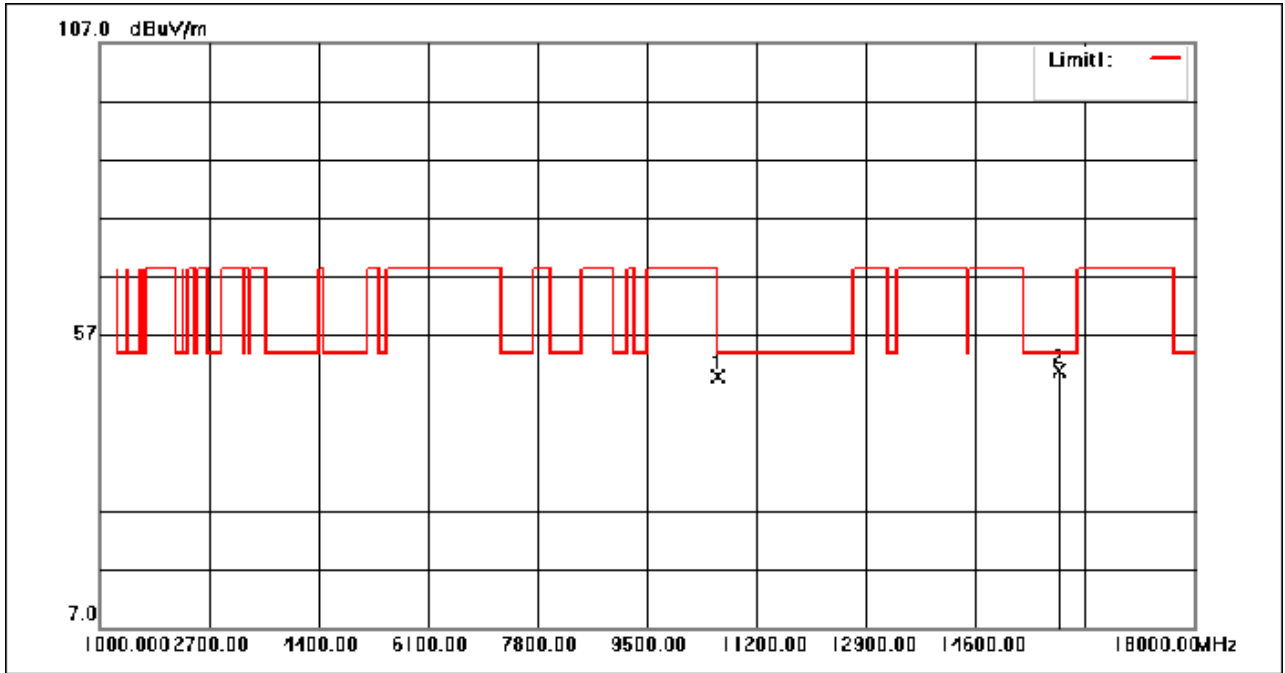

No.	Frequency (MHz)	Reading (dBuV)	Correction factor(dB/m)	Result (dBuV/m)	Limit (dBuV/m)	Margin (dB)	Remark
1	10600.000	49.36	0.46	49.82	54.00	-4.18	peak
2	15900.000	44.33	6.48	50.81	54.00	-3.19	peak



Unless otherwise agreed in writing, this document is issued by the Company subject to its General Conditions of Service printed overleaf, available on request or accessible at <http://www.sgs.com/en/Terms-and-Conditions.aspx> and, for electronic format documents, subject to Terms and Conditions for Electronic Documents at <http://www.sgs.com/en/Terms-and-Conditions/Terms-e-Documents.aspx>. Attention is drawn to the limitation of liability, indemnification and jurisdiction issues defined therein. Any holder of this document is advised that information contained hereon reflects the Company's findings at the time of its intervention only and within the limits of Client's instructions, if any. The Company's sole responsibility is to its Client and this document does not exonerate parties to a transaction from exercising all their rights and obligations under the transaction documents. This document cannot be reproduced except in full, without prior written approval of the Company. Any unauthorized alteration, forgery or falsification of the content or appearance of this document is unlawful and offenders may be prosecuted to the fullest extent of the law. Unless otherwise stated the results shown in this test report refer only to the sample(s) tested and such sample(s) are retained for 30 days only.  
**Attention: To check the authenticity of testing /inspection report & certificate, please contact us at telephone: (86-755) 8307 1443, or email: CN.Doccheck@sgs.com**

No.10, Weiye Road, Innovation Park, Kunshan, Jiangsu, China 215300  
 中国·江苏·昆山市留学生创业园伟业路10号 邮编 215300

t(86-512)57355888 f(86-512)57370818 www.sgsgroup.com.cn  
 t(86-512)57355888 f(86-512)57370818 sgs.china@sgs.com



Test Mode: 02; Polarity: Horizontal; Modulation:802.11a; Bandwidth:20MHz; Channel:High

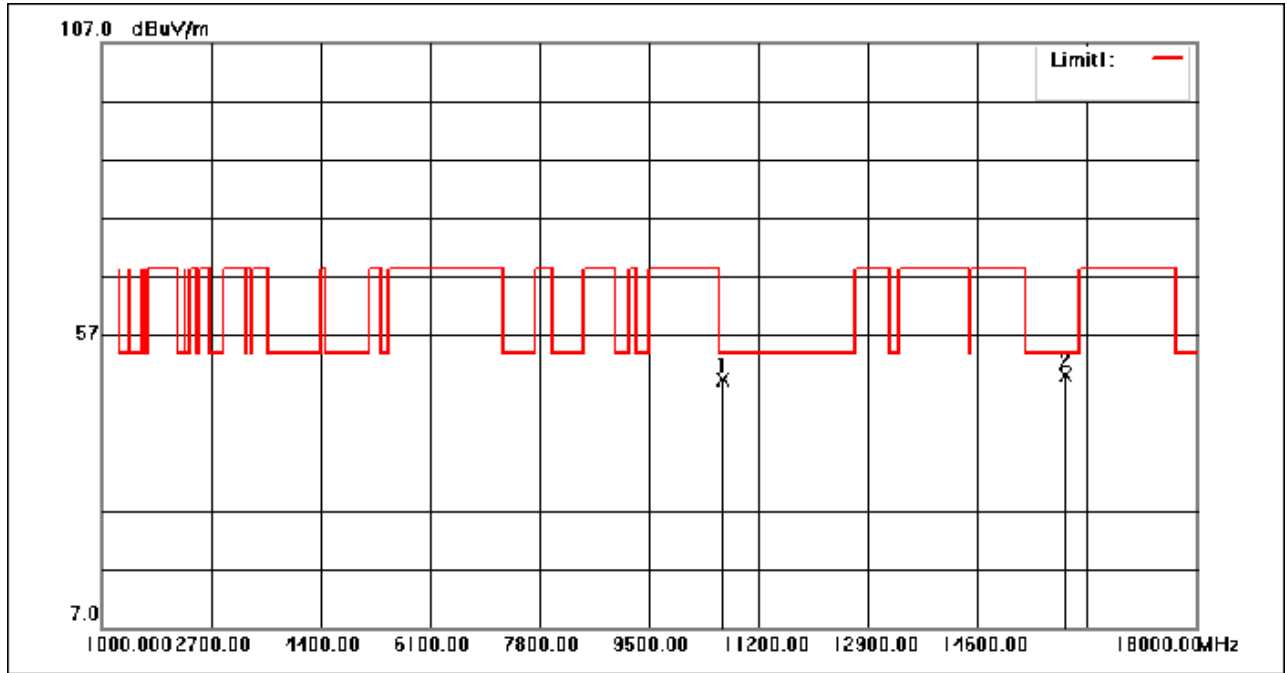

No.	Frequency (MHz)	Reading (dBuV)	Correction factor(dB/m)	Result (dBuV/m)	Limit (dBuV/m)	Margin (dB)	Remark
1	10640.000	48.83	0.46	49.29	54.00	-4.71	peak
2	15960.000	43.52	6.60	50.12	54.00	-3.88	peak



Unless otherwise agreed in writing, this document is issued by the Company subject to its General Conditions of Service printed overleaf, available on request or accessible at <http://www.sgs.com/en/Terms-and-Conditions.aspx> and, for electronic format documents, subject to Terms and Conditions for Electronic Documents at <http://www.sgs.com/en/Terms-and-Conditions/Terms-e-Documents.aspx>. Attention is drawn to the limitation of liability, indemnification and jurisdiction issues defined therein. Any holder of this document is advised that information contained hereon reflects the Company's findings at the time of its intervention only and within the limits of Client's instructions, if any. The Company's sole responsibility is to its Client and this document does not exonerate parties to a transaction from exercising all their rights and obligations under the transaction documents. This document cannot be reproduced except in full, without prior written approval of the Company. Any unauthorized alteration, forgery or falsification of the content or appearance of this document is unlawful and offenders may be prosecuted to the fullest extent of the law. Unless otherwise stated the results shown in this test report refer only to the sample(s) tested and such sample(s) are retained for 30 days only.  
**Attention: To check the authenticity of testing /inspection report & certificate, please contact us at telephone: (86-755) 8307 1443, or email: CN.Doccheck@sgs.com**

No.10, Weiye Road, Innovation Park, Kunshan, Jiangsu, China 215300  
 中国·江苏·昆山市留学生创业园伟业路10号 邮编 215300

t(86-512)57355888 f(86-512)57370818 www.sgs.com.cn  
 t(86-512)57355888 f(86-512)57370818 sgs.china@sgs.com

Test Mode: 02; Polarity: Vertical; Modulation:802.11a; Bandwidth:20MHz; Channel:High

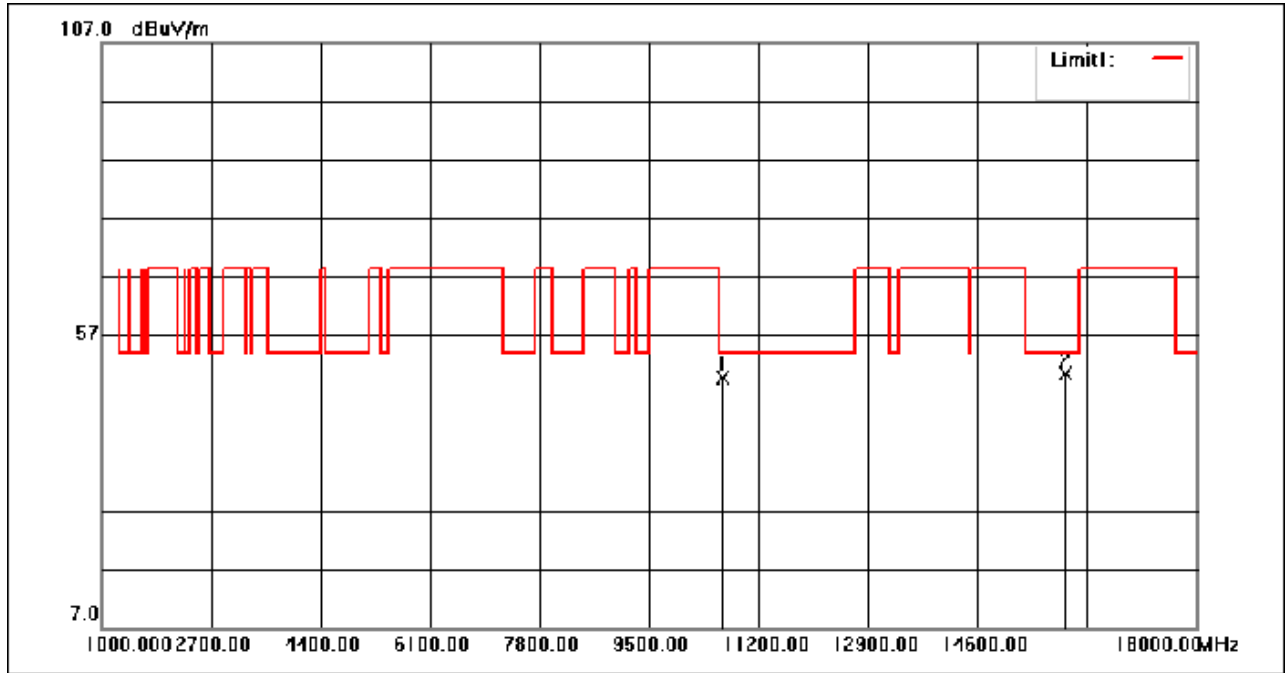

No.	Frequency (MHz)	Reading (dBuV)	Correction factor(dB/m)	Result (dBuV/m)	Limit (dBuV/m)	Margin (dB)	Remark
1	10640.000	49.11	0.46	49.57	54.00	-4.43	peak
2	15960.000	43.71	6.60	50.31	54.00	-3.69	peak



Unless otherwise agreed in writing, this document is issued by the Company subject to its General Conditions of Service printed overleaf, available on request or accessible at <http://www.sgs.com/en/Terms-and-Conditions.aspx> and, for electronic format documents, subject to Terms and Conditions for Electronic Documents at <http://www.sgs.com/en/Terms-and-Conditions/Terms-e-Documents.aspx>. Attention is drawn to the limitation of liability, indemnification and jurisdiction issues defined therein. Any holder of this document is advised that information contained hereon reflects the Company's findings at the time of its intervention only and within the limits of Client's instructions, if any. The Company's sole responsibility is to its Client and this document does not exonerate parties to a transaction from exercising all their rights and obligations under the transaction documents. This document cannot be reproduced except in full, without prior written approval of the Company. Any unauthorized alteration, forgery or falsification of the content or appearance of this document is unlawful and offenders may be prosecuted to the fullest extent of the law. Unless otherwise stated the results shown in this test report refer only to the sample(s) tested and such sample(s) are retained for 30 days only.  
**Attention: To check the authenticity of testing /inspection report & certificate, please contact us at telephone: (86-755) 8307 1443, or email: CN.Doccheck@sgs.com**

No.10, Weiye Road, Innovation Park, Kunshan, Jiangsu, China 215300  
 中国·江苏·昆山市留学生创业园伟业路10号 邮编 215300

t(86-512)57355888 f(86-512)57370818 www.sgs.com.cn  
 t(86-512)57355888 f(86-512)57370818 sgs.china@sgs.com

Test Mode: 02; Polarity: Horizontal; Modulation:802.11n; Bandwidth:20MHz; Channel:Low

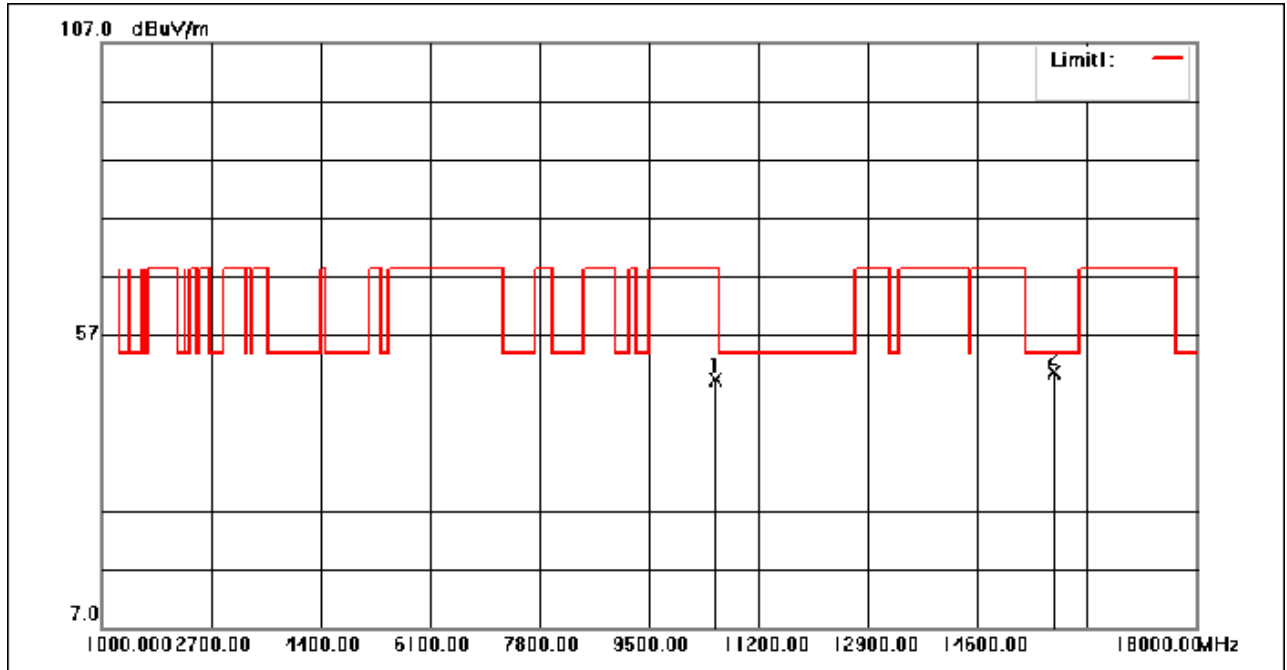

No.	Frequency (MHz)	Reading (dBuV)	Correction factor(dB/m)	Result (dBuV/m)	Limit (dBuV/m)	Margin (dB)	Remark
1	10520.000	48.84	0.44	49.28	68.30	-19.02	peak
2	15780.000	44.46	6.23	50.69	54.00	-3.31	peak



Unless otherwise agreed in writing, this document is issued by the Company subject to its General Conditions of Service printed overleaf, available on request or accessible at <http://www.sgs.com/en/Terms-and-Conditions.aspx> and, for electronic format documents, subject to Terms and Conditions for Electronic Documents at <http://www.sgs.com/en/Terms-and-Conditions/Terms-e-Documents.aspx>. Attention is drawn to the limitation of liability, indemnification and jurisdiction issues defined therein. Any holder of this document is advised that information contained hereon reflects the Company's findings at the time of its intervention only and within the limits of Client's instructions, if any. The Company's sole responsibility is to its Client and this document does not exonerate parties to a transaction from exercising all their rights and obligations under the transaction documents. This document cannot be reproduced except in full, without prior written approval of the Company. Any unauthorized alteration, forgery or falsification of the content or appearance of this document is unlawful and offenders may be prosecuted to the fullest extent of the law. Unless otherwise stated the results shown in this test report refer only to the sample(s) tested and such sample(s) are retained for 30 days only.  
**Attention: To check the authenticity of testing /inspection report & certificate, please contact us at telephone: (86-755) 8307 1443, or email: CN\_Doccheck@sgs.com**

No.10, Weiye Road, Innovation Park, Kunshan, Jiangsu, China 215300  
 中国·江苏·昆山市留学生创业园伟业路10号 邮编 215300

t(86-512)57355888 f(86-512)57370818 www.sgs.com.cn  
 t(86-512)57355888 f(86-512)57370818 sgs.china@sgs.com

Test Mode: 02; Polarity: Vertical; Modulation:802.11n; Bandwidth:20MHz; Channel:Low

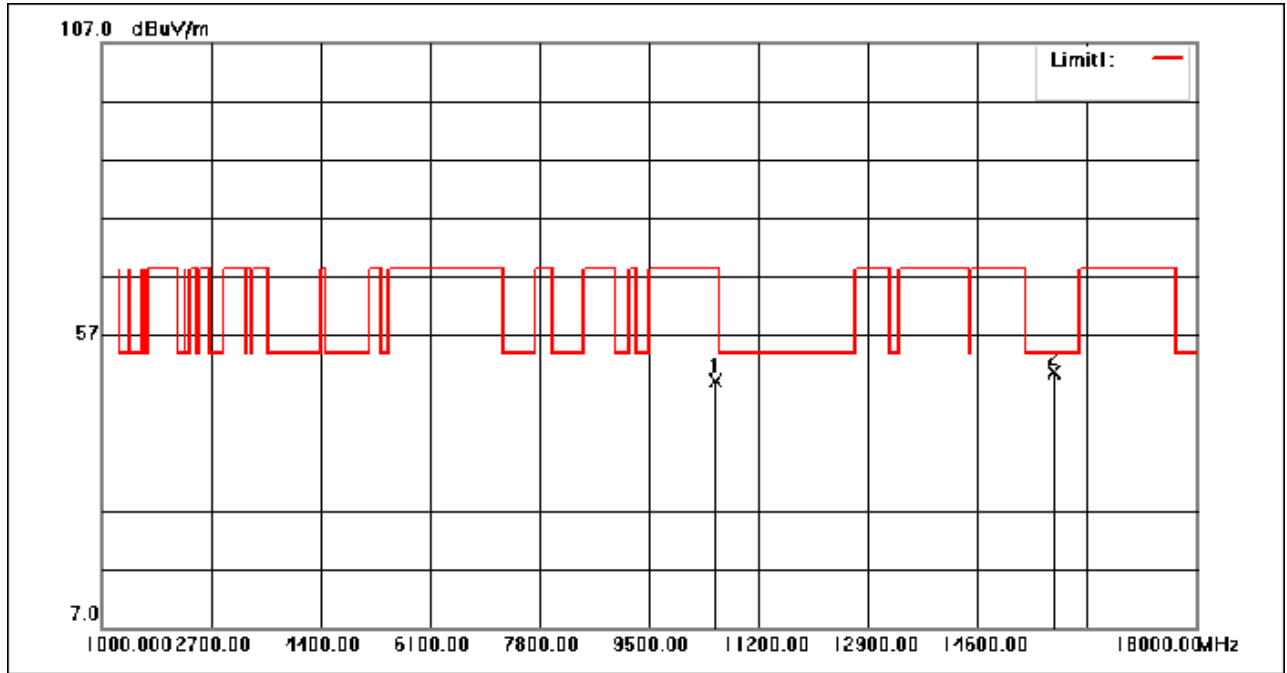

No.	Frequency (MHz)	Reading (dBuV)	Correction factor(dB/m)	Result (dBuV/m)	Limit (dBuV/m)	Margin (dB)	Remark
1	10520.000	48.67	0.44	49.11	68.30	-19.19	peak
2	15780.000	44.35	6.23	50.58	54.00	-3.42	peak



Unless otherwise agreed in writing, this document is issued by the Company subject to its General Conditions of Service printed overleaf, available on request or accessible at <http://www.sgs.com/en/Terms-and-Conditions.aspx> and, for electronic format documents, subject to Terms and Conditions for Electronic Documents at <http://www.sgs.com/en/Terms-and-Conditions/Terms-e-Documents.aspx>. Attention is drawn to the limitation of liability, indemnification and jurisdiction issues defined therein. Any holder of this document is advised that information contained hereon reflects the Company's findings at the time of its intervention only and within the limits of Client's instructions, if any. The Company's sole responsibility is to its Client and this document does not exonerate parties to a transaction from exercising all their rights and obligations under the transaction documents. This document cannot be reproduced except in full, without prior written approval of the Company. Any unauthorized alteration, forgery or falsification of the content or appearance of this document is unlawful and offenders may be prosecuted to the fullest extent of the law. Unless otherwise stated the results shown in this test report refer only to the sample(s) tested and such sample(s) are retained for 30 days only.  
**Attention: To check the authenticity of testing /inspection report & certificate, please contact us at telephone: (86-755) 8307 1443, or email: CN\_Doccheck@sgs.com**

No.10, Weiye Road, Innovation Park, Kunshan, Jiangsu, China 215300  
 中国·江苏·昆山市留学生创业园伟业路10号 邮编 215300

t(86-512)57355888 f(86-512)57370818 www.sgs.com.cn  
 t(86-512)57355888 f(86-512)57370818 sgs.china@sgs.com

Test Mode: 02; Polarity: Horizontal; Modulation:802.11n; Bandwidth:20MHz; Channel:middle

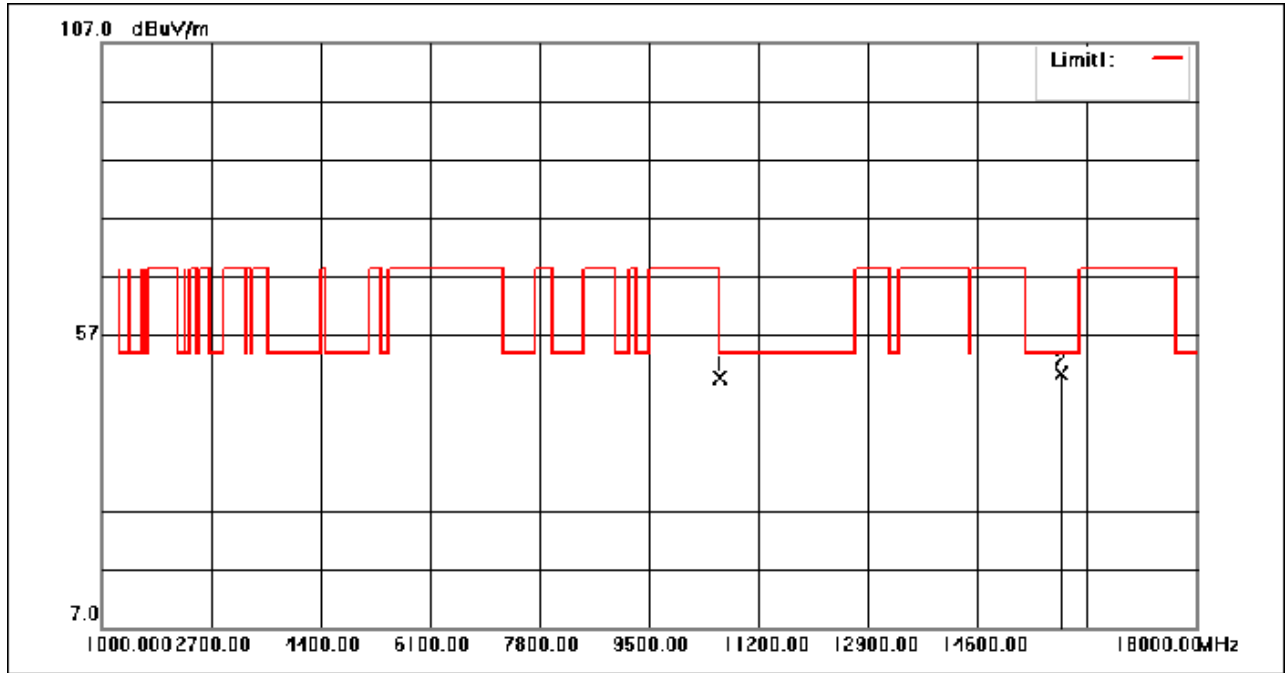

No.	Frequency (MHz)	Reading (dBuV)	Correction factor(dB/m)	Result (dBuV/m)	Limit (dBuV/m)	Margin (dB)	Remark
1	10600.000	49.21	0.46	49.67	54.00	-4.33	peak
2	15900.000	43.89	6.48	50.37	54.00	-3.63	peak



Unless otherwise agreed in writing, this document is issued by the Company subject to its General Conditions of Service printed overleaf, available on request or accessible at <http://www.sgs.com/en/Terms-and-Conditions.aspx> and, for electronic format documents, subject to Terms and Conditions for Electronic Documents at <http://www.sgs.com/en/Terms-and-Conditions/Terms-e-Documents.aspx>. Attention is drawn to the limitation of liability, indemnification and jurisdiction issues defined therein. Any holder of this document is advised that information contained hereon reflects the Company's findings at the time of its intervention only and within the limits of Client's instructions, if any. The Company's sole responsibility is to its Client and this document does not exonerate parties to a transaction from exercising all their rights and obligations under the transaction documents. This document cannot be reproduced except in full, without prior written approval of the Company. Any unauthorized alteration, forgery or falsification of the content or appearance of this document is unlawful and offenders may be prosecuted to the fullest extent of the law. Unless otherwise stated the results shown in this test report refer only to the sample(s) tested and such sample(s) are retained for 30 days only.  
**Attention: To check the authenticity of testing /inspection report & certificate, please contact us at telephone: (86-755) 8307 1443, or email: CN.Doccheck@sgs.com**

No.10, Weiye Road, Innovation Park, Kunshan, Jiangsu, China 215300  
 中国·江苏·昆山市留学生创业园伟业路10号 邮编 215300

t(86-512)57355888 f(86-512)57370818 www.sgsgroup.com.cn  
 t(86-512)57355888 f(86-512)57370818 sgs.china@sgs.com



Test Mode: 02; Polarity: Vertical; Modulation:802.11n; Bandwidth:20MHz; Channel:middle

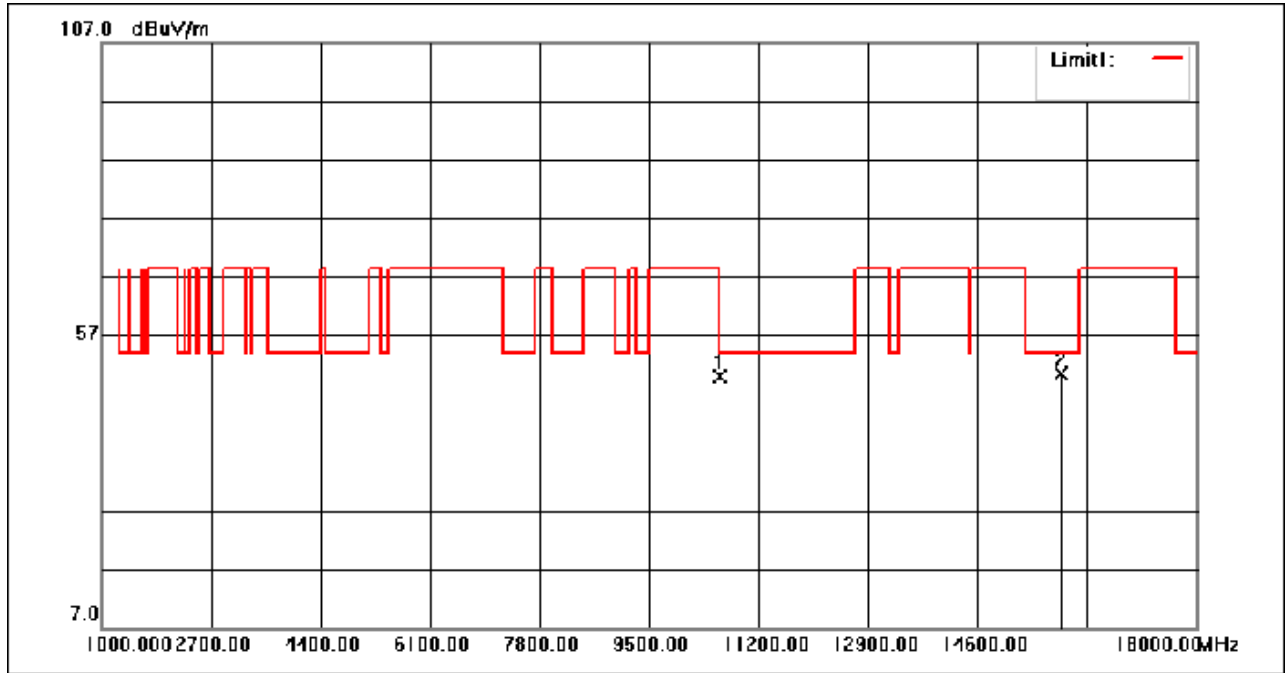

No.	Frequency (MHz)	Reading (dBuV)	Correction factor(dB/m)	Result (dBuV/m)	Limit (dBuV/m)	Margin (dB)	Remark
1	10600.000	49.37	0.46	49.83	54.00	-4.17	peak
2	15900.000	43.79	6.48	50.27	54.00	-3.73	peak



Unless otherwise agreed in writing, this document is issued by the Company subject to its General Conditions of Service printed overleaf, available on request or accessible at <http://www.sgs.com/en/Terms-and-Conditions.aspx> and, for electronic format documents, subject to Terms and Conditions for Electronic Documents at <http://www.sgs.com/en/Terms-and-Conditions/Terms-e-Documents.aspx>. Attention is drawn to the limitation of liability, indemnification and jurisdiction issues defined therein. Any holder of this document is advised that information contained hereon reflects the Company's findings at the time of its intervention only and within the limits of Client's instructions, if any. The Company's sole responsibility is to its Client and this document does not exonerate parties to a transaction from exercising all their rights and obligations under the transaction documents. This document cannot be reproduced except in full, without prior written approval of the Company. Any unauthorized alteration, forgery or falsification of the content or appearance of this document is unlawful and offenders may be prosecuted to the fullest extent of the law. Unless otherwise stated the results shown in this test report refer only to the sample(s) tested and such sample(s) are retained for 30 days only.  
**Attention: To check the authenticity of testing /inspection report & certificate, please contact us at telephone: (86-755) 8307 1443, or email: CN.Doccheck@sgs.com**

No.10, Weiye Road, Innovation Park, Kunshan, Jiangsu, China 215300  
 中国·江苏·昆山市留学生创业园伟业路10号 邮编 215300

t(86-512)57355888 f(86-512)57370818 www.sgsgroup.com.cn  
 t(86-512)57355888 f(86-512)57370818 sgs.china@sgs.com

Test Mode: 02; Polarity: Horizontal; Modulation:802.11n; Bandwidth:20MHz; Channel:High

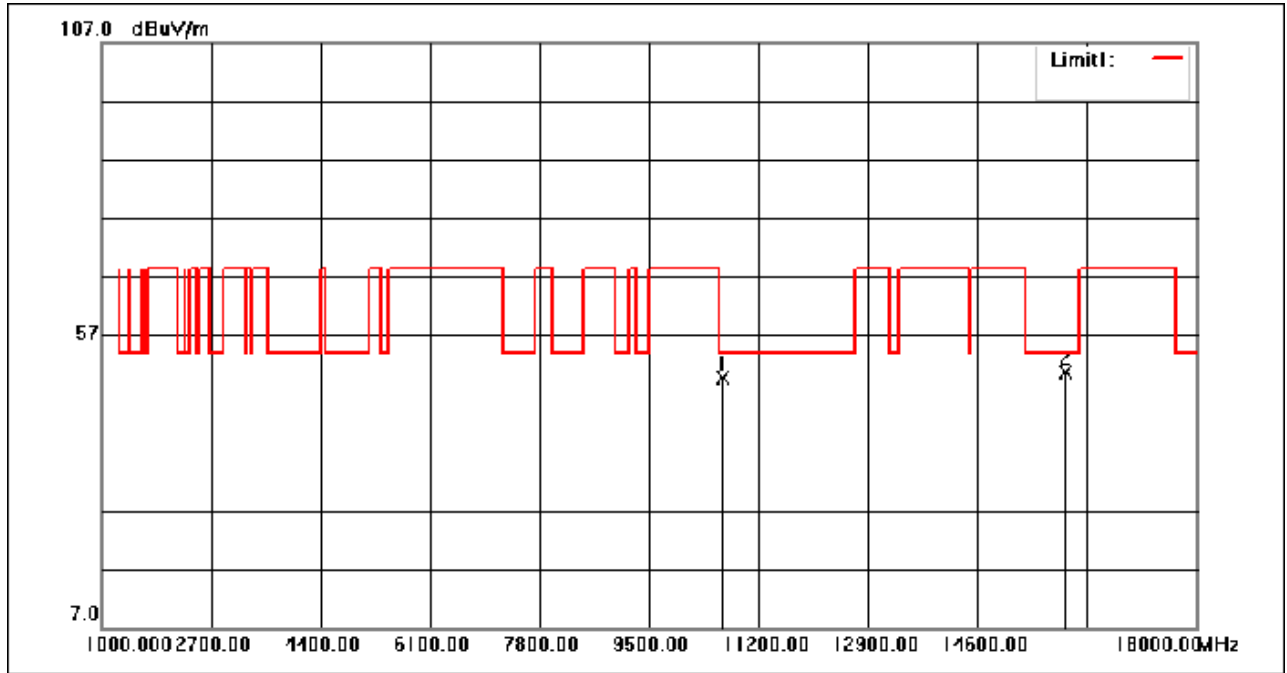

No.	Frequency (MHz)	Reading (dBuV)	Correction factor(dB/m)	Result (dBuV/m)	Limit (dBuV/m)	Margin (dB)	Remark
1	10640.000	49.11	0.46	49.57	54.00	-4.43	peak
2	15960.000	44.09	6.60	50.69	54.00	-3.31	peak



Unless otherwise agreed in writing, this document is issued by the Company subject to its General Conditions of Service printed overleaf, available on request or accessible at <http://www.sgs.com/en/Terms-and-Conditions.aspx> and, for electronic format documents, subject to Terms and Conditions for Electronic Documents at <http://www.sgs.com/en/Terms-and-Conditions/Terms-e-Documents.aspx>. Attention is drawn to the limitation of liability, indemnification and jurisdiction issues defined therein. Any holder of this document is advised that information contained hereon reflects the Company's findings at the time of its intervention only and within the limits of Client's instructions, if any. The Company's sole responsibility is to its Client and this document does not exonerate parties to a transaction from exercising all their rights and obligations under the transaction documents. This document cannot be reproduced except in full, without prior written approval of the Company. Any unauthorized alteration, forgery or falsification of the content or appearance of this document is unlawful and offenders may be prosecuted to the fullest extent of the law. Unless otherwise stated the results shown in this test report refer only to the sample(s) tested and such sample(s) are retained for 30 days only.  
**Attention: To check the authenticity of testing /inspection report & certificate, please contact us at telephone: (86-755) 8307 1443, or email: CN.Doccheck@sgs.com**

No.10, Weiye Road, Innovation Park, Kunshan, Jiangsu, China 215300  
 中国·江苏·昆山市留学生创业园伟业路10号 邮编 215300

t(86-512)57355888 f(86-512)57370818 www.sgsgroup.com.cn  
 t(86-512)57355888 f(86-512)57370818 sgs.china@sgs.com

Test Mode: 02; Polarity: Vertical; Modulation:802.11n; Bandwidth:20MHz; Channel:High

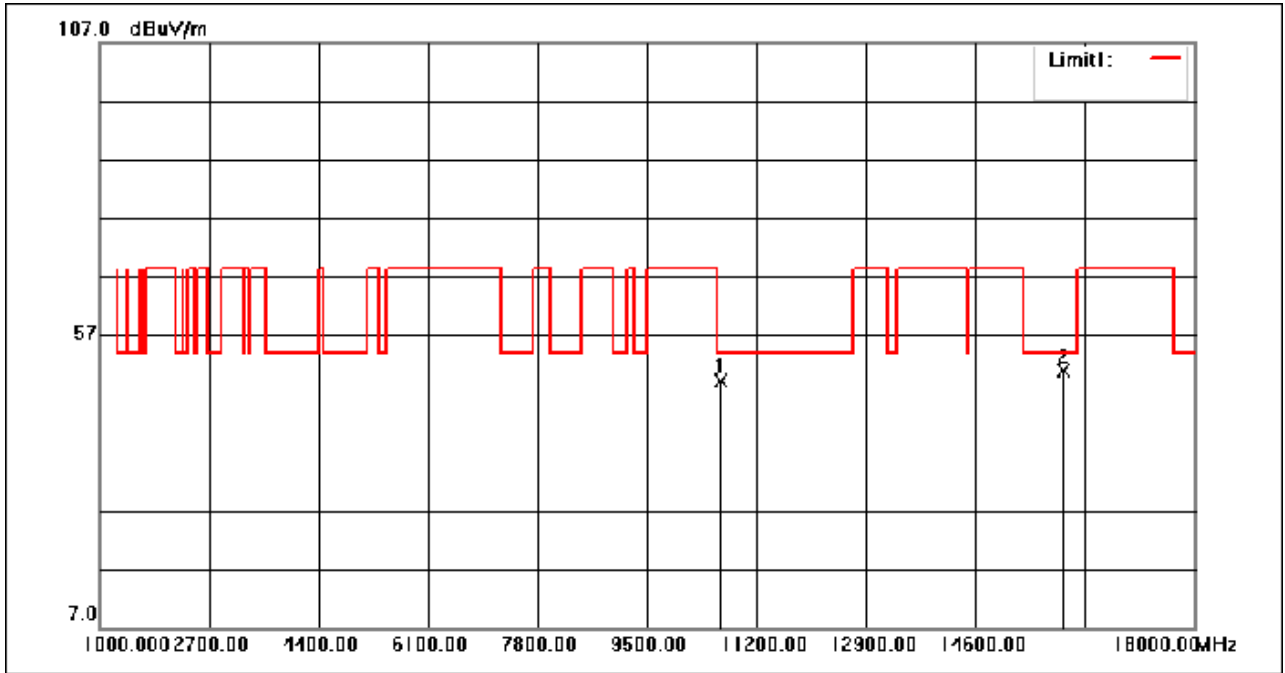

No.	Frequency (MHz)	Reading (dBuV)	Correction factor(dB/m)	Result (dBuV/m)	Limit (dBuV/m)	Margin (dB)	Remark
1	10640.000	48.66	0.46	49.12	54.00	-4.88	peak
2	15960.000	44.39	6.60	50.99	54.00	-3.01	peak



Unless otherwise agreed in writing, this document is issued by the Company subject to its General Conditions of Service printed overleaf, available on request or accessible at <http://www.sgs.com/en/Terms-and-Conditions.aspx> and, for electronic format documents, subject to Terms and Conditions for Electronic Documents at <http://www.sgs.com/en/Terms-and-Conditions/Terms-e-Documents.aspx>. Attention is drawn to the limitation of liability, indemnification and jurisdiction issues defined therein. Any holder of this document is advised that information contained hereon reflects the Company's findings at the time of its intervention only and within the limits of Client's instructions, if any. The Company's sole responsibility is to its Client and this document does not exonerate parties to a transaction from exercising all their rights and obligations under the transaction documents. This document cannot be reproduced except in full, without prior written approval of the Company. Any unauthorized alteration, forgery or falsification of the content or appearance of this document is unlawful and offenders may be prosecuted to the fullest extent of the law. Unless otherwise stated the results shown in this test report refer only to the sample(s) tested and such sample(s) are retained for 30 days only.  
**Attention: To check the authenticity of testing /inspection report & certificate, please contact us at telephone: (86-755) 8307 1443, or email: CN.Doccheck@sgs.com**

No.10, Weiye Road, Innovation Park, Kunshan, Jiangsu, China 215300  
 中国·江苏·昆山市留学生创业园伟业路10号 邮编 215300

t(86-512)57355888 f(86-512)57370818 www.sgsgroup.com.cn  
 t(86-512)57355888 f(86-512)57370818 sgs.china@sgs.com

Test Mode: 02; Polarity: Horizontal; Modulation:802.11n; Bandwidth:40MHz; Channel:Low

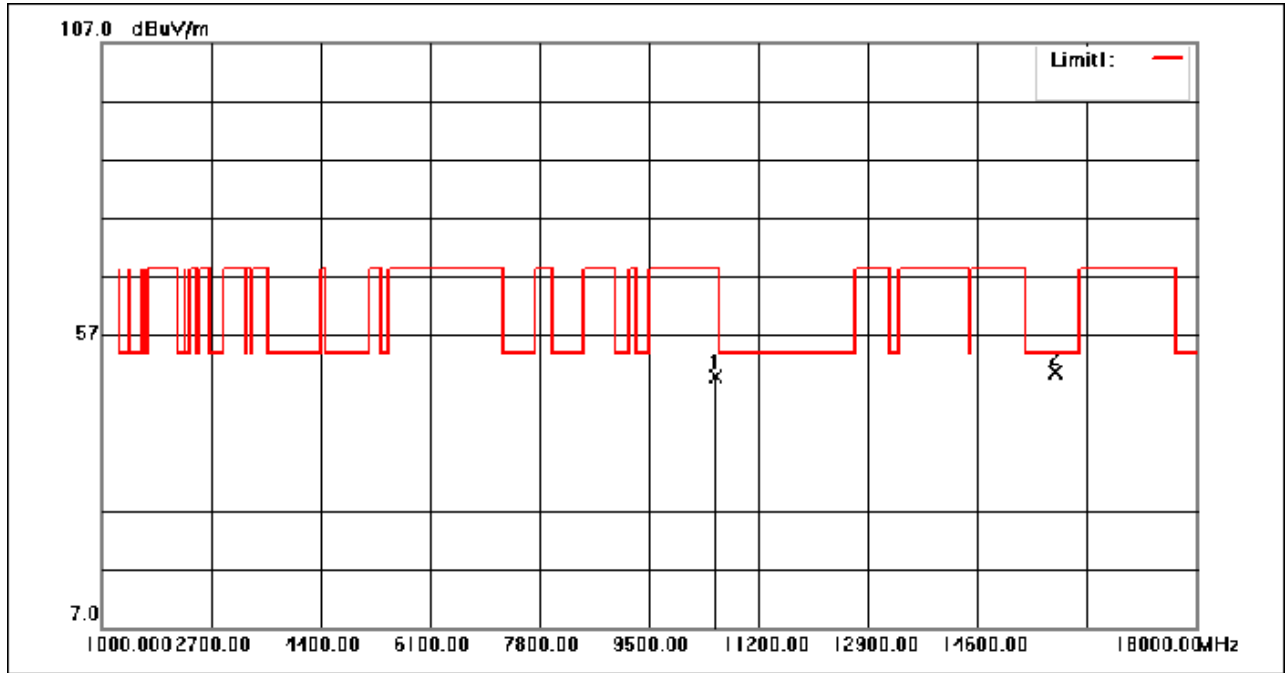

No.	Frequency (MHz)	Reading (dBuV)	Correction factor(dB/m)	Result (dBuV/m)	Limit (dBuV/m)	Margin (dB)	Remark
1	10540.000	49.34	0.44	49.78	68.30	-18.52	peak
2	15810.000	44.40	6.29	50.69	54.00	-3.31	peak



Unless otherwise agreed in writing, this document is issued by the Company subject to its General Conditions of Service printed overleaf, available on request or accessible at <http://www.sgs.com/en/Terms-and-Conditions.aspx> and, for electronic format documents, subject to Terms and Conditions for Electronic Documents at <http://www.sgs.com/en/Terms-and-Conditions/Terms-e-Documents.aspx>. Attention is drawn to the limitation of liability, indemnification and jurisdiction issues defined therein. Any holder of this document is advised that information contained hereon reflects the Company's findings at the time of its intervention only and within the limits of Client's instructions, if any. The Company's sole responsibility is to its Client and this document does not exonerate parties to a transaction from exercising all their rights and obligations under the transaction documents. This document cannot be reproduced except in full, without prior written approval of the Company. Any unauthorized alteration, forgery or falsification of the content or appearance of this document is unlawful and offenders may be prosecuted to the fullest extent of the law. Unless otherwise stated the results shown in this test report refer only to the sample(s) tested and such sample(s) are retained for 30 days only.  
**Attention: To check the authenticity of testing /inspection report & certificate, please contact us at telephone: (86-755) 8307 1443, or email: CN.Doccheck@sgs.com**

No.10, Weiye Road, Innovation Park, Kunshan, Jiangsu, China 215300  
 中国·江苏·昆山市留学生创业园伟业路10号 邮编 215300

t(86-512)57355888 f(86-512)57370818 www.sgsgroup.com.cn  
 t(86-512)57355888 f(86-512)57370818 sgs.china@sgs.com

Test Mode: 02; Polarity: Vertical; Modulation:802.11n; Bandwidth:40MHz; Channel:Low

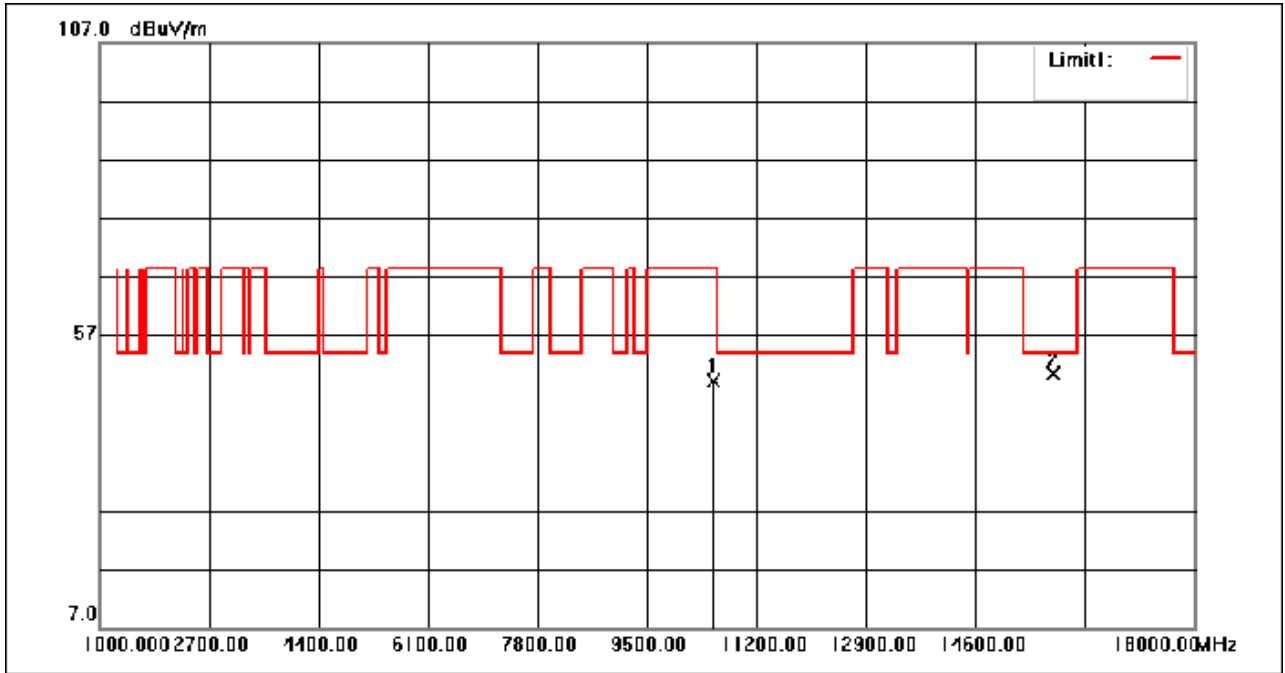

No.	Frequency (MHz)	Reading (dBuV)	Correction factor(dB/m)	Result (dBuV/m)	Limit (dBuV/m)	Margin (dB)	Remark
1	10540.000	48.71	0.44	49.15	68.30	-19.15	peak
2	15810.000	44.21	6.29	50.50	54.00	-3.50	peak



Unless otherwise agreed in writing, this document is issued by the Company subject to its General Conditions of Service printed overleaf, available on request or accessible at <http://www.sgs.com/en/Terms-and-Conditions.aspx> and, for electronic format documents, subject to Terms and Conditions for Electronic Documents at <http://www.sgs.com/en/Terms-and-Conditions/Terms-e-Documents.aspx>. Attention is drawn to the limitation of liability, indemnification and jurisdiction issues defined therein. Any holder of this document is advised that information contained hereon reflects the Company's findings at the time of its intervention only and within the limits of Client's instructions, if any. The Company's sole responsibility is to its Client and this document does not exonerate parties to a transaction from exercising all their rights and obligations under the transaction documents. This document cannot be reproduced except in full, without prior written approval of the Company. Any unauthorized alteration, forgery or falsification of the content or appearance of this document is unlawful and offenders may be prosecuted to the fullest extent of the law. Unless otherwise stated the results shown in this test report refer only to the sample(s) tested and such sample(s) are retained for 30 days only.  
**Attention: To check the authenticity of testing /inspection report & certificate, please contact us at telephone: (86-755) 8307 1443, or email: CN\_Doccheck@sgs.com**

No.10, Weiye Road, Innovation Park, Kunshan, Jiangsu, China 215300  
 中国·江苏·昆山市留学生创业园伟业路10号 邮编 215300

t(86-512)57355888 f(86-512)57370818 www.sgsgroup.com.cn  
 t(86-512)57355888 f(86-512)57370818 sgs.china@sgs.com



Test Mode: 02; Polarity: Horizontal; Modulation:802.11n; Bandwidth:40MHz; Channel:High

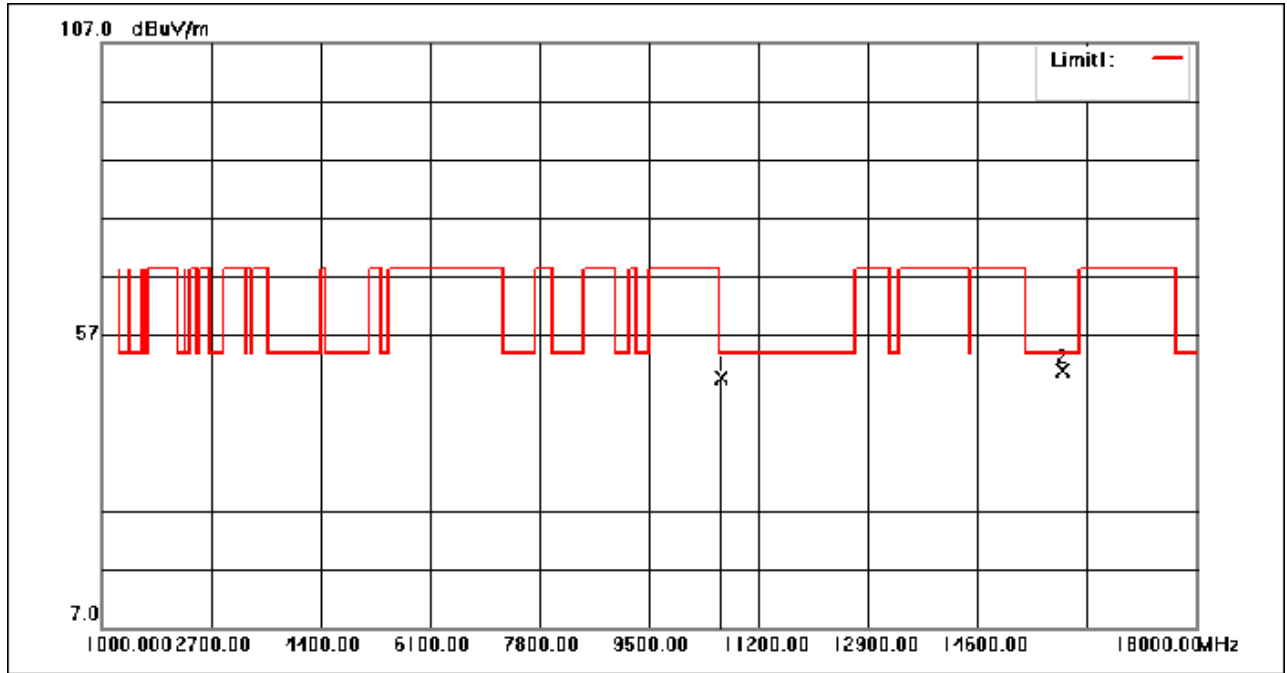

No.	Frequency (MHz)	Reading (dBuV)	Correction factor(dB/m)	Result (dBuV/m)	Limit (dBuV/m)	Margin (dB)	Remark
1	10620.000	49.23	0.46	49.69	54.00	-4.31	peak
2	15930.000	44.35	6.54	50.89	54.00	-3.11	peak



Unless otherwise agreed in writing, this document is issued by the Company subject to its General Conditions of Service printed overleaf, available on request or accessible at <http://www.sgs.com/en/Terms-and-Conditions.aspx> and, for electronic format documents, subject to Terms and Conditions for Electronic Documents at <http://www.sgs.com/en/Terms-and-Conditions/Terms-e-Documents.aspx>. Attention is drawn to the limitation of liability, indemnification and jurisdiction issues defined therein. Any holder of this document is advised that information contained hereon reflects the Company's findings at the time of its intervention only and within the limits of Client's instructions, if any. The Company's sole responsibility is to its Client and this document does not exonerate parties to a transaction from exercising all their rights and obligations under the transaction documents. This document cannot be reproduced except in full, without prior written approval of the Company. Any unauthorized alteration, forgery or falsification of the content or appearance of this document is unlawful and offenders may be prosecuted to the fullest extent of the law. Unless otherwise stated the results shown in this test report refer only to the sample(s) tested and such sample(s) are retained for 30 days only.  
**Attention: To check the authenticity of testing /inspection report & certificate, please contact us at telephone: (86-755) 8307 1443, or email: CN.Doccheck@sgs.com**

No.10, Weiye Road, Innovation Park, Kunshan, Jiangsu, China 215300  
 中国·江苏·昆山市留学生创业园伟业路10号 邮编 215300

t(86-512)57355888 f(86-512)57370818 www.sgsgroup.com.cn  
 t(86-512)57355888 f(86-512)57370818 sgs.china@sgs.com

Test Mode: 02; Polarity: Vertical; Modulation:802.11n; Bandwidth:40MHz; Channel:High

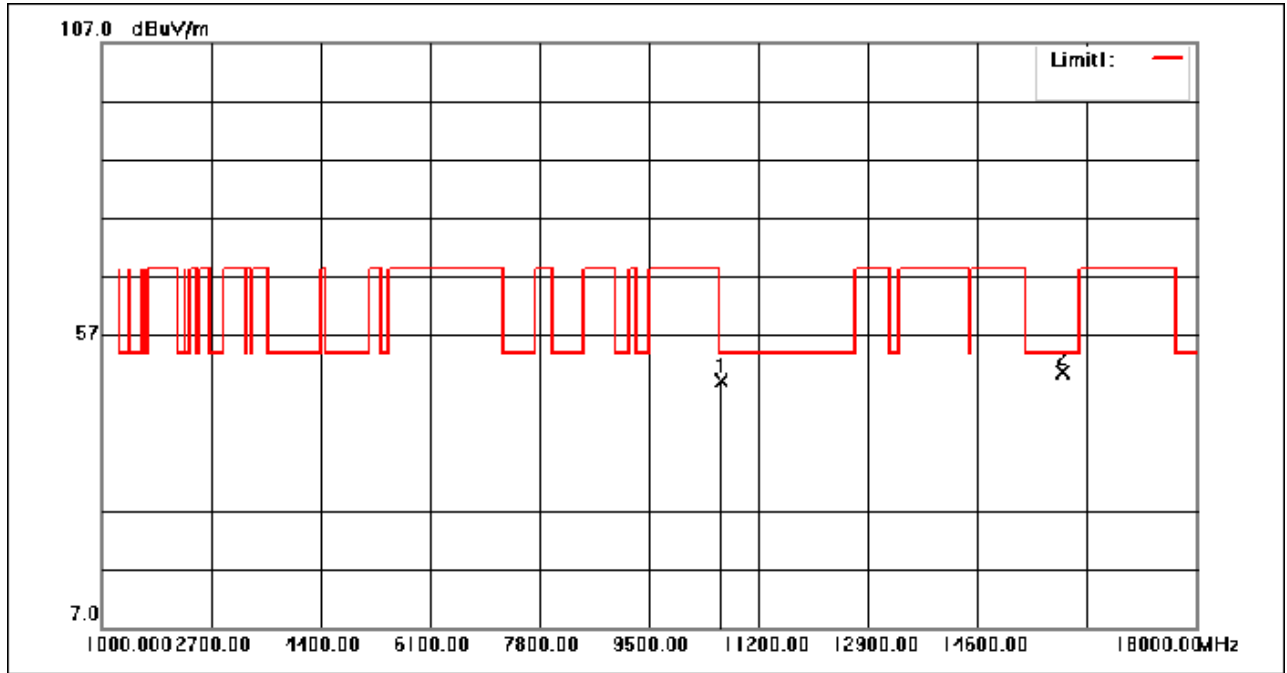

No.	Frequency (MHz)	Reading (dBuV)	Correction factor(dB/m)	Result (dBuV/m)	Limit (dBuV/m)	Margin (dB)	Remark
1	10620.000	48.71	0.46	49.17	54.00	-4.83	peak
2	15930.000	43.97	6.54	50.51	54.00	-3.49	peak



Unless otherwise agreed in writing, this document is issued by the Company subject to its General Conditions of Service printed overleaf, available on request or accessible at <http://www.sgs.com/en/Terms-and-Conditions.aspx> and, for electronic format documents, subject to Terms and Conditions for Electronic Documents at <http://www.sgs.com/en/Terms-and-Conditions/Terms-e-Documents.aspx>. Attention is drawn to the limitation of liability, indemnification and jurisdiction issues defined therein. Any holder of this document is advised that information contained hereon reflects the Company's findings at the time of its intervention only and within the limits of Client's instructions, if any. The Company's sole responsibility is to its Client and this document does not exonerate parties to a transaction from exercising all their rights and obligations under the transaction documents. This document cannot be reproduced except in full, without prior written approval of the Company. Any unauthorized alteration, forgery or falsification of the content or appearance of this document is unlawful and offenders may be prosecuted to the fullest extent of the law. Unless otherwise stated the results shown in this test report refer only to the sample(s) tested and such sample(s) are retained for 30 days only.  
**Attention: To check the authenticity of testing /inspection report & certificate, please contact us at telephone: (86-755) 8307 1443, or email: CN.Doccheck@sgs.com**

No.10, Weiye Road, Innovation Park, Kunshan, Jiangsu, China 215300  
 中国·江苏·昆山市留学生创业园伟业路10号 邮编 215300

t(86-512)57355888 f(86-512)57370818 www.sgsgroup.com.cn  
 t(86-512)57355888 f(86-512)57370818 sgs.china@sgs.com

Test Mode: 02; Polarity: Horizontal; Modulation:802.11ac; Bandwidth:20MHz; Channel:Low

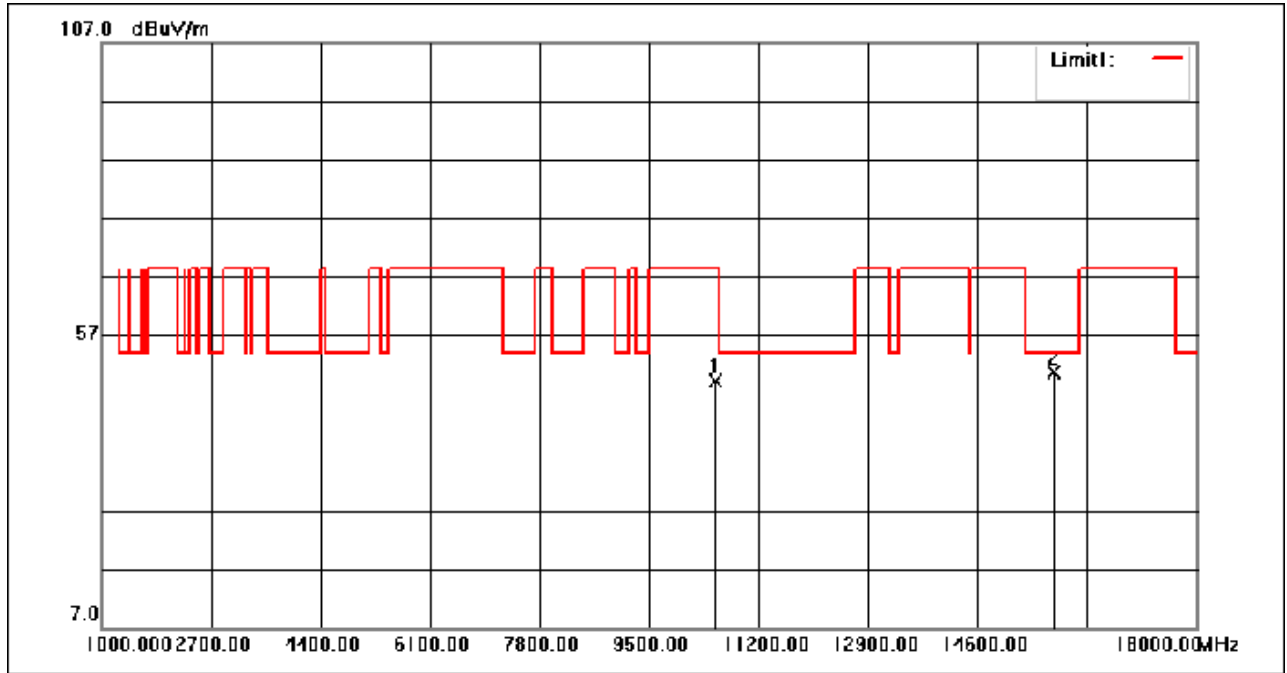

No.	Frequency (MHz)	Reading (dBuV)	Correction factor(dB/m)	Result (dBuV/m)	Limit (dBuV/m)	Margin (dB)	Remark
1	10520.000	48.72	0.44	49.16	68.30	-19.14	peak
2	15780.000	44.43	6.23	50.66	54.00	-3.34	peak



Unless otherwise agreed in writing, this document is issued by the Company subject to its General Conditions of Service printed overleaf, available on request or accessible at <http://www.sgs.com/en/Terms-and-Conditions.aspx> and, for electronic format documents, subject to Terms and Conditions for Electronic Documents at <http://www.sgs.com/en/Terms-and-Conditions/Terms-e-Documents.aspx>. Attention is drawn to the limitation of liability, indemnification and jurisdiction issues defined therein. Any holder of this document is advised that information contained hereon reflects the Company's findings at the time of its intervention only and within the limits of Client's instructions, if any. The Company's sole responsibility is to its Client and this document does not exonerate parties to a transaction from exercising all their rights and obligations under the transaction documents. This document cannot be reproduced except in full, without prior written approval of the Company. Any unauthorized alteration, forgery or falsification of the content or appearance of this document is unlawful and offenders may be prosecuted to the fullest extent of the law. Unless otherwise stated the results shown in this test report refer only to the sample(s) tested and such sample(s) are retained for 30 days only.  
**Attention: To check the authenticity of testing /inspection report & certificate, please contact us at telephone: (86-755) 8307 1443, or email: CN.Doccheck@sgs.com**

No.10, Weiye Road, Innovation Park, Kunshan, Jiangsu, China 215300  
 中国·江苏·昆山市留学生创业园伟业路10号 邮编 215300

t(86-512)57355888 f(86-512)57370818 www.sgsgroup.com.cn  
 t(86-512)57355888 f(86-512)57370818 sgs.china@sgs.com

Test Mode: 02; Polarity: Vertical; Modulation:802.11ac; Bandwidth:20MHz; Channel:Low

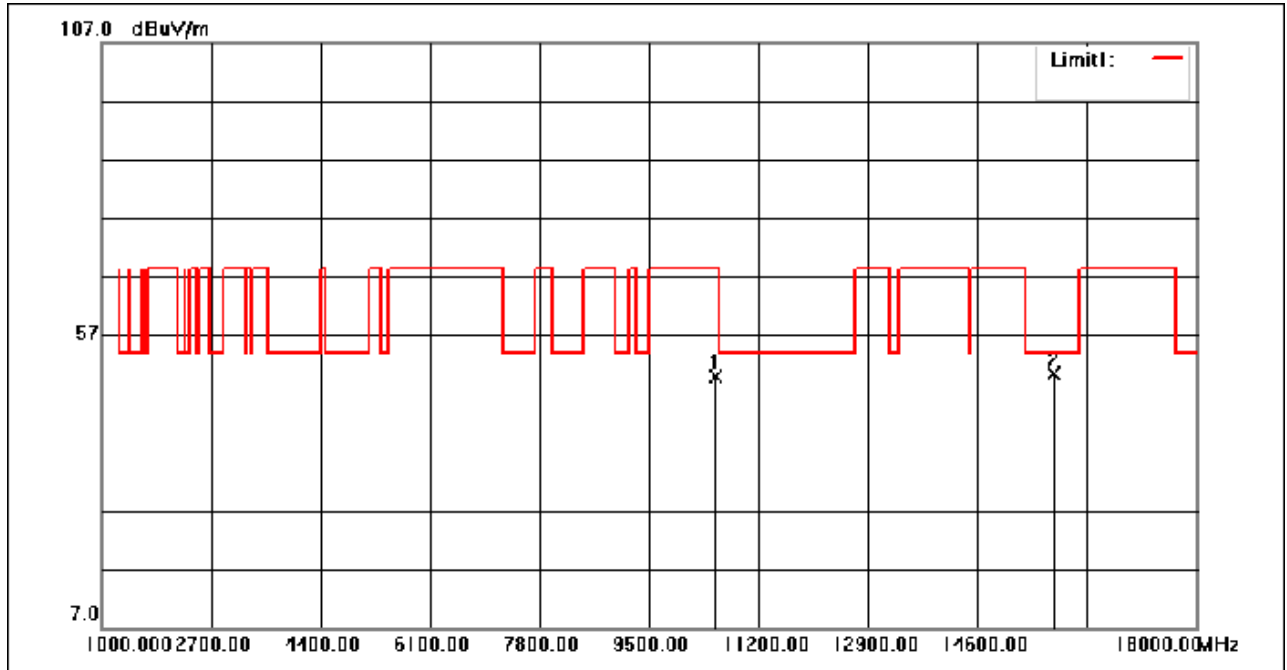

No.	Frequency (MHz)	Reading (dBuV)	Correction factor(dB/m)	Result (dBuV/m)	Limit (dBuV/m)	Margin (dB)	Remark
1	10520.000	49.38	0.44	49.82	68.30	-18.48	peak
2	15780.000	44.19	6.23	50.42	54.00	-3.58	peak



Unless otherwise agreed in writing, this document is issued by the Company subject to its General Conditions of Service printed overleaf, available on request or accessible at <http://www.sgs.com/en/Terms-and-Conditions.aspx> and, for electronic format documents, subject to Terms and Conditions for Electronic Documents at <http://www.sgs.com/en/Terms-and-Conditions/Terms-e-Documents.aspx>. Attention is drawn to the limitation of liability, indemnification and jurisdiction issues defined therein. Any holder of this document is advised that information contained hereon reflects the Company's findings at the time of its intervention only and within the limits of Client's instructions, if any. The Company's sole responsibility is to its Client and this document does not exonerate parties to a transaction from exercising all their rights and obligations under the transaction documents. This document cannot be reproduced except in full, without prior written approval of the Company. Any unauthorized alteration, forgery or falsification of the content or appearance of this document is unlawful and offenders may be prosecuted to the fullest extent of the law. Unless otherwise stated the results shown in this test report refer only to the sample(s) tested and such sample(s) are retained for 30 days only.  
**Attention: To check the authenticity of testing /inspection report & certificate, please contact us at telephone: (86-755) 8307 1443, or email: CN.Doccheck@sgs.com**

No.10, Weiye Road, Innovation Park, Kunshan, Jiangsu, China 215300  
 中国·江苏·昆山市留学生创业园伟业路10号 邮编 215300

t(86-512)57355888 f(86-512)57370818 www.sgsgroup.com.cn  
 t(86-512)57355888 f(86-512)57370818 sgs.china@sgs.com

Test Mode: 02; Polarity: Horizontal; Modulation:802.11ac; Bandwidth:20MHz; Channel:middle

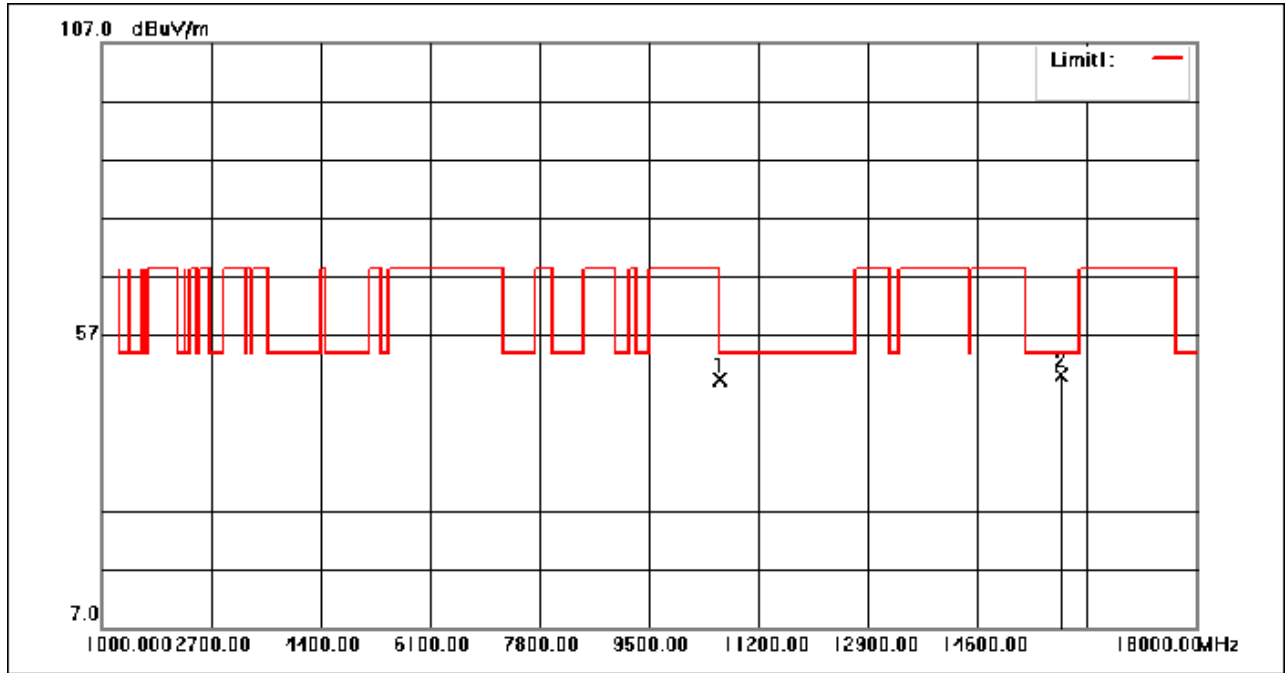

No.	Frequency (MHz)	Reading (dBuV)	Correction factor(dB/m)	Result (dBuV/m)	Limit (dBuV/m)	Margin (dB)	Remark
1	10600.000	48.81	0.46	49.27	54.00	-4.73	peak
2	15900.000	43.58	6.48	50.06	54.00	-3.94	peak



Unless otherwise agreed in writing, this document is issued by the Company subject to its General Conditions of Service printed overleaf, available on request or accessible at <http://www.sgs.com/en/Terms-and-Conditions.aspx> and, for electronic format documents, subject to Terms and Conditions for Electronic Documents at <http://www.sgs.com/en/Terms-and-Conditions/Terms-e-Documents.aspx>. Attention is drawn to the limitation of liability, indemnification and jurisdiction issues defined therein. Any holder of this document is advised that information contained hereon reflects the Company's findings at the time of its intervention only and within the limits of Client's instructions, if any. The Company's sole responsibility is to its Client and this document does not exonerate parties to a transaction from exercising all their rights and obligations under the transaction documents. This document cannot be reproduced except in full, without prior written approval of the Company. Any unauthorized alteration, forgery or falsification of the content or appearance of this document is unlawful and offenders may be prosecuted to the fullest extent of the law. Unless otherwise stated the results shown in this test report refer only to the sample(s) tested and such sample(s) are retained for 30 days only.  
**Attention: To check the authenticity of testing /inspection report & certificate, please contact us at telephone: (86-755) 8307 1443, or email: CN.Doccheck@sgs.com**

No.10, Weiye Road, Innovation Park, Kunshan, Jiangsu, China 215300  
 中国·江苏·昆山市留学生创业园伟业路10号 邮编 215300

t(86-512)57355888 f(86-512)57370818 www.sgsgroup.com.cn  
 t(86-512)57355888 f(86-512)57370818 sgs.china@sgs.com



Test Mode: 02; Polarity: Vertical; Modulation:802.11ac; Bandwidth:20MHz; Channel:middle

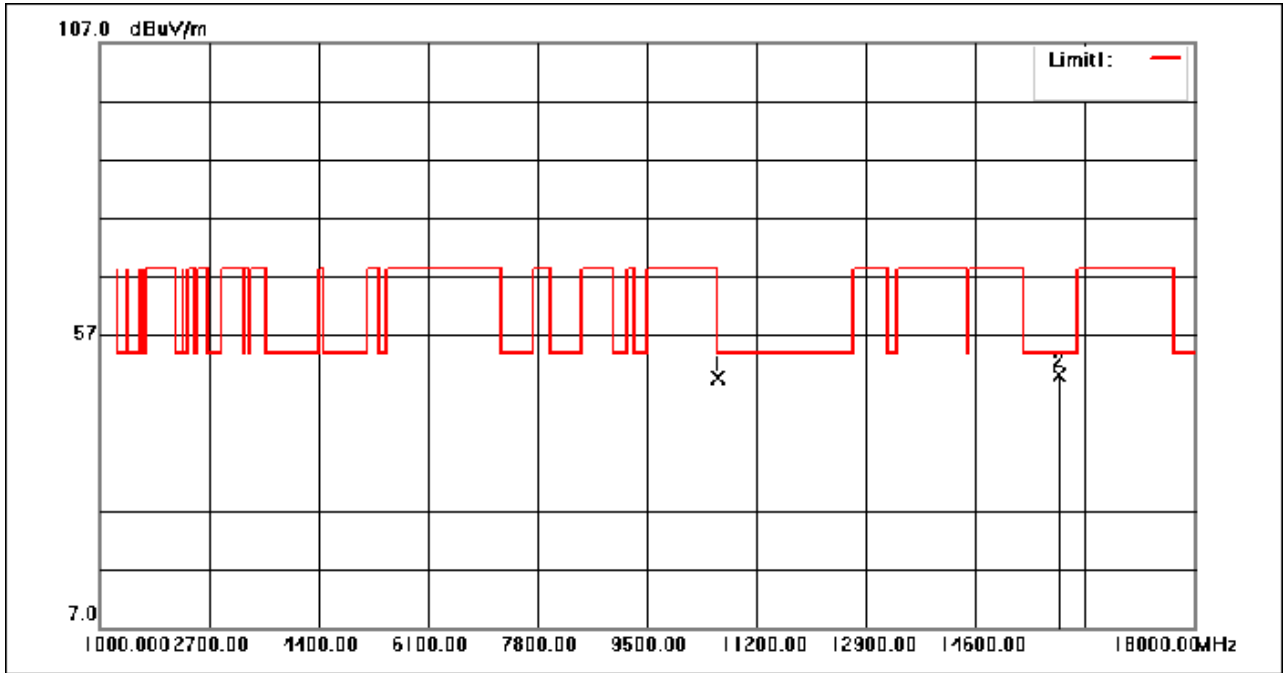

No.	Frequency (MHz)	Reading (dBuV)	Correction factor(dB/m)	Result (dBuV/m)	Limit (dBuV/m)	Margin (dB)	Remark
1	10600.000	49.17	0.46	49.63	54.00	-4.37	peak
2	15900.000	43.73	6.48	50.21	54.00	-3.79	peak



Unless otherwise agreed in writing, this document is issued by the Company subject to its General Conditions of Service printed overleaf, available on request or accessible at <http://www.sgs.com/en/Terms-and-Conditions.aspx> and, for electronic format documents, subject to Terms and Conditions for Electronic Documents at <http://www.sgs.com/en/Terms-and-Conditions/Terms-e-Documents.aspx>. Attention is drawn to the limitation of liability, indemnification and jurisdiction issues defined therein. Any holder of this document is advised that information contained hereon reflects the Company's findings at the time of its intervention only and within the limits of Client's instructions, if any. The Company's sole responsibility is to its Client and this document does not exonerate parties to a transaction from exercising all their rights and obligations under the transaction documents. This document cannot be reproduced except in full, without prior written approval of the Company. Any unauthorized alteration, forgery or falsification of the content or appearance of this document is unlawful and offenders may be prosecuted to the fullest extent of the law. Unless otherwise stated the results shown in this test report refer only to the sample(s) tested and such sample(s) are retained for 30 days only.  
**Attention: To check the authenticity of testing /inspection report & certificate, please contact us at telephone: (86-755) 8307 1443, or email: CN.Doccheck@sgs.com**

No.10, Weiye Road, Innovation Park, Kunshan, Jiangsu, China 215300  
 中国·江苏·昆山市留学生创业园伟业路10号 邮编 215300

t(86-512)57355888 f(86-512)57370818 www.sgsgroup.com.cn  
 t(86-512)57355888 f(86-512)57370818 sgs.china@sgs.com

Test Mode: 02; Polarity: Horizontal; Modulation:802.11ac; Bandwidth:20MHz; Channel:High

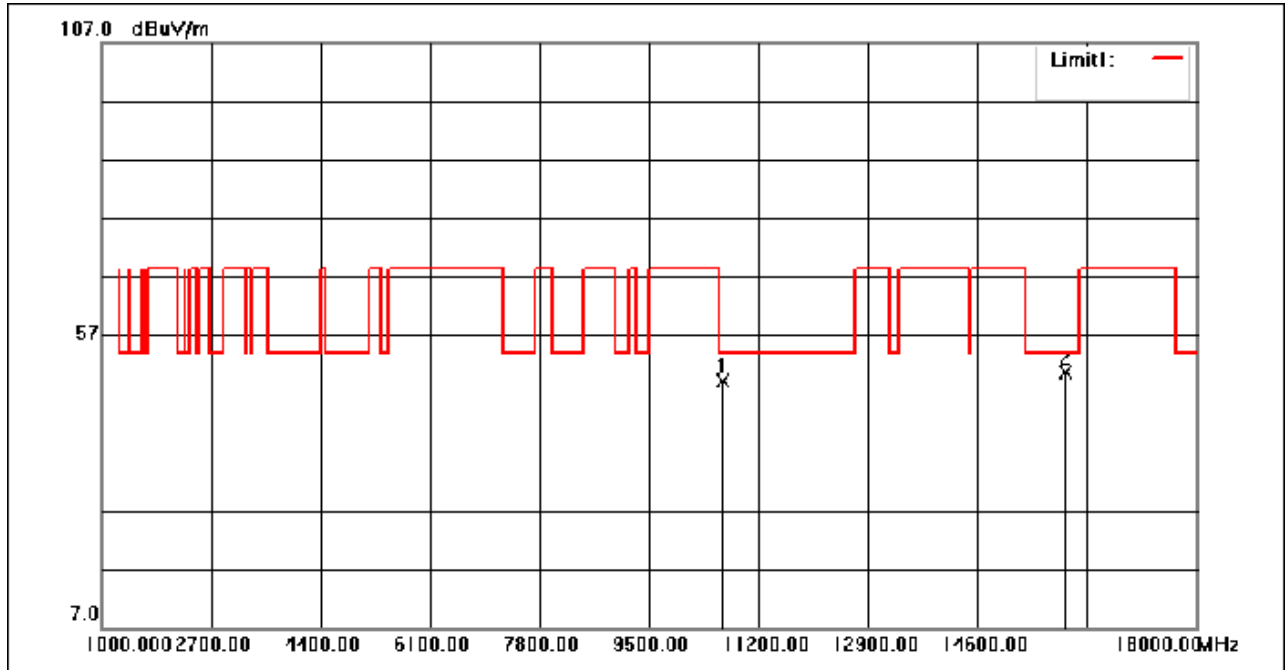

No.	Frequency (MHz)	Reading (dBuV)	Correction factor(dB/m)	Result (dBuV/m)	Limit (dBuV/m)	Margin (dB)	Remark
1	10640.000	48.60	0.46	49.06	54.00	-4.94	peak
2	15960.000	44.09	6.60	50.69	54.00	-3.31	peak



Unless otherwise agreed in writing, this document is issued by the Company subject to its General Conditions of Service printed overleaf, available on request or accessible at <http://www.sgs.com/en/Terms-and-Conditions.aspx> and, for electronic format documents, subject to Terms and Conditions for Electronic Documents at <http://www.sgs.com/en/Terms-and-Conditions/Terms-e-Documents.aspx>. Attention is drawn to the limitation of liability, indemnification and jurisdiction issues defined therein. Any holder of this document is advised that information contained hereon reflects the Company's findings at the time of its intervention only and within the limits of Client's instructions, if any. The Company's sole responsibility is to its Client and this document does not exonerate parties to a transaction from exercising all their rights and obligations under the transaction documents. This document cannot be reproduced except in full, without prior written approval of the Company. Any unauthorized alteration, forgery or falsification of the content or appearance of this document is unlawful and offenders may be prosecuted to the fullest extent of the law. Unless otherwise stated the results shown in this test report refer only to the sample(s) tested and such sample(s) are retained for 30 days only.  
**Attention: To check the authenticity of testing /inspection report & certificate, please contact us at telephone: (86-755) 8307 1443, or email: CN.Doccheck@sgs.com**

No.10, Weiye Road, Innovation Park, Kunshan, Jiangsu, China 215300  
 中国·江苏·昆山市留学生创业园伟业路10号 邮编 215300

t(86-512)57355888 f(86-512)57370818 www.sgsgroup.com.cn  
 t(86-512)57355888 f(86-512)57370818 sgs.china@sgs.com

Test Mode: 02; Polarity: Vertical; Modulation:802.11ac; Bandwidth:20MHz; Channel:High

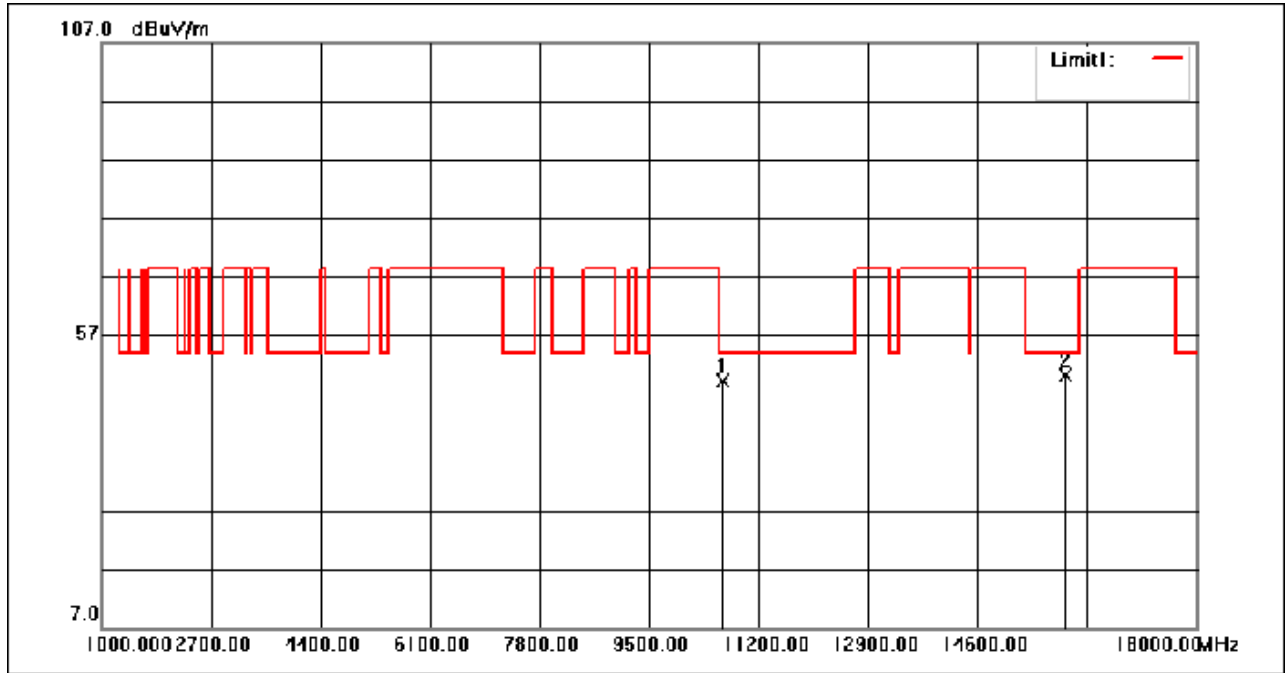

No.	Frequency (MHz)	Reading (dBuV)	Correction factor(dB/m)	Result (dBuV/m)	Limit (dBuV/m)	Margin (dB)	Remark
1	10640.000	48.64	0.46	49.10	54.00	-4.90	peak
2	15960.000	43.61	6.60	50.21	54.00	-3.79	peak



Unless otherwise agreed in writing, this document is issued by the Company subject to its General Conditions of Service printed overleaf, available on request or accessible at <http://www.sgs.com/en/Terms-and-Conditions.aspx> and, for electronic format documents, subject to Terms and Conditions for Electronic Documents at <http://www.sgs.com/en/Terms-and-Conditions/Terms-e-Documents.aspx>. Attention is drawn to the limitation of liability, indemnification and jurisdiction issues defined therein. Any holder of this document is advised that information contained hereon reflects the Company's findings at the time of its intervention only and within the limits of Client's instructions, if any. The Company's sole responsibility is to its Client and this document does not exonerate parties to a transaction from exercising all their rights and obligations under the transaction documents. This document cannot be reproduced except in full, without prior written approval of the Company. Any unauthorized alteration, forgery or falsification of the content or appearance of this document is unlawful and offenders may be prosecuted to the fullest extent of the law. Unless otherwise stated the results shown in this test report refer only to the sample(s) tested and such sample(s) are retained for 30 days only.  
**Attention: To check the authenticity of testing /inspection report & certificate, please contact us at telephone: (86-755) 8307 1443, or email: CN.Doccheck@sgs.com**

No.10, Weiye Road, Innovation Park, Kunshan, Jiangsu, China 215300  
 中国·江苏·昆山市留学生创业园伟业路10号 邮编 215300

t(86-512)57355888 f(86-512)57370818 www.sgsgroup.com.cn  
 t(86-512)57355888 f(86-512)57370818 sgs.china@sgs.com

Test Mode: 02; Polarity: Horizontal; Modulation:802.11ac; Bandwidth:40MHz; Channel:Low

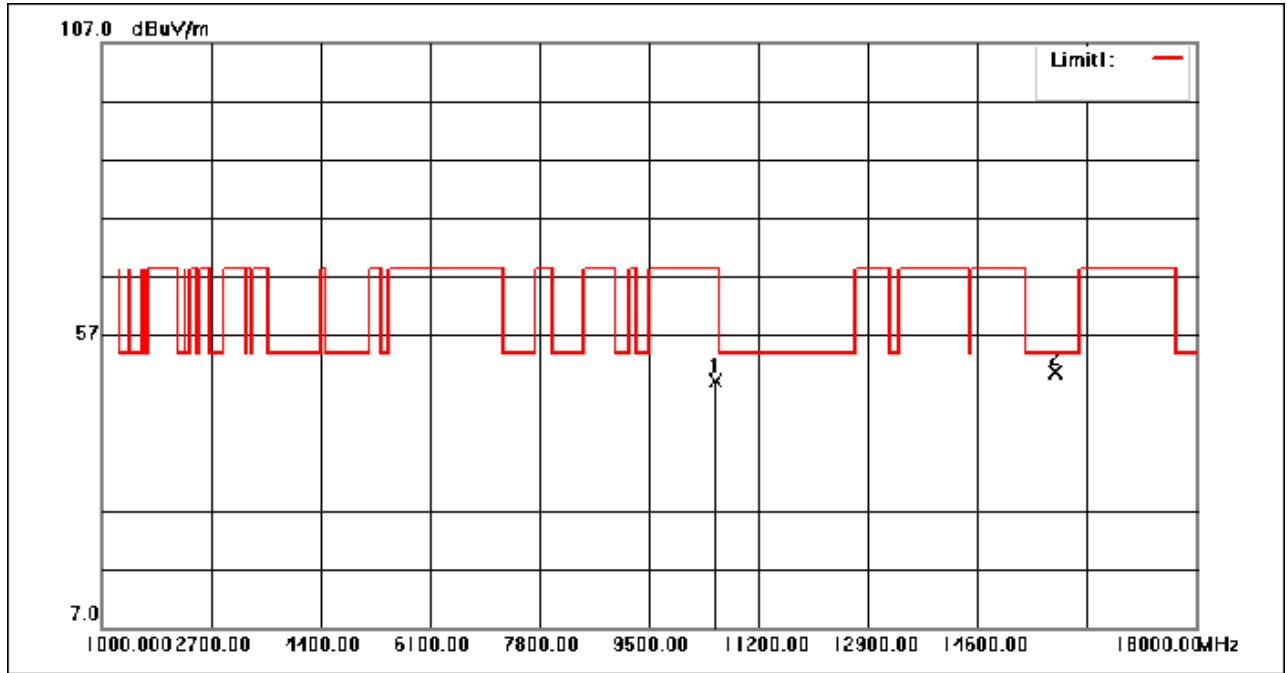

No.	Frequency (MHz)	Reading (dBuV)	Correction factor(dB/m)	Result (dBuV/m)	Limit (dBuV/m)	Margin (dB)	Remark
1	10540.000	48.62	0.44	49.06	68.30	-19.24	peak
2	15810.000	44.40	6.29	50.69	54.00	-3.31	peak



Unless otherwise agreed in writing, this document is issued by the Company subject to its General Conditions of Service printed overleaf, available on request or accessible at <http://www.sgs.com/en/Terms-and-Conditions.aspx> and, for electronic format documents, subject to Terms and Conditions for Electronic Documents at <http://www.sgs.com/en/Terms-and-Conditions/Terms-e-Documents.aspx>. Attention is drawn to the limitation of liability, indemnification and jurisdiction issues defined therein. Any holder of this document is advised that information contained hereon reflects the Company's findings at the time of its intervention only and within the limits of Client's instructions, if any. The Company's sole responsibility is to its Client and this document does not exonerate parties to a transaction from exercising all their rights and obligations under the transaction documents. This document cannot be reproduced except in full, without prior written approval of the Company. Any unauthorized alteration, forgery or falsification of the content or appearance of this document is unlawful and offenders may be prosecuted to the fullest extent of the law. Unless otherwise stated the results shown in this test report refer only to the sample(s) tested and such sample(s) are retained for 30 days only.  
**Attention: To check the authenticity of testing /inspection report & certificate, please contact us at telephone: (86-755) 8307 1443, or email: CN.Doccheck@sgs.com**

No.10, Weiye Road, Innovation Park, Kunshan, Jiangsu, China 215300  
 中国·江苏·昆山市留学生创业园伟业路10号 邮编 215300

t(86-512)57355888 f(86-512)57370818 www.sgsgroup.com.cn  
 t(86-512)57355888 f(86-512)57370818 sgs.china@sgs.com

Test Mode: 02; Polarity: Vertical; Modulation:802.11ac; Bandwidth:40MHz; Channel:Low

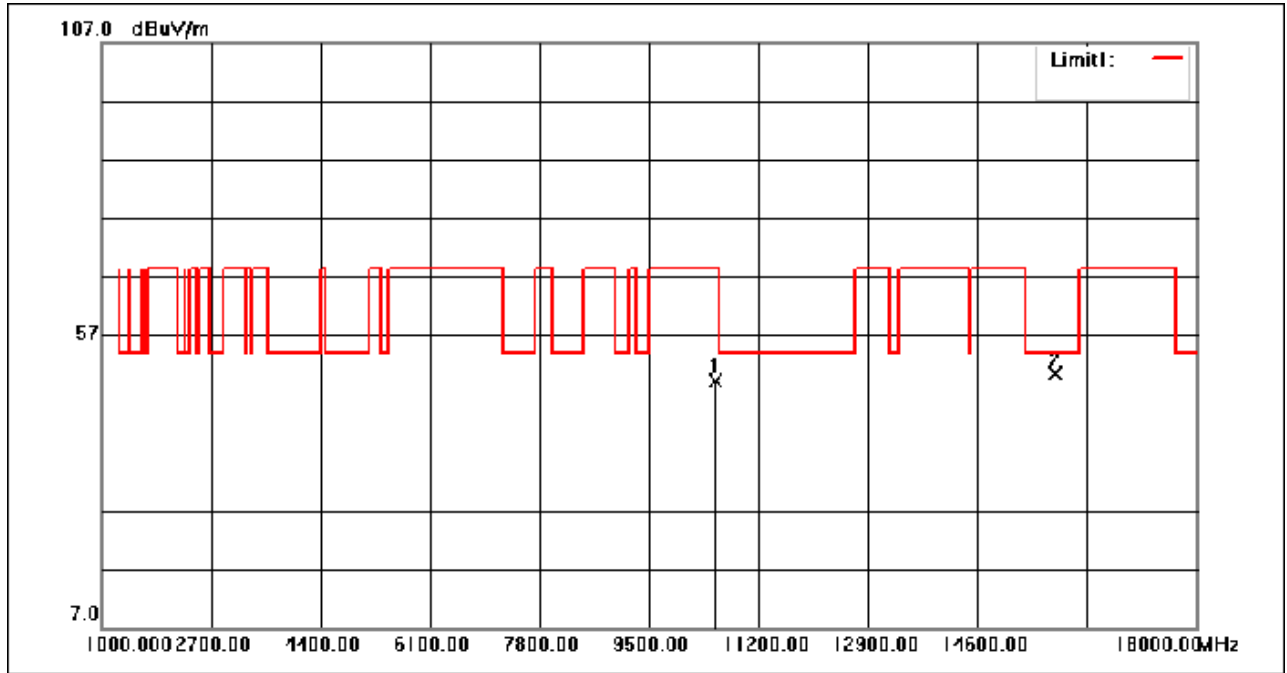

No.	Frequency (MHz)	Reading (dBuV)	Correction factor(dB/m)	Result (dBuV/m)	Limit (dBuV/m)	Margin (dB)	Remark
1	10540.000	48.59	0.44	49.03	68.30	-19.27	peak
2	15810.000	44.20	6.29	50.49	54.00	-3.51	peak



Unless otherwise agreed in writing, this document is issued by the Company subject to its General Conditions of Service printed overleaf, available on request or accessible at <http://www.sgs.com/en/Terms-and-Conditions.aspx> and, for electronic format documents, subject to Terms and Conditions for Electronic Documents at <http://www.sgs.com/en/Terms-and-Conditions/Terms-e-Documents.aspx>. Attention is drawn to the limitation of liability, indemnification and jurisdiction issues defined therein. Any holder of this document is advised that information contained hereon reflects the Company's findings at the time of its intervention only and within the limits of Client's instructions, if any. The Company's sole responsibility is to its Client and this document does not exonerate parties to a transaction from exercising all their rights and obligations under the transaction documents. This document cannot be reproduced except in full, without prior written approval of the Company. Any unauthorized alteration, forgery or falsification of the content or appearance of this document is unlawful and offenders may be prosecuted to the fullest extent of the law. Unless otherwise stated the results shown in this test report refer only to the sample(s) tested and such sample(s) are retained for 30 days only.  
**Attention: To check the authenticity of testing /inspection report & certificate, please contact us at telephone: (86-755) 8307 1443, or email: CN.Doccheck@sgs.com**

No.10, Weiye Road, Innovation Park, Kunshan, Jiangsu, China 215300  
 中国·江苏·昆山市留学生创业园伟业路10号 邮编 215300

t(86-512)57355888 f(86-512)57370818 www.sgsgroup.com.cn  
 t(86-512)57355888 f(86-512)57370818 sgs.china@sgs.com



Test Mode: 02; Polarity: Horizontal; Modulation:802.11ac; Bandwidth:40MHz; Channel:High

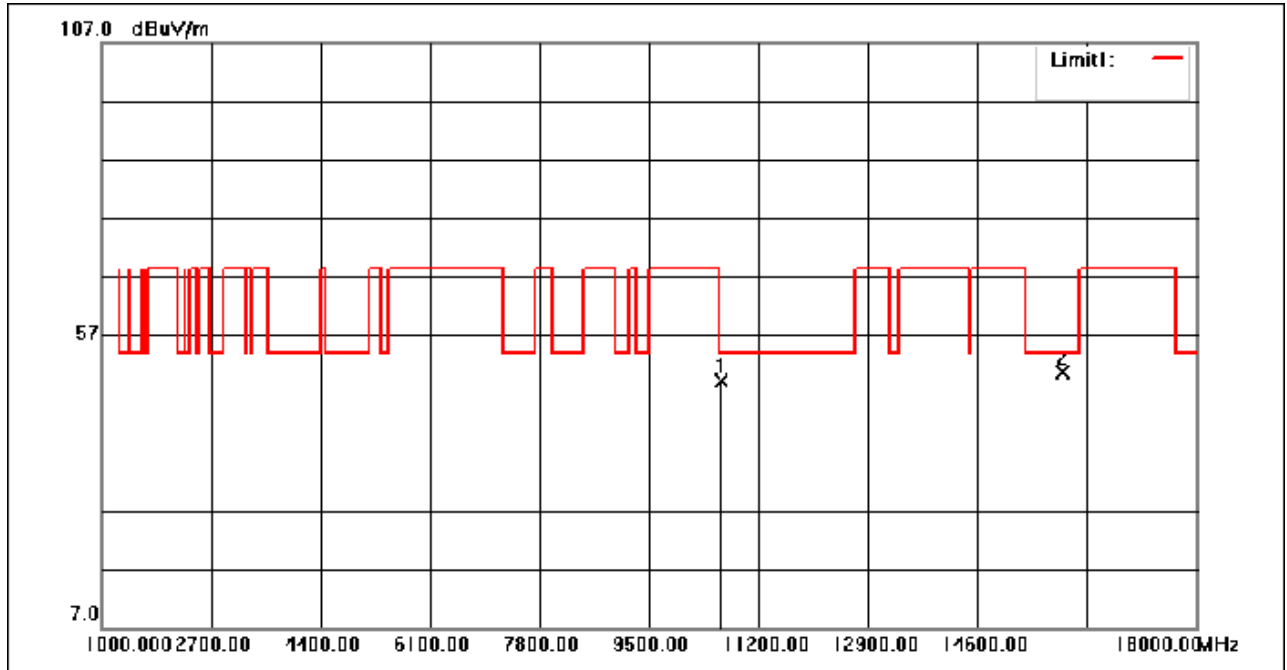

No.	Frequency (MHz)	Reading (dBuV)	Correction factor(dB/m)	Result (dBuV/m)	Limit (dBuV/m)	Margin (dB)	Remark
1	10620.000	48.70	0.46	49.16	54.00	-4.84	peak
2	15930.000	44.00	6.54	50.54	54.00	-3.46	peak



Unless otherwise agreed in writing, this document is issued by the Company subject to its General Conditions of Service printed overleaf, available on request or accessible at <http://www.sgs.com/en/Terms-and-Conditions.aspx> and, for electronic format documents, subject to Terms and Conditions for Electronic Documents at <http://www.sgs.com/en/Terms-and-Conditions/Terms-e-Documents.aspx>. Attention is drawn to the limitation of liability, indemnification and jurisdiction issues defined therein. Any holder of this document is advised that information contained hereon reflects the Company's findings at the time of its intervention only and within the limits of Client's instructions, if any. The Company's sole responsibility is to its Client and this document does not exonerate parties to a transaction from exercising all their rights and obligations under the transaction documents. This document cannot be reproduced except in full, without prior written approval of the Company. Any unauthorized alteration, forgery or falsification of the content or appearance of this document is unlawful and offenders may be prosecuted to the fullest extent of the law. Unless otherwise stated the results shown in this test report refer only to the sample(s) tested and such sample(s) are retained for 30 days only.  
**Attention: To check the authenticity of testing /inspection report & certificate, please contact us at telephone: (86-755) 8307 1443, or email: CN.Doccheck@sgs.com**

No.10, Weiye Road, Innovation Park, Kunshan, Jiangsu, China 215300  
 中国·江苏·昆山市留学生创业园伟业路10号 邮编 215300

t(86-512)57355888 f(86-512)57370818 www.sgs.com.cn  
 t(86-512)57355888 f(86-512)57370818 sgs.china@sgs.com

Test Mode: 02; Polarity: Vertical; Modulation:802.11ac; Bandwidth:40MHz; Channel:High

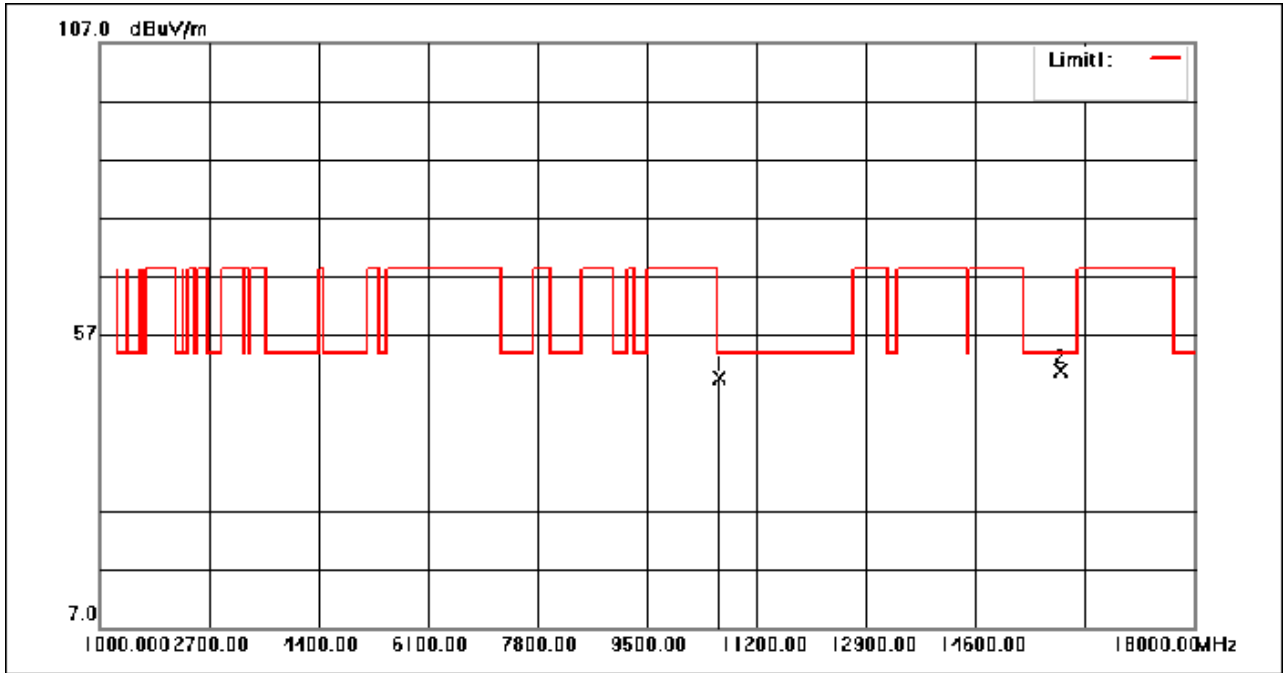

No.	Frequency (MHz)	Reading (dBuV)	Correction factor(dB/m)	Result (dBuV/m)	Limit (dBuV/m)	Margin (dB)	Remark
1	10620.000	49.06	0.46	49.52	54.00	-4.48	peak
2	15930.000	44.37	6.54	50.91	54.00	-3.09	peak



Unless otherwise agreed in writing, this document is issued by the Company subject to its General Conditions of Service printed overleaf, available on request or accessible at <http://www.sgs.com/en/Terms-and-Conditions.aspx> and, for electronic format documents, subject to Terms and Conditions for Electronic Documents at <http://www.sgs.com/en/Terms-and-Conditions/Terms-e-Documents.aspx>. Attention is drawn to the limitation of liability, indemnification and jurisdiction issues defined therein. Any holder of this document is advised that information contained hereon reflects the Company's findings at the time of its intervention only and within the limits of Client's instructions, if any. The Company's sole responsibility is to its Client and this document does not exonerate parties to a transaction from exercising all their rights and obligations under the transaction documents. This document cannot be reproduced except in full, without prior written approval of the Company. Any unauthorized alteration, forgery or falsification of the content or appearance of this document is unlawful and offenders may be prosecuted to the fullest extent of the law. Unless otherwise stated the results shown in this test report refer only to the sample(s) tested and such sample(s) are retained for 30 days only.  
**Attention: To check the authenticity of testing /inspection report & certificate, please contact us at telephone: (86-755) 8307 1443, or email: CN.Doccheck@sgs.com**

No.10, Weiye Road, Innovation Park, Kunshan, Jiangsu, China 215300  
 中国·江苏·昆山市留学生创业园伟业路10号 邮编 215300

t(86-512)57355888 f(86-512)57370818 www.sgsgroup.com.cn  
 t(86-512)57355888 f(86-512)57370818 sgs.china@sgs.com

Test Mode: 02; Polarity: Horizontal; Modulation:802.11ac; Bandwidth:80MHz; Channel:middle

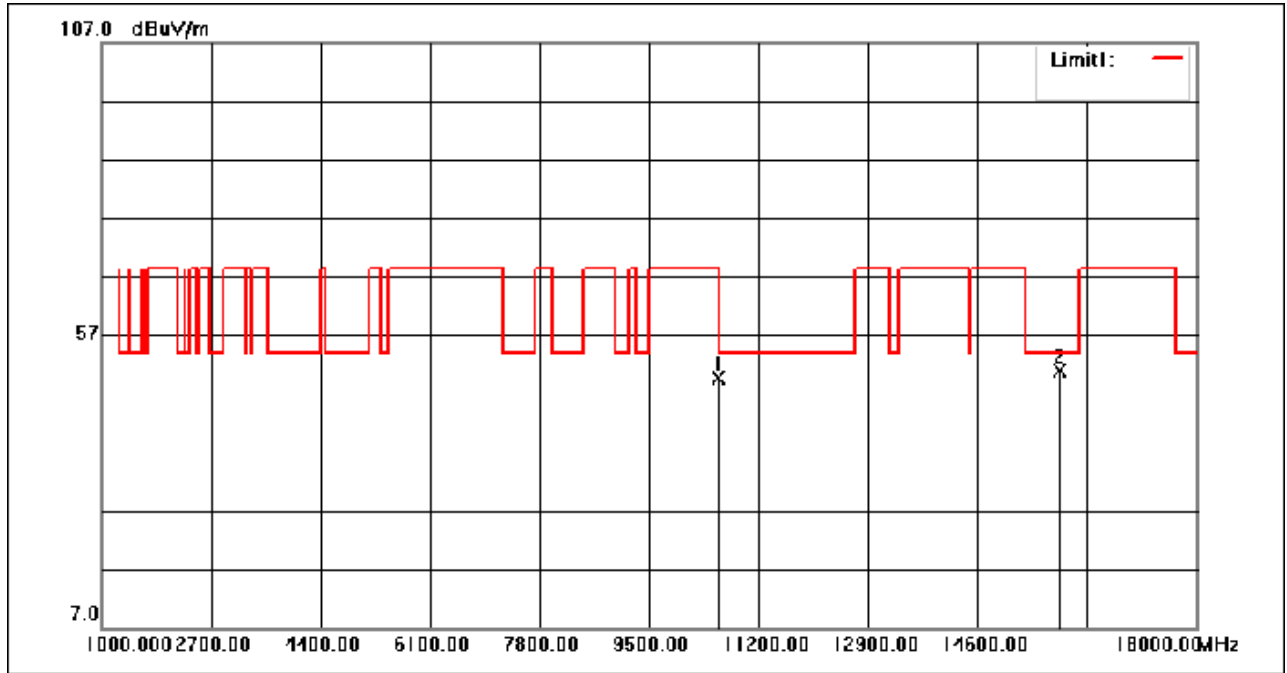

No.	Frequency (MHz)	Reading (dBuV)	Correction factor(dB/m)	Result (dBuV/m)	Limit (dBuV/m)	Margin (dB)	Remark
1	10580.000	49.18	0.46	49.64	68.30	-18.66	peak
2	15870.000	44.47	6.41	50.88	54.00	-3.12	peak



Unless otherwise agreed in writing, this document is issued by the Company subject to its General Conditions of Service printed overleaf, available on request or accessible at <http://www.sgs.com/en/Terms-and-Conditions.aspx> and, for electronic format documents, subject to Terms and Conditions for Electronic Documents at <http://www.sgs.com/en/Terms-and-Conditions/Terms-e-Documents.aspx>. Attention is drawn to the limitation of liability, indemnification and jurisdiction issues defined therein. Any holder of this document is advised that information contained hereon reflects the Company's findings at the time of its intervention only and within the limits of Client's instructions, if any. The Company's sole responsibility is to its Client and this document does not exonerate parties to a transaction from exercising all their rights and obligations under the transaction documents. This document cannot be reproduced except in full, without prior written approval of the Company. Any unauthorized alteration, forgery or falsification of the content or appearance of this document is unlawful and offenders may be prosecuted to the fullest extent of the law. Unless otherwise stated the results shown in this test report refer only to the sample(s) tested and such sample(s) are retained for 30 days only.  
**Attention: To check the authenticity of testing /inspection report & certificate, please contact us at telephone: (86-755) 8307 1443, or email: CN.Doccheck@sgs.com**

No.10, Weiye Road, Innovation Park, Kunshan, Jiangsu, China 215300  
 中国·江苏·昆山市留学生创业园伟业路10号 邮编 215300

t(86-512)57355888 f(86-512)57370818 www.sgsgroup.com.cn  
 t(86-512)57355888 f(86-512)57370818 sgs.china@sgs.com

Test Mode: 02; Polarity: Vertical; Modulation:802.11ac; Bandwidth:80MHz; Channel:middle

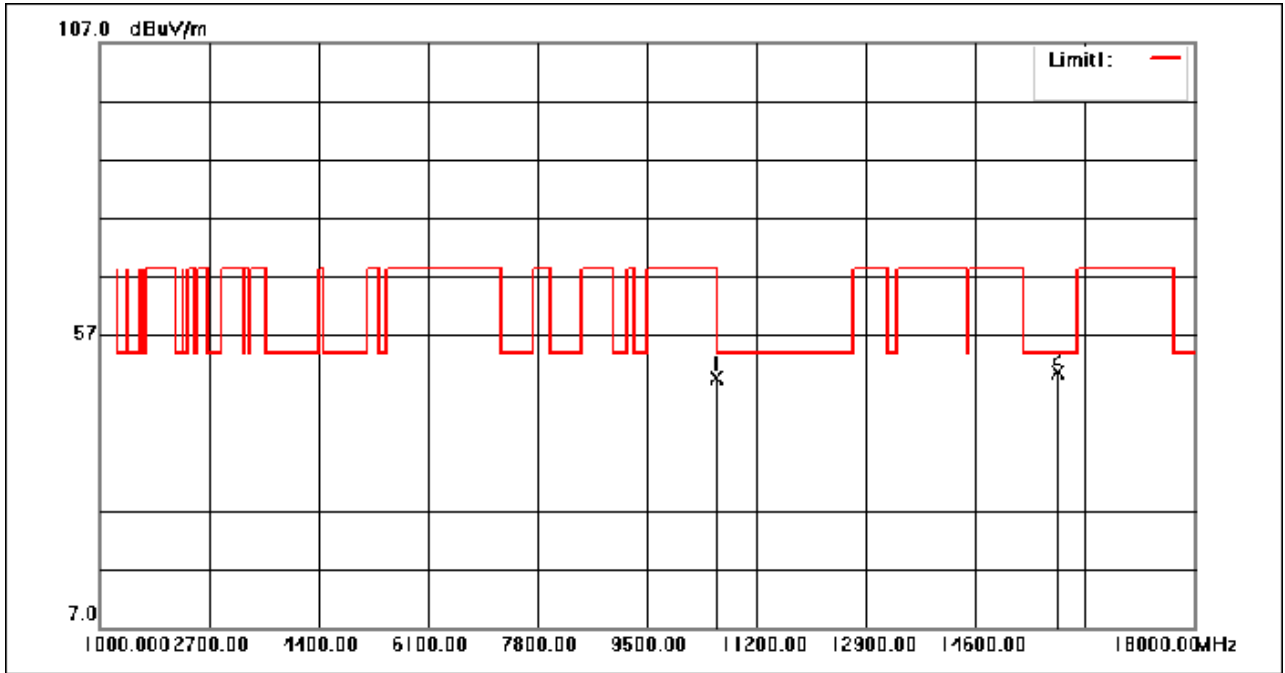

No.	Frequency (MHz)	Reading (dBuV)	Correction factor(dB/m)	Result (dBuV/m)	Limit (dBuV/m)	Margin (dB)	Remark
1	10580.000	49.25	0.46	49.71	68.30	-18.59	peak
2	15870.000	44.18	6.41	50.59	54.00	-3.41	peak



Unless otherwise agreed in writing, this document is issued by the Company subject to its General Conditions of Service printed overleaf, available on request or accessible at <http://www.sgs.com/en/Terms-and-Conditions.aspx> and, for electronic format documents, subject to Terms and Conditions for Electronic Documents at <http://www.sgs.com/en/Terms-and-Conditions/Terms-e-Documents.aspx>. Attention is drawn to the limitation of liability, indemnification and jurisdiction issues defined therein. Any holder of this document is advised that information contained hereon reflects the Company's findings at the time of its intervention only and within the limits of Client's instructions, if any. The Company's sole responsibility is to its Client and this document does not exonerate parties to a transaction from exercising all their rights and obligations under the transaction documents. This document cannot be reproduced except in full, without prior written approval of the Company. Any unauthorized alteration, forgery or falsification of the content or appearance of this document is unlawful and offenders may be prosecuted to the fullest extent of the law. Unless otherwise stated the results shown in this test report refer only to the sample(s) tested and such sample(s) are retained for 30 days only.  
**Attention: To check the authenticity of testing /inspection report & certificate, please contact us at telephone: (86-755) 8307 1443, or email: CN.Doccheck@sgs.com**

No.10, Weiye Road, Innovation Park, Kunshan, Jiangsu, China 215300  
 中国·江苏·昆山市留学生创业园伟业路10号 邮编 215300

t(86-512)57355888 f(86-512)57370818 www.sgs.com.cn  
 t(86-512)57355888 f(86-512)57370818 sgs.china@sgs.com

Test Mode: 03; Polarity: Horizontal; Modulation:802.11a; Bandwidth:20MHz; Channel:Low

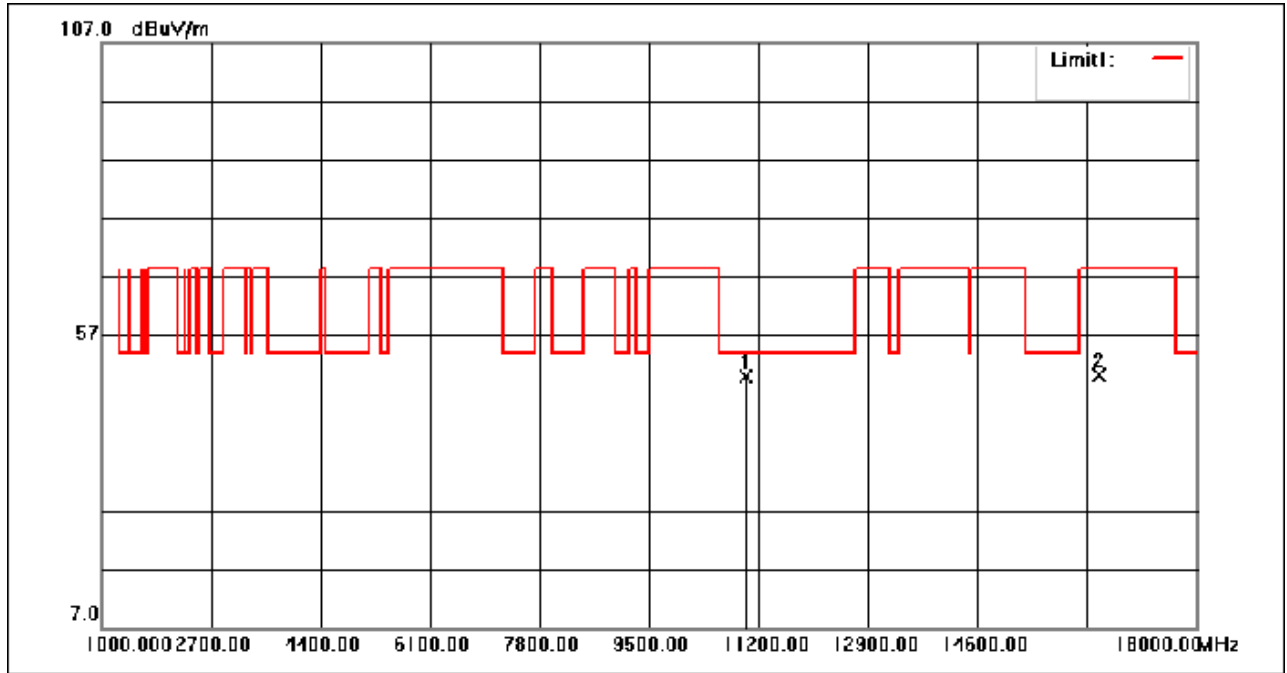

No.	Frequency (MHz)	Reading (dBuV)	Correction factor(dB/m)	Result (dBuV/m)	Limit (dBuV/m)	Margin (dB)	Remark
1	11000.000	49.22	0.54	49.76	54.00	-4.24	peak
2	16500.000	41.79	8.43	50.22	68.30	-18.08	peak



Unless otherwise agreed in writing, this document is issued by the Company subject to its General Conditions of Service printed overleaf, available on request or accessible at <http://www.sgs.com/en/Terms-and-Conditions.aspx> and, for electronic format documents, subject to Terms and Conditions for Electronic Documents at <http://www.sgs.com/en/Terms-and-Conditions/Terms-e-Documents.aspx>. Attention is drawn to the limitation of liability, indemnification and jurisdiction issues defined therein. Any holder of this document is advised that information contained hereon reflects the Company's findings at the time of its intervention only and within the limits of Client's instructions, if any. The Company's sole responsibility is to its Client and this document does not exonerate parties to a transaction from exercising all their rights and obligations under the transaction documents. This document cannot be reproduced except in full, without prior written approval of the Company. Any unauthorized alteration, forgery or falsification of the content or appearance of this document is unlawful and offenders may be prosecuted to the fullest extent of the law. Unless otherwise stated the results shown in this test report refer only to the sample(s) tested and such sample(s) are retained for 30 days only.  
**Attention: To check the authenticity of testing /inspection report & certificate, please contact us at telephone: (86-755) 8307 1443, or email: CN.Doccheck@sgs.com**

No.10, Weiye Road, Innovation Park, Kunshan, Jiangsu, China 215300  
 中国·江苏·昆山市留学生创业园伟业路10号 邮编 215300

t(86-512)57355888 f(86-512)57370818 www.sgsgroup.com.cn  
 t(86-512)57355888 f(86-512)57370818 sgs.china@sgs.com



Test Mode: 03; Polarity: Vertical; Modulation:802.11a; Bandwidth:20MHz; Channel:Low

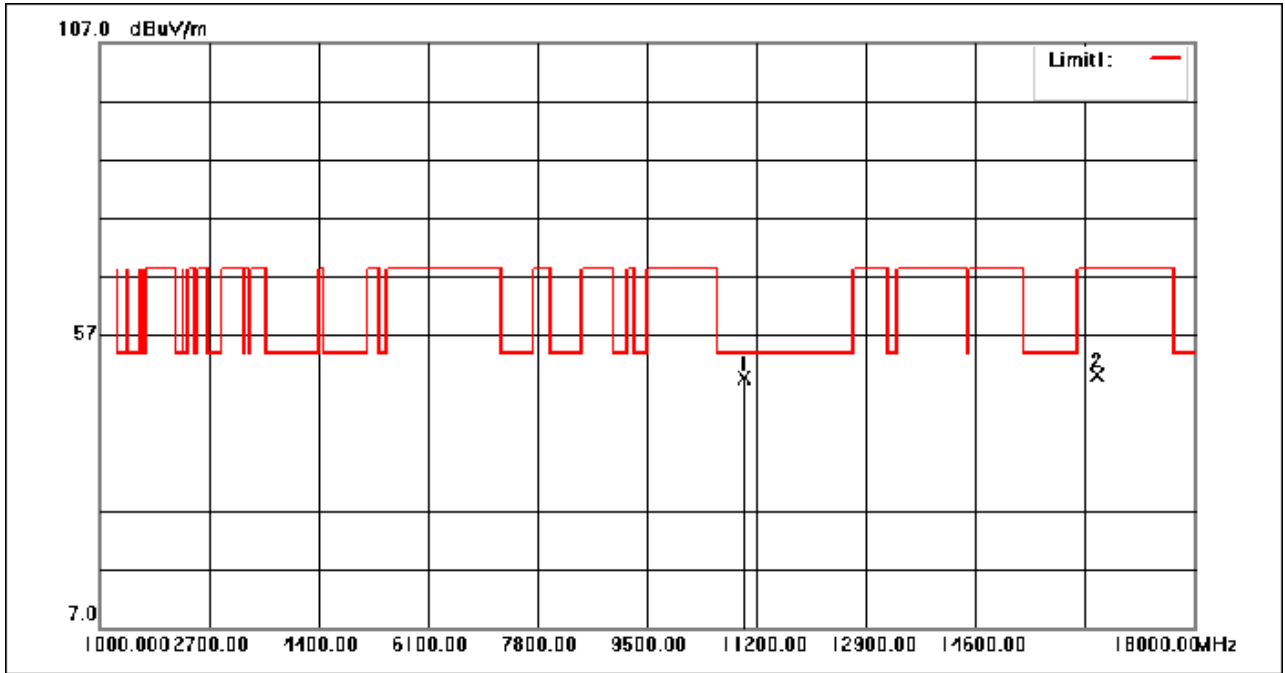

No.	Frequency (MHz)	Reading (dBuV)	Correction factor(dB/m)	Result (dBuV/m)	Limit (dBuV/m)	Margin (dB)	Remark
1	11000.000	49.14	0.54	49.68	54.00	-4.32	peak
2	16500.000	41.65	8.43	50.08	68.30	-18.22	peak



Unless otherwise agreed in writing, this document is issued by the Company subject to its General Conditions of Service printed overleaf, available on request or accessible at <http://www.sgs.com/en/Terms-and-Conditions.aspx> and, for electronic format documents, subject to Terms and Conditions for Electronic Documents at <http://www.sgs.com/en/Terms-and-Conditions/Terms-e-Documents.aspx>. Attention is drawn to the limitation of liability, indemnification and jurisdiction issues defined therein. Any holder of this document is advised that information contained hereon reflects the Company's findings at the time of its intervention only and within the limits of Client's instructions, if any. The Company's sole responsibility is to its Client and this document does not exonerate parties to a transaction from exercising all their rights and obligations under the transaction documents. This document cannot be reproduced except in full, without prior written approval of the Company. Any unauthorized alteration, forgery or falsification of the content or appearance of this document is unlawful and offenders may be prosecuted to the fullest extent of the law. Unless otherwise stated the results shown in this test report refer only to the sample(s) tested and such sample(s) are retained for 30 days only.  
**Attention: To check the authenticity of testing /inspection report & certificate, please contact us at telephone: (86-755) 8307 1443, or email: CN.Doccheck@sgs.com**

No.10, Weiye Road, Innovation Park, Kunshan, Jiangsu, China 215300  
 中国·江苏·昆山市留学生创业园伟业路10号 邮编 215300

t(86-512)57355888 f(86-512)57370818 www.sgsgroup.com.cn  
 t(86-512)57355888 f(86-512)57370818 sgs.china@sgs.com

Test Mode: 03; Polarity: Horizontal; Modulation:802.11a; Bandwidth:20MHz; Channel:middle

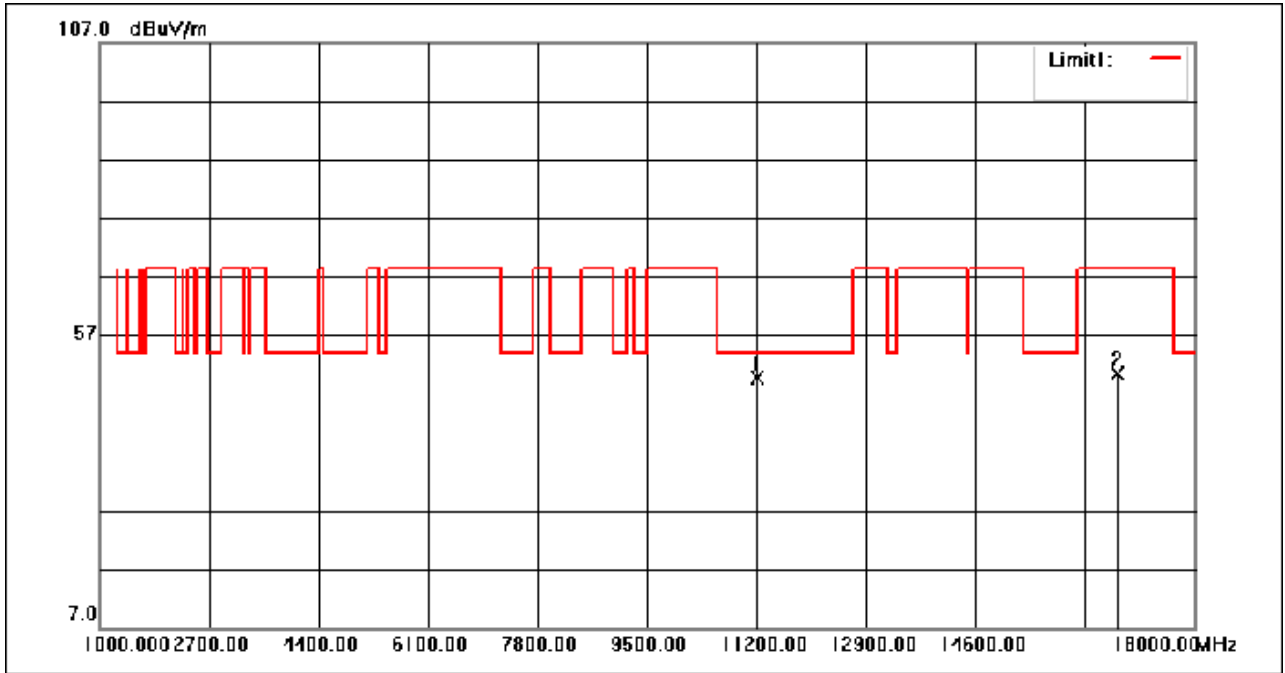

No.	Frequency (MHz)	Reading (dBuV)	Correction factor(dB/m)	Result (dBuV/m)	Limit (dBuV/m)	Margin (dB)	Remark
1	11200.000	48.98	0.71	49.69	54.00	-4.31	peak
2	16800.000	41.43	8.89	50.32	68.30	-17.98	peak



Unless otherwise agreed in writing, this document is issued by the Company subject to its General Conditions of Service printed overleaf, available on request or accessible at <http://www.sgs.com/en/Terms-and-Conditions.aspx> and, for electronic format documents, subject to Terms and Conditions for Electronic Documents at <http://www.sgs.com/en/Terms-and-Conditions/Terms-e-Documents.aspx>. Attention is drawn to the limitation of liability, indemnification and jurisdiction issues defined therein. Any holder of this document is advised that information contained hereon reflects the Company's findings at the time of its intervention only and within the limits of Client's instructions, if any. The Company's sole responsibility is to its Client and this document does not exonerate parties to a transaction from exercising all their rights and obligations under the transaction documents. This document cannot be reproduced except in full, without prior written approval of the Company. Any unauthorized alteration, forgery or falsification of the content or appearance of this document is unlawful and offenders may be prosecuted to the fullest extent of the law. Unless otherwise stated the results shown in this test report refer only to the sample(s) tested and such sample(s) are retained for 30 days only.  
**Attention: To check the authenticity of testing /inspection report & certificate, please contact us at telephone: (86-755) 8307 1443, or email: CN.Doccheck@sgs.com**

No.10, Weiye Road, Innovation Park, Kunshan, Jiangsu, China 215300  
 中国·江苏·昆山市留学生创业园伟业路10号 邮编 215300

t(86-512)57355888 f(86-512)57370818 www.sgs.com.cn  
 t(86-512)57355888 f(86-512)57370818 sgs.china@sgs.com

Test Mode: 03; Polarity: Vertical; Modulation:802.11a; Bandwidth:20MHz; Channel:middle

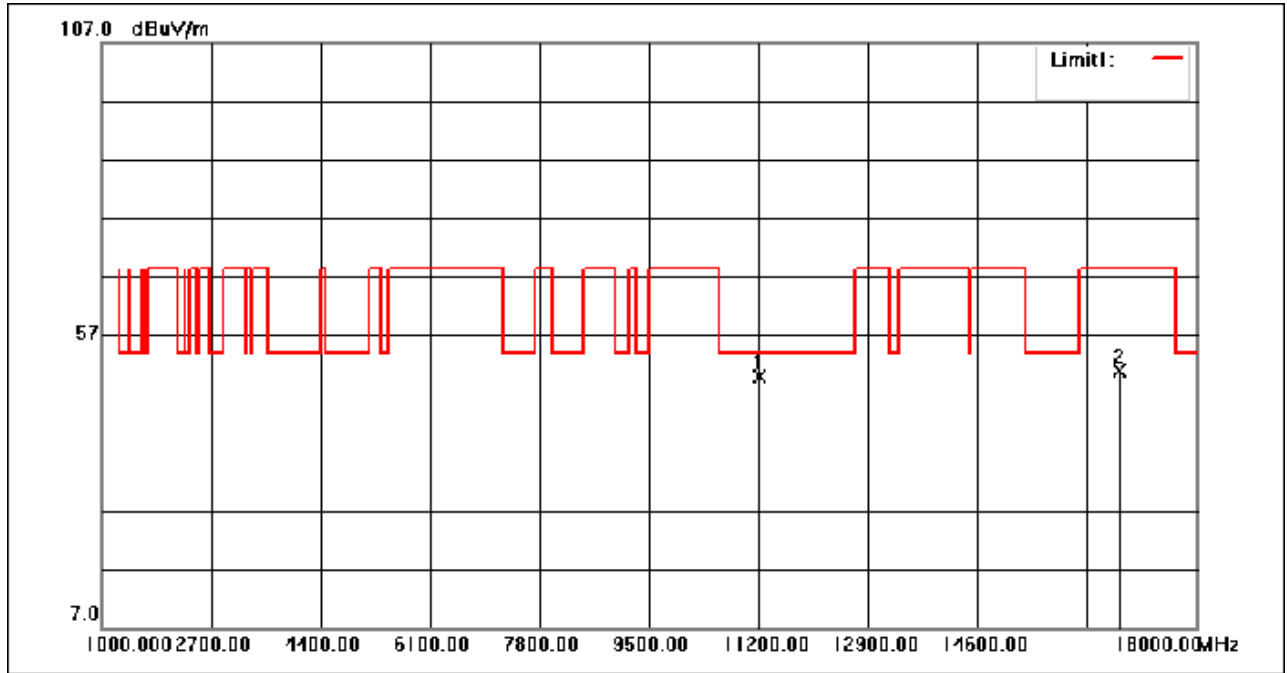

No.	Frequency (MHz)	Reading (dBuV)	Correction factor(dB/m)	Result (dBuV/m)	Limit (dBuV/m)	Margin (dB)	Remark
1	11200.000	49.11	0.71	49.82	54.00	-4.18	peak
2	16800.000	42.02	8.89	50.91	68.30	-17.39	peak



Unless otherwise agreed in writing, this document is issued by the Company subject to its General Conditions of Service printed overleaf, available on request or accessible at <http://www.sgs.com/en/Terms-and-Conditions.aspx> and, for electronic format documents, subject to Terms and Conditions for Electronic Documents at <http://www.sgs.com/en/Terms-and-Conditions/Terms-e-Documents.aspx>. Attention is drawn to the limitation of liability, indemnification and jurisdiction issues defined therein. Any holder of this document is advised that information contained hereon reflects the Company's findings at the time of its intervention only and within the limits of Client's instructions, if any. The Company's sole responsibility is to its Client and this document does not exonerate parties to a transaction from exercising all their rights and obligations under the transaction documents. This document cannot be reproduced except in full, without prior written approval of the Company. Any unauthorized alteration, forgery or falsification of the content or appearance of this document is unlawful and offenders may be prosecuted to the fullest extent of the law. Unless otherwise stated the results shown in this test report refer only to the sample(s) tested and such sample(s) are retained for 30 days only.  
**Attention: To check the authenticity of testing /inspection report & certificate, please contact us at telephone: (86-755) 8307 1443, or email: CN.Doccheck@sgs.com**

No.10, Weiye Road, Innovation Park, Kunshan, Jiangsu, China 215300  
 中国·江苏·昆山市留学生创业园伟业路10号 邮编 215300

t(86-512)57355888 f(86-512)57370818 www.sgsgroup.com.cn  
 t(86-512)57355888 f(86-512)57370818 sgs.china@sgs.com

Test Mode: 03; Polarity: Horizontal; Modulation:802.11a; Bandwidth:20MHz; Channel:High

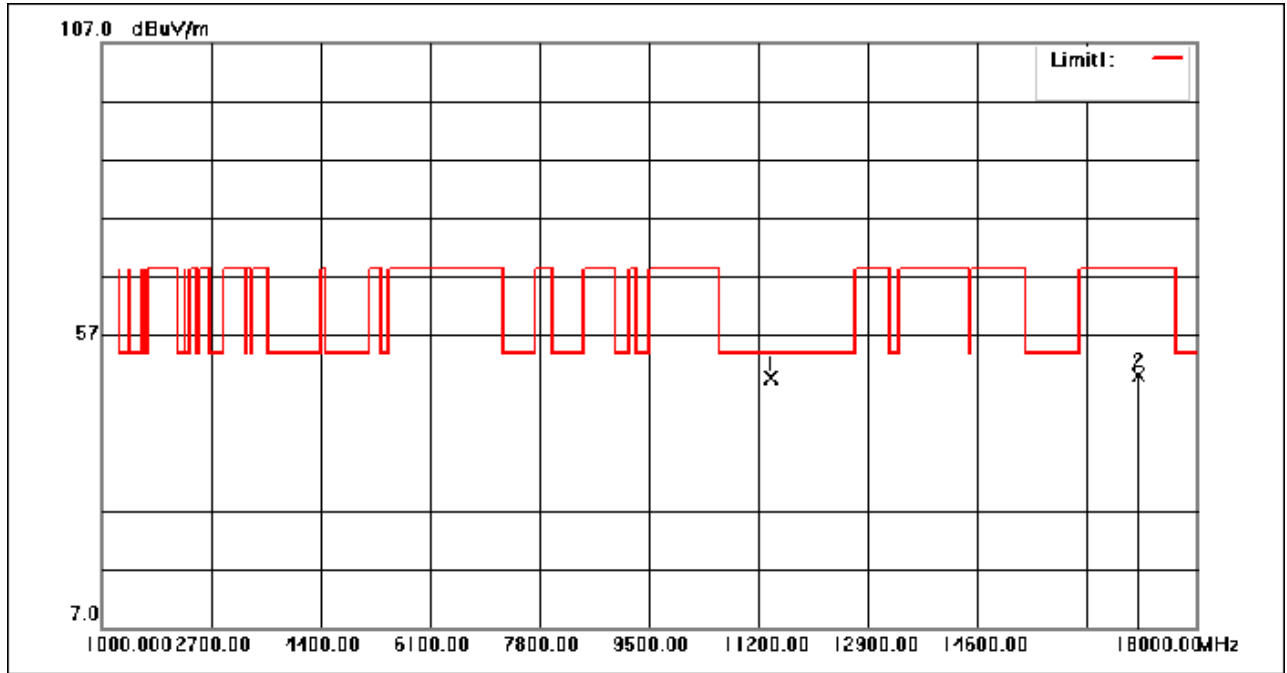

No.	Frequency (MHz)	Reading (dBuV)	Correction factor(dB/m)	Result (dBuV/m)	Limit (dBuV/m)	Margin (dB)	Remark
1	11400.000	48.72	0.87	49.59	54.00	-4.41	peak
2	17100.000	41.12	9.13	50.25	68.30	-18.05	peak



Unless otherwise agreed in writing, this document is issued by the Company subject to its General Conditions of Service printed overleaf, available on request or accessible at <http://www.sgs.com/en/Terms-and-Conditions.aspx> and, for electronic format documents, subject to Terms and Conditions for Electronic Documents at <http://www.sgs.com/en/Terms-and-Conditions/Terms-e-Documents.aspx>. Attention is drawn to the limitation of liability, indemnification and jurisdiction issues defined therein. Any holder of this document is advised that information contained hereon reflects the Company's findings at the time of its intervention only and within the limits of Client's instructions, if any. The Company's sole responsibility is to its Client and this document does not exonerate parties to a transaction from exercising all their rights and obligations under the transaction documents. This document cannot be reproduced except in full, without prior written approval of the Company. Any unauthorized alteration, forgery or falsification of the content or appearance of this document is unlawful and offenders may be prosecuted to the fullest extent of the law. Unless otherwise stated the results shown in this test report refer only to the sample(s) tested and such sample(s) are retained for 30 days only.  
**Attention: To check the authenticity of testing /inspection report & certificate, please contact us at telephone: (86-755) 8307 1443, or email: CN.Doccheck@sgs.com**

No.10, Weiye Road, Innovation Park, Kunshan, Jiangsu, China 215300  
 中国·江苏·昆山市留学生创业园伟业路10号 邮编 215300

t(86-512)57355888 f(86-512)57370818 www.sgsgroup.com.cn  
 t(86-512)57355888 f(86-512)57370818 sgs.china@sgs.com

Test Mode: 03; Polarity: Vertical; Modulation:802.11a; Bandwidth:20MHz; Channel:High

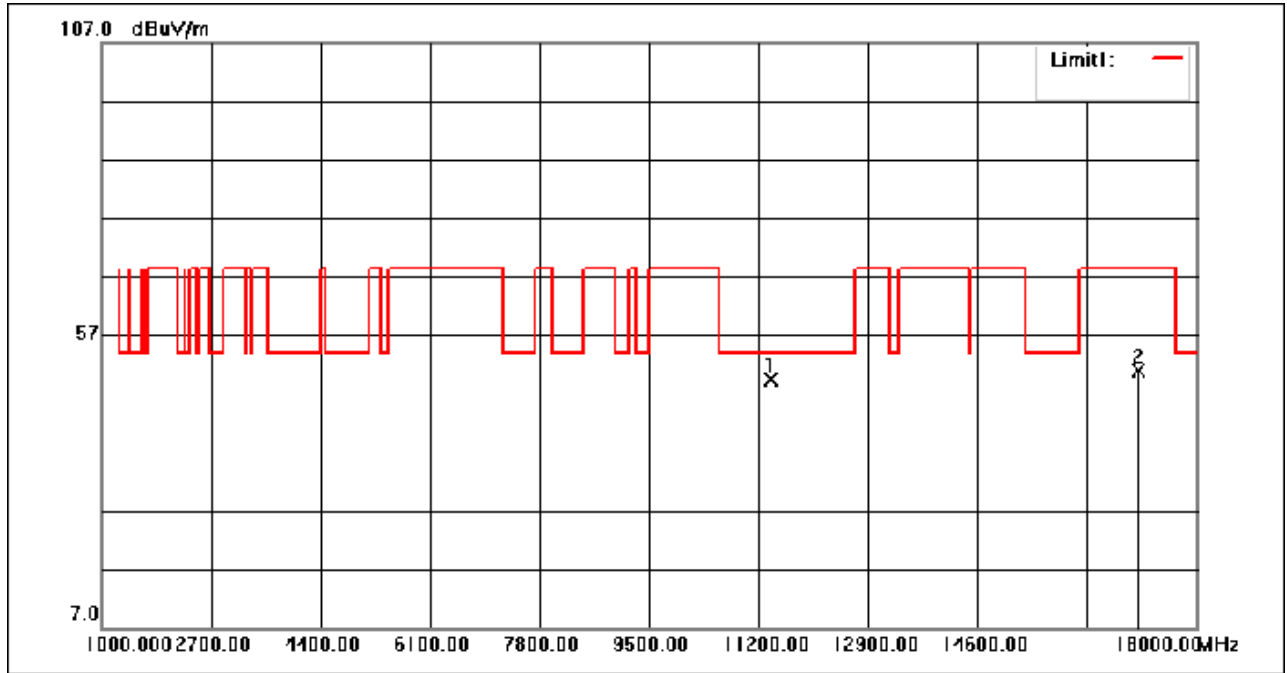

No.	Frequency (MHz)	Reading (dBuV)	Correction factor(dB/m)	Result (dBuV/m)	Limit (dBuV/m)	Margin (dB)	Remark
1	11400.000	48.58	0.87	49.45	54.00	-4.55	peak
2	17100.000	41.78	9.13	50.91	68.30	-17.39	peak



Unless otherwise agreed in writing, this document is issued by the Company subject to its General Conditions of Service printed overleaf, available on request or accessible at <http://www.sgs.com/en/Terms-and-Conditions.aspx> and, for electronic format documents, subject to Terms and Conditions for Electronic Documents at <http://www.sgs.com/en/Terms-and-Conditions/Terms-e-Documents.aspx>. Attention is drawn to the limitation of liability, indemnification and jurisdiction issues defined therein. Any holder of this document is advised that information contained hereon reflects the Company's findings at the time of its intervention only and within the limits of Client's instructions, if any. The Company's sole responsibility is to its Client and this document does not exonerate parties to a transaction from exercising all their rights and obligations under the transaction documents. This document cannot be reproduced except in full, without prior written approval of the Company. Any unauthorized alteration, forgery or falsification of the content or appearance of this document is unlawful and offenders may be prosecuted to the fullest extent of the law. Unless otherwise stated the results shown in this test report refer only to the sample(s) tested and such sample(s) are retained for 30 days only.  
**Attention: To check the authenticity of testing /inspection report & certificate, please contact us at telephone: (86-755) 8307 1443, or email: CN.Doccheck@sgs.com**

No.10, Weiye Road, Innovation Park, Kunshan, Jiangsu, China 215300  
 中国·江苏·昆山市留学生创业园伟业路10号 邮编 215300

t(86-512)57355888 f(86-512)57370818 www.sgsgroup.com.cn  
 t(86-512)57355888 f(86-512)57370818 sgs.china@sgs.com



Test Mode: 03; Polarity: Horizontal; Modulation:802.11n; Bandwidth:20MHz; Channel:Low

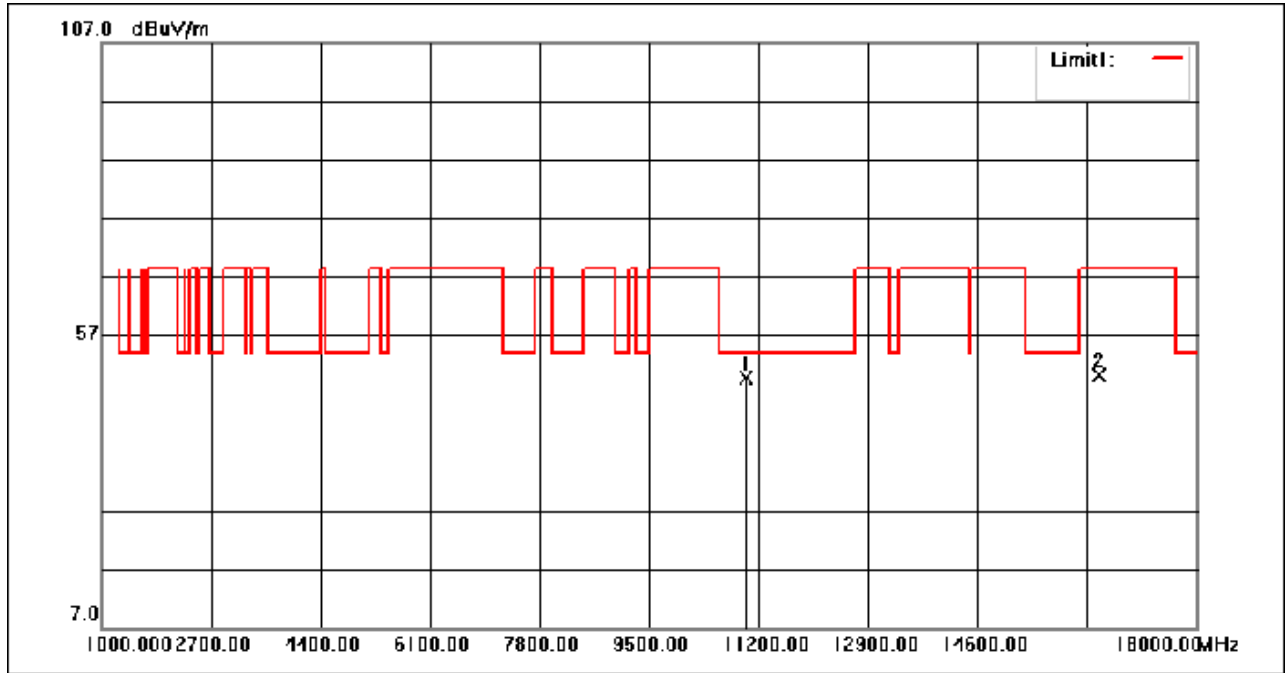

No.	Frequency (MHz)	Reading (dBuV)	Correction factor(dB/m)	Result (dBuV/m)	Limit (dBuV/m)	Margin (dB)	Remark
1	11000.000	49.10	0.54	49.64	54.00	-4.36	peak
2	16500.000	41.63	8.43	50.06	68.30	-18.24	peak



Unless otherwise agreed in writing, this document is issued by the Company subject to its General Conditions of Service printed overleaf, available on request or accessible at <http://www.sgs.com/en/Terms-and-Conditions.aspx> and, for electronic format documents, subject to Terms and Conditions for Electronic Documents at <http://www.sgs.com/en/Terms-and-Conditions/Terms-e-Documents.aspx>. Attention is drawn to the limitation of liability, indemnification and jurisdiction issues defined therein. Any holder of this document is advised that information contained hereon reflects the Company's findings at the time of its intervention only and within the limits of Client's instructions, if any. The Company's sole responsibility is to its Client and this document does not exonerate parties to a transaction from exercising all their rights and obligations under the transaction documents. This document cannot be reproduced except in full, without prior written approval of the Company. Any unauthorized alteration, forgery or falsification of the content or appearance of this document is unlawful and offenders may be prosecuted to the fullest extent of the law. Unless otherwise stated the results shown in this test report refer only to the sample(s) tested and such sample(s) are retained for 30 days only.  
**Attention: To check the authenticity of testing /inspection report & certificate, please contact us at telephone: (86-755) 8307 1443, or email: CN.Doccheck@sgs.com**

No.10, Weiye Road, Innovation Park, Kunshan, Jiangsu, China 215300  
 中国·江苏·昆山市留学生创业园伟业路10号 邮编 215300

t(86-512)57355888 f(86-512)57370818 www.sgsgroup.com.cn  
 t(86-512)57355888 f(86-512)57370818 sgs.china@sgs.com

Test Mode: 03; Polarity: Vertical; Modulation:802.11n; Bandwidth:20MHz; Channel:Low

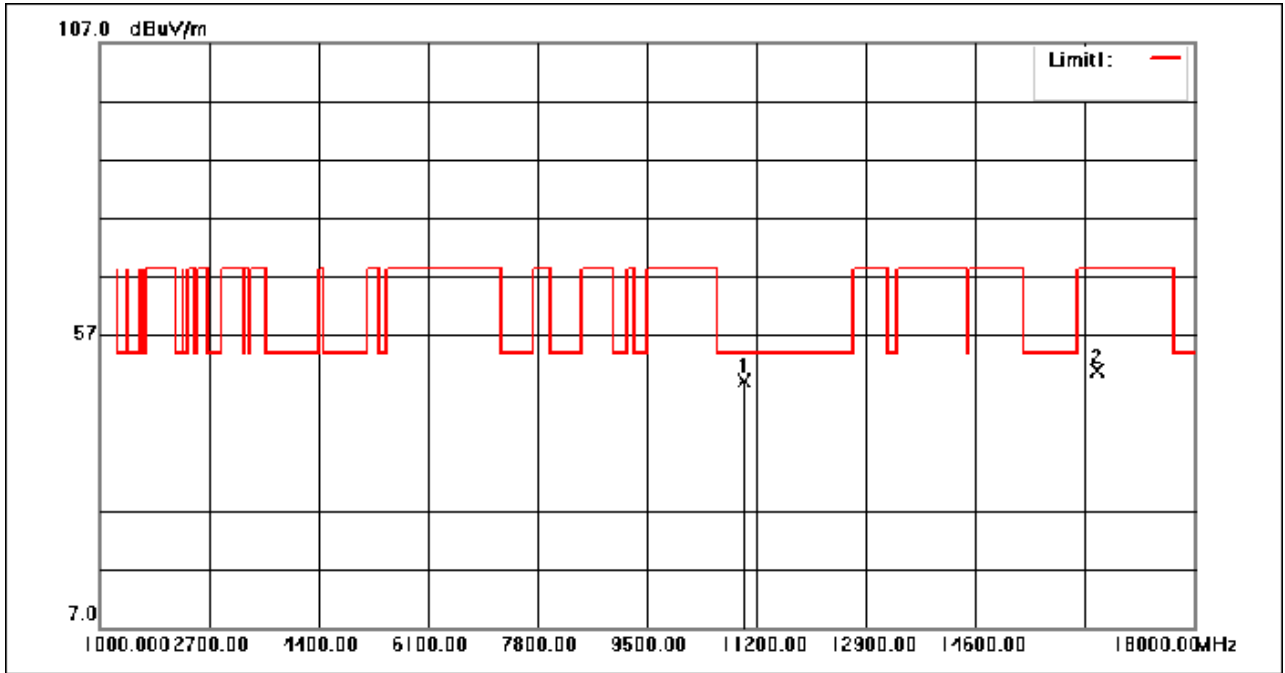

No.	Frequency (MHz)	Reading (dBuV)	Correction factor(dB/m)	Result (dBuV/m)	Limit (dBuV/m)	Margin (dB)	Remark
1	11000.000	48.49	0.54	49.03	54.00	-4.97	peak
2	16500.000	42.55	8.43	50.98	68.30	-17.32	peak



Unless otherwise agreed in writing, this document is issued by the Company subject to its General Conditions of Service printed overleaf, available on request or accessible at <http://www.sgs.com/en/Terms-and-Conditions.aspx> and, for electronic format documents, subject to Terms and Conditions for Electronic Documents at <http://www.sgs.com/en/Terms-and-Conditions/Terms-e-Documents.aspx>. Attention is drawn to the limitation of liability, indemnification and jurisdiction issues defined therein. Any holder of this document is advised that information contained hereon reflects the Company's findings at the time of its intervention only and within the limits of Client's instructions, if any. The Company's sole responsibility is to its Client and this document does not exonerate parties to a transaction from exercising all their rights and obligations under the transaction documents. This document cannot be reproduced except in full, without prior written approval of the Company. Any unauthorized alteration, forgery or falsification of the content or appearance of this document is unlawful and offenders may be prosecuted to the fullest extent of the law. Unless otherwise stated the results shown in this test report refer only to the sample(s) tested and such sample(s) are retained for 30 days only.  
**Attention: To check the authenticity of testing /inspection report & certificate, please contact us at telephone: (86-755) 8307 1443, or email: CN.Doccheck@sgs.com**

No.10, Weiye Road, Innovation Park, Kunshan, Jiangsu, China 215300  
 中国·江苏·昆山市留学生创业园伟业路10号 邮编 215300

t(86-512)57355888 f(86-512)57370818 www.sgsgroup.com.cn  
 t(86-512)57355888 f(86-512)57370818 sgs.china@sgs.com

Test Mode: 03; Polarity: Horizontal; Modulation:802.11n; Bandwidth:20MHz; Channel:middle

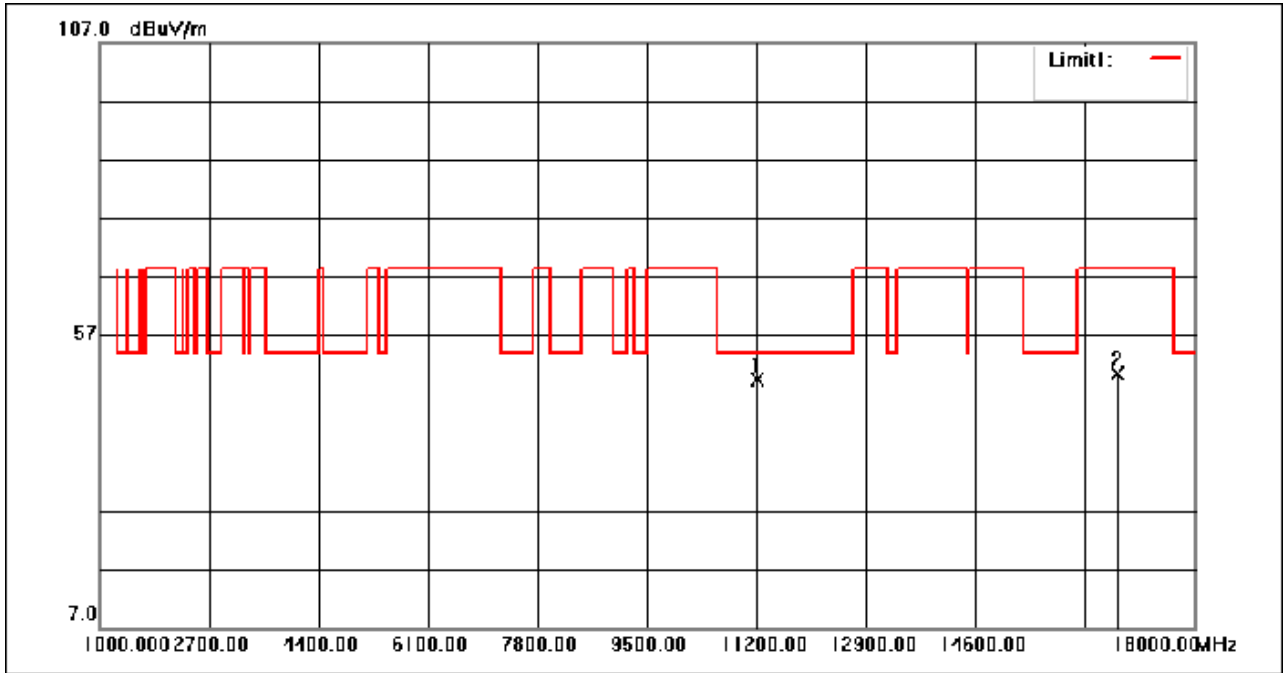

No.	Frequency (MHz)	Reading (dBuV)	Correction factor(dB/m)	Result (dBuV/m)	Limit (dBuV/m)	Margin (dB)	Remark
1	11200.000	48.76	0.71	49.47	54.00	-4.53	peak
2	16800.000	41.46	8.89	50.35	68.30	-17.95	peak



Unless otherwise agreed in writing, this document is issued by the Company subject to its General Conditions of Service printed overleaf, available on request or accessible at <http://www.sgs.com/en/Terms-and-Conditions.aspx> and, for electronic format documents, subject to Terms and Conditions for Electronic Documents at <http://www.sgs.com/en/Terms-and-Conditions/Terms-e-Document.aspx>. Attention is drawn to the limitation of liability, indemnification and jurisdiction issues defined therein. Any holder of this document is advised that information contained hereon reflects the Company's findings at the time of its intervention only and within the limits of Client's instructions, if any. The Company's sole responsibility is to its Client and this document does not exonerate parties to a transaction from exercising all their rights and obligations under the transaction documents. This document cannot be reproduced except in full, without prior written approval of the Company. Any unauthorized alteration, forgery or falsification of the content or appearance of this document is unlawful and offenders may be prosecuted to the fullest extent of the law. Unless otherwise stated the results shown in this test report refer only to the sample(s) tested and such sample(s) are retained for 30 days only.  
**Attention: To check the authenticity of testing /inspection report & certificate, please contact us at telephone: (86-755) 8307 1443, or email: CN.Doccheck@sgs.com**

No.10, Weiye Road, Innovation Park, Kunshan, Jiangsu, China 215300  
 中国·江苏·昆山市留学生创业园伟业路10号 邮编 215300

t(86-512)57355888 f(86-512)57370818 www.sgsgroup.com.cn  
 t(86-512)57355888 f(86-512)57370818 sgs.china@sgs.com

Test Mode: 03; Polarity: Vertical; Modulation:802.11n; Bandwidth:20MHz; Channel:middle

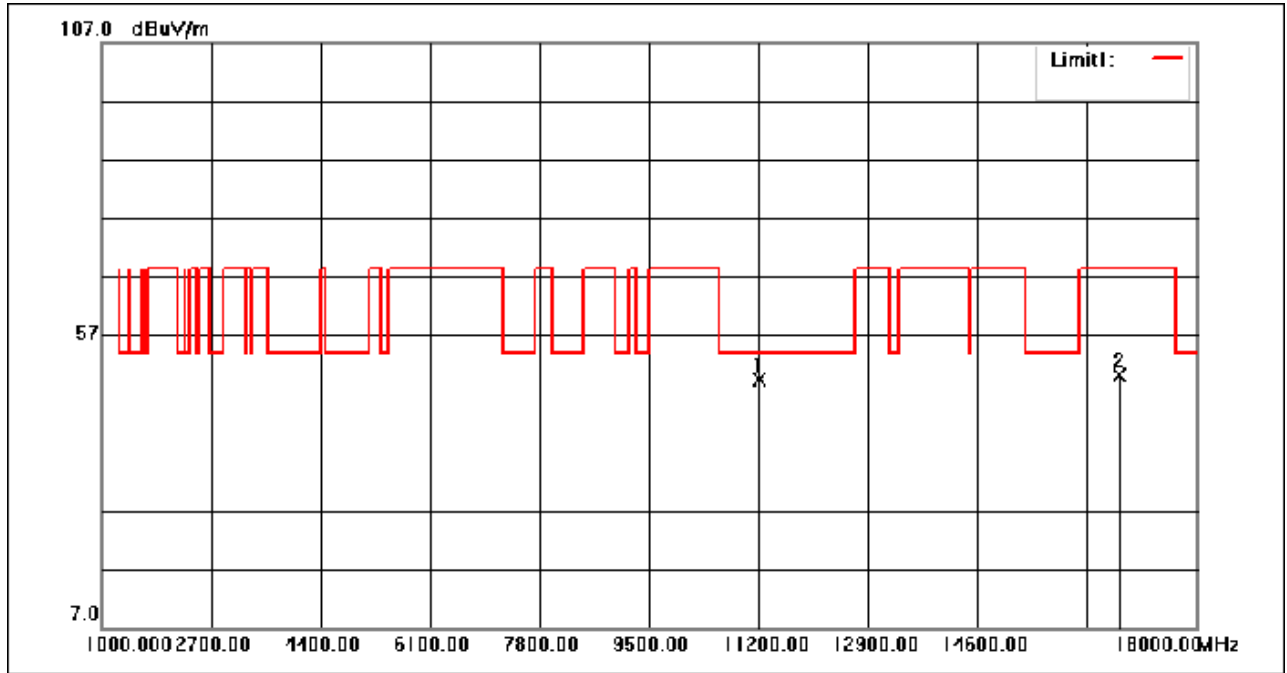

No.	Frequency (MHz)	Reading (dBuV)	Correction factor(dB/m)	Result (dBuV/m)	Limit (dBuV/m)	Margin (dB)	Remark
1	11200.000	48.66	0.71	49.37	54.00	-4.63	peak
2	16800.000	41.13	8.89	50.02	68.30	-18.28	peak



Unless otherwise agreed in writing, this document is issued by the Company subject to its General Conditions of Service printed overleaf, available on request or accessible at <http://www.sgs.com/en/Terms-and-Conditions.aspx> and, for electronic format documents, subject to Terms and Conditions for Electronic Documents at <http://www.sgs.com/en/Terms-and-Conditions/Terms-e-Documents.aspx>. Attention is drawn to the limitation of liability, indemnification and jurisdiction issues defined therein. Any holder of this document is advised that information contained hereon reflects the Company's findings at the time of its intervention only and within the limits of Client's instructions, if any. The Company's sole responsibility is to its Client and this document does not exonerate parties to a transaction from exercising all their rights and obligations under the transaction documents. This document cannot be reproduced except in full, without prior written approval of the Company. Any unauthorized alteration, forgery or falsification of the content or appearance of this document is unlawful and offenders may be prosecuted to the fullest extent of the law. Unless otherwise stated the results shown in this test report refer only to the sample(s) tested and such sample(s) are retained for 30 days only.  
**Attention: To check the authenticity of testing /inspection report & certificate, please contact us at telephone: (86-755) 8307 1443, or email: CN.Doccheck@sgs.com**

No.10, Weiye Road, Innovation Park, Kunshan, Jiangsu, China 215300  
 中国·江苏·昆山市留学生创业园伟业路10号 邮编 215300

t(86-512)57355888 f(86-512)57370818 www.sgsgroup.com.cn  
 t(86-512)57355888 f(86-512)57370818 sgs.china@sgs.com

Test Mode: 03; Polarity: Horizontal; Modulation:802.11n; Bandwidth:20MHz; Channel:High

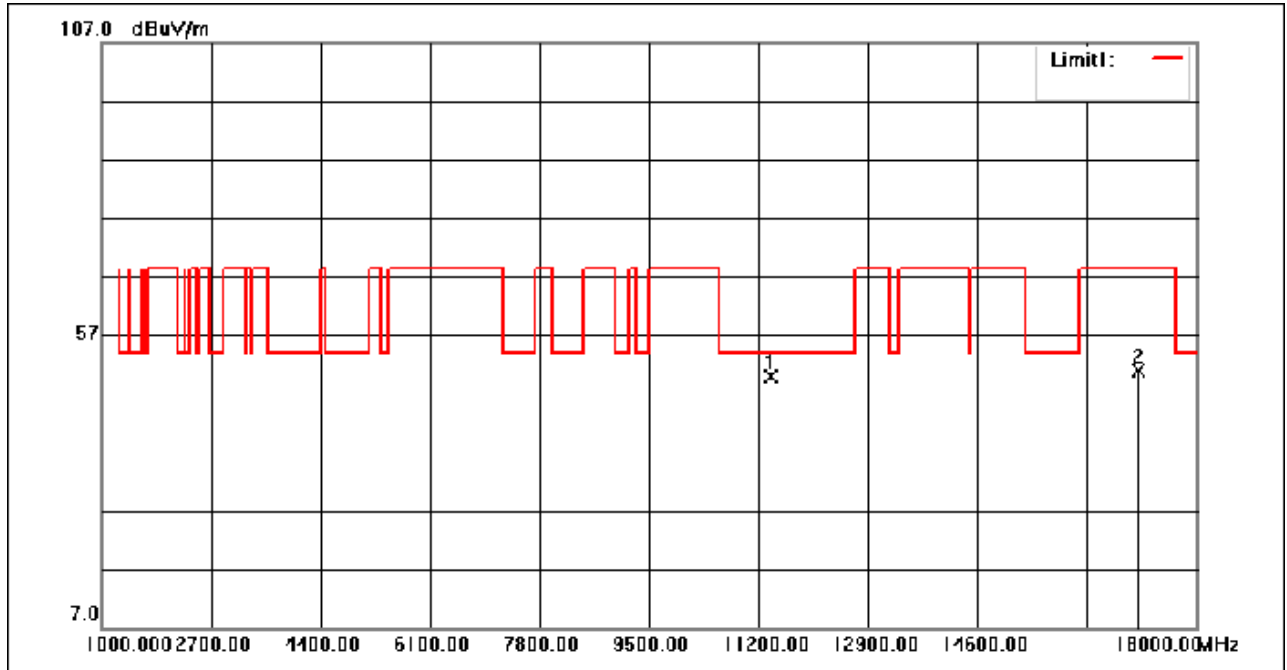

No.	Frequency (MHz)	Reading (dBuV)	Correction factor(dB/m)	Result (dBuV/m)	Limit (dBuV/m)	Margin (dB)	Remark
1	11400.000	49.10	0.87	49.97	54.00	-4.03	peak
2	17100.000	41.80	9.13	50.93	68.30	-17.37	peak



Unless otherwise agreed in writing, this document is issued by the Company subject to its General Conditions of Service printed overleaf, available on request or accessible at <http://www.sgs.com/en/Terms-and-Conditions.aspx> and, for electronic format documents, subject to Terms and Conditions for Electronic Documents at <http://www.sgs.com/en/Terms-and-Conditions/Terms-e-Documents.aspx>. Attention is drawn to the limitation of liability, indemnification and jurisdiction issues defined therein. Any holder of this document is advised that information contained hereon reflects the Company's findings at the time of its intervention only and within the limits of Client's instructions, if any. The Company's sole responsibility is to its Client and this document does not exonerate parties to a transaction from exercising all their rights and obligations under the transaction documents. This document cannot be reproduced except in full, without prior written approval of the Company. Any unauthorized alteration, forgery or falsification of the content or appearance of this document is unlawful and offenders may be prosecuted to the fullest extent of the law. Unless otherwise stated the results shown in this test report refer only to the sample(s) tested and such sample(s) are retained for 30 days only.  
**Attention: To check the authenticity of testing /inspection report & certificate, please contact us at telephone: (86-755) 8307 1443, or email: CN.Doccheck@sgs.com**

No.10, Weiye Road, Innovation Park, Kunshan, Jiangsu, China 215300  
 中国·江苏·昆山市留学生创业园伟业路10号 邮编 215300

t(86-512)57355888 f(86-512)57370818 www.sgsgroup.com.cn  
 t(86-512)57355888 f(86-512)57370818 sgs.china@sgs.com



Test Mode: 03; Polarity: Vertical; Modulation:802.11n; Bandwidth:20MHz; Channel:High

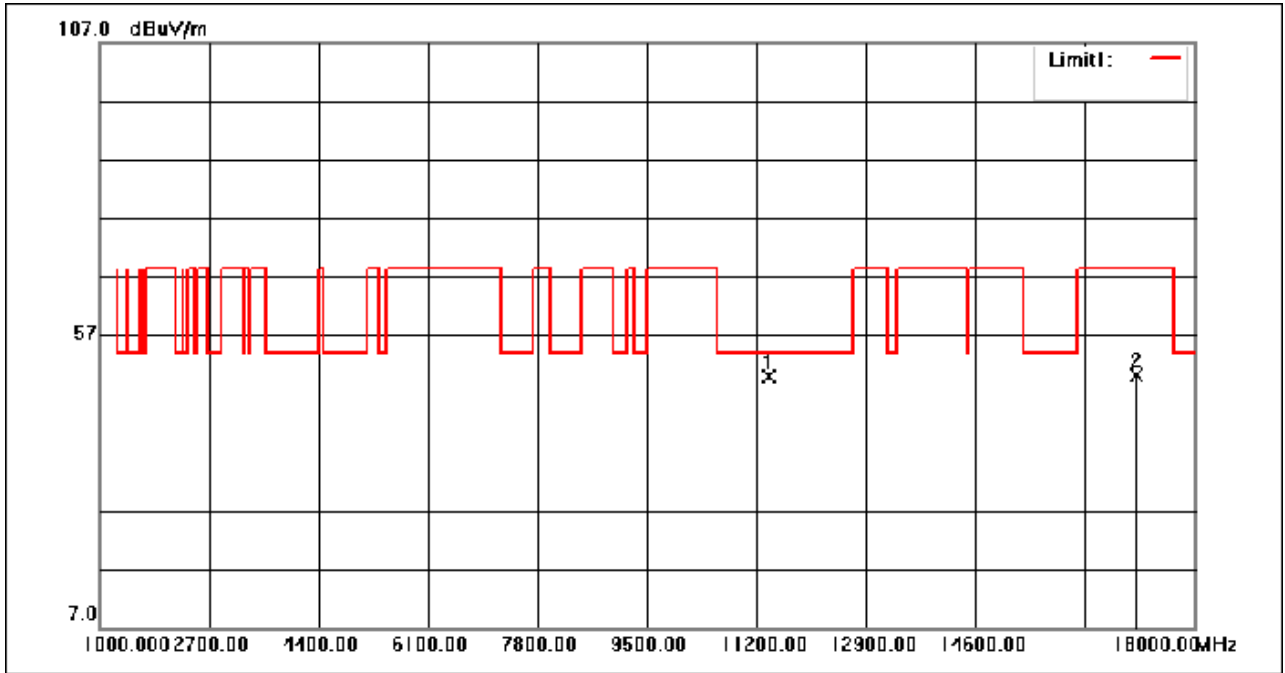

No.	Frequency (MHz)	Reading (dBuV)	Correction factor(dB/m)	Result (dBuV/m)	Limit (dBuV/m)	Margin (dB)	Remark
1	11400.000	48.92	0.87	49.79	54.00	-4.21	peak
2	17100.000	41.03	9.13	50.16	68.30	-18.14	peak



Unless otherwise agreed in writing, this document is issued by the Company subject to its General Conditions of Service printed overleaf, available on request or accessible at <http://www.sgs.com/en/Terms-and-Conditions.aspx> and, for electronic format documents, subject to Terms and Conditions for Electronic Documents at <http://www.sgs.com/en/Terms-and-Conditions/Terms-e-Document.aspx>. Attention is drawn to the limitation of liability, indemnification and jurisdiction issues defined therein. Any holder of this document is advised that information contained hereon reflects the Company's findings at the time of its intervention only and within the limits of Client's instructions, if any. The Company's sole responsibility is to its Client and this document does not exonerate parties to a transaction from exercising all their rights and obligations under the transaction documents. This document cannot be reproduced except in full, without prior written approval of the Company. Any unauthorized alteration, forgery or falsification of the content or appearance of this document is unlawful and offenders may be prosecuted to the fullest extent of the law. Unless otherwise stated the results shown in this test report refer only to the sample(s) tested and such sample(s) are retained for 30 days only.  
**Attention: To check the authenticity of testing /inspection report & certificate, please contact us at telephone: (86-755) 8307 1443, or email: CN.Doccheck@sgs.com**

No.10, Weiye Road, Innovation Park, Kunshan, Jiangsu, China 215300  
 中国·江苏·昆山市留学生创业园伟业路10号 邮编 215300

t(86-512)57355888 f(86-512)57370818 www.sgsgroup.com.cn  
 t(86-512)57355888 f(86-512)57370818 sgs.china@sgs.com

Test Mode: 03; Polarity: Horizontal; Modulation:802.11n; Bandwidth:40MHz; Channel:Low

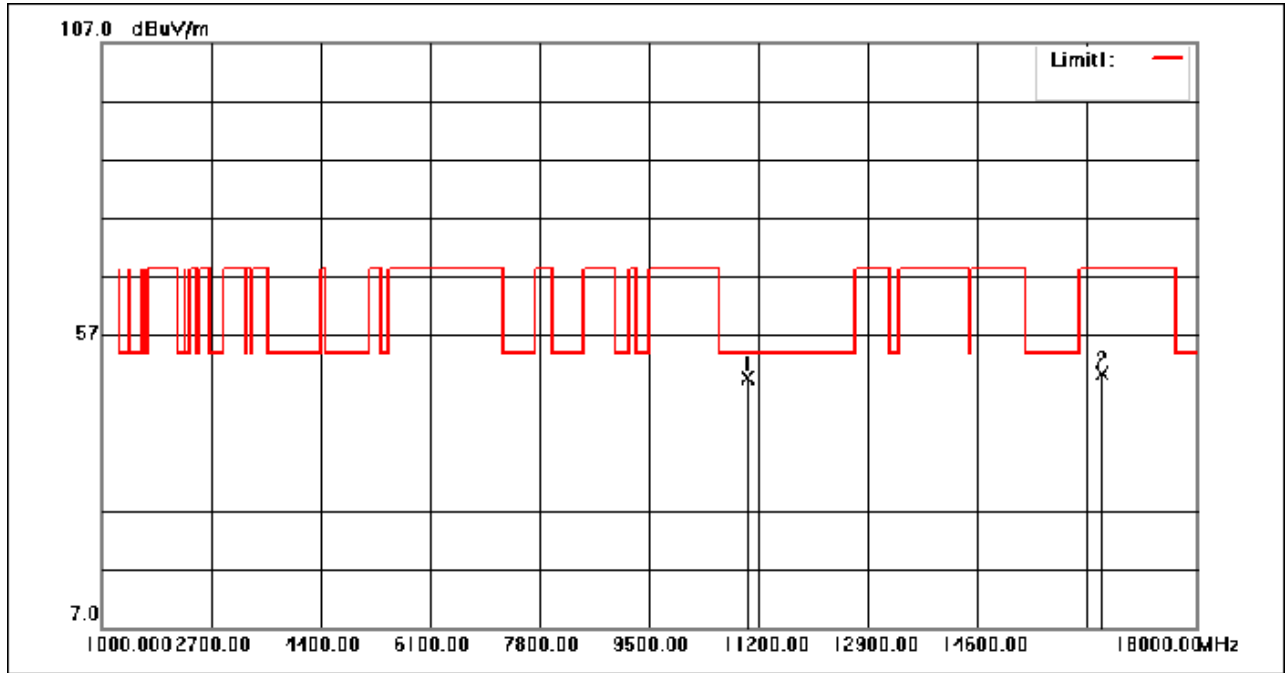

No.	Frequency (MHz)	Reading (dBuV)	Correction factor(dB/m)	Result (dBuV/m)	Limit (dBuV/m)	Margin (dB)	Remark
1	11020.000	49.13	0.56	49.69	54.00	-4.31	peak
2	16530.000	41.89	8.47	50.36	68.30	-17.94	peak



Unless otherwise agreed in writing, this document is issued by the Company subject to its General Conditions of Service printed overleaf, available on request or accessible at <http://www.sgs.com/en/Terms-and-Conditions.aspx> and, for electronic format documents, subject to Terms and Conditions for Electronic Documents at <http://www.sgs.com/en/Terms-and-Conditions/Terms-e-Documents.aspx>. Attention is drawn to the limitation of liability, indemnification and jurisdiction issues defined therein. Any holder of this document is advised that information contained hereon reflects the Company's findings at the time of its intervention only and within the limits of Client's instructions, if any. The Company's sole responsibility is to its Client and this document does not exonerate parties to a transaction from exercising all their rights and obligations under the transaction documents. This document cannot be reproduced except in full, without prior written approval of the Company. Any unauthorized alteration, forgery or falsification of the content or appearance of this document is unlawful and offenders may be prosecuted to the fullest extent of the law. Unless otherwise stated the results shown in this test report refer only to the sample(s) tested and such sample(s) are retained for 30 days only.  
**Attention: To check the authenticity of testing /inspection report & certificate, please contact us at telephone: (86-755) 8307 1443, or email: CN.Doccheck@sgs.com**

No.10, Weiye Road, Innovation Park, Kunshan, Jiangsu, China 215300  
 中国·江苏·昆山市留学生创业园伟业路10号 邮编 215300

t(86-512)57355888 f(86-512)57370818 www.sgsgroup.com.cn  
 t(86-512)57355888 f(86-512)57370818 sgs.china@sgs.com

Test Mode: 03; Polarity: Vertical; Modulation:802.11n; Bandwidth:40MHz; Channel:Low

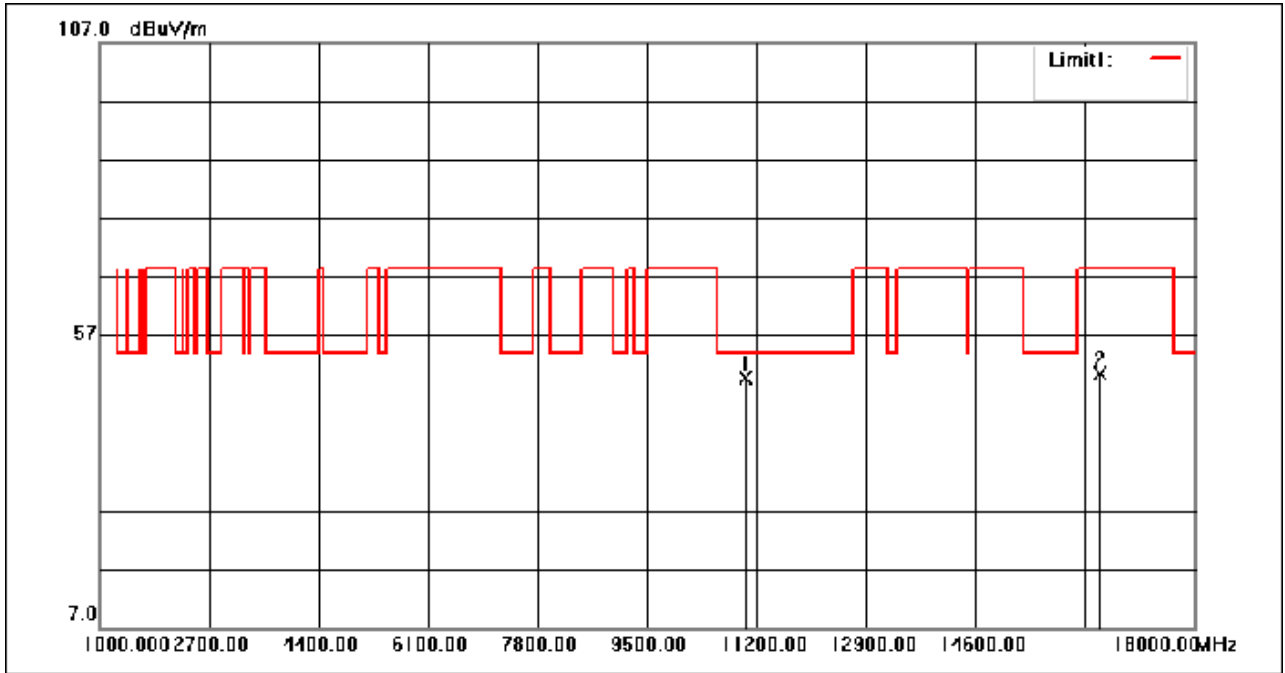

No.	Frequency (MHz)	Reading (dBuV)	Correction factor(dB/m)	Result (dBuV/m)	Limit (dBuV/m)	Margin (dB)	Remark
1	11020.000	49.12	0.56	49.68	54.00	-4.32	peak
2	16530.000	41.87	8.47	50.34	68.30	-17.96	peak



Unless otherwise agreed in writing, this document is issued by the Company subject to its General Conditions of Service printed overleaf, available on request or accessible at <http://www.sgs.com/en/Terms-and-Conditions.aspx> and, for electronic format documents, subject to Terms and Conditions for Electronic Documents at <http://www.sgs.com/en/Terms-and-Conditions/Terms-e-Document.aspx>. Attention is drawn to the limitation of liability, indemnification and jurisdiction issues defined therein. Any holder of this document is advised that information contained hereon reflects the Company's findings at the time of its intervention only and within the limits of Client's instructions, if any. The Company's sole responsibility is to its Client and this document does not exonerate parties to a transaction from exercising all their rights and obligations under the transaction documents. This document cannot be reproduced except in full, without prior written approval of the Company. Any unauthorized alteration, forgery or falsification of the content or appearance of this document is unlawful and offenders may be prosecuted to the fullest extent of the law. Unless otherwise stated the results shown in this test report refer only to the sample(s) tested and such sample(s) are retained for 30 days only.  
**Attention: To check the authenticity of testing /inspection report & certificate, please contact us at telephone: (86-755) 8307 1443, or email: CN.Doccheck@sgs.com**

No.10, Weiye Road, Innovation Park, Kunshan, Jiangsu, China 215300  
 中国·江苏·昆山市留学生创业园伟业路10号 邮编 215300

t(86-512)57355888 f(86-512)57370818 www.sgsgroup.com.cn  
 t(86-512)57355888 f(86-512)57370818 sgs.china@sgs.com

Test Mode: 03; Polarity: Horizontal; Modulation:802.11n; Bandwidth:40MHz; Channel:middle

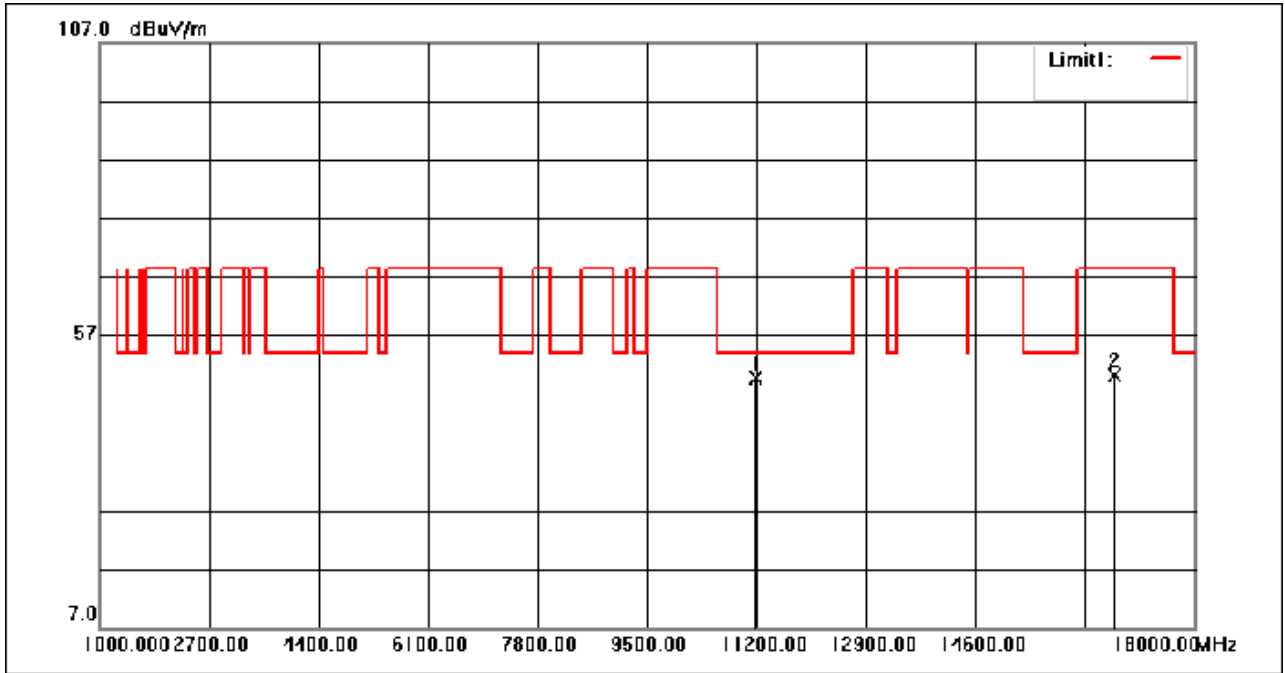

No.	Frequency (MHz)	Reading (dBuV)	Correction factor(dB/m)	Result (dBuV/m)	Limit (dBuV/m)	Margin (dB)	Remark
1	11180.000	48.97	0.69	49.66	54.00	-4.34	peak
2	16770.000	41.33	8.84	50.17	68.30	-18.13	peak



Unless otherwise agreed in writing, this document is issued by the Company subject to its General Conditions of Service printed overleaf, available on request or accessible at <http://www.sgs.com/en/Terms-and-Conditions.aspx> and, for electronic format documents, subject to Terms and Conditions for Electronic Documents at <http://www.sgs.com/en/Terms-and-Conditions/Terms-e-Documents.aspx>. Attention is drawn to the limitation of liability, indemnification and jurisdiction issues defined therein. Any holder of this document is advised that information contained hereon reflects the Company's findings at the time of its intervention only and within the limits of Client's instructions, if any. The Company's sole responsibility is to its Client and this document does not exonerate parties to a transaction from exercising all their rights and obligations under the transaction documents. This document cannot be reproduced except in full, without prior written approval of the Company. Any unauthorized alteration, forgery or falsification of the content or appearance of this document is unlawful and offenders may be prosecuted to the fullest extent of the law. Unless otherwise stated the results shown in this test report refer only to the sample(s) tested and such sample(s) are retained for 30 days only.  
**Attention: To check the authenticity of testing /inspection report & certificate, please contact us at telephone: (86-755) 8307 1443, or email: CN.Doccheck@sgs.com**

No.10, Weiye Road, Innovation Park, Kunshan, Jiangsu, China 215300  
 中国·江苏·昆山市留学生创业园伟业路10号 邮编 215300

t(86-512)57355888 f(86-512)57370818 www.sgsgroup.com.cn  
 t(86-512)57355888 f(86-512)57370818 sgs.china@sgs.com

Test Mode: 03; Polarity: Vertical; Modulation:802.11n; Bandwidth:40MHz; Channel:middle

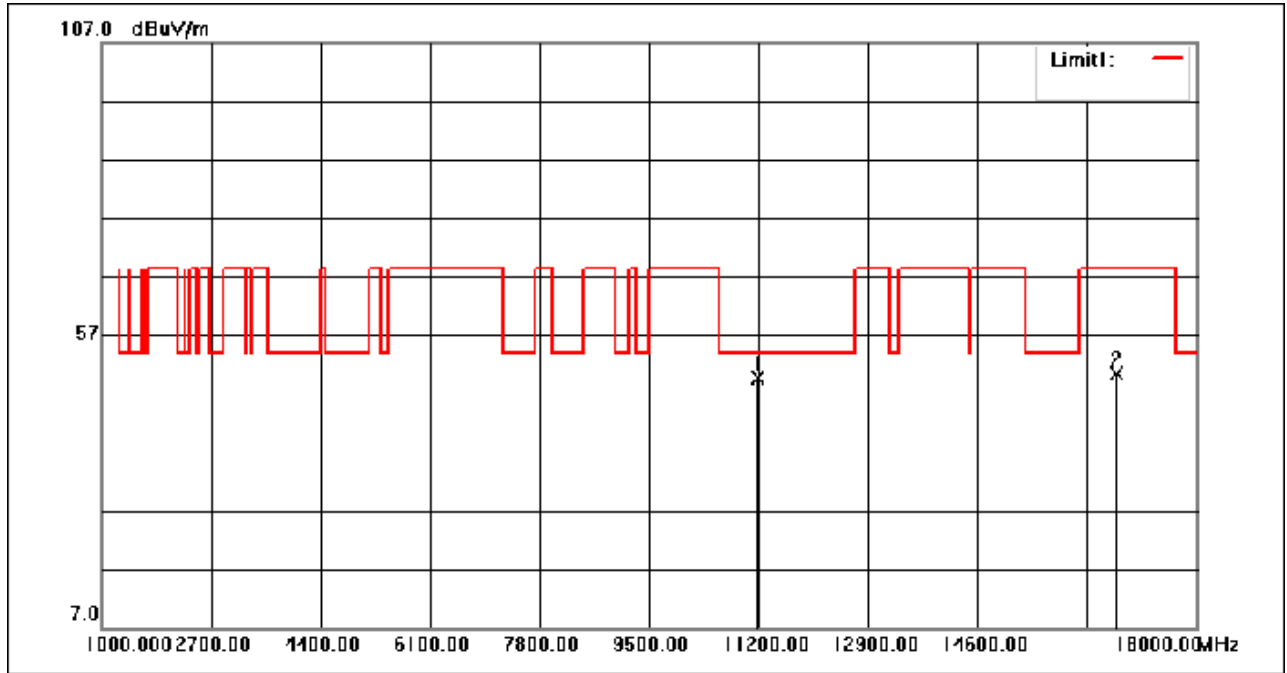

No.	Frequency (MHz)	Reading (dBuV)	Correction factor(dB/m)	Result (dBuV/m)	Limit (dBuV/m)	Margin (dB)	Remark
1	11180.000	48.99	0.69	49.68	54.00	-4.32	peak
2	16770.000	41.50	8.84	50.34	68.30	-17.96	peak



Unless otherwise agreed in writing, this document is issued by the Company subject to its General Conditions of Service printed overleaf, available on request or accessible at <http://www.sgs.com/en/Terms-and-Conditions.aspx> and, for electronic format documents, subject to Terms and Conditions for Electronic Documents at <http://www.sgs.com/en/Terms-and-Conditions/Terms-e-Documents.aspx>. Attention is drawn to the limitation of liability, indemnification and jurisdiction issues defined therein. Any holder of this document is advised that information contained hereon reflects the Company's findings at the time of its intervention only and within the limits of Client's instructions, if any. The Company's sole responsibility is to its Client and this document does not exonerate parties to a transaction from exercising all their rights and obligations under the transaction documents. This document cannot be reproduced except in full, without prior written approval of the Company. Any unauthorized alteration, forgery or falsification of the content or appearance of this document is unlawful and offenders may be prosecuted to the fullest extent of the law. Unless otherwise stated the results shown in this test report refer only to the sample(s) tested and such sample(s) are retained for 30 days only.  
**Attention: To check the authenticity of testing /inspection report & certificate, please contact us at telephone: (86-755) 8307 1443, or email: CN.Doccheck@sgs.com**

No.10, Weiye Road, Innovation Park, Kunshan, Jiangsu, China 215300  
 中国·江苏·昆山市留学生创业园伟业路10号 邮编 215300

t(86-512)57355888 f(86-512)57370818 www.sgsgroup.com.cn  
 t(86-512)57355888 f(86-512)57370818 sgs.china@sgs.com



Test Mode: 03; Polarity: Horizontal; Modulation:802.11n; Bandwidth:40MHz; Channel:High

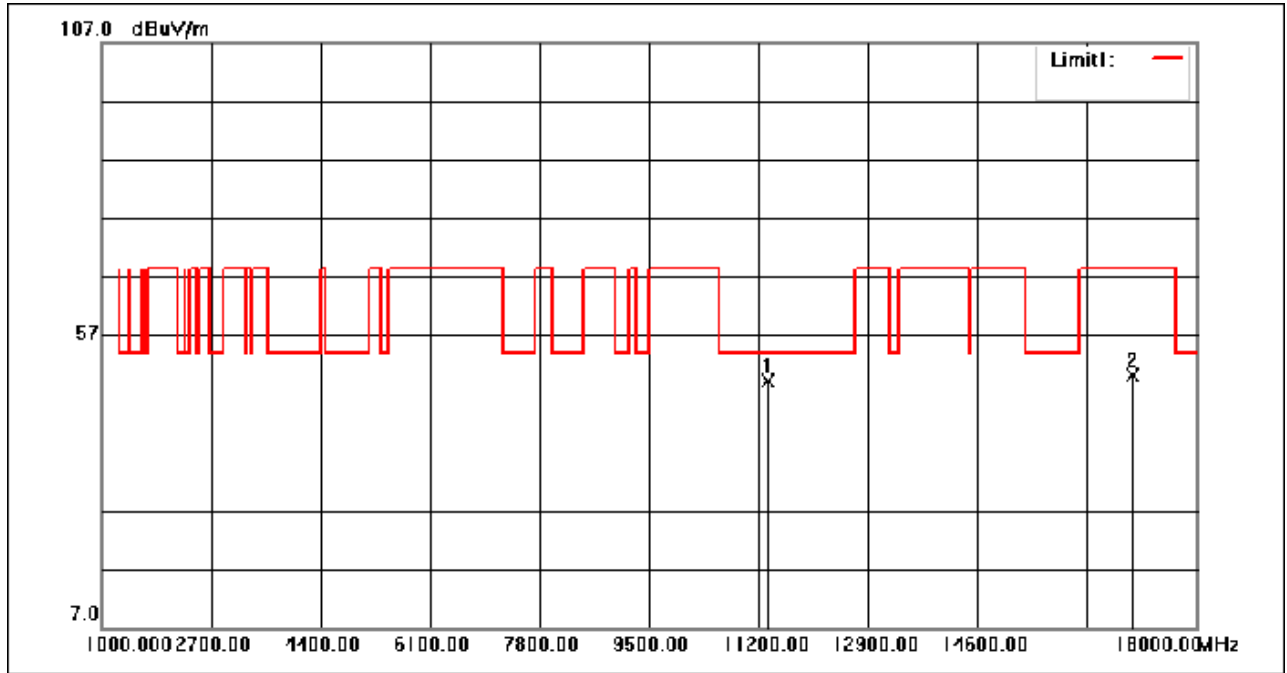

No.	Frequency (MHz)	Reading (dBuV)	Correction factor(dB/m)	Result (dBuV/m)	Limit (dBuV/m)	Margin (dB)	Remark
1	11340.000	48.28	0.82	49.10	54.00	-4.90	peak
2	17010.000	41.01	9.18	50.19	68.30	-18.11	peak



Unless otherwise agreed in writing, this document is issued by the Company subject to its General Conditions of Service printed overleaf, available on request or accessible at <http://www.sgs.com/en/Terms-and-Conditions.aspx> and, for electronic format documents, subject to Terms and Conditions for Electronic Documents at <http://www.sgs.com/en/Terms-and-Conditions/Terms-e-Documents.aspx>. Attention is drawn to the limitation of liability, indemnification and jurisdiction issues defined therein. Any holder of this document is advised that information contained hereon reflects the Company's findings at the time of its intervention only and within the limits of Client's instructions, if any. The Company's sole responsibility is to its Client and this document does not exonerate parties to a transaction from exercising all their rights and obligations under the transaction documents. This document cannot be reproduced except in full, without prior written approval of the Company. Any unauthorized alteration, forgery or falsification of the content or appearance of this document is unlawful and offenders may be prosecuted to the fullest extent of the law. Unless otherwise stated the results shown in this test report refer only to the sample(s) tested and such sample(s) are retained for 30 days only.  
Attention: To check the authenticity of testing /inspection report & certificate, please contact us at telephone: (86-755) 8307 1443, or email: [CN.Doccheck@sgs.com](mailto:CN.Doccheck@sgs.com)

No.10, Weiye Road, Innovation Park, Kunshan, Jiangsu, China 215300  
中国·江苏·昆山市留学生创业园伟业路10号 邮编 215300

t(86-512)57355888 f(86-512)57370818 www.sgsgroup.com.cn  
t(86-512)57355888 f(86-512)57370818 sgs.china@sgs.com

Test Mode: 03; Polarity: Vertical; Modulation:802.11n; Bandwidth:40MHz; Channel:High

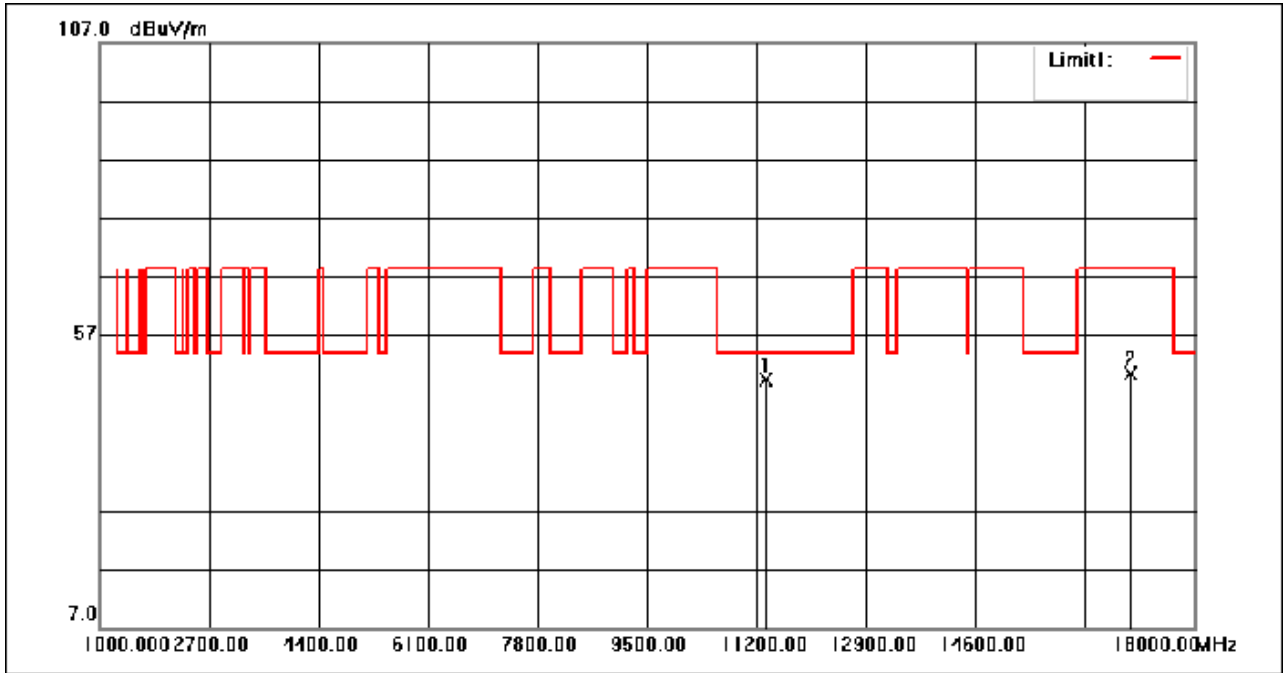

No.	Frequency (MHz)	Reading (dBuV)	Correction factor(dB/m)	Result (dBuV/m)	Limit (dBuV/m)	Margin (dB)	Remark
1	11340.000	48.52	0.82	49.34	54.00	-4.66	peak
2	17010.000	41.21	9.18	50.39	68.30	-17.91	peak



Unless otherwise agreed in writing, this document is issued by the Company subject to its General Conditions of Service printed overleaf, available on request or accessible at <http://www.sgs.com/en/Terms-and-Conditions.aspx> and, for electronic format documents, subject to Terms and Conditions for Electronic Documents at <http://www.sgs.com/en/Terms-and-Conditions/Terms-e-Documents.aspx>. Attention is drawn to the limitation of liability, indemnification and jurisdiction issues defined therein. Any holder of this document is advised that information contained hereon reflects the Company's findings at the time of its intervention only and within the limits of Client's instructions, if any. The Company's sole responsibility is to its Client and this document does not exonerate parties to a transaction from exercising all their rights and obligations under the transaction documents. This document cannot be reproduced except in full, without prior written approval of the Company. Any unauthorized alteration, forgery or falsification of the content or appearance of this document is unlawful and offenders may be prosecuted to the fullest extent of the law. Unless otherwise stated the results shown in this test report refer only to the sample(s) tested and such sample(s) are retained for 30 days only.  
**Attention: To check the authenticity of testing /inspection report & certificate, please contact us at telephone: (86-755) 8307 1443, or email: CN.Doccheck@sgs.com**

No.10, Weiye Road, Innovation Park, Kunshan, Jiangsu, China 215300  
 中国·江苏·昆山市留学生创业园伟业路10号 邮编 215300

t(86-512)57355888 f(86-512)57370818 www.sgsgroup.com.cn  
 t(86-512)57355888 f(86-512)57370818 sgs.china@sgs.com

## Compliance Certification Services (Kunshan) Inc.

Report No.: KSCR221000189002

Page: 109 of 607

Test Mode: 03; Polarity: Horizontal; Modulation:802.11ac; Bandwidth:20MHz; Channel:Low

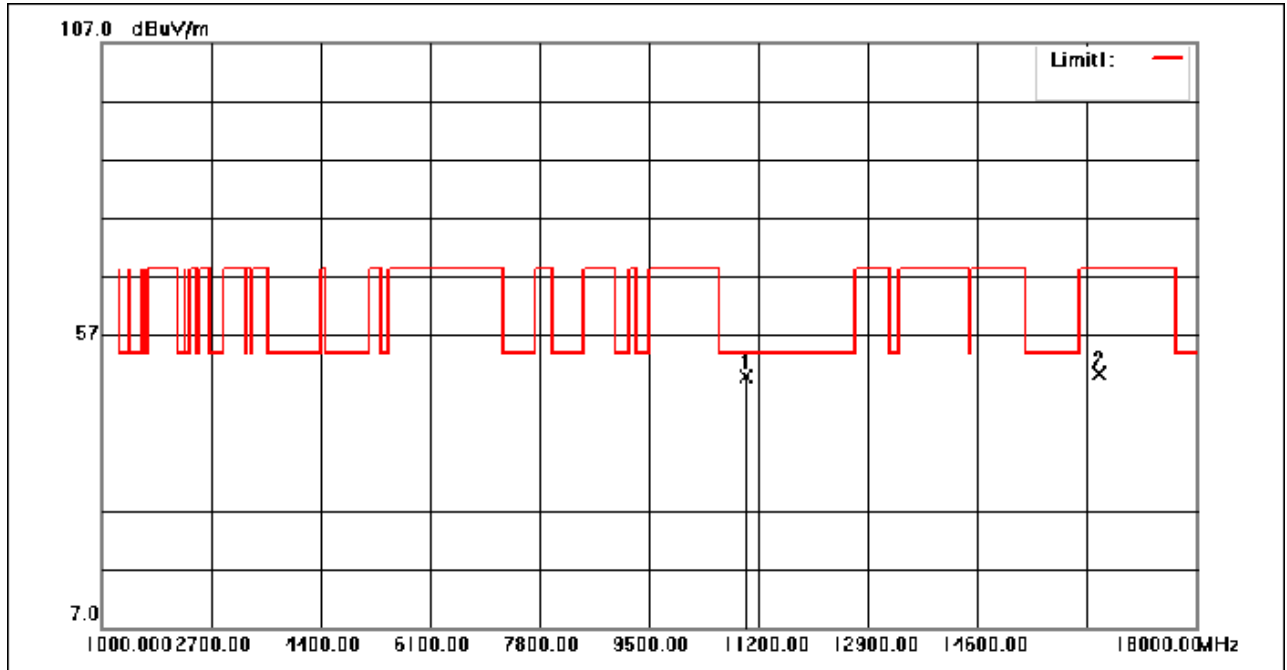

No.	Frequency (MHz)	Reading (dBuV)	Correction factor(dB/m)	Result (dBuV/m)	Limit (dBuV/m)	Margin (dB)	Remark
1	11000.000	49.43	0.54	49.97	54.00	-4.03	peak
2	16500.000	41.94	8.43	50.37	68.30	-17.93	peak



Unless otherwise agreed in writing, this document is issued by the Company subject to its General Conditions of Service printed overleaf, available on request or accessible at <http://www.sgs.com/en/Terms-and-Conditions.aspx> and, for electronic format documents, subject to Terms and Conditions for Electronic Documents at <http://www.sgs.com/en/Terms-and-Conditions/Terms-e-Documents.aspx>. Attention is drawn to the limitation of liability, indemnification and jurisdiction issues defined therein. Any holder of this document is advised that information contained hereon reflects the Company's findings at the time of its intervention only and within the limits of Client's instructions, if any. The Company's sole responsibility is to its Client and this document does not exonerate parties to a transaction from exercising all their rights and obligations under the transaction documents. This document cannot be reproduced except in full, without prior written approval of the Company. Any unauthorized alteration, forgery or falsification of the content or appearance of this document is unlawful and offenders may be prosecuted to the fullest extent of the law. Unless otherwise stated the results shown in this test report refer only to the sample(s) tested and such sample(s) are retained for 30 days only.  
**Attention: To check the authenticity of testing /inspection report & certificate, please contact us at telephone: (86-755) 8307 1443, or email: CN.Doccheck@sgs.com**

No.10, Weiye Road, Innovation Park, Kunshan, Jiangsu, China 215300  
 中国·江苏·昆山市留学生创业园伟业路10号 邮编 215300

t(86-512)57355888 f(86-512)57370818 www.sgsgroup.com.cn  
 t(86-512)57355888 f(86-512)57370818 sgs.china@sgs.com

Test Mode: 03; Polarity: Vertical; Modulation:802.11ac; Bandwidth:20MHz; Channel:Low

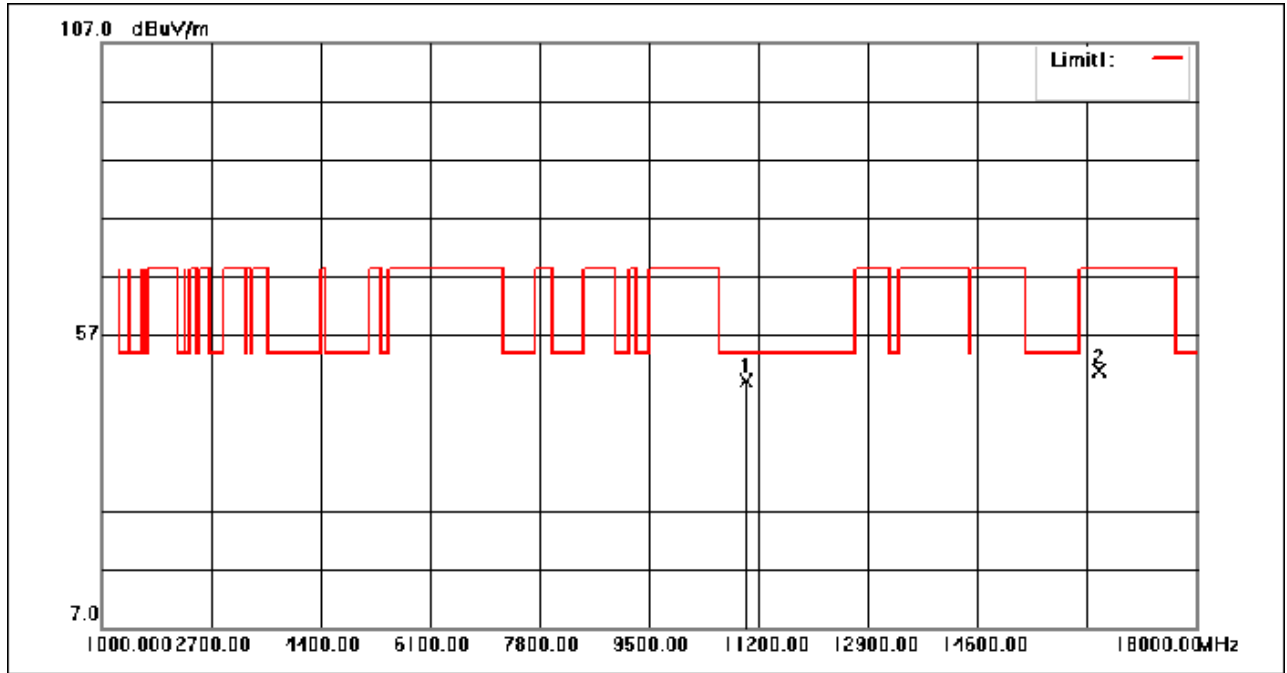

No.	Frequency (MHz)	Reading (dBuV)	Correction factor(dB/m)	Result (dBuV/m)	Limit (dBuV/m)	Margin (dB)	Remark
1	11000.000	48.49	0.54	49.03	54.00	-4.97	peak
2	16500.000	42.55	8.43	50.98	68.30	-17.32	peak



Unless otherwise agreed in writing, this document is issued by the Company subject to its General Conditions of Service printed overleaf, available on request or accessible at <http://www.sgs.com/en/Terms-and-Conditions.aspx> and, for electronic format documents, subject to Terms and Conditions for Electronic Documents at <http://www.sgs.com/en/Terms-and-Conditions/Terms-e-Documents.aspx>. Attention is drawn to the limitation of liability, indemnification and jurisdiction issues defined therein. Any holder of this document is advised that information contained hereon reflects the Company's findings at the time of its intervention only and within the limits of Client's instructions, if any. The Company's sole responsibility is to its Client and this document does not exonerate parties to a transaction from exercising all their rights and obligations under the transaction documents. This document cannot be reproduced except in full, without prior written approval of the Company. Any unauthorized alteration, forgery or falsification of the content or appearance of this document is unlawful and offenders may be prosecuted to the fullest extent of the law. Unless otherwise stated the results shown in this test report refer only to the sample(s) tested and such sample(s) are retained for 30 days only.  
**Attention: To check the authenticity of testing /inspection report & certificate, please contact us at telephone: (86-755) 8307 1443, or email: CN.Doccheck@sgs.com**

No.10, Weiye Road, Innovation Park, Kunshan, Jiangsu, China 215300  
 中国·江苏·昆山市留学生创业园伟业路10号 邮编 215300

t(86-512)57355888 f(86-512)57370818 www.sgsgroup.com.cn  
 t(86-512)57355888 f(86-512)57370818 sgs.china@sgs.com

Test Mode: 03; Polarity: Horizontal; Modulation:802.11ac; Bandwidth:20MHz; Channel:middle

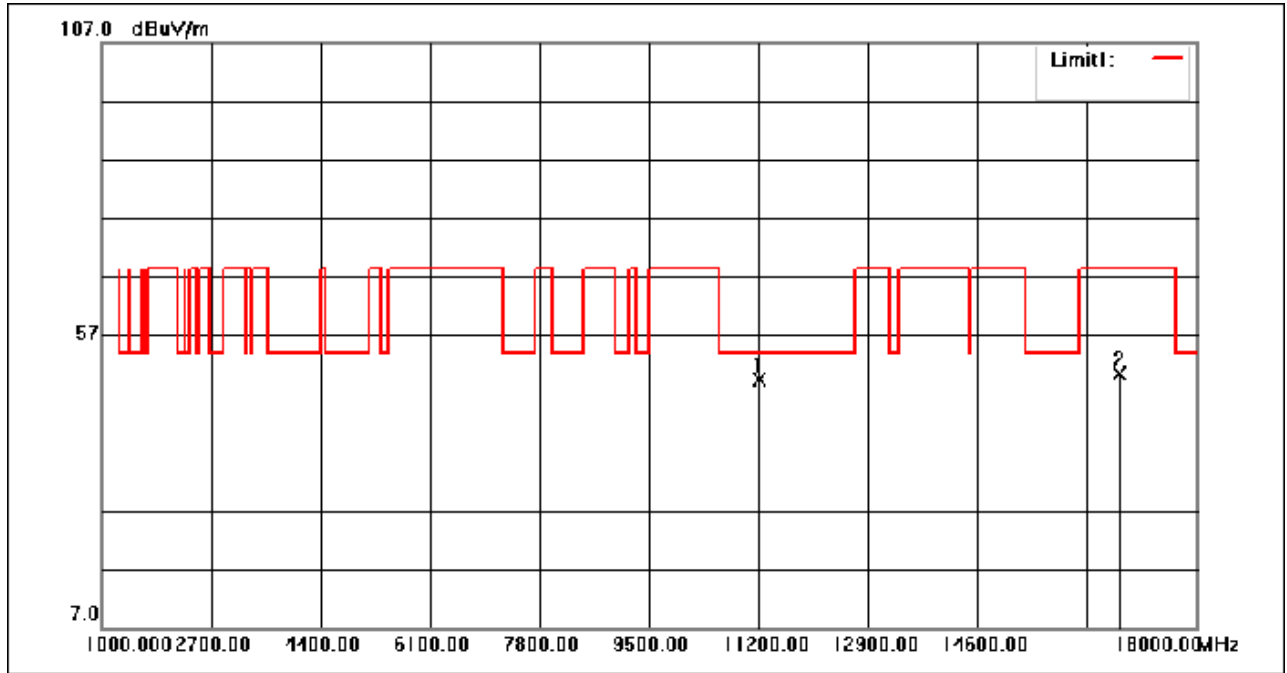

No.	Frequency (MHz)	Reading (dBuV)	Correction factor(dB/m)	Result (dBuV/m)	Limit (dBuV/m)	Margin (dB)	Remark
1	11200.000	48.76	0.71	49.47	54.00	-4.53	peak
2	16800.000	41.46	8.89	50.35	68.30	-17.95	peak



Unless otherwise agreed in writing, this document is issued by the Company subject to its General Conditions of Service printed overleaf, available on request or accessible at <http://www.sgs.com/en/Terms-and-Conditions.aspx> and, for electronic format documents, subject to Terms and Conditions for Electronic Documents at <http://www.sgs.com/en/Terms-and-Conditions/Terms-e-Documents.aspx>. Attention is drawn to the limitation of liability, indemnification and jurisdiction issues defined therein. Any holder of this document is advised that information contained hereon reflects the Company's findings at the time of its intervention only and within the limits of Client's instructions, if any. The Company's sole responsibility is to its Client and this document does not exonerate parties to a transaction from exercising all their rights and obligations under the transaction documents. This document cannot be reproduced except in full, without prior written approval of the Company. Any unauthorized alteration, forgery or falsification of the content or appearance of this document is unlawful and offenders may be prosecuted to the fullest extent of the law. Unless otherwise stated the results shown in this test report refer only to the sample(s) tested and such sample(s) are retained for 30 days only.  
**Attention: To check the authenticity of testing /inspection report & certificate, please contact us at telephone: (86-755) 8307 1443, or email: CN.Doccheck@sgs.com**

No.10, Weiye Road, Innovation Park, Kunshan, Jiangsu, China 215300  
 中国·江苏·昆山市留学生创业园伟业路10号 邮编 215300

t(86-512)57355888 f(86-512)57370818 www.sgsgroup.com.cn  
 t(86-512)57355888 f(86-512)57370818 sgs.china@sgs.com



Test Mode: 03; Polarity: Vertical; Modulation:802.11ac; Bandwidth:20MHz; Channel:middle

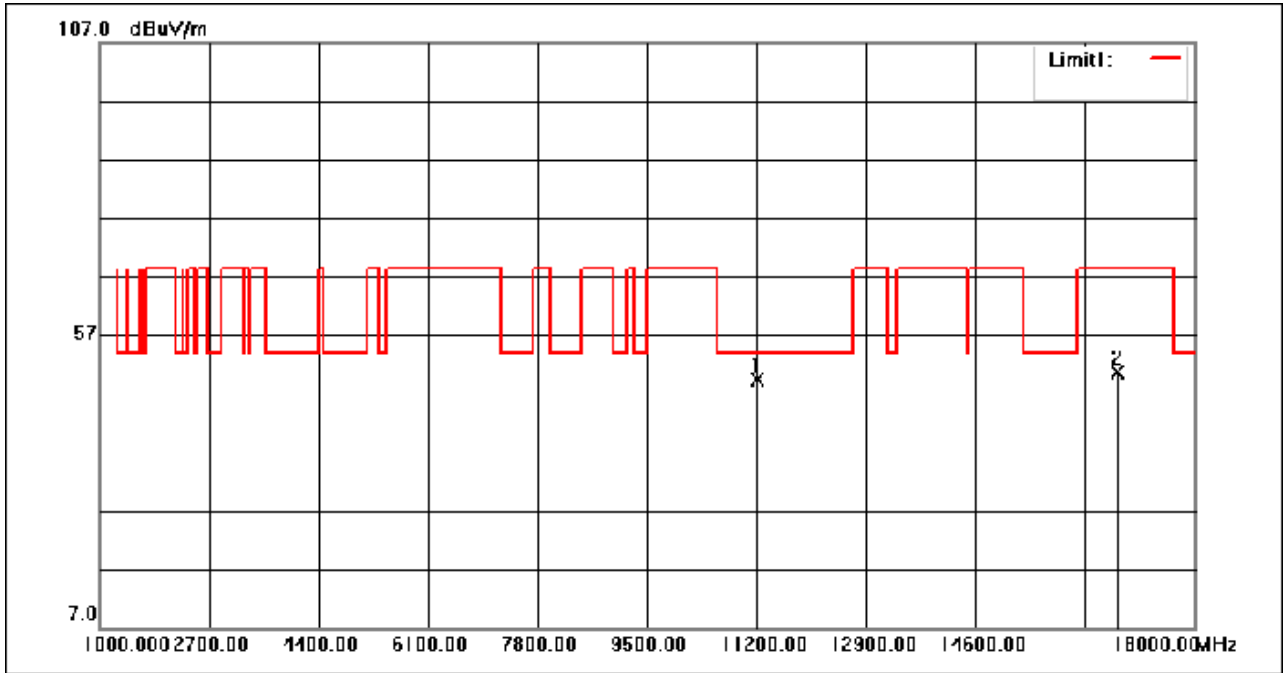

No.	Frequency (MHz)	Reading (dBuV)	Correction factor(dB/m)	Result (dBuV/m)	Limit (dBuV/m)	Margin (dB)	Remark
1	11200.000	48.75	0.71	49.46	54.00	-4.54	peak
2	16800.000	41.72	8.89	50.61	68.30	-17.69	peak



Unless otherwise agreed in writing, this document is issued by the Company subject to its General Conditions of Service printed overleaf, available on request or accessible at <http://www.sgs.com/en/Terms-and-Conditions.aspx> and, for electronic format documents, subject to Terms and Conditions for Electronic Documents at <http://www.sgs.com/en/Terms-and-Conditions/Terms-e-Documents.aspx>. Attention is drawn to the limitation of liability, indemnification and jurisdiction issues defined therein. Any holder of this document is advised that information contained hereon reflects the Company's findings at the time of its intervention only and within the limits of Client's instructions, if any. The Company's sole responsibility is to its Client and this document does not exonerate parties to a transaction from exercising all their rights and obligations under the transaction documents. This document cannot be reproduced except in full, without prior written approval of the Company. Any unauthorized alteration, forgery or falsification of the content or appearance of this document is unlawful and offenders may be prosecuted to the fullest extent of the law. Unless otherwise stated the results shown in this test report refer only to the sample(s) tested and such sample(s) are retained for 30 days only.  
**Attention: To check the authenticity of testing /inspection report & certificate, please contact us at telephone: (86-755) 8307 1443, or email: CN.Doccheck@sgs.com**

No.10, Weiye Road, Innovation Park, Kunshan, Jiangsu, China 215300  
 中国·江苏·昆山市留学生创业园伟业路10号 邮编 215300

t(86-512)57355888 f(86-512)57370818 www.sgsgroup.com.cn  
 t(86-512)57355888 f(86-512)57370818 sgs.china@sgs.com

Test Mode: 03; Polarity: Horizontal; Modulation:802.11ac; Bandwidth:20MHz; Channel:High

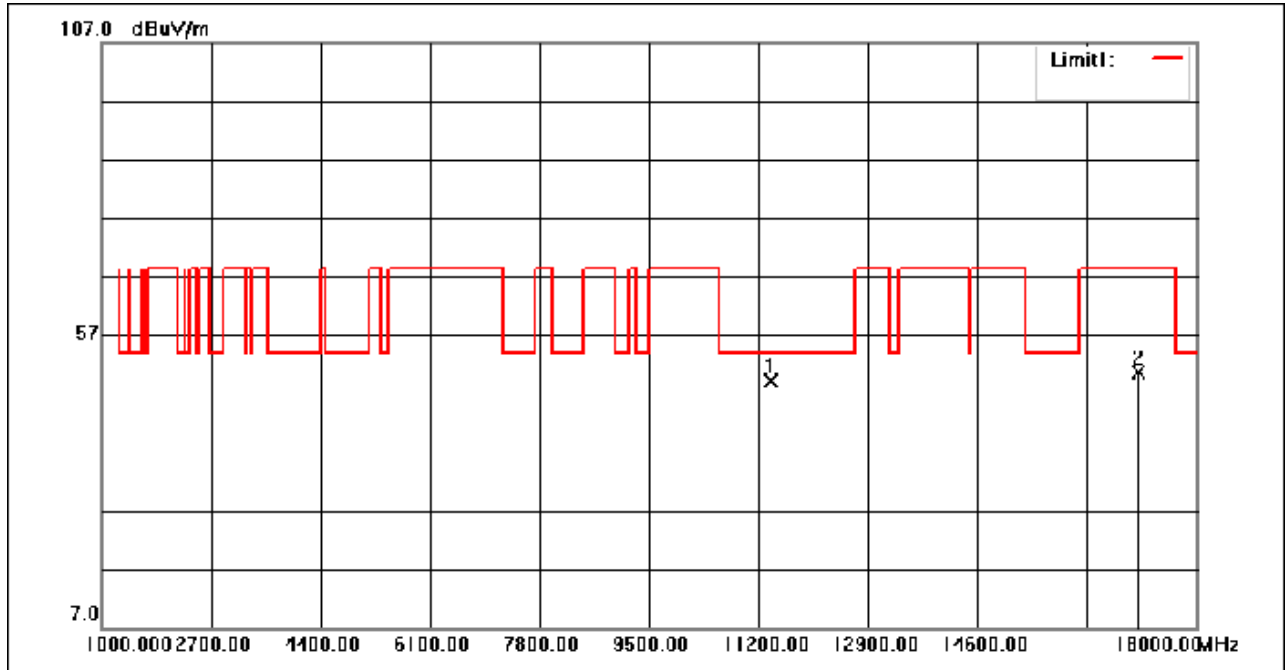

No.	Frequency (MHz)	Reading (dBuV)	Correction factor(dB/m)	Result (dBuV/m)	Limit (dBuV/m)	Margin (dB)	Remark
1	11400.000	48.37	0.87	49.24	54.00	-4.76	peak
2	17100.000	41.49	9.13	50.62	68.30	-17.68	peak



Unless otherwise agreed in writing, this document is issued by the Company subject to its General Conditions of Service printed overleaf, available on request or accessible at <http://www.sgs.com/en/Terms-and-Conditions.aspx> and, for electronic format documents, subject to Terms and Conditions for Electronic Documents at <http://www.sgs.com/en/Terms-and-Conditions/Terms-e-Documents.aspx>. Attention is drawn to the limitation of liability, indemnification and jurisdiction issues defined therein. Any holder of this document is advised that information contained hereon reflects the Company's findings at the time of its intervention only and within the limits of Client's instructions, if any. The Company's sole responsibility is to its Client and this document does not exonerate parties to a transaction from exercising all their rights and obligations under the transaction documents. This document cannot be reproduced except in full, without prior written approval of the Company. Any unauthorized alteration, forgery or falsification of the content or appearance of this document is unlawful and offenders may be prosecuted to the fullest extent of the law. Unless otherwise stated the results shown in this test report refer only to the sample(s) tested and such sample(s) are retained for 30 days only.  
**Attention: To check the authenticity of testing /inspection report & certificate, please contact us at telephone: (86-755) 8307 1443, or email: CN.Doccheck@sgs.com**

No.10, Weiye Road, Innovation Park, Kunshan, Jiangsu, China 215300  
 中国·江苏·昆山市留学生创业园伟业路10号 邮编 215300

t(86-512)57355888 f(86-512)57370818 www.sgsgroup.com.cn  
 t(86-512)57355888 f(86-512)57370818 sgs.china@sgs.com

Test Mode: 03; Polarity: Vertical; Modulation:802.11ac; Bandwidth:20MHz; Channel:High

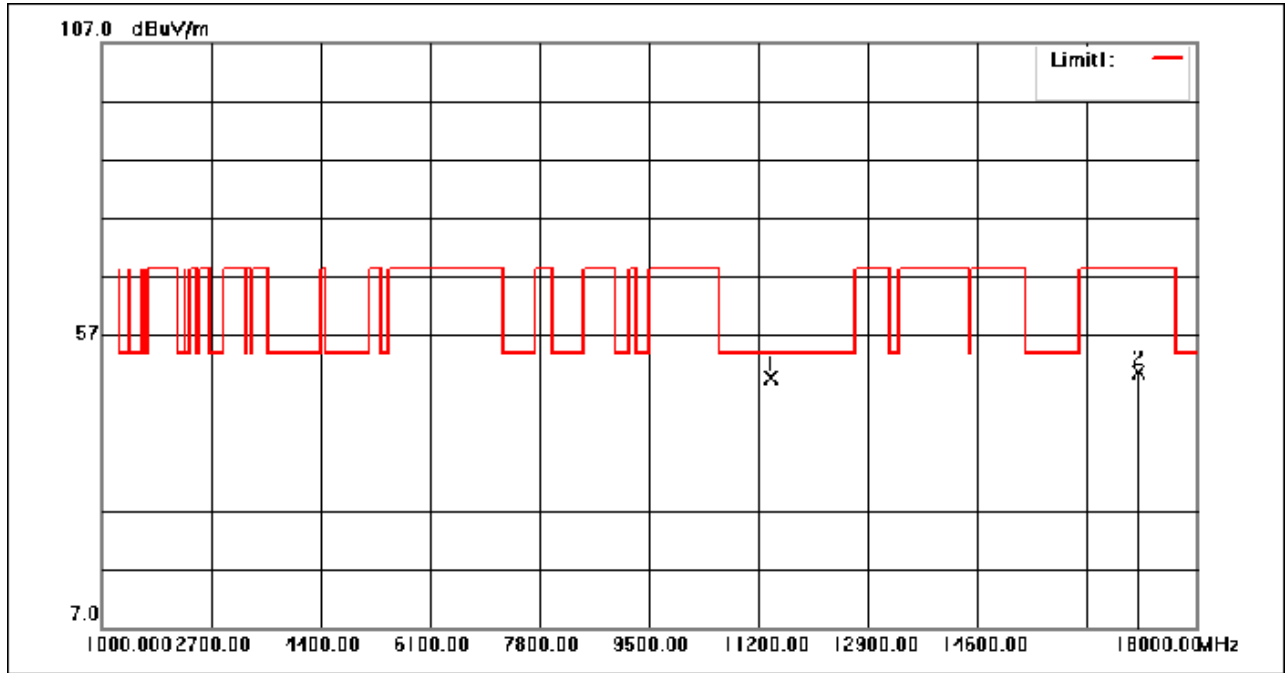

No.	Frequency (MHz)	Reading (dBuV)	Correction factor(dB/m)	Result (dBuV/m)	Limit (dBuV/m)	Margin (dB)	Remark
1	11400.000	48.66	0.87	49.53	54.00	-4.47	peak
2	17100.000	41.45	9.13	50.58	68.30	-17.72	peak



Unless otherwise agreed in writing, this document is issued by the Company subject to its General Conditions of Service printed overleaf, available on request or accessible at <http://www.sgs.com/en/Terms-and-Conditions.aspx> and, for electronic format documents, subject to Terms and Conditions for Electronic Documents at <http://www.sgs.com/en/Terms-and-Conditions/Terms-e-Documents.aspx>. Attention is drawn to the limitation of liability, indemnification and jurisdiction issues defined therein. Any holder of this document is advised that information contained hereon reflects the Company's findings at the time of its intervention only and within the limits of Client's instructions, if any. The Company's sole responsibility is to its Client and this document does not exonerate parties to a transaction from exercising all their rights and obligations under the transaction documents. This document cannot be reproduced except in full, without prior written approval of the Company. Any unauthorized alteration, forgery or falsification of the content or appearance of this document is unlawful and offenders may be prosecuted to the fullest extent of the law. Unless otherwise stated the results shown in this test report refer only to the sample(s) tested and such sample(s) are retained for 30 days only.  
**Attention: To check the authenticity of testing /inspection report & certificate, please contact us at telephone: (86-755) 8307 1443, or email: CN.Doccheck@sgs.com**

No.10, Weiye Road, Innovation Park, Kunshan, Jiangsu, China 215300  
 中国·江苏·昆山市留学生创业园伟业路10号 邮编 215300

t(86-512)57355888 f(86-512)57370818 www.sgsgroup.com.cn  
 t(86-512)57355888 f(86-512)57370818 sgs.china@sgs.com

Test Mode: 03; Polarity: Horizontal; Modulation:802.11ac; Bandwidth:40MHz; Channel:Low

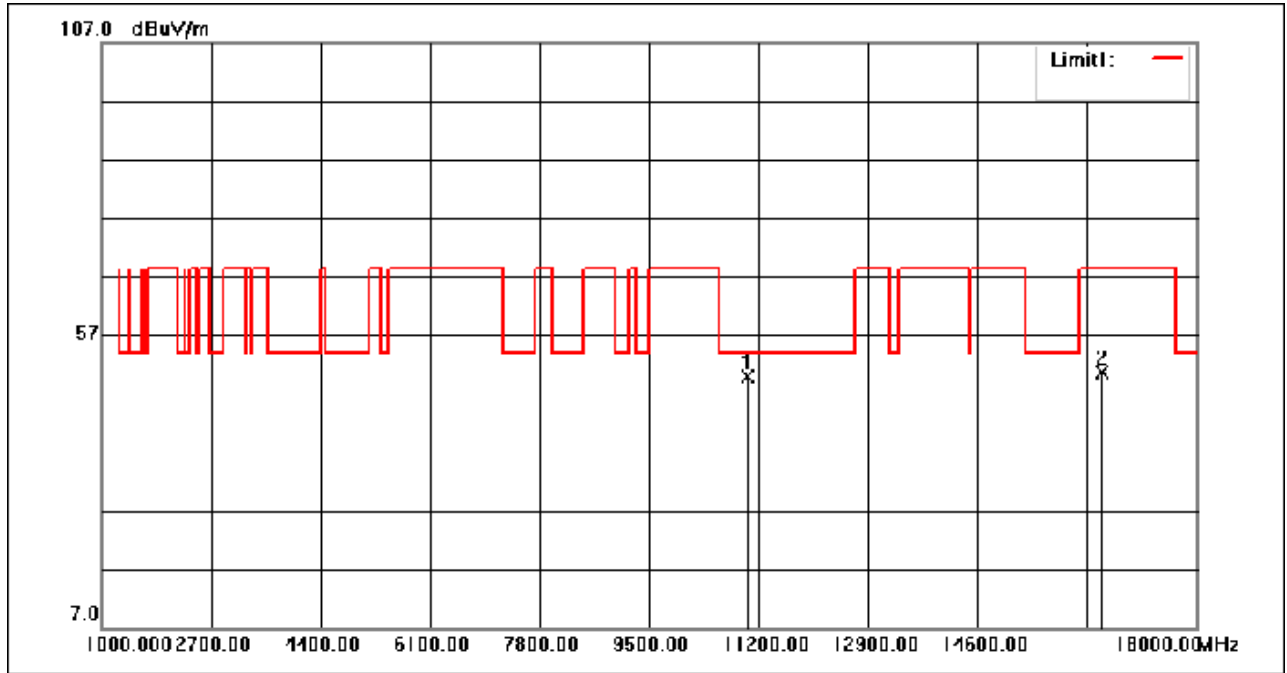

No.	Frequency (MHz)	Reading (dBuV)	Correction factor(dB/m)	Result (dBuV/m)	Limit (dBuV/m)	Margin (dB)	Remark
1	11020.000	49.33	0.56	49.89	54.00	-4.11	peak
2	16530.000	42.14	8.47	50.61	68.30	-17.69	peak



Unless otherwise agreed in writing, this document is issued by the Company subject to its General Conditions of Service printed overleaf, available on request or accessible at <http://www.sgs.com/en/Terms-and-Conditions.aspx> and, for electronic format documents, subject to Terms and Conditions for Electronic Documents at <http://www.sgs.com/en/Terms-and-Conditions/Terms-e-Documents.aspx>. Attention is drawn to the limitation of liability, indemnification and jurisdiction issues defined therein. Any holder of this document is advised that information contained hereon reflects the Company's findings at the time of its intervention only and within the limits of Client's instructions, if any. The Company's sole responsibility is to its Client and this document does not exonerate parties to a transaction from exercising all their rights and obligations under the transaction documents. This document cannot be reproduced except in full, without prior written approval of the Company. Any unauthorized alteration, forgery or falsification of the content or appearance of this document is unlawful and offenders may be prosecuted to the fullest extent of the law. Unless otherwise stated the results shown in this test report refer only to the sample(s) tested and such sample(s) are retained for 30 days only.  
**Attention: To check the authenticity of testing /inspection report & certificate, please contact us at telephone: (86-755) 8307 1443, or email: CN.Doccheck@sgs.com**

No.10, Weiye Road, Innovation Park, Kunshan, Jiangsu, China 215300  
 中国·江苏·昆山市留学生创业园伟业路10号 邮编 215300

t(86-512)57355888 f(86-512)57370818 www.sgsgroup.com.cn  
 t(86-512)57355888 f(86-512)57370818 sgs.china@sgs.com

## Compliance Certification Services (Kunshan) Inc.

Report No.: KSCR221000189002

Page: 116 of 607

Test Mode: 03; Polarity: Vertical; Modulation:802.11ac; Bandwidth:40MHz; Channel:Low

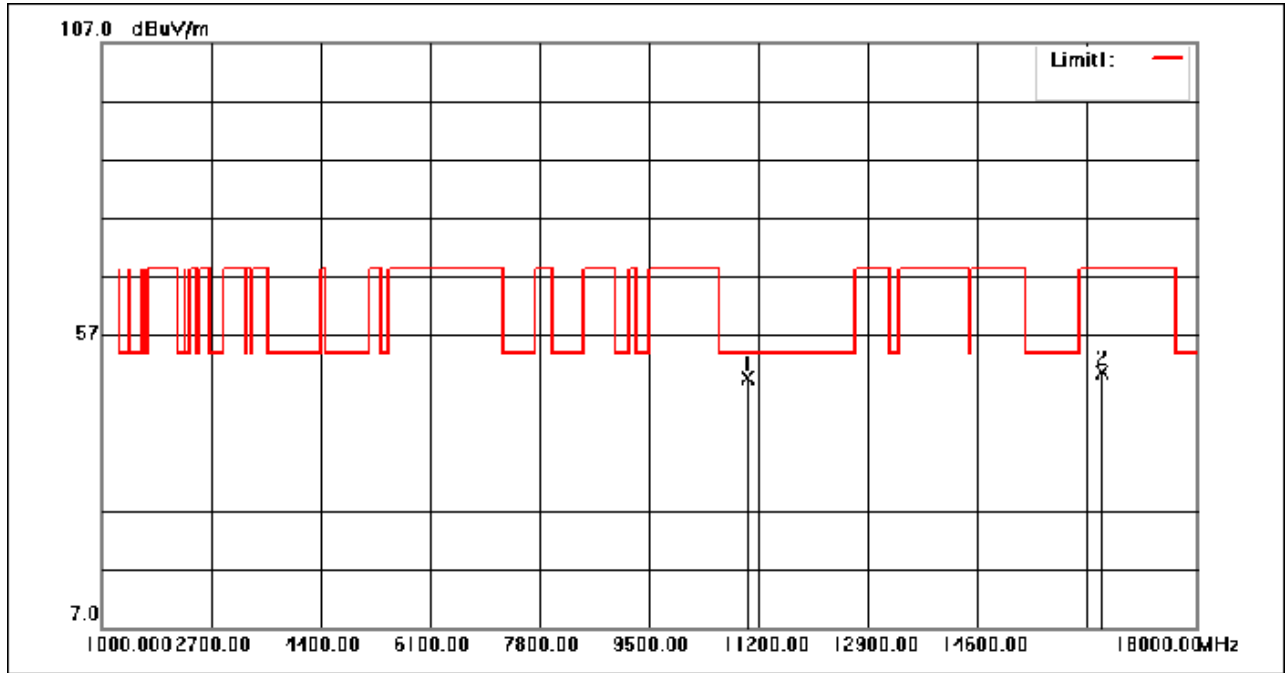

No.	Frequency (MHz)	Reading (dBuV)	Correction factor(dB/m)	Result (dBuV/m)	Limit (dBuV/m)	Margin (dB)	Remark
1	11020.000	49.02	0.56	49.58	54.00	-4.42	peak
2	16530.000	42.06	8.47	50.53	68.30	-17.77	peak



Unless otherwise agreed in writing, this document is issued by the Company subject to its General Conditions of Service printed overleaf, available on request or accessible at <http://www.sgs.com/en/Terms-and-Conditions.aspx> and, for electronic format documents, subject to Terms and Conditions for Electronic Documents at <http://www.sgs.com/en/Terms-and-Conditions/Terms-e-Documents.aspx>. Attention is drawn to the limitation of liability, indemnification and jurisdiction issues defined therein. Any holder of this document is advised that information contained hereon reflects the Company's findings at the time of its intervention only and within the limits of Client's instructions, if any. The Company's sole responsibility is to its Client and this document does not exonerate parties to a transaction from exercising all their rights and obligations under the transaction documents. This document cannot be reproduced except in full, without prior written approval of the Company. Any unauthorized alteration, forgery or falsification of the content or appearance of this document is unlawful and offenders may be prosecuted to the fullest extent of the law. Unless otherwise stated the results shown in this test report refer only to the sample(s) tested and such sample(s) are retained for 30 days only.  
**Attention: To check the authenticity of testing /inspection report & certificate, please contact us at telephone: (86-755) 8307 1443, or email: CN.Doccheck@sgs.com**

No.10, Weiye Road, Innovation Park, Kunshan, Jiangsu, China 215300  
 中国·江苏·昆山市留学生创业园伟业路10号 邮编 215300

t(86-512)57355888 f(86-512)57370818 www.sgsgroup.com.cn  
 t(86-512)57355888 f(86-512)57370818 sgs.china@sgs.com



Test Mode: 03; Polarity: Horizontal; Modulation:802.11ac; Bandwidth:40MHz; Channel:middle

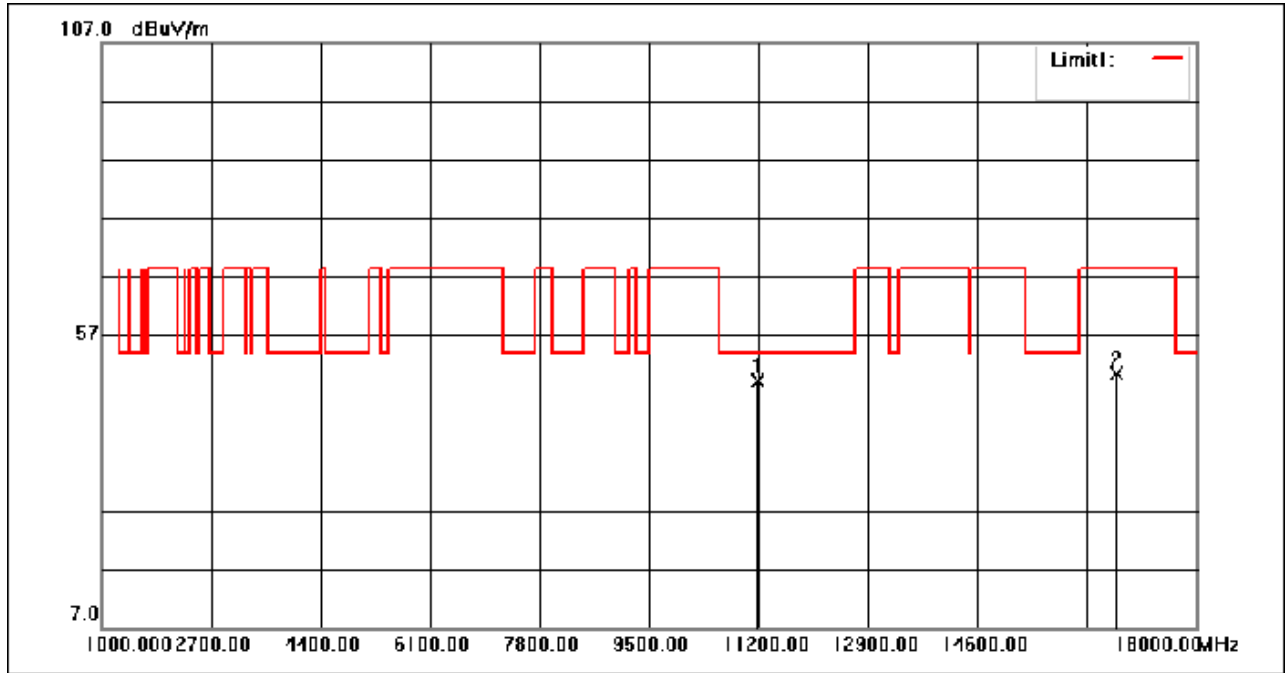

No.	Frequency (MHz)	Reading (dBuV)	Correction factor(dB/m)	Result (dBuV/m)	Limit (dBuV/m)	Margin (dB)	Remark
1	11180.000	48.45	0.69	49.14	54.00	-4.86	peak
2	16770.000	41.55	8.84	50.39	68.30	-17.91	peak



Unless otherwise agreed in writing, this document is issued by the Company subject to its General Conditions of Service printed overleaf, available on request or accessible at <http://www.sgs.com/en/Terms-and-Conditions.aspx> and, for electronic format documents, subject to Terms and Conditions for Electronic Documents at <http://www.sgs.com/en/Terms-and-Conditions/Terms-e-Documents.aspx>. Attention is drawn to the limitation of liability, indemnification and jurisdiction issues defined therein. Any holder of this document is advised that information contained hereon reflects the Company's findings at the time of its intervention only and within the limits of Client's instructions, if any. The Company's sole responsibility is to its Client and this document does not exonerate parties to a transaction from exercising all their rights and obligations under the transaction documents. This document cannot be reproduced except in full, without prior written approval of the Company. Any unauthorized alteration, forgery or falsification of the content or appearance of this document is unlawful and offenders may be prosecuted to the fullest extent of the law. Unless otherwise stated the results shown in this test report refer only to the sample(s) tested and such sample(s) are retained for 30 days only.  
**Attention: To check the authenticity of testing /inspection report & certificate, please contact us at telephone: (86-755) 8307 1443, or email: CN.Doccheck@sgs.com**

No.10, Weiye Road, Innovation Park, Kunshan, Jiangsu, China 215300  
 中国·江苏·昆山市留学生创业园伟业路10号 邮编 215300

t(86-512)57355888 f(86-512)57370818 www.sgsgroup.com.cn  
 t(86-512)57355888 f(86-512)57370818 sgs.china@sgs.com

Test Mode: 03; Polarity: Vertical; Modulation:802.11ac; Bandwidth:40MHz; Channel:middle

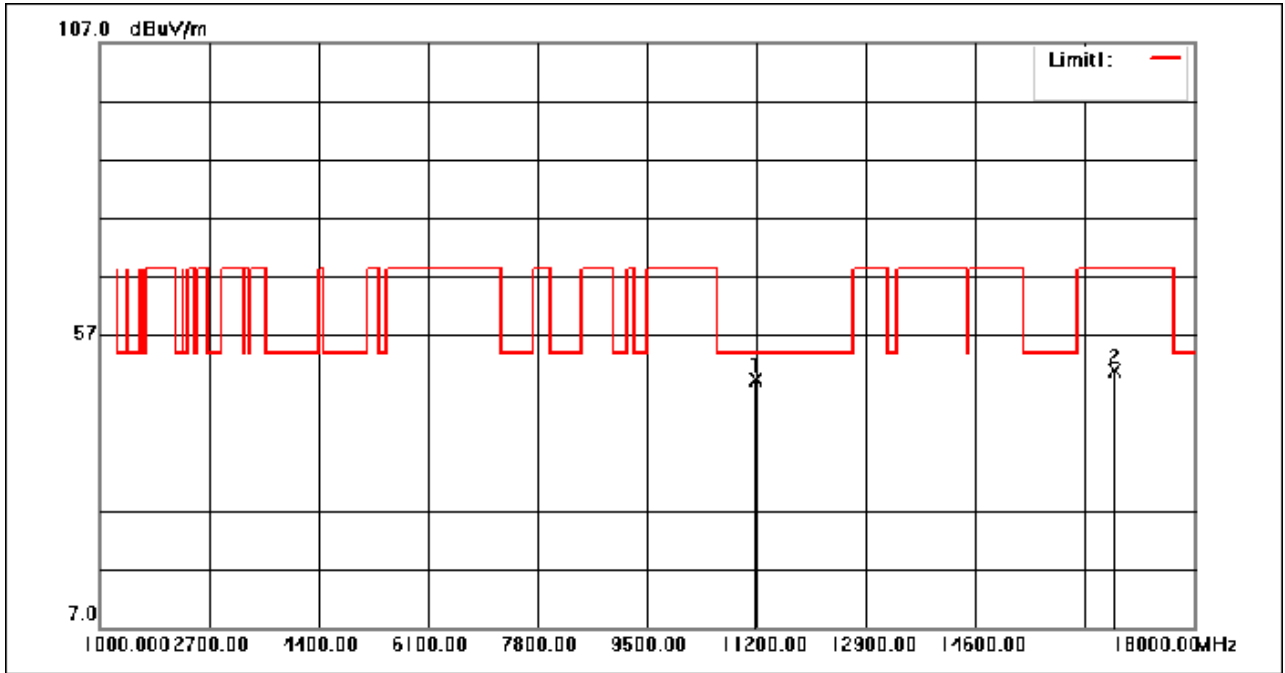

No.	Frequency (MHz)	Reading (dBuV)	Correction factor(dB/m)	Result (dBuV/m)	Limit (dBuV/m)	Margin (dB)	Remark
1	11180.000	48.65	0.69	49.34	54.00	-4.66	peak
2	16770.000	42.11	8.84	50.95	68.30	-17.35	peak



Unless otherwise agreed in writing, this document is issued by the Company subject to its General Conditions of Service printed overleaf, available on request or accessible at <http://www.sgs.com/en/Terms-and-Conditions.aspx> and, for electronic format documents, subject to Terms and Conditions for Electronic Documents at <http://www.sgs.com/en/Terms-and-Conditions/Terms-e-Documents.aspx>. Attention is drawn to the limitation of liability, indemnification and jurisdiction issues defined therein. Any holder of this document is advised that information contained hereon reflects the Company's findings at the time of its intervention only and within the limits of Client's instructions, if any. The Company's sole responsibility is to its Client and this document does not exonerate parties to a transaction from exercising all their rights and obligations under the transaction documents. This document cannot be reproduced except in full, without prior written approval of the Company. Any unauthorized alteration, forgery or falsification of the content or appearance of this document is unlawful and offenders may be prosecuted to the fullest extent of the law. Unless otherwise stated the results shown in this test report refer only to the sample(s) tested and such sample(s) are retained for 30 days only.  
**Attention: To check the authenticity of testing /inspection report & certificate, please contact us at telephone: (86-755) 8307 1443, or email: CN.Doccheck@sgs.com**

No.10, Weiye Road, Innovation Park, Kunshan, Jiangsu, China 215300  
 中国·江苏·昆山市留学生创业园伟业路10号 邮编 215300

t(86-512)57355888 f(86-512)57370818 www.sgsgroup.com.cn  
 t(86-512)57355888 f(86-512)57370818 sgs.china@sgs.com

Test Mode: 03; Polarity: Horizontal; Modulation:802.11ac; Bandwidth:40MHz; Channel:High

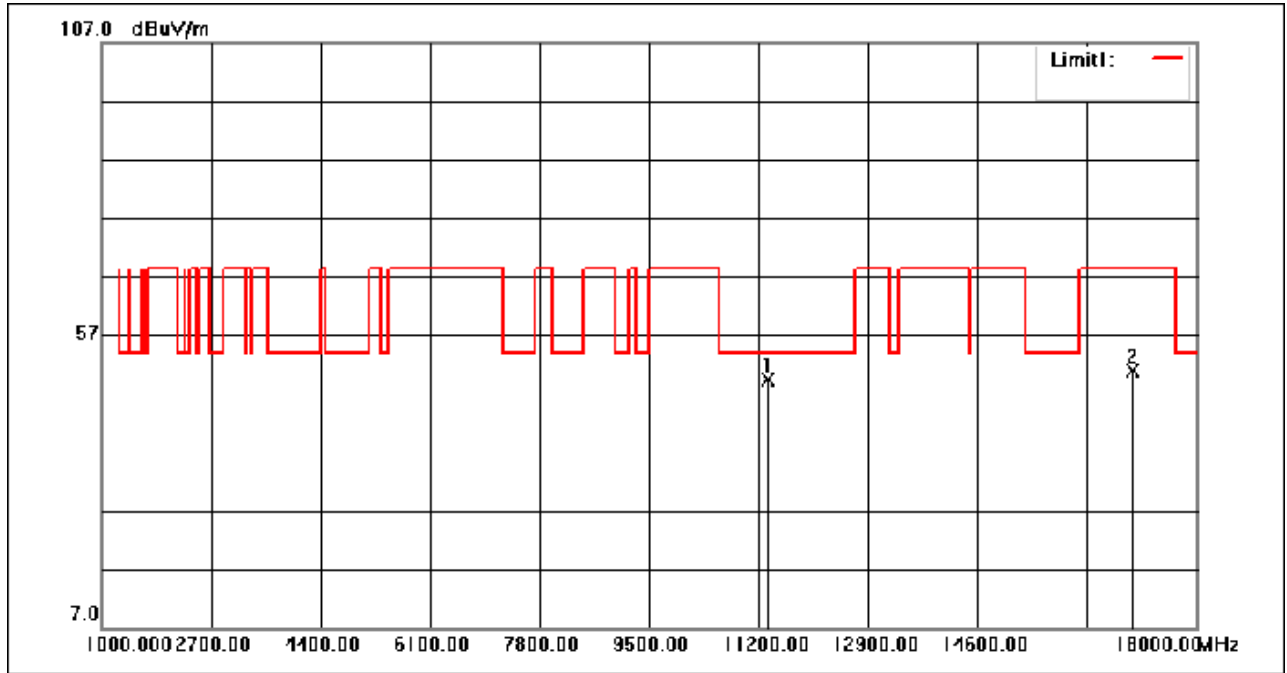

No.	Frequency (MHz)	Reading (dBuV)	Correction factor(dB/m)	Result (dBuV/m)	Limit (dBuV/m)	Margin (dB)	Remark
1	11340.000	48.46	0.82	49.28	54.00	-4.72	peak
2	17010.000	41.58	9.18	50.76	68.30	-17.54	peak



Unless otherwise agreed in writing, this document is issued by the Company subject to its General Conditions of Service printed overleaf, available on request or accessible at <http://www.sgs.com/en/Terms-and-Conditions.aspx> and, for electronic format documents, subject to Terms and Conditions for Electronic Documents at <http://www.sgs.com/en/Terms-and-Conditions/Terms-e-Documents.aspx>. Attention is drawn to the limitation of liability, indemnification and jurisdiction issues defined therein. Any holder of this document is advised that information contained hereon reflects the Company's findings at the time of its intervention only and within the limits of Client's instructions, if any. The Company's sole responsibility is to its Client and this document does not exonerate parties to a transaction from exercising all their rights and obligations under the transaction documents. This document cannot be reproduced except in full, without prior written approval of the Company. Any unauthorized alteration, forgery or falsification of the content or appearance of this document is unlawful and offenders may be prosecuted to the fullest extent of the law. Unless otherwise stated the results shown in this test report refer only to the sample(s) tested and such sample(s) are retained for 30 days only.  
**Attention: To check the authenticity of testing /inspection report & certificate, please contact us at telephone: (86-755) 8307 1443, or email: CN.Doccheck@sgs.com**

No.10, Weiye Road, Innovation Park, Kunshan, Jiangsu, China 215300  
 中国·江苏·昆山市留学生创业园伟业路10号 邮编 215300

t(86-512)57355888 f(86-512)57370818 www.sgsgroup.com.cn  
 t(86-512)57355888 f(86-512)57370818 sgs.china@sgs.com

Test Mode: 03; Polarity: Vertical; Modulation:802.11ac; Bandwidth:40MHz; Channel:High

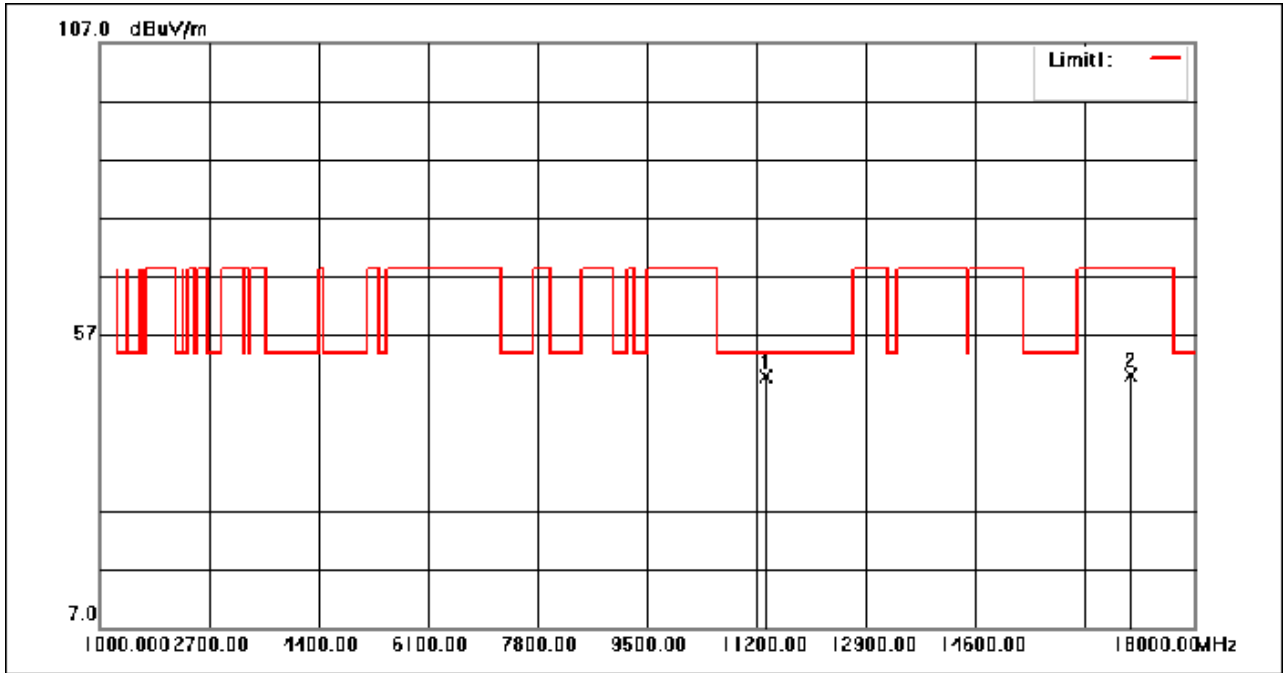

No.	Frequency (MHz)	Reading (dBuV)	Correction factor(dB/m)	Result (dBuV/m)	Limit (dBuV/m)	Margin (dB)	Remark
1	11340.000	49.03	0.82	49.85	54.00	-4.15	peak
2	17010.000	40.83	9.18	50.01	68.30	-18.29	peak



Unless otherwise agreed in writing, this document is issued by the Company subject to its General Conditions of Service printed overleaf, available on request or accessible at <http://www.sgs.com/en/Terms-and-Conditions.aspx> and, for electronic format documents, subject to Terms and Conditions for Electronic Documents at <http://www.sgs.com/en/Terms-and-Conditions/Terms-e-Documents.aspx>. Attention is drawn to the limitation of liability, indemnification and jurisdiction issues defined therein. Any holder of this document is advised that information contained hereon reflects the Company's findings at the time of its intervention only and within the limits of Client's instructions, if any. The Company's sole responsibility is to its Client and this document does not exonerate parties to a transaction from exercising all their rights and obligations under the transaction documents. This document cannot be reproduced except in full, without prior written approval of the Company. Any unauthorized alteration, forgery or falsification of the content or appearance of this document is unlawful and offenders may be prosecuted to the fullest extent of the law. Unless otherwise stated the results shown in this test report refer only to the sample(s) tested and such sample(s) are retained for 30 days only.  
**Attention: To check the authenticity of testing /inspection report & certificate, please contact us at telephone: (86-755) 8307 1443, or email: CN.Doccheck@sgs.com**

No.10, Weiye Road, Innovation Park, Kunshan, Jiangsu, China 215300  
 中国·江苏·昆山市留学生创业园伟业路10号 邮编 215300

t(86-512)57355888 f(86-512)57370818 www.sgsgroup.com.cn  
 t(86-512)57355888 f(86-512)57370818 sgs.china@sgs.com

Test Mode: 03; Polarity: Horizontal; Modulation:802.11ac; Bandwidth:80MHz; Channel:Low

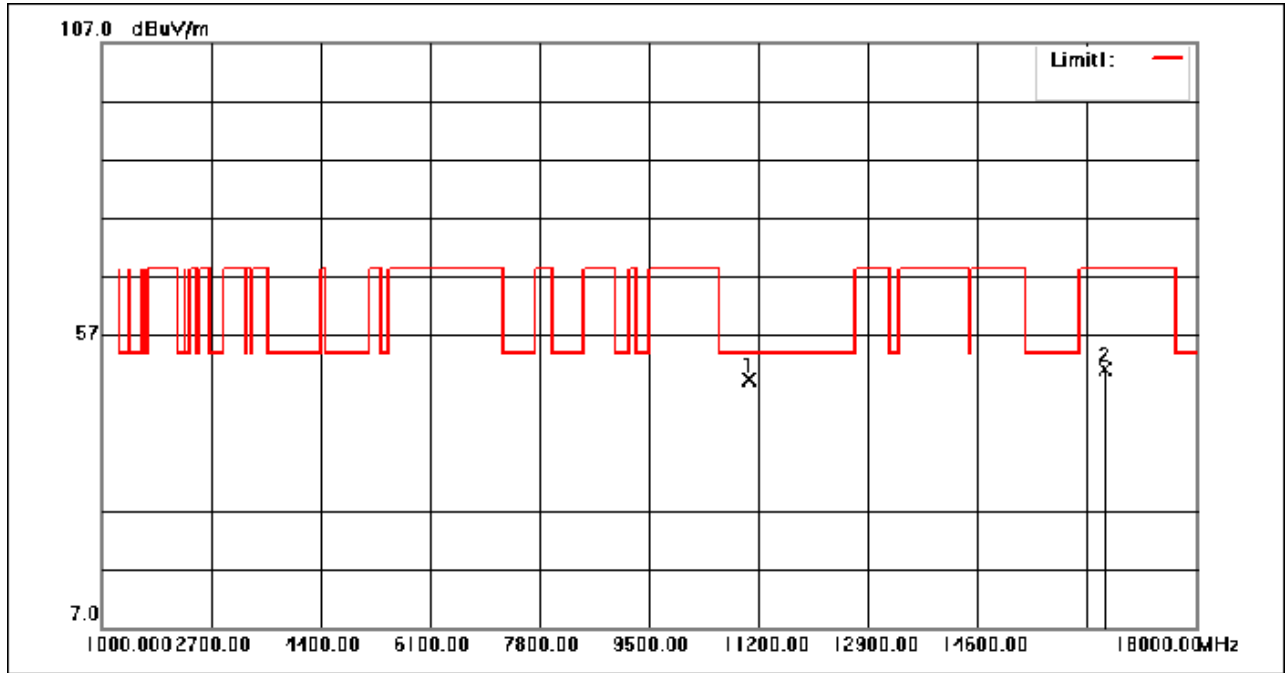

No.	Frequency (MHz)	Reading (dBuV)	Correction factor(dB/m)	Result (dBuV/m)	Limit (dBuV/m)	Margin (dB)	Remark
1	11060.000	48.84	0.59	49.43	54.00	-4.57	peak
2	16590.000	42.45	8.56	51.01	68.30	-17.29	peak



Unless otherwise agreed in writing, this document is issued by the Company subject to its General Conditions of Service printed overleaf, available on request or accessible at <http://www.sgs.com/en/Terms-and-Conditions.aspx> and, for electronic format documents, subject to Terms and Conditions for Electronic Documents at <http://www.sgs.com/en/Terms-and-Conditions/Terms-e-Documents.aspx>. Attention is drawn to the limitation of liability, indemnification and jurisdiction issues defined therein. Any holder of this document is advised that information contained hereon reflects the Company's findings at the time of its intervention only and within the limits of Client's instructions, if any. The Company's sole responsibility is to its Client and this document does not exonerate parties to a transaction from exercising all their rights and obligations under the transaction documents. This document cannot be reproduced except in full, without prior written approval of the Company. Any unauthorized alteration, forgery or falsification of the content or appearance of this document is unlawful and offenders may be prosecuted to the fullest extent of the law. Unless otherwise stated the results shown in this test report refer only to the sample(s) tested and such sample(s) are retained for 30 days only.  
**Attention: To check the authenticity of testing /inspection report & certificate, please contact us at telephone: (86-755) 8307 1443, or email: CN\_Doccheck@sgs.com**

No.10, Weiye Road, Innovation Park, Kunshan, Jiangsu, China 215300  
 中国·江苏·昆山市留学生创业园伟业路10号 邮编 215300

t(86-512)57355888 f(86-512)57370818 www.sgsgroup.com.cn  
 t(86-512)57355888 f(86-512)57370818 sgs.china@sgs.com



Test Mode: 03; Polarity: Vertical; Modulation:802.11ac; Bandwidth:80MHz; Channel:Low

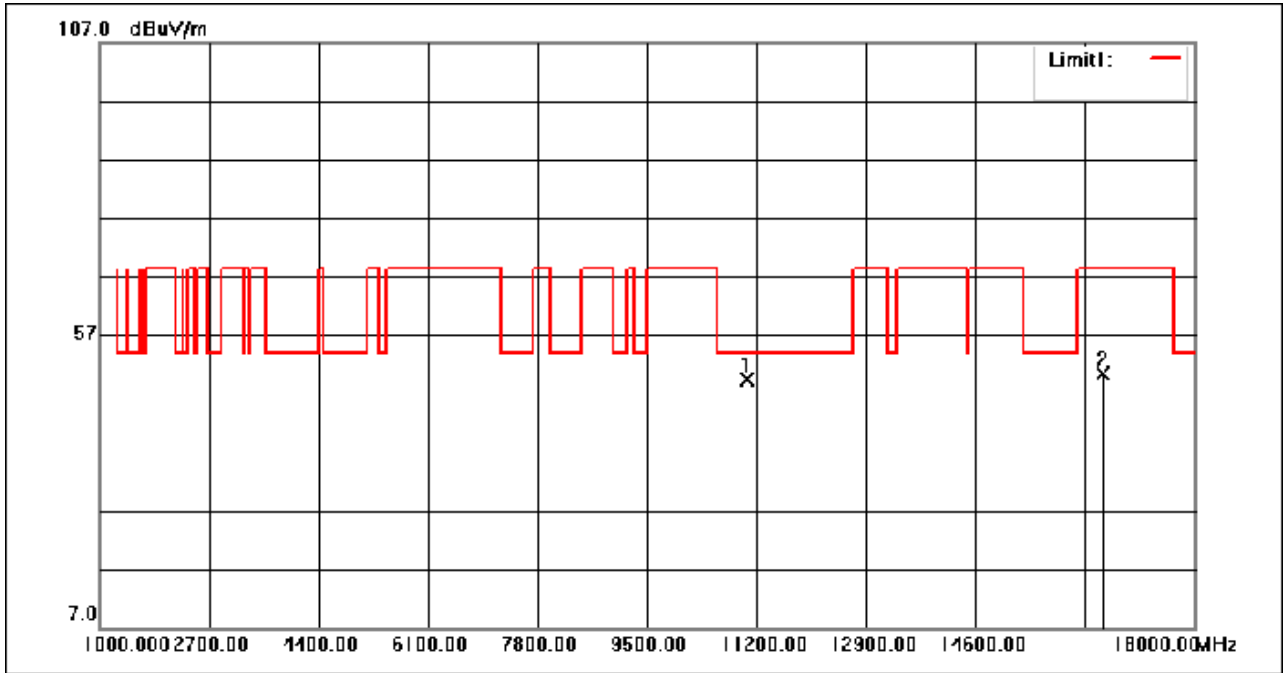

No.	Frequency (MHz)	Reading (dBuV)	Correction factor(dB/m)	Result (dBuV/m)	Limit (dBuV/m)	Margin (dB)	Remark
1	11060.000	48.85	0.59	49.44	54.00	-4.56	peak
2	16590.000	41.79	8.56	50.35	68.30	-17.95	peak



Unless otherwise agreed in writing, this document is issued by the Company subject to its General Conditions of Service printed overleaf, available on request or accessible at <http://www.sgs.com/en/Terms-and-Conditions.aspx> and, for electronic format documents, subject to Terms and Conditions for Electronic Documents at <http://www.sgs.com/en/Terms-and-Conditions/Terms-e-Documents.aspx>. Attention is drawn to the limitation of liability, indemnification and jurisdiction issues defined therein. Any holder of this document is advised that information contained hereon reflects the Company's findings at the time of its intervention only and within the limits of Client's instructions, if any. The Company's sole responsibility is to its Client and this document does not exonerate parties to a transaction from exercising all their rights and obligations under the transaction documents. This document cannot be reproduced except in full, without prior written approval of the Company. Any unauthorized alteration, forgery or falsification of the content or appearance of this document is unlawful and offenders may be prosecuted to the fullest extent of the law. Unless otherwise stated the results shown in this test report refer only to the sample(s) tested and such sample(s) are retained for 30 days only.  
**Attention: To check the authenticity of testing /inspection report & certificate, please contact us at telephone: (86-755) 8307 1443, or email: CN.Doccheck@sgs.com**

Compliance Certification Services (Kunshan) Inc.  
EMC Laboratory

No.10, Weiye Road, Innovation Park, Kunshan, Jiangsu, China 215300  
中国·江苏·昆山市留学生创业园伟业路10号 邮编 215300

t(86-512)57355888 f(86-512)57370818 www.sgsgroup.com.cn  
t(86-512)57355888 f(86-512)57370818 sgs.china@sgs.com

Test Mode: 03; Polarity: Horizontal; Modulation:802.11ac; Bandwidth:80MHz; Channel:High

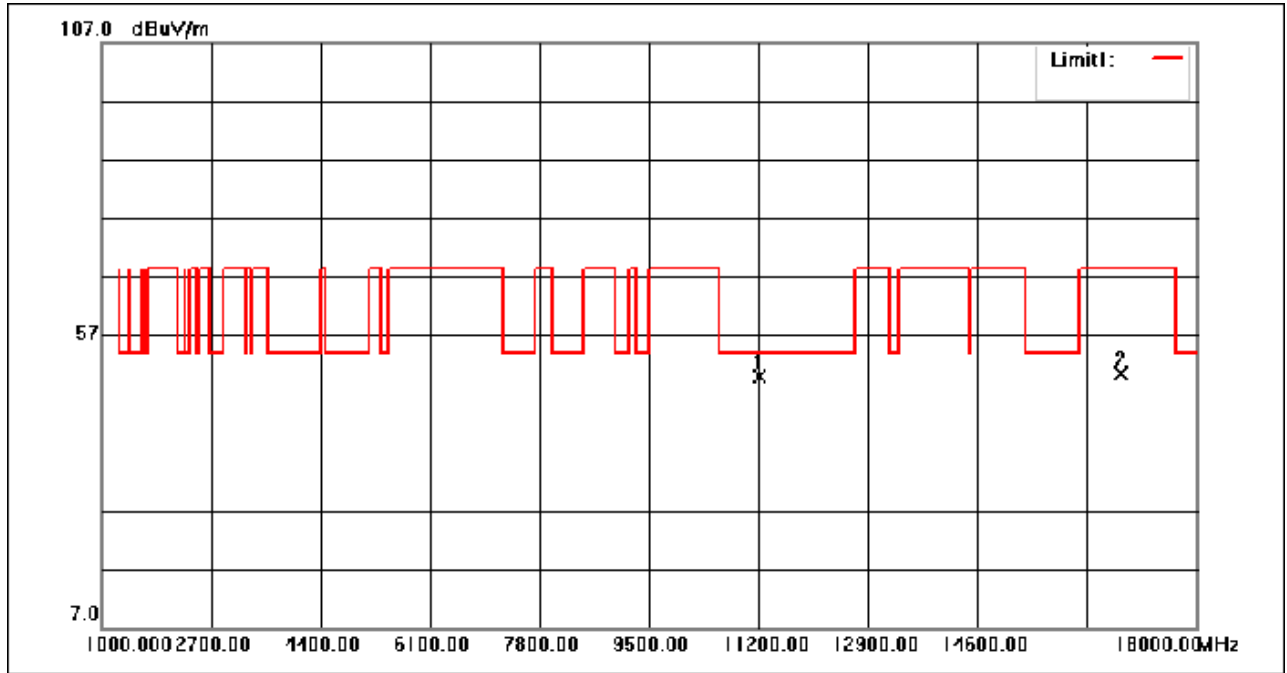

No.	Frequency (MHz)	Reading (dBuV)	Correction factor(dB/m)	Result (dBuV/m)	Limit (dBuV/m)	Margin (dB)	Remark
1	11220.000	49.05	0.72	49.77	54.00	-4.23	peak
2	16830.000	41.56	8.93	50.49	68.30	-17.81	peak



Unless otherwise agreed in writing, this document is issued by the Company subject to its General Conditions of Service printed overleaf, available on request or accessible at <http://www.sgs.com/en/Terms-and-Conditions.aspx> and, for electronic format documents, subject to Terms and Conditions for Electronic Documents at <http://www.sgs.com/en/Terms-and-Conditions/Terms-e-Documents.aspx>. Attention is drawn to the limitation of liability, indemnification and jurisdiction issues defined therein. Any holder of this document is advised that information contained hereon reflects the Company's findings at the time of its intervention only and within the limits of Client's instructions, if any. The Company's sole responsibility is to its Client and this document does not exonerate parties to a transaction from exercising all their rights and obligations under the transaction documents. This document cannot be reproduced except in full, without prior written approval of the Company. Any unauthorized alteration, forgery or falsification of the content or appearance of this document is unlawful and offenders may be prosecuted to the fullest extent of the law. Unless otherwise stated the results shown in this test report refer only to the sample(s) tested and such sample(s) are retained for 30 days only.  
**Attention: To check the authenticity of testing /inspection report & certificate, please contact us at telephone: (86-755) 8307 1443, or email: CN.Doccheck@sgs.com**

No.10, Weiye Road, Innovation Park, Kunshan, Jiangsu, China 215300  
 中国·江苏·昆山市留学生创业园伟业路10号 邮编 215300

t(86-512)57355888 f(86-512)57370818 www.sgsgroup.com.cn  
 t(86-512)57355888 f(86-512)57370818 sgs.china@sgs.com

Test Mode: 03; Polarity: Vertical; Modulation:802.11ac; Bandwidth:80MHz; Channel:High

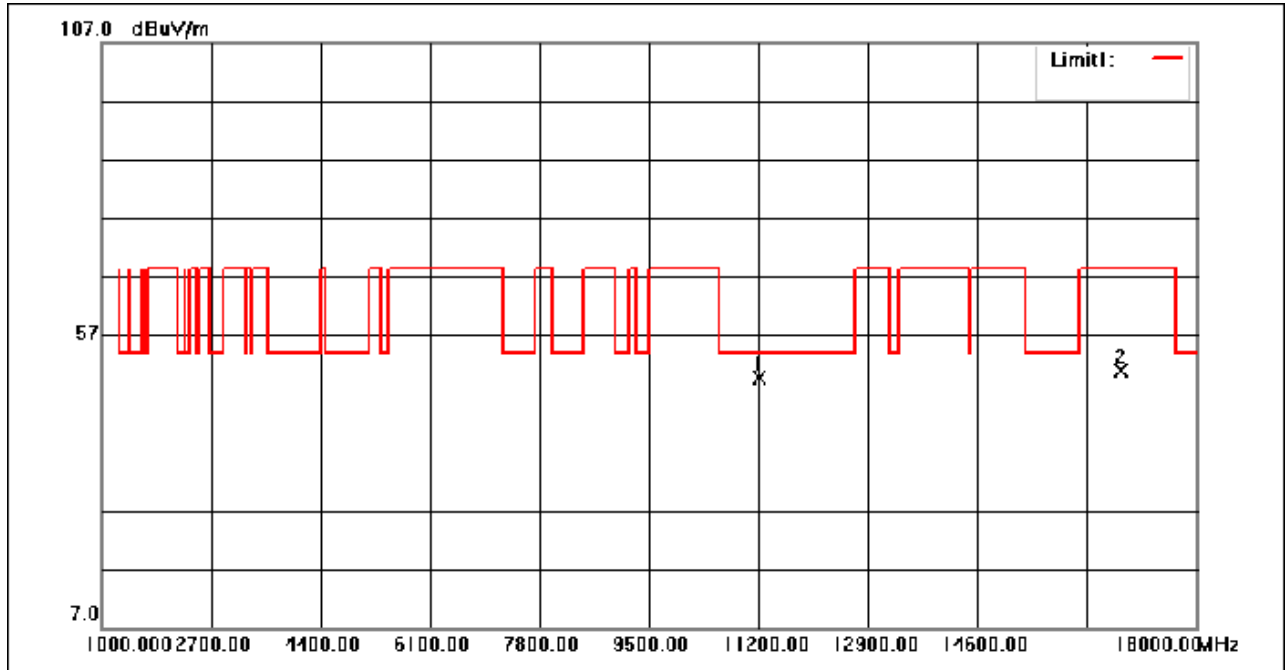

No.	Frequency (MHz)	Reading (dBuV)	Correction factor(dB/m)	Result (dBuV/m)	Limit (dBuV/m)	Margin (dB)	Remark
1	11220.000	48.96	0.72	49.68	54.00	-4.32	peak
2	16830.000	42.06	8.93	50.99	68.30	-17.31	peak



Unless otherwise agreed in writing, this document is issued by the Company subject to its General Conditions of Service printed overleaf, available on request or accessible at <http://www.sgs.com/en/Terms-and-Conditions.aspx> and, for electronic format documents, subject to Terms and Conditions for Electronic Documents at <http://www.sgs.com/en/Terms-and-Conditions/Terms-e-Documents.aspx>. Attention is drawn to the limitation of liability, indemnification and jurisdiction issues defined therein. Any holder of this document is advised that information contained hereon reflects the Company's findings at the time of its intervention only and within the limits of Client's instructions, if any. The Company's sole responsibility is to its Client and this document does not exonerate parties to a transaction from exercising all their rights and obligations under the transaction documents. This document cannot be reproduced except in full, without prior written approval of the Company. Any unauthorized alteration, forgery or falsification of the content or appearance of this document is unlawful and offenders may be prosecuted to the fullest extent of the law. Unless otherwise stated the results shown in this test report refer only to the sample(s) tested and such sample(s) are retained for 30 days only.  
**Attention: To check the authenticity of testing /inspection report & certificate, please contact us at telephone: (86-755) 8307 1443, or email: CN.Doccheck@sgs.com**

No.10, Weiye Road, Innovation Park, Kunshan, Jiangsu, China 215300  
 中国·江苏·昆山市留学生创业园伟业路10号 邮编 215300

t(86-512)57355888 f(86-512)57370818 www.sgsgroup.com.cn  
 t(86-512)57355888 f(86-512)57370818 sgs.china@sgs.com

Test Mode: 04; Polarity: Horizontal; Modulation:802.11a; Bandwidth:20MHz; Channel:Low

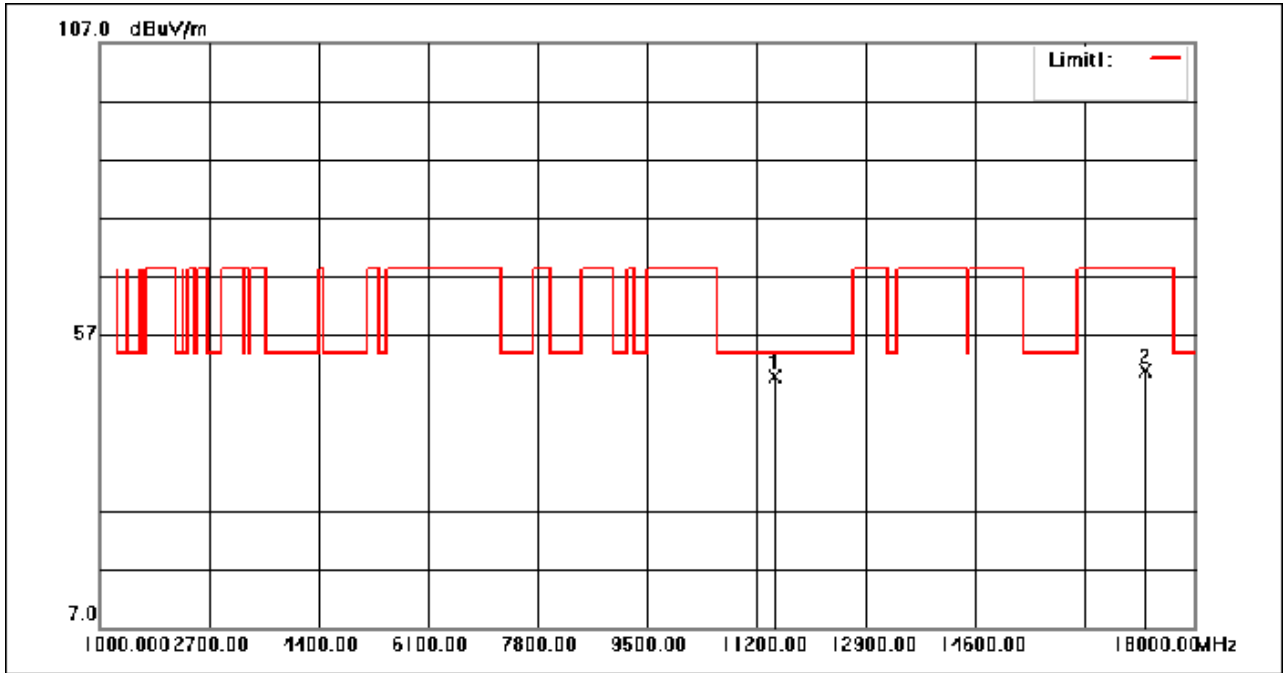

No.	Frequency (MHz)	Reading (dBuV)	Correction factor(dB/m)	Result (dBuV/m)	Limit (dBuV/m)	Margin (dB)	Remark
1	11490.000	48.97	0.94	49.91	54.00	-4.09	peak
2	17235.000	41.91	9.05	50.96	68.30	-17.34	peak



Unless otherwise agreed in writing, this document is issued by the Company subject to its General Conditions of Service printed overleaf, available on request or accessible at <http://www.sgs.com/en/Terms-and-Conditions.aspx> and, for electronic format documents, subject to Terms and Conditions for Electronic Documents at <http://www.sgs.com/en/Terms-and-Conditions/Terms-e-Documents.aspx>. Attention is drawn to the limitation of liability, indemnification and jurisdiction issues defined therein. Any holder of this document is advised that information contained hereon reflects the Company's findings at the time of its intervention only and within the limits of Client's instructions, if any. The Company's sole responsibility is to its Client and this document does not exonerate parties to a transaction from exercising all their rights and obligations under the transaction documents. This document cannot be reproduced except in full, without prior written approval of the Company. Any unauthorized alteration, forgery or falsification of the content or appearance of this document is unlawful and offenders may be prosecuted to the fullest extent of the law. Unless otherwise stated the results shown in this test report refer only to the sample(s) tested and such sample(s) are retained for 30 days only.  
Attention: To check the authenticity of testing /inspection report & certificate, please contact us at telephone: (86-755) 8307 1443, or email: [CN.Doccheck@sgs.com](mailto:CN.Doccheck@sgs.com)

No.10, Weiye Road, Innovation Park, Kunshan, Jiangsu, China 215300  
中国·江苏·昆山市留学生创业园伟业路10号 邮编 215300

t(86-512)57355888 f(86-512)57370818 www.sgsgroup.com.cn  
t(86-512)57355888 f(86-512)57370818 sgs.china@sgs.com

Test Mode: 04; Polarity: Vertical; Modulation:802.11a; Bandwidth:20MHz; Channel:Low

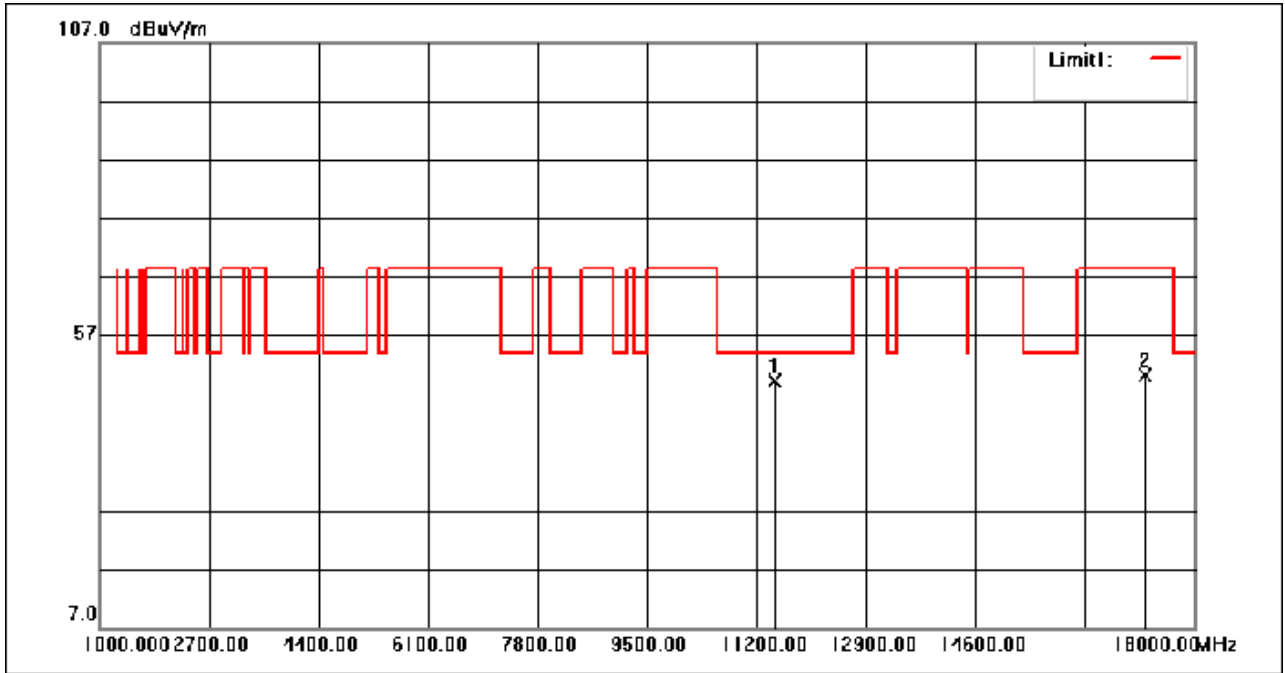

No.	Frequency (MHz)	Reading (dBuV)	Correction factor(dB/m)	Result (dBuV/m)	Limit (dBuV/m)	Margin (dB)	Remark
1	11490.000	48.11	0.94	49.05	54.00	-4.95	peak
2	17235.000	41.11	9.05	50.16	68.30	-18.14	peak



Unless otherwise agreed in writing, this document is issued by the Company subject to its General Conditions of Service printed overleaf, available on request or accessible at <http://www.sgs.com/en/Terms-and-Conditions.aspx> and, for electronic format documents, subject to Terms and Conditions for Electronic Documents at <http://www.sgs.com/en/Terms-and-Conditions/Terms-e-Documents.aspx>. Attention is drawn to the limitation of liability, indemnification and jurisdiction issues defined therein. Any holder of this document is advised that information contained hereon reflects the Company's findings at the time of its intervention only and within the limits of Client's instructions, if any. The Company's sole responsibility is to its Client and this document does not exonerate parties to a transaction from exercising all their rights and obligations under the transaction documents. This document cannot be reproduced except in full, without prior written approval of the Company. Any unauthorized alteration, forgery or falsification of the content or appearance of this document is unlawful and offenders may be prosecuted to the fullest extent of the law. Unless otherwise stated the results shown in this test report refer only to the sample(s) tested and such sample(s) are retained for 30 days only.  
**Attention: To check the authenticity of testing /inspection report & certificate, please contact us at telephone: (86-755) 8307 1443, or email: CN\_Doccheck@sgs.com**

No.10, Weiye Road, Innovation Park, Kunshan, Jiangsu, China 215300  
 中国·江苏·昆山市留学生创业园伟业路10号 邮编 215300

t(86-512)57355888 f(86-512)57370818 www.sgsgroup.com.cn  
 t(86-512)57355888 f(86-512)57370818 sgs.china@sgs.com



Test Mode: 04; Polarity: Horizontal; Modulation:802.11a; Bandwidth:20MHz; Channel:middle

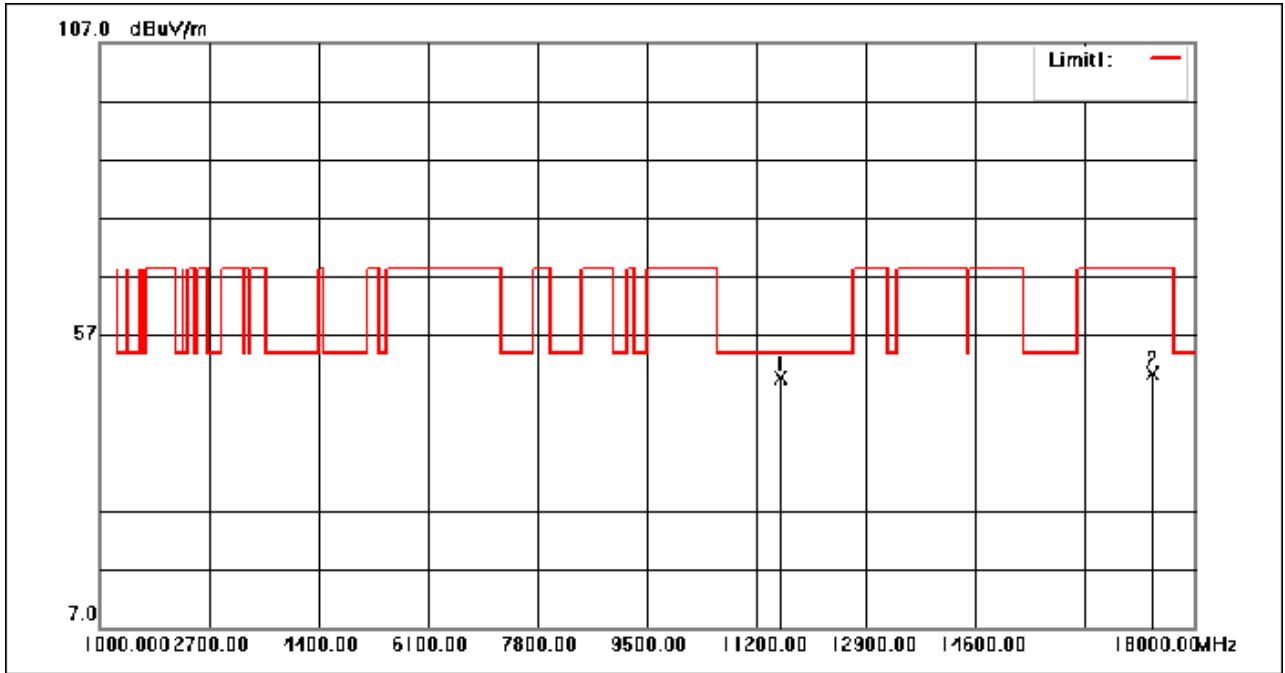

No.	Frequency (MHz)	Reading (dBuV)	Correction factor(dB/m)	Result (dBuV/m)	Limit (dBuV/m)	Margin (dB)	Remark
1	11570.000	48.36	1.18	49.54	54.00	-4.46	peak
2	17355.000	41.44	8.98	50.42	68.30	-17.88	peak



Unless otherwise agreed in writing, this document is issued by the Company subject to its General Conditions of Service printed overleaf, available on request or accessible at <http://www.sgs.com/en/Terms-and-Conditions.aspx> and, for electronic format documents, subject to Terms and Conditions for Electronic Documents at <http://www.sgs.com/en/Terms-and-Conditions/Terms-e-Documents.aspx>. Attention is drawn to the limitation of liability, indemnification and jurisdiction issues defined therein. Any holder of this document is advised that information contained hereon reflects the Company's findings at the time of its intervention only and within the limits of Client's instructions, if any. The Company's sole responsibility is to its Client and this document does not exonerate parties to a transaction from exercising all their rights and obligations under the transaction documents. This document cannot be reproduced except in full, without prior written approval of the Company. Any unauthorized alteration, forgery or falsification of the content or appearance of this document is unlawful and offenders may be prosecuted to the fullest extent of the law. Unless otherwise stated the results shown in this test report refer only to the sample(s) tested and such sample(s) are retained for 30 days only.  
**Attention: To check the authenticity of testing /inspection report & certificate, please contact us at telephone: (86-755) 8307 1443, or email: CN.Doccheck@sgs.com**

No.10, Weiye Road, Innovation Park, Kunshan, Jiangsu, China 215300  
 中国·江苏·昆山市留学生创业园伟业路10号 邮编 215300

t(86-512)57355888 f(86-512)57370818 www.sgsgroup.com.cn  
 t(86-512)57355888 f(86-512)57370818 sgs.china@sgs.com

Test Mode: 04; Polarity: Vertical; Modulation:802.11a; Bandwidth:20MHz; Channel:middle

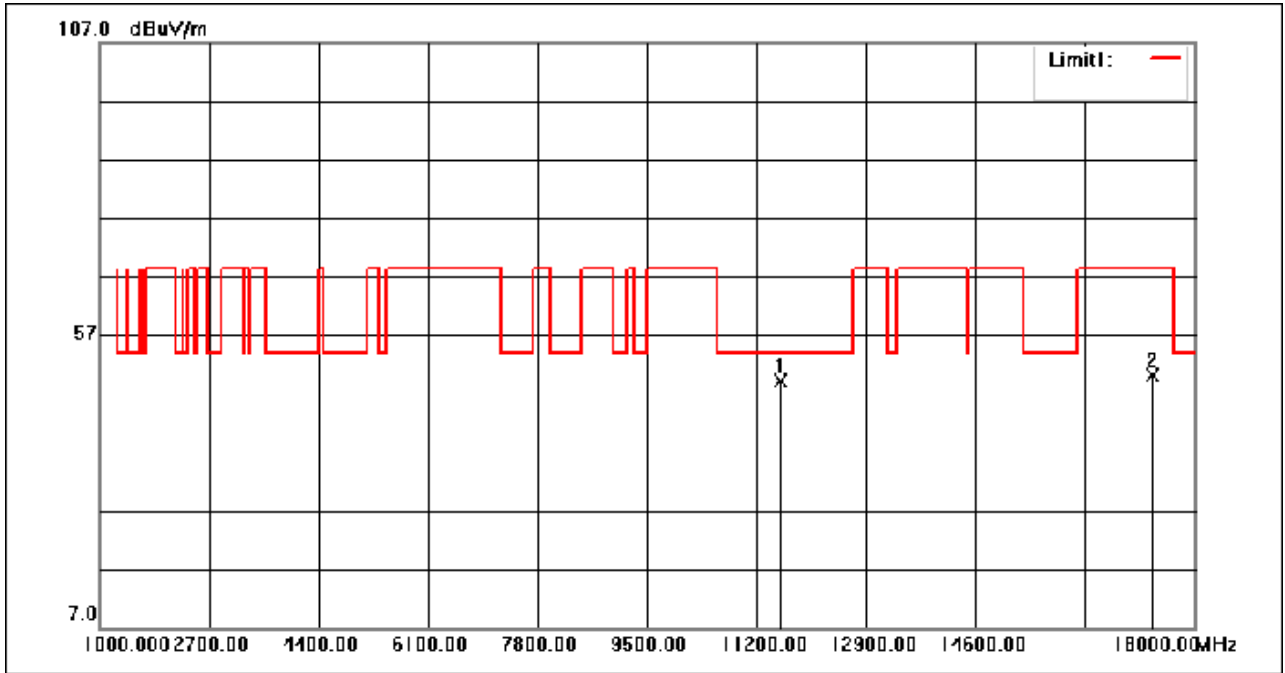

No.	Frequency (MHz)	Reading (dBuV)	Correction factor(dB/m)	Result (dBuV/m)	Limit (dBuV/m)	Margin (dB)	Remark
1	11570.000	47.98	1.18	49.16	54.00	-4.84	peak
2	17355.000	41.03	8.98	50.01	68.30	-18.29	peak



Unless otherwise agreed in writing, this document is issued by the Company subject to its General Conditions of Service printed overleaf, available on request or accessible at <http://www.sgs.com/en/Terms-and-Conditions.aspx> and, for electronic format documents, subject to Terms and Conditions for Electronic Documents at <http://www.sgs.com/en/Terms-and-Conditions/Terms-e-Documents.aspx>. Attention is drawn to the limitation of liability, indemnification and jurisdiction issues defined therein. Any holder of this document is advised that information contained hereon reflects the Company's findings at the time of its intervention only and within the limits of Client's instructions, if any. The Company's sole responsibility is to its Client and this document does not exonerate parties to a transaction from exercising all their rights and obligations under the transaction documents. This document cannot be reproduced except in full, without prior written approval of the Company. Any unauthorized alteration, forgery or falsification of the content or appearance of this document is unlawful and offenders may be prosecuted to the fullest extent of the law. Unless otherwise stated the results shown in this test report refer only to the sample(s) tested and such sample(s) are retained for 30 days only.  
**Attention: To check the authenticity of testing /inspection report & certificate, please contact us at telephone: (86-755) 8307 1443, or email: CN\_Doccheck@sgs.com**

No.10, Weiye Road, Innovation Park, Kunshan, Jiangsu, China 215300  
 中国·江苏·昆山市留学生创业园伟业路10号 邮编 215300

t(86-512)57355888 f(86-512)57370818 www.sgsgroup.com.cn  
 t(86-512)57355888 f(86-512)57370818 sgs.china@sgs.com

Test Mode: 04; Polarity: Horizontal; Modulation:802.11a; Bandwidth:20MHz; Channel:High

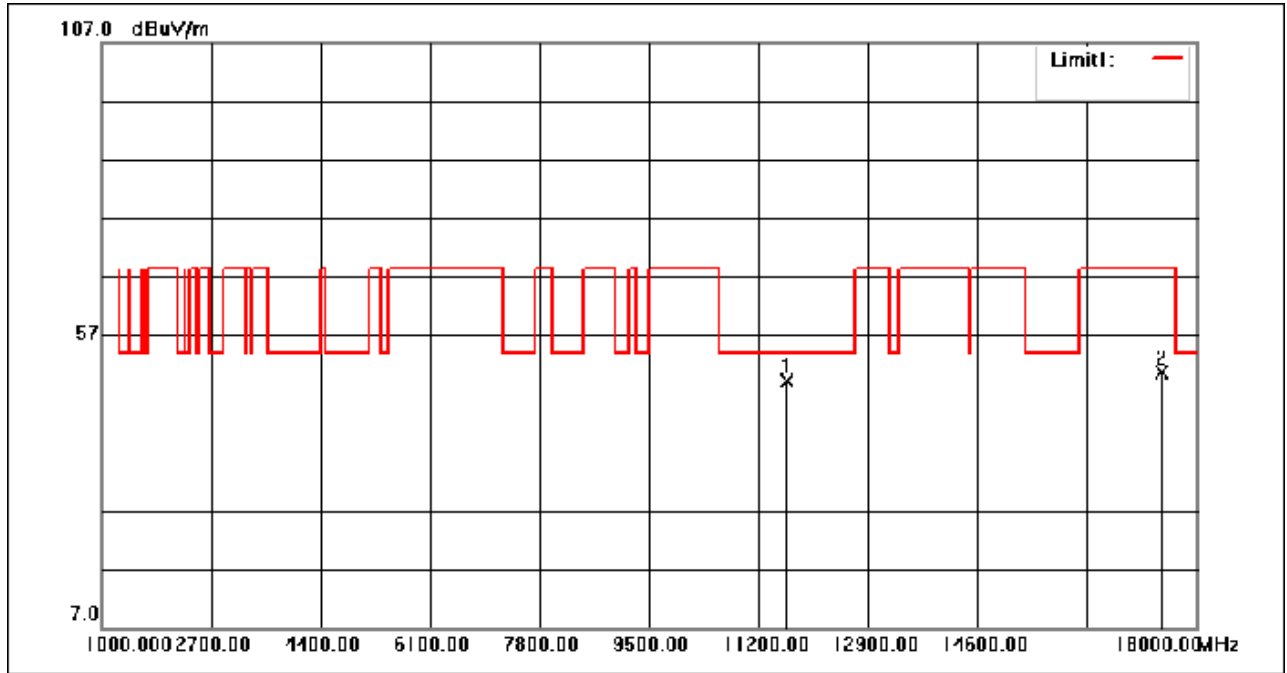

No.	Frequency (MHz)	Reading (dBuV)	Correction factor(dB/m)	Result (dBuV/m)	Limit (dBuV/m)	Margin (dB)	Remark
1	11650.000	47.76	1.45	49.21	54.00	-4.79	peak
2	17475.000	41.72	8.90	50.62	68.30	-17.68	peak



Unless otherwise agreed in writing, this document is issued by the Company subject to its General Conditions of Service printed overleaf, available on request or accessible at <http://www.sgs.com/en/Terms-and-Conditions.aspx> and, for electronic format documents, subject to Terms and Conditions for Electronic Documents at <http://www.sgs.com/en/Terms-and-Conditions/Terms-e-Documents.aspx>. Attention is drawn to the limitation of liability, indemnification and jurisdiction issues defined therein. Any holder of this document is advised that information contained hereon reflects the Company's findings at the time of its intervention only and within the limits of Client's instructions, if any. The Company's sole responsibility is to its Client and this document does not exonerate parties to a transaction from exercising all their rights and obligations under the transaction documents. This document cannot be reproduced except in full, without prior written approval of the Company. Any unauthorized alteration, forgery or falsification of the content or appearance of this document is unlawful and offenders may be prosecuted to the fullest extent of the law. Unless otherwise stated the results shown in this test report refer only to the sample(s) tested and such sample(s) are retained for 30 days only.  
**Attention: To check the authenticity of testing /inspection report & certificate, please contact us at telephone: (86-755) 8307 1443, or email: CN.Doccheck@sgs.com**

No.10, Weiye Road, Innovation Park, Kunshan, Jiangsu, China 215300  
 中国·江苏·昆山市留学生创业园伟业路10号 邮编 215300

t(86-512)57355888 f(86-512)57370818 www.sgsgroup.com.cn  
 t(86-512)57355888 f(86-512)57370818 sgs.china@sgs.com

Test Mode: 04; Polarity: Vertical; Modulation:802.11a; Bandwidth:20MHz; Channel:High

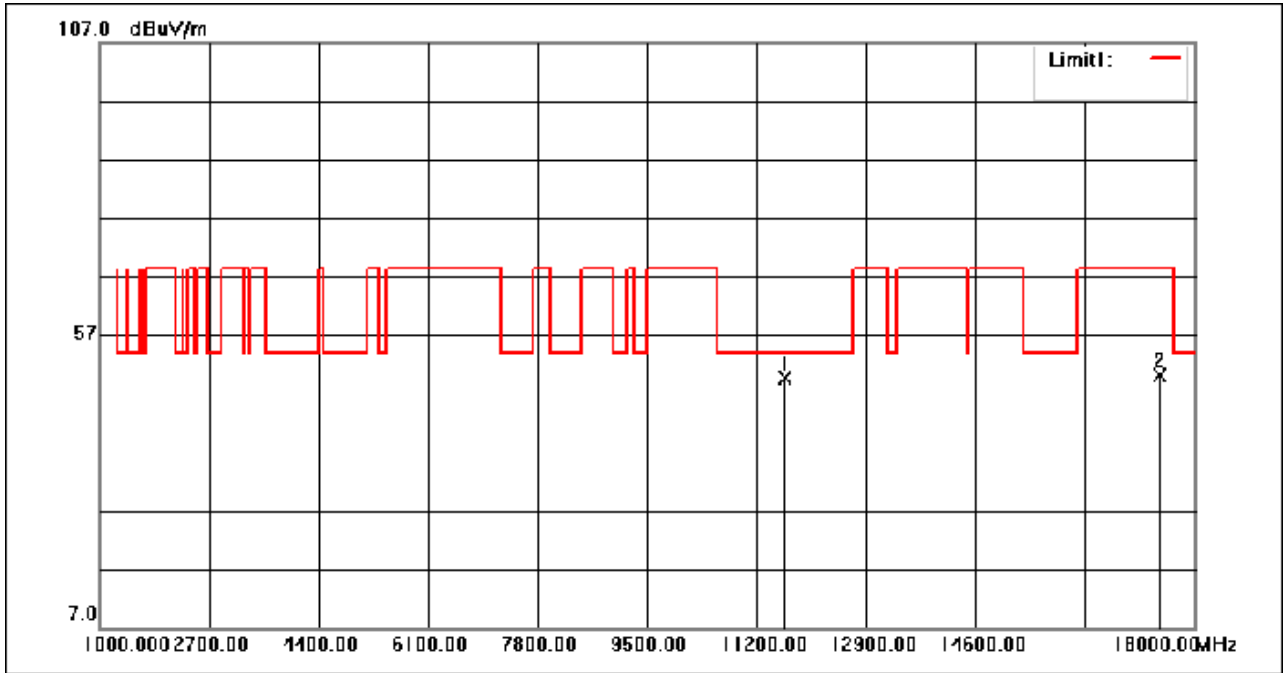

No.	Frequency (MHz)	Reading (dBuV)	Correction factor(dB/m)	Result (dBuV/m)	Limit (dBuV/m)	Margin (dB)	Remark
1	11650.000	48.11	1.45	49.56	54.00	-4.44	peak
2	17475.000	41.34	8.90	50.24	68.30	-18.06	peak



Unless otherwise agreed in writing, this document is issued by the Company subject to its General Conditions of Service printed overleaf, available on request or accessible at <http://www.sgs.com/en/Terms-and-Conditions.aspx> and, for electronic format documents, subject to Terms and Conditions for Electronic Documents at <http://www.sgs.com/en/Terms-and-Conditions/Terms-e-Documents.aspx>. Attention is drawn to the limitation of liability, indemnification and jurisdiction issues defined therein. Any holder of this document is advised that information contained hereon reflects the Company's findings at the time of its intervention only and within the limits of Client's instructions, if any. The Company's sole responsibility is to its Client and this document does not exonerate parties to a transaction from exercising all their rights and obligations under the transaction documents. This document cannot be reproduced except in full, without prior written approval of the Company. Any unauthorized alteration, forgery or falsification of the content or appearance of this document is unlawful and offenders may be prosecuted to the fullest extent of the law. Unless otherwise stated the results shown in this test report refer only to the sample(s) tested and such sample(s) are retained for 30 days only.  
**Attention: To check the authenticity of testing /inspection report & certificate, please contact us at telephone: (86-755) 8307 1443, or email: CN.Doccheck@sgs.com**

No.10, Weiye Road, Innovation Park, Kunshan, Jiangsu, China 215300  
 中国·江苏·昆山市留学生创业园伟业路10号 邮编 215300

t(86-512)57355888 f(86-512)57370818 www.sgsgroup.com.cn  
 t(86-512)57355888 f(86-512)57370818 sgs.china@sgs.com

Test Mode: 04; Polarity: Horizontal; Modulation:802.11n; Bandwidth:20MHz; Channel:Low

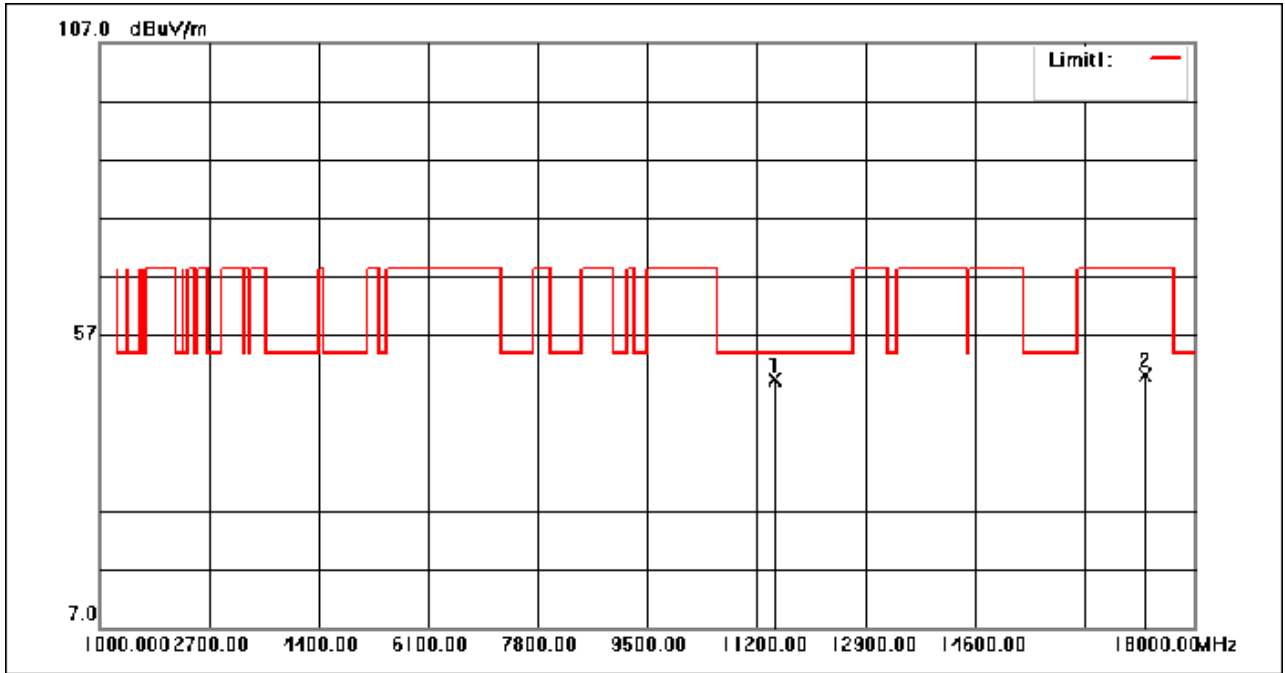

No.	Frequency (MHz)	Reading (dBuV)	Correction factor(dB/m)	Result (dBuV/m)	Limit (dBuV/m)	Margin (dB)	Remark
1	11490.000	48.55	0.94	49.49	54.00	-4.51	peak
2	17235.000	41.16	9.05	50.21	68.30	-18.09	peak



Unless otherwise agreed in writing, this document is issued by the Company subject to its General Conditions of Service printed overleaf, available on request or accessible at <http://www.sgs.com/en/Terms-and-Conditions.aspx> and, for electronic format documents, subject to Terms and Conditions for Electronic Documents at <http://www.sgs.com/en/Terms-and-Conditions/Terms-e-Documents.aspx>. Attention is drawn to the limitation of liability, indemnification and jurisdiction issues defined therein. Any holder of this document is advised that information contained hereon reflects the Company's findings at the time of its intervention only and within the limits of Client's instructions, if any. The Company's sole responsibility is to its Client and this document does not exonerate parties to a transaction from exercising all their rights and obligations under the transaction documents. This document cannot be reproduced except in full, without prior written approval of the Company. Any unauthorized alteration, forgery or falsification of the content or appearance of this document is unlawful and offenders may be prosecuted to the fullest extent of the law. Unless otherwise stated the results shown in this test report refer only to the sample(s) tested and such sample(s) are retained for 30 days only.  
Attention: To check the authenticity of testing /inspection report & certificate, please contact us at telephone: (86-755) 8307 1443, or email: [CN.Doccheck@sgs.com](mailto:CN.Doccheck@sgs.com)

No.10, Weiye Road, Innovation Park, Kunshan, Jiangsu, China 215300  
中国·江苏·昆山市留学生创业园伟业路10号 邮编 215300

t(86-512)57355888 f(86-512)57370818 www.sgsgroup.com.cn  
t(86-512)57355888 f(86-512)57370818 sgs.china@sgs.com



Test Mode: 04; Polarity: Vertical; Modulation:802.11n; Bandwidth:20MHz; Channel:Low

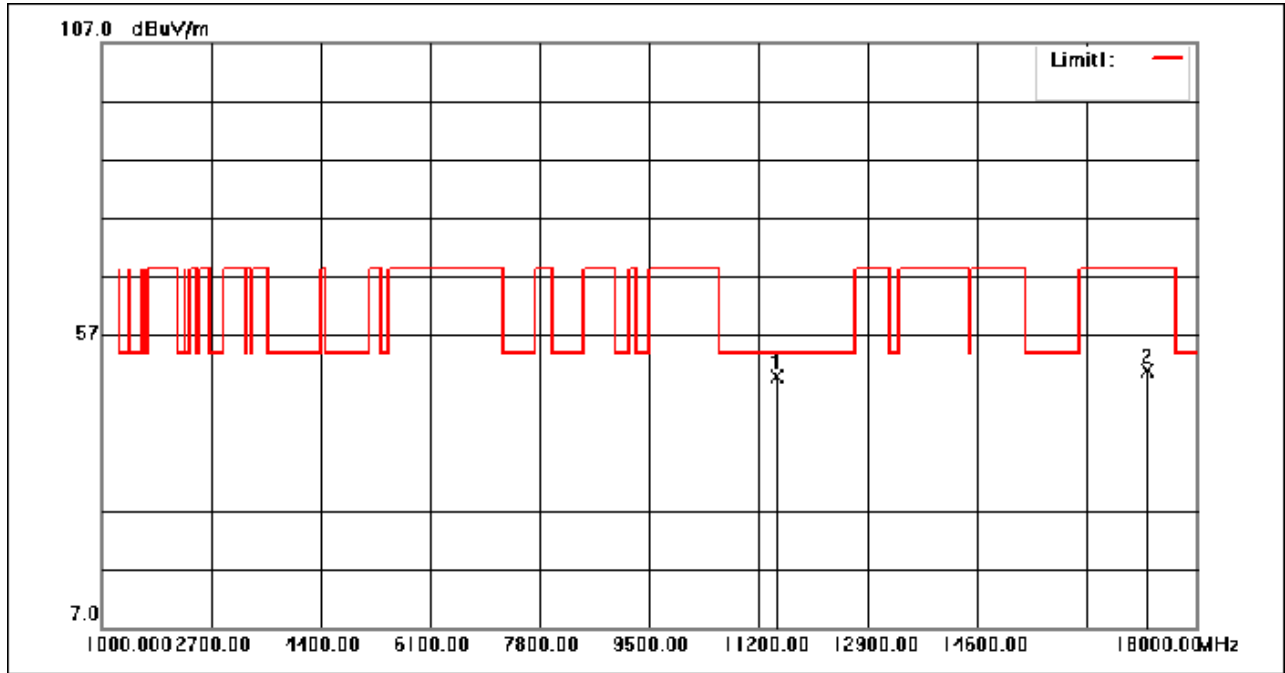

No.	Frequency (MHz)	Reading (dBuV)	Correction factor(dB/m)	Result (dBuV/m)	Limit (dBuV/m)	Margin (dB)	Remark
1	11490.000	48.93	0.94	49.87	54.00	-4.13	peak
2	17235.000	41.79	9.05	50.84	68.30	-17.46	peak



Unless otherwise agreed in writing, this document is issued by the Company subject to its General Conditions of Service printed overleaf, available on request or accessible at <http://www.sgs.com/en/Terms-and-Conditions.aspx> and, for electronic format documents, subject to Terms and Conditions for Electronic Documents at <http://www.sgs.com/en/Terms-and-Conditions/Terms-e-Documents.aspx>. Attention is drawn to the limitation of liability, indemnification and jurisdiction issues defined therein. Any holder of this document is advised that information contained hereon reflects the Company's findings at the time of its intervention only and within the limits of Client's instructions, if any. The Company's sole responsibility is to its Client and this document does not exonerate parties to a transaction from exercising all their rights and obligations under the transaction documents. This document cannot be reproduced except in full, without prior written approval of the Company. Any unauthorized alteration, forgery or falsification of the content or appearance of this document is unlawful and offenders may be prosecuted to the fullest extent of the law. Unless otherwise stated the results shown in this test report refer only to the sample(s) tested and such sample(s) are retained for 30 days only.  
**Attention: To check the authenticity of testing /inspection report & certificate, please contact us at telephone: (86-755) 8307 1443, or email: CN.Doccheck@sgs.com**

No.10, Weiye Road, Innovation Park, Kunshan, Jiangsu, China 215300  
 中国·江苏·昆山市留学生创业园伟业路10号 邮编 215300

t(86-512)57355888 f(86-512)57370818 www.sgsgroup.com.cn  
 t(86-512)57355888 f(86-512)57370818 sgs.china@sgs.com

Test Mode: 04; Polarity: Horizontal; Modulation:802.11n; Bandwidth:20MHz; Channel:middle

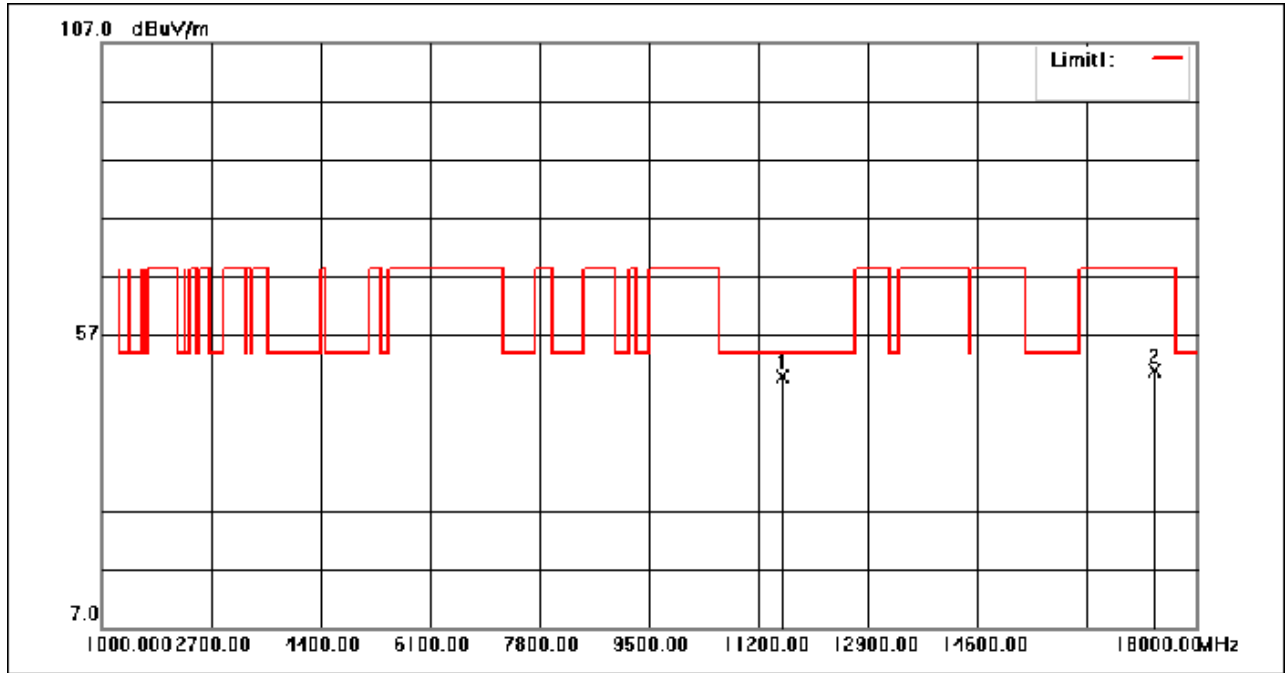

No.	Frequency (MHz)	Reading (dBuV)	Correction factor(dB/m)	Result (dBuV/m)	Limit (dBuV/m)	Margin (dB)	Remark
1	11570.000	48.78	1.18	49.96	54.00	-4.04	peak
2	17355.000	41.83	8.98	50.81	68.30	-17.49	peak



Unless otherwise agreed in writing, this document is issued by the Company subject to its General Conditions of Service printed overleaf, available on request or accessible at <http://www.sgs.com/en/Terms-and-Conditions.aspx> and, for electronic format documents, subject to Terms and Conditions for Electronic Documents at <http://www.sgs.com/en/Terms-and-Conditions/Terms-e-Documents.aspx>. Attention is drawn to the limitation of liability, indemnification and jurisdiction issues defined therein. Any holder of this document is advised that information contained hereon reflects the Company's findings at the time of its intervention only and within the limits of Client's instructions, if any. The Company's sole responsibility is to its Client and this document does not exonerate parties to a transaction from exercising all their rights and obligations under the transaction documents. This document cannot be reproduced except in full, without prior written approval of the Company. Any unauthorized alteration, forgery or falsification of the content or appearance of this document is unlawful and offenders may be prosecuted to the fullest extent of the law. Unless otherwise stated the results shown in this test report refer only to the sample(s) tested and such sample(s) are retained for 30 days only.  
**Attention: To check the authenticity of testing /inspection report & certificate, please contact us at telephone: (86-755) 8307 1443, or email: CN.Doccheck@sgs.com**

No.10, Weiye Road, Innovation Park, Kunshan, Jiangsu, China 215300  
 中国·江苏·昆山市留学生创业园伟业路10号 邮编 215300

t(86-512)57355888 f(86-512)57370818 www.sgsgroup.com.cn  
 t(86-512)57355888 f(86-512)57370818 sgs.china@sgs.com

Test Mode: 04; Polarity: Vertical; Modulation:802.11n; Bandwidth:20MHz; Channel:middle

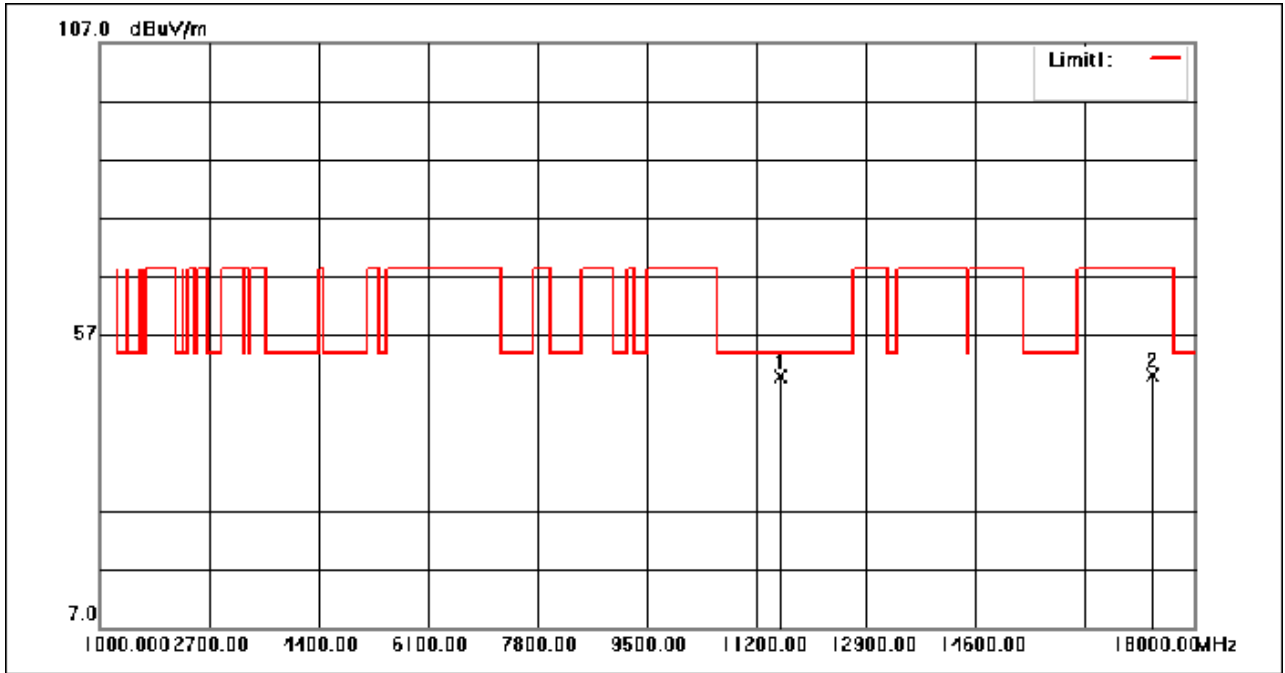

No.	Frequency (MHz)	Reading (dBuV)	Correction factor(dB/m)	Result (dBuV/m)	Limit (dBuV/m)	Margin (dB)	Remark
1	11570.000	48.74	1.18	49.92	54.00	-4.08	peak
2	17355.000	41.25	8.98	50.23	68.30	-18.07	peak



Unless otherwise agreed in writing, this document is issued by the Company subject to its General Conditions of Service printed overleaf, available on request or accessible at <http://www.sgs.com/en/Terms-and-Conditions.aspx> and, for electronic format documents, subject to Terms and Conditions for Electronic Documents at <http://www.sgs.com/en/Terms-and-Conditions/Terms-e-Documents.aspx>. Attention is drawn to the limitation of liability, indemnification and jurisdiction issues defined therein. Any holder of this document is advised that information contained hereon reflects the Company's findings at the time of its intervention only and within the limits of Client's instructions, if any. The Company's sole responsibility is to its Client and this document does not exonerate parties to a transaction from exercising all their rights and obligations under the transaction documents. This document cannot be reproduced except in full, without prior written approval of the Company. Any unauthorized alteration, forgery or falsification of the content or appearance of this document is unlawful and offenders may be prosecuted to the fullest extent of the law. Unless otherwise stated the results shown in this test report refer only to the sample(s) tested and such sample(s) are retained for 30 days only.  
**Attention: To check the authenticity of testing /inspection report & certificate, please contact us at telephone: (86-755) 8307 1443, or email: CN.Doccheck@sgs.com**

No.10, Weiye Road, Innovation Park, Kunshan, Jiangsu, China 215300  
 中国·江苏·昆山市留学生创业园伟业路10号 邮编 215300

t(86-512)57355888 f(86-512)57370818 www.sgsgroup.com.cn  
 t(86-512)57355888 f(86-512)57370818 sgs.china@sgs.com

Test Mode: 04; Polarity: Horizontal; Modulation:802.11n; Bandwidth:20MHz; Channel:High

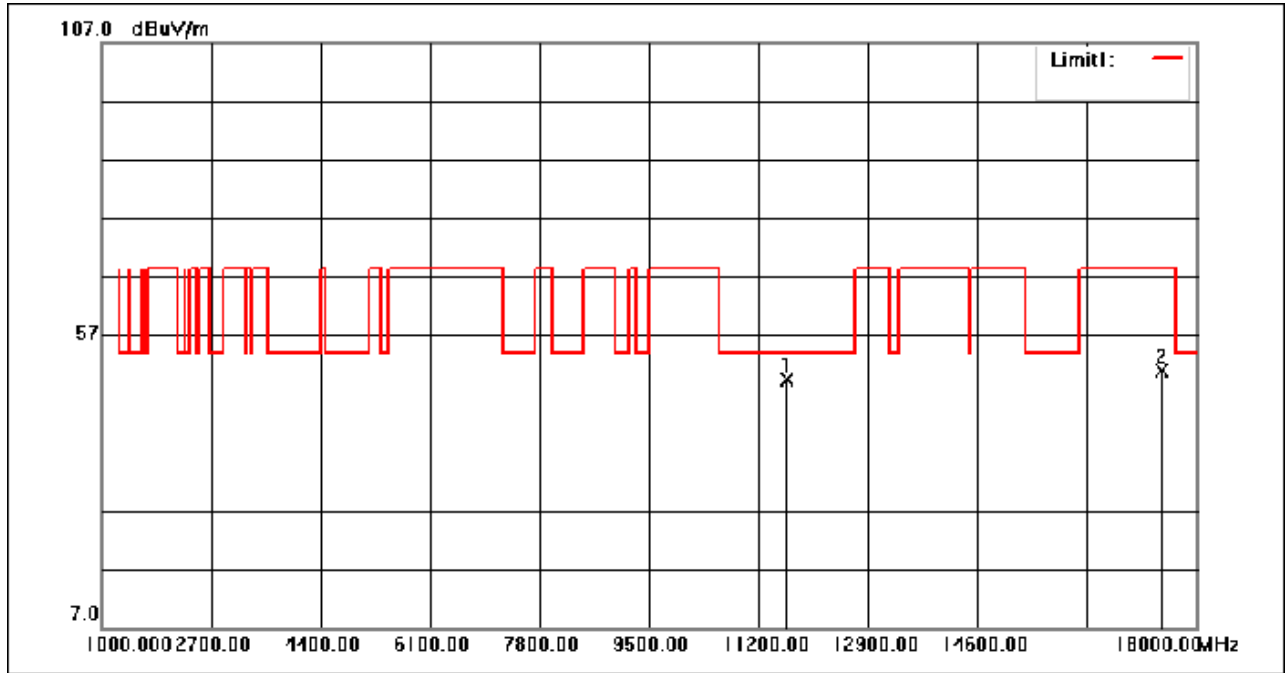

No.	Frequency (MHz)	Reading (dBuV)	Correction factor(dB/m)	Result (dBuV/m)	Limit (dBuV/m)	Margin (dB)	Remark
1	11650.000	47.96	1.45	49.41	54.00	-4.59	peak
2	17475.000	41.94	8.90	50.84	68.30	-17.46	peak



Unless otherwise agreed in writing, this document is issued by the Company subject to its General Conditions of Service printed overleaf, available on request or accessible at <http://www.sgs.com/en/Terms-and-Conditions.aspx> and, for electronic format documents, subject to Terms and Conditions for Electronic Documents at <http://www.sgs.com/en/Terms-and-Conditions/Terms-e-Documents.aspx>. Attention is drawn to the limitation of liability, indemnification and jurisdiction issues defined therein. Any holder of this document is advised that information contained hereon reflects the Company's findings at the time of its intervention only and within the limits of Client's instructions, if any. The Company's sole responsibility is to its Client and this document does not exonerate parties to a transaction from exercising all their rights and obligations under the transaction documents. This document cannot be reproduced except in full, without prior written approval of the Company. Any unauthorized alteration, forgery or falsification of the content or appearance of this document is unlawful and offenders may be prosecuted to the fullest extent of the law. Unless otherwise stated the results shown in this test report refer only to the sample(s) tested and such sample(s) are retained for 30 days only.  
**Attention: To check the authenticity of testing /inspection report & certificate, please contact us at telephone: (86-755) 8307 1443, or email: CN\_Doccheck@sgs.com**

No.10, Weiye Road, Innovation Park, Kunshan, Jiangsu, China 215300  
 中国·江苏·昆山市留学生创业园伟业路10号 邮编 215300

t(86-512)57355888 f(86-512)57370818 www.sgsgroup.com.cn  
 t(86-512)57355888 f(86-512)57370818 sgs.china@sgs.com

Test Mode: 04; Polarity: Vertical; Modulation:802.11n; Bandwidth:20MHz; Channel:High

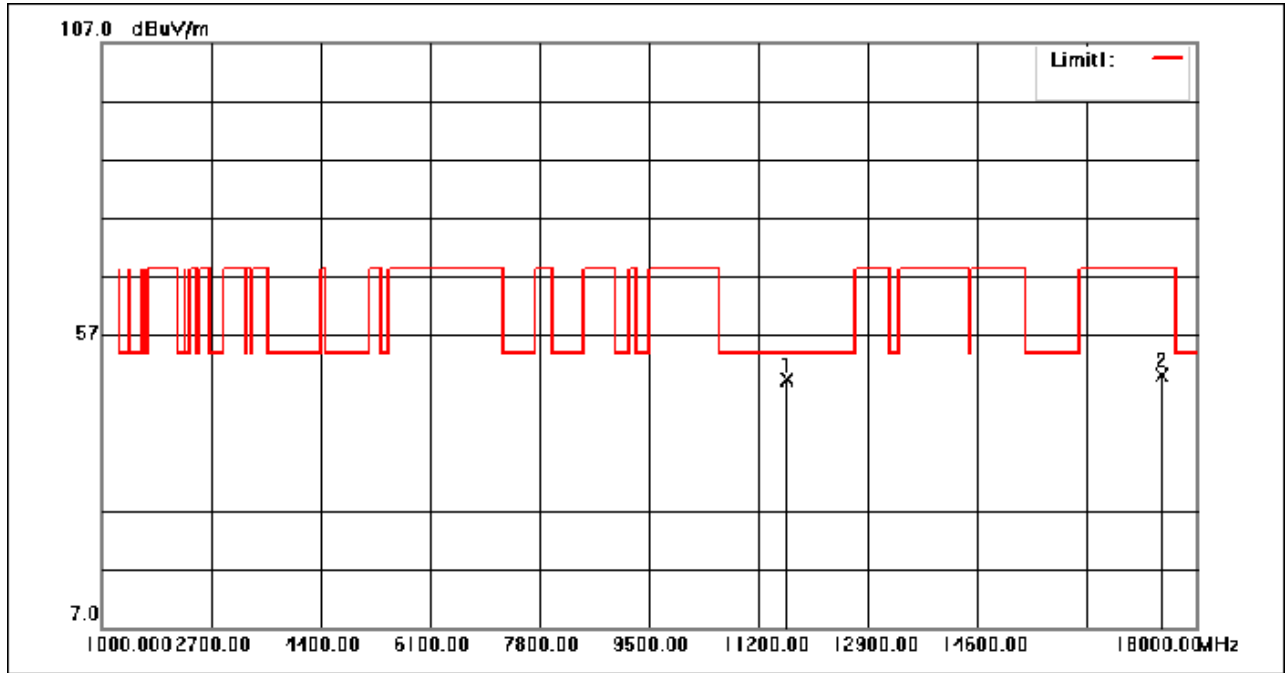

No.	Frequency (MHz)	Reading (dBuV)	Correction factor(dB/m)	Result (dBuV/m)	Limit (dBuV/m)	Margin (dB)	Remark
1	11650.000	48.01	1.45	49.46	54.00	-4.54	peak
2	17475.000	41.13	8.90	50.03	68.30	-18.27	peak



Unless otherwise agreed in writing, this document is issued by the Company subject to its General Conditions of Service printed overleaf, available on request or accessible at <http://www.sgs.com/en/Terms-and-Conditions.aspx> and, for electronic format documents, subject to Terms and Conditions for Electronic Documents at <http://www.sgs.com/en/Terms-and-Conditions/Terms-e-Documents.aspx>. Attention is drawn to the limitation of liability, indemnification and jurisdiction issues defined therein. Any holder of this document is advised that information contained hereon reflects the Company's findings at the time of its intervention only and within the limits of Client's instructions, if any. The Company's sole responsibility is to its Client and this document does not exonerate parties to a transaction from exercising all their rights and obligations under the transaction documents. This document cannot be reproduced except in full, without prior written approval of the Company. Any unauthorized alteration, forgery or falsification of the content or appearance of this document is unlawful and offenders may be prosecuted to the fullest extent of the law. Unless otherwise stated the results shown in this test report refer only to the sample(s) tested and such sample(s) are retained for 30 days only.  
**Attention: To check the authenticity of testing /inspection report & certificate, please contact us at telephone: (86-755) 8307 1443, or email: CN.Doccheck@sgs.com**

No.10, Weiye Road, Innovation Park, Kunshan, Jiangsu, China 215300  
 中国·江苏·昆山市留学生创业园伟业路10号 邮编 215300

t(86-512)57355888 f(86-512)57370818 www.sgsgroup.com.cn  
 t(86-512)57355888 f(86-512)57370818 sgs.china@sgs.com



Test Mode: 04; Polarity: Horizontal; Modulation:802.11n; Bandwidth:40MHz; Channel:Low

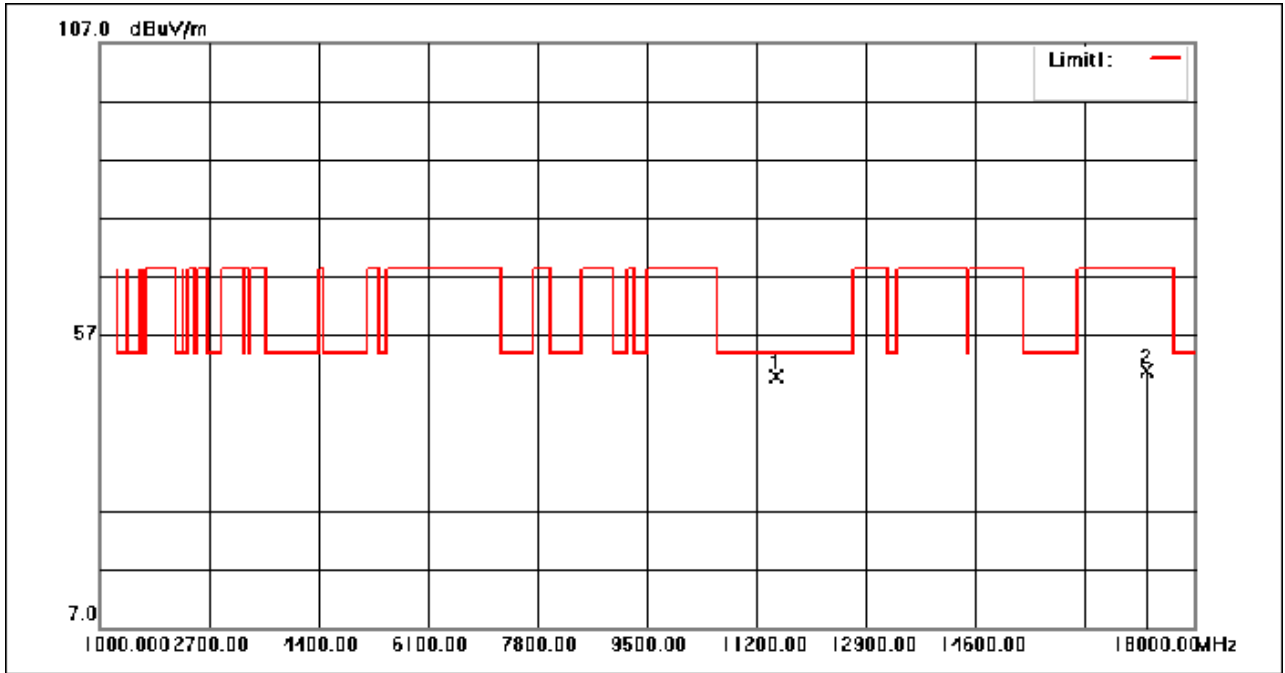

No.	Frequency (MHz)	Reading (dBuV)	Correction factor(dB/m)	Result (dBuV/m)	Limit (dBuV/m)	Margin (dB)	Remark
1	11510.000	48.82	0.99	49.81	54.00	-4.19	peak
2	17265.000	41.90	9.03	50.93	68.30	-17.37	peak



Unless otherwise agreed in writing, this document is issued by the Company subject to its General Conditions of Service printed overleaf, available on request or accessible at <http://www.sgs.com/en/Terms-and-Conditions.aspx> and, for electronic format documents, subject to Terms and Conditions for Electronic Documents at <http://www.sgs.com/en/Terms-and-Conditions/Terms-e-Documents.aspx>. Attention is drawn to the limitation of liability, indemnification and jurisdiction issues defined therein. Any holder of this document is advised that information contained hereon reflects the Company's findings at the time of its intervention only and within the limits of Client's instructions, if any. The Company's sole responsibility is to its Client and this document does not exonerate parties to a transaction from exercising all their rights and obligations under the transaction documents. This document cannot be reproduced except in full, without prior written approval of the Company. Any unauthorized alteration, forgery or falsification of the content or appearance of this document is unlawful and offenders may be prosecuted to the fullest extent of the law. Unless otherwise stated the results shown in this test report refer only to the sample(s) tested and such sample(s) are retained for 30 days only.  
**Attention: To check the authenticity of testing /inspection report & certificate, please contact us at telephone: (86-755) 8307 1443, or email: CN.Doccheck@sgs.com**

No.10, Weiye Road, Innovation Park, Kunshan, Jiangsu, China 215300  
中国·江苏·昆山市留学生创业园伟业路10号 邮编 215300

t(86-512)57355888 f(86-512)57370818 www.sgsgroup.com.cn  
t(86-512)57355888 f(86-512)57370818 sgs.china@sgs.com

Test Mode: 04; Polarity: Vertical; Modulation:802.11n; Bandwidth:40MHz; Channel:Low

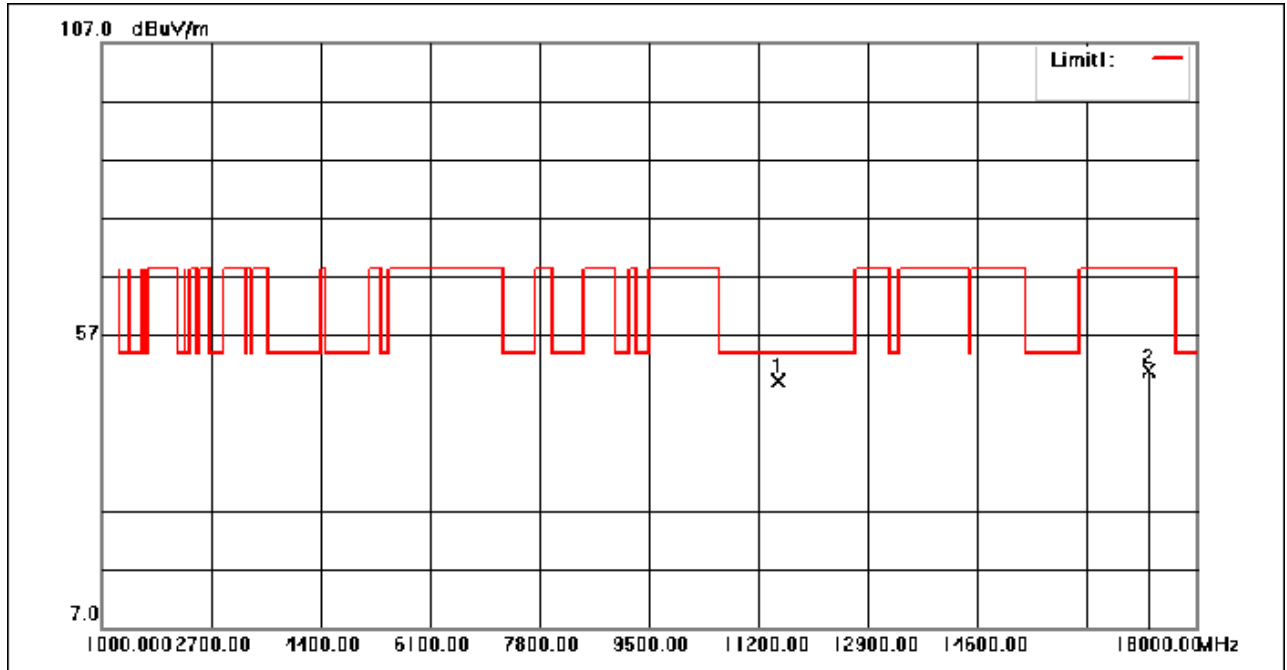

No.	Frequency (MHz)	Reading (dBuV)	Correction factor(dB/m)	Result (dBuV/m)	Limit (dBuV/m)	Margin (dB)	Remark
1	11510.000	48.12	0.99	49.11	54.00	-4.89	peak
2	17265.000	41.84	9.03	50.87	68.30	-17.43	peak



Unless otherwise agreed in writing, this document is issued by the Company subject to its General Conditions of Service printed overleaf, available on request or accessible at <http://www.sgs.com/en/Terms-and-Conditions.aspx> and, for electronic format documents, subject to Terms and Conditions for Electronic Documents at <http://www.sgs.com/en/Terms-and-Conditions/Terms-e-Documents.aspx>. Attention is drawn to the limitation of liability, indemnification and jurisdiction issues defined therein. Any holder of this document is advised that information contained hereon reflects the Company's findings at the time of its intervention only and within the limits of Client's instructions, if any. The Company's sole responsibility is to its Client and this document does not exonerate parties to a transaction from exercising all their rights and obligations under the transaction documents. This document cannot be reproduced except in full, without prior written approval of the Company. Any unauthorized alteration, forgery or falsification of the content or appearance of this document is unlawful and offenders may be prosecuted to the fullest extent of the law. Unless otherwise stated the results shown in this test report refer only to the sample(s) tested and such sample(s) are retained for 30 days only.  
**Attention: To check the authenticity of testing /inspection report & certificate, please contact us at telephone: (86-755) 8307 1443, or email: CN\_Doccheck@sgs.com**

No.10, Weiye Road, Innovation Park, Kunshan, Jiangsu, China 215300  
 中国·江苏·昆山市留学生创业园伟业路10号 邮编 215300

t(86-512)57355888 f(86-512)57370818 www.sgsgroup.com.cn  
 t(86-512)57355888 f(86-512)57370818 sgs.china@sgs.com

Test Mode: 04; Polarity: Horizontal; Modulation:802.11n; Bandwidth:40MHz; Channel:High

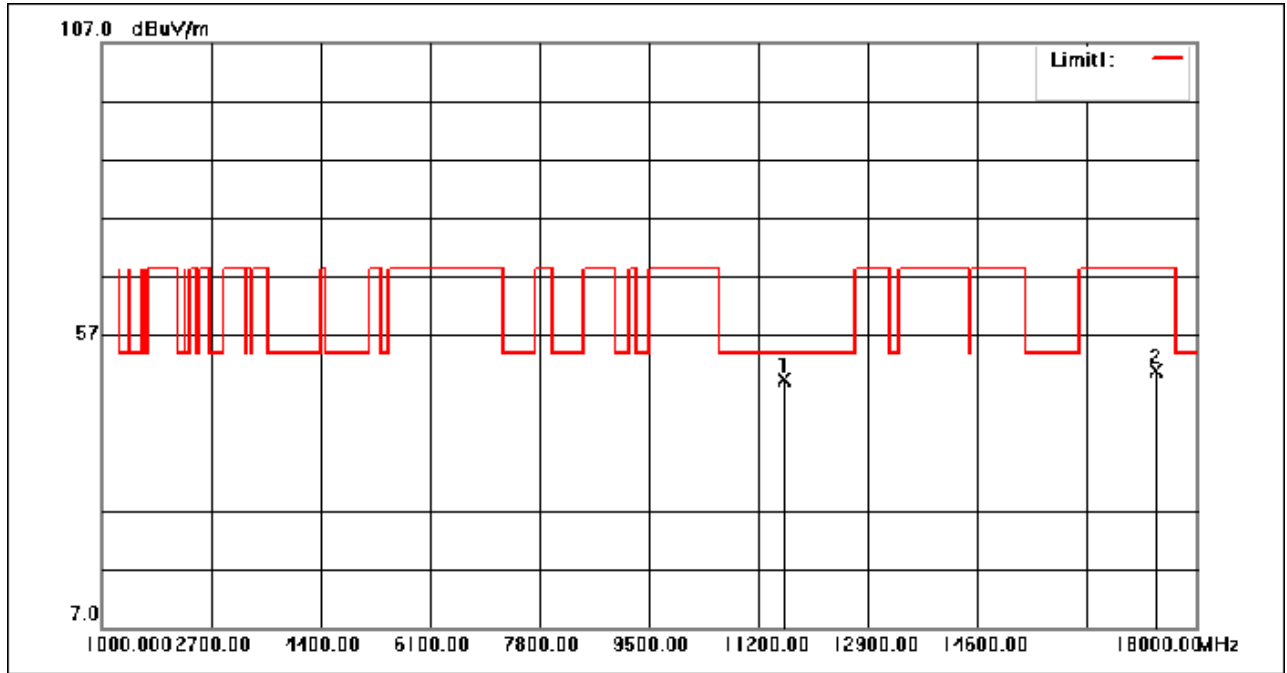

No.	Frequency (MHz)	Reading (dBuV)	Correction factor(dB/m)	Result (dBuV/m)	Limit (dBuV/m)	Margin (dB)	Remark
1	11590.000	48.16	1.25	49.41	54.00	-4.59	peak
2	17385.000	41.88	8.96	50.84	68.30	-17.46	peak



Unless otherwise agreed in writing, this document is issued by the Company subject to its General Conditions of Service printed overleaf, available on request or accessible at <http://www.sgs.com/en/Terms-and-Conditions.aspx> and, for electronic format documents, subject to Terms and Conditions for Electronic Documents at <http://www.sgs.com/en/Terms-and-Conditions/Terms-e-Documents.aspx>. Attention is drawn to the limitation of liability, indemnification and jurisdiction issues defined therein. Any holder of this document is advised that information contained hereon reflects the Company's findings at the time of its intervention only and within the limits of Client's instructions, if any. The Company's sole responsibility is to its Client and this document does not exonerate parties to a transaction from exercising all their rights and obligations under the transaction documents. This document cannot be reproduced except in full, without prior written approval of the Company. Any unauthorized alteration, forgery or falsification of the content or appearance of this document is unlawful and offenders may be prosecuted to the fullest extent of the law. Unless otherwise stated the results shown in this test report refer only to the sample(s) tested and such sample(s) are retained for 30 days only.  
Attention: To check the authenticity of testing /inspection report & certificate, please contact us at telephone: (86-755) 8307 1443, or email: [CN.Doccheck@sgs.com](mailto:CN.Doccheck@sgs.com)

No.10, Weiye Road, Innovation Park, Kunshan, Jiangsu, China 215300  
中国·江苏·昆山市留学生创业园伟业路10号 邮编 215300

t(86-512)57355888 f(86-512)57370818 www.sgsgroup.com.cn  
t(86-512)57355888 f(86-512)57370818 sgs.china@sgs.com

Test Mode: 04; Polarity: Vertical; Modulation:802.11n; Bandwidth:40MHz; Channel:High

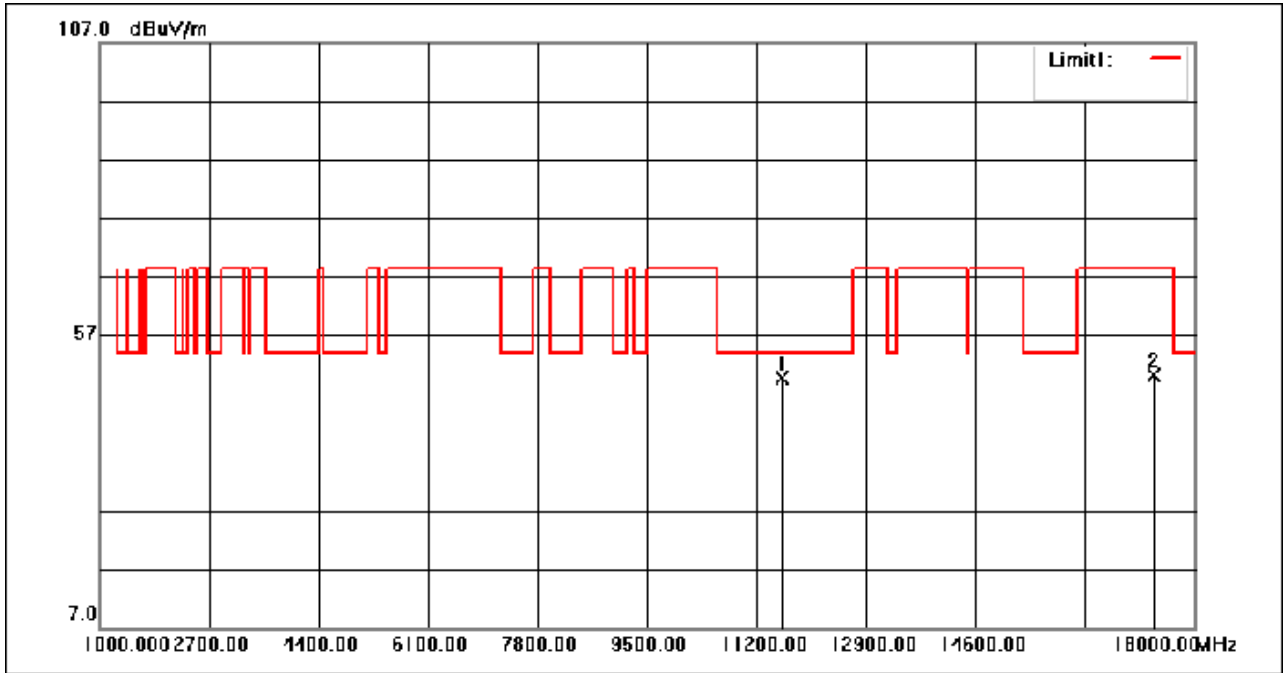

No.	Frequency (MHz)	Reading (dBuV)	Correction factor(dB/m)	Result (dBuV/m)	Limit (dBuV/m)	Margin (dB)	Remark
1	11590.000	48.45	1.25	49.70	54.00	-4.30	peak
2	17385.000	41.21	8.96	50.17	68.30	-18.13	peak



Unless otherwise agreed in writing, this document is issued by the Company subject to its General Conditions of Service printed overleaf, available on request or accessible at <http://www.sgs.com/en/Terms-and-Conditions.aspx> and, for electronic format documents, subject to Terms and Conditions for Electronic Documents at <http://www.sgs.com/en/Terms-and-Conditions/Terms-e-Documents.aspx>. Attention is drawn to the limitation of liability, indemnification and jurisdiction issues defined therein. Any holder of this document is advised that information contained hereon reflects the Company's findings at the time of its intervention only and within the limits of Client's instructions, if any. The Company's sole responsibility is to its Client and this document does not exonerate parties to a transaction from exercising all their rights and obligations under the transaction documents. This document cannot be reproduced except in full, without prior written approval of the Company. Any unauthorized alteration, forgery or falsification of the content or appearance of this document is unlawful and offenders may be prosecuted to the fullest extent of the law. Unless otherwise stated the results shown in this test report refer only to the sample(s) tested and such sample(s) are retained for 30 days only.  
**Attention: To check the authenticity of testing /inspection report & certificate, please contact us at telephone: (86-755) 8307 1443, or email: CN.Doccheck@sgs.com**

No.10, Weiye Road, Innovation Park, Kunshan, Jiangsu, China 215300  
 中国·江苏·昆山市留学生创业园伟业路10号 邮编 215300

t(86-512)57355888 f(86-512)57370818 www.sgsgroup.com.cn  
 t(86-512)57355888 f(86-512)57370818 sgs.china@sgs.com

Test Mode: 04; Polarity: Horizontal; Modulation:802.11ac; Bandwidth:20MHz; Channel:Low

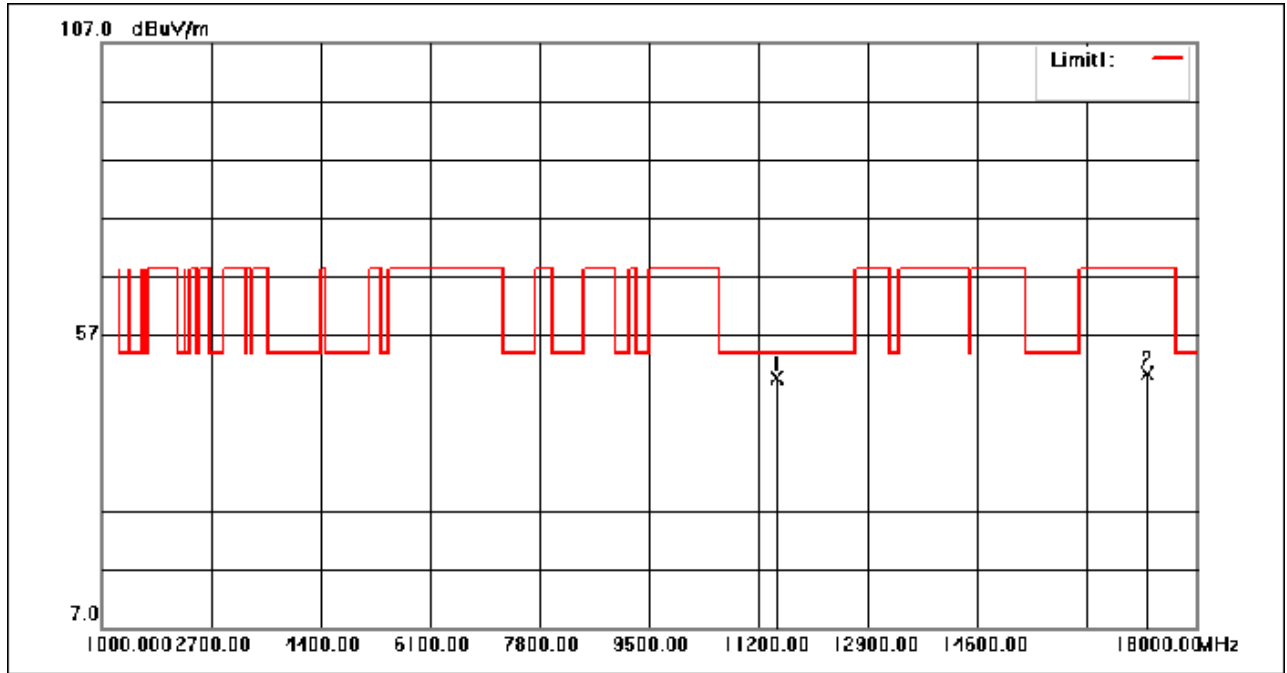

No.	Frequency (MHz)	Reading (dBuV)	Correction factor(dB/m)	Result (dBuV/m)	Limit (dBuV/m)	Margin (dB)	Remark
1	11490.000	48.62	0.94	49.56	54.00	-4.44	peak
2	17235.000	41.30	9.05	50.35	68.30	-17.95	peak



Unless otherwise agreed in writing, this document is issued by the Company subject to its General Conditions of Service printed overleaf, available on request or accessible at <http://www.sgs.com/en/Terms-and-Conditions.aspx> and, for electronic format documents, subject to Terms and Conditions for Electronic Documents at <http://www.sgs.com/en/Terms-and-Conditions/Terms-e-Documents.aspx>. Attention is drawn to the limitation of liability, indemnification and jurisdiction issues defined therein. Any holder of this document is advised that information contained hereon reflects the Company's findings at the time of its intervention only and within the limits of Client's instructions, if any. The Company's sole responsibility is to its Client and this document does not exonerate parties to a transaction from exercising all their rights and obligations under the transaction documents. This document cannot be reproduced except in full, without prior written approval of the Company. Any unauthorized alteration, forgery or falsification of the content or appearance of this document is unlawful and offenders may be prosecuted to the fullest extent of the law. Unless otherwise stated the results shown in this test report refer only to the sample(s) tested and such sample(s) are retained for 30 days only.  
**Attention: To check the authenticity of testing /inspection report & certificate, please contact us at telephone: (86-755) 8307 1443, or email: CN.Doccheck@sgs.com**

No.10, Weiye Road, Innovation Park, Kunshan, Jiangsu, China 215300  
 中国·江苏·昆山市留学生创业园伟业路10号 邮编 215300

t(86-512)57355888 f(86-512)57370818 www.sgsgroup.com.cn  
 t(86-512)57355888 f(86-512)57370818 sgs.china@sgs.com



Test Mode: 04; Polarity: Vertical; Modulation:802.11ac; Bandwidth:20MHz; Channel:Low

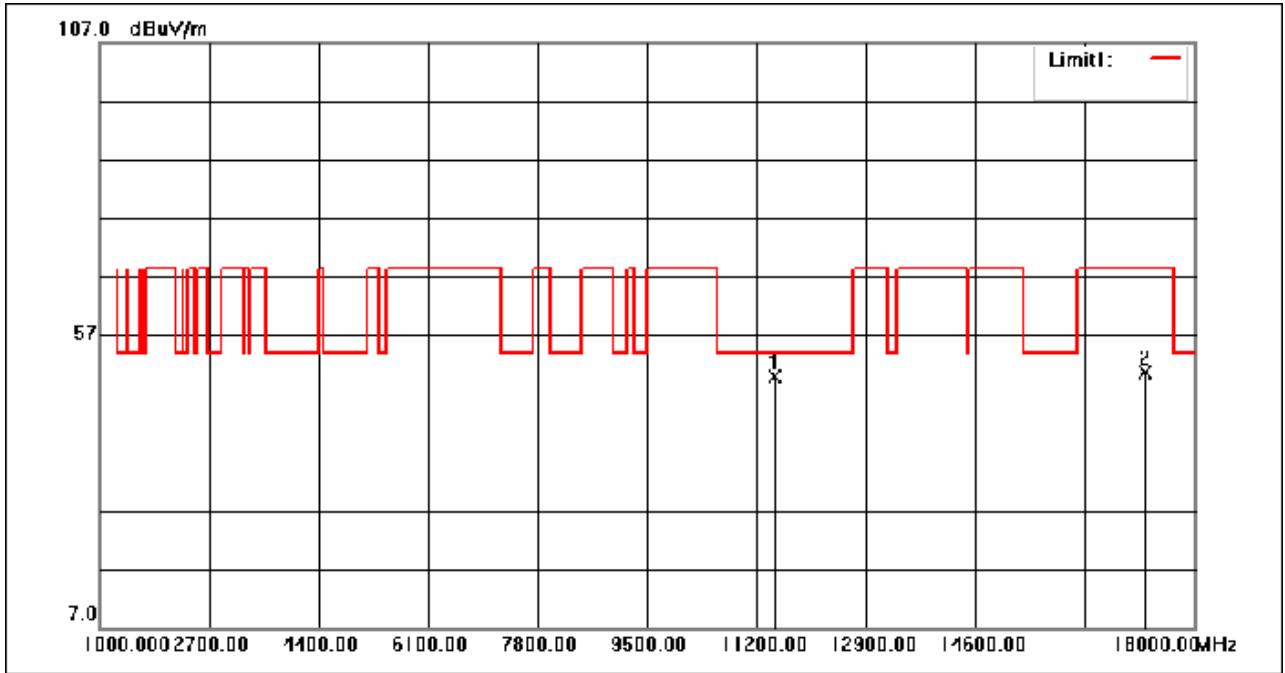

No.	Frequency (MHz)	Reading (dBuV)	Correction factor(dB/m)	Result (dBuV/m)	Limit (dBuV/m)	Margin (dB)	Remark
1	11490.000	48.99	0.94	49.93	54.00	-4.07	peak
2	17235.000	41.66	9.05	50.71	68.30	-17.59	peak



Unless otherwise agreed in writing, this document is issued by the Company subject to its General Conditions of Service printed overleaf, available on request or accessible at <http://www.sgs.com/en/Terms-and-Conditions.aspx> and, for electronic format documents, subject to Terms and Conditions for Electronic Documents at <http://www.sgs.com/en/Terms-and-Conditions/Terms-e-Documents.aspx>. Attention is drawn to the limitation of liability, indemnification and jurisdiction issues defined therein. Any holder of this document is advised that information contained hereon reflects the Company's findings at the time of its intervention only and within the limits of Client's instructions, if any. The Company's sole responsibility is to its Client and this document does not exonerate parties to a transaction from exercising all their rights and obligations under the transaction documents. This document cannot be reproduced except in full, without prior written approval of the Company. Any unauthorized alteration, forgery or falsification of the content or appearance of this document is unlawful and offenders may be prosecuted to the fullest extent of the law. Unless otherwise stated the results shown in this test report refer only to the sample(s) tested and such sample(s) are retained for 30 days only.  
**Attention: To check the authenticity of testing /inspection report & certificate, please contact us at telephone: (86-755) 8307 1443, or email: CN.Doccheck@sgs.com**

No.10, Weiye Road, Innovation Park, Kunshan, Jiangsu, China 215300  
 中国·江苏·昆山市留学生创业园伟业路10号 邮编 215300

t(86-512)57355888 f(86-512)57370818 www.sgsgroup.com.cn  
 t(86-512)57355888 f(86-512)57370818 sgs.china@sgs.com

Test Mode: 04; Polarity: Horizontal; Modulation:802.11ac; Bandwidth:20MHz; Channel:middle

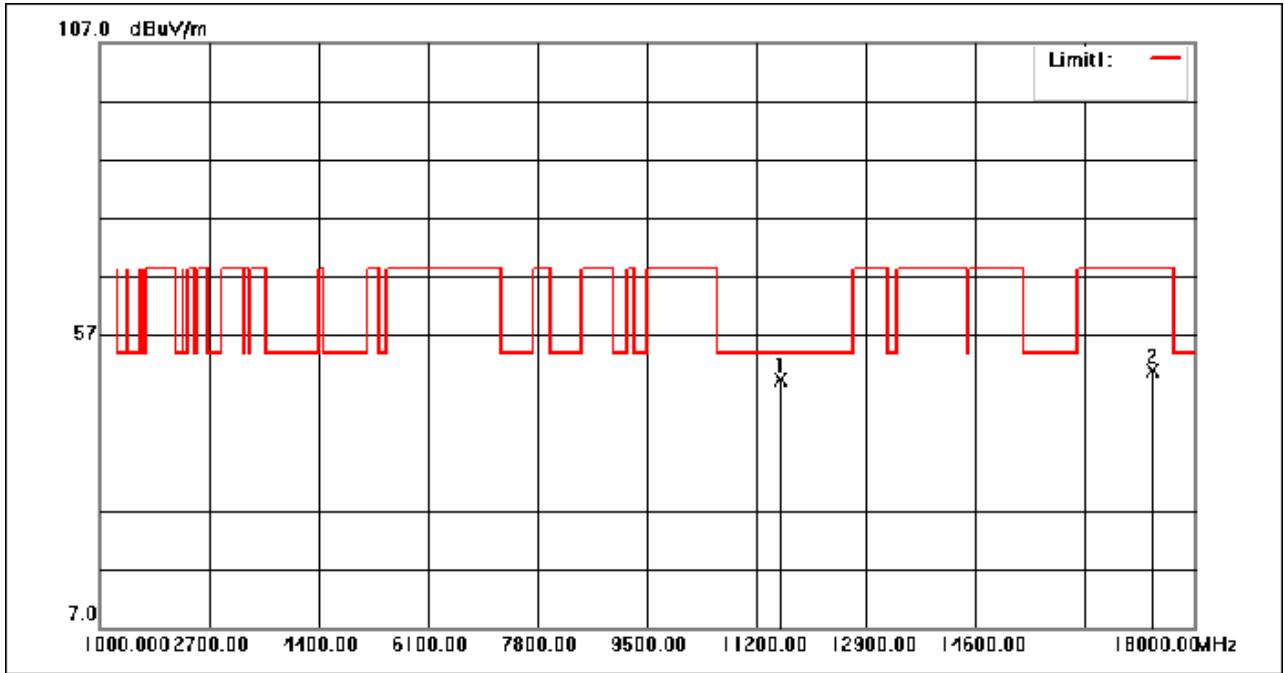

No.	Frequency (MHz)	Reading (dBuV)	Correction factor(dB/m)	Result (dBuV/m)	Limit (dBuV/m)	Margin (dB)	Remark
1	11570.000	48.23	1.18	49.41	54.00	-4.59	peak
2	17355.000	41.93	8.98	50.91	68.30	-17.39	peak



Unless otherwise agreed in writing, this document is issued by the Company subject to its General Conditions of Service printed overleaf, available on request or accessible at <http://www.sgs.com/en/Terms-and-Conditions.aspx> and, for electronic format documents, subject to Terms and Conditions for Electronic Documents at <http://www.sgs.com/en/Terms-and-Conditions/Terms-e-Documents.aspx>. Attention is drawn to the limitation of liability, indemnification and jurisdiction issues defined therein. Any holder of this document is advised that information contained hereon reflects the Company's findings at the time of its intervention only and within the limits of Client's instructions, if any. The Company's sole responsibility is to its Client and this document does not exonerate parties to a transaction from exercising all their rights and obligations under the transaction documents. This document cannot be reproduced except in full, without prior written approval of the Company. Any unauthorized alteration, forgery or falsification of the content or appearance of this document is unlawful and offenders may be prosecuted to the fullest extent of the law. Unless otherwise stated the results shown in this test report refer only to the sample(s) tested and such sample(s) are retained for 30 days only.  
**Attention: To check the authenticity of testing /inspection report & certificate, please contact us at telephone: (86-755) 8307 1443, or email: CN.Doccheck@sgs.com**

No.10, Weiye Road, Innovation Park, Kunshan, Jiangsu, China 215300  
 中国·江苏·昆山市留学生创业园伟业路10号 邮编 215300

t(86-512)57355888 f(86-512)57370818 www.sgsgroup.com.cn  
 t(86-512)57355888 f(86-512)57370818 sgs.china@sgs.com

Test Mode: 04; Polarity: Vertical; Modulation:802.11 ac; Bandwidth:20MHz; Channel:middle

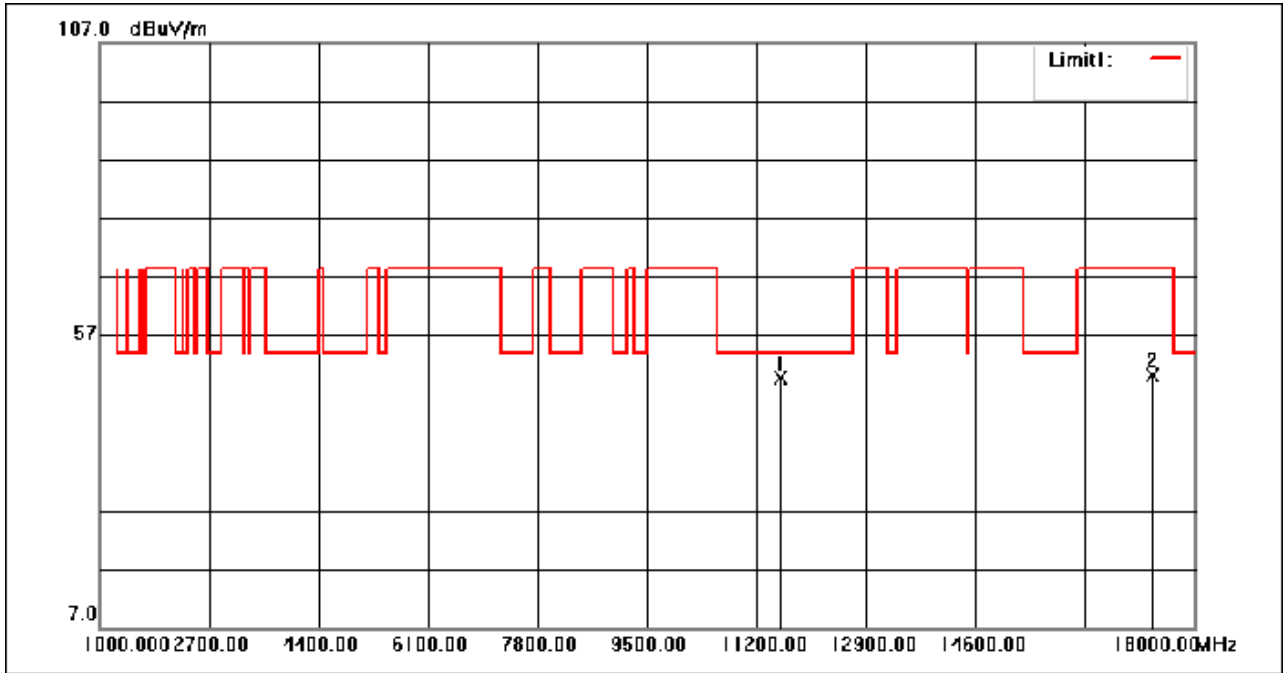

No.	Frequency (MHz)	Reading (dBuV)	Correction factor(dB/m)	Result (dBuV/m)	Limit (dBuV/m)	Margin (dB)	Remark
1	11570.000	48.49	1.18	49.67	54.00	-4.33	peak
2	17355.000	41.27	8.98	50.25	68.30	-18.05	peak



Unless otherwise agreed in writing, this document is issued by the Company subject to its General Conditions of Service printed overleaf, available on request or accessible at <http://www.sgs.com/en/Terms-and-Conditions.aspx> and, for electronic format documents, subject to Terms and Conditions for Electronic Documents at <http://www.sgs.com/en/Terms-and-Conditions/Terms-e-Documents.aspx>. Attention is drawn to the limitation of liability, indemnification and jurisdiction issues defined therein. Any holder of this document is advised that information contained hereon reflects the Company's findings at the time of its intervention only and within the limits of Client's instructions, if any. The Company's sole responsibility is to its Client and this document does not exonerate parties to a transaction from exercising all their rights and obligations under the transaction documents. This document cannot be reproduced except in full, without prior written approval of the Company. Any unauthorized alteration, forgery or falsification of the content or appearance of this document is unlawful and offenders may be prosecuted to the fullest extent of the law. Unless otherwise stated the results shown in this test report refer only to the sample(s) tested and such sample(s) are retained for 30 days only.  
**Attention: To check the authenticity of testing /inspection report & certificate, please contact us at telephone: (86-755) 8307 1443, or email: CN.Doccheck@sgs.com**

No.10, Weiye Road, Innovation Park, Kunshan, Jiangsu, China 215300  
 中国·江苏·昆山市留学生创业园伟业路10号 邮编 215300

t(86-512)57355888 f(86-512)57370818 www.sgsgroup.com.cn  
 t(86-512)57355888 f(86-512)57370818 sgs.china@sgs.com

Test Mode: 04; Polarity: Horizontal; Modulation:802.11ac; Bandwidth:20MHz; Channel:High

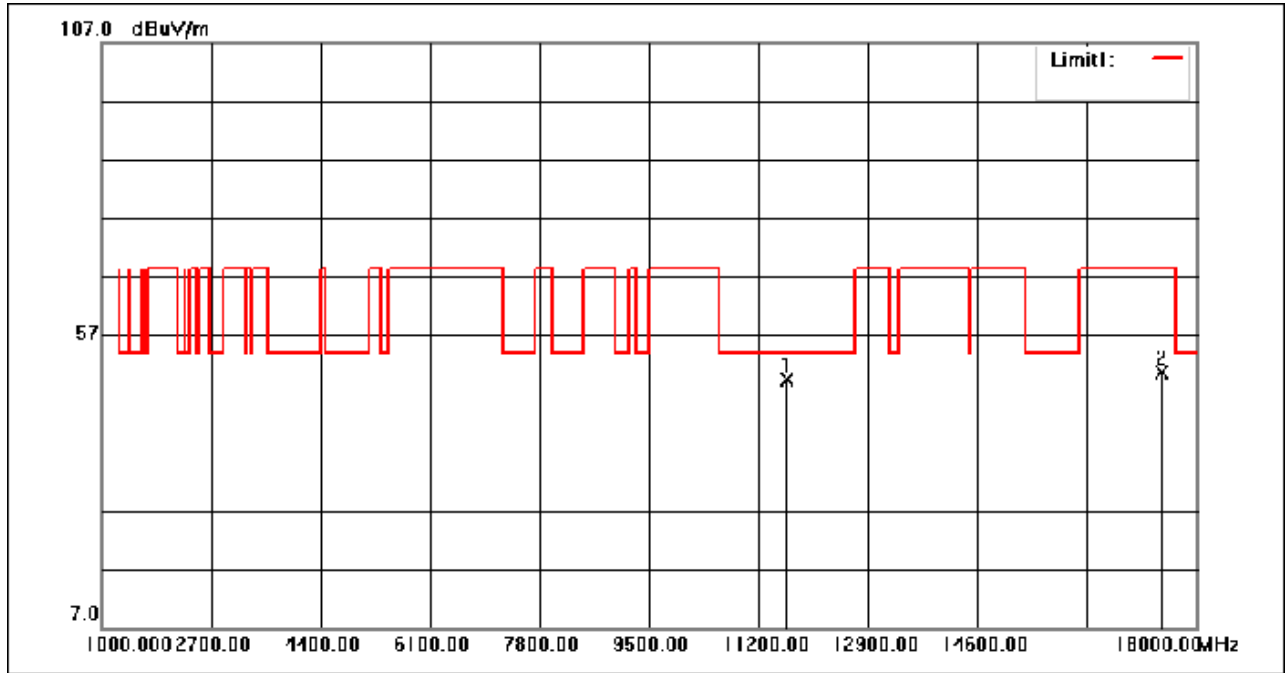

No.	Frequency (MHz)	Reading (dBuV)	Correction factor(dB/m)	Result (dBuV/m)	Limit (dBuV/m)	Margin (dB)	Remark
1	11650.000	47.85	1.45	49.30	54.00	-4.70	peak
2	17475.000	41.69	8.90	50.59	68.30	-17.71	peak



Unless otherwise agreed in writing, this document is issued by the Company subject to its General Conditions of Service printed overleaf, available on request or accessible at <http://www.sgs.com/en/Terms-and-Conditions.aspx> and, for electronic format documents, subject to Terms and Conditions for Electronic Documents at <http://www.sgs.com/en/Terms-and-Conditions/Terms-e-Documents.aspx>. Attention is drawn to the limitation of liability, indemnification and jurisdiction issues defined therein. Any holder of this document is advised that information contained hereon reflects the Company's findings at the time of its intervention only and within the limits of Client's instructions, if any. The Company's sole responsibility is to its Client and this document does not exonerate parties to a transaction from exercising all their rights and obligations under the transaction documents. This document cannot be reproduced except in full, without prior written approval of the Company. Any unauthorized alteration, forgery or falsification of the content or appearance of this document is unlawful and offenders may be prosecuted to the fullest extent of the law. Unless otherwise stated the results shown in this test report refer only to the sample(s) tested and such sample(s) are retained for 30 days only.  
**Attention: To check the authenticity of testing /inspection report & certificate, please contact us at telephone: (86-755) 8307 1443, or email: CN.Doccheck@sgs.com**

No.10, Weiye Road, Innovation Park, Kunshan, Jiangsu, China 215300  
 中国·江苏·昆山市留学生创业园伟业路10号 邮编 215300

t(86-512)57355888 f(86-512)57370818 www.sgsgroup.com.cn  
 t(86-512)57355888 f(86-512)57370818 sgs.china@sgs.com

Test Mode: 04; Polarity: Vertical; Modulation:802.11ac; Bandwidth:20MHz; Channel:High

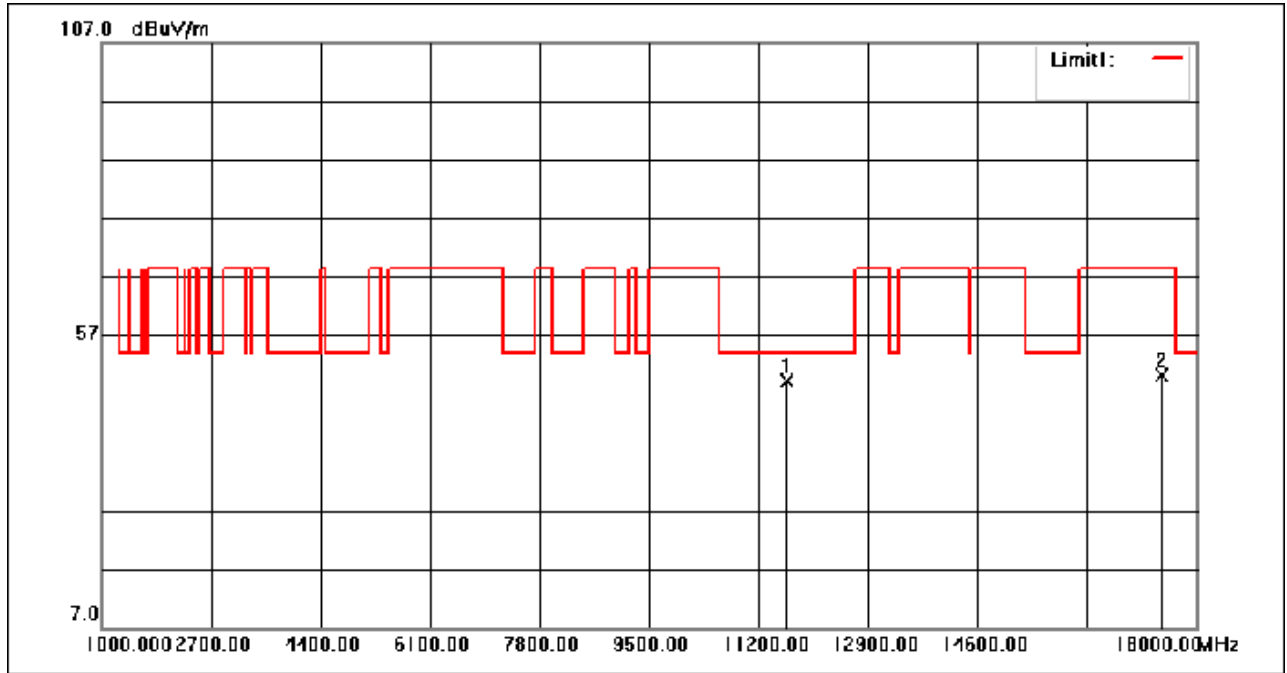

No.	Frequency (MHz)	Reading (dBuV)	Correction factor(dB/m)	Result (dBuV/m)	Limit (dBuV/m)	Margin (dB)	Remark
1	11650.000	47.68	1.45	49.13	54.00	-4.87	peak
2	17475.000	41.31	8.90	50.21	68.30	-18.09	peak



Unless otherwise agreed in writing, this document is issued by the Company subject to its General Conditions of Service printed overleaf, available on request or accessible at <http://www.sgs.com/en/Terms-and-Conditions.aspx> and, for electronic format documents, subject to Terms and Conditions for Electronic Documents at <http://www.sgs.com/en/Terms-and-Conditions/Terms-e-Documents.aspx>. Attention is drawn to the limitation of liability, indemnification and jurisdiction issues defined therein. Any holder of this document is advised that information contained hereon reflects the Company's findings at the time of its intervention only and within the limits of Client's instructions, if any. The Company's sole responsibility is to its Client and this document does not exonerate parties to a transaction from exercising all their rights and obligations under the transaction documents. This document cannot be reproduced except in full, without prior written approval of the Company. Any unauthorized alteration, forgery or falsification of the content or appearance of this document is unlawful and offenders may be prosecuted to the fullest extent of the law. Unless otherwise stated the results shown in this test report refer only to the sample(s) tested and such sample(s) are retained for 30 days only.  
**Attention: To check the authenticity of testing /inspection report & certificate, please contact us at telephone: (86-755) 8307 1443, or email: CN.Doccheck@sgs.com**

No.10, Weiye Road, Innovation Park, Kunshan, Jiangsu, China 215300  
 中国·江苏·昆山市留学生创业园伟业路10号 邮编 215300

t(86-512)57355888 f(86-512)57370818 www.sgsgroup.com.cn  
 t(86-512)57355888 f(86-512)57370818 sgs.china@sgs.com



Test Mode: 04; Polarity: Horizontal; Modulation:802.11ac; Bandwidth:40MHz; Channel:Low

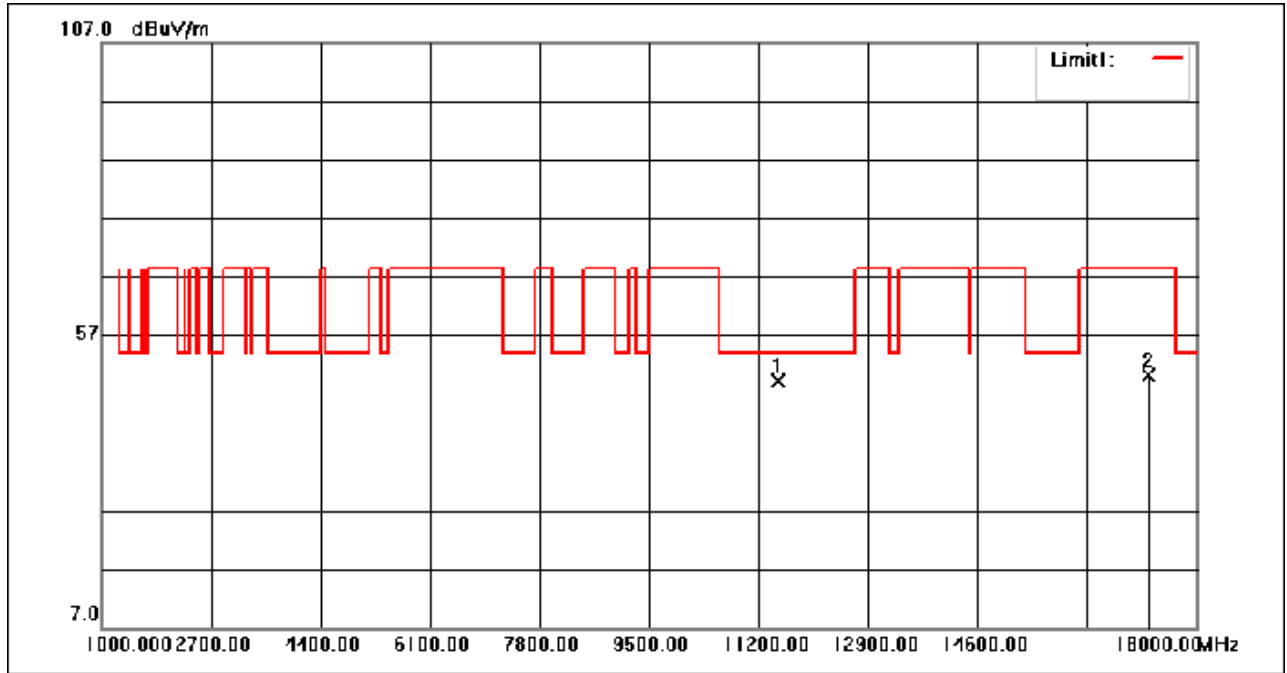

No.	Frequency (MHz)	Reading (dBuV)	Correction factor(dB/m)	Result (dBuV/m)	Limit (dBuV/m)	Margin (dB)	Remark
1	11510.000	48.25	0.99	49.24	54.00	-4.76	peak
2	17265.000	41.16	9.03	50.19	68.30	-18.11	peak



Unless otherwise agreed in writing, this document is issued by the Company subject to its General Conditions of Service printed overleaf, available on request or accessible at <http://www.sgs.com/en/Terms-and-Conditions.aspx> and, for electronic format documents, subject to Terms and Conditions for Electronic Documents at <http://www.sgs.com/en/Terms-and-Conditions/Terms-e-Documents.aspx>. Attention is drawn to the limitation of liability, indemnification and jurisdiction issues defined therein. Any holder of this document is advised that information contained hereon reflects the Company's findings at the time of its intervention only and within the limits of Client's instructions, if any. The Company's sole responsibility is to its Client and this document does not exonerate parties to a transaction from exercising all their rights and obligations under the transaction documents. This document cannot be reproduced except in full, without prior written approval of the Company. Any unauthorized alteration, forgery or falsification of the content or appearance of this document is unlawful and offenders may be prosecuted to the fullest extent of the law. Unless otherwise stated the results shown in this test report refer only to the sample(s) tested and such sample(s) are retained for 30 days only.  
Attention: To check the authenticity of testing /inspection report & certificate, please contact us at telephone: (86-755) 8307 1443, or email: [CN.Doccheck@sgs.com](mailto:CN.Doccheck@sgs.com)

No.10, Weiye Road, Innovation Park, Kunshan, Jiangsu, China 215300  
中国·江苏·昆山市留学生创业园伟业路10号 邮编 215300

t(86-512)57355888 f(86-512)57370818 www.sgsgroup.com.cn  
t(86-512)57355888 f(86-512)57370818 sgs.china@sgs.com

Test Mode: 04; Polarity: Vertical; Modulation:802.11ac; Bandwidth:40MHz; Channel:Low

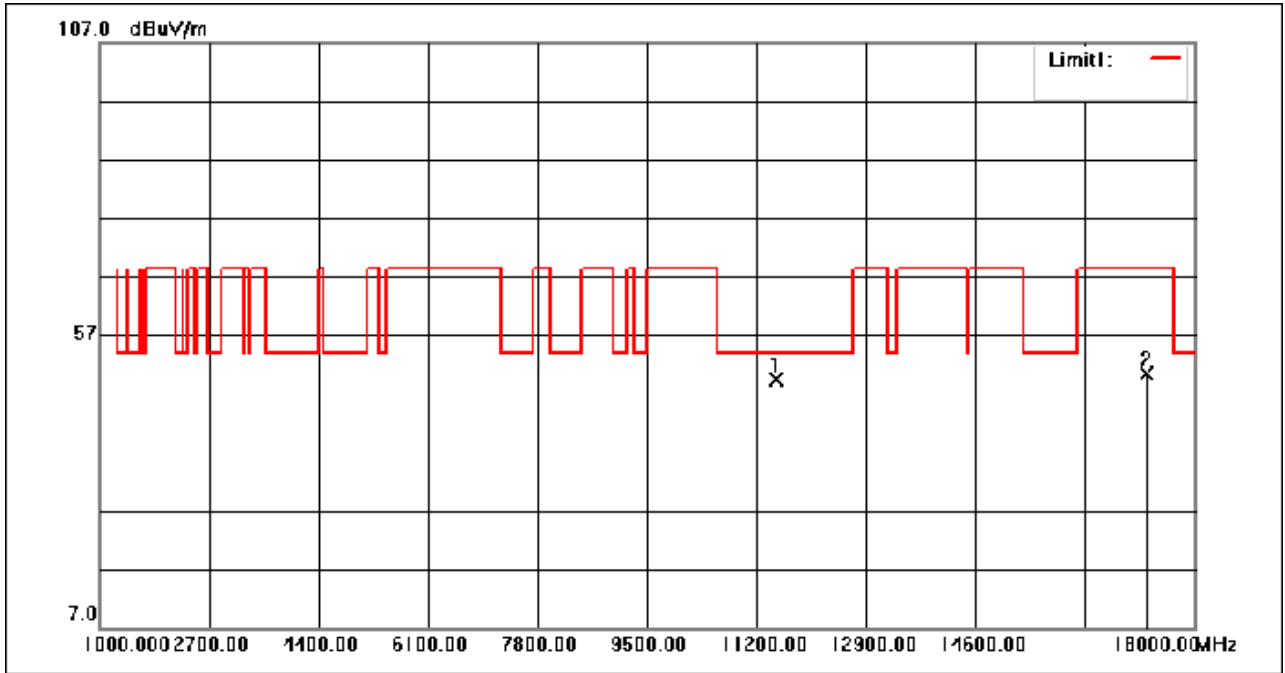

No.	Frequency (MHz)	Reading (dBuV)	Correction factor(dB/m)	Result (dBuV/m)	Limit (dBuV/m)	Margin (dB)	Remark
1	11510.000	48.47	0.99	49.46	54.00	-4.54	peak
2	17265.000	41.28	9.03	50.31	68.30	-17.99	peak



Unless otherwise agreed in writing, this document is issued by the Company subject to its General Conditions of Service printed overleaf, available on request or accessible at <http://www.sgs.com/en/Terms-and-Conditions.aspx> and, for electronic format documents, subject to Terms and Conditions for Electronic Documents at <http://www.sgs.com/en/Terms-and-Conditions/Terms-e-Documents.aspx>. Attention is drawn to the limitation of liability, indemnification and jurisdiction issues defined therein. Any holder of this document is advised that information contained hereon reflects the Company's findings at the time of its intervention only and within the limits of Client's instructions, if any. The Company's sole responsibility is to its Client and this document does not exonerate parties to a transaction from exercising all their rights and obligations under the transaction documents. This document cannot be reproduced except in full, without prior written approval of the Company. Any unauthorized alteration, forgery or falsification of the content or appearance of this document is unlawful and offenders may be prosecuted to the fullest extent of the law. Unless otherwise stated the results shown in this test report refer only to the sample(s) tested and such sample(s) are retained for 30 days only.  
Attention: To check the authenticity of testing /inspection report & certificate, please contact us at telephone: (86-755) 8307 1443, or email: [CN.Doccheck@sgs.com](mailto:CN.Doccheck@sgs.com)

No.10, Weiye Road, Innovation Park, Kunshan, Jiangsu, China 215300  
中国·江苏·昆山市留学生创业园伟业路10号 邮编 215300

t(86-512)57355888 f(86-512)57370818 www.sgsgroup.com.cn  
t(86-512)57355888 f(86-512)57370818 sgs.china@sgs.com

Test Mode: 04; Polarity: Horizontal; Modulation:802.11ac; Bandwidth:40MHz; Channel:High

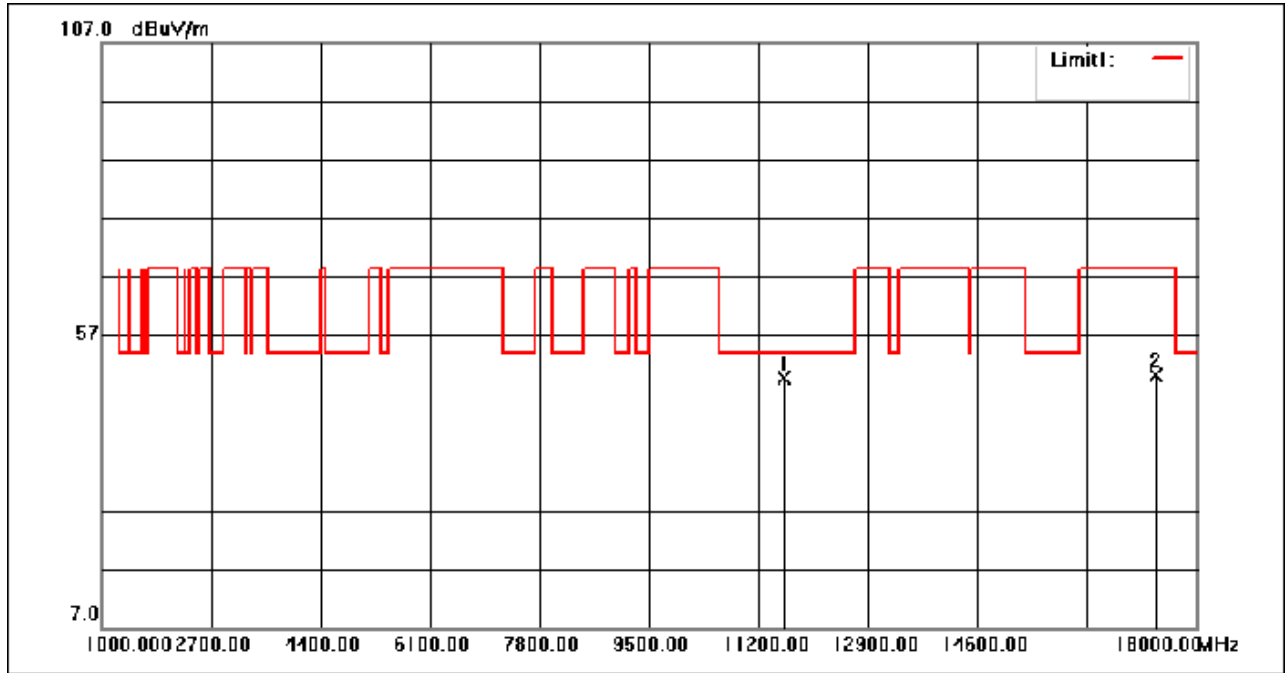

No.	Frequency (MHz)	Reading (dBuV)	Correction factor(dB/m)	Result (dBuV/m)	Limit (dBuV/m)	Margin (dB)	Remark
1	11590.000	48.37	1.25	49.62	54.00	-4.38	peak
2	17385.000	41.07	8.96	50.03	68.30	-18.27	peak



Unless otherwise agreed in writing, this document is issued by the Company subject to its General Conditions of Service printed overleaf, available on request or accessible at <http://www.sgs.com/en/Terms-and-Conditions.aspx> and, for electronic format documents, subject to Terms and Conditions for Electronic Documents at <http://www.sgs.com/en/Terms-and-Conditions/Terms-e-Documents.aspx>. Attention is drawn to the limitation of liability, indemnification and jurisdiction issues defined therein. Any holder of this document is advised that information contained hereon reflects the Company's findings at the time of its intervention only and within the limits of Client's instructions, if any. The Company's sole responsibility is to its Client and this document does not exonerate parties to a transaction from exercising all their rights and obligations under the transaction documents. This document cannot be reproduced except in full, without prior written approval of the Company. Any unauthorized alteration, forgery or falsification of the content or appearance of this document is unlawful and offenders may be prosecuted to the fullest extent of the law. Unless otherwise stated the results shown in this test report refer only to the sample(s) tested and such sample(s) are retained for 30 days only.  
**Attention: To check the authenticity of testing /inspection report & certificate, please contact us at telephone: (86-755) 8307 1443, or email: CN.Doccheck@sgs.com**

No.10, Weiye Road, Innovation Park, Kunshan, Jiangsu, China 215300  
 中国·江苏·昆山市留学生创业园伟业路10号 邮编 215300

t(86-512)57355888 f(86-512)57370818 www.sgsgroup.com.cn  
 t(86-512)57355888 f(86-512)57370818 sgs.china@sgs.com

Test Mode: 04; Polarity: Vertical; Modulation:802.11ac; Bandwidth:40MHz; Channel:High

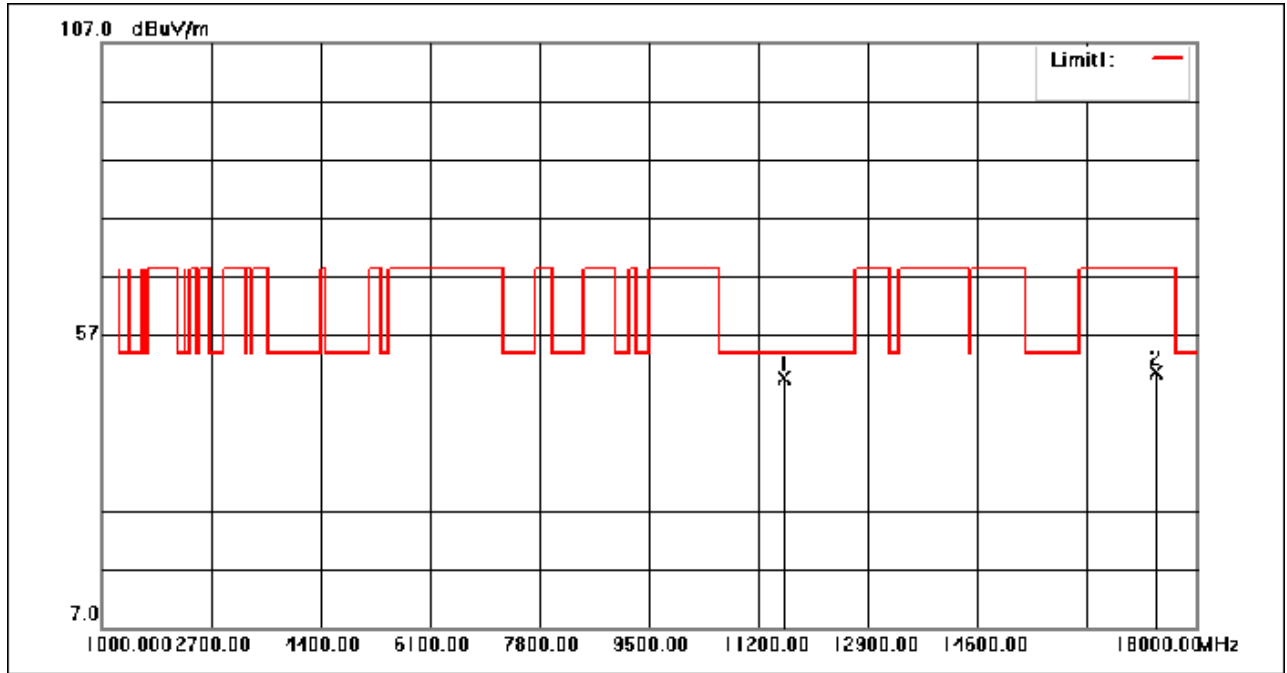

No.	Frequency (MHz)	Reading (dBuV)	Correction factor(dB/m)	Result (dBuV/m)	Limit (dBuV/m)	Margin (dB)	Remark
1	11590.000	48.34	1.25	49.59	54.00	-4.41	peak
2	17385.000	41.77	8.96	50.73	68.30	-17.57	peak



Unless otherwise agreed in writing, this document is issued by the Company subject to its General Conditions of Service printed overleaf, available on request or accessible at <http://www.sgs.com/en/Terms-and-Conditions.aspx> and, for electronic format documents, subject to Terms and Conditions for Electronic Documents at <http://www.sgs.com/en/Terms-and-Conditions/Terms-e-Documents.aspx>. Attention is drawn to the limitation of liability, indemnification and jurisdiction issues defined therein. Any holder of this document is advised that information contained hereon reflects the Company's findings at the time of its intervention only and within the limits of Client's instructions, if any. The Company's sole responsibility is to its Client and this document does not exonerate parties to a transaction from exercising all their rights and obligations under the transaction documents. This document cannot be reproduced except in full, without prior written approval of the Company. Any unauthorized alteration, forgery or falsification of the content or appearance of this document is unlawful and offenders may be prosecuted to the fullest extent of the law. Unless otherwise stated the results shown in this test report refer only to the sample(s) tested and such sample(s) are retained for 30 days only.  
**Attention: To check the authenticity of testing /inspection report & certificate, please contact us at telephone: (86-755) 8307 1443, or email: CN.Doccheck@sgs.com**

No.10, Weiye Road, Innovation Park, Kunshan, Jiangsu, China 215300  
 中国·江苏·昆山市留学生创业园伟业路10号 邮编 215300

t(86-512)57355888 f(86-512)57370818 www.sgsgroup.com.cn  
 t(86-512)57355888 f(86-512)57370818 sgs.china@sgs.com

Test Mode: 04; Polarity: Horizontal; Modulation:802.11 ac; Bandwidth:80MHz; Channel:middle

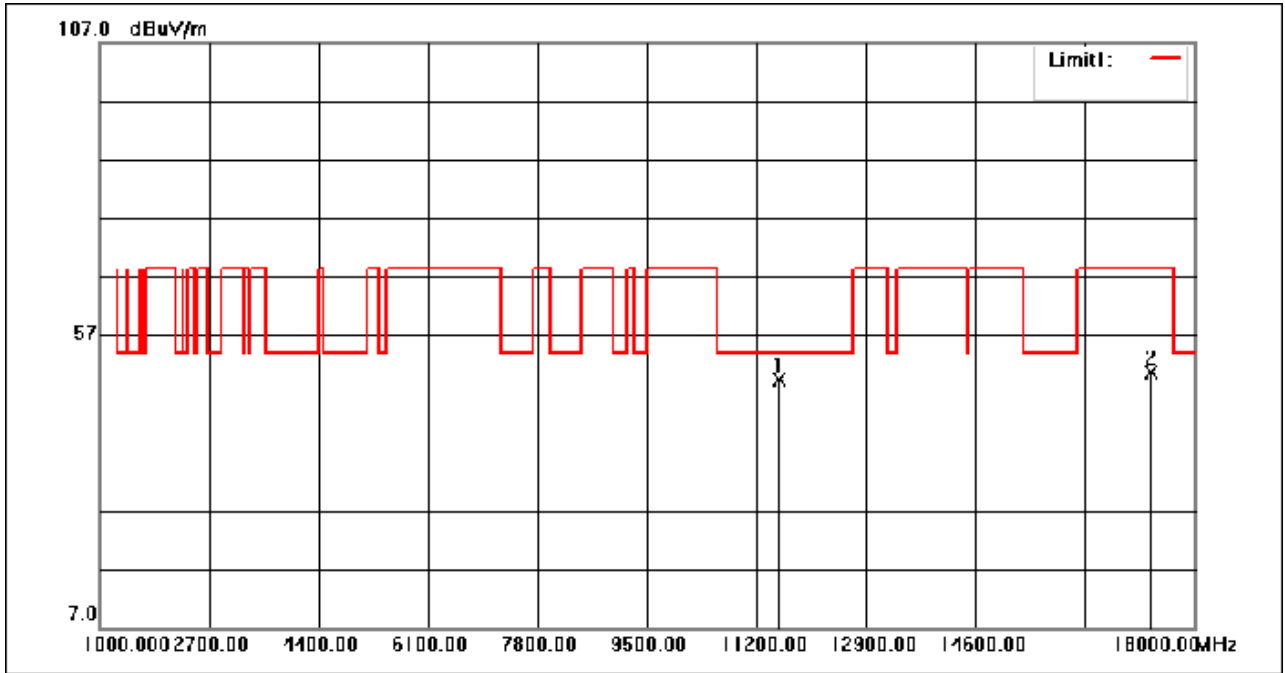

No.	Frequency (MHz)	Reading (dBuV)	Correction factor(dB/m)	Result (dBuV/m)	Limit (dBuV/m)	Margin (dB)	Remark
1	11550.000	48.30	1.12	49.42	54.00	-4.58	peak
2	17325.000	41.75	8.99	50.74	68.30	-17.56	peak



Unless otherwise agreed in writing, this document is issued by the Company subject to its General Conditions of Service printed overleaf, available on request or accessible at <http://www.sgs.com/en/Terms-and-Conditions.aspx> and, for electronic format documents, subject to Terms and Conditions for Electronic Documents at <http://www.sgs.com/en/Terms-and-Conditions/Terms-e-Documents.aspx>. Attention is drawn to the limitation of liability, indemnification and jurisdiction issues defined therein. Any holder of this document is advised that information contained hereon reflects the Company's findings at the time of its intervention only and within the limits of Client's instructions, if any. The Company's sole responsibility is to its Client and this document does not exonerate parties to a transaction from exercising all their rights and obligations under the transaction documents. This document cannot be reproduced except in full, without prior written approval of the Company. Any unauthorized alteration, forgery or falsification of the content or appearance of this document is unlawful and offenders may be prosecuted to the fullest extent of the law. Unless otherwise stated the results shown in this test report refer only to the sample(s) tested and such sample(s) are retained for 30 days only.  
**Attention: To check the authenticity of testing /inspection report & certificate, please contact us at telephone: (86-755) 8307 1443, or email: CN.Doccheck@sgs.com**

No.10, Weiye Road, Innovation Park, Kunshan, Jiangsu, China 215300  
 中国·江苏·昆山市留学生创业园伟业路10号 邮编 215300

t(86-512)57355888 f(86-512)57370818 www.sgsgroup.com.cn  
 t(86-512)57355888 f(86-512)57370818 sgs.china@sgs.com



Test Mode: 04; Polarity: Vertical; Modulation:802.11ac; Bandwidth:80MHz; Channel:middle

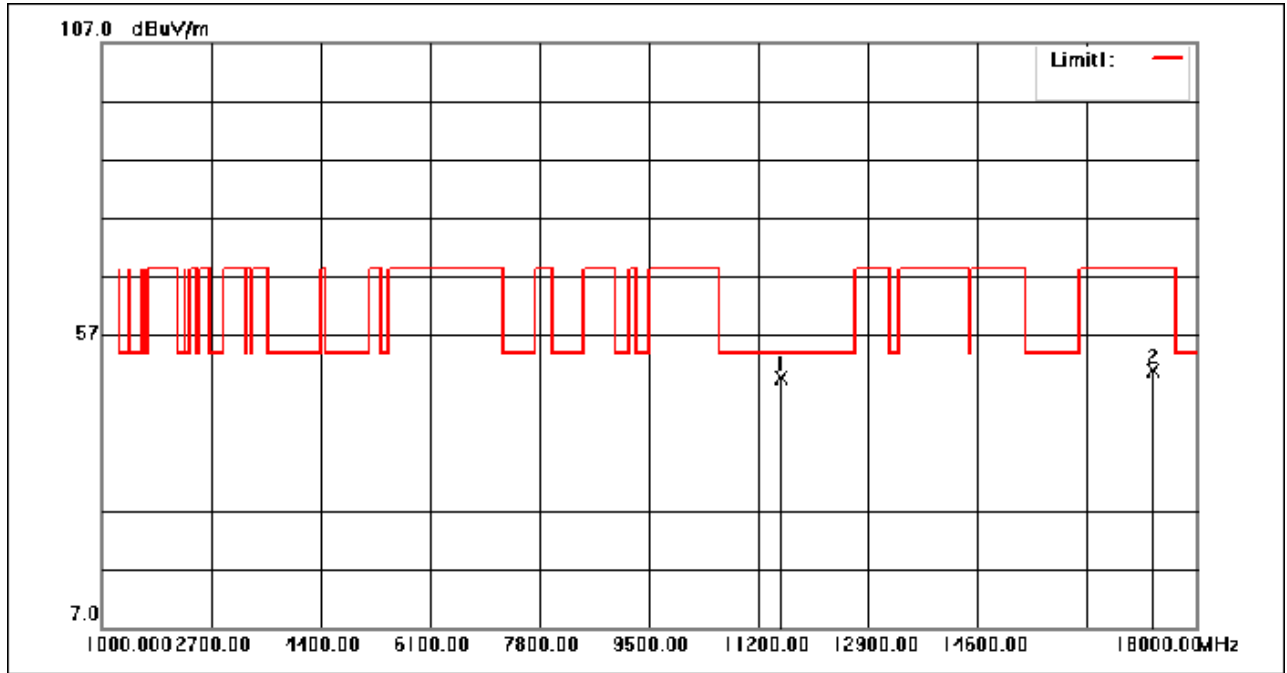

No.	Frequency (MHz)	Reading (dBuV)	Correction factor(dB/m)	Result (dBuV/m)	Limit (dBuV/m)	Margin (dB)	Remark
1	11550.000	48.63	1.12	49.75	54.00	-4.25	peak
2	17325.000	41.89	8.99	50.88	68.30	-17.42	peak



Unless otherwise agreed in writing, this document is issued by the Company subject to its General Conditions of Service printed overleaf, available on request or accessible at <http://www.sgs.com/en/Terms-and-Conditions.aspx> and, for electronic format documents, subject to Terms and Conditions for Electronic Documents at <http://www.sgs.com/en/Terms-and-Conditions/Terms-e-Documents.aspx>. Attention is drawn to the limitation of liability, indemnification and jurisdiction issues defined therein. Any holder of this document is advised that information contained hereon reflects the Company's findings at the time of its intervention only and within the limits of Client's instructions, if any. The Company's sole responsibility is to its Client and this document does not exonerate parties to a transaction from exercising all their rights and obligations under the transaction documents. This document cannot be reproduced except in full, without prior written approval of the Company. Any unauthorized alteration, forgery or falsification of the content or appearance of this document is unlawful and offenders may be prosecuted to the fullest extent of the law. Unless otherwise stated the results shown in this test report refer only to the sample(s) tested and such sample(s) are retained for 30 days only.  
**Attention: To check the authenticity of testing /inspection report & certificate, please contact us at telephone: (86-755) 8307 1443, or email: CN.Doccheck@sgs.com**

No.10, Weiye Road, Innovation Park, Kunshan, Jiangsu, China 215300  
 中国·江苏·昆山市留学生创业园伟业路10号 邮编 215300

t(86-512)57355888 f(86-512)57370818 www.sgsgroup.com.cn  
 t(86-512)57355888 f(86-512)57370818 sgs.china@sgs.com

**7.9 Radiated Emissions which fall in the restricted bands**

Test Requirement 47 CFR Part 15, Subpart C 15.209 & Subpart E 15.407(b)

Test Method: KDB 789033 D02 II G

Limit:

Frequency(MHz)	Field strength(microvolts/meter)	Measurement distance(meters)
0.009-0.490	2400/F(kHz)	300
0.490-1.705	24000/F(kHz)	30
1.705-30.0	30	30
30-88	100	3
88-216	150	3
216-960	200	3
Above 960	500	3

\*(1) For transmitters operating in the 5.15-5.25 GHz band: All emissions outside of the 5.15-5.35 GHz band shall not exceed an e.i.r.p. of -27 dBm/MHz.

(2) For transmitters operating in the 5.25-5.35 GHz band: All emissions outside of the 5.15-5.35 GHz band shall not exceed an e.i.r.p. of -27 dBm/MHz.

(3) For transmitters operating in the 5.47-5.725 GHz band: All emissions outside of the 5.47-5.725 GHz band shall not exceed an e.i.r.p. of -27 dBm/MHz.

(4) For transmitters operating in the 5.725-5.85 GHz band:

(i) All emissions shall be limited to a level of -27 dBm/MHz at 75 MHz or more above or below the band edge increasing linearly to 10 dBm/MHz at 25 MHz above or below the band edge, and from 25 MHz above or below the band edge increasing linearly to a level of 15.6 dBm/MHz at 5 MHz above or below the band edge, and from 5 MHz above or below the band edge increasing linearly to a level of 27 dBm/MHz at the band edge.

Remark: The emission limits shown in the above table are based on measurements employing a CISPR quasi-peak detector except for the frequency bands 9-90kHz, 110-490kHz and above 1000 MHz. Radiated emission limits in these three bands are based on measurements employing an average detector, the peak field strength of any emission shall not exceed the maximum permitted average limits specified above by more than 20 dB under any condition of modulation.

**7.9.1 E.U.T. Operation**

Operating Environment:

Temperature: 23.5 °C  
2 Humidity: 58.5 % RH Atmospheric Pressure: 1010 mbar



Unless otherwise agreed in writing, this document is issued by the Company subject to its General Conditions of Service printed overleaf, available on request or accessible at <http://www.sgs.com/en/Terms-and-Conditions.aspx> and, for electronic format documents, subject to Terms and Conditions for Electronic Documents at <http://www.sgs.com/en/Terms-and-Conditions/Terms-e-Documents.aspx>. Attention is drawn to the limitation of liability, indemnification and jurisdiction issues defined therein. Any holder of this document is advised that information contained hereon reflects the Company's findings at the time of its intervention only and within the limits of Client's instructions, if any. The Company's sole responsibility is to its Client and this document does not exonerate parties to a transaction from exercising all their rights and obligations under the transaction documents. This document cannot be reproduced except in full, without prior written approval of the Company. Any unauthorized alteration, forgery or falsification of the content or appearance of this document is unlawful and offenders may be prosecuted to the fullest extent of the law. Unless otherwise stated the results shown in this test report refer only to the sample(s) tested and such sample(s) are retained for 30 days only. Attention: To check the authenticity of testing / inspection report & certificate, please contact us at telephone: (86-755) 8307 1443, or email: [CN.Doccheck@sgs.com](mailto:CN.Doccheck@sgs.com)

No.10, Weiye Road, Innovation Park, Kunshan, Jiangsu, China 215300  
中国·江苏·昆山市留学生创业园伟业路10号 邮编 215300

t(86-512)57355888 f(86-512)57370818 www.sgsgroup.com.cn  
t(86-512)57355888 f(86-512)57370818 sgs.china@sgs.com

**7.9.2 Test Mode Description**

Pre-scan / Final test	Mode Code	Description
Final test	01	Charge + TX mode (U-NII-1)_Keep the EUT in charging and continuously transmitting mode with all modulation types. All data rates for each modulation type have been tested and found the data rate @ 6Mbps is the worst case of IEEE 802.11a; data rate @ MCS0 is the worst case of IEEE 802.11n(HT20); data rate @ MCS0 is the worst case of IEEE 802.11n(HT40); data rate @ MCS0 is the worst case of IEEE 802.11ac(VHT20); data rate @ MCS0 is the worst case of IEEE 802.11ac(VHT40); data rate @ MCS0 is the worst case of IEEE 802.11ac(VHT80), Only the data of worst case is recorded in the report.
Final test	02	Charge + TX mode (U-NII-2A)_Keep the EUT in charging and continuously transmitting mode with all modulation types. All data rates for each modulation type have been tested and found the data rate @ 6Mbps is the worst case of IEEE 802.11a; data rate @ MCS0 is the worst case of IEEE 802.11n(HT20); data rate @ MCS0 is the worst case of IEEE 802.11n(HT40); data rate @ MCS0 is the worst case of IEEE 802.11ac(VHT20); data rate @ MCS0 is the worst case of IEEE 802.11ac(VHT40); data rate @ MCS0 is the worst case of IEEE 802.11ac(VHT80), final test modes are considering the modulation and worse data rates. Only the data of worst case is recorded in the report.
Final test	03	Charge + TX mode (U-NII-2C)_Keep the EUT in charging and continuously transmitting mode with all modulation types. All data rates for each modulation type have been tested and found the data rate @ 6Mbps is the worst case of IEEE 802.11a; data rate @ MCS0 is the worst case of IEEE 802.11n(HT20); data rate @ MCS0 is the worst case of IEEE 802.11n(HT40); data rate @ MCS0 is the worst case of IEEE 802.11ac(VHT20); data rate @ MCS0 is the worst case of IEEE 802.11ac(VHT40); data rate @ MCS0 is the worst case of IEEE 802.11ac(VHT80), Only the data of worst case is recorded in the report.
Final test	04	Charge + TX mode (U-NII-3)_Keep the EUT in charging and continuously transmitting mode with all modulation types. All data rates for each modulation type have been tested and found the data rate @ 6Mbps is the worst case of IEEE 802.11a; data rate @ MCS0 is the worst case of IEEE 802.11n(HT20); data rate @ MCS0 is the worst case of IEEE 802.11n(HT40); data rate @ MCS0 is the worst case of IEEE 802.11ac(VHT20); data rate @ MCS0 is the worst case of IEEE 802.11ac(VHT40); data rate @ MCS0 is the worst case of IEEE 802.11ac(VHT80), Only the data of worst case is recorded in the report.



Unless otherwise agreed in writing, this document is issued by the Company subject to its General Conditions of Service printed overleaf, available on request or accessible at <http://www.sgs.com/en/Terms-and-Conditions.aspx> and, for electronic format documents, subject to Terms and Conditions for Electronic Documents at <http://www.sgs.com/en/Terms-and-Conditions/Terms-e-Documents.aspx>. Attention is drawn to the limitation of liability, indemnification and jurisdiction issues defined therein. Any holder of this document is advised that information contained hereon reflects the Company's findings at the time of its intervention only and within the limits of Client's instructions, if any. The Company's sole responsibility is to its Client and this document does not exonerate parties to a transaction from exercising all their rights and obligations under the transaction documents. This document cannot be reproduced except in full, without prior written approval of the Company. Any unauthorized alteration, forgery or falsification of the content or appearance of this document is unlawful and offenders may be prosecuted to the fullest extent of the law. Unless otherwise stated the results shown in this test report refer only to the sample(s) tested and such sample(s) are retained for 30 days only.  
**Attention: To check the authenticity of testing /inspection report & certificate, please contact us at telephone: (86-755) 8307 1443, or email: CN.Doccheck@sgs.com**

No.10, Weiye Road, Innovation Park, Kunshan, Jiangsu, China 215300  
 中国·江苏·昆山市留学生创业园伟业路10号 邮编 215300

t(86-512)57355888 f(86-512)57370818 www.sgsgroup.com.cn  
 t(86-512)57355888 f(86-512)57370818 sgs.china@sgs.com

### 7.9.3 Test Setup Diagram

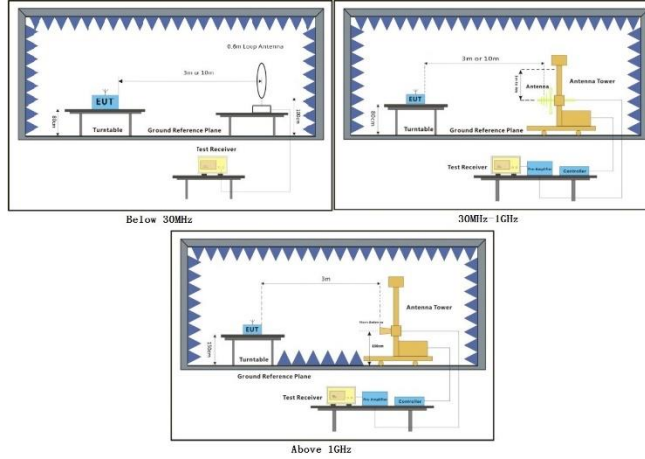

Unless otherwise agreed in writing, this document is issued by the Company subject to its General Conditions of Service printed overleaf, available on request or accessible at <http://www.sgs.com/en/Terms-and-Conditions.aspx> and, for electronic format documents, subject to Terms and Conditions for Electronic Documents at <http://www.sgs.com/en/Terms-and-Conditions/Terms-e-Document.aspx>. Attention is drawn to the limitation of liability, indemnification and jurisdiction issues defined therein. Any holder of this document is advised that information contained hereon reflects the Company's findings at the time of its intervention only and within the limits of Client's instructions, if any. The Company's sole responsibility is to its Client and this document does not exonerate parties to a transaction from exercising all their rights and obligations under the transaction documents. This document cannot be reproduced except in full, without prior written approval of the Company. Any unauthorized alteration, forgery or falsification of the content or appearance of this document is unlawful and offenders may be prosecuted to the fullest extent of the law. Unless otherwise stated the results shown in this test report refer only to the sample(s) tested and such sample(s) are retained for 30 days only.  
**Attention: To check the authenticity of testing /inspection report & certificate, please contact us at telephone: (86-755) 8307 1443, or email: CN\_Doccheck@sgs.com**

No.10, Weiye Road, Innovation Park, Kunshan, Jiangsu, China 215300  
中国·江苏·昆山市留学生创业园伟业路10号 邮编 215300

t(86-512)57355888 f(86-512)57370818 www.sgsgroup.com.cn  
t(86-512)57355888 f(86-512)57370818 sgs.china@sgs.com



**7.9.4 Measurement Procedure and Data**

- a. For below 1GHz, the EUT was placed on the top of a rotating table 0.8 meters above the ground at a 3 or 10 meter semi-anechoic chamber. The table was rotated 360 degrees to determine the position of the highest radiation.
- b. For above 1GHz, the EUT was placed on the top of a rotating table 1.5 meters above the ground at a 3 meter fully-anechoic chamber. The table was rotated 360 degrees to determine the position of the highest radiation.
- c. The EUT was set 3 or 10 meters away from the interference-receiving antenna, which was mounted on the top of a variable-height antenna tower.
- d. The antenna height is varied from one meter to four meters above the ground to determine the maximum value of the field strength. Both horizontal and vertical polarizations of the antenna are set to make the measurement.
- e. For each suspected emission, the EUT was arranged to its worst case and then the antenna was tuned to heights from 1 meter to 4 meters (for the test frequency of below 30MHz, the antenna was tuned to heights 1 meter) and the rotatable table was turned from 0 degrees to 360 degrees to find the maximum reading.
- f. The test-receiver system was set to Peak Detect Function and Specified Bandwidth with Maximum Hold Mode.
- g. If the emission level of the EUT in peak mode was 10dB lower than the limit specified, then testing could be stopped and the peak values of the EUT would be reported. Otherwise the emissions that did not have 10dB margin would be re-tested one by one using peak, quasi-peak or average method as specified and then reported in a data sheet.
- h. Test the EUT in the lowest channel, the middle channel, the Highest channel.
- i. The radiation measurements are performed in X, Y, Z axis positioning for Transmitting mode, and found the X axis positioning which it is the worst case.
- j. Repeat above procedures until all frequencies measured was complete.

Remark: Level= Read Level+ Cable Loss+ Antenna Factor- Preamp Factor

Remark: This test item was investigated while operating in SISO and MIMO mode, however, it was determined that SISO antenna 1 operation for a modulation and MIMO antenna operation for n/ac modulation produced the worst emissions. So the emissions produced from other operation are not recorded in report.



Unless otherwise agreed in writing, this document is issued by the Company subject to its General Conditions of Service printed overleaf, available on request or accessible at <http://www.sgs.com/en/Terms-and-Conditions.aspx> and, for electronic format documents, subject to Terms and Conditions for Electronic Documents at <http://www.sgs.com/en/Terms-and-Conditions/Terms-e-Documents.aspx>. Attention is drawn to the limitation of liability, indemnification and jurisdiction issues defined therein. Any holder of this document is advised that information contained hereon reflects the Company's findings at the time of its intervention only and within the limits of Client's instructions, if any. The Company's sole responsibility is to its Client and this document does not exonerate parties to a transaction from exercising all their rights and obligations under the transaction documents. This document cannot be reproduced except in full, without prior written approval of the Company. Any unauthorized alteration, forgery or falsification of the content or appearance of this document is unlawful and offenders may be prosecuted to the fullest extent of the law. Unless otherwise stated the results shown in this test report refer only to the sample(s) tested and such sample(s) are retained for 30 days only.  
**Attention: To check the authenticity of testing /inspection report & certificate, please contact us at telephone: (86-755) 8307 1443, or email: CN.Doccheck@sgs.com**

No.10, Weiye Road, Innovation Park, Kunshan, Jiangsu, China 215300      t(86-512)57355888      f(86-512)57370818      www.sgsgroup.com.cn  
 中国·江苏·昆山市留学院创业园伟业路10号 邮编 215300      t(86-512)57355888      f(86-512)57370818      sgs.china@sgs.com



Test Mode: 01; Polarity: Horizontal; Modulation:802.11a; Bandwidth:20MHz; Channel:Low

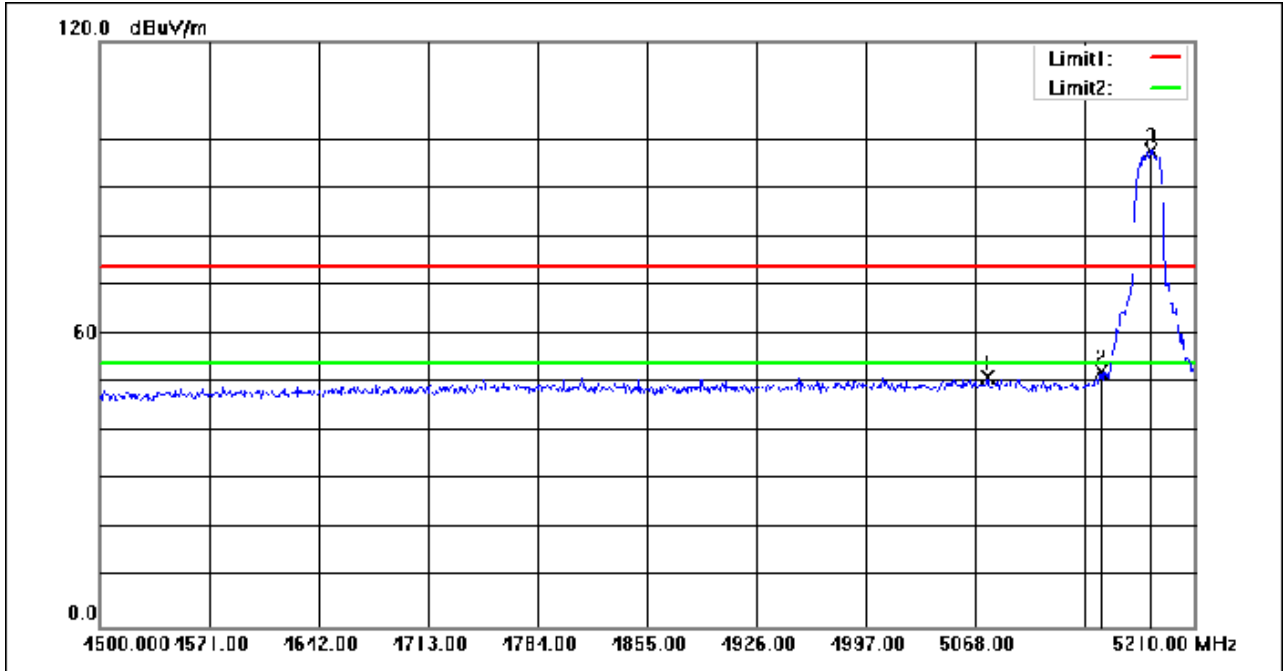

No.	Frequency (MHz)	Reading (dBuV)	Correction factor(dB/m)	Result (dBuV/m)	Limit (dBuV/m)	Margin (dB)	Remark
1	5075.810	61.88	-10.63	51.25	74.00	-22.75	peak
2	5150.000	62.87	-10.64	52.23	74.00	-21.77	peak
3	5182.310	108.38	-10.64	97.74	74.00	23.74	peak



Unless otherwise agreed in writing, this document is issued by the Company subject to its General Conditions of Service printed overleaf, available on request or accessible at <http://www.sgs.com/en/Terms-and-Conditions.aspx> and, for electronic format documents, subject to Terms and Conditions for Electronic Documents at <http://www.sgs.com/en/Terms-and-Conditions/Terms-e-Documents.aspx>. Attention is drawn to the limitation of liability, indemnification and jurisdiction issues defined therein. Any holder of this document is advised that information contained hereon reflects the Company's findings at the time of its intervention only and within the limits of Client's instructions, if any. The Company's sole responsibility is to its Client and this document does not exonerate parties to a transaction from exercising all their rights and obligations under the transaction documents. This document cannot be reproduced except in full, without prior written approval of the Company. Any unauthorized alteration, forgery or falsification of the content or appearance of this document is unlawful and offenders may be prosecuted to the fullest extent of the law. Unless otherwise stated the results shown in this test report refer only to the sample(s) tested and such sample(s) are retained for 30 days only.  
**Attention: To check the authenticity of testing /inspection report & certificate, please contact us at telephone: (86-755) 8307 1443, or email: CN.Doccheck@sgs.com**

No.10, Weiye Road, Innovation Park, Kunshan, Jiangsu, China 215300  
 中国·江苏·昆山市留学生创业园伟业路10号 邮编 215300

t(86-512)57355888 f(86-512)57370818 www.sgsgroup.com.cn  
 t(86-512)57355888 f(86-512)57370818 sgs.china@sgs.com

Test Mode: 01; Polarity: Vertical; Modulation:802.11a; Bandwidth:20MHz; Channel:Low

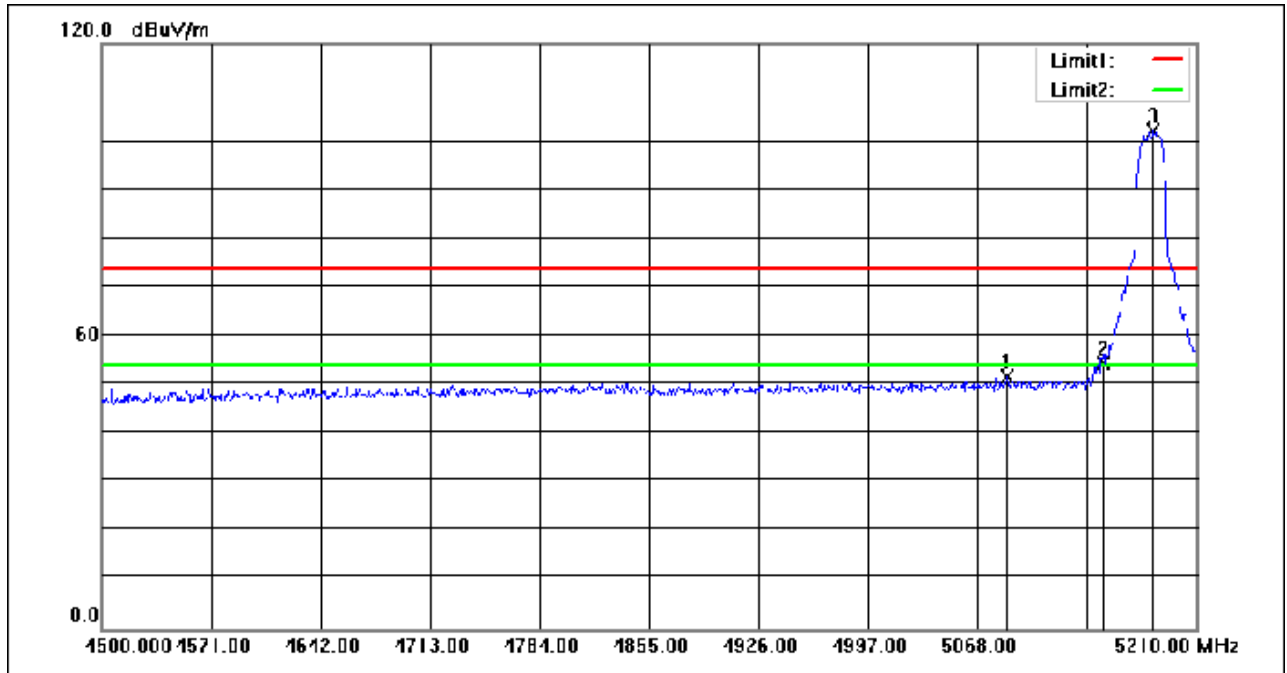

No.	Frequency (MHz)	Reading (dBuV)	Correction factor(dB/m)	Result (dBuV/m)	Limit (dBuV/m)	Margin (dB)	Remark
1	5087.170	62.35	-10.63	51.72	74.00	-22.28	peak
2	5150.000	64.96	-10.64	54.32	74.00	-19.68	peak
3	5182.310	112.79	-10.64	102.15	74.00	28.15	peak



Unless otherwise agreed in writing, this document is issued by the Company subject to its General Conditions of Service printed overleaf, available on request or accessible at <http://www.sgs.com/en/Terms-and-Conditions.aspx> and, for electronic format documents, subject to Terms and Conditions for Electronic Documents at <http://www.sgs.com/en/Terms-and-Conditions/Terms-e-Documents.aspx>. Attention is drawn to the limitation of liability, indemnification and jurisdiction issues defined therein. Any holder of this document is advised that information contained hereon reflects the Company's findings at the time of its intervention only and within the limits of Client's instructions, if any. The Company's sole responsibility is to its Client and this document does not exonerate parties to a transaction from exercising all their rights and obligations under the transaction documents. This document cannot be reproduced except in full, without prior written approval of the Company. Any unauthorized alteration, forgery or falsification of the content or appearance of this document is unlawful and offenders may be prosecuted to the fullest extent of the law. Unless otherwise stated the results shown in this test report refer only to the sample(s) tested and such sample(s) are retained for 30 days only.  
**Attention: To check the authenticity of testing /inspection report & certificate, please contact us at telephone: (86-755) 8307 1443, or email: CN.Doccheck@sgs.com**

No.10, Weiye Road, Innovation Park, Kunshan, Jiangsu, China 215300  
 中国·江苏·昆山市留学生创业园伟业路10号 邮编 215300

t(86-512)57355888 f(86-512)57370818 www.sgsgroup.com.cn  
 t(86-512)57355888 f(86-512)57370818 sgs.china@sgs.com

Test Mode: 01; Polarity: Vertical; Modulation:802.11a; Bandwidth:20MHz; Channel:Low

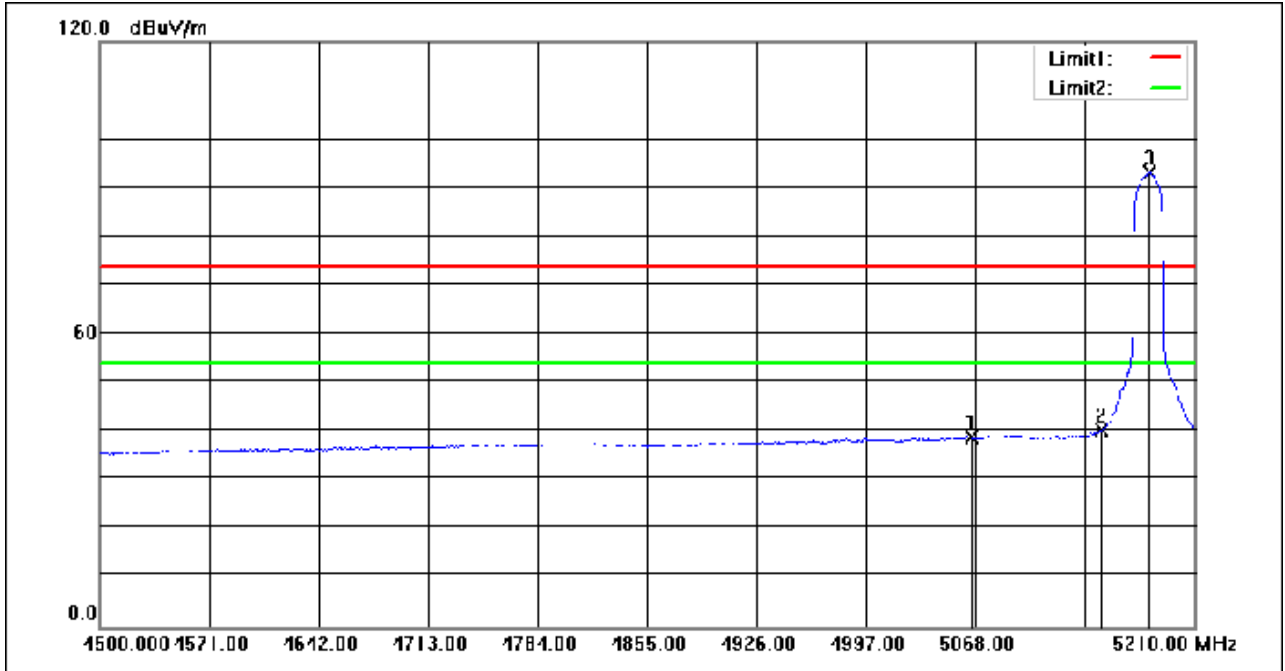

No.	Frequency (MHz)	Reading (dBuV)	Correction factor(dB/m)	Result (dBuV/m)	Limit (dBuV/m)	Margin (dB)	Remark
1	5068.870	49.52	-10.62	38.90	54.00	-15.10	AVG
2	5150.000	50.94	-10.64	40.30	54.00	-13.70	AVG
3	5180.890	103.75	-10.64	93.11	54.00	39.11	AVG



Unless otherwise agreed in writing, this document is issued by the Company subject to its General Conditions of Service printed overleaf, available on request or accessible at <http://www.sgs.com/en/Terms-and-Conditions.aspx> and, for electronic format documents, subject to Terms and Conditions for Electronic Documents at <http://www.sgs.com/en/Terms-and-Conditions/Terms-e-Documents.aspx>. Attention is drawn to the limitation of liability, indemnification and jurisdiction issues defined therein. Any holder of this document is advised that information contained hereon reflects the Company's findings at the time of its intervention only and within the limits of Client's instructions, if any. The Company's sole responsibility is to its Client and this document does not exonerate parties to a transaction from exercising all their rights and obligations under the transaction documents. This document cannot be reproduced except in full, without prior written approval of the Company. Any unauthorized alteration, forgery or falsification of the content or appearance of this document is unlawful and offenders may be prosecuted to the fullest extent of the law. Unless otherwise stated the results shown in this test report refer only to the sample(s) tested and such sample(s) are retained for 30 days only.  
**Attention: To check the authenticity of testing /inspection report & certificate, please contact us at telephone: (86-755) 8307 1443, or email: CN.Doccheck@sgs.com**

No.10, Weiye Road, Innovation Park, Kunshan, Jiangsu, China 215300  
 中国·江苏·昆山市留学生创业园伟业路10号 邮编 215300

t(86-512)57355888 f(86-512)57370818 www.sgsgroup.com.cn  
 t(86-512)57355888 f(86-512)57370818 sgs.china@sgs.com

Test Mode: 01; Polarity: Horizontal; Modulation:802.11n; Bandwidth:20MHz; Channel:Low

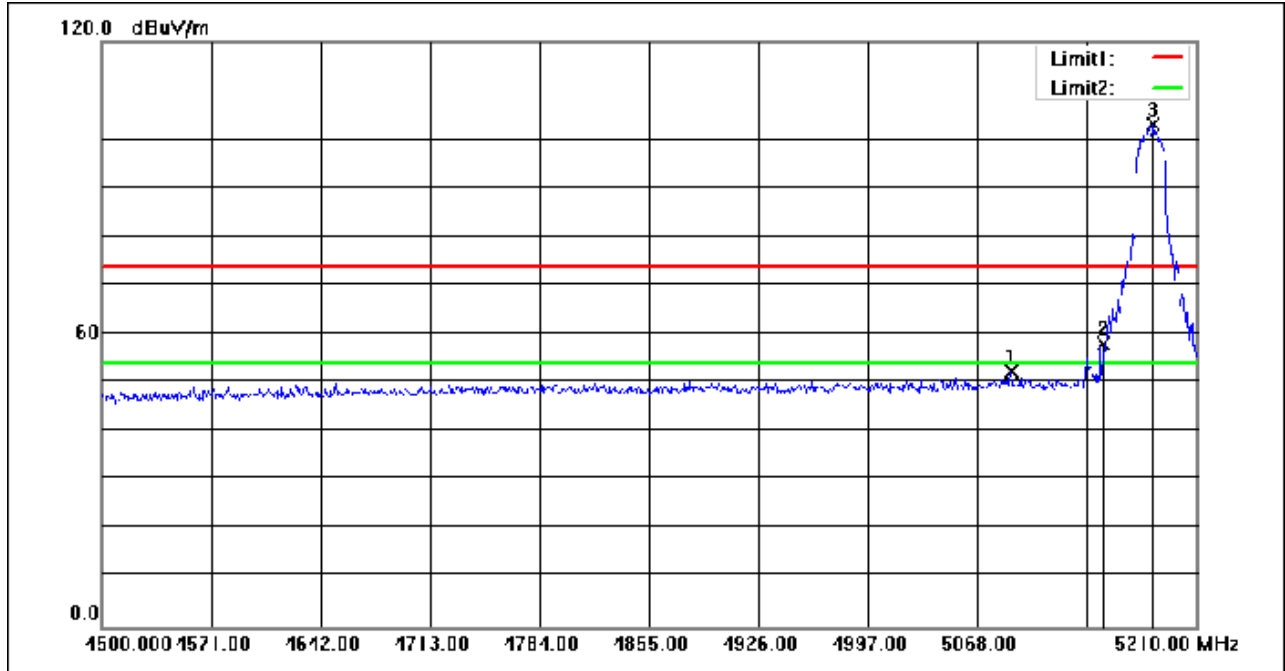

No.	Frequency (MHz)	Reading (dBuV)	Correction factor(dB/m)	Result (dBuV/m)	Limit (dBuV/m)	Margin (dB)	Remark
1	5090.010	63.02	-10.63	52.39	74.00	-21.61	peak
2	5150.000	68.63	-10.64	57.99	74.00	-16.01	peak
3	5182.310	113.78	-10.64	103.14	74.00	29.14	peak



Unless otherwise agreed in writing, this document is issued by the Company subject to its General Conditions of Service printed overleaf, available on request or accessible at <http://www.sgs.com/en/Terms-and-Conditions.aspx> and, for electronic format documents, subject to Terms and Conditions for Electronic Documents at <http://www.sgs.com/en/Terms-and-Conditions/Terms-e-Documents.aspx>. Attention is drawn to the limitation of liability, indemnification and jurisdiction issues defined therein. Any holder of this document is advised that information contained hereon reflects the Company's findings at the time of its intervention only and within the limits of Client's instructions, if any. The Company's sole responsibility is to its Client and this document does not exonerate parties to a transaction from exercising all their rights and obligations under the transaction documents. This document cannot be reproduced except in full, without prior written approval of the Company. Any unauthorized alteration, forgery or falsification of the content or appearance of this document is unlawful and offenders may be prosecuted to the fullest extent of the law. Unless otherwise stated the results shown in this test report refer only to the sample(s) tested and such sample(s) are retained for 30 days only.  
**Attention: To check the authenticity of testing /inspection report & certificate, please contact us at telephone: (86-755) 8307 1443, or email: CN.Doccheck@sgs.com**

No.10, Weiye Road, Innovation Park, Kunshan, Jiangsu, China 215300  
 中国·江苏·昆山市留学生创业园伟业路10号 邮编 215300

t(86-512)57355888 f(86-512)57370818 www.sgsgroup.com.cn  
 t(86-512)57355888 f(86-512)57370818 sgs.china@sgs.com

Test Mode: 01; Polarity: Horizontal; Modulation:802.11n; Bandwidth:20MHz; Channel:Low

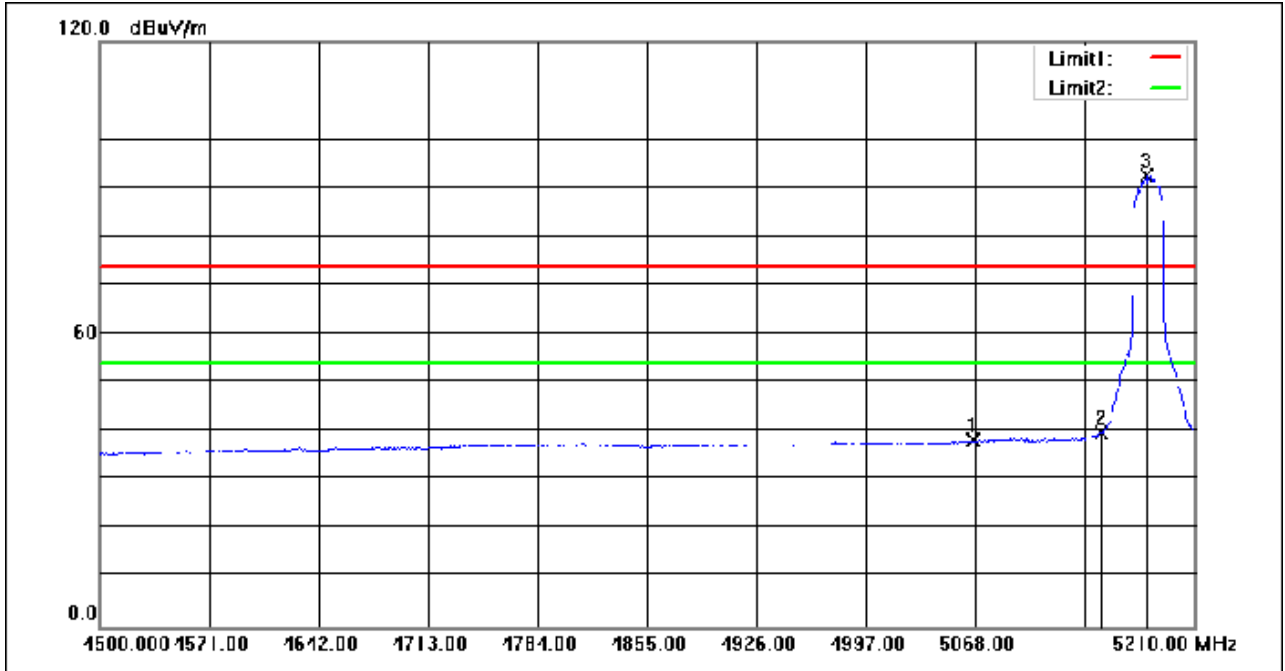

No.	Frequency (MHz)	Reading (dBuV)	Correction factor(dB/m)	Result (dBuV/m)	Limit (dBuV/m)	Margin (dB)	Remark
1	5066.580	48.90	-10.62	38.28	54.00	-15.72	AVG
2	5150.000	50.36	-10.64	39.72	54.00	-14.28	AVG
3	5178.760	103.15	-10.64	92.51	54.00	38.51	AVG



Unless otherwise agreed in writing, this document is issued by the Company subject to its General Conditions of Service printed overleaf, available on request or accessible at <http://www.sgs.com/en/Terms-and-Conditions.aspx> and, for electronic format documents, subject to Terms and Conditions for Electronic Documents at <http://www.sgs.com/en/Terms-and-Conditions/Terms-e-Documents.aspx>. Attention is drawn to the limitation of liability, indemnification and jurisdiction issues defined therein. Any holder of this document is advised that information contained hereon reflects the Company's findings at the time of its intervention only and within the limits of Client's instructions, if any. The Company's sole responsibility is to its Client and this document does not exonerate parties to a transaction from exercising all their rights and obligations under the transaction documents. This document cannot be reproduced except in full, without prior written approval of the Company. Any unauthorized alteration, forgery or falsification of the content or appearance of this document is unlawful and offenders may be prosecuted to the fullest extent of the law. Unless otherwise stated the results shown in this test report refer only to the sample(s) tested and such sample(s) are retained for 30 days only.  
**Attention: To check the authenticity of testing /inspection report & certificate, please contact us at telephone: (86-755) 8307 1443, or email: CN.Doccheck@sgs.com**

No.10, Weiye Road, Innovation Park, Kunshan, Jiangsu, China 215300  
 中国·江苏·昆山市留学生创业园伟业路10号 邮编 215300

t(86-512)57355888 f(86-512)57370818 www.sgsgroup.com.cn  
 t(86-512)57355888 f(86-512)57370818 sgs.china@sgs.com



Test Mode: 01; Polarity: Vertical; Modulation:802.11n; Bandwidth:20MHz; Channel:Low

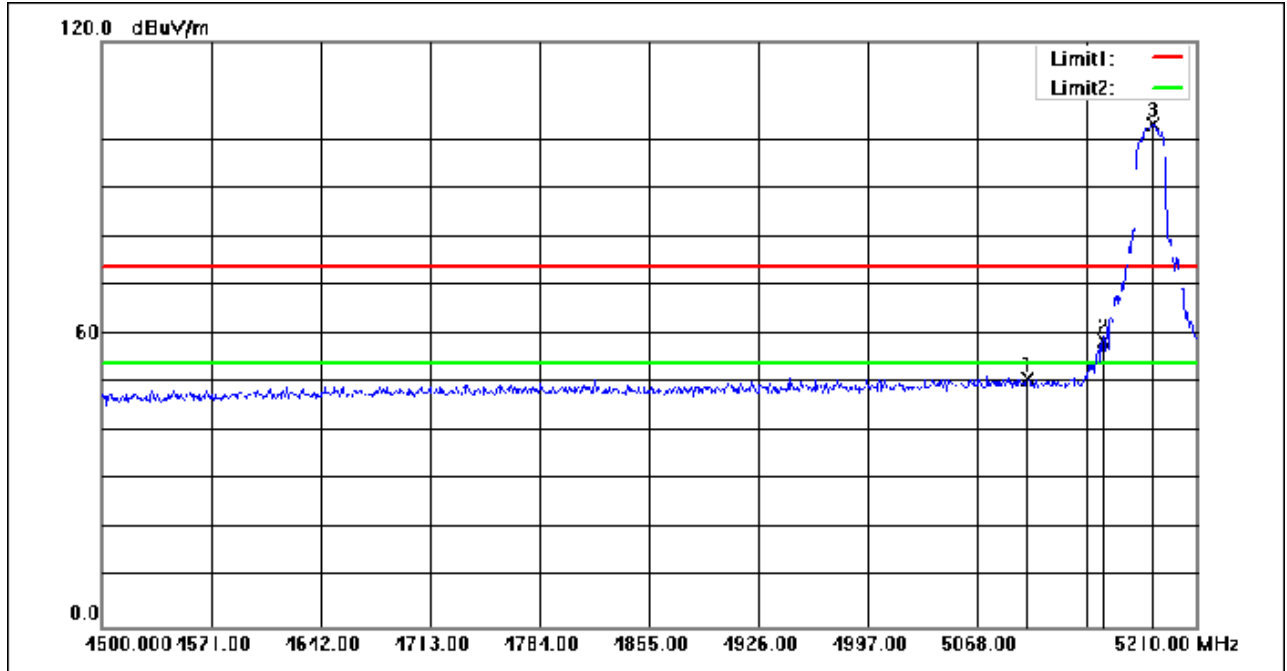

No.	Frequency (MHz)	Reading (dBuV)	Correction factor(dB/m)	Result (dBuV/m)	Limit (dBuV/m)	Margin (dB)	Remark
1	5100.660	61.44	-10.63	50.81	74.00	-23.19	peak
2	5150.000	69.17	-10.64	58.53	74.00	-15.47	peak
3	5182.310	113.82	-10.64	103.18	74.00	29.18	peak



Unless otherwise agreed in writing, this document is issued by the Company subject to its General Conditions of Service printed overleaf, available on request or accessible at <http://www.sgs.com/en/Terms-and-Conditions.aspx> and, for electronic format documents, subject to Terms and Conditions for Electronic Documents at <http://www.sgs.com/en/Terms-and-Conditions/Terms-e-Documents.aspx>. Attention is drawn to the limitation of liability, indemnification and jurisdiction issues defined therein. Any holder of this document is advised that information contained hereon reflects the Company's findings at the time of its intervention only and within the limits of Client's instructions, if any. The Company's sole responsibility is to its Client and this document does not exonerate parties to a transaction from exercising all their rights and obligations under the transaction documents. This document cannot be reproduced except in full, without prior written approval of the Company. Any unauthorized alteration, forgery or falsification of the content or appearance of this document is unlawful and offenders may be prosecuted to the fullest extent of the law. Unless otherwise stated the results shown in this test report refer only to the sample(s) tested and such sample(s) are retained for 30 days only.  
**Attention: To check the authenticity of testing /inspection report & certificate, please contact us at telephone: (86-755) 8307 1443, or email: CN.Doccheck@sgs.com**

No.10, Weiye Road, Innovation Park, Kunshan, Jiangsu, China 215300  
 中国·江苏·昆山市留学生创业园伟业路10号 邮编 215300

t(86-512)57355888 f(86-512)57370818 www.sgsgroup.com.cn  
 t(86-512)57355888 f(86-512)57370818 sgs.china@sgs.com

Test Mode: 01; Polarity: Vertical; Modulation:802.11n; Bandwidth:20MHz; Channel:Low

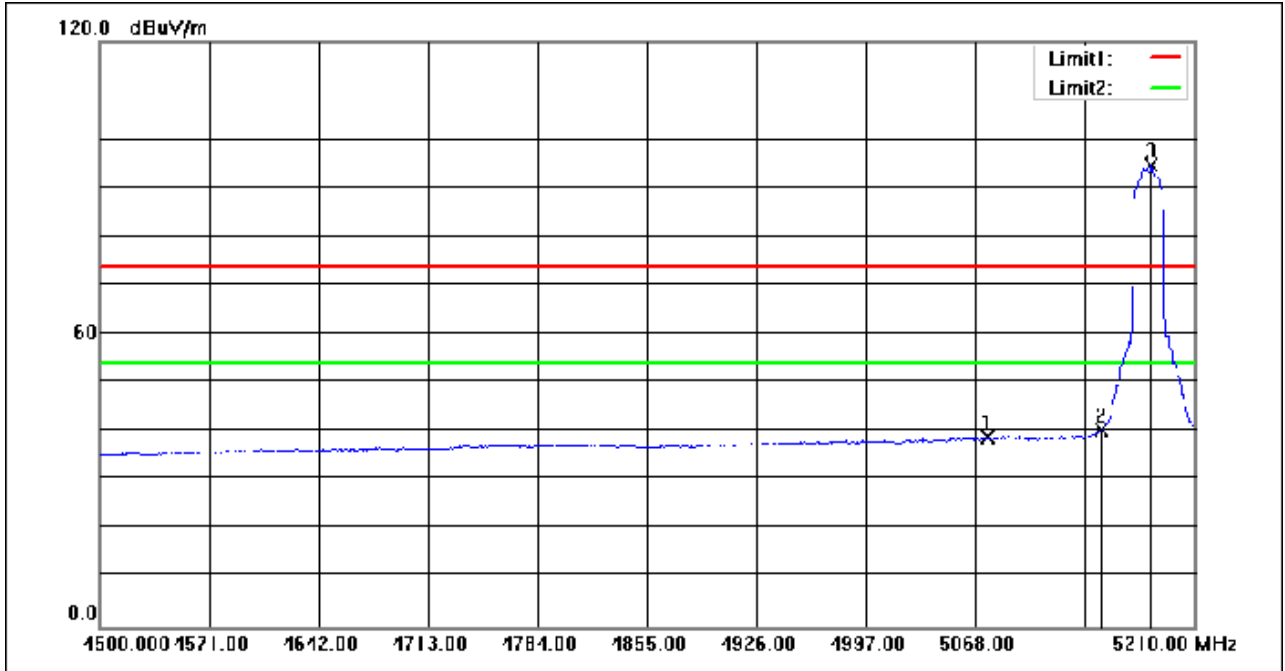

No.	Frequency (MHz)	Reading (dBuV)	Correction factor(dB/m)	Result (dBuV/m)	Limit (dBuV/m)	Margin (dB)	Remark
1	5075.810	49.59	-10.63	38.96	54.00	-15.04	AVG
2	5150.000	51.01	-10.64	40.37	54.00	-13.63	AVG
3	5182.310	105.30	-10.64	94.66	54.00	40.66	AVG



Unless otherwise agreed in writing, this document is issued by the Company subject to its General Conditions of Service printed overleaf, available on request or accessible at <http://www.sgs.com/en/Terms-and-Conditions.aspx> and, for electronic format documents, subject to Terms and Conditions for Electronic Documents at <http://www.sgs.com/en/Terms-and-Conditions/Terms-e-Documents.aspx>. Attention is drawn to the limitation of liability, indemnification and jurisdiction issues defined therein. Any holder of this document is advised that information contained hereon reflects the Company's findings at the time of its intervention only and within the limits of Client's instructions, if any. The Company's sole responsibility is to its Client and this document does not exonerate parties to a transaction from exercising all their rights and obligations under the transaction documents. This document cannot be reproduced except in full, without prior written approval of the Company. Any unauthorized alteration, forgery or falsification of the content or appearance of this document is unlawful and offenders may be prosecuted to the fullest extent of the law. Unless otherwise stated the results shown in this test report refer only to the sample(s) tested and such sample(s) are retained for 30 days only.  
**Attention: To check the authenticity of testing /inspection report & certificate, please contact us at telephone: (86-755) 8307 1443, or email: CN.Doccheck@sgs.com**

No.10, Weiye Road, Innovation Park, Kunshan, Jiangsu, China 215300  
 中国·江苏·昆山市留学生创业园伟业路10号 邮编 215300

t(86-512)57355888 f(86-512)57370818 www.sgsgroup.com.cn  
 t(86-512)57355888 f(86-512)57370818 sgs.china@sgs.com

Test Mode: 01; Polarity: Horizontal; Modulation:802.11n; Bandwidth:40MHz; Channel:Low

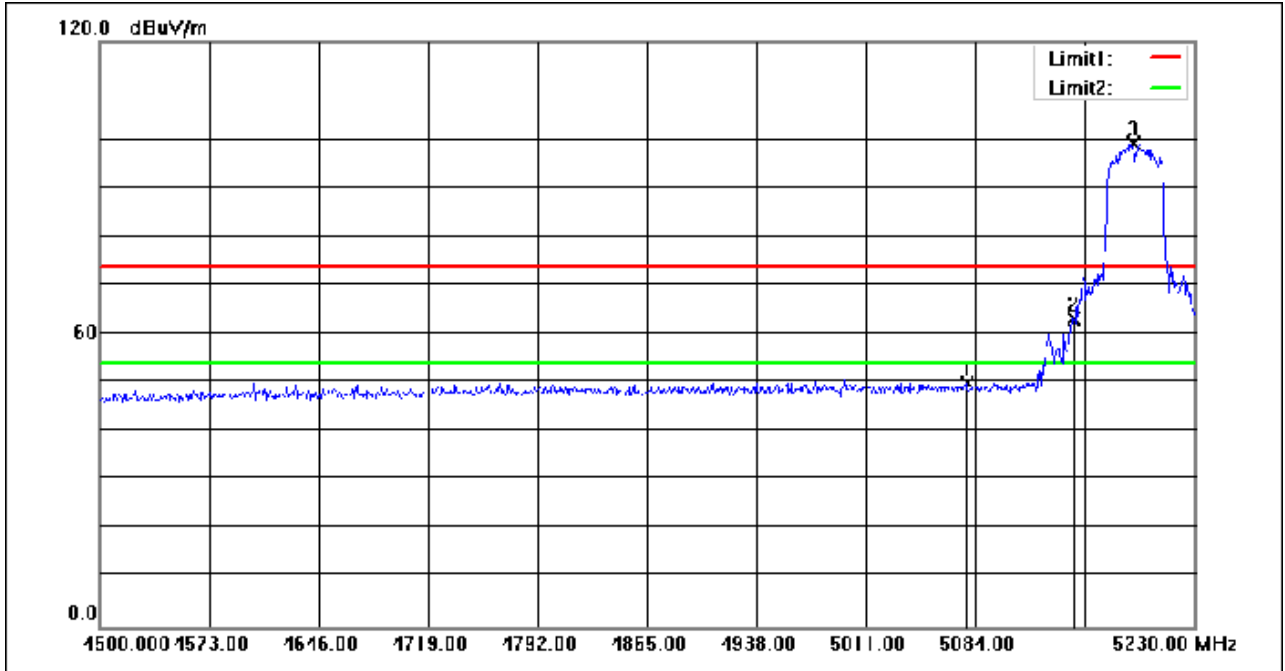

No.	Frequency (MHz)	Reading (dBuV)	Correction factor(dB/m)	Result (dBuV/m)	Limit (dBuV/m)	Margin (dB)	Remark
1	5078.160	60.57	-10.63	49.94	74.00	-24.06	peak
2	5150.000	73.90	-10.64	63.26	74.00	-10.74	peak
3	5189.850	109.84	-10.65	99.19	74.00	25.19	peak



Unless otherwise agreed in writing, this document is issued by the Company subject to its General Conditions of Service printed overleaf, available on request or accessible at <http://www.sgs.com/en/Terms-and-Conditions.aspx> and, for electronic format documents, subject to Terms and Conditions for Electronic Documents at <http://www.sgs.com/en/Terms-and-Conditions/Terms-e-Documents.aspx>. Attention is drawn to the limitation of liability, indemnification and jurisdiction issues defined therein. Any holder of this document is advised that information contained hereon reflects the Company's findings at the time of its intervention only and within the limits of Client's instructions, if any. The Company's sole responsibility is to its Client and this document does not exonerate parties to a transaction from exercising all their rights and obligations under the transaction documents. This document cannot be reproduced except in full, without prior written approval of the Company. Any unauthorized alteration, forgery or falsification of the content or appearance of this document is unlawful and offenders may be prosecuted to the fullest extent of the law. Unless otherwise stated the results shown in this test report refer only to the sample(s) tested and such sample(s) are retained for 30 days only.  
**Attention: To check the authenticity of testing /inspection report & certificate, please contact us at telephone: (86-755) 8307 1443, or email: CN.Doccheck@sgs.com**

No.10, Weiye Road, Innovation Park, Kunshan, Jiangsu, China 215300  
 中国·江苏·昆山市留学生创业园伟业路10号 邮编 215300

t(86-512)57355888 f(86-512)57370818 www.sgsgroup.com.cn  
 t(86-512)57355888 f(86-512)57370818 sgs.china@sgs.com

Test Mode: 01; Polarity: Horizontal; Modulation:802.11n; Bandwidth:40MHz; Channel:Low

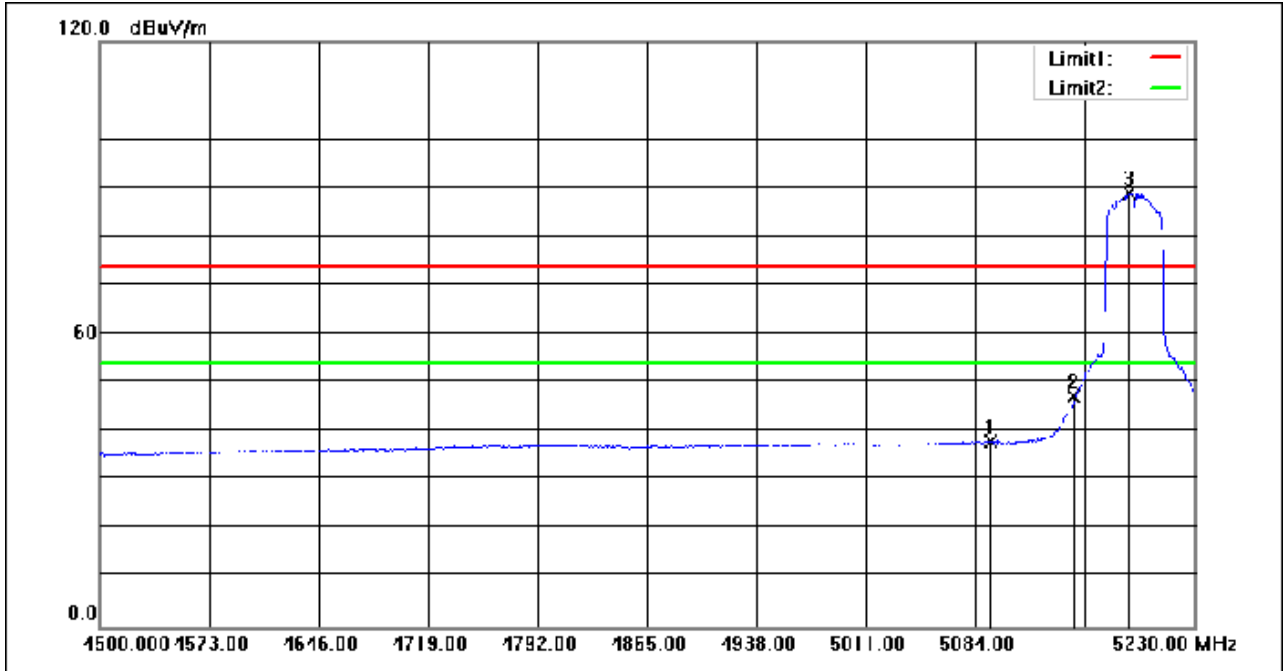

No.	Frequency (MHz)	Reading (dBuV)	Correction factor(dB/m)	Result (dBuV/m)	Limit (dBuV/m)	Margin (dB)	Remark
1	5094.220	48.68	-10.63	38.05	54.00	-15.95	AVG
2	5150.000	57.77	-10.64	47.13	54.00	-6.87	AVG
3	5186.930	99.53	-10.65	88.88	54.00	34.88	AVG



Unless otherwise agreed in writing, this document is issued by the Company subject to its General Conditions of Service printed overleaf, available on request or accessible at <http://www.sgs.com/en/Terms-and-Conditions.aspx> and, for electronic format documents, subject to Terms and Conditions for Electronic Documents at <http://www.sgs.com/en/Terms-and-Conditions/Terms-e-Documents.aspx>. Attention is drawn to the limitation of liability, indemnification and jurisdiction issues defined therein. Any holder of this document is advised that information contained hereon reflects the Company's findings at the time of its intervention only and within the limits of Client's instructions, if any. The Company's sole responsibility is to its Client and this document does not exonerate parties to a transaction from exercising all their rights and obligations under the transaction documents. This document cannot be reproduced except in full, without prior written approval of the Company. Any unauthorized alteration, forgery or falsification of the content or appearance of this document is unlawful and offenders may be prosecuted to the fullest extent of the law. Unless otherwise stated the results shown in this test report refer only to the sample(s) tested and such sample(s) are retained for 30 days only.  
**Attention: To check the authenticity of testing /inspection report & certificate, please contact us at telephone: (86-755) 8307 1443, or email: CN.Doccheck@sgs.com**

No.10, Weiye Road, Innovation Park, Kunshan, Jiangsu, China 215300  
 中国·江苏·昆山市留学生创业园伟业路10号 邮编 215300

t(86-512)57355888 f(86-512)57370818 www.sgsgroup.com.cn  
 t(86-512)57355888 f(86-512)57370818 sgs.china@sgs.com

Test Mode: 01; Polarity: Vertical; Modulation:802.11n; Bandwidth:40MHz; Channel:Low

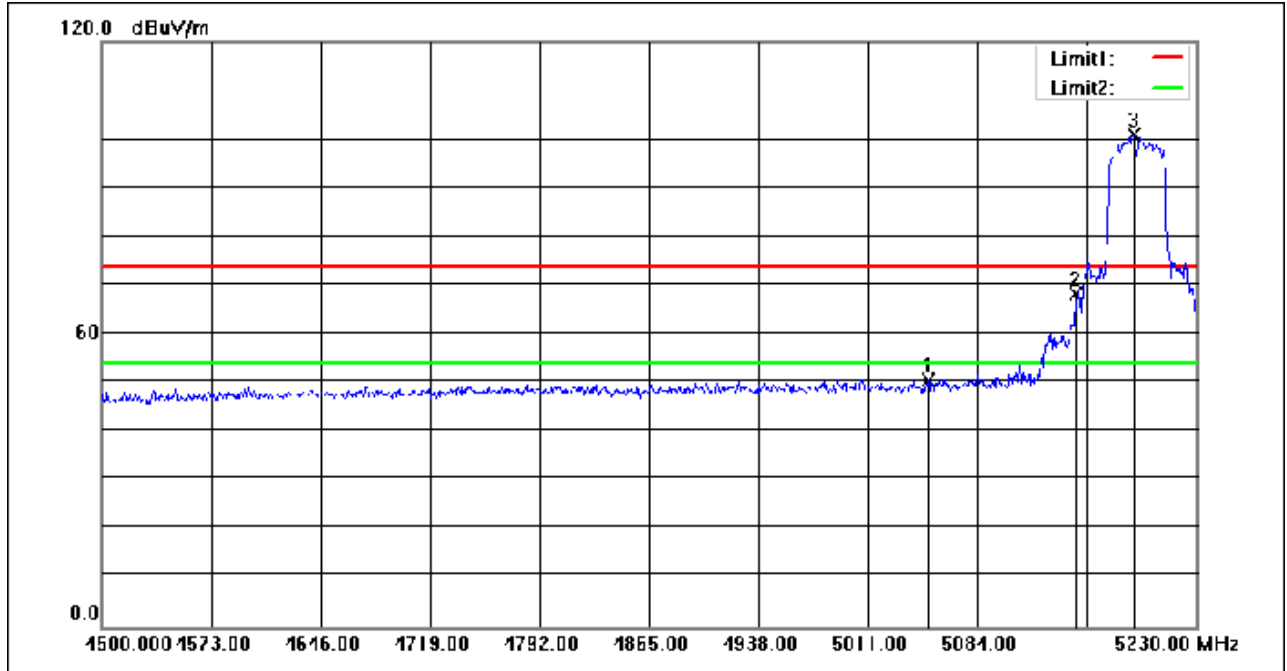

No.	Frequency (MHz)	Reading (dBuV)	Correction factor(dB/m)	Result (dBuV/m)	Limit (dBuV/m)	Margin (dB)	Remark
1	5051.150	61.22	-10.62	50.60	74.00	-23.40	peak
2	5150.000	78.93	-10.64	68.29	74.00	-5.71	peak
3	5188.390	111.49	-10.65	100.84	74.00	26.84	peak



Unless otherwise agreed in writing, this document is issued by the Company subject to its General Conditions of Service printed overleaf, available on request or accessible at <http://www.sgs.com/en/Terms-and-Conditions.aspx> and, for electronic format documents, subject to Terms and Conditions for Electronic Documents at <http://www.sgs.com/en/Terms-and-Conditions/Terms-e-Documents.aspx>. Attention is drawn to the limitation of liability, indemnification and jurisdiction issues defined therein. Any holder of this document is advised that information contained hereon reflects the Company's findings at the time of its intervention only and within the limits of Client's instructions, if any. The Company's sole responsibility is to its Client and this document does not exonerate parties to a transaction from exercising all their rights and obligations under the transaction documents. This document cannot be reproduced except in full, without prior written approval of the Company. Any unauthorized alteration, forgery or falsification of the content or appearance of this document is unlawful and offenders may be prosecuted to the fullest extent of the law. Unless otherwise stated the results shown in this test report refer only to the sample(s) tested and such sample(s) are retained for 30 days only.  
**Attention: To check the authenticity of testing /inspection report & certificate, please contact us at telephone: (86-755) 8307 1443, or email: CN.Doccheck@sgs.com**

No.10, Weiye Road, Innovation Park, Kunshan, Jiangsu, China 215300  
 中国·江苏·昆山市留学生创业园伟业路10号 邮编 215300

t(86-512)57355888 f(86-512)57370818 www.sgsgroup.com.cn  
 t(86-512)57355888 f(86-512)57370818 sgs.china@sgs.com



Test Mode: 01; Polarity: Vertical; Modulation:802.11n; Bandwidth:40MHz; Channel:Low

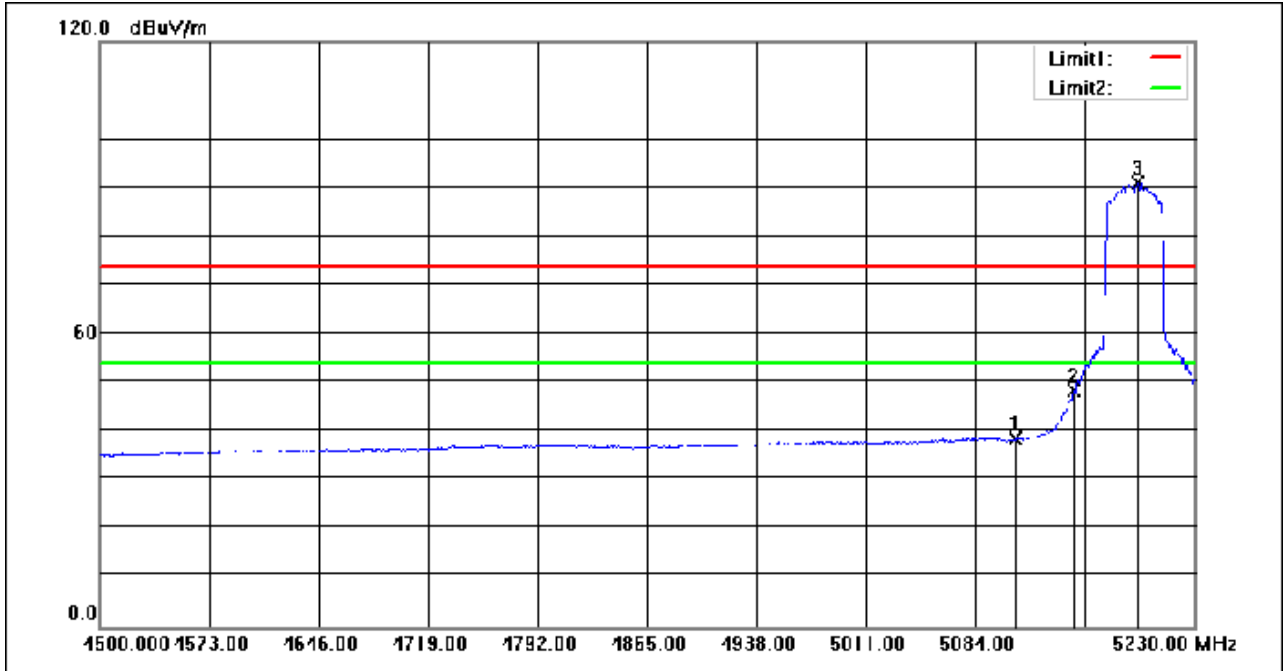

No.	Frequency (MHz)	Reading (dBuV)	Correction factor(dB/m)	Result (dBuV/m)	Limit (dBuV/m)	Margin (dB)	Remark
1	5111.010	49.11	-10.63	38.48	54.00	-15.52	AVG
2	5150.000	59.10	-10.64	48.46	54.00	-5.54	AVG
3	5192.770	101.66	-10.65	91.01	54.00	37.01	AVG



Unless otherwise agreed in writing, this document is issued by the Company subject to its General Conditions of Service printed overleaf, available on request or accessible at <http://www.sgs.com/en/Terms-and-Conditions.aspx> and, for electronic format documents, subject to Terms and Conditions for Electronic Documents at <http://www.sgs.com/en/Terms-and-Conditions/Terms-e-Documents.aspx>. Attention is drawn to the limitation of liability, indemnification and jurisdiction issues defined therein. Any holder of this document is advised that information contained hereon reflects the Company's findings at the time of its intervention only and within the limits of Client's instructions, if any. The Company's sole responsibility is to its Client and this document does not exonerate parties to a transaction from exercising all their rights and obligations under the transaction documents. This document cannot be reproduced except in full, without prior written approval of the Company. Any unauthorized alteration, forgery or falsification of the content or appearance of this document is unlawful and offenders may be prosecuted to the fullest extent of the law. Unless otherwise stated the results shown in this test report refer only to the sample(s) tested and such sample(s) are retained for 30 days only.  
**Attention: To check the authenticity of testing /inspection report & certificate, please contact us at telephone: (86-755) 8307 1443, or email: CN.Doccheck@sgs.com**

No.10, Weiye Road, Innovation Park, Kunshan, Jiangsu, China 215300  
 中国·江苏·昆山市留学生创业园伟业路10号 邮编 215300

t(86-512)57355888 f(86-512)57370818 www.sgsgroup.com.cn  
 t(86-512)57355888 f(86-512)57370818 sgs.china@sgs.com

Test Mode: 01; Polarity: Horizontal; Modulation:802.11ac; Bandwidth:20MHz; Channel:Low

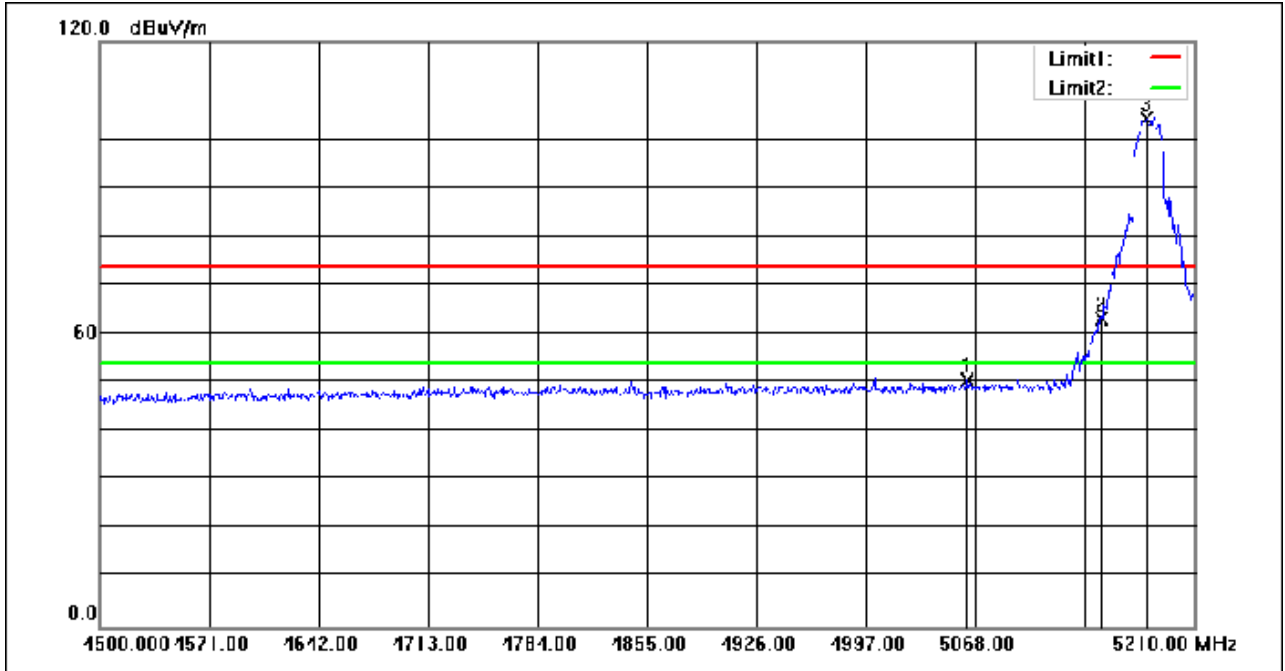

No.	Frequency (MHz)	Reading (dBuV)	Correction factor(dB/m)	Result (dBuV/m)	Limit (dBuV/m)	Margin (dB)	Remark
1	5063.030	61.25	-10.62	50.63	74.00	-23.37	peak
2	5150.000	73.70	-10.64	63.06	74.00	-10.94	peak
3	5179.470	114.83	-10.64	104.19	74.00	30.19	peak



Unless otherwise agreed in writing, this document is issued by the Company subject to its General Conditions of Service printed overleaf, available on request or accessible at <http://www.sgs.com/en/Terms-and-Conditions.aspx> and, for electronic format documents, subject to Terms and Conditions for Electronic Documents at <http://www.sgs.com/en/Terms-and-Conditions/Terms-e-Documents.aspx>. Attention is drawn to the limitation of liability, indemnification and jurisdiction issues defined therein. Any holder of this document is advised that information contained hereon reflects the Company's findings at the time of its intervention only and within the limits of Client's instructions, if any. The Company's sole responsibility is to its Client and this document does not exonerate parties to a transaction from exercising all their rights and obligations under the transaction documents. This document cannot be reproduced except in full, without prior written approval of the Company. Any unauthorized alteration, forgery or falsification of the content or appearance of this document is unlawful and offenders may be prosecuted to the fullest extent of the law. Unless otherwise stated the results shown in this test report refer only to the sample(s) tested and such sample(s) are retained for 30 days only.  
**Attention: To check the authenticity of testing /inspection report & certificate, please contact us at telephone: (86-755) 8307 1443, or email: CN.Doccheck@sgs.com**

No.10, Weiye Road, Innovation Park, Kunshan, Jiangsu, China 215300  
 中国·江苏·昆山市留学生创业园伟业路10号 邮编 215300

t(86-512)57355888 f(86-512)57370818 www.sgsgroup.com.cn  
 t(86-512)57355888 f(86-512)57370818 sgs.china@sgs.com

Test Mode: 01; Polarity: Horizontal; Modulation:802.11ac; Bandwidth:20MHz; Channel:Low

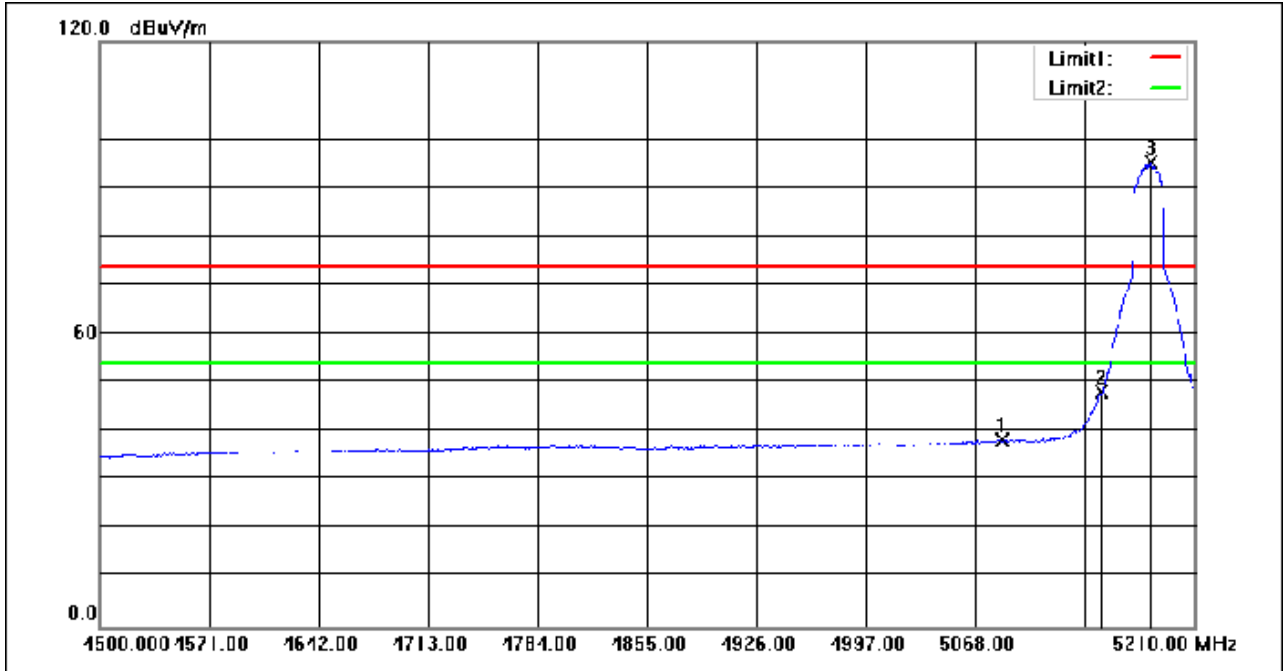

No.	Frequency (MHz)	Reading (dBuV)	Correction factor(dB/m)	Result (dBuV/m)	Limit (dBuV/m)	Margin (dB)	Remark
1	5085.750	48.84	-10.63	38.21	54.00	-15.79	AVG
2	5150.000	58.85	-10.64	48.21	54.00	-5.79	AVG
3	5181.600	105.92	-10.64	95.28	54.00	41.28	AVG



Unless otherwise agreed in writing, this document is issued by the Company subject to its General Conditions of Service printed overleaf, available on request or accessible at <http://www.sgs.com/en/Terms-and-Conditions.aspx> and, for electronic format documents, subject to Terms and Conditions for Electronic Documents at <http://www.sgs.com/en/Terms-and-Conditions/Terms-e-Documents.aspx>. Attention is drawn to the limitation of liability, indemnification and jurisdiction issues defined therein. Any holder of this document is advised that information contained hereon reflects the Company's findings at the time of its intervention only and within the limits of Client's instructions, if any. The Company's sole responsibility is to its Client and this document does not exonerate parties to a transaction from exercising all their rights and obligations under the transaction documents. This document cannot be reproduced except in full, without prior written approval of the Company. Any unauthorized alteration, forgery or falsification of the content or appearance of this document is unlawful and offenders may be prosecuted to the fullest extent of the law. Unless otherwise stated the results shown in this test report refer only to the sample(s) tested and such sample(s) are retained for 30 days only.  
**Attention: To check the authenticity of testing /inspection report & certificate, please contact us at telephone: (86-755) 8307 1443, or email: CN.Doccheck@sgs.com**

No.10, Weiye Road, Innovation Park, Kunshan, Jiangsu, China 215300  
 中国·江苏·昆山市留学生创业园伟业路10号 邮编 215300

t(86-512)57355888 f(86-512)57370818 www.sgsgroup.com.cn  
 t(86-512)57355888 f(86-512)57370818 sgs.china@sgs.com

Test Mode: 01; Polarity: Vertical; Modulation:802.11ac; Bandwidth:20MHz; Channel:Low

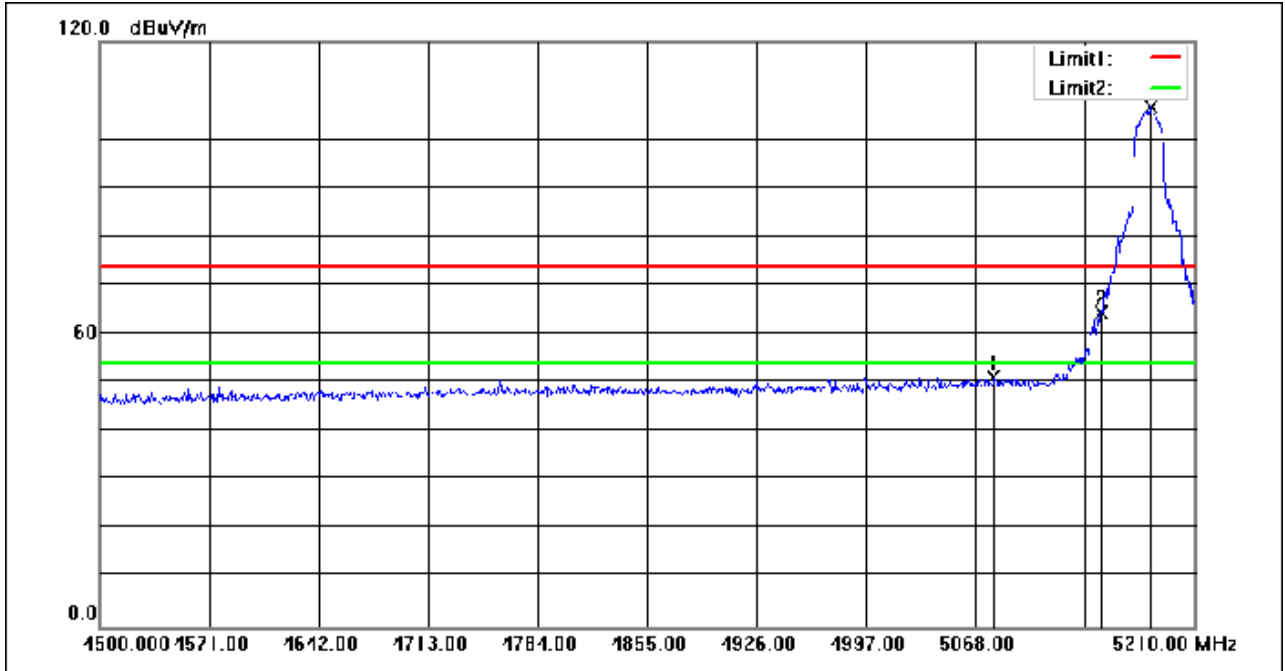

No.	Frequency (MHz)	Reading (dBuV)	Correction factor(dB/m)	Result (dBuV/m)	Limit (dBuV/m)	Margin (dB)	Remark
1	5080.070	61.83	-10.63	51.20	74.00	-22.80	peak
2	5150.000	75.00	-10.64	64.36	74.00	-9.64	peak
3	5181.600	117.15	-10.64	106.51	74.00	32.51	peak



Unless otherwise agreed in writing, this document is issued by the Company subject to its General Conditions of Service printed overleaf, available on request or accessible at <http://www.sgs.com/en/Terms-and-Conditions.aspx> and, for electronic format documents, subject to Terms and Conditions for Electronic Documents at <http://www.sgs.com/en/Terms-and-Conditions/Terms-e-Documents.aspx>. Attention is drawn to the limitation of liability, indemnification and jurisdiction issues defined therein. Any holder of this document is advised that information contained hereon reflects the Company's findings at the time of its intervention only and within the limits of Client's instructions, if any. The Company's sole responsibility is to its Client and this document does not exonerate parties to a transaction from exercising all their rights and obligations under the transaction documents. This document cannot be reproduced except in full, without prior written approval of the Company. Any unauthorized alteration, forgery or falsification of the content or appearance of this document is unlawful and offenders may be prosecuted to the fullest extent of the law. Unless otherwise stated the results shown in this test report refer only to the sample(s) tested and such sample(s) are retained for 30 days only.  
**Attention: To check the authenticity of testing /inspection report & certificate, please contact us at telephone: (86-755) 8307 1443, or email: CN.Doccheck@sgs.com**

No.10, Weiye Road, Innovation Park, Kunshan, Jiangsu, China 215300  
 中国·江苏·昆山市留学生创业园伟业路10号 邮编 215300

t(86-512)57355888 f(86-512)57370818 www.sgsgroup.com.cn  
 t(86-512)57355888 f(86-512)57370818 sgs.china@sgs.com

Test Mode: 01; Polarity: Vertical; Modulation:802.11ac; Bandwidth:20MHz; Channel:Low

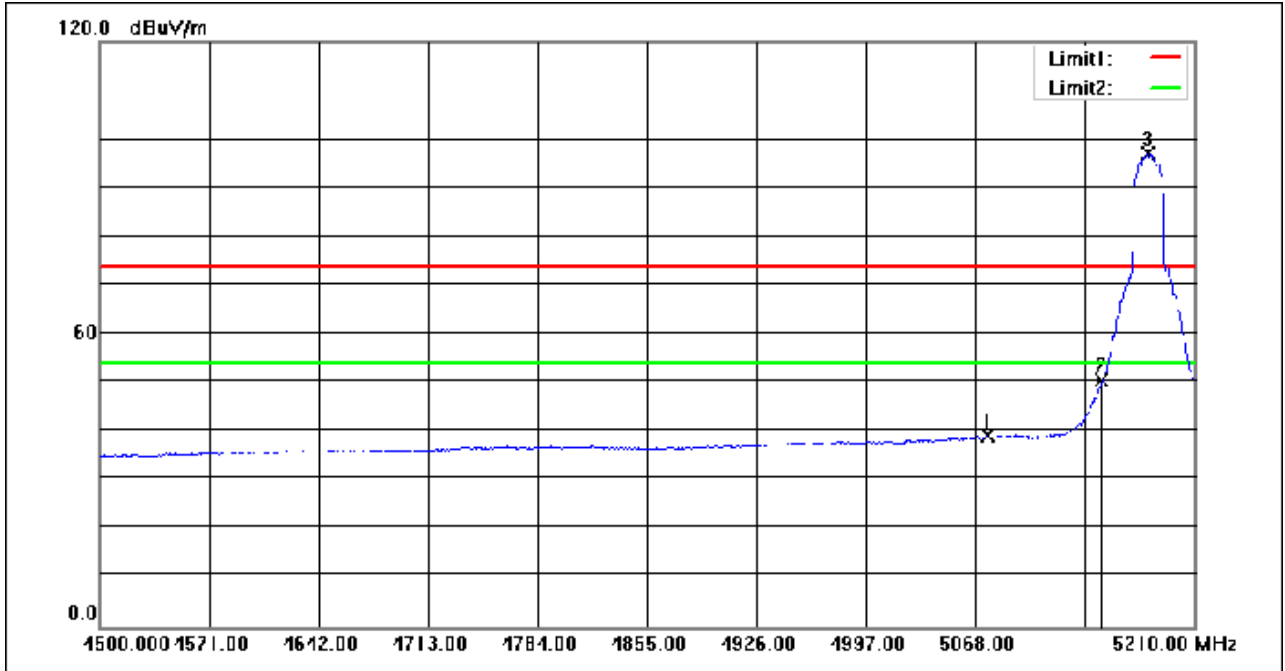

No.	Frequency (MHz)	Reading (dBuV)	Correction factor(dB/m)	Result (dBuV/m)	Limit (dBuV/m)	Margin (dB)	Remark
1	5075.810	49.89	-10.63	39.26	54.00	-14.74	AVG
2	5150.000	61.22	-10.64	50.58	54.00	-3.42	AVG
3	5180.180	107.72	-10.64	97.08	54.00	43.08	AVG



Unless otherwise agreed in writing, this document is issued by the Company subject to its General Conditions of Service printed overleaf, available on request or accessible at <http://www.sgs.com/en/Terms-and-Conditions.aspx> and, for electronic format documents, subject to Terms and Conditions for Electronic Documents at <http://www.sgs.com/en/Terms-and-Conditions/Terms-e-Documents.aspx>. Attention is drawn to the limitation of liability, indemnification and jurisdiction issues defined therein. Any holder of this document is advised that information contained hereon reflects the Company's findings at the time of its intervention only and within the limits of Client's instructions, if any. The Company's sole responsibility is to its Client and this document does not exonerate parties to a transaction from exercising all their rights and obligations under the transaction documents. This document cannot be reproduced except in full, without prior written approval of the Company. Any unauthorized alteration, forgery or falsification of the content or appearance of this document is unlawful and offenders may be prosecuted to the fullest extent of the law. Unless otherwise stated the results shown in this test report refer only to the sample(s) tested and such sample(s) are retained for 30 days only.  
**Attention: To check the authenticity of testing /inspection report & certificate, please contact us at telephone: (86-755) 8307 1443, or email: CN.Doccheck@sgs.com**

No.10, Weiye Road, Innovation Park, Kunshan, Jiangsu, China 215300  
 中国·江苏·昆山市留学生创业园伟业路10号 邮编 215300

t(86-512)57355888 f(86-512)57370818 www.sgsgroup.com.cn  
 t(86-512)57355888 f(86-512)57370818 sgs.china@sgs.com



Test Mode: 01; Polarity: Horizontal; Modulation:802.11ac; Bandwidth:40MHz; Channel:Low

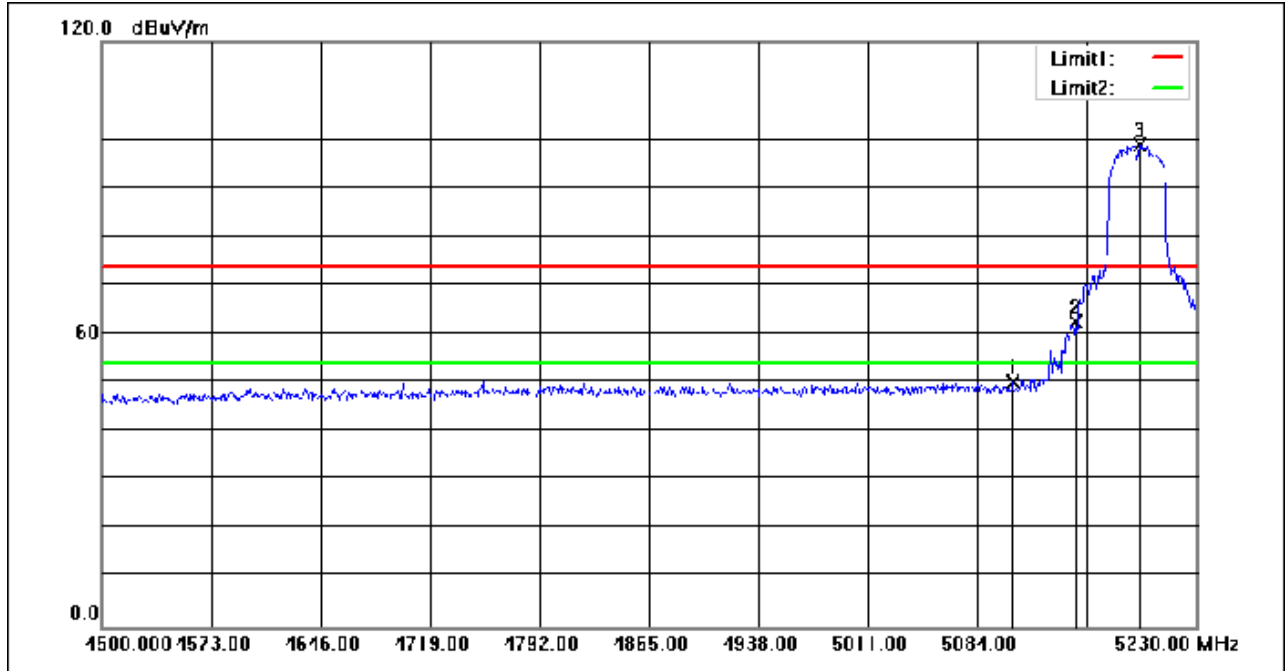

No.	Frequency (MHz)	Reading (dBuV)	Correction factor(dB/m)	Result (dBuV/m)	Limit (dBuV/m)	Margin (dB)	Remark
1	5107.360	60.79	-10.63	50.16	74.00	-23.84	peak
2	5150.000	73.07	-10.64	62.43	74.00	-11.57	peak
3	5192.770	109.58	-10.65	98.93	74.00	24.93	peak



Unless otherwise agreed in writing, this document is issued by the Company subject to its General Conditions of Service printed overleaf, available on request or accessible at <http://www.sgs.com/en/Terms-and-Conditions.aspx> and, for electronic format documents, subject to Terms and Conditions for Electronic Documents at <http://www.sgs.com/en/Terms-and-Conditions/Terms-e-Documents.aspx>. Attention is drawn to the limitation of liability, indemnification and jurisdiction issues defined therein. Any holder of this document is advised that information contained hereon reflects the Company's findings at the time of its intervention only and within the limits of Client's instructions, if any. The Company's sole responsibility is to its Client and this document does not exonerate parties to a transaction from exercising all their rights and obligations under the transaction documents. This document cannot be reproduced except in full, without prior written approval of the Company. Any unauthorized alteration, forgery or falsification of the content or appearance of this document is unlawful and offenders may be prosecuted to the fullest extent of the law. Unless otherwise stated the results shown in this test report refer only to the sample(s) tested and such sample(s) are retained for 30 days only.  
**Attention: To check the authenticity of testing /inspection report & certificate, please contact us at telephone: (86-755) 8307 1443, or email: CN.Doccheck@sgs.com**

No.10, Weiye Road, Innovation Park, Kunshan, Jiangsu, China 215300  
 中国·江苏·昆山市留学生创业园伟业路10号 邮编 215300

t(86-512)57355888 f(86-512)57370818 www.sgsgroup.com.cn  
 t(86-512)57355888 f(86-512)57370818 sgs.china@sgs.com

Test Mode: 01; Polarity: Horizontal; Modulation:802.11ac; Bandwidth:40MHz; Channel:Low

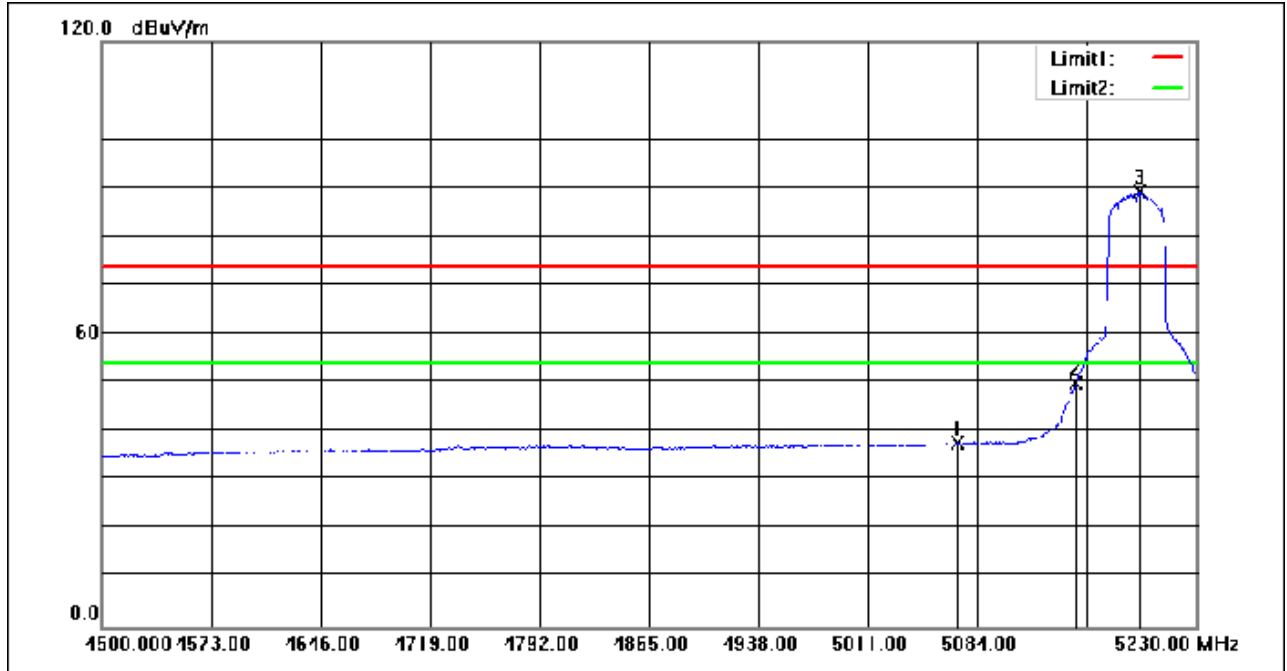

No.	Frequency (MHz)	Reading (dBuV)	Correction factor(dB/m)	Result (dBuV/m)	Limit (dBuV/m)	Margin (dB)	Remark
1	5070.860	48.37	-10.62	37.75	54.00	-16.25	AVG
2	5150.000	60.65	-10.64	50.01	54.00	-3.99	AVG
3	5192.040	99.93	-10.65	89.28	54.00	35.28	AVG



Unless otherwise agreed in writing, this document is issued by the Company subject to its General Conditions of Service printed overleaf, available on request or accessible at <http://www.sgs.com/en/Terms-and-Conditions.aspx> and, for electronic format documents, subject to Terms and Conditions for Electronic Documents at <http://www.sgs.com/en/Terms-and-Conditions/Terms-e-Documents.aspx>. Attention is drawn to the limitation of liability, indemnification and jurisdiction issues defined therein. Any holder of this document is advised that information contained hereon reflects the Company's findings at the time of its intervention only and within the limits of Client's instructions, if any. The Company's sole responsibility is to its Client and this document does not exonerate parties to a transaction from exercising all their rights and obligations under the transaction documents. This document cannot be reproduced except in full, without prior written approval of the Company. Any unauthorized alteration, forgery or falsification of the content or appearance of this document is unlawful and offenders may be prosecuted to the fullest extent of the law. Unless otherwise stated the results shown in this test report refer only to the sample(s) tested and such sample(s) are retained for 30 days only.  
**Attention: To check the authenticity of testing /inspection report & certificate, please contact us at telephone: (86-755) 8307 1443, or email: CN.Doccheck@sgs.com**

No.10, Weiye Road, Innovation Park, Kunshan, Jiangsu, China 215300  
 中国·江苏·昆山市留学生创业园伟业路10号 邮编 215300

t(86-512)57355888 f(86-512)57370818 www.sgs.com.cn  
 t(86-512)57355888 f(86-512)57370818 sgs.china@sgs.com

Test Mode: 01; Polarity: Vertical; Modulation:802.11ac; Bandwidth:40MHz; Channel:Low

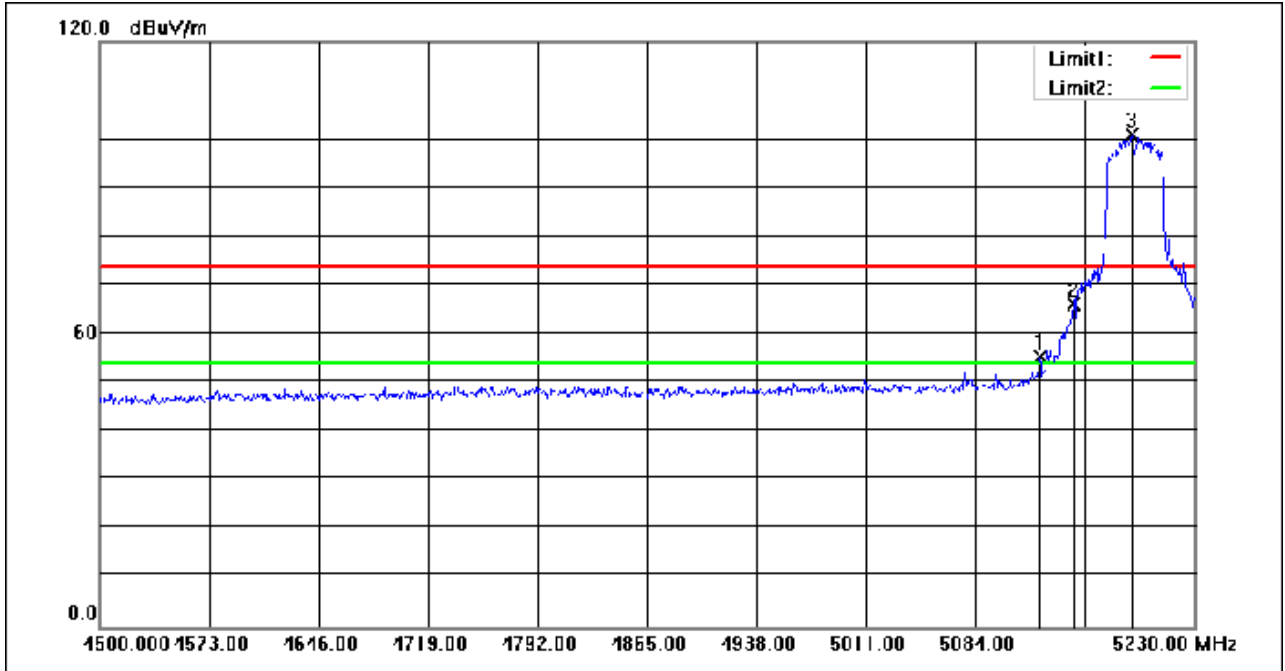

No.	Frequency (MHz)	Reading (dBuV)	Correction factor(dB/m)	Result (dBuV/m)	Limit (dBuV/m)	Margin (dB)	Remark
1	5127.070	66.01	-10.63	55.38	74.00	-18.62	peak
2	5150.000	76.83	-10.64	66.19	74.00	-7.81	peak
3	5188.390	111.47	-10.65	100.82	74.00	26.82	peak



Unless otherwise agreed in writing, this document is issued by the Company subject to its General Conditions of Service printed overleaf, available on request or accessible at <http://www.sgs.com/en/Terms-and-Conditions.aspx> and, for electronic format documents, subject to Terms and Conditions for Electronic Documents at <http://www.sgs.com/en/Terms-and-Conditions/Terms-e-Documents.aspx>. Attention is drawn to the limitation of liability, indemnification and jurisdiction issues defined therein. Any holder of this document is advised that information contained hereon reflects the Company's findings at the time of its intervention only and within the limits of Client's instructions, if any. The Company's sole responsibility is to its Client and this document does not exonerate parties to a transaction from exercising all their rights and obligations under the transaction documents. This document cannot be reproduced except in full, without prior written approval of the Company. Any unauthorized alteration, forgery or falsification of the content or appearance of this document is unlawful and offenders may be prosecuted to the fullest extent of the law. Unless otherwise stated the results shown in this test report refer only to the sample(s) tested and such sample(s) are retained for 30 days only.  
**Attention: To check the authenticity of testing /inspection report & certificate, please contact us at telephone: (86-755) 8307 1443, or email: CN.Doccheck@sgs.com**

No.10, Weiye Road, Innovation Park, Kunshan, Jiangsu, China 215300  
 中国·江苏·昆山市留学生创业园伟业路10号 邮编 215300

t(86-512)57355888 f(86-512)57370818 www.sgsgroup.com.cn  
 t(86-512)57355888 f(86-512)57370818 sgs.china@sgs.com

Test Mode: 01; Polarity: Vertical; Modulation:802.11ac; Bandwidth:40MHz; Channel:Low

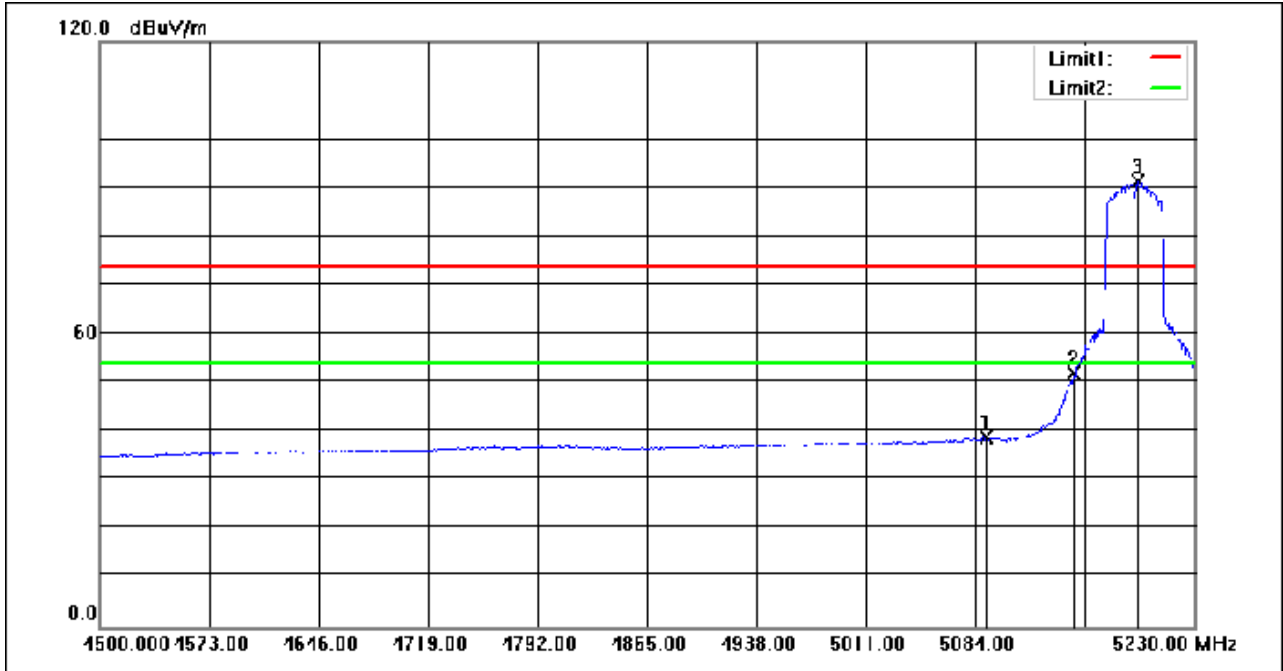

No.	Frequency (MHz)	Reading (dBuV)	Correction factor(dB/m)	Result (dBuV/m)	Limit (dBuV/m)	Margin (dB)	Remark
1	5091.300	49.52	-10.63	38.89	54.00	-15.11	AVG
2	5150.000	62.56	-10.64	51.92	54.00	-2.08	AVG
3	5192.770	102.02	-10.65	91.37	54.00	37.37	AVG



Unless otherwise agreed in writing, this document is issued by the Company subject to its General Conditions of Service printed overleaf, available on request or accessible at <http://www.sgs.com/en/Terms-and-Conditions.aspx> and, for electronic format documents, subject to Terms and Conditions for Electronic Documents at <http://www.sgs.com/en/Terms-and-Conditions/Terms-e-Documents.aspx>. Attention is drawn to the limitation of liability, indemnification and jurisdiction issues defined therein. Any holder of this document is advised that information contained hereon reflects the Company's findings at the time of its intervention only and within the limits of Client's instructions, if any. The Company's sole responsibility is to its Client and this document does not exonerate parties to a transaction from exercising all their rights and obligations under the transaction documents. This document cannot be reproduced except in full, without prior written approval of the Company. Any unauthorized alteration, forgery or falsification of the content or appearance of this document is unlawful and offenders may be prosecuted to the fullest extent of the law. Unless otherwise stated the results shown in this test report refer only to the sample(s) tested and such sample(s) are retained for 30 days only.  
**Attention: To check the authenticity of testing /inspection report & certificate, please contact us at telephone: (86-755) 8307 1443, or email: CN.Doccheck@sgs.com**

No.10, Weiye Road, Innovation Park, Kunshan, Jiangsu, China 215300  
 中国·江苏·昆山市留学生创业园伟业路10号 邮编 215300

t(86-512)57355888 f(86-512)57370818 www.sgsgroup.com.cn  
 t(86-512)57355888 f(86-512)57370818 sgs.china@sgs.com

Test Mode: 01; Polarity: Horizontal; Modulation:802.11ac; Bandwidth:80MHz; Channel:Low

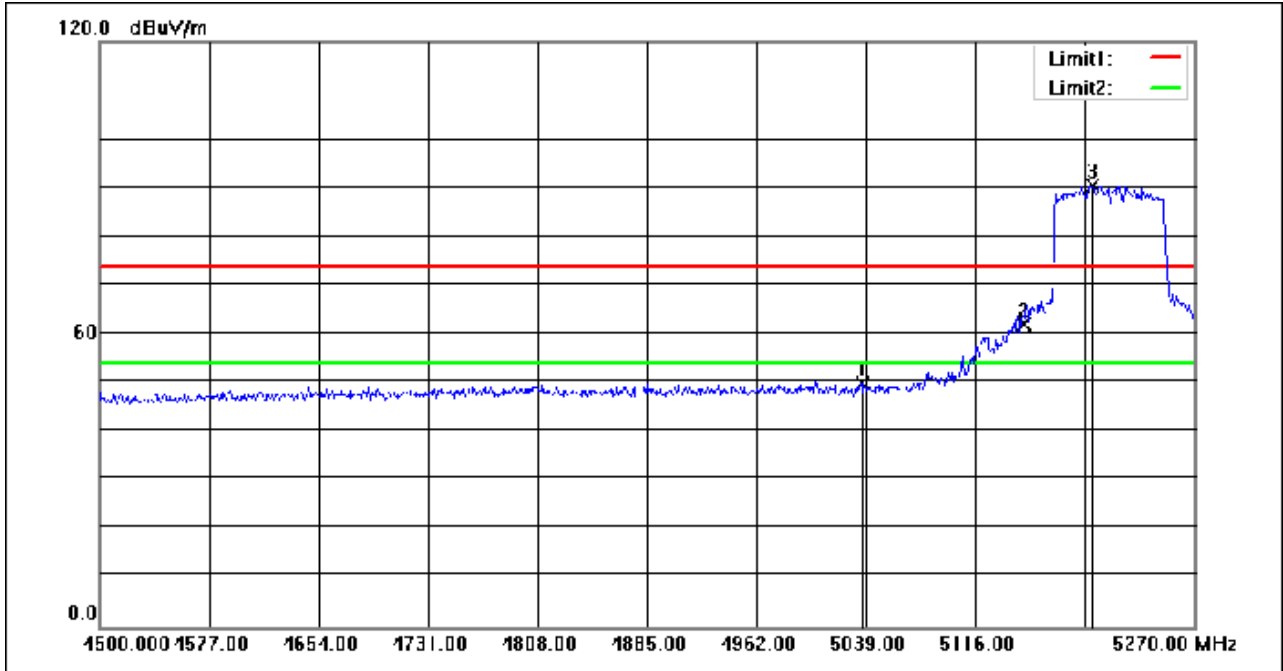

No.	Frequency (MHz)	Reading (dBuV)	Correction factor(dB/m)	Result (dBuV/m)	Limit (dBuV/m)	Margin (dB)	Remark
1	5035.920	60.57	-10.61	49.96	74.00	-24.04	peak
2	5150.000	72.58	-10.64	61.94	74.00	-12.06	peak
3	5198.390	101.25	-10.65	90.60	74.00	16.60	peak



Unless otherwise agreed in writing, this document is issued by the Company subject to its General Conditions of Service printed overleaf, available on request or accessible at <http://www.sgs.com/en/Terms-and-Conditions.aspx> and, for electronic format documents, subject to Terms and Conditions for Electronic Documents at <http://www.sgs.com/en/Terms-and-Conditions/Terms-e-Documents.aspx>. Attention is drawn to the limitation of liability, indemnification and jurisdiction issues defined therein. Any holder of this document is advised that information contained hereon reflects the Company's findings at the time of its intervention only and within the limits of Client's instructions, if any. The Company's sole responsibility is to its Client and this document does not exonerate parties to a transaction from exercising all their rights and obligations under the transaction documents. This document cannot be reproduced except in full, without prior written approval of the Company. Any unauthorized alteration, forgery or falsification of the content or appearance of this document is unlawful and offenders may be prosecuted to the fullest extent of the law. Unless otherwise stated the results shown in this test report refer only to the sample(s) tested and such sample(s) are retained for 30 days only.  
**Attention: To check the authenticity of testing /inspection report & certificate, please contact us at telephone: (86-755) 8307 1443, or email: CN.Doccheck@sgs.com**

No.10, Weiye Road, Innovation Park, Kunshan, Jiangsu, China 215300  
 中国·江苏·昆山市留学生创业园伟业路10号 邮编 215300

t(86-512)57355888 f(86-512)57370818 www.sgsgroup.com.cn  
 t(86-512)57355888 f(86-512)57370818 sgs.china@sgs.com



Test Mode: 01; Polarity: Horizontal; Modulation:802.11ac; Bandwidth:80MHz; Channel:Low

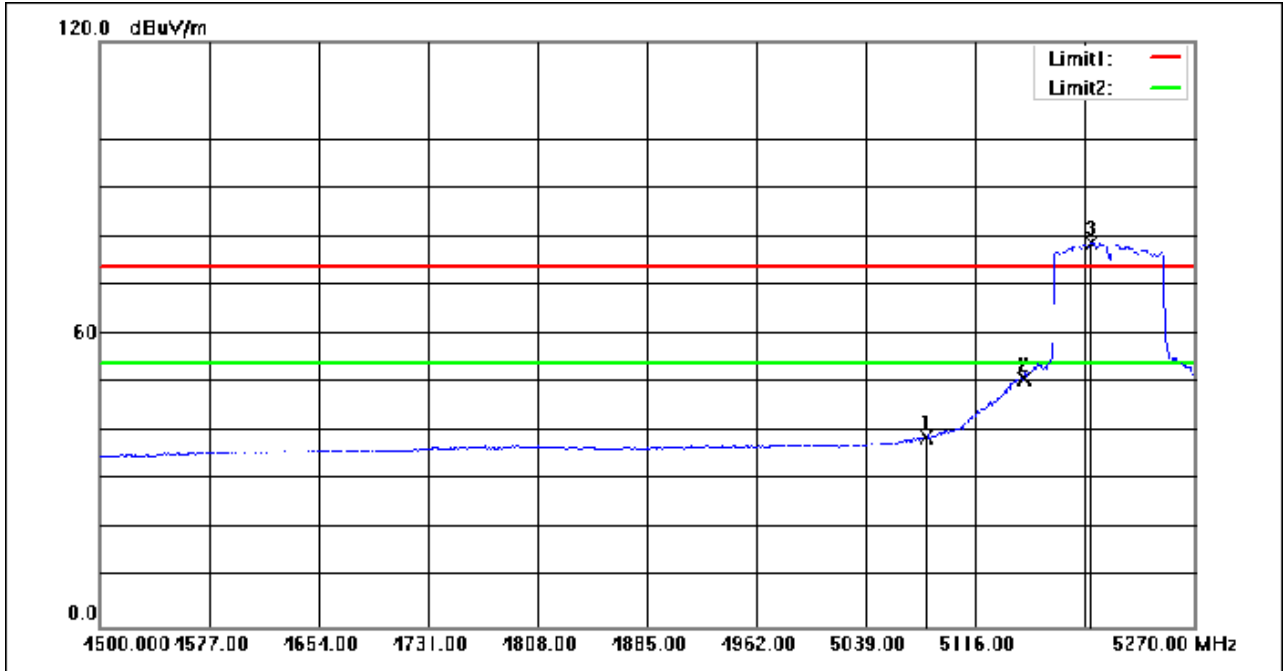

No.	Frequency (MHz)	Reading (dBuV)	Correction factor(dB/m)	Result (dBuV/m)	Limit (dBuV/m)	Margin (dB)	Remark
1	5081.350	49.49	-10.63	38.86	54.00	-15.14	AVG
2	5150.000	61.56	-10.64	50.92	54.00	-3.08	AVG
3	5197.620	89.35	-10.65	78.70	54.00	24.70	AVG



Unless otherwise agreed in writing, this document is issued by the Company subject to its General Conditions of Service printed overleaf, available on request or accessible at <http://www.sgs.com/en/Terms-and-Conditions.aspx> and, for electronic format documents, subject to Terms and Conditions for Electronic Documents at <http://www.sgs.com/en/Terms-and-Conditions/Terms-e-Documents.aspx>. Attention is drawn to the limitation of liability, indemnification and jurisdiction issues defined therein. Any holder of this document is advised that information contained hereon reflects the Company's findings at the time of its intervention only and within the limits of Client's instructions, if any. The Company's sole responsibility is to its Client and this document does not exonerate parties to a transaction from exercising all their rights and obligations under the transaction documents. This document cannot be reproduced except in full, without prior written approval of the Company. Any unauthorized alteration, forgery or falsification of the content or appearance of this document is unlawful and offenders may be prosecuted to the fullest extent of the law. Unless otherwise stated the results shown in this test report refer only to the sample(s) tested and such sample(s) are retained for 30 days only.  
**Attention: To check the authenticity of testing /inspection report & certificate, please contact us at telephone: (86-755) 8307 1443, or email: CN.Doccheck@sgs.com**

No.10, Weiye Road, Innovation Park, Kunshan, Jiangsu, China 215300  
 中国·江苏·昆山市留学生创业园伟业路10号 邮编 215300

t(86-512)57355888 f(86-512)57370818 www.sgsgroup.com.cn  
 t(86-512)57355888 f(86-512)57370818 sgs.china@sgs.com

Test Mode: 01; Polarity: Vertical; Modulation:802.11ac; Bandwidth:80MHz; Channel:Low

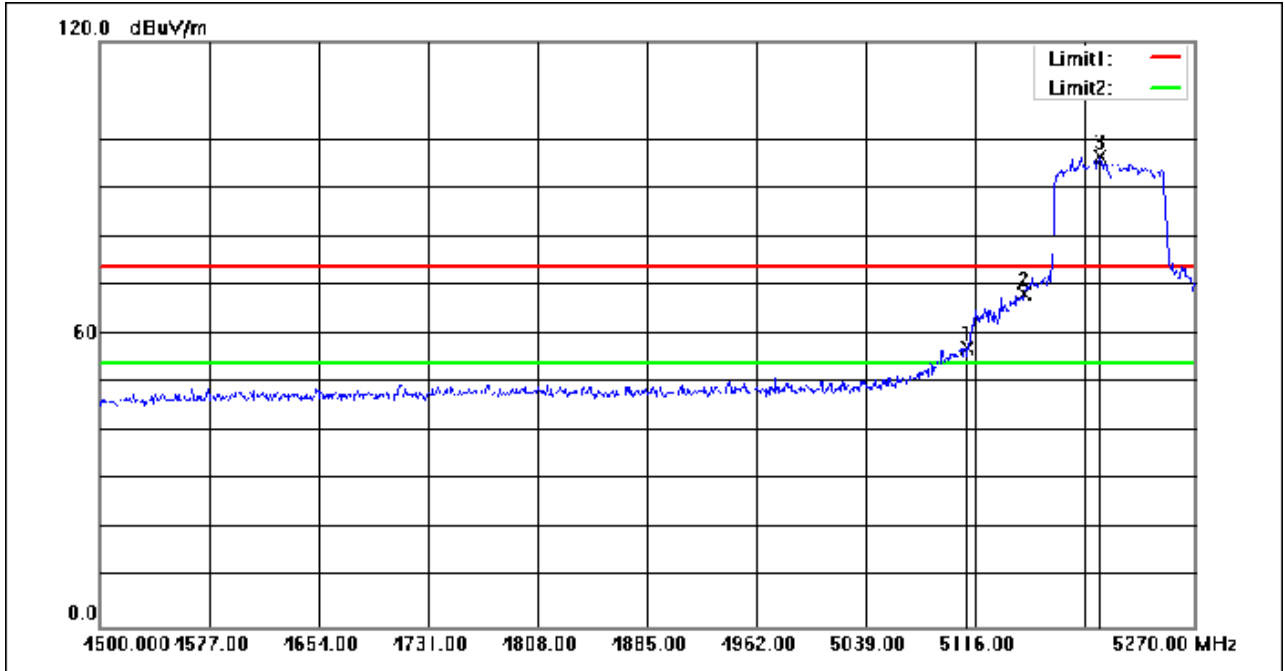

No.	Frequency (MHz)	Reading (dBuV)	Correction factor(dB/m)	Result (dBuV/m)	Limit (dBuV/m)	Margin (dB)	Remark
1	5110.610	67.81	-10.63	57.18	74.00	-16.82	peak
2	5150.000	78.79	-10.64	68.15	74.00	-5.85	peak
3	5203.780	106.99	-10.63	96.36	74.00	22.36	peak



Unless otherwise agreed in writing, this document is issued by the Company subject to its General Conditions of Service printed overleaf, available on request or accessible at <http://www.sgs.com/en/Terms-and-Conditions.aspx> and, for electronic format documents, subject to Terms and Conditions for Electronic Documents at <http://www.sgs.com/en/Terms-and-Conditions/Terms-e-Documents.aspx>. Attention is drawn to the limitation of liability, indemnification and jurisdiction issues defined therein. Any holder of this document is advised that information contained hereon reflects the Company's findings at the time of its intervention only and within the limits of Client's instructions, if any. The Company's sole responsibility is to its Client and this document does not exonerate parties to a transaction from exercising all their rights and obligations under the transaction documents. This document cannot be reproduced except in full, without prior written approval of the Company. Any unauthorized alteration, forgery or falsification of the content or appearance of this document is unlawful and offenders may be prosecuted to the fullest extent of the law. Unless otherwise stated the results shown in this test report refer only to the sample(s) tested and such sample(s) are retained for 30 days only.  
**Attention: To check the authenticity of testing /inspection report & certificate, please contact us at telephone: (86-755) 8307 1443, or email: CN\_Doccheck@sgs.com**

No.10, Weiye Road, Innovation Park, Kunshan, Jiangsu, China 215300  
 中国·江苏·昆山市留学生创业园伟业路10号 邮编 215300

t(86-512)57355888 f(86-512)57370818 www.sgsgroup.com.cn  
 t(86-512)57355888 f(86-512)57370818 sgs.china@sgs.com

Test Mode: 01; Polarity: Vertical; Modulation:802.11ac; Bandwidth:80MHz; Channel:Low

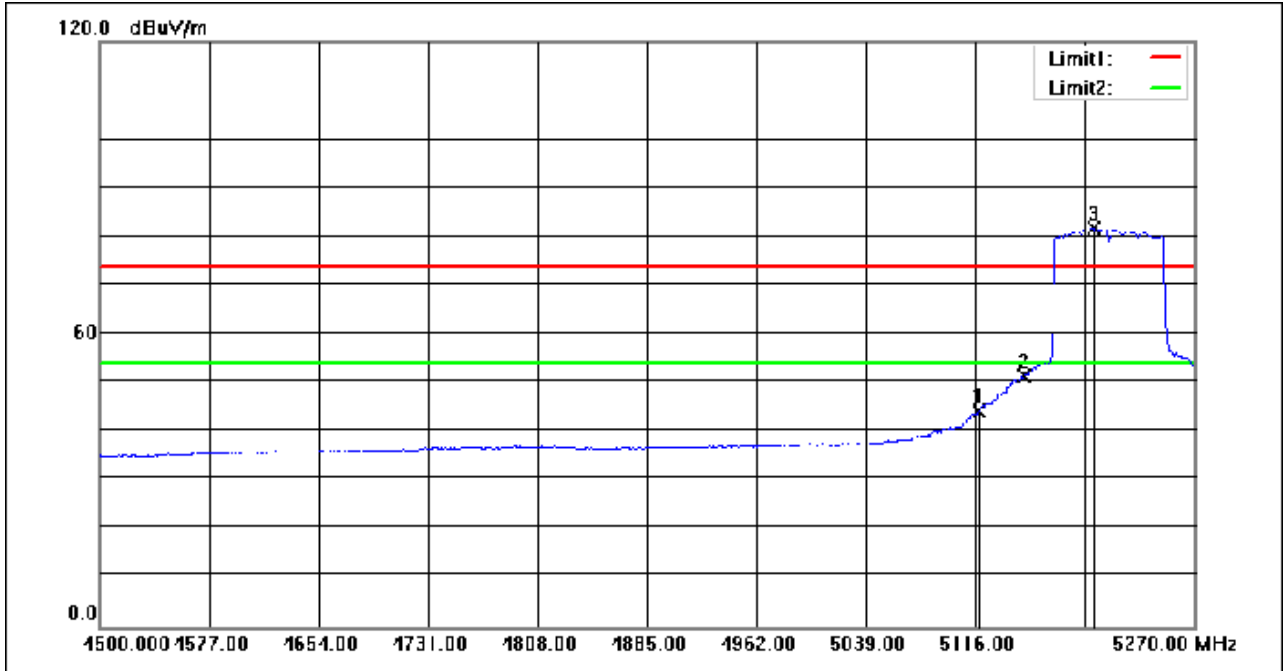

No.	Frequency (MHz)	Reading (dBuV)	Correction factor(dB/m)	Result (dBuV/m)	Limit (dBuV/m)	Margin (dB)	Remark
1	5118.310	54.91	-10.63	44.28	54.00	-9.72	AVG
2	5150.000	62.17	-10.64	51.53	54.00	-2.47	AVG
3	5199.160	92.26	-10.65	81.61	54.00	27.61	AVG



Unless otherwise agreed in writing, this document is issued by the Company subject to its General Conditions of Service printed overleaf, available on request or accessible at <http://www.sgs.com/en/Terms-and-Conditions.aspx> and, for electronic format documents, subject to Terms and Conditions for Electronic Documents at <http://www.sgs.com/en/Terms-and-Conditions/Terms-e-Documents.aspx>. Attention is drawn to the limitation of liability, indemnification and jurisdiction issues defined therein. Any holder of this document is advised that information contained hereon reflects the Company's findings at the time of its intervention only and within the limits of Client's instructions, if any. The Company's sole responsibility is to its Client and this document does not exonerate parties to a transaction from exercising all their rights and obligations under the transaction documents. This document cannot be reproduced except in full, without prior written approval of the Company. Any unauthorized alteration, forgery or falsification of the content or appearance of this document is unlawful and offenders may be prosecuted to the fullest extent of the law. Unless otherwise stated the results shown in this test report refer only to the sample(s) tested and such sample(s) are retained for 30 days only.  
**Attention: To check the authenticity of testing /inspection report & certificate, please contact us at telephone: (86-755) 8307 1443, or email: CN.Doccheck@sgs.com**

No.10, Weiye Road, Innovation Park, Kunshan, Jiangsu, China 215300  
 中国·江苏·昆山市留学生创业园伟业路10号 邮编 215300

t(86-512)57355888 f(86-512)57370818 www.sgsgroup.com.cn  
 t(86-512)57355888 f(86-512)57370818 sgs.china@sgs.com

Test Mode: 02; Polarity: Horizontal; Modulation:802.11a; Bandwidth:20MHz; Channel:High

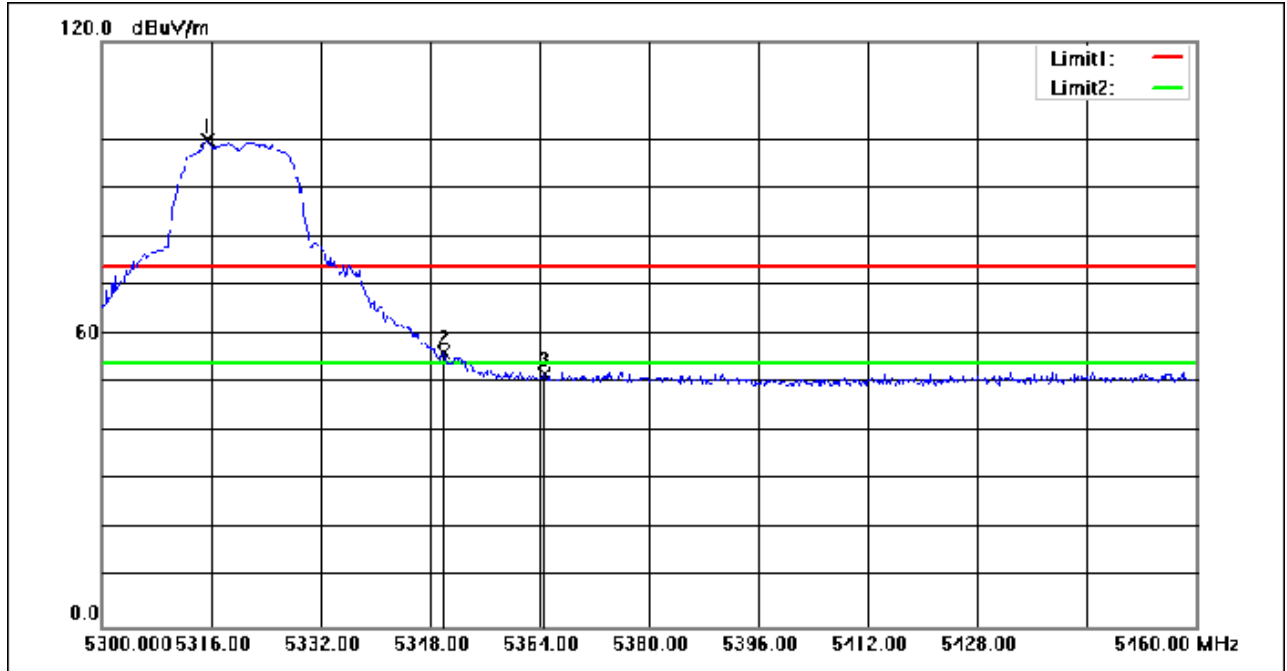

No.	Frequency (MHz)	Reading (dBuV)	Correction factor(dB/m)	Result (dBuV/m)	Limit (dBuV/m)	Margin (dB)	Remark
1	5315.360	109.83	-10.10	99.73	74.00	25.73	peak
2	5350.000	66.24	-9.94	56.30	74.00	-17.70	peak
3	5364.800	61.62	-9.87	51.75	74.00	-22.25	peak



Unless otherwise agreed in writing, this document is issued by the Company subject to its General Conditions of Service printed overleaf, available on request or accessible at <http://www.sgs.com/en/Terms-and-Conditions.aspx> and, for electronic format documents, subject to Terms and Conditions for Electronic Documents at <http://www.sgs.com/en/Terms-and-Conditions/Terms-e-Documents.aspx>. Attention is drawn to the limitation of liability, indemnification and jurisdiction issues defined therein. Any holder of this document is advised that information contained hereon reflects the Company's findings at the time of its intervention only and within the limits of Client's instructions, if any. The Company's sole responsibility is to its Client and this document does not exonerate parties to a transaction from exercising all their rights and obligations under the transaction documents. This document cannot be reproduced except in full, without prior written approval of the Company. Any unauthorized alteration, forgery or falsification of the content or appearance of this document is unlawful and offenders may be prosecuted to the fullest extent of the law. Unless otherwise stated the results shown in this test report refer only to the sample(s) tested and such sample(s) are retained for 30 days only.  
**Attention: To check the authenticity of testing /inspection report & certificate, please contact us at telephone: (86-755) 8307 1443, or email: CN.Doccheck@sgs.com**

No.10, Weiye Road, Innovation Park, Kunshan, Jiangsu, China 215300  
 中国·江苏·昆山市留学生创业园伟业路10号 邮编 215300

t(86-512)57355888 f(86-512)57370818 www.sgsgroup.com.cn  
 t(86-512)57355888 f(86-512)57370818 sgs.china@sgs.com

Test Mode: 02; Polarity: Horizontal; Modulation:802.11a; Bandwidth:20MHz; Channel:High

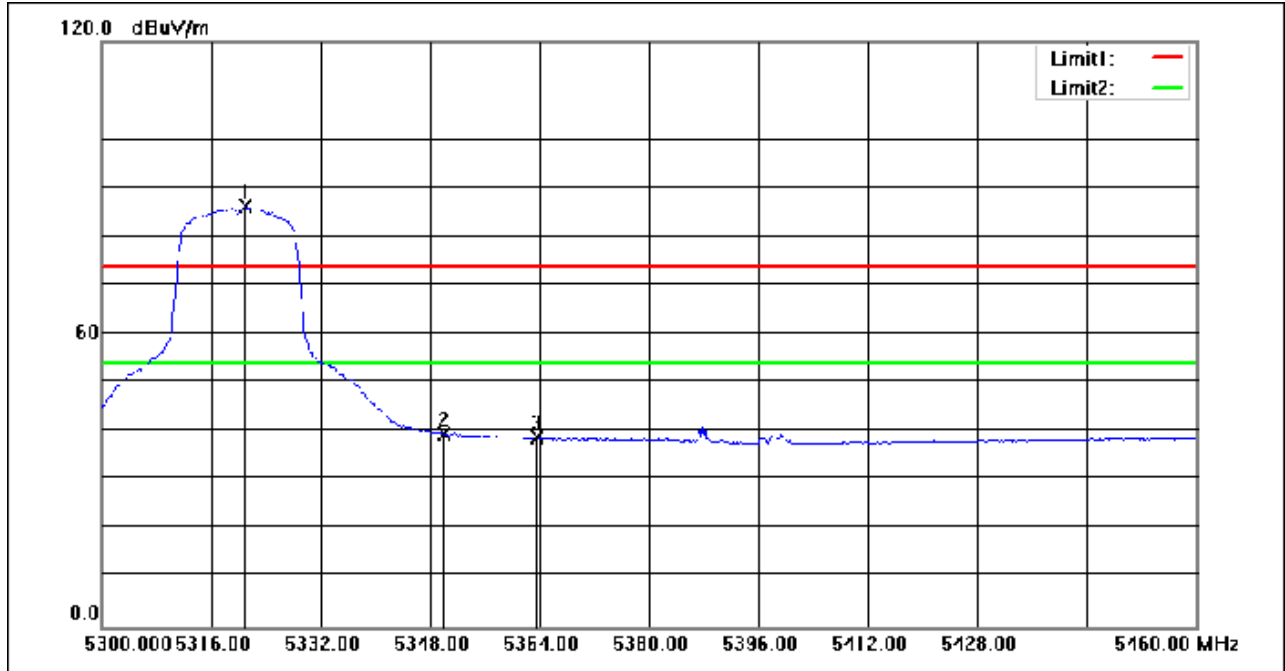

No.	Frequency (MHz)	Reading (dBuV)	Correction factor(dB/m)	Result (dBuV/m)	Limit (dBuV/m)	Margin (dB)	Remark
1	5320.960	96.27	-10.07	86.20	54.00	32.20	AVG
2	5350.000	49.39	-9.94	39.45	54.00	-14.55	AVG
3	5363.680	48.74	-9.87	38.87	54.00	-15.13	AVG



Unless otherwise agreed in writing, this document is issued by the Company subject to its General Conditions of Service printed overleaf, available on request or accessible at <http://www.sgs.com/en/Terms-and-Conditions.aspx> and, for electronic format documents, subject to Terms and Conditions for Electronic Documents at <http://www.sgs.com/en/Terms-and-Conditions/Terms-e-Documents.aspx>. Attention is drawn to the limitation of liability, indemnification and jurisdiction issues defined therein. Any holder of this document is advised that information contained hereon reflects the Company's findings at the time of its intervention only and within the limits of Client's instructions, if any. The Company's sole responsibility is to its Client and this document does not exonerate parties to a transaction from exercising all their rights and obligations under the transaction documents. This document cannot be reproduced except in full, without prior written approval of the Company. Any unauthorized alteration, forgery or falsification of the content or appearance of this document is unlawful and offenders may be prosecuted to the fullest extent of the law. Unless otherwise stated the results shown in this test report refer only to the sample(s) tested and such sample(s) are retained for 30 days only.  
**Attention: To check the authenticity of testing /inspection report & certificate, please contact us at telephone: (86-755) 8307 1443, or email: CN.Doccheck@sgs.com**

No.10, Weiye Road, Innovation Park, Kunshan, Jiangsu, China 215300  
 中国·江苏·昆山市留学院创业园伟业路10号 邮编 215300

t(86-512)57355888 f(86-512)57370818 www.sgsgroup.com.cn  
 t(86-512)57355888 f(86-512)57370818 sgs.china@sgs.com



Test Mode: 02; Polarity: Vertical; Modulation:802.11a; Bandwidth:20MHz; Channel:High

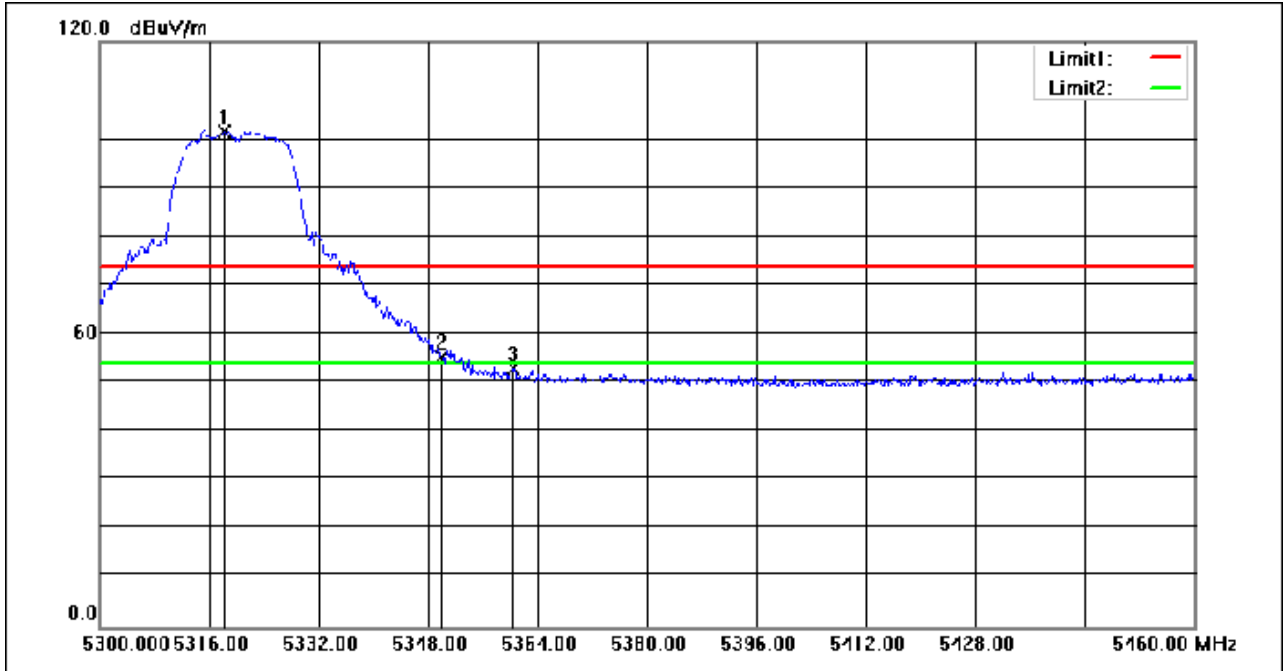

No.	Frequency (MHz)	Reading (dBuV)	Correction factor(dB/m)	Result (dBuV/m)	Limit (dBuV/m)	Margin (dB)	Remark
1	5318.240	111.67	-10.09	101.58	74.00	27.58	peak
2	5350.000	65.18	-9.94	55.24	74.00	-18.76	peak
3	5360.480	62.89	-9.89	53.00	74.00	-21.00	peak



Unless otherwise agreed in writing, this document is issued by the Company subject to its General Conditions of Service printed overleaf, available on request or accessible at <http://www.sgs.com/en/Terms-and-Conditions.aspx> and, for electronic format documents, subject to Terms and Conditions for Electronic Documents at <http://www.sgs.com/en/Terms-and-Conditions/Terms-e-Documents.aspx>. Attention is drawn to the limitation of liability, indemnification and jurisdiction issues defined therein. Any holder of this document is advised that information contained hereon reflects the Company's findings at the time of its intervention only and within the limits of Client's instructions, if any. The Company's sole responsibility is to its Client and this document does not exonerate parties to a transaction from exercising all their rights and obligations under the transaction documents. This document cannot be reproduced except in full, without prior written approval of the Company. Any unauthorized alteration, forgery or falsification of the content or appearance of this document is unlawful and offenders may be prosecuted to the fullest extent of the law. Unless otherwise stated the results shown in this test report refer only to the sample(s) tested and such sample(s) are retained for 30 days only.  
Attention: To check the authenticity of testing /inspection report & certificate, please contact us at telephone: (86-755) 8307 1443, or email: [CN.Doccheck@sgs.com](mailto:CN.Doccheck@sgs.com)

No.10, Weiye Road, Innovation Park, Kunshan, Jiangsu, China 215300  
中国·江苏·昆山市留学生创业园伟业路10号 邮编 215300

t(86-512)57355888 f(86-512)57370818 www.sgsgroup.com.cn  
t(86-512)57355888 f(86-512)57370818 sgs.china@sgs.com

Test Mode: 02; Polarity: Vertical; Modulation:802.11a; Bandwidth:20MHz; Channel:High

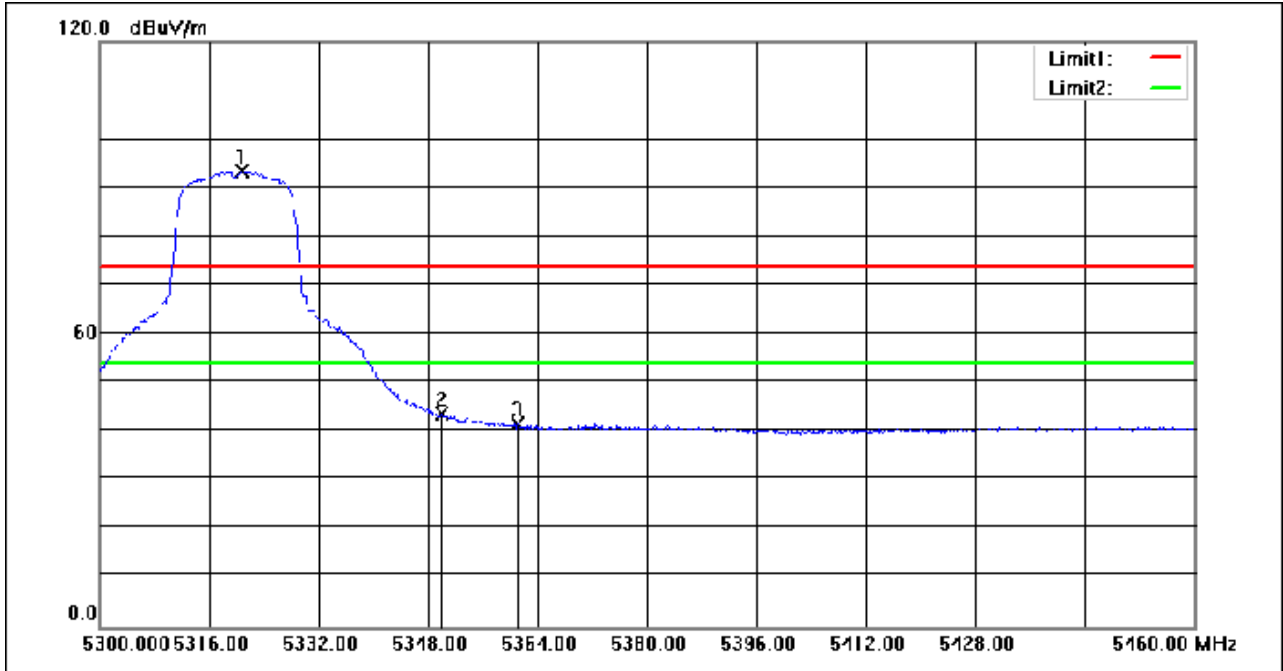

No.	Frequency (MHz)	Reading (dBuV)	Correction factor(dB/m)	Result (dBuV/m)	Limit (dBuV/m)	Margin (dB)	Remark
1	5320.800	103.47	-10.07	93.40	54.00	39.40	AVG
2	5350.000	53.64	-9.94	43.70	54.00	-10.30	AVG
3	5361.120	51.52	-9.89	41.63	54.00	-12.37	AVG



Unless otherwise agreed in writing, this document is issued by the Company subject to its General Conditions of Service printed overleaf, available on request or accessible at <http://www.sgs.com/en/Terms-and-Conditions.aspx> and, for electronic format documents, subject to Terms and Conditions for Electronic Documents at <http://www.sgs.com/en/Terms-and-Conditions/Terms-e-Documents.aspx>. Attention is drawn to the limitation of liability, indemnification and jurisdiction issues defined therein. Any holder of this document is advised that information contained hereon reflects the Company's findings at the time of its intervention only and within the limits of Client's instructions, if any. The Company's sole responsibility is to its Client and this document does not exonerate parties to a transaction from exercising all their rights and obligations under the transaction documents. This document cannot be reproduced except in full, without prior written approval of the Company. Any unauthorized alteration, forgery or falsification of the content or appearance of this document is unlawful and offenders may be prosecuted to the fullest extent of the law. Unless otherwise stated the results shown in this test report refer only to the sample(s) tested and such sample(s) are retained for 30 days only.  
**Attention: To check the authenticity of testing /inspection report & certificate, please contact us at telephone: (86-755) 8307 1443, or email: CN.Doccheck@sgs.com**

No.10, Weiye Road, Innovation Park, Kunshan, Jiangsu, China 215300  
 中国·江苏·昆山市留学生创业园伟业路10号 邮编 215300

t(86-512)57355888 f(86-512)57370818 www.sgsgroup.com.cn  
 t(86-512)57355888 f(86-512)57370818 sgs.china@sgs.com

Test Mode: 02; Polarity: Horizontal; Modulation:802.11n; Bandwidth:20MHz; Channel:High

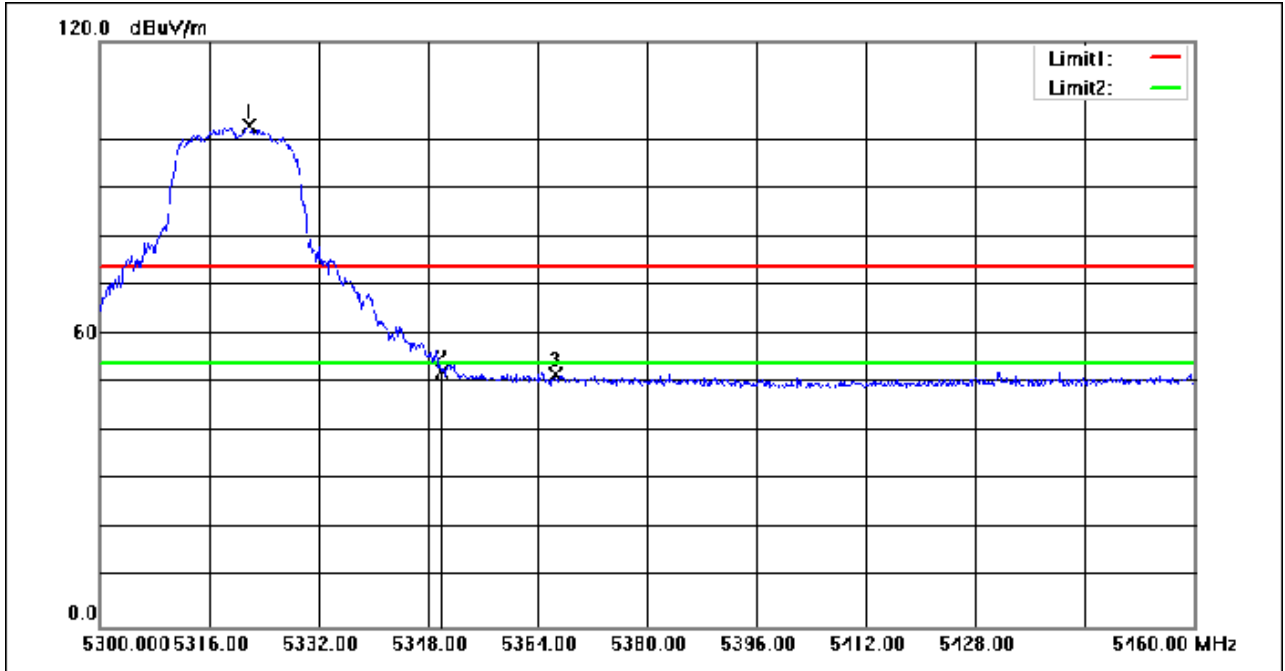

No.	Frequency (MHz)	Reading (dBuV)	Correction factor(dB/m)	Result (dBuV/m)	Limit (dBuV/m)	Margin (dB)	Remark
1	5321.760	112.74	-10.07	102.67	74.00	28.67	peak
2	5350.000	62.40	-9.94	52.46	74.00	-21.54	peak
3	5366.560	61.49	-9.86	51.63	74.00	-22.37	peak



Unless otherwise agreed in writing, this document is issued by the Company subject to its General Conditions of Service printed overleaf, available on request or accessible at <http://www.sgs.com/en/Terms-and-Conditions.aspx> and, for electronic format documents, subject to Terms and Conditions for Electronic Documents at <http://www.sgs.com/en/Terms-and-Conditions/Terms-e-Documents.aspx>. Attention is drawn to the limitation of liability, indemnification and jurisdiction issues defined therein. Any holder of this document is advised that information contained hereon reflects the Company's findings at the time of its intervention only and within the limits of Client's instructions, if any. The Company's sole responsibility is to its Client and this document does not exonerate parties to a transaction from exercising all their rights and obligations under the transaction documents. This document cannot be reproduced except in full, without prior written approval of the Company. Any unauthorized alteration, forgery or falsification of the content or appearance of this document is unlawful and offenders may be prosecuted to the fullest extent of the law. Unless otherwise stated the results shown in this test report refer only to the sample(s) tested and such sample(s) are retained for 30 days only.  
**Attention: To check the authenticity of testing /inspection report & certificate, please contact us at telephone: (86-755) 8307 1443, or email: CN.Doccheck@sgs.com**

No.10, Weiye Road, Innovation Park, Kunshan, Jiangsu, China 215300  
 中国·江苏·昆山市留学生创业园伟业路10号 邮编 215300

t(86-512)57355888 f(86-512)57370818 www.sgs.com.cn  
 t(86-512)57355888 f(86-512)57370818 sgs.china@sgs.com

Test Mode: 02; Polarity: Vertical; Modulation:802.11n; Bandwidth:20MHz; Channel:High

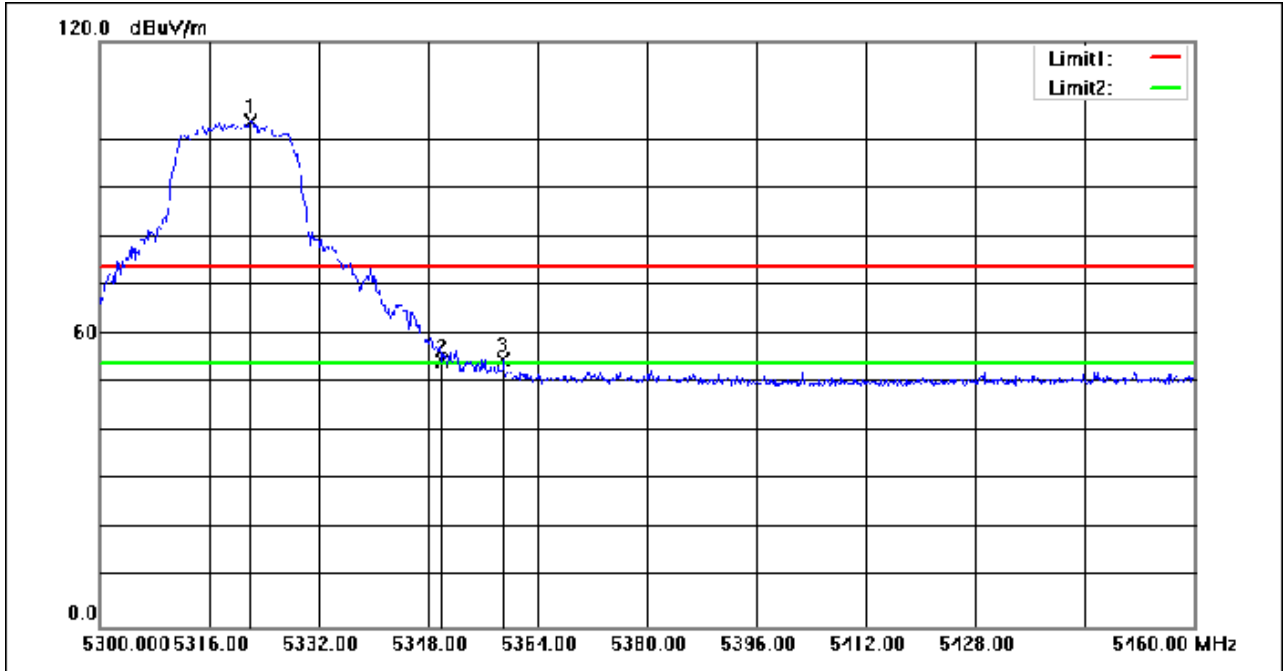

No.	Frequency (MHz)	Reading (dBuV)	Correction factor(dB/m)	Result (dBuV/m)	Limit (dBuV/m)	Margin (dB)	Remark
1	5322.080	113.74	-10.07	103.67	74.00	29.67	peak
2	5350.000	64.33	-9.94	54.39	74.00	-19.61	peak
3	5359.040	64.52	-9.89	54.63	74.00	-19.37	peak



Unless otherwise agreed in writing, this document is issued by the Company subject to its General Conditions of Service printed overleaf, available on request or accessible at <http://www.sgs.com/en/Terms-and-Conditions.aspx> and, for electronic format documents, subject to Terms and Conditions for Electronic Documents at <http://www.sgs.com/en/Terms-and-Conditions/Terms-e-Documents.aspx>. Attention is drawn to the limitation of liability, indemnification and jurisdiction issues defined therein. Any holder of this document is advised that information contained hereon reflects the Company's findings at the time of its intervention only and within the limits of Client's instructions, if any. The Company's sole responsibility is to its Client and this document does not exonerate parties to a transaction from exercising all their rights and obligations under the transaction documents. This document cannot be reproduced except in full, without prior written approval of the Company. Any unauthorized alteration, forgery or falsification of the content or appearance of this document is unlawful and offenders may be prosecuted to the fullest extent of the law. Unless otherwise stated the results shown in this test report refer only to the sample(s) tested and such sample(s) are retained for 30 days only.  
**Attention: To check the authenticity of testing /inspection report & certificate, please contact us at telephone: (86-755) 8307 1443, or email: CN.Doccheck@sgs.com**

No.10, Weiye Road, Innovation Park, Kunshan, Jiangsu, China 215300  
 中国·江苏·昆山市留学生创业园伟业路10号 邮编 215300

t(86-512)57355888 f(86-512)57370818 www.sgsgroup.com.cn  
 t(86-512)57355888 f(86-512)57370818 sgs.china@sgs.com

Test Mode: 02; Polarity: Vertical; Modulation:802.11n; Bandwidth:20MHz; Channel:High

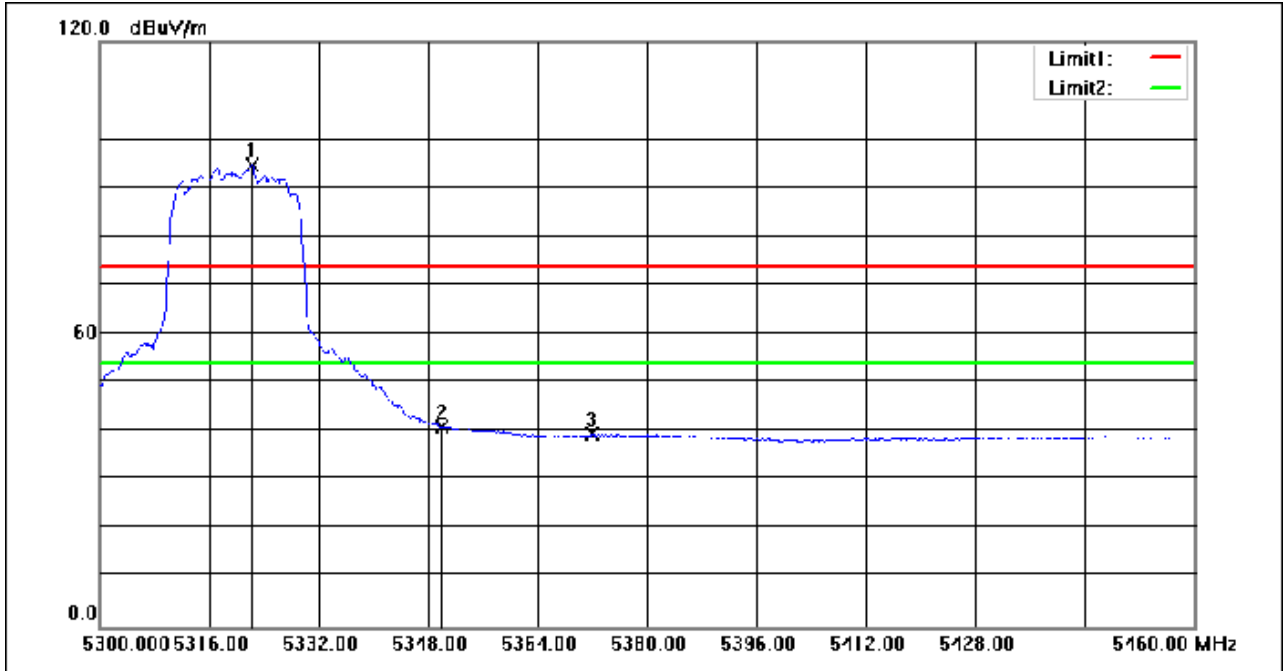

No.	Frequency (MHz)	Reading (dBuV)	Correction factor(dB/m)	Result (dBuV/m)	Limit (dBuV/m)	Margin (dB)	Remark
1	5322.240	104.78	-10.07	94.71	54.00	40.71	AVG
2	5350.000	51.00	-9.94	41.06	54.00	-12.94	AVG
3	5372.000	49.24	-9.83	39.41	54.00	-14.59	AVG



Unless otherwise agreed in writing, this document is issued by the Company subject to its General Conditions of Service printed overleaf, available on request or accessible at <http://www.sgs.com/en/Terms-and-Conditions.aspx> and, for electronic format documents, subject to Terms and Conditions for Electronic Documents at <http://www.sgs.com/en/Terms-and-Conditions/Terms-e-Documents.aspx>. Attention is drawn to the limitation of liability, indemnification and jurisdiction issues defined therein. Any holder of this document is advised that information contained hereon reflects the Company's findings at the time of its intervention only and within the limits of Client's instructions, if any. The Company's sole responsibility is to its Client and this document does not exonerate parties to a transaction from exercising all their rights and obligations under the transaction documents. This document cannot be reproduced except in full, without prior written approval of the Company. Any unauthorized alteration, forgery or falsification of the content or appearance of this document is unlawful and offenders may be prosecuted to the fullest extent of the law. Unless otherwise stated the results shown in this test report refer only to the sample(s) tested and such sample(s) are retained for 30 days only.  
**Attention: To check the authenticity of testing /inspection report & certificate, please contact us at telephone: (86-755) 8307 1443, or email: CN.Doccheck@sgs.com**

No.10, Weiye Road, Innovation Park, Kunshan, Jiangsu, China 215300  
 中国·江苏·昆山市留学生创业园伟业路10号 邮编 215300

t(86-512)57355888 f(86-512)57370818 www.sgsgroup.com.cn  
 t(86-512)57355888 f(86-512)57370818 sgs.china@sgs.com



Test Mode: 02; Polarity: Horizontal; Modulation:802.11n; Bandwidth:40MHz; Channel:High

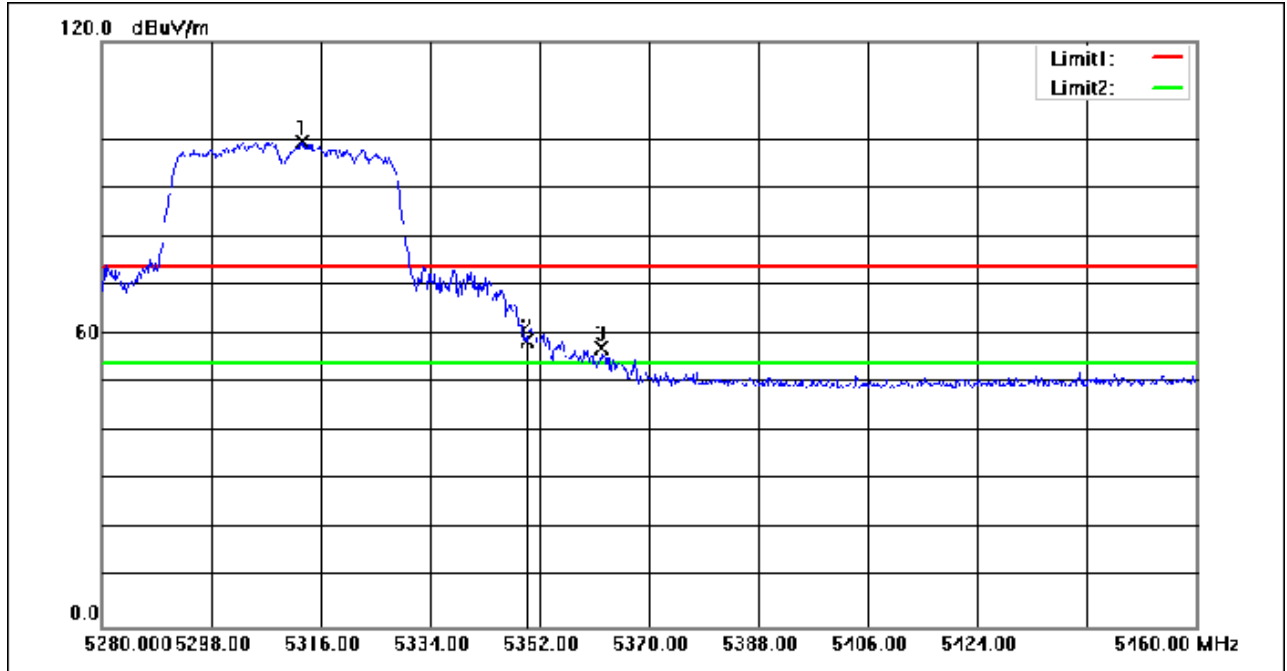

No.	Frequency (MHz)	Reading (dBuV)	Correction factor(dB/m)	Result (dBuV/m)	Limit (dBuV/m)	Margin (dB)	Remark
1	5312.940	109.47	-10.11	99.36	74.00	25.36	peak
2	5350.000	68.63	-9.94	58.69	74.00	-15.31	peak
3	5362.260	66.89	-9.88	57.01	74.00	-16.99	peak



Unless otherwise agreed in writing, this document is issued by the Company subject to its General Conditions of Service printed overleaf, available on request or accessible at <http://www.sgs.com/en/Terms-and-Conditions.aspx> and, for electronic format documents, subject to Terms and Conditions for Electronic Documents at <http://www.sgs.com/en/Terms-and-Conditions/Terms-e-Documents.aspx>. Attention is drawn to the limitation of liability, indemnification and jurisdiction issues defined therein. Any holder of this document is advised that information contained hereon reflects the Company's findings at the time of its intervention only and within the limits of Client's instructions, if any. The Company's sole responsibility is to its Client and this document does not exonerate parties to a transaction from exercising all their rights and obligations under the transaction documents. This document cannot be reproduced except in full, without prior written approval of the Company. Any unauthorized alteration, forgery or falsification of the content or appearance of this document is unlawful and offenders may be prosecuted to the fullest extent of the law. Unless otherwise stated the results shown in this test report refer only to the sample(s) tested and such sample(s) are retained for 30 days only.  
**Attention: To check the authenticity of testing /inspection report & certificate, please contact us at telephone: (86-755) 8307 1443, or email: CN.Doccheck@sgs.com**

No.10, Weiye Road, Innovation Park, Kunshan, Jiangsu, China 215300  
 中国·江苏·昆山市留学生创业园伟业路10号 邮编 215300

t(86-512)57355888 f(86-512)57370818 www.sgsgroup.com.cn  
 t(86-512)57355888 f(86-512)57370818 sgs.china@sgs.com

Test Mode: 02; Polarity: Horizontal; Modulation:802.11n; Bandwidth:40MHz; Channel:High

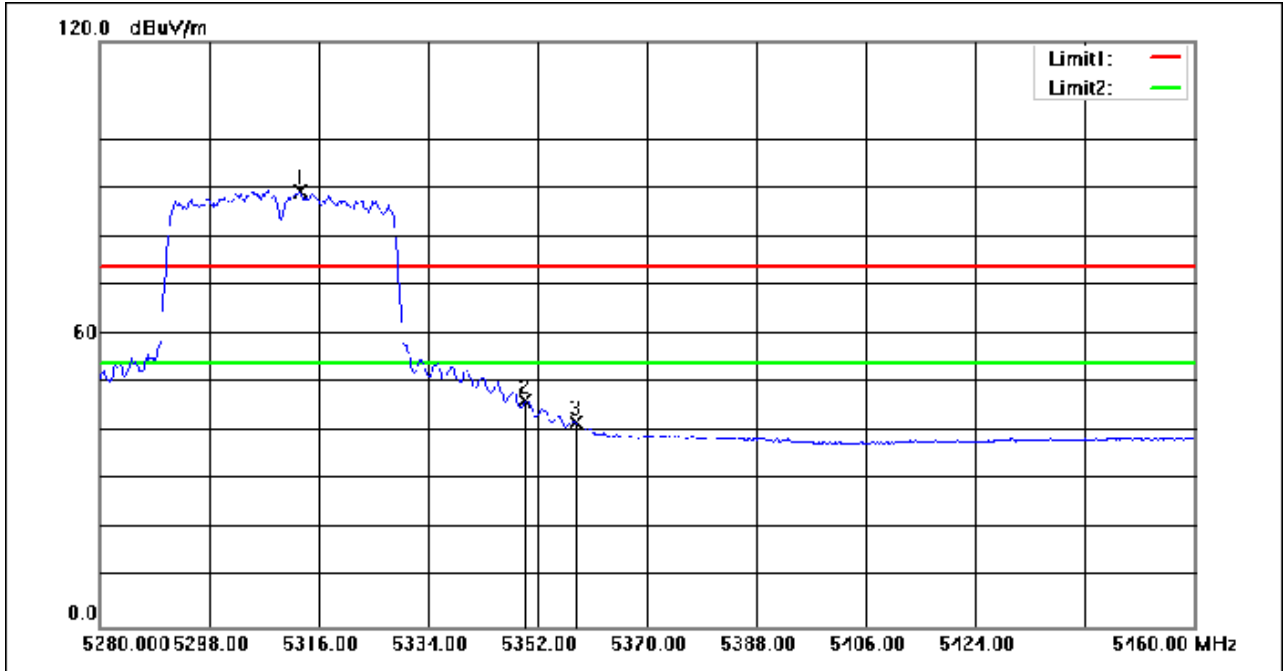

No.	Frequency (MHz)	Reading (dBuV)	Correction factor(dB/m)	Result (dBuV/m)	Limit (dBuV/m)	Margin (dB)	Remark
1	5312.940	99.36	-10.11	89.25	54.00	35.25	AVG
2	5350.000	56.43	-9.94	46.49	54.00	-7.51	AVG
3	5358.300	51.68	-9.90	41.78	54.00	-12.22	AVG



Unless otherwise agreed in writing, this document is issued by the Company subject to its General Conditions of Service printed overleaf, available on request or accessible at <http://www.sgs.com/en/Terms-and-Conditions.aspx> and, for electronic format documents, subject to Terms and Conditions for Electronic Documents at <http://www.sgs.com/en/Terms-and-Conditions/Terms-e-Documents.aspx>. Attention is drawn to the limitation of liability, indemnification and jurisdiction issues defined therein. Any holder of this document is advised that information contained hereon reflects the Company's findings at the time of its intervention only and within the limits of Client's instructions, if any. The Company's sole responsibility is to its Client and this document does not exonerate parties to a transaction from exercising all their rights and obligations under the transaction documents. This document cannot be reproduced except in full, without prior written approval of the Company. Any unauthorized alteration, forgery or falsification of the content or appearance of this document is unlawful and offenders may be prosecuted to the fullest extent of the law. Unless otherwise stated the results shown in this test report refer only to the sample(s) tested and such sample(s) are retained for 30 days only.  
**Attention: To check the authenticity of testing /inspection report & certificate, please contact us at telephone: (86-755) 8307 1443, or email: CN.Doccheck@sgs.com**

No.10, Weiye Road, Innovation Park, Kunshan, Jiangsu, China 215300  
 中国·江苏·昆山市留学生创业园伟业路10号 邮编 215300

t(86-512)57355888 f(86-512)57370818 www.sgsgroup.com.cn  
 t(86-512)57355888 f(86-512)57370818 sgs.china@sgs.com

Test Mode: 02; Polarity: Vertical; Modulation:802.11n; Bandwidth:40MHz; Channel:High

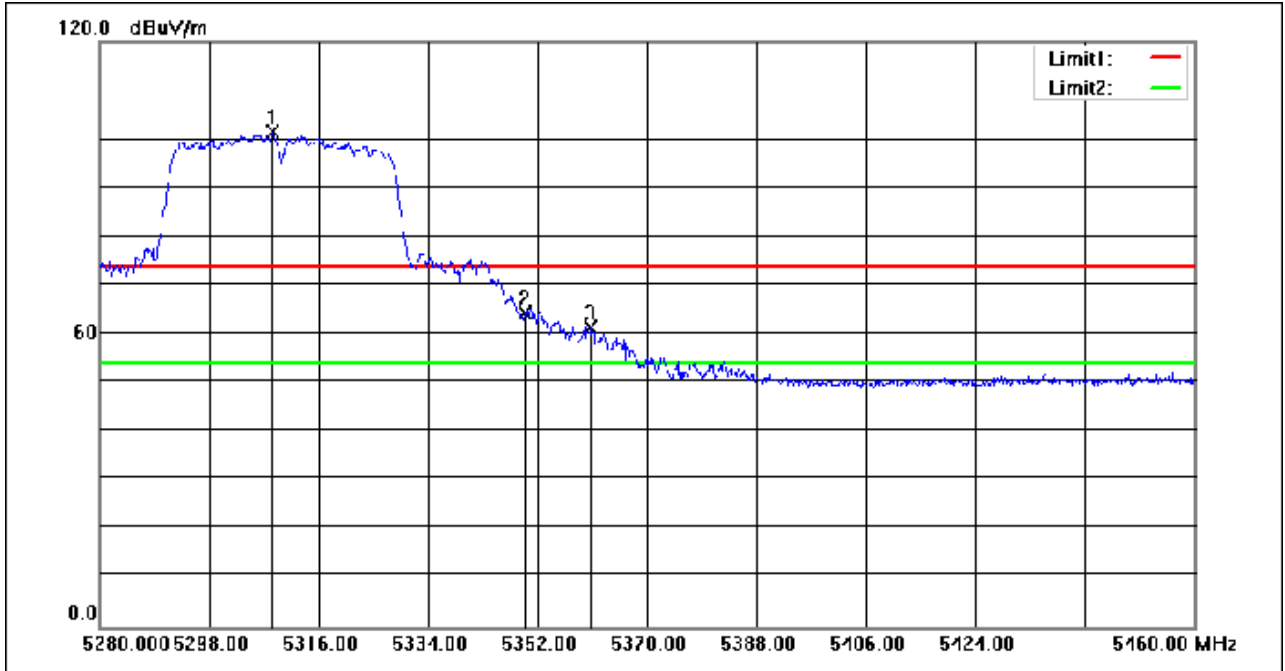

No.	Frequency (MHz)	Reading (dBuV)	Correction factor(dB/m)	Result (dBuV/m)	Limit (dBuV/m)	Margin (dB)	Remark
1	5308.440	111.68	-10.13	101.55	74.00	27.55	peak
2	5350.000	74.27	-9.94	64.33	74.00	-9.67	peak
3	5360.820	71.26	-9.89	61.37	74.00	-12.63	peak



Unless otherwise agreed in writing, this document is issued by the Company subject to its General Conditions of Service printed overleaf, available on request or accessible at <http://www.sgs.com/en/Terms-and-Conditions.aspx> and, for electronic format documents, subject to Terms and Conditions for Electronic Documents at <http://www.sgs.com/en/Terms-and-Conditions/Terms-e-Documents.aspx>. Attention is drawn to the limitation of liability, indemnification and jurisdiction issues defined therein. Any holder of this document is advised that information contained hereon reflects the Company's findings at the time of its intervention only and within the limits of Client's instructions, if any. The Company's sole responsibility is to its Client and this document does not exonerate parties to a transaction from exercising all their rights and obligations under the transaction documents. This document cannot be reproduced except in full, without prior written approval of the Company. Any unauthorized alteration, forgery or falsification of the content or appearance of this document is unlawful and offenders may be prosecuted to the fullest extent of the law. Unless otherwise stated the results shown in this test report refer only to the sample(s) tested and such sample(s) are retained for 30 days only.

Attention: To check the authenticity of testing /inspection report & certificate, please contact us at telephone: (86-755) 8307 1443, or email: [CN.Doccheck@sgs.com](mailto:CN.Doccheck@sgs.com)

No.10, Weiye Road, Innovation Park, Kunshan, Jiangsu, China 215300  
 中国·江苏·昆山市留学院创业园伟业路10号 邮编 215300

t(86-512)57355888 f(86-512)57370818 www.sgsgroup.com.cn  
 t(86-512)57355888 f(86-512)57370818 sgs.china@sgs.com

Test Mode: 02; Polarity: Vertical; Modulation:802.11n; Bandwidth:40MHz; Channel:High

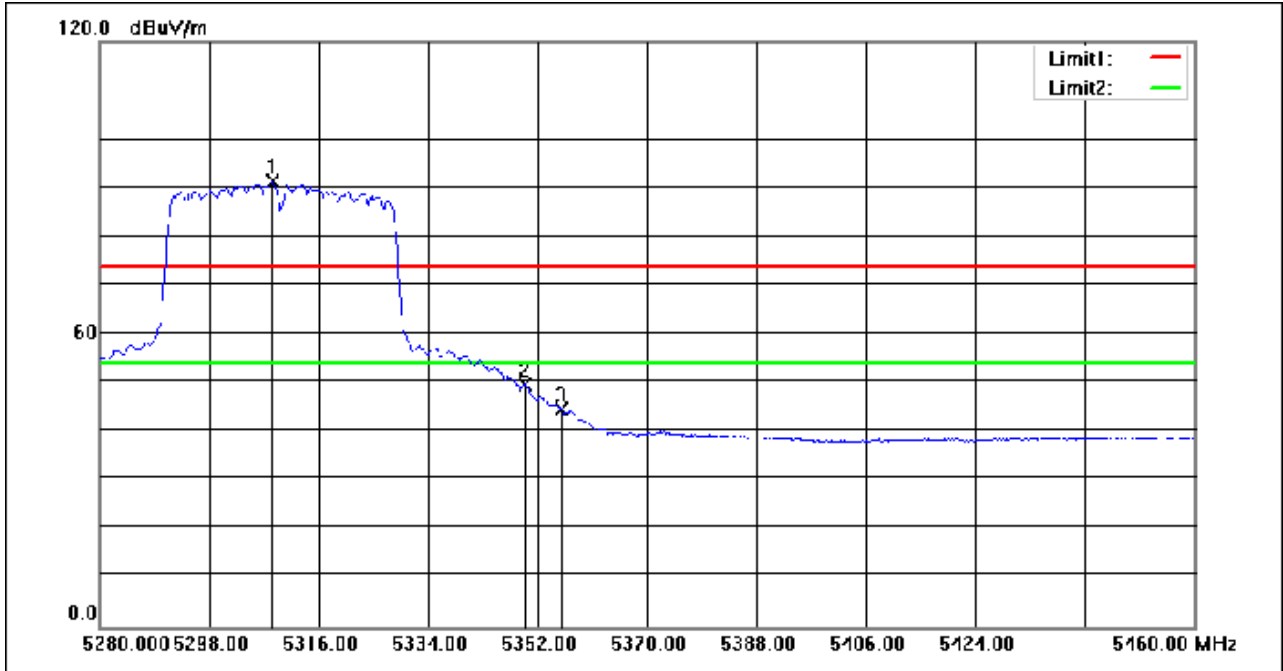

No.	Frequency (MHz)	Reading (dBuV)	Correction factor(dB/m)	Result (dBuV/m)	Limit (dBuV/m)	Margin (dB)	Remark
1	5308.440	101.37	-10.13	91.24	54.00	37.24	AVG
2	5350.000	59.63	-9.94	49.69	54.00	-4.31	AVG
3	5355.960	54.58	-9.91	44.67	54.00	-9.33	AVG



Unless otherwise agreed in writing, this document is issued by the Company subject to its General Conditions of Service printed overleaf, available on request or accessible at <http://www.sgs.com/en/Terms-and-Conditions.aspx> and, for electronic format documents, subject to Terms and Conditions for Electronic Documents at <http://www.sgs.com/en/Terms-and-Conditions/Terms-e-Documents.aspx>. Attention is drawn to the limitation of liability, indemnification and jurisdiction issues defined therein. Any holder of this document is advised that information contained hereon reflects the Company's findings at the time of its intervention only and within the limits of Client's instructions, if any. The Company's sole responsibility is to its Client and this document does not exonerate parties to a transaction from exercising all their rights and obligations under the transaction documents. This document cannot be reproduced except in full, without prior written approval of the Company. Any unauthorized alteration, forgery or falsification of the content or appearance of this document is unlawful and offenders may be prosecuted to the fullest extent of the law. Unless otherwise stated the results shown in this test report refer only to the sample(s) tested and such sample(s) are retained for 30 days only.  
**Attention: To check the authenticity of testing /inspection report & certificate, please contact us at telephone: (86-755) 8307 1443, or email: CN.Doccheck@sgs.com**

No.10, Weiye Road, Innovation Park, Kunshan, Jiangsu, China 215300  
 中国·江苏·昆山市留学生创业园伟业路10号 邮编 215300

t(86-512)57355888 f(86-512)57370818 www.sgsgroup.com.cn  
 t(86-512)57355888 f(86-512)57370818 sgs.china@sgs.com

Test Mode: 02; Polarity: Horizontal; Modulation:802.11ac; Bandwidth:20MHz; Channel:High

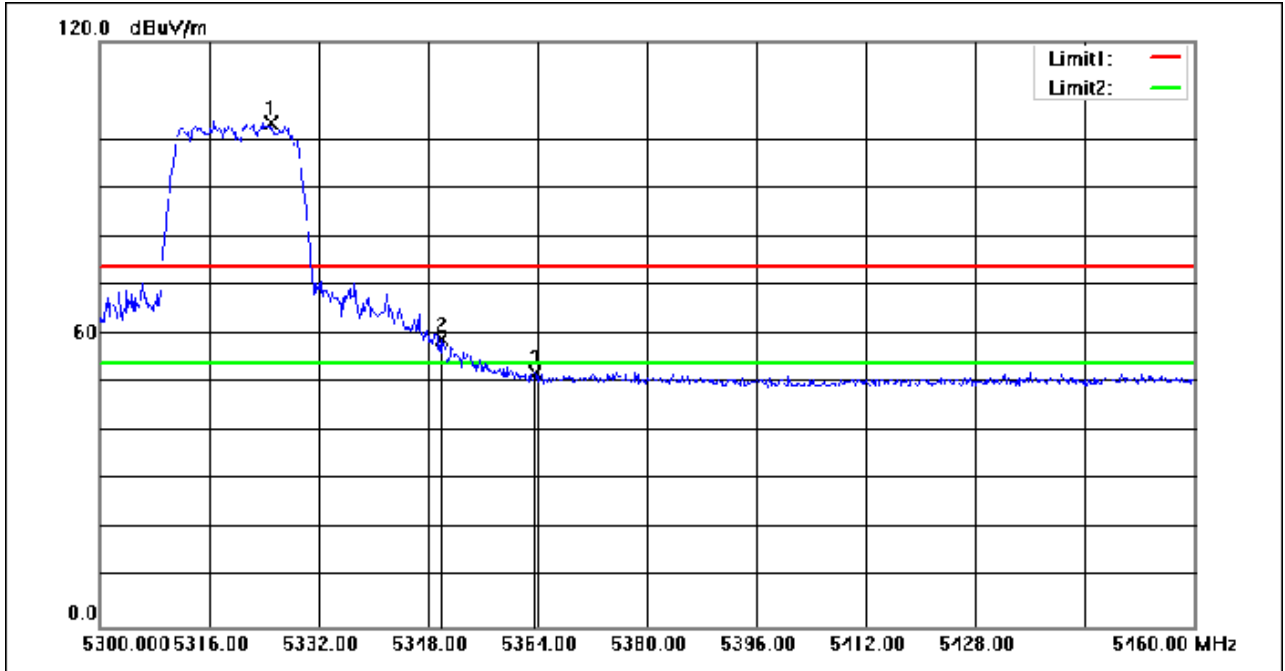

No.	Frequency (MHz)	Reading (dBuV)	Correction factor(dB/m)	Result (dBuV/m)	Limit (dBuV/m)	Margin (dB)	Remark
1	5324.960	113.50	-10.05	103.45	74.00	29.45	peak
2	5350.000	68.96	-9.94	59.02	74.00	-14.98	peak
3	5363.680	61.84	-9.87	51.97	74.00	-22.03	peak



Unless otherwise agreed in writing, this document is issued by the Company subject to its General Conditions of Service printed overleaf, available on request or accessible at <http://www.sgs.com/en/Terms-and-Conditions.aspx> and, for electronic format documents, subject to Terms and Conditions for Electronic Documents at <http://www.sgs.com/en/Terms-and-Conditions/Terms-e-Documents.aspx>. Attention is drawn to the limitation of liability, indemnification and jurisdiction issues defined therein. Any holder of this document is advised that information contained hereon reflects the Company's findings at the time of its intervention only and within the limits of Client's instructions, if any. The Company's sole responsibility is to its Client and this document does not exonerate parties to a transaction from exercising all their rights and obligations under the transaction documents. This document cannot be reproduced except in full, without prior written approval of the Company. Any unauthorized alteration, forgery or falsification of the content or appearance of this document is unlawful and offenders may be prosecuted to the fullest extent of the law. Unless otherwise stated the results shown in this test report refer only to the sample(s) tested and such sample(s) are retained for 30 days only.  
**Attention: To check the authenticity of testing /inspection report & certificate, please contact us at telephone: (86-755) 8307 1443, or email: CN.Doccheck@sgs.com**

No.10, Weiye Road, Innovation Park, Kunshan, Jiangsu, China 215300  
 中国·江苏·昆山市留学生创业园伟业路10号 邮编 215300

t(86-512)57355888 f(86-512)57370818 www.sgsgroup.com.cn  
 t(86-512)57355888 f(86-512)57370818 sgs.china@sgs.com



Test Mode: 02; Polarity: Horizontal; Modulation:802.11ac; Bandwidth:20MHz; Channel:High

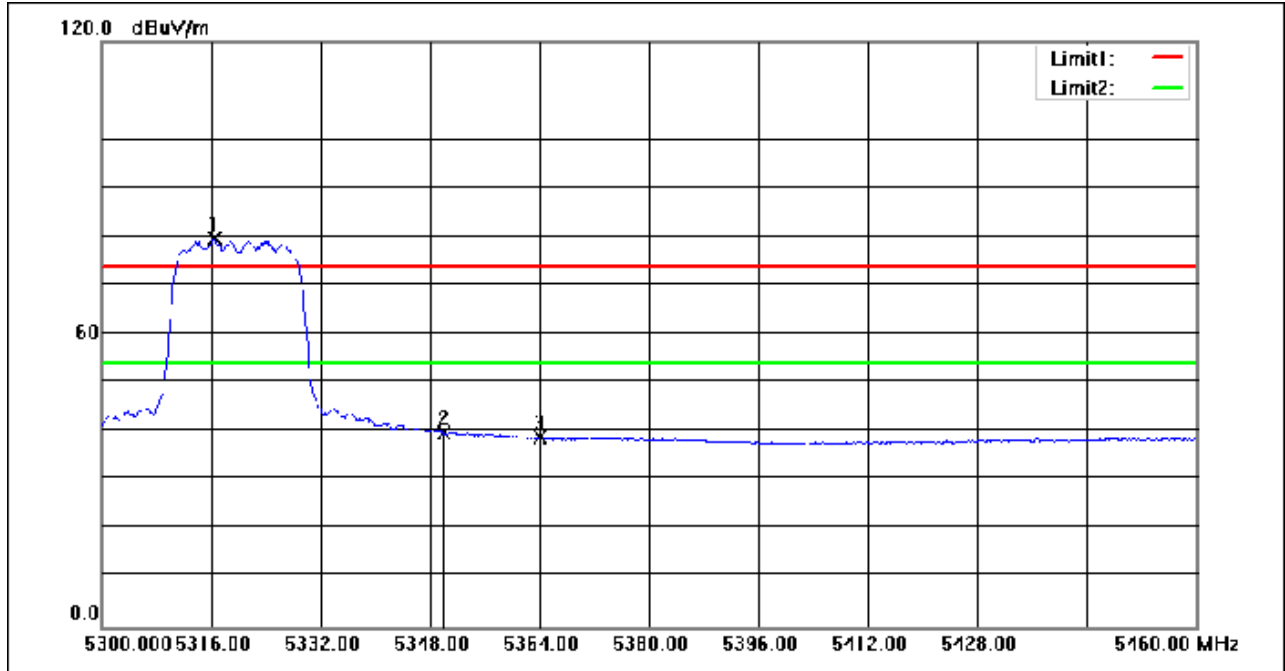

No.	Frequency (MHz)	Reading (dBuV)	Correction factor(dB/m)	Result (dBuV/m)	Limit (dBuV/m)	Margin (dB)	Remark
1	5316.480	89.61	-10.09	79.52	54.00	25.52	AVG
2	5350.000	49.64	-9.94	39.70	54.00	-14.30	AVG
3	5364.160	48.62	-9.87	38.75	54.00	-15.25	AVG



Unless otherwise agreed in writing, this document is issued by the Company subject to its General Conditions of Service printed overleaf, available on request or accessible at <http://www.sgs.com/en/Terms-and-Conditions.aspx> and, for electronic format documents, subject to Terms and Conditions for Electronic Documents at <http://www.sgs.com/en/Terms-and-Conditions/Terms-e-Documents.aspx>. Attention is drawn to the limitation of liability, indemnification and jurisdiction issues defined therein. Any holder of this document is advised that information contained hereon reflects the Company's findings at the time of its intervention only and within the limits of Client's instructions, if any. The Company's sole responsibility is to its Client and this document does not exonerate parties to a transaction from exercising all their rights and obligations under the transaction documents. This document cannot be reproduced except in full, without prior written approval of the Company. Any unauthorized alteration, forgery or falsification of the content or appearance of this document is unlawful and offenders may be prosecuted to the fullest extent of the law. Unless otherwise stated the results shown in this test report refer only to the sample(s) tested and such sample(s) are retained for 30 days only.  
Attention: To check the authenticity of testing /inspection report & certificate, please contact us at telephone: (86-755) 8307 1443, or email: [CN.Doccheck@sgs.com](mailto:CN.Doccheck@sgs.com)

No.10, Weiye Road, Innovation Park, Kunshan, Jiangsu, China 215300  
中国·江苏·昆山市留学院创业园伟业路10号 邮编 215300

t(86-512)57355888 f(86-512)57370818 www.sgsgroup.com.cn  
t(86-512)57355888 f(86-512)57370818 sgs.china@sgs.com

Test Mode: 02; Polarity: Vertical; Modulation:802.11ac; Bandwidth:20MHz; Channel:High

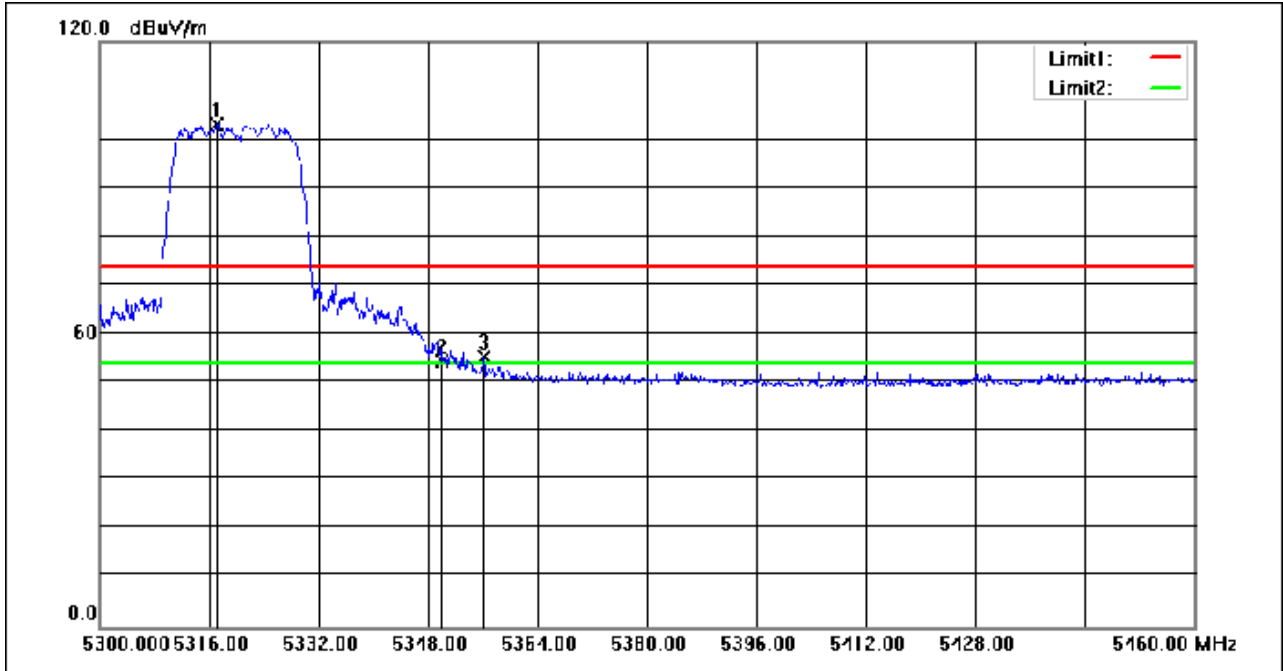

No.	Frequency (MHz)	Reading (dBuV)	Correction factor(dB/m)	Result (dBuV/m)	Limit (dBuV/m)	Margin (dB)	Remark
1	5317.120	113.14	-10.09	103.05	74.00	29.05	peak
2	5350.000	64.39	-9.94	54.45	74.00	-19.55	peak
3	5356.160	65.39	-9.91	55.48	74.00	-18.52	peak



Unless otherwise agreed in writing, this document is issued by the Company subject to its General Conditions of Service printed overleaf, available on request or accessible at <http://www.sgs.com/en/Terms-and-Conditions.aspx> and, for electronic format documents, subject to Terms and Conditions for Electronic Documents at <http://www.sgs.com/en/Terms-and-Conditions/Terms-e-Documents.aspx>. Attention is drawn to the limitation of liability, indemnification and jurisdiction issues defined therein. Any holder of this document is advised that information contained hereon reflects the Company's findings at the time of its intervention only and within the limits of Client's instructions, if any. The Company's sole responsibility is to its Client and this document does not exonerate parties to a transaction from exercising all their rights and obligations under the transaction documents. This document cannot be reproduced except in full, without prior written approval of the Company. Any unauthorized alteration, forgery or falsification of the content or appearance of this document is unlawful and offenders may be prosecuted to the fullest extent of the law. Unless otherwise stated the results shown in this test report refer only to the sample(s) tested and such sample(s) are retained for 30 days only.  
**Attention: To check the authenticity of testing /inspection report & certificate, please contact us at telephone: (86-755) 8307 1443, or email: CN.Doccheck@sgs.com**

No.10, Weiye Road, Innovation Park, Kunshan, Jiangsu, China 215300  
 中国·江苏·昆山市留学生创业园伟业路10号 邮编 215300

t(86-512)57355888 f(86-512)57370818 www.sgsgroup.com.cn  
 t(86-512)57355888 f(86-512)57370818 sgs.china@sgs.com

Test Mode: 02; Polarity: Vertical; Modulation:802.11ac; Bandwidth:20MHz; Channel:High

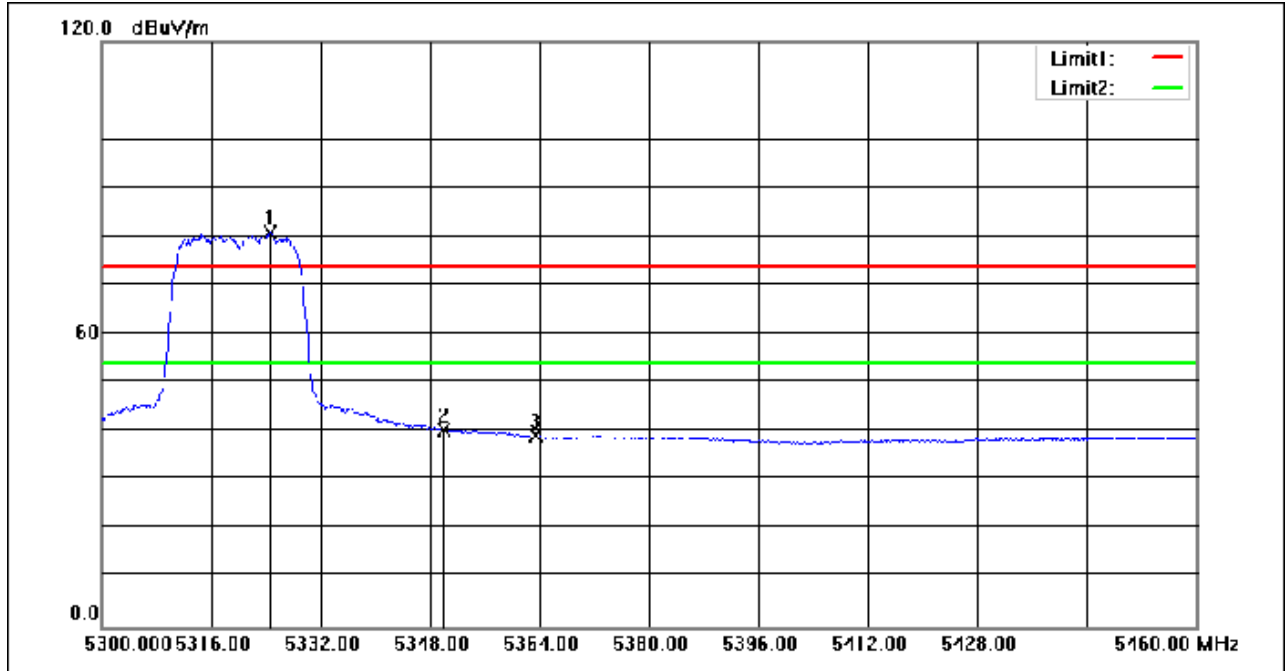

No.	Frequency (MHz)	Reading (dBuV)	Correction factor(dB/m)	Result (dBuV/m)	Limit (dBuV/m)	Margin (dB)	Remark
1	5324.640	90.81	-10.05	80.76	54.00	26.76	AVG
2	5350.000	50.25	-9.94	40.31	54.00	-13.69	AVG
3	5363.360	48.95	-9.87	39.08	54.00	-14.92	AVG



Unless otherwise agreed in writing, this document is issued by the Company subject to its General Conditions of Service printed overleaf, available on request or accessible at <http://www.sgs.com/en/Terms-and-Conditions.aspx> and, for electronic format documents, subject to Terms and Conditions for Electronic Documents at <http://www.sgs.com/en/Terms-and-Conditions/Terms-e-Documents.aspx>. Attention is drawn to the limitation of liability, indemnification and jurisdiction issues defined therein. Any holder of this document is advised that information contained hereon reflects the Company's findings at the time of its intervention only and within the limits of Client's instructions, if any. The Company's sole responsibility is to its Client and this document does not exonerate parties to a transaction from exercising all their rights and obligations under the transaction documents. This document cannot be reproduced except in full, without prior written approval of the Company. Any unauthorized alteration, forgery or falsification of the content or appearance of this document is unlawful and offenders may be prosecuted to the fullest extent of the law. Unless otherwise stated the results shown in this test report refer only to the sample(s) tested and such sample(s) are retained for 30 days only.  
**Attention: To check the authenticity of testing /inspection report & certificate, please contact us at telephone: (86-755) 8307 1443, or email: CN.Doccheck@sgs.com**

No.10, Weiye Road, Innovation Park, Kunshan, Jiangsu, China 215300  
 中国·江苏·昆山市留学生创业园伟业路10号 邮编 215300

t(86-512)57355888 f(86-512)57370818 www.sgsgroup.com.cn  
 t(86-512)57355888 f(86-512)57370818 sgs.china@sgs.com

Test Mode: 02; Polarity: Horizontal; Modulation:802.11ac; Bandwidth:40MHz; Channel:High

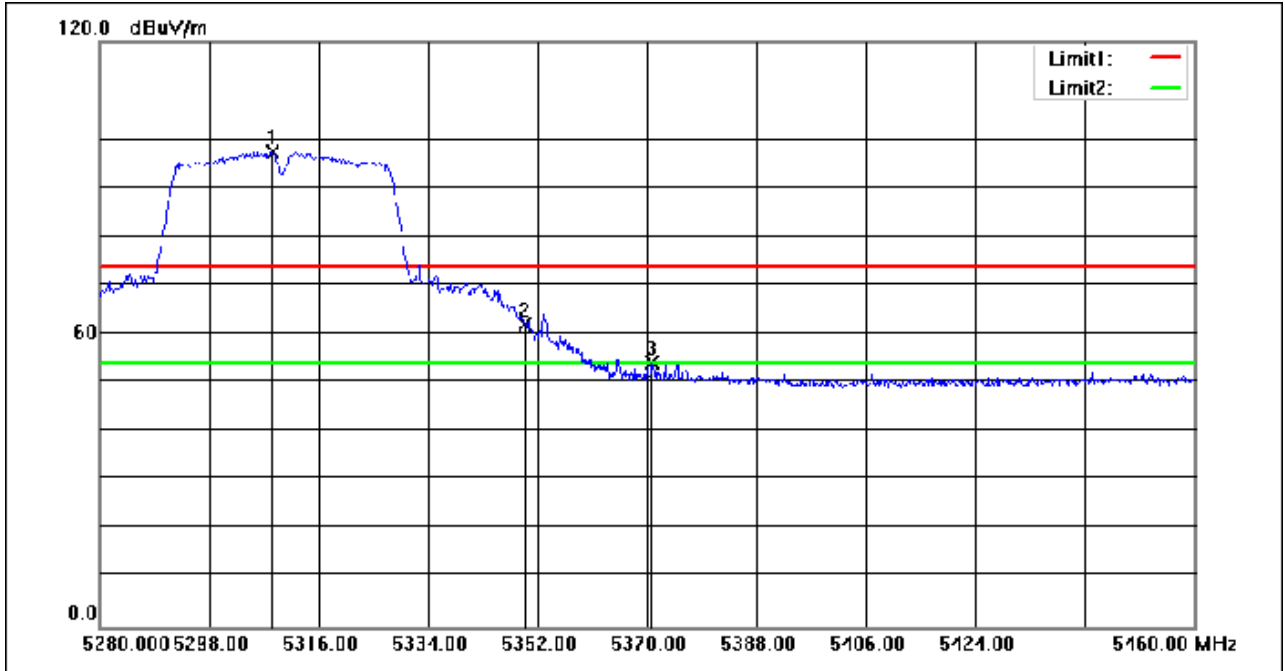

No.	Frequency (MHz)	Reading (dBuV)	Correction factor(dB/m)	Result (dBuV/m)	Limit (dBuV/m)	Margin (dB)	Remark
1	5308.440	107.46	-10.13	97.33	74.00	23.33	peak
2	5350.000	71.94	-9.94	62.00	74.00	-12.00	peak
3	5370.900	63.97	-9.84	54.13	74.00	-19.87	peak



Unless otherwise agreed in writing, this document is issued by the Company subject to its General Conditions of Service printed overleaf, available on request or accessible at <http://www.sgs.com/en/Terms-and-Conditions.aspx> and, for electronic format documents, subject to Terms and Conditions for Electronic Documents at <http://www.sgs.com/en/Terms-and-Conditions/Terms-e-Documents.aspx>. Attention is drawn to the limitation of liability, indemnification and jurisdiction issues defined therein. Any holder of this document is advised that information contained hereon reflects the Company's findings at the time of its intervention only and within the limits of Client's instructions, if any. The Company's sole responsibility is to its Client and this document does not exonerate parties to a transaction from exercising all their rights and obligations under the transaction documents. This document cannot be reproduced except in full, without prior written approval of the Company. Any unauthorized alteration, forgery or falsification of the content or appearance of this document is unlawful and offenders may be prosecuted to the fullest extent of the law. Unless otherwise stated the results shown in this test report refer only to the sample(s) tested and such sample(s) are retained for 30 days only.  
**Attention: To check the authenticity of testing /inspection report & certificate, please contact us at telephone: (86-755) 8307 1443, or email: CN.Doccheck@sgs.com**

No.10, Weiye Road, Innovation Park, Kunshan, Jiangsu, China 215300  
中国·江苏·昆山市留学生创业园伟业路10号 邮编 215300

t(86-512)57355888 f(86-512)57370818 www.sgsgroup.com.cn  
t(86-512)57355888 f(86-512)57370818 sgs.china@sgs.com

Test Mode: 02; Polarity: Horizontal; Modulation:802.11ac; Bandwidth:40MHz; Channel:High

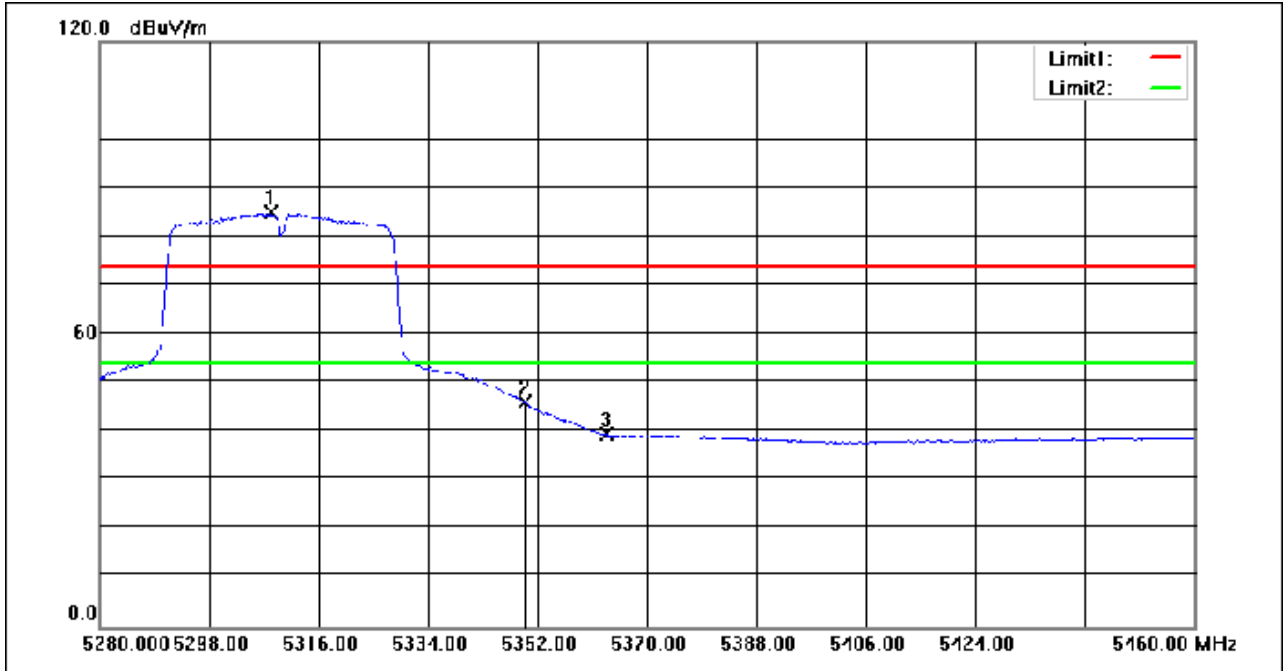

No.	Frequency (MHz)	Reading (dBuV)	Correction factor(dB/m)	Result (dBuV/m)	Limit (dBuV/m)	Margin (dB)	Remark
1	5308.260	95.24	-10.13	85.11	54.00	31.11	AVG
2	5350.000	55.98	-9.94	46.04	54.00	-7.96	AVG
3	5363.340	49.43	-9.87	39.56	54.00	-14.44	AVG



Unless otherwise agreed in writing, this document is issued by the Company subject to its General Conditions of Service printed overleaf, available on request or accessible at <http://www.sgs.com/en/Terms-and-Conditions.aspx> and, for electronic format documents, subject to Terms and Conditions for Electronic Documents at <http://www.sgs.com/en/Terms-and-Conditions/Terms-e-Documents.aspx>. Attention is drawn to the limitation of liability, indemnification and jurisdiction issues defined therein. Any holder of this document is advised that information contained hereon reflects the Company's findings at the time of its intervention only and within the limits of Client's instructions, if any. The Company's sole responsibility is to its Client and this document does not exonerate parties to a transaction from exercising all their rights and obligations under the transaction documents. This document cannot be reproduced except in full, without prior written approval of the Company. Any unauthorized alteration, forgery or falsification of the content or appearance of this document is unlawful and offenders may be prosecuted to the fullest extent of the law. Unless otherwise stated the results shown in this test report refer only to the sample(s) tested and such sample(s) are retained for 30 days only.  
**Attention: To check the authenticity of testing /inspection report & certificate, please contact us at telephone: (86-755) 8307 1443, or email: CN.Doccheck@sgs.com**

No.10, Weiye Road, Innovation Park, Kunshan, Jiangsu, China 215300  
 中国·江苏·昆山市留学生创业园伟业路10号 邮编 215300

t(86-512)57355888 f(86-512)57370818 www.sgsgroup.com.cn  
 t(86-512)57355888 f(86-512)57370818 sgs.china@sgs.com



Test Mode: 02; Polarity: Vertical; Modulation:802.11ac; Bandwidth:40MHz; Channel:High

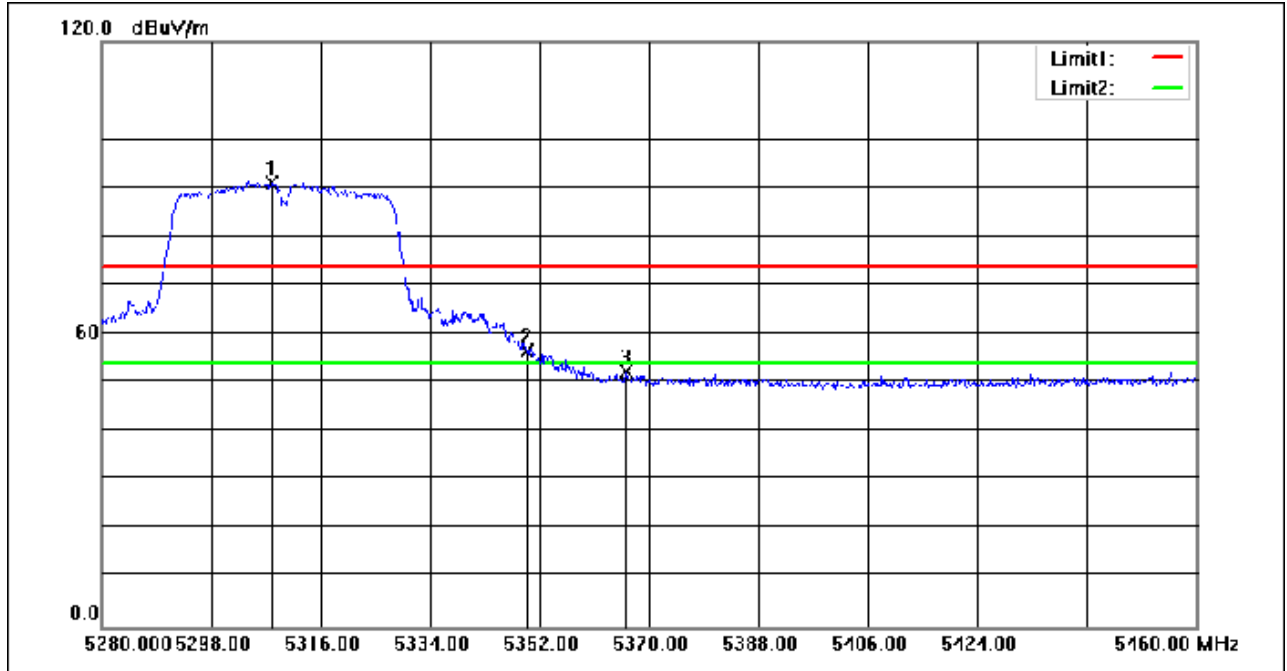

No.	Frequency (MHz)	Reading (dBuV)	Correction factor(dB/m)	Result (dBuV/m)	Limit (dBuV/m)	Margin (dB)	Remark
1	5307.900	101.26	-10.14	91.12	74.00	17.12	peak
2	5350.000	66.55	-9.94	56.61	74.00	-17.39	peak
3	5366.220	62.17	-9.86	52.31	74.00	-21.69	peak



Unless otherwise agreed in writing, this document is issued by the Company subject to its General Conditions of Service printed overleaf, available on request or accessible at <http://www.sgs.com/en/Terms-and-Conditions.aspx> and, for electronic format documents, subject to Terms and Conditions for Electronic Documents at <http://www.sgs.com/en/Terms-and-Conditions/Terms-e-Documents.aspx>. Attention is drawn to the limitation of liability, indemnification and jurisdiction issues defined therein. Any holder of this document is advised that information contained hereon reflects the Company's findings at the time of its intervention only and within the limits of Client's instructions, if any. The Company's sole responsibility is to its Client and this document does not exonerate parties to a transaction from exercising all their rights and obligations under the transaction documents. This document cannot be reproduced except in full, without prior written approval of the Company. Any unauthorized alteration, forgery or falsification of the content or appearance of this document is unlawful and offenders may be prosecuted to the fullest extent of the law. Unless otherwise stated the results shown in this test report refer only to the sample(s) tested and such sample(s) are retained for 30 days only.  
**Attention: To check the authenticity of testing /inspection report & certificate, please contact us at telephone: (86-755) 8307 1443, or email: CN.Doccheck@sgs.com**

No.10, Weiye Road, Innovation Park, Kunshan, Jiangsu, China 215300  
 中国·江苏·昆山市留学生创业园伟业路10号 邮编 215300

t(86-512)57355888 f(86-512)57370818 www.sgsgroup.com.cn  
 t(86-512)57355888 f(86-512)57370818 sgs.china@sgs.com

Test Mode: 02; Polarity: Vertical; Modulation:802.11ac; Bandwidth:40MHz; Channel:High

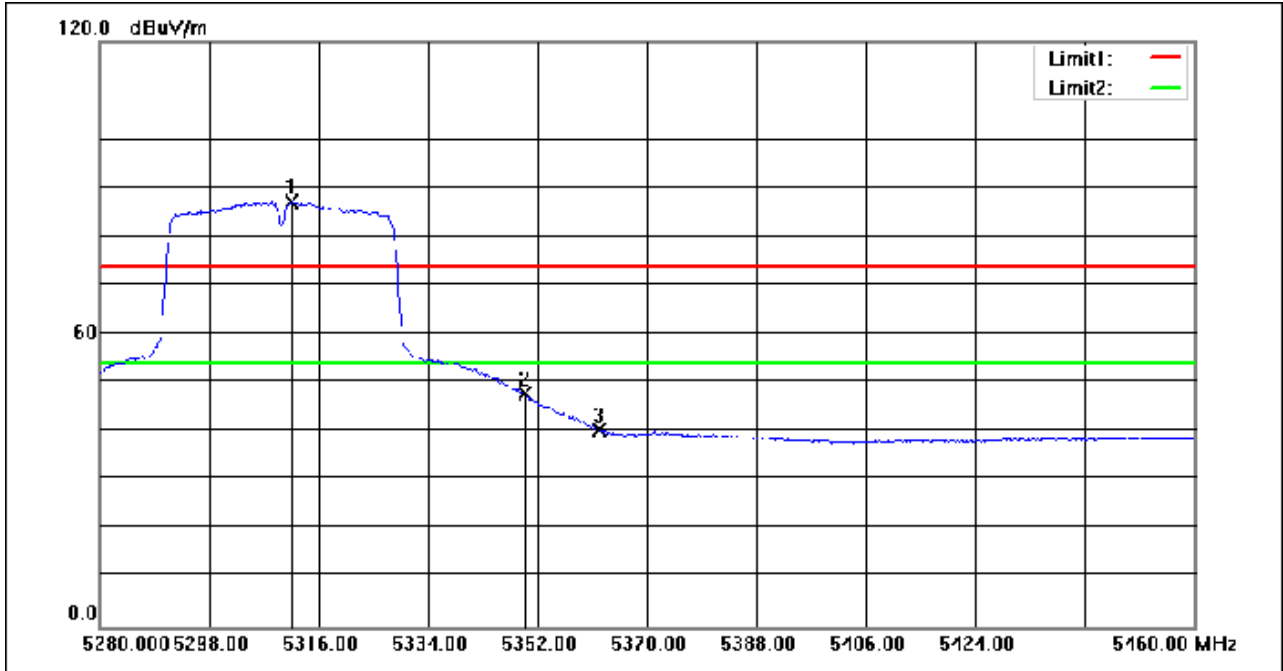

No.	Frequency (MHz)	Reading (dBuV)	Correction factor(dB/m)	Result (dBuV/m)	Limit (dBuV/m)	Margin (dB)	Remark
1	5311.500	97.34	-10.12	87.22	54.00	33.22	AVG
2	5350.000	57.87	-9.94	47.93	54.00	-6.07	AVG
3	5362.080	50.20	-9.88	40.32	54.00	-13.68	AVG



Unless otherwise agreed in writing, this document is issued by the Company subject to its General Conditions of Service printed overleaf, available on request or accessible at <http://www.sgs.com/en/Terms-and-Conditions.aspx> and, for electronic format documents, subject to Terms and Conditions for Electronic Documents at <http://www.sgs.com/en/Terms-and-Conditions/Terms-e-Documents.aspx>. Attention is drawn to the limitation of liability, indemnification and jurisdiction issues defined therein. Any holder of this document is advised that information contained hereon reflects the Company's findings at the time of its intervention only and within the limits of Client's instructions, if any. The Company's sole responsibility is to its Client and this document does not exonerate parties to a transaction from exercising all their rights and obligations under the transaction documents. This document cannot be reproduced except in full, without prior written approval of the Company. Any unauthorized alteration, forgery or falsification of the content or appearance of this document is unlawful and offenders may be prosecuted to the fullest extent of the law. Unless otherwise stated the results shown in this test report refer only to the sample(s) tested and such sample(s) are retained for 30 days only.  
**Attention: To check the authenticity of testing /inspection report & certificate, please contact us at telephone: (86-755) 8307 1443, or email: CN.Doccheck@sgs.com**

No.10, Weiye Road, Innovation Park, Kunshan, Jiangsu, China 215300  
中国·江苏·昆山市留学生创业园伟业路10号 邮编 215300

t(86-512)57355888 f(86-512)57370818 www.sgsgroup.com.cn  
t(86-512)57355888 f(86-512)57370818 sgs.china@sgs.com

Test Mode: 02; Polarity: Horizontal; Modulation:802.11ac; Bandwidth:80MHz; Channel:High

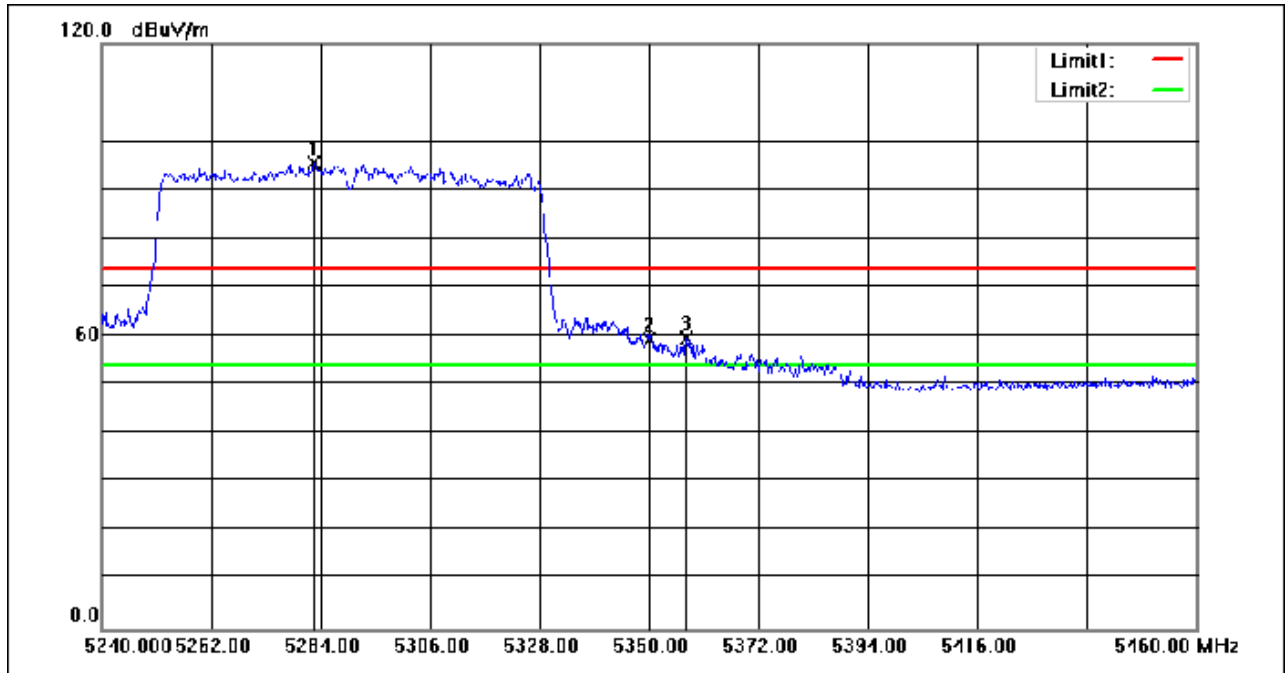

No.	Frequency (MHz)	Reading (dBuV)	Correction factor(dB/m)	Result (dBuV/m)	Limit (dBuV/m)	Margin (dB)	Remark
1	5282.680	105.86	-10.26	95.60	74.00	21.60	peak
2	5350.000	69.24	-9.94	59.30	74.00	-14.70	peak
3	5357.480	69.46	-9.90	59.56	74.00	-14.44	peak



Unless otherwise agreed in writing, this document is issued by the Company subject to its General Conditions of Service printed overleaf, available on request or accessible at <http://www.sgs.com/en/Terms-and-Conditions.aspx> and, for electronic format documents, subject to Terms and Conditions for Electronic Documents at <http://www.sgs.com/en/Terms-and-Conditions/Terms-e-Documents.aspx>. Attention is drawn to the limitation of liability, indemnification and jurisdiction issues defined therein. Any holder of this document is advised that information contained hereon reflects the Company's findings at the time of its intervention only and within the limits of Client's instructions, if any. The Company's sole responsibility is to its Client and this document does not exonerate parties to a transaction from exercising all their rights and obligations under the transaction documents. This document cannot be reproduced except in full, without prior written approval of the Company. Any unauthorized alteration, forgery or falsification of the content or appearance of this document is unlawful and offenders may be prosecuted to the fullest extent of the law. Unless otherwise stated the results shown in this test report refer only to the sample(s) tested and such sample(s) are retained for 30 days only.  
**Attention: To check the authenticity of testing /inspection report & certificate, please contact us at telephone: (86-755) 8307 1443, or email: CN.Doccheck@sgs.com**

No.10, Weiye Road, Innovation Park, Kunshan, Jiangsu, China 215300  
 中国·江苏·昆山市留学生创业园伟业路10号 邮编 215300

t(86-512)57355888 f(86-512)57370818 www.sgsgroup.com.cn  
 t(86-512)57355888 f(86-512)57370818 sgs.china@sgs.com

Test Mode: 02; Polarity: Horizontal; Modulation:802.11ac; Bandwidth:80MHz; Channel:High

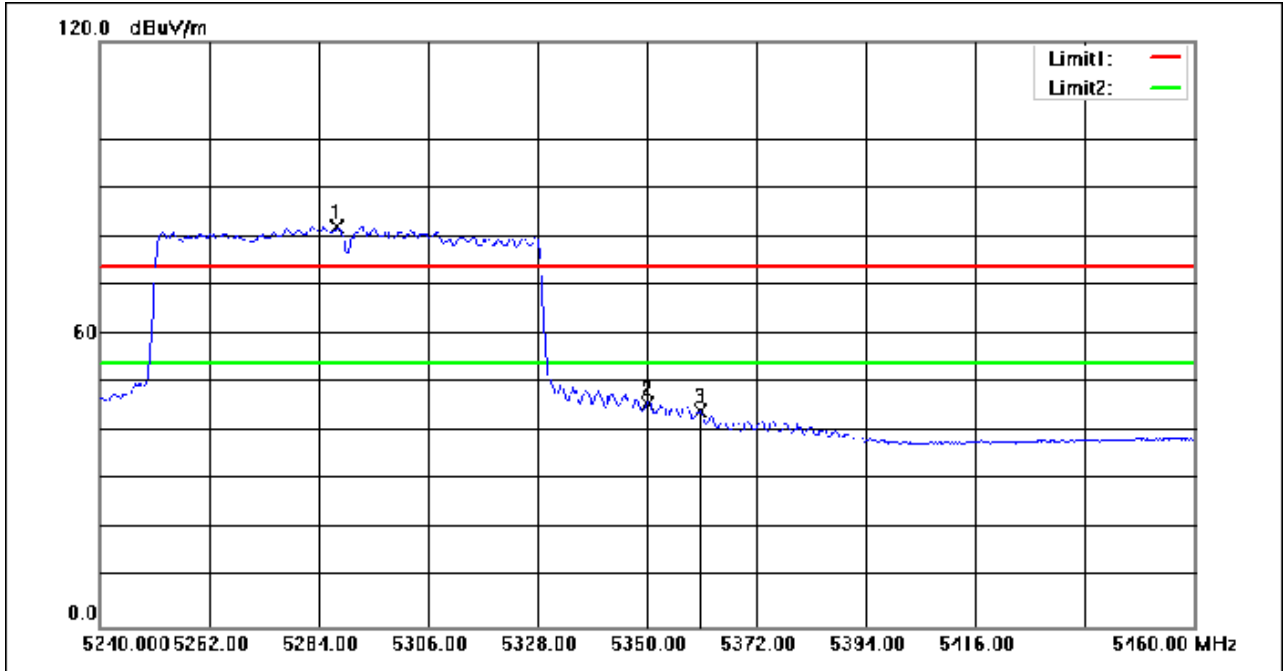

No.	Frequency (MHz)	Reading (dBuV)	Correction factor(dB/m)	Result (dBuV/m)	Limit (dBuV/m)	Margin (dB)	Remark
1	5287.740	92.44	-10.24	82.20	54.00	28.20	AVG
2	5350.000	55.63	-9.94	45.69	54.00	-8.31	AVG
3	5360.560	54.17	-9.89	44.28	54.00	-9.72	AVG



Unless otherwise agreed in writing, this document is issued by the Company subject to its General Conditions of Service printed overleaf, available on request or accessible at <http://www.sgs.com/en/Terms-and-Conditions.aspx> and, for electronic format documents, subject to Terms and Conditions for Electronic Documents at <http://www.sgs.com/en/Terms-and-Conditions/Terms-e-Documents.aspx>. Attention is drawn to the limitation of liability, indemnification and jurisdiction issues defined therein. Any holder of this document is advised that information contained hereon reflects the Company's findings at the time of its intervention only and within the limits of Client's instructions, if any. The Company's sole responsibility is to its Client and this document does not exonerate parties to a transaction from exercising all their rights and obligations under the transaction documents. This document cannot be reproduced except in full, without prior written approval of the Company. Any unauthorized alteration, forgery or falsification of the content or appearance of this document is unlawful and offenders may be prosecuted to the fullest extent of the law. Unless otherwise stated the results shown in this test report refer only to the sample(s) tested and such sample(s) are retained for 30 days only.  
Attention: To check the authenticity of testing /inspection report & certificate, please contact us at telephone: (86-755) 8307 1443, or email: [CN.Doccheck@sgs.com](mailto:CN.Doccheck@sgs.com)

No.10, Weiye Road, Innovation Park, Kunshan, Jiangsu, China 215300  
中国·江苏·昆山市留学生创业园伟业路10号 邮编 215300

t(86-512)57355888 f(86-512)57370818 www.sgs.com.cn  
t(86-512)57355888 f(86-512)57370818 sgs.china@sgs.com

Test Mode: 02; Polarity: Vertical; Modulation:802.11ac; Bandwidth:80MHz; Channel:High

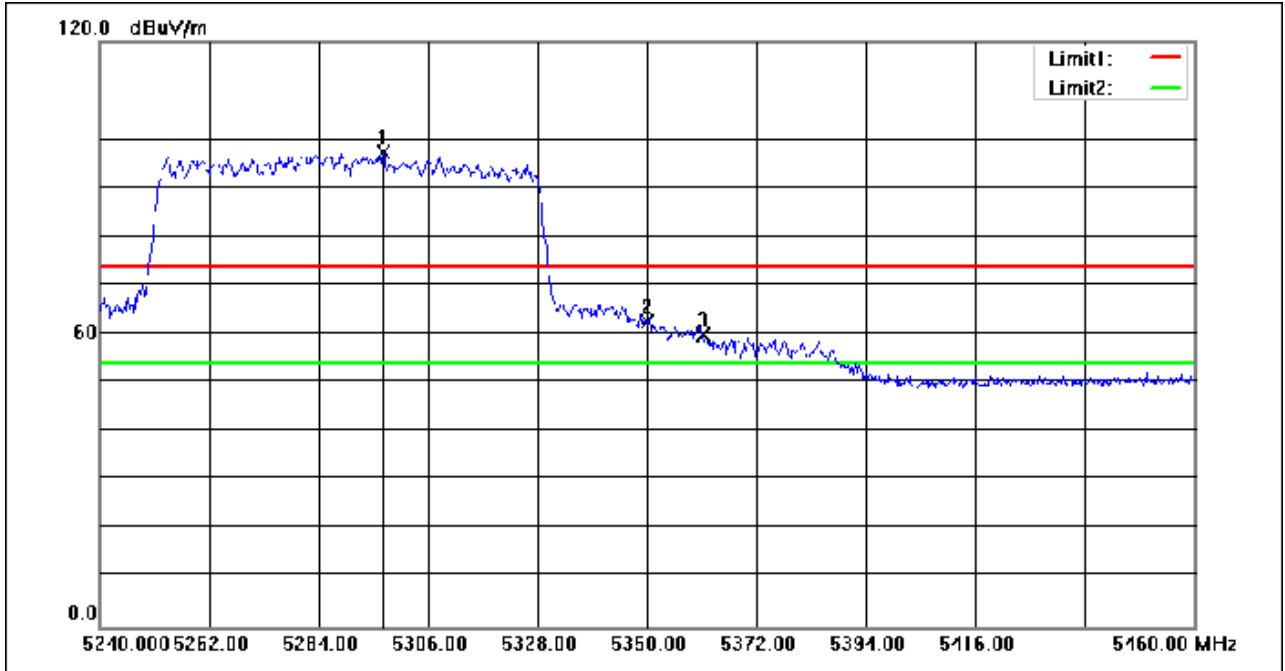

No.	Frequency (MHz)	Reading (dBuV)	Correction factor(dB/m)	Result (dBuV/m)	Limit (dBuV/m)	Margin (dB)	Remark
1	5296.980	107.53	-10.19	97.34	74.00	23.34	peak
2	5350.000	72.53	-9.94	62.59	74.00	-11.41	peak
3	5361.220	69.72	-9.89	59.83	74.00	-14.17	peak



Unless otherwise agreed in writing, this document is issued by the Company subject to its General Conditions of Service printed overleaf, available on request or accessible at <http://www.sgs.com/en/Terms-and-Conditions.aspx> and, for electronic format documents, subject to Terms and Conditions for Electronic Documents at <http://www.sgs.com/en/Terms-and-Conditions/Terms-e-Documents.aspx>. Attention is drawn to the limitation of liability, indemnification and jurisdiction issues defined therein. Any holder of this document is advised that information contained hereon reflects the Company's findings at the time of its intervention only and within the limits of Client's instructions, if any. The Company's sole responsibility is to its Client and this document does not exonerate parties to a transaction from exercising all their rights and obligations under the transaction documents. This document cannot be reproduced except in full, without prior written approval of the Company. Any unauthorized alteration, forgery or falsification of the content or appearance of this document is unlawful and offenders may be prosecuted to the fullest extent of the law. Unless otherwise stated the results shown in this test report refer only to the sample(s) tested and such sample(s) are retained for 30 days only.  
**Attention: To check the authenticity of testing /inspection report & certificate, please contact us at telephone: (86-755) 8307 1443, or email: CN.Doccheck@sgs.com**

No.10, Weiye Road, Innovation Park, Kunshan, Jiangsu, China 215300  
 中国·江苏·昆山市留学生创业园伟业路10号 邮编 215300

t(86-512)57355888 f(86-512)57370818 www.sgsgroup.com.cn  
 t(86-512)57355888 f(86-512)57370818 sgs.china@sgs.com



Test Mode: 02; Polarity: Vertical; Modulation:802.11ac; Bandwidth:80MHz; Channel:High

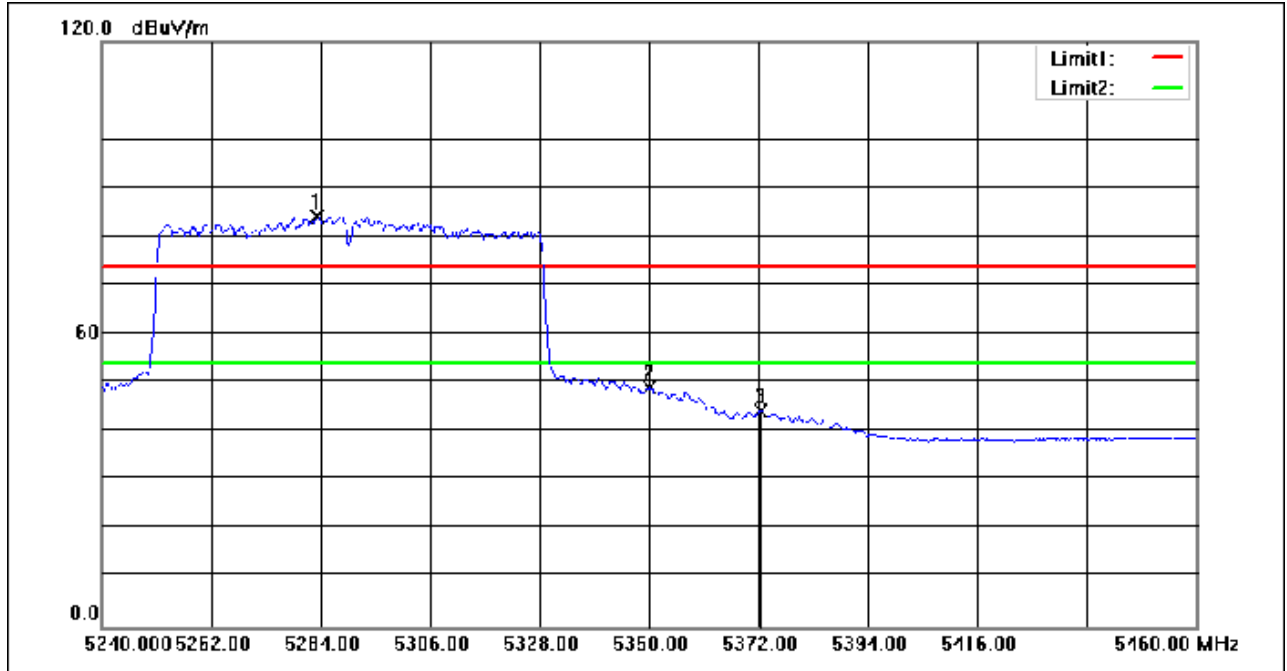

No.	Frequency (MHz)	Reading (dBuV)	Correction factor(dB/m)	Result (dBuV/m)	Limit (dBuV/m)	Margin (dB)	Remark
1	5283.340	94.48	-10.26	84.22	54.00	30.22	AVG
2	5350.000	59.00	-9.94	49.06	54.00	-4.94	AVG
3	5372.440	54.08	-9.83	44.25	54.00	-9.75	AVG



Unless otherwise agreed in writing, this document is issued by the Company subject to its General Conditions of Service printed overleaf, available on request or accessible at <http://www.sgs.com/en/Terms-and-Conditions.aspx> and, for electronic format documents, subject to Terms and Conditions for Electronic Documents at <http://www.sgs.com/en/Terms-and-Conditions/Terms-e-Documents.aspx>. Attention is drawn to the limitation of liability, indemnification and jurisdiction issues defined therein. Any holder of this document is advised that information contained hereon reflects the Company's findings at the time of its intervention only and within the limits of Client's instructions, if any. The Company's sole responsibility is to its Client and this document does not exonerate parties to a transaction from exercising all their rights and obligations under the transaction documents. This document cannot be reproduced except in full, without prior written approval of the Company. Any unauthorized alteration, forgery or falsification of the content or appearance of this document is unlawful and offenders may be prosecuted to the fullest extent of the law. Unless otherwise stated the results shown in this test report refer only to the sample(s) tested and such sample(s) are retained for 30 days only.  
Attention: To check the authenticity of testing /inspection report & certificate, please contact us at telephone: (86-755) 8307 1443, or email: [CN.Doccheck@sgs.com](mailto:CN.Doccheck@sgs.com)

No.10, Weiye Road, Innovation Park, Kunshan, Jiangsu, China 215300  
中国·江苏·昆山市留学生创业园伟业路10号 邮编 215300

t(86-512)57355888 f(86-512)57370818 www.sgsgroup.com.cn  
t(86-512)57355888 f(86-512)57370818 sgs.china@sgs.com

Test Mode: 03; Polarity: Horizontal; Modulation:802.11a; Bandwidth:20MHz; Channel:Low

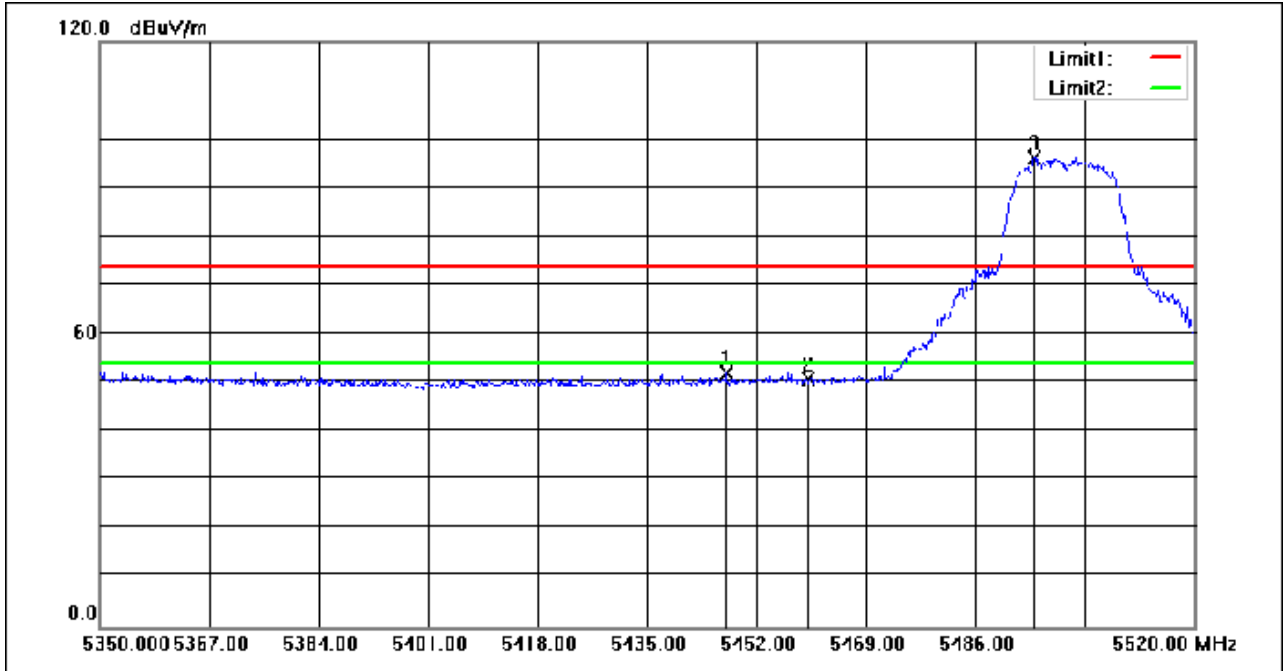

No.	Frequency (MHz)	Reading (dBuV)	Correction factor(dB/m)	Result (dBuV/m)	Limit (dBuV/m)	Margin (dB)	Remark
1	5447.240	61.64	-9.62	52.02	74.00	-21.98	peak
2	5460.000	60.39	-9.59	50.80	74.00	-23.20	peak
3	5495.180	105.65	-9.52	96.13	74.00	22.13	peak



Unless otherwise agreed in writing, this document is issued by the Company subject to its General Conditions of Service printed overleaf, available on request or accessible at <http://www.sgs.com/en/Terms-and-Conditions.aspx> and, for electronic format documents, subject to Terms and Conditions for Electronic Documents at <http://www.sgs.com/en/Terms-and-Conditions/Terms-e-Documents.aspx>. Attention is drawn to the limitation of liability, indemnification and jurisdiction issues defined therein. Any holder of this document is advised that information contained hereon reflects the Company's findings at the time of its intervention only and within the limits of Client's instructions, if any. The Company's sole responsibility is to its Client and this document does not exonerate parties to a transaction from exercising all their rights and obligations under the transaction documents. This document cannot be reproduced except in full, without prior written approval of the Company. Any unauthorized alteration, forgery or falsification of the content or appearance of this document is unlawful and offenders may be prosecuted to the fullest extent of the law. Unless otherwise stated the results shown in this test report refer only to the sample(s) tested and such sample(s) are retained for 30 days only.  
**Attention: To check the authenticity of testing /inspection report & certificate, please contact us at telephone: (86-755) 8307 1443, or email: CN.Doccheck@sgs.com**

No.10, Weiye Road, Innovation Park, Kunshan, Jiangsu, China 215300  
 中国·江苏·昆山市留学生创业园伟业路10号 邮编 215300

t(86-512)57355888 f(86-512)57370818 www.sgsgroup.com.cn  
 t(86-512)57355888 f(86-512)57370818 sgs.china@sgs.com

Test Mode: 03; Polarity: Vertical; Modulation:802.11a; Bandwidth:20MHz; Channel:Low

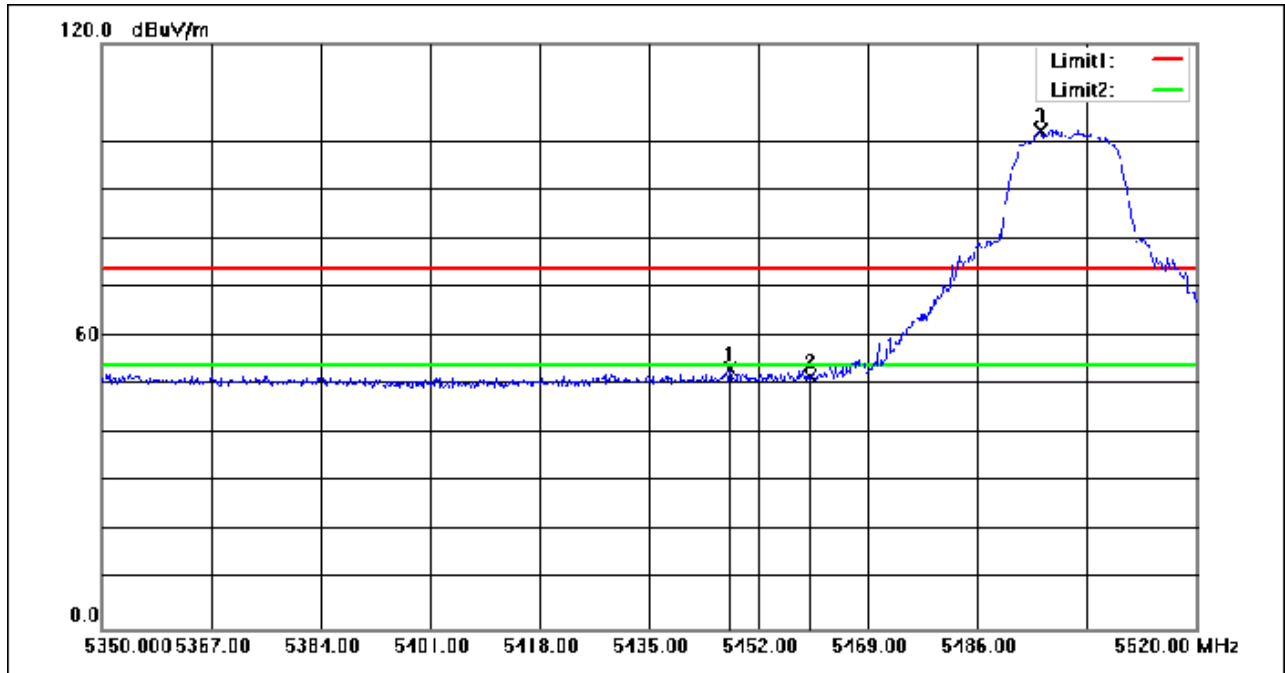

No.	Frequency (MHz)	Reading (dBuV)	Correction factor(dB/m)	Result (dBuV/m)	Limit (dBuV/m)	Margin (dB)	Remark
1	5447.580	62.86	-9.62	53.24	74.00	-20.76	peak
2	5460.000	61.39	-9.59	51.80	74.00	-22.20	peak
3	5495.860	111.78	-9.52	102.26	74.00	28.26	peak



Unless otherwise agreed in writing, this document is issued by the Company subject to its General Conditions of Service printed overleaf, available on request or accessible at <http://www.sgs.com/en/Terms-and-Conditions.aspx> and, for electronic format documents, subject to Terms and Conditions for Electronic Documents at <http://www.sgs.com/en/Terms-and-Conditions/Terms-e-Documents.aspx>. Attention is drawn to the limitation of liability, indemnification and jurisdiction issues defined therein. Any holder of this document is advised that information contained hereon reflects the Company's findings at the time of its intervention only and within the limits of Client's instructions, if any. The Company's sole responsibility is to its Client and this document does not exonerate parties to a transaction from exercising all their rights and obligations under the transaction documents. This document cannot be reproduced except in full, without prior written approval of the Company. Any unauthorized alteration, forgery or falsification of the content or appearance of this document is unlawful and offenders may be prosecuted to the fullest extent of the law. Unless otherwise stated the results shown in this test report refer only to the sample(s) tested and such sample(s) are retained for 30 days only.  
**Attention: To check the authenticity of testing /inspection report & certificate, please contact us at telephone: (86-755) 8307 1443, or email: CN.Doccheck@sgs.com**

No.10, Weiye Road, Innovation Park, Kunshan, Jiangsu, China 215300  
 中国·江苏·昆山市留学生创业园伟业路10号 邮编 215300

t(86-512)57355888 f(86-512)57370818 www.sgsgroup.com.cn  
 t(86-512)57355888 f(86-512)57370818 sgs.china@sgs.com

Test Mode: 03; Polarity: Horizontal; Modulation:802.11n; Bandwidth:20MHz; Channel:Low

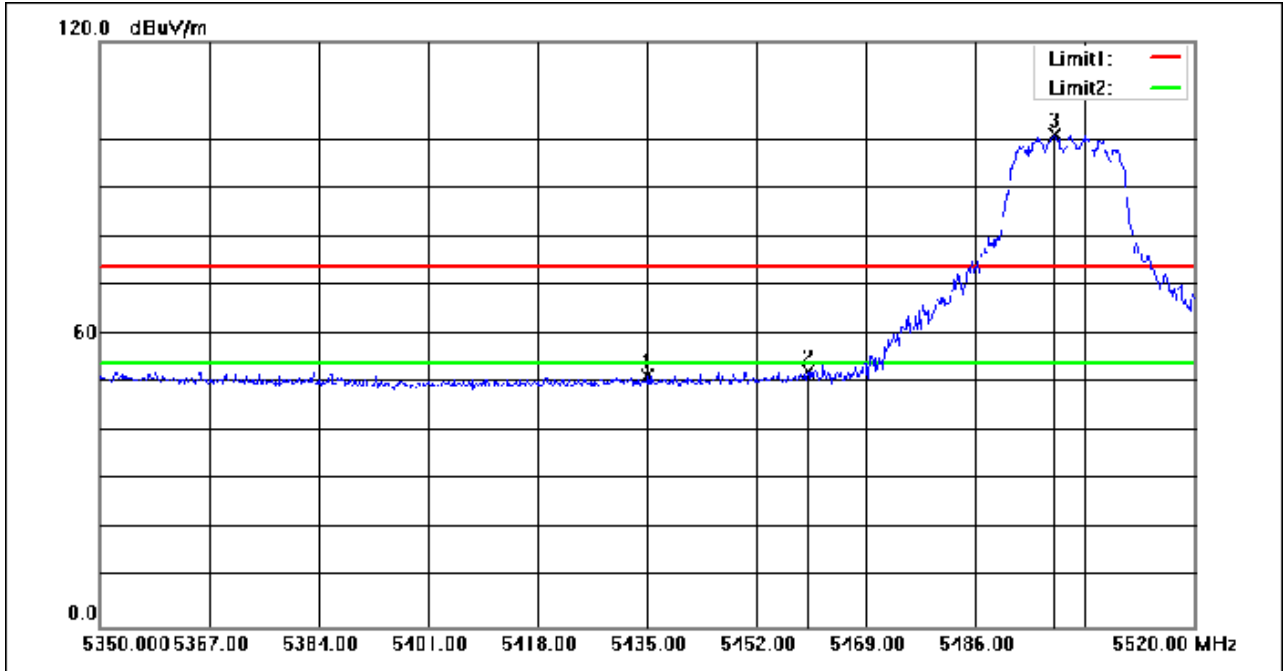

No.	Frequency (MHz)	Reading (dBuV)	Correction factor(dB/m)	Result (dBuV/m)	Limit (dBuV/m)	Margin (dB)	Remark
1	5435.170	61.22	-9.63	51.59	74.00	-22.41	peak
2	5460.000	61.86	-9.59	52.27	74.00	-21.73	peak
3	5498.240	110.39	-9.51	100.88	74.00	26.88	peak



Unless otherwise agreed in writing, this document is issued by the Company subject to its General Conditions of Service printed overleaf, available on request or accessible at <http://www.sgs.com/en/Terms-and-Conditions.aspx> and, for electronic format documents, subject to Terms and Conditions for Electronic Documents at <http://www.sgs.com/en/Terms-and-Conditions/Terms-e-Documents.aspx>. Attention is drawn to the limitation of liability, indemnification and jurisdiction issues defined therein. Any holder of this document is advised that information contained hereon reflects the Company's findings at the time of its intervention only and within the limits of Client's instructions, if any. The Company's sole responsibility is to its Client and this document does not exonerate parties to a transaction from exercising all their rights and obligations under the transaction documents. This document cannot be reproduced except in full, without prior written approval of the Company. Any unauthorized alteration, forgery or falsification of the content or appearance of this document is unlawful and offenders may be prosecuted to the fullest extent of the law. Unless otherwise stated the results shown in this test report refer only to the sample(s) tested and such sample(s) are retained for 30 days only.  
**Attention: To check the authenticity of testing /inspection report & certificate, please contact us at telephone: (86-755) 8307 1443, or email: CN.Doccheck@sgs.com**

No.10, Weiye Road, Innovation Park, Kunshan, Jiangsu, China 215300  
 中国·江苏·昆山市留学生创业园伟业路10号 邮编 215300

t(86-512)57355888 f(86-512)57370818 www.sgsgroup.com.cn  
 t(86-512)57355888 f(86-512)57370818 sgs.china@sgs.com

Test Mode: 03; Polarity: Vertical; Modulation:802.11n; Bandwidth:20MHz; Channel:Low

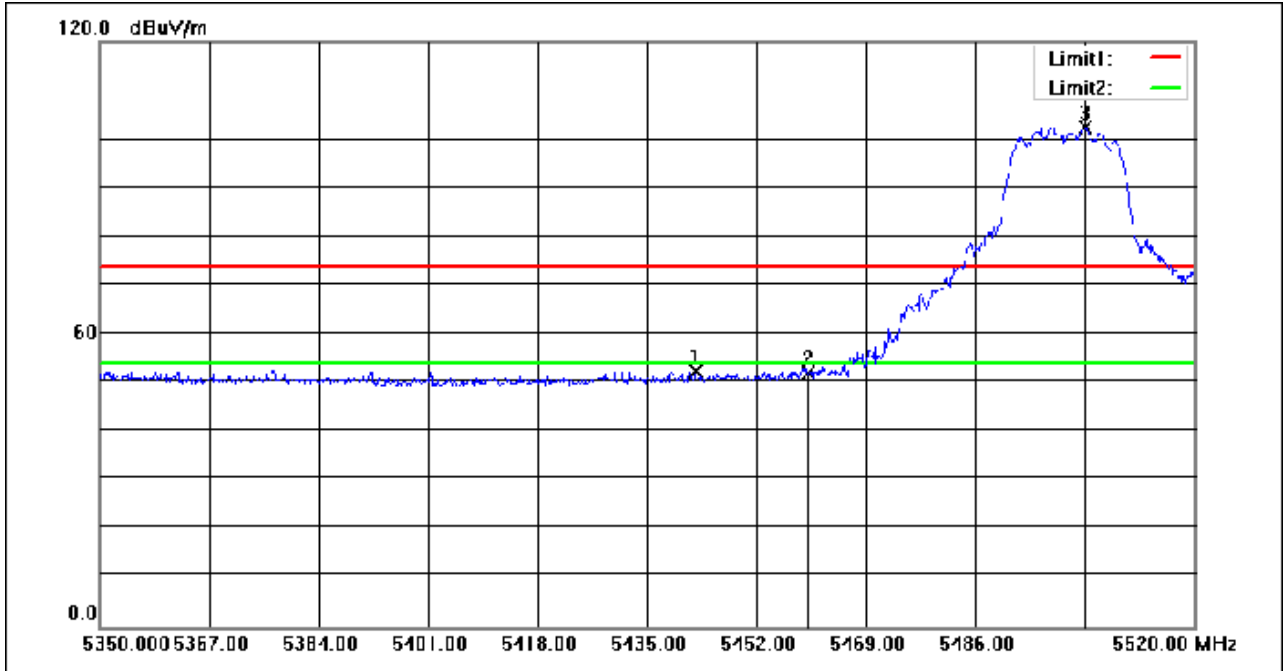

No.	Frequency (MHz)	Reading (dBuV)	Correction factor(dB/m)	Result (dBuV/m)	Limit (dBuV/m)	Margin (dB)	Remark
1	5442.480	61.91	-9.62	52.29	74.00	-21.71	peak
2	5460.000	61.77	-9.59	52.18	74.00	-21.82	peak
3	5503.000	112.06	-9.51	102.55	74.00	28.55	peak



Unless otherwise agreed in writing, this document is issued by the Company subject to its General Conditions of Service printed overleaf, available on request or accessible at <http://www.sgs.com/en/Terms-and-Conditions.aspx> and, for electronic format documents, subject to Terms and Conditions for Electronic Documents at <http://www.sgs.com/en/Terms-and-Conditions/Terms-e-Documents.aspx>. Attention is drawn to the limitation of liability, indemnification and jurisdiction issues defined therein. Any holder of this document is advised that information contained hereon reflects the Company's findings at the time of its intervention only and within the limits of Client's instructions, if any. The Company's sole responsibility is to its Client and this document does not exonerate parties to a transaction from exercising all their rights and obligations under the transaction documents. This document cannot be reproduced except in full, without prior written approval of the Company. Any unauthorized alteration, forgery or falsification of the content or appearance of this document is unlawful and offenders may be prosecuted to the fullest extent of the law. Unless otherwise stated the results shown in this test report refer only to the sample(s) tested and such sample(s) are retained for 30 days only.  
**Attention: To check the authenticity of testing /inspection report & certificate, please contact us at telephone: (86-755) 8307 1443, or email: CN.Doccheck@sgs.com**

No.10, Weiye Road, Innovation Park, Kunshan, Jiangsu, China 215300  
 中国·江苏·昆山市留学生创业园伟业路10号 邮编 215300

t(86-512)57355888 f(86-512)57370818 www.sgsgroup.com.cn  
 t(86-512)57355888 f(86-512)57370818 sgs.china@sgs.com



## Compliance Certification Services (Kunshan) Inc.

Report No.: KSCR221000189002

Page: 207 of 607

Test Mode: 03; Polarity: Horizontal; Modulation:802.11n; Bandwidth:40MHz; Channel:Low

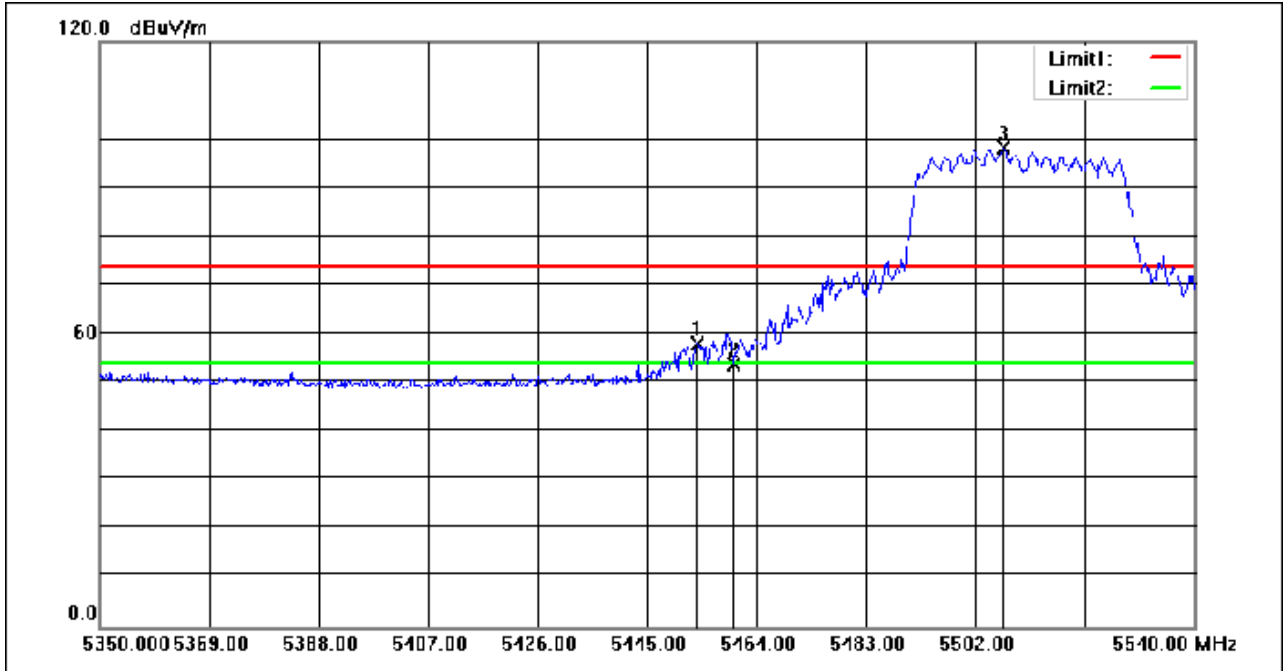

No.	Frequency (MHz)	Reading (dBuV)	Correction factor(dB/m)	Result (dBuV/m)	Limit (dBuV/m)	Margin (dB)	Remark
1	5453.740	67.61	-9.60	58.01	74.00	-15.99	peak
2	5460.000	63.48	-9.59	53.89	74.00	-20.11	peak
3	5506.940	107.76	-9.50	98.26	74.00	24.26	peak



Unless otherwise agreed in writing, this document is issued by the Company subject to its General Conditions of Service printed overleaf, available on request or accessible at <http://www.sgs.com/en/Terms-and-Conditions.aspx> and, for electronic format documents, subject to Terms and Conditions for Electronic Documents at <http://www.sgs.com/en/Terms-and-Conditions/Terms-e-Documents.aspx>. Attention is drawn to the limitation of liability, indemnification and jurisdiction issues defined therein. Any holder of this document is advised that information contained hereon reflects the Company's findings at the time of its intervention only and within the limits of Client's instructions, if any. The Company's sole responsibility is to its Client and this document does not exonerate parties to a transaction from exercising all their rights and obligations under the transaction documents. This document cannot be reproduced except in full, without prior written approval of the Company. Any unauthorized alteration, forgery or falsification of the content or appearance of this document is unlawful and offenders may be prosecuted to the fullest extent of the law. Unless otherwise stated the results shown in this test report refer only to the sample(s) tested and such sample(s) are retained for 30 days only.  
**Attention: To check the authenticity of testing /inspection report & certificate, please contact us at telephone: (86-755) 8307 1443, or email: CN.Doccheck@sgs.com**

No.10, Weiye Road, Innovation Park, Kunshan, Jiangsu, China 215300  
 中国·江苏·昆山市留学生创业园伟业路10号 邮编 215300

t(86-512)57355888 f(86-512)57370818 www.sgsgroup.com.cn  
 t(86-512)57355888 f(86-512)57370818 sgs.china@sgs.com

Test Mode: 03; Polarity: Horizontal; Modulation:802.11n; Bandwidth:40MHz; Channel:Low

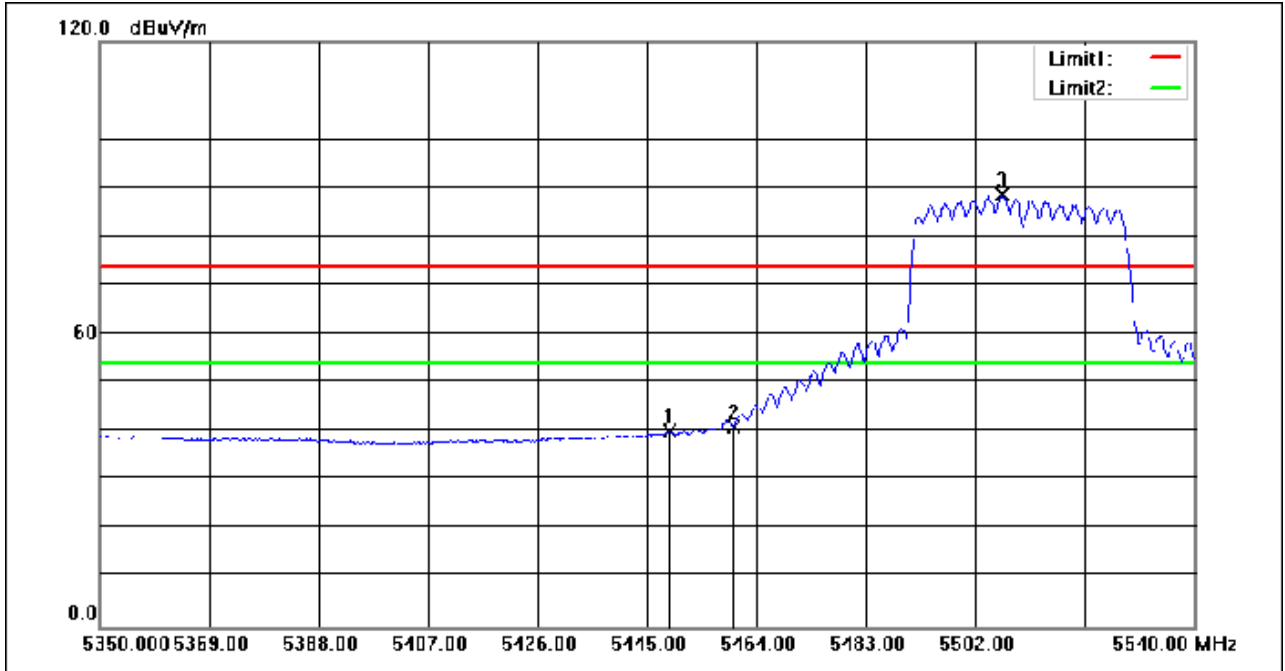

No.	Frequency (MHz)	Reading (dBuV)	Correction factor(dB/m)	Result (dBuV/m)	Limit (dBuV/m)	Margin (dB)	Remark
1	5448.990	49.59	-9.61	39.98	54.00	-14.02	AVG
2	5460.000	50.60	-9.59	41.01	54.00	-12.99	AVG
3	5506.750	98.07	-9.51	88.56	54.00	34.56	AVG



Unless otherwise agreed in writing, this document is issued by the Company subject to its General Conditions of Service printed overleaf, available on request or accessible at <http://www.sgs.com/en/Terms-and-Conditions.aspx> and, for electronic format documents, subject to Terms and Conditions for Electronic Documents at <http://www.sgs.com/en/Terms-and-Conditions/Terms-e-Documents.aspx>. Attention is drawn to the limitation of liability, indemnification and jurisdiction issues defined therein. Any holder of this document is advised that information contained hereon reflects the Company's findings at the time of its intervention only and within the limits of Client's instructions, if any. The Company's sole responsibility is to its Client and this document does not exonerate parties to a transaction from exercising all their rights and obligations under the transaction documents. This document cannot be reproduced except in full, without prior written approval of the Company. Any unauthorized alteration, forgery or falsification of the content or appearance of this document is unlawful and offenders may be prosecuted to the fullest extent of the law. Unless otherwise stated the results shown in this test report refer only to the sample(s) tested and such sample(s) are retained for 30 days only.  
**Attention: To check the authenticity of testing /inspection report & certificate, please contact us at telephone: (86-755) 8307 1443, or email: CN.Doccheck@sgs.com**

No.10, Weiye Road, Innovation Park, Kunshan, Jiangsu, China 215300  
 中国·江苏·昆山市留学生创业园伟业路10号 邮编 215300

t(86-512)57355888 f(86-512)57370818 www.sgsgroup.com.cn  
 t(86-512)57355888 f(86-512)57370818 sgs.china@sgs.com

Test Mode: 03; Polarity: Vertical; Modulation:802.11n; Bandwidth:40MHz; Channel:Low

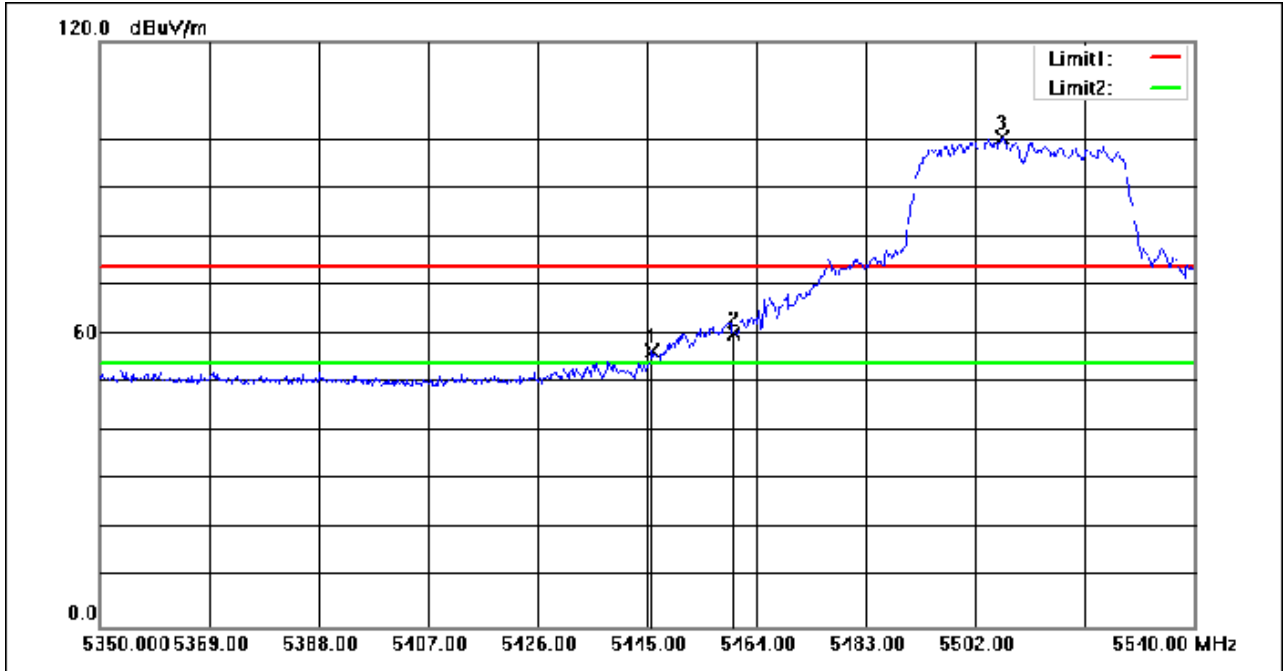

No.	Frequency (MHz)	Reading (dBuV)	Correction factor(dB/m)	Result (dBuV/m)	Limit (dBuV/m)	Margin (dB)	Remark
1	5445.950	66.14	-9.62	56.52	74.00	-17.48	peak
2	5460.000	69.80	-9.59	60.21	74.00	-13.79	peak
3	5506.560	109.87	-9.51	100.36	74.00	26.36	peak



Unless otherwise agreed in writing, this document is issued by the Company subject to its General Conditions of Service printed overleaf, available on request or accessible at <http://www.sgs.com/en/Terms-and-Conditions.aspx> and, for electronic format documents, subject to Terms and Conditions for Electronic Documents at <http://www.sgs.com/en/Terms-and-Conditions/Terms-e-Documents.aspx>. Attention is drawn to the limitation of liability, indemnification and jurisdiction issues defined therein. Any holder of this document is advised that information contained hereon reflects the Company's findings at the time of its intervention only and within the limits of Client's instructions, if any. The Company's sole responsibility is to its Client and this document does not exonerate parties to a transaction from exercising all their rights and obligations under the transaction documents. This document cannot be reproduced except in full, without prior written approval of the Company. Any unauthorized alteration, forgery or falsification of the content or appearance of this document is unlawful and offenders may be prosecuted to the fullest extent of the law. Unless otherwise stated the results shown in this test report refer only to the sample(s) tested and such sample(s) are retained for 30 days only.  
**Attention: To check the authenticity of testing /inspection report & certificate, please contact us at telephone: (86-755) 8307 1443, or email: CN.Doccheck@sgs.com**

No.10, Weiye Road, Innovation Park, Kunshan, Jiangsu, China 215300  
 中国·江苏·昆山市留学院创业园伟业路10号 邮编 215300

t(86-512)57355888 f(86-512)57370818 www.sgs.com.cn  
 t(86-512)57355888 f(86-512)57370818 sgs.china@sgs.com

Test Mode: 03; Polarity: Vertical; Modulation:802.11n; Bandwidth:40MHz; Channel:Low

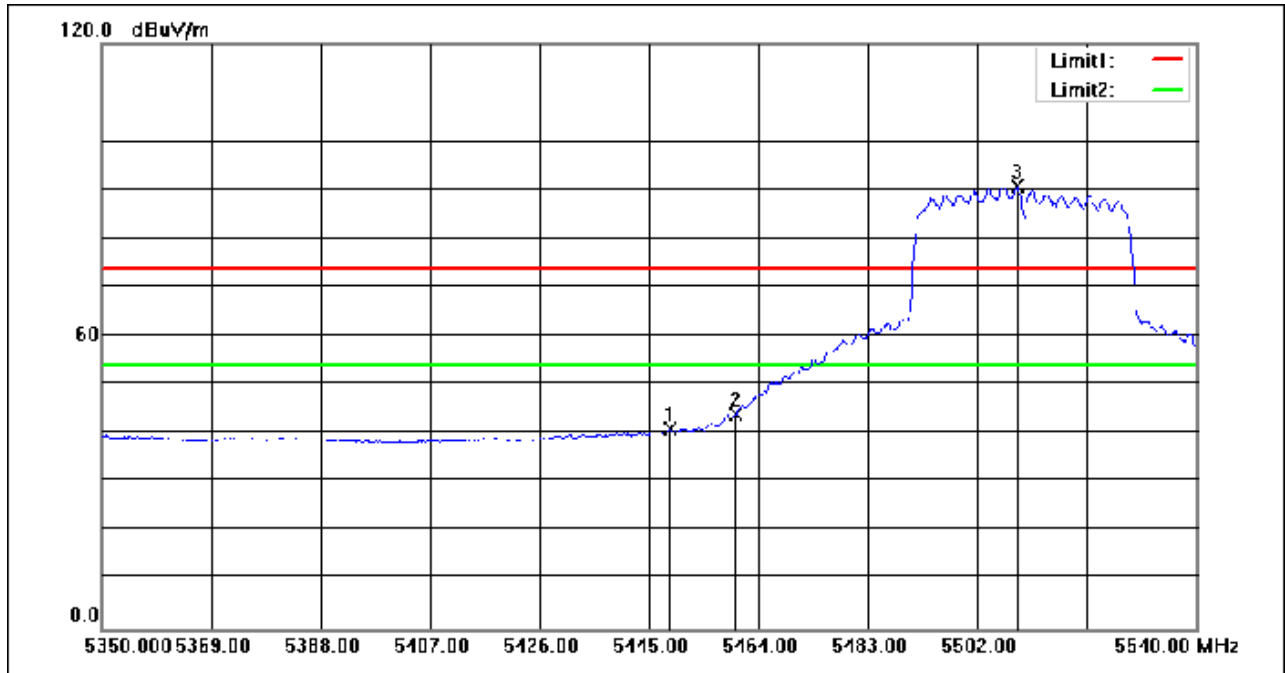

No.	Frequency (MHz)	Reading (dBuV)	Correction factor(dB/m)	Result (dBuV/m)	Limit (dBuV/m)	Margin (dB)	Remark
1	5448.610	50.49	-9.61	40.88	54.00	-13.12	AVG
2	5460.000	53.53	-9.59	43.94	54.00	-10.06	AVG
3	5508.840	100.12	-9.50	90.62	54.00	36.62	AVG



Unless otherwise agreed in writing, this document is issued by the Company subject to its General Conditions of Service printed overleaf, available on request or accessible at <http://www.sgs.com/en/Terms-and-Conditions.aspx> and, for electronic format documents, subject to Terms and Conditions for Electronic Documents at <http://www.sgs.com/en/Terms-and-Conditions/Terms-e-Documents.aspx>. Attention is drawn to the limitation of liability, indemnification and jurisdiction issues defined therein. Any holder of this document is advised that information contained hereon reflects the Company's findings at the time of its intervention only and within the limits of Client's instructions, if any. The Company's sole responsibility is to its Client and this document does not exonerate parties to a transaction from exercising all their rights and obligations under the transaction documents. This document cannot be reproduced except in full, without prior written approval of the Company. Any unauthorized alteration, forgery or falsification of the content or appearance of this document is unlawful and offenders may be prosecuted to the fullest extent of the law. Unless otherwise stated the results shown in this test report refer only to the sample(s) tested and such sample(s) are retained for 30 days only.  
**Attention: To check the authenticity of testing /inspection report & certificate, please contact us at telephone: (86-755) 8307 1443, or email: CN.Doccheck@sgs.com**

No.10, Weiye Road, Innovation Park, Kunshan, Jiangsu, China 215300  
 中国·江苏·昆山市留学生创业园伟业路10号 邮编 215300

t(86-512)57355888 f(86-512)57370818 www.sgsgroup.com.cn  
 t(86-512)57355888 f(86-512)57370818 sgs.china@sgs.com

Test Mode: 03; Polarity: Horizontal; Modulation:802.11ac; Bandwidth:20MHz; Channel:Low

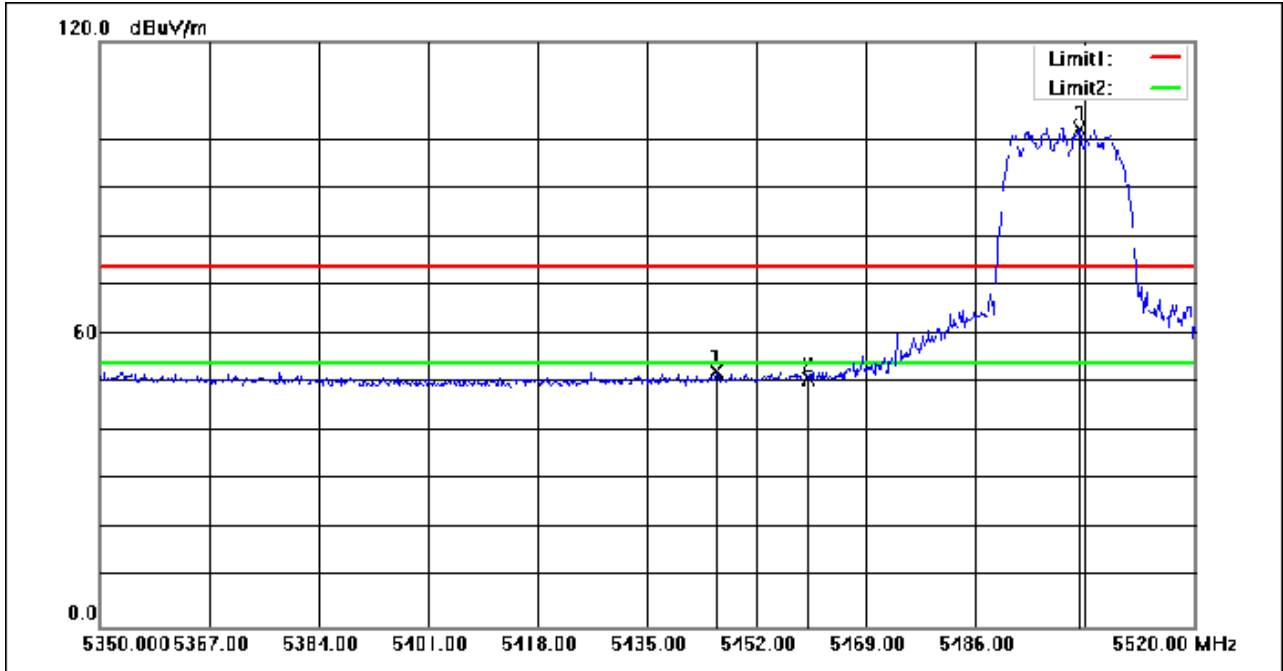

No.	Frequency (MHz)	Reading (dBuV)	Correction factor(dB/m)	Result (dBuV/m)	Limit (dBuV/m)	Margin (dB)	Remark
1	5445.710	61.93	-9.62	52.31	74.00	-21.69	peak
2	5460.000	60.40	-9.59	50.81	74.00	-23.19	peak
3	5502.150	111.80	-9.52	102.28	74.00	28.28	peak



Unless otherwise agreed in writing, this document is issued by the Company subject to its General Conditions of Service printed overleaf, available on request or accessible at <http://www.sgs.com/en/Terms-and-Conditions.aspx> and, for electronic format documents, subject to Terms and Conditions for Electronic Documents at <http://www.sgs.com/en/Terms-and-Conditions/Terms-e-Documents.aspx>. Attention is drawn to the limitation of liability, indemnification and jurisdiction issues defined therein. Any holder of this document is advised that information contained hereon reflects the Company's findings at the time of its intervention only and within the limits of Client's instructions, if any. The Company's sole responsibility is to its Client and this document does not exonerate parties to a transaction from exercising all their rights and obligations under the transaction documents. This document cannot be reproduced except in full, without prior written approval of the Company. Any unauthorized alteration, forgery or falsification of the content or appearance of this document is unlawful and offenders may be prosecuted to the fullest extent of the law. Unless otherwise stated the results shown in this test report refer only to the sample(s) tested and such sample(s) are retained for 30 days only.  
**Attention: To check the authenticity of testing /inspection report & certificate, please contact us at telephone: (86-755) 8307 1443, or email: CN.Doccheck@sgs.com**

No.10, Weiye Road, Innovation Park, Kunshan, Jiangsu, China 215300  
 中国·江苏·昆山市留学生创业园伟业路10号 邮编 215300

t(86-512)57355888 f(86-512)57370818 www.sgsgroup.com.cn  
 t(86-512)57355888 f(86-512)57370818 sgs.china@sgs.com



Test Mode: 03; Polarity: Vertical; Modulation:802.11ac; Bandwidth:20MHz; Channel:Low

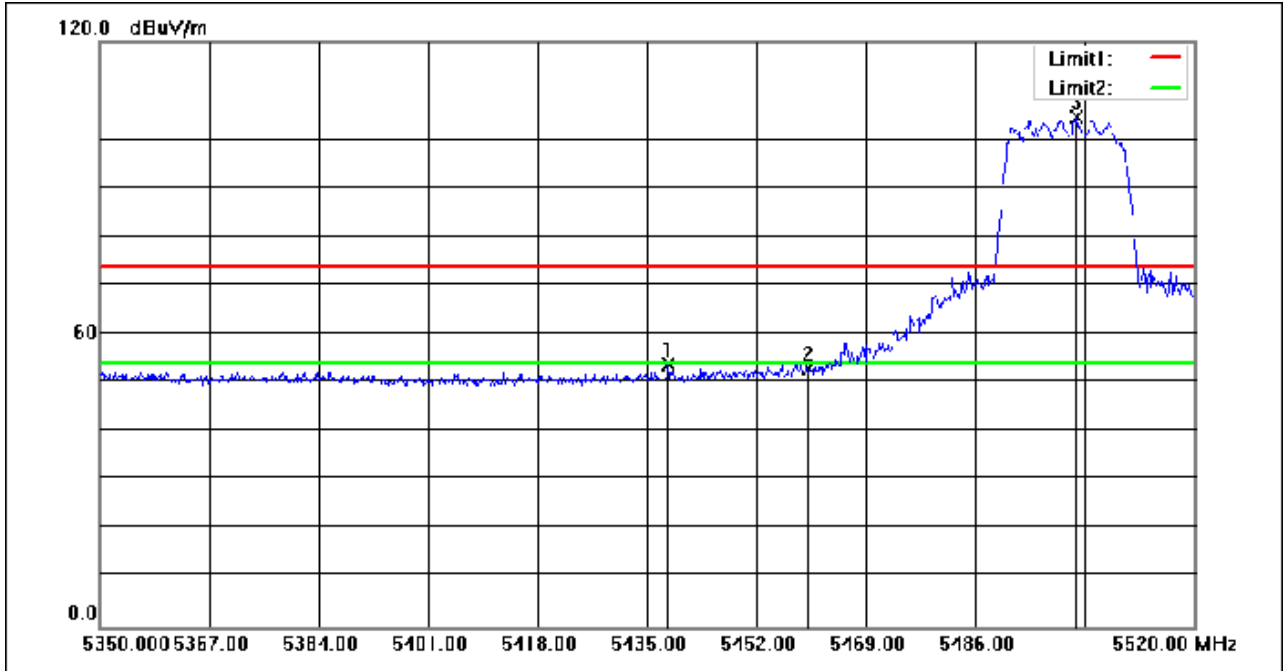

No.	Frequency (MHz)	Reading (dBuV)	Correction factor(dB/m)	Result (dBuV/m)	Limit (dBuV/m)	Margin (dB)	Remark
1	5438.230	63.51	-9.63	53.88	74.00	-20.12	peak
2	5460.000	62.62	-9.59	53.03	74.00	-20.97	peak
3	5501.810	114.01	-9.52	104.49	74.00	30.49	peak



Unless otherwise agreed in writing, this document is issued by the Company subject to its General Conditions of Service printed overleaf, available on request or accessible at <http://www.sgs.com/en/Terms-and-Conditions.aspx> and, for electronic format documents, subject to Terms and Conditions for Electronic Documents at <http://www.sgs.com/en/Terms-and-Conditions/Terms-e-Documents.aspx>. Attention is drawn to the limitation of liability, indemnification and jurisdiction issues defined therein. Any holder of this document is advised that information contained hereon reflects the Company's findings at the time of its intervention only and within the limits of Client's instructions, if any. The Company's sole responsibility is to its Client and this document does not exonerate parties to a transaction from exercising all their rights and obligations under the transaction documents. This document cannot be reproduced except in full, without prior written approval of the Company. Any unauthorized alteration, forgery or falsification of the content or appearance of this document is unlawful and offenders may be prosecuted to the fullest extent of the law. Unless otherwise stated the results shown in this test report refer only to the sample(s) tested and such sample(s) are retained for 30 days only.  
**Attention: To check the authenticity of testing /inspection report & certificate, please contact us at telephone: (86-755) 8307 1443, or email: CN.Doccheck@sgs.com**

No.10, Weiye Road, Innovation Park, Kunshan, Jiangsu, China 215300  
 中国·江苏·昆山市留学生创业园伟业路10号 邮编 215300

t(86-512)57355888 f(86-512)57370818 www.sgsgroup.com.cn  
 t(86-512)57355888 f(86-512)57370818 sgs.china@sgs.com

Test Mode: 03; Polarity: Horizontal; Modulation:802.11ac; Bandwidth:40MHz; Channel:Low

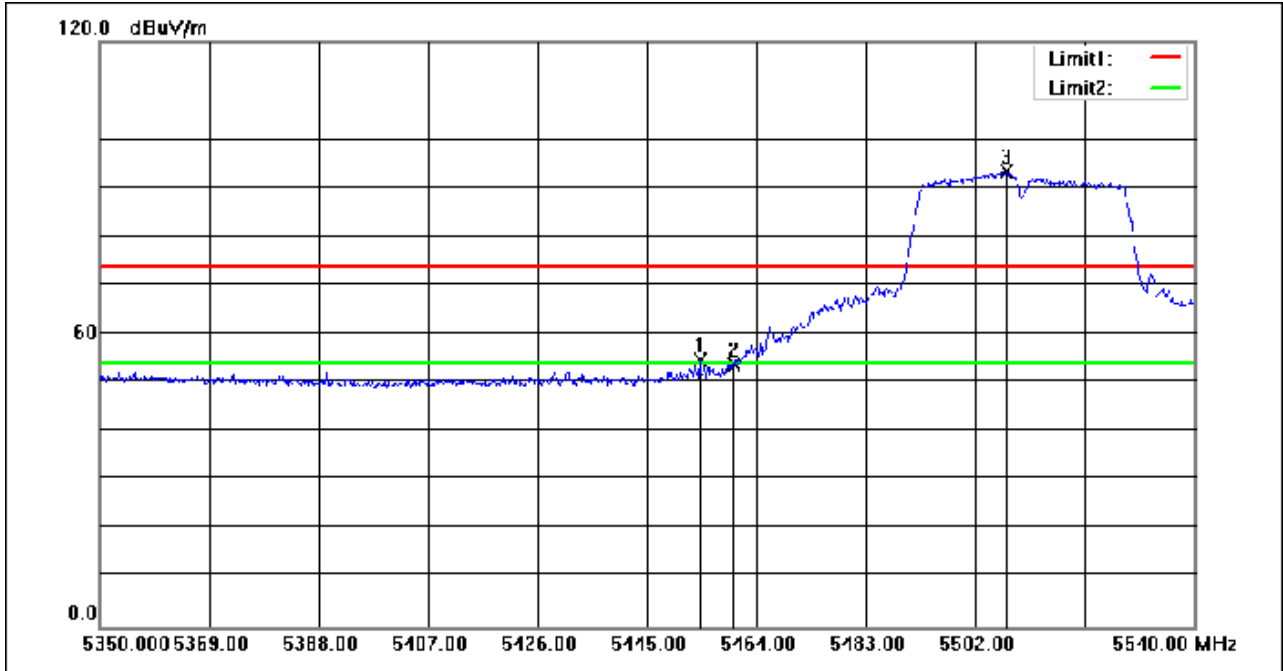

No.	Frequency (MHz)	Reading (dBuV)	Correction factor(dB/m)	Result (dBuV/m)	Limit (dBuV/m)	Margin (dB)	Remark
1	5454.120	64.29	-9.60	54.69	74.00	-19.31	peak
2	5460.000	63.31	-9.59	53.72	74.00	-20.28	peak
3	5507.510	102.84	-9.50	93.34	74.00	19.34	peak



Unless otherwise agreed in writing, this document is issued by the Company subject to its General Conditions of Service printed overleaf, available on request or accessible at <http://www.sgs.com/en/Terms-and-Conditions.aspx> and, for electronic format documents, subject to Terms and Conditions for Electronic Documents at <http://www.sgs.com/en/Terms-and-Conditions/Terms-e-Documents.aspx>. Attention is drawn to the limitation of liability, indemnification and jurisdiction issues defined therein. Any holder of this document is advised that information contained hereon reflects the Company's findings at the time of its intervention only and within the limits of Client's instructions, if any. The Company's sole responsibility is to its Client and this document does not exonerate parties to a transaction from exercising all their rights and obligations under the transaction documents. This document cannot be reproduced except in full, without prior written approval of the Company. Any unauthorized alteration, forgery or falsification of the content or appearance of this document is unlawful and offenders may be prosecuted to the fullest extent of the law. Unless otherwise stated the results shown in this test report refer only to the sample(s) tested and such sample(s) are retained for 30 days only.  
**Attention: To check the authenticity of testing /inspection report & certificate, please contact us at telephone: (86-755) 8307 1443, or email: CN.Doccheck@sgs.com**

No.10, Weiye Road, Innovation Park, Kunshan, Jiangsu, China 215300  
 中国·江苏·昆山市留学生创业园伟业路10号 邮编 215300

t(86-512)57355888 f(86-512)57370818 www.sgsgroup.com.cn  
 t(86-512)57355888 f(86-512)57370818 sgs.china@sgs.com

Test Mode: 03; Polarity: Horizontal; Modulation:802.11ac; Bandwidth:40MHz; Channel:Low

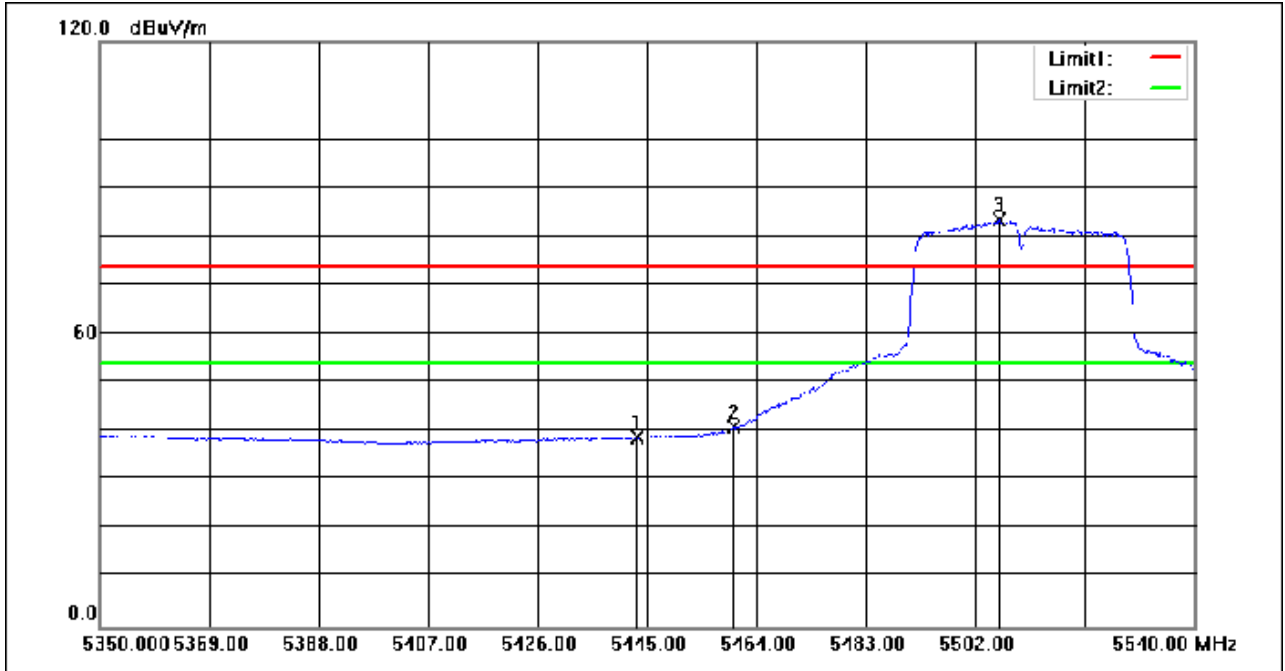

No.	Frequency (MHz)	Reading (dBuV)	Correction factor(dB/m)	Result (dBuV/m)	Limit (dBuV/m)	Margin (dB)	Remark
1	5443.290	48.53	-9.62	38.91	54.00	-15.09	AVG
2	5460.000	50.42	-9.59	40.83	54.00	-13.17	AVG
3	5506.180	92.97	-9.51	83.46	54.00	29.46	AVG



Unless otherwise agreed in writing, this document is issued by the Company subject to its General Conditions of Service printed overleaf, available on request or accessible at <http://www.sgs.com/en/Terms-and-Conditions.aspx> and, for electronic format documents, subject to Terms and Conditions for Electronic Documents at <http://www.sgs.com/en/Terms-and-Conditions/Terms-e-Documents.aspx>. Attention is drawn to the limitation of liability, indemnification and jurisdiction issues defined therein. Any holder of this document is advised that information contained hereon reflects the Company's findings at the time of its intervention only and within the limits of Client's instructions, if any. The Company's sole responsibility is to its Client and this document does not exonerate parties to a transaction from exercising all their rights and obligations under the transaction documents. This document cannot be reproduced except in full, without prior written approval of the Company. Any unauthorized alteration, forgery or falsification of the content or appearance of this document is unlawful and offenders may be prosecuted to the fullest extent of the law. Unless otherwise stated the results shown in this test report refer only to the sample(s) tested and such sample(s) are retained for 30 days only.  
**Attention: To check the authenticity of testing /inspection report & certificate, please contact us at telephone: (86-755) 8307 1443, or email: CN.Doccheck@sgs.com**

No.10, Weiye Road, Innovation Park, Kunshan, Jiangsu, China 215300  
 中国·江苏·昆山市留学生创业园伟业路10号 邮编 215300

t(86-512)57355888 f(86-512)57370818 www.sgs.com.cn  
 t(86-512)57355888 f(86-512)57370818 sgs.china@sgs.com

Test Mode: 03; Polarity: Vertical; Modulation:802.11ac; Bandwidth:40MHz; Channel:Low

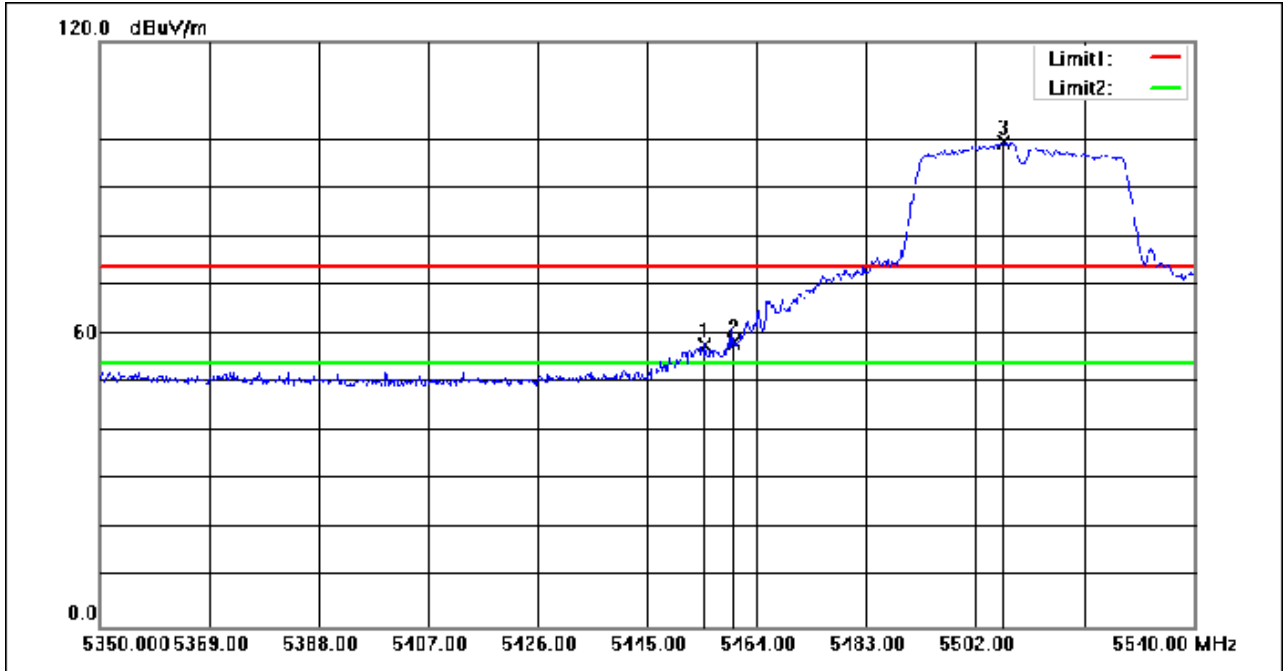

No.	Frequency (MHz)	Reading (dBuV)	Correction factor (dB/m)	Result (dBuV/m)	Limit (dBuV/m)	Margin (dB)	Remark
1	5455.070	67.50	-9.60	57.90	74.00	-16.10	peak
2	5460.000	67.89	-9.59	58.30	74.00	-15.70	peak
3	5506.940	108.81	-9.50	99.31	74.00	25.31	peak



Unless otherwise agreed in writing, this document is issued by the Company subject to its General Conditions of Service printed overleaf, available on request or accessible at <http://www.sgs.com/en/Terms-and-Conditions.aspx> and, for electronic format documents, subject to Terms and Conditions for Electronic Documents at <http://www.sgs.com/en/Terms-and-Conditions/Terms-e-Documents.aspx>. Attention is drawn to the limitation of liability, indemnification and jurisdiction issues defined therein. Any holder of this document is advised that information contained hereon reflects the Company's findings at the time of its intervention only and within the limits of Client's instructions, if any. The Company's sole responsibility is to its Client and this document does not exonerate parties to a transaction from exercising all their rights and obligations under the transaction documents. This document cannot be reproduced except in full, without prior written approval of the Company. Any unauthorized alteration, forgery or falsification of the content or appearance of this document is unlawful and offenders may be prosecuted to the fullest extent of the law. Unless otherwise stated the results shown in this test report refer only to the sample(s) tested and such sample(s) are retained for 30 days only.

Attention: To check the authenticity of testing /inspection report & certificate, please contact us at telephone: (86-755) 8307 1443, or email: [CN.Doccheck@sgs.com](mailto:CN.Doccheck@sgs.com)

No.10, Weiye Road, Innovation Park, Kunshan, Jiangsu, China 215300  
 中国·江苏·昆山市留学生创业园伟业路10号 邮编 215300

t(86-512)57355888 f(86-512)57370818 www.sgsgroup.com.cn  
 t(86-512)57355888 f(86-512)57370818 sgs.china@sgs.com

Test Mode: 03; Polarity: Vertical; Modulation:802.11ac; Bandwidth:40MHz; Channel:Low

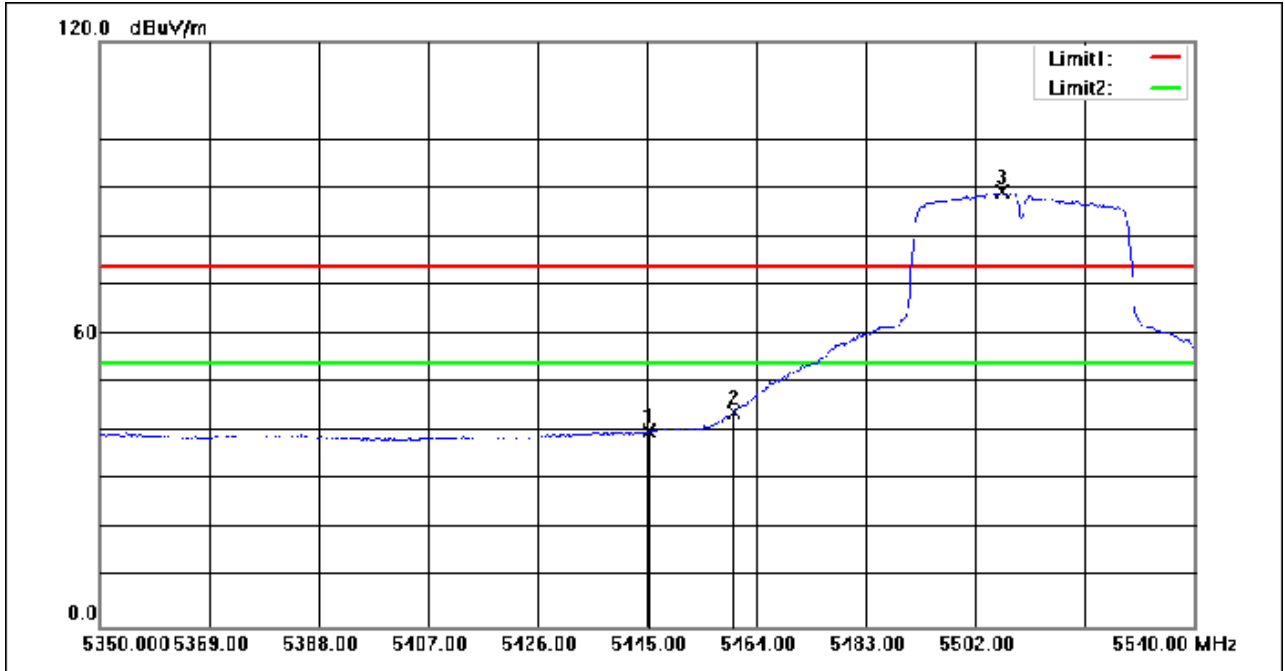

No.	Frequency (MHz)	Reading (dBuV)	Correction factor(dB/m)	Result (dBuV/m)	Limit (dBuV/m)	Margin (dB)	Remark
1	5445.380	49.71	-9.62	40.09	54.00	-13.91	AVG
2	5460.000	53.55	-9.59	43.96	54.00	-10.04	AVG
3	5506.750	98.68	-9.51	89.17	54.00	35.17	AVG



Unless otherwise agreed in writing, this document is issued by the Company subject to its General Conditions of Service printed overleaf, available on request or accessible at <http://www.sgs.com/en/Terms-and-Conditions.aspx> and, for electronic format documents, subject to Terms and Conditions for Electronic Documents at <http://www.sgs.com/en/Terms-and-Conditions/Terms-e-Documents.aspx>. Attention is drawn to the limitation of liability, indemnification and jurisdiction issues defined therein. Any holder of this document is advised that information contained hereon reflects the Company's findings at the time of its intervention only and within the limits of Client's instructions, if any. The Company's sole responsibility is to its Client and this document does not exonerate parties to a transaction from exercising all their rights and obligations under the transaction documents. This document cannot be reproduced except in full, without prior written approval of the Company. Any unauthorized alteration, forgery or falsification of the content or appearance of this document is unlawful and offenders may be prosecuted to the fullest extent of the law. Unless otherwise stated the results shown in this test report refer only to the sample(s) tested and such sample(s) are retained for 30 days only.  
**Attention: To check the authenticity of testing /inspection report & certificate, please contact us at telephone: (86-755) 8307 1443, or email: CN.Doccheck@sgs.com**

No.10, Weiye Road, Innovation Park, Kunshan, Jiangsu, China 215300  
 中国·江苏·昆山市留学生创业园伟业路10号 邮编 215300

t(86-512)57355888 f(86-512)57370818 www.sgsgroup.com.cn  
 t(86-512)57355888 f(86-512)57370818 sgs.china@sgs.com



Test Mode: 03; Polarity: Horizontal; Modulation:802.11ac; Bandwidth:80MHz; Channel:Low

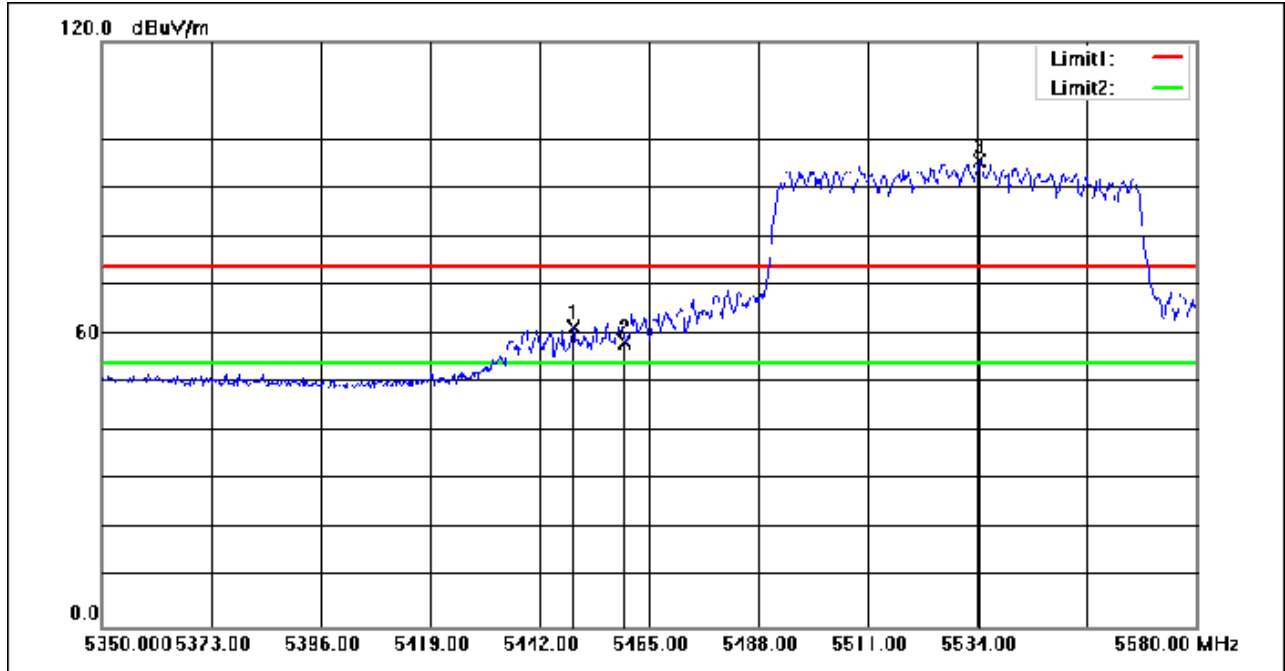

No.	Frequency (MHz)	Reading (dBuV)	Correction factor(dB/m)	Result (dBuV/m)	Limit (dBuV/m)	Margin (dB)	Remark
1	5449.130	71.01	-9.61	61.40	74.00	-12.60	peak
2	5460.000	67.85	-9.59	58.26	74.00	-15.74	peak
3	5534.460	105.10	-9.45	95.65	74.00	21.65	peak



Unless otherwise agreed in writing, this document is issued by the Company subject to its General Conditions of Service printed overleaf, available on request or accessible at <http://www.sgs.com/en/Terms-and-Conditions.aspx> and, for electronic format documents, subject to Terms and Conditions for Electronic Documents at <http://www.sgs.com/en/Terms-and-Conditions/Terms-e-Documents.aspx>. Attention is drawn to the limitation of liability, indemnification and jurisdiction issues defined therein. Any holder of this document is advised that information contained hereon reflects the Company's findings at the time of its intervention only and within the limits of Client's instructions, if any. The Company's sole responsibility is to its Client and this document does not exonerate parties to a transaction from exercising all their rights and obligations under the transaction documents. This document cannot be reproduced except in full, without prior written approval of the Company. Any unauthorized alteration, forgery or falsification of the content or appearance of this document is unlawful and offenders may be prosecuted to the fullest extent of the law. Unless otherwise stated the results shown in this test report refer only to the sample(s) tested and such sample(s) are retained for 30 days only.  
**Attention: To check the authenticity of testing /inspection report & certificate, please contact us at telephone: (86-755) 8307 1443, or email: CN.Doccheck@sgs.com**

No.10, Weiye Road, Innovation Park, Kunshan, Jiangsu, China 215300  
 中国·江苏·昆山市留学生创业园伟业路10号 邮编 215300

t(86-512)57355888 f(86-512)57370818 www.sgs.com.cn  
 t(86-512)57355888 f(86-512)57370818 sgs.china@sgs.com

Test Mode: 03; Polarity: Horizontal; Modulation:802.11ac; Bandwidth:80MHz; Channel:Low

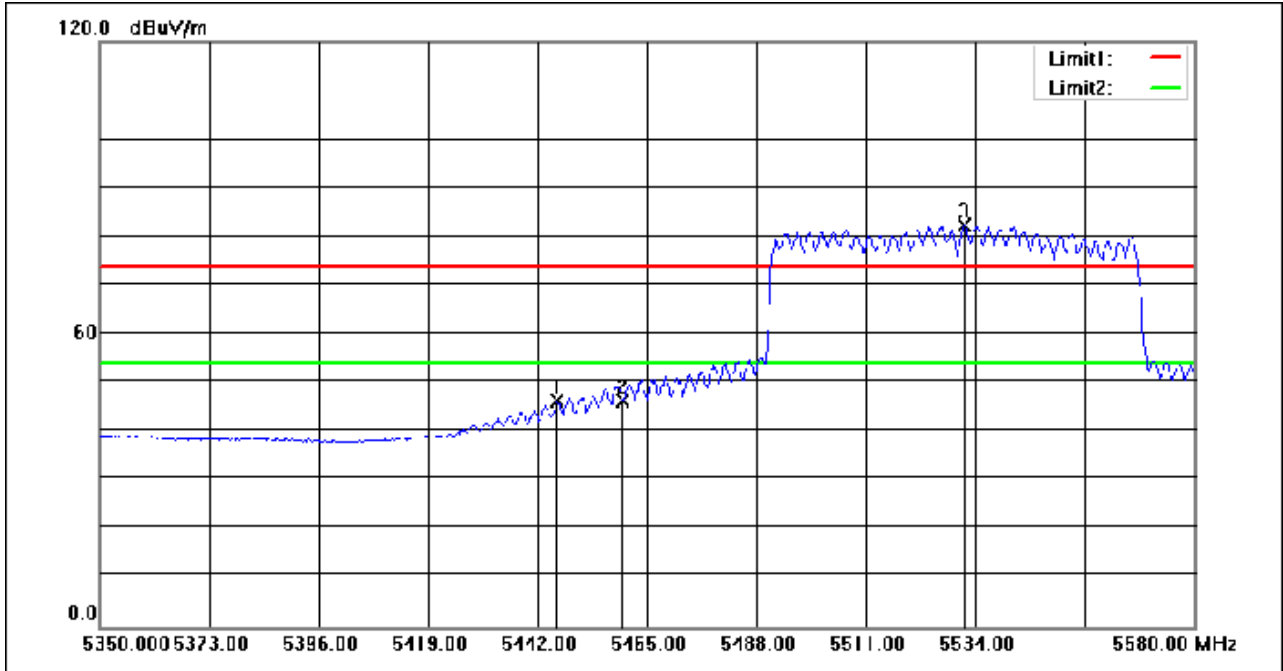

No.	Frequency (MHz)	Reading (dBuV)	Correction factor(dB/m)	Result (dBuV/m)	Limit (dBuV/m)	Margin (dB)	Remark
1	5446.140	56.04	-9.62	46.42	54.00	-7.58	AVG
2	5460.000	55.83	-9.59	46.24	54.00	-7.76	AVG
3	5531.700	91.83	-9.46	82.37	54.00	28.37	AVG



Unless otherwise agreed in writing, this document is issued by the Company subject to its General Conditions of Service printed overleaf, available on request or accessible at <http://www.sgs.com/en/Terms-and-Conditions.aspx> and, for electronic format documents, subject to Terms and Conditions for Electronic Documents at <http://www.sgs.com/en/Terms-and-Conditions/Terms-e-Documents.aspx>. Attention is drawn to the limitation of liability, indemnification and jurisdiction issues defined therein. Any holder of this document is advised that information contained hereon reflects the Company's findings at the time of its intervention only and within the limits of Client's instructions, if any. The Company's sole responsibility is to its Client and this document does not exonerate parties to a transaction from exercising all their rights and obligations under the transaction documents. This document cannot be reproduced except in full, without prior written approval of the Company. Any unauthorized alteration, forgery or falsification of the content or appearance of this document is unlawful and offenders may be prosecuted to the fullest extent of the law. Unless otherwise stated the results shown in this test report refer only to the sample(s) tested and such sample(s) are retained for 30 days only.  
**Attention: To check the authenticity of testing /inspection report & certificate, please contact us at telephone: (86-755) 8307 1443, or email: CN.Doccheck@sgs.com**

No.10, Weiye Road, Innovation Park, Kunshan, Jiangsu, China 215300  
 中国·江苏·昆山市留学生创业园伟业路10号 邮编 215300

t(86-512)57355888 f(86-512)57370818 www.sgsgroup.com.cn  
 t(86-512)57355888 f(86-512)57370818 sgs.china@sgs.com

Test Mode: 03; Polarity: Vertical; Modulation:802.11ac; Bandwidth:80MHz; Channel:Low

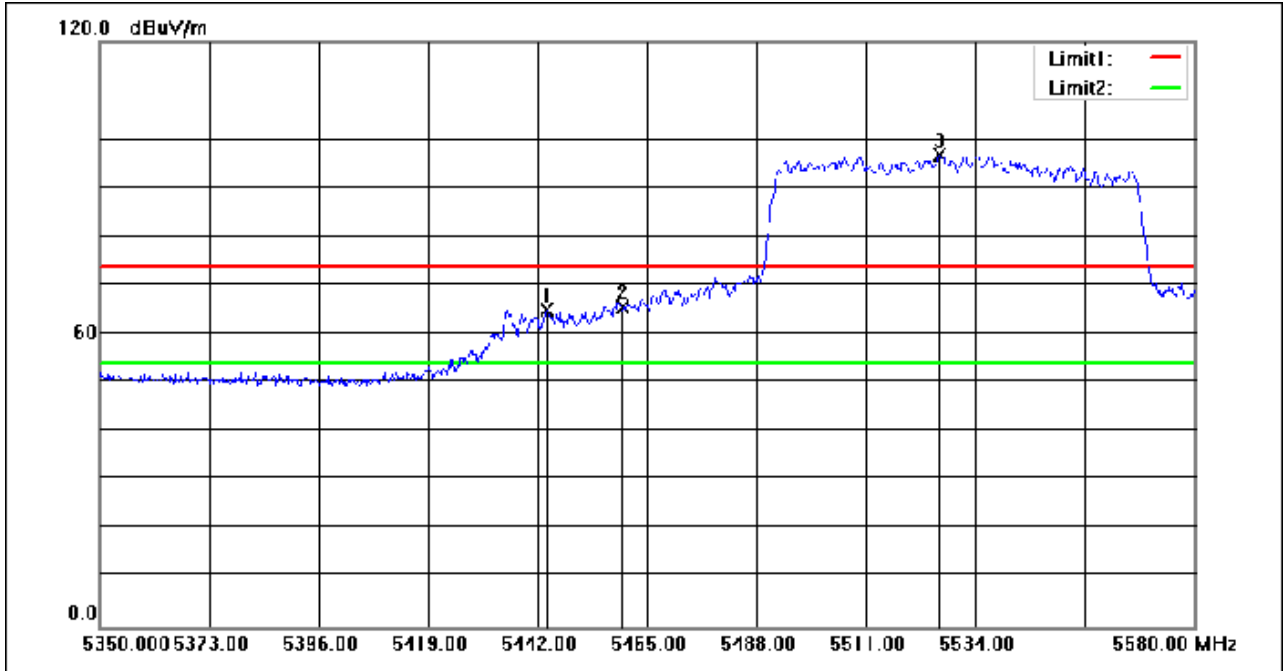

No.	Frequency (MHz)	Reading (dBuV)	Correction factor(dB/m)	Result (dBuV/m)	Limit (dBuV/m)	Margin (dB)	Remark
1	5444.070	74.70	-9.62	65.08	74.00	-8.92	peak
2	5460.000	75.12	-9.59	65.53	74.00	-8.47	peak
3	5526.410	106.13	-9.46	96.67	74.00	22.67	peak



Unless otherwise agreed in writing, this document is issued by the Company subject to its General Conditions of Service printed overleaf, available on request or accessible at <http://www.sgs.com/en/Terms-and-Conditions.aspx> and, for electronic format documents, subject to Terms and Conditions for Electronic Documents at <http://www.sgs.com/en/Terms-and-Conditions/Terms-e-Documents.aspx>. Attention is drawn to the limitation of liability, indemnification and jurisdiction issues defined therein. Any holder of this document is advised that information contained hereon reflects the Company's findings at the time of its intervention only and within the limits of Client's instructions, if any. The Company's sole responsibility is to its Client and this document does not exonerate parties to a transaction from exercising all their rights and obligations under the transaction documents. This document cannot be reproduced except in full, without prior written approval of the Company. Any unauthorized alteration, forgery or falsification of the content or appearance of this document is unlawful and offenders may be prosecuted to the fullest extent of the law. Unless otherwise stated the results shown in this test report refer only to the sample(s) tested and such sample(s) are retained for 30 days only.  
**Attention: To check the authenticity of testing /inspection report & certificate, please contact us at telephone: (86-755) 8307 1443, or email: CN.Doccheck@sgs.com**

No.10, Weiye Road, Innovation Park, Kunshan, Jiangsu, China 215300  
 中国·江苏·昆山市留学生创业园伟业路10号 邮编 215300

t(86-512)57355888 f(86-512)57370818 www.sgsgroup.com.cn  
 t(86-512)57355888 f(86-512)57370818 sgs.china@sgs.com

Test Mode: 03; Polarity: Vertical; Modulation:802.11ac; Bandwidth:80MHz; Channel:Low

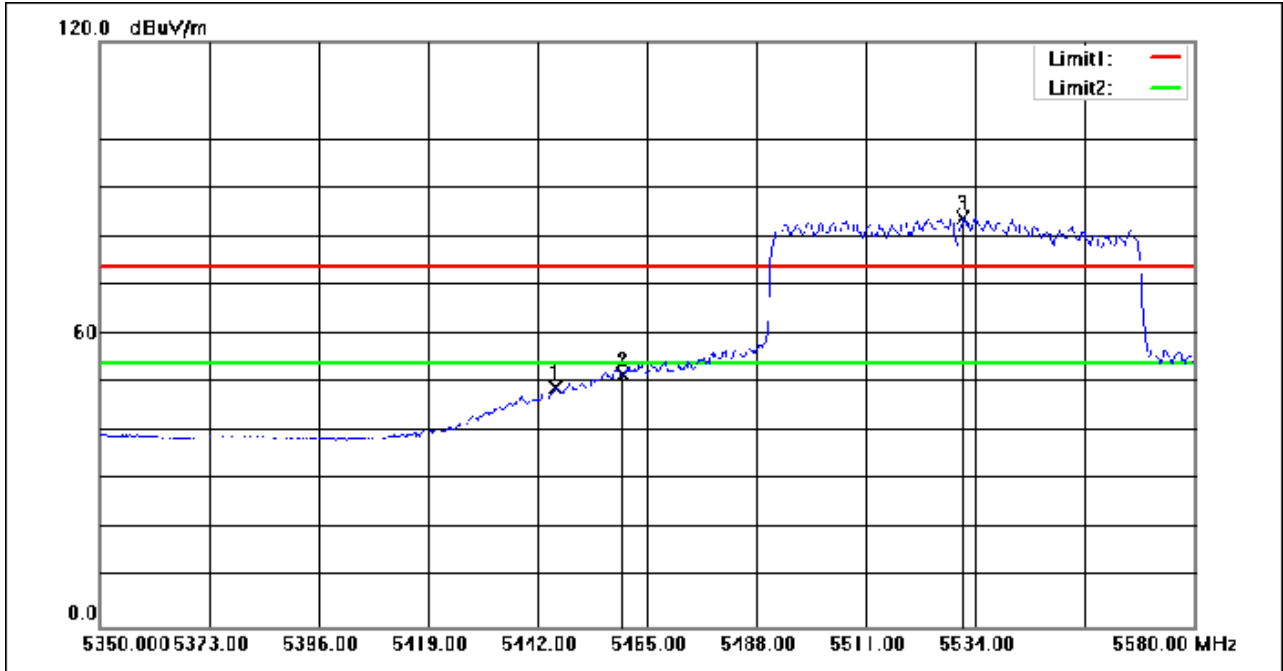

No.	Frequency (MHz)	Reading (dBuV)	Correction factor(dB/m)	Result (dBuV/m)	Limit (dBuV/m)	Margin (dB)	Remark
1	5445.910	58.80	-9.62	49.18	54.00	-4.82	AVG
2	5460.000	61.29	-9.59	51.70	54.00	-2.30	AVG
3	5531.470	93.29	-9.46	83.83	54.00	29.83	AVG



Unless otherwise agreed in writing, this document is issued by the Company subject to its General Conditions of Service printed overleaf, available on request or accessible at <http://www.sgs.com/en/Terms-and-Conditions.aspx> and, for electronic format documents, subject to Terms and Conditions for Electronic Documents at <http://www.sgs.com/en/Terms-and-Conditions/Terms-e-Document.aspx>. Attention is drawn to the limitation of liability, indemnification and jurisdiction issues defined therein. Any holder of this document is advised that information contained hereon reflects the Company's findings at the time of its intervention only and within the limits of Client's instructions, if any. The Company's sole responsibility is to its Client and this document does not exonerate parties to a transaction from exercising all their rights and obligations under the transaction documents. This document cannot be reproduced except in full, without prior written approval of the Company. Any unauthorized alteration, forgery or falsification of the content or appearance of this document is unlawful and offenders may be prosecuted to the fullest extent of the law. Unless otherwise stated the results shown in this test report refer only to the sample(s) tested and such sample(s) are retained for 30 days only.  
**Attention: To check the authenticity of testing /inspection report & certificate, please contact us at telephone: (86-755) 8307 1443, or email: CN.Doccheck@sgs.com**

No.10, Weiye Road, Innovation Park, Kunshan, Jiangsu, China 215300  
 中国·江苏·昆山市留学生创业园伟业路10号 邮编 215300

t(86-512)57355888 f(86-512)57370818 www.sgsgroup.com.cn  
 t(86-512)57355888 f(86-512)57370818 sgs.china@sgs.com

Test Mode: 04; Polarity: Horizontal; Modulation:802.11a; Bandwidth:20MHz; Channel:Low

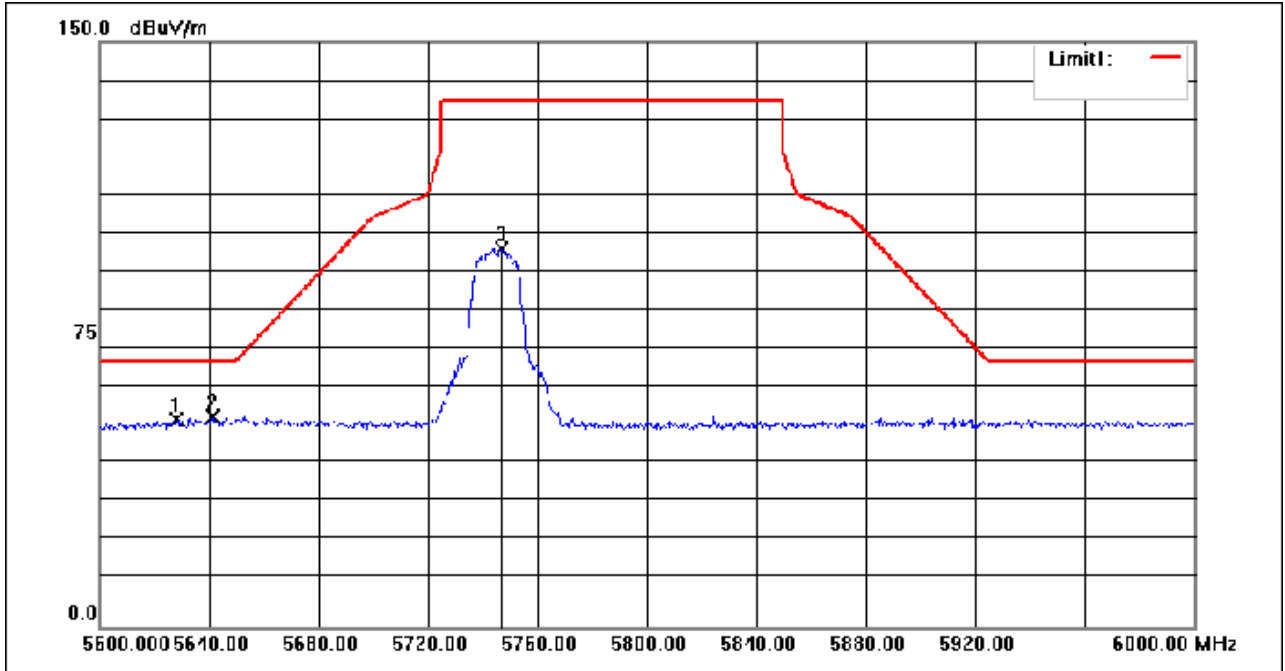

No.	Frequency (MHz)	Reading (dBuV)	Correction factor(dB/m)	Result (dBuV/m)	Limit (dBuV/m)	Margin (dB)	Remark
1	5628.000	62.27	-9.24	53.03	68.20	-15.17	peak
2	5641.200	62.90	-9.20	53.70	68.20	-14.50	peak
3	5746.800	105.87	-8.86	97.01	135.00	-37.99	peak



Unless otherwise agreed in writing, this document is issued by the Company subject to its General Conditions of Service printed overleaf, available on request or accessible at <http://www.sgs.com/en/Terms-and-Conditions.aspx> and, for electronic format documents, subject to Terms and Conditions for Electronic Documents at <http://www.sgs.com/en/Terms-and-Conditions/Terms-e-Documents.aspx>. Attention is drawn to the limitation of liability, indemnification and jurisdiction issues defined therein. Any holder of this document is advised that information contained hereon reflects the Company's findings at the time of its intervention only and within the limits of Client's instructions, if any. The Company's sole responsibility is to its Client and this document does not exonerate parties to a transaction from exercising all their rights and obligations under the transaction documents. This document cannot be reproduced except in full, without prior written approval of the Company. Any unauthorized alteration, forgery or falsification of the content or appearance of this document is unlawful and offenders may be prosecuted to the fullest extent of the law. Unless otherwise stated the results shown in this test report refer only to the sample(s) tested and such sample(s) are retained for 30 days only.  
Attention: To check the authenticity of testing /inspection report & certificate, please contact us at telephone: (86-755) 8307 1443, or email: [CN.Doccheck@sgs.com](mailto:CN.Doccheck@sgs.com)

No.10, Weiye Road, Innovation Park, Kunshan, Jiangsu, China 215300  
中国·江苏·昆山市留学生创业园伟业路10号 邮编 215300

t(86-512)57355888 f(86-512)57370818 www.sgsgroup.com.cn  
t(86-512)57355888 f(86-512)57370818 sgs.china@sgs.com



Test Mode: 04; Polarity: Vertical; Modulation:802.11a; Bandwidth:20MHz; Channel:Low

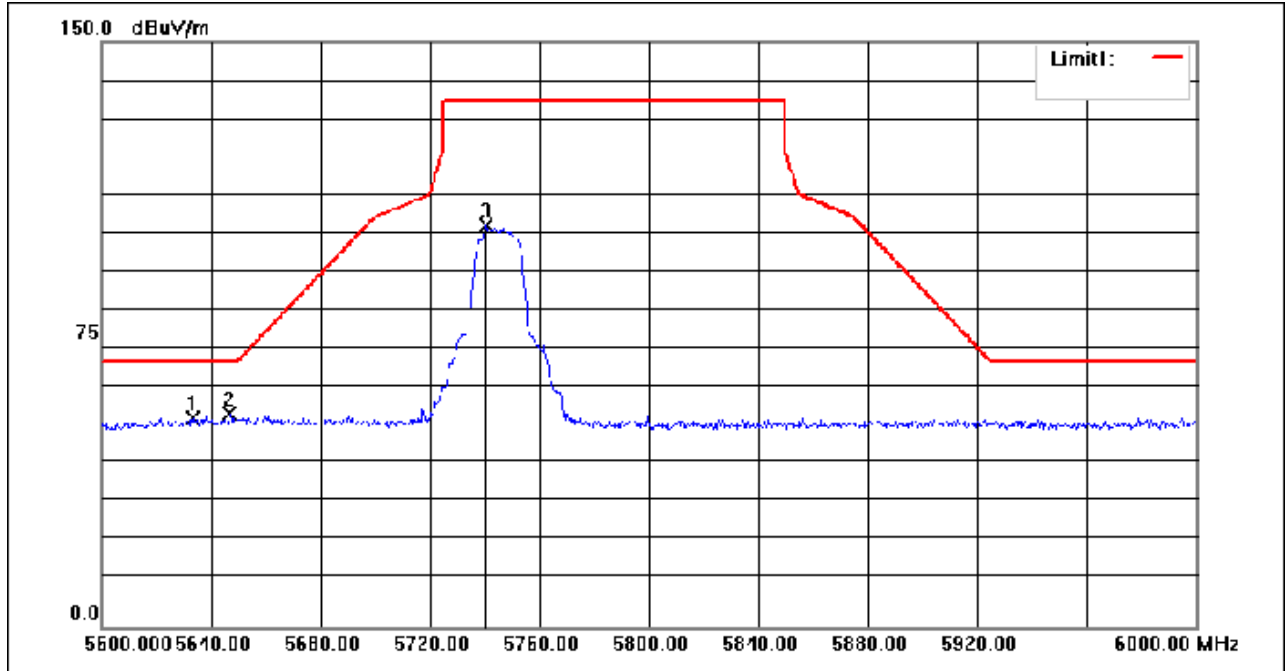

No.	Frequency (MHz)	Reading (dBuV)	Correction factor(dB/m)	Result (dBuV/m)	Limit (dBuV/m)	Margin (dB)	Remark
1	5633.200	62.78	-9.23	53.55	68.20	-14.65	peak
2	5646.800	63.91	-9.18	54.73	68.20	-13.47	peak
3	5740.400	111.65	-8.88	102.77	135.00	-32.23	peak



Unless otherwise agreed in writing, this document is issued by the Company subject to its General Conditions of Service printed overleaf, available on request or accessible at <http://www.sgs.com/en/Terms-and-Conditions.aspx> and, for electronic format documents, subject to Terms and Conditions for Electronic Documents at <http://www.sgs.com/en/Terms-and-Conditions/Terms-e-Documents.aspx>. Attention is drawn to the limitation of liability, indemnification and jurisdiction issues defined therein. Any holder of this document is advised that information contained hereon reflects the Company's findings at the time of its intervention only and within the limits of Client's instructions, if any. The Company's sole responsibility is to its Client and this document does not exonerate parties to a transaction from exercising all their rights and obligations under the transaction documents. This document cannot be reproduced except in full, without prior written approval of the Company. Any unauthorized alteration, forgery or falsification of the content or appearance of this document is unlawful and offenders may be prosecuted to the fullest extent of the law. Unless otherwise stated the results shown in this test report refer only to the sample(s) tested and such sample(s) are retained for 30 days only.  
**Attention: To check the authenticity of testing /inspection report & certificate, please contact us at telephone: (86-755) 8307 1443, or email: CN.Doccheck@sgs.com**

No.10, Weiye Road, Innovation Park, Kunshan, Jiangsu, China 215300  
 中国·江苏·昆山市留学生创业园伟业路10号 邮编 215300

t(86-512)57355888 f(86-512)57370818 www.sgsgroup.com.cn  
 t(86-512)57355888 f(86-512)57370818 sgs.china@sgs.com

## Compliance Certification Services (Kunshan) Inc.

Report No.: KSCR221000189002

Page: 223 of 607

Test Mode: 04; Polarity: Horizontal; Modulation:802.11a; Bandwidth:20MHz; Channel:High

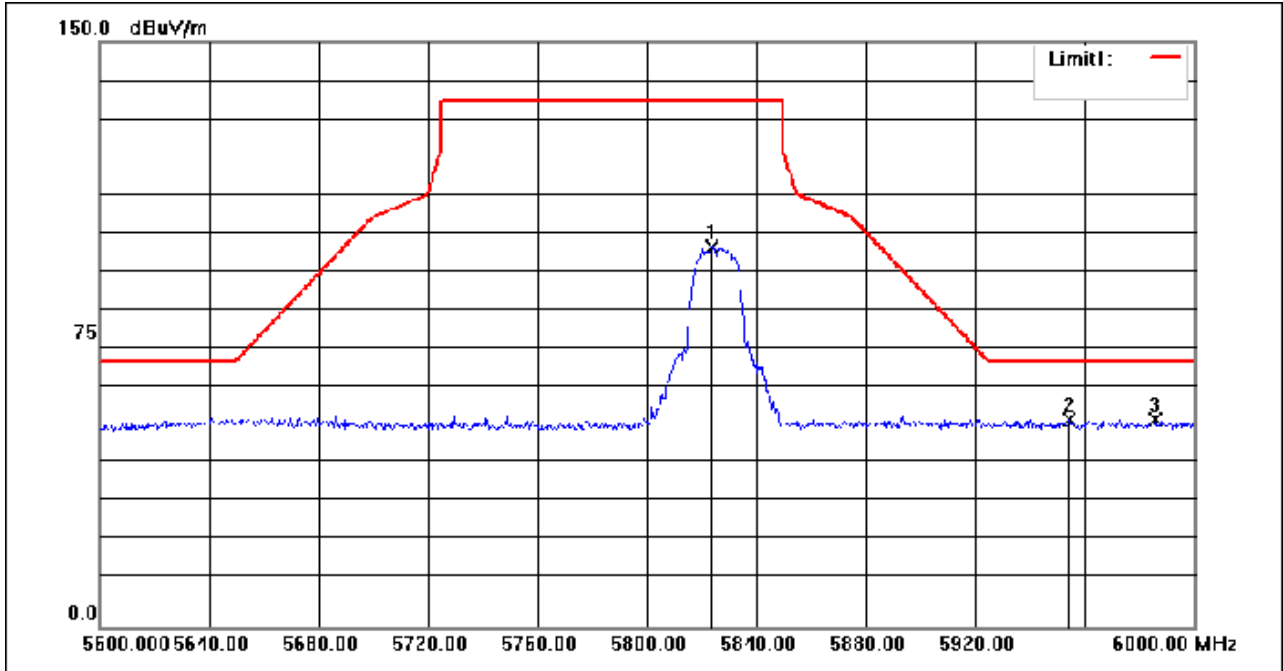

No.	Frequency (MHz)	Reading (dBuV)	Correction factor(dB/m)	Result (dBuV/m)	Limit (dBuV/m)	Margin (dB)	Remark
1	5823.600	106.04	-8.58	97.46	135.00	-37.54	peak
2	5954.400	61.22	-8.01	53.21	68.20	-14.99	peak
3	5986.000	61.04	-7.86	53.18	68.20	-15.02	peak



Unless otherwise agreed in writing, this document is issued by the Company subject to its General Conditions of Service printed overleaf, available on request or accessible at <http://www.sgs.com/en/Terms-and-Conditions.aspx> and, for electronic format documents, subject to Terms and Conditions for Electronic Documents at <http://www.sgs.com/en/Terms-and-Conditions/Terms-e-Documents.aspx>. Attention is drawn to the limitation of liability, indemnification and jurisdiction issues defined therein. Any holder of this document is advised that information contained hereon reflects the Company's findings at the time of its intervention only and within the limits of Client's instructions, if any. The Company's sole responsibility is to its Client and this document does not exonerate parties to a transaction from exercising all their rights and obligations under the transaction documents. This document cannot be reproduced except in full, without prior written approval of the Company. Any unauthorized alteration, forgery or falsification of the content or appearance of this document is unlawful and offenders may be prosecuted to the fullest extent of the law. Unless otherwise stated the results shown in this test report refer only to the sample(s) tested and such sample(s) are retained for 30 days only.  
**Attention: To check the authenticity of testing /inspection report & certificate, please contact us at telephone: (86-755) 8307 1443, or email: CN.Doccheck@sgs.com**

No.10, Weiye Road, Innovation Park, Kunshan, Jiangsu, China 215300  
 中国·江苏·昆山市留学生创业园伟业路10号 邮编 215300

t(86-512)57355888 f(86-512)57370818 www.sgsgroup.com.cn  
 t(86-512)57355888 f(86-512)57370818 sgs.china@sgs.com

Test Mode: 04; Polarity: Vertical; Modulation:802.11a; Bandwidth:20MHz; Channel:High

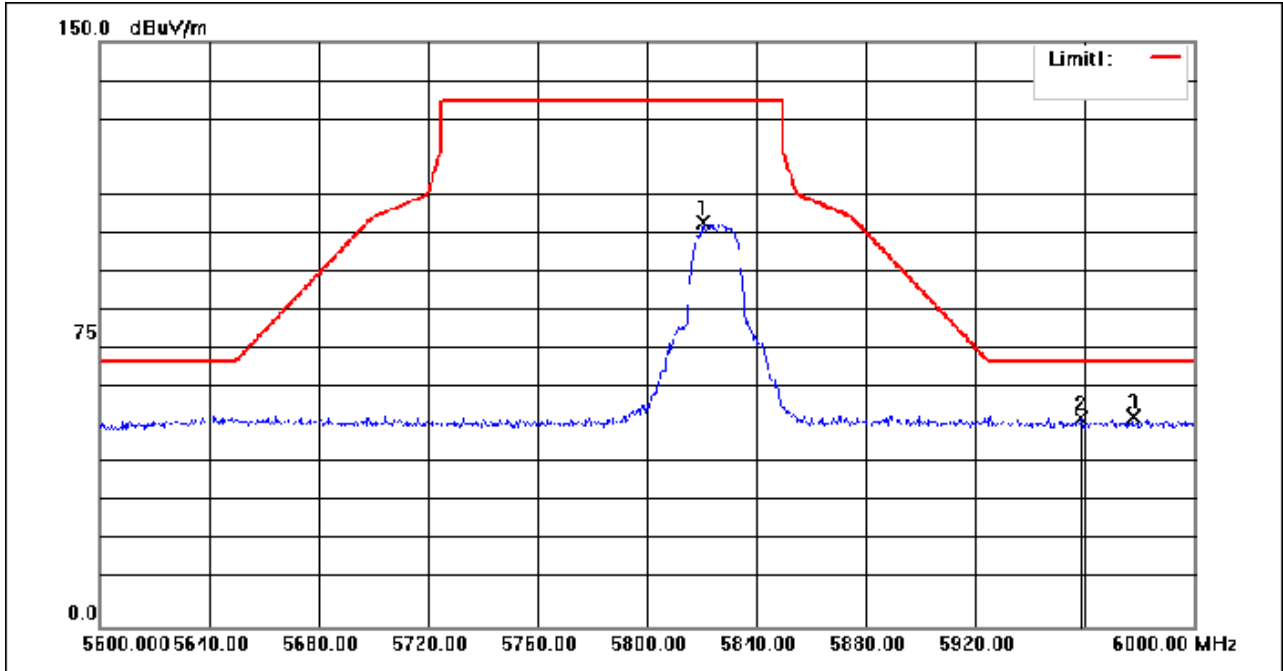

No.	Frequency (MHz)	Reading (dBuV)	Correction factor(dB/m)	Result (dBuV/m)	Limit (dBuV/m)	Margin (dB)	Remark
1	5820.400	112.27	-8.60	103.67	135.00	-31.33	peak
2	5958.800	61.36	-7.98	53.38	68.20	-14.82	peak
3	5977.600	61.76	-7.90	53.86	68.20	-14.34	peak



Unless otherwise agreed in writing, this document is issued by the Company subject to its General Conditions of Service printed overleaf, available on request or accessible at <http://www.sgs.com/en/Terms-and-Conditions.aspx> and, for electronic format documents, subject to Terms and Conditions for Electronic Documents at <http://www.sgs.com/en/Terms-and-Conditions/Terms-e-Document.aspx>. Attention is drawn to the limitation of liability, indemnification and jurisdiction issues defined therein. Any holder of this document is advised that information contained hereon reflects the Company's findings at the time of its intervention only and within the limits of Client's instructions, if any. The Company's sole responsibility is to its Client and this document does not exonerate parties to a transaction from exercising all their rights and obligations under the transaction documents. This document cannot be reproduced except in full, without prior written approval of the Company. Any unauthorized alteration, forgery or falsification of the content or appearance of this document is unlawful and offenders may be prosecuted to the fullest extent of the law. Unless otherwise stated the results shown in this test report refer only to the sample(s) tested and such sample(s) are retained for 30 days only.  
**Attention: To check the authenticity of testing /inspection report & certificate, please contact us at telephone: (86-755) 8307 1443, or email: CN.Doccheck@sgs.com**

No.10, Weiye Road, Innovation Park, Kunshan, Jiangsu, China 215300  
 中国·江苏·昆山市留学生创业园伟业路10号 邮编 215300

t(86-512)57355888 f(86-512)57370818 www.sgsgroup.com.cn  
 t(86-512)57355888 f(86-512)57370818 sgs.china@sgs.com

Test Mode: 04; Polarity: Horizontal; Modulation:802.11n; Bandwidth:20MHz; Channel:Low

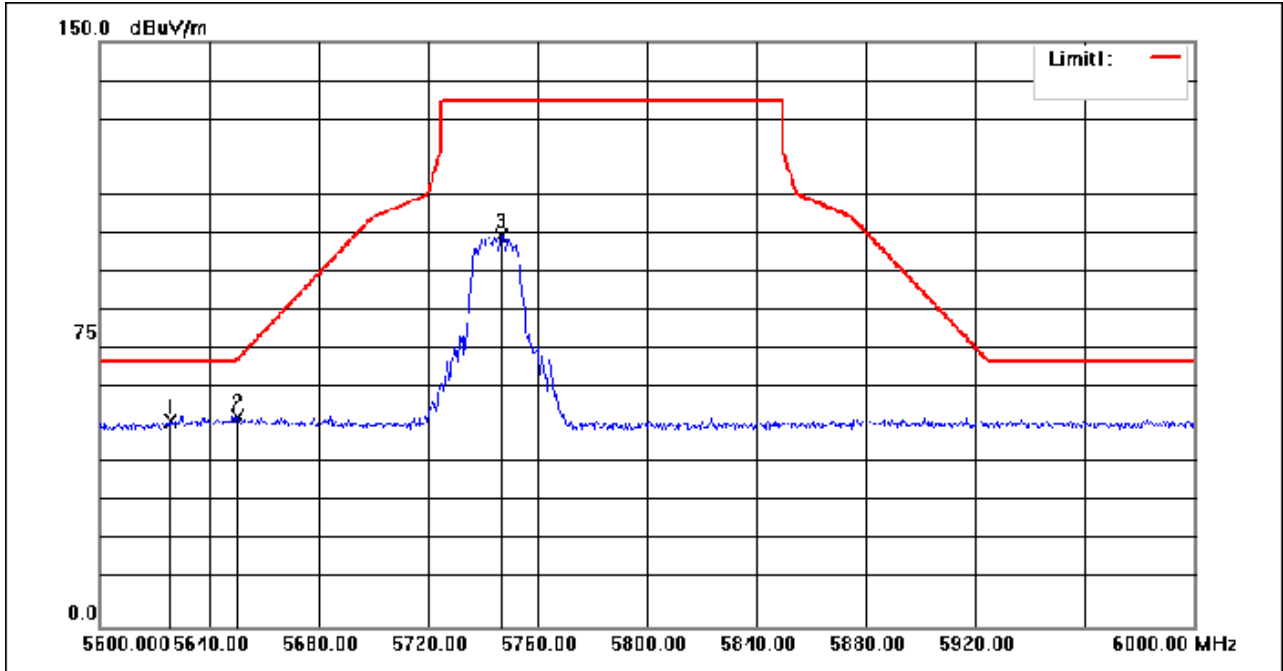

No.	Frequency (MHz)	Reading (dBuV)	Correction factor(dB/m)	Result (dBuV/m)	Limit (dBuV/m)	Margin (dB)	Remark
1	5626.000	61.80	-9.24	52.56	68.20	-15.64	peak
2	5650.400	62.90	-9.17	53.73	68.50	-14.77	peak
3	5746.800	109.09	-8.86	100.23	135.00	-34.77	peak



Unless otherwise agreed in writing, this document is issued by the Company subject to its General Conditions of Service printed overleaf, available on request or accessible at <http://www.sgs.com/en/Terms-and-Conditions.aspx> and, for electronic format documents, subject to Terms and Conditions for Electronic Documents at <http://www.sgs.com/en/Terms-and-Conditions/Terms-e-Documents.aspx>. Attention is drawn to the limitation of liability, indemnification and jurisdiction issues defined therein. Any holder of this document is advised that information contained hereon reflects the Company's findings at the time of its intervention only and within the limits of Client's instructions, if any. The Company's sole responsibility is to its Client and this document does not exonerate parties to a transaction from exercising all their rights and obligations under the transaction documents. This document cannot be reproduced except in full, without prior written approval of the Company. Any unauthorized alteration, forgery or falsification of the content or appearance of this document is unlawful and offenders may be prosecuted to the fullest extent of the law. Unless otherwise stated the results shown in this test report refer only to the sample(s) tested and such sample(s) are retained for 30 days only.  
**Attention: To check the authenticity of testing /inspection report & certificate, please contact us at telephone: (86-755) 8307 1443, or email: CN.Doccheck@sgs.com**

No.10, Weiye Road, Innovation Park, Kunshan, Jiangsu, China 215300  
 中国·江苏·昆山市留学生创业园伟业路10号 邮编 215300

t(86-512)57355888 f(86-512)57370818 www.sgs.com.cn  
 t(86-512)57355888 f(86-512)57370818 sgs.china@sgs.com

Test Mode: 04; Polarity: Vertical; Modulation:802.11n; Bandwidth:20MHz; Channel:Low

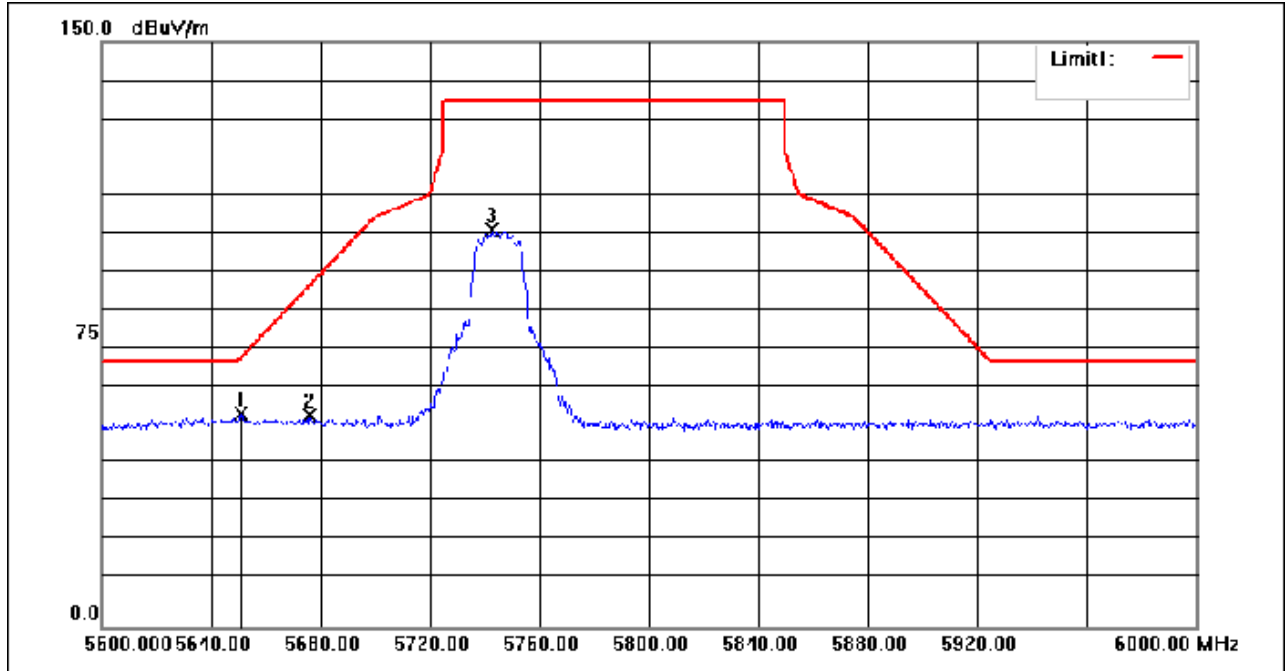

No.	Frequency (MHz)	Reading (dBUV)	Correction factor(dB/m)	Result (dBUV/m)	Limit (dBUV/m)	Margin (dB)	Remark
1	5650.800	63.58	-9.17	54.41	68.79	-14.38	peak
2	5676.000	63.27	-9.09	54.18	87.44	-33.26	peak
3	5742.800	110.70	-8.87	101.83	135.00	-33.17	peak



Unless otherwise agreed in writing, this document is issued by the Company subject to its General Conditions of Service printed overleaf, available on request or accessible at <http://www.sgs.com/en/Terms-and-Conditions.aspx> and, for electronic format documents, subject to Terms and Conditions for Electronic Documents at <http://www.sgs.com/en/Terms-and-Conditions/Terms-e-Document.aspx>. Attention is drawn to the limitation of liability, indemnification and jurisdiction issues defined therein. Any holder of this document is advised that information contained hereon reflects the Company's findings at the time of its intervention only and within the limits of Client's instructions, if any. The Company's sole responsibility is to its Client and this document does not exonerate parties to a transaction from exercising all their rights and obligations under the transaction documents. This document cannot be reproduced except in full, without prior written approval of the Company. Any unauthorized alteration, forgery or falsification of the content or appearance of this document is unlawful and offenders may be prosecuted to the fullest extent of the law. Unless otherwise stated the results shown in this test report refer only to the sample(s) tested and such sample(s) are retained for 30 days only.  
Attention: To check the authenticity of testing /inspection report & certificate, please contact us at telephone: (86-755) 8307 1443, or email: [CN.Doccheck@sgs.com](mailto:CN.Doccheck@sgs.com)

No.10, Weiye Road, Innovation Park, Kunshan, Jiangsu, China 215300  
中国·江苏·昆山市留学生创业园伟业路10号 邮编 215300

t(86-512)57355888 f(86-512)57370818 www.sgsgroup.com.cn  
t(86-512)57355888 f(86-512)57370818 sgs.china@sgs.com



Test Mode: 04; Polarity: Horizontal; Modulation:802.11n; Bandwidth:20MHz; Channel:High

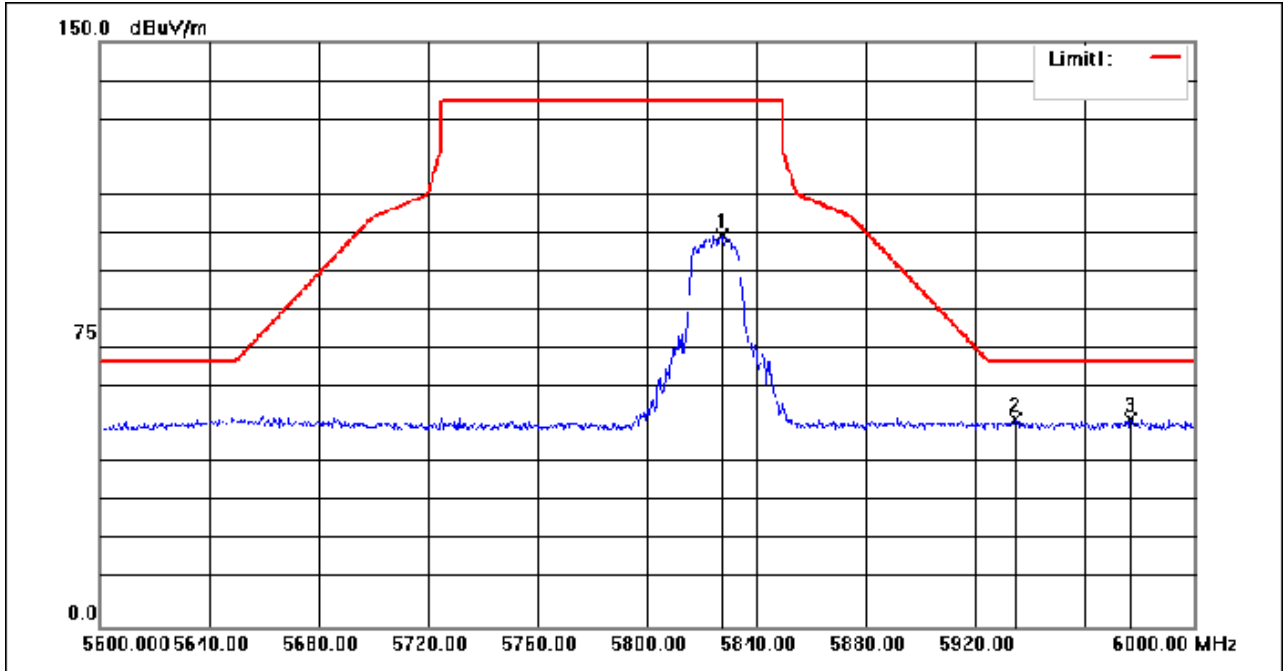

No.	Frequency (MHz)	Reading (dBuV)	Correction factor(dB/m)	Result (dBuV/m)	Limit (dBuV/m)	Margin (dB)	Remark
1	5827.200	108.78	-8.57	100.21	135.00	-34.79	peak
2	5934.400	60.99	-8.09	52.90	68.20	-15.30	peak
3	5976.800	61.00	-7.91	53.09	68.20	-15.11	peak



Unless otherwise agreed in writing, this document is issued by the Company subject to its General Conditions of Service printed overleaf, available on request or accessible at <http://www.sgs.com/en/Terms-and-Conditions.aspx> and, for electronic format documents, subject to Terms and Conditions for Electronic Documents at <http://www.sgs.com/en/Terms-and-Conditions/Terms-e-Documents.aspx>. Attention is drawn to the limitation of liability, indemnification and jurisdiction issues defined therein. Any holder of this document is advised that information contained hereon reflects the Company's findings at the time of its intervention only and within the limits of Client's instructions, if any. The Company's sole responsibility is to its Client and this document does not exonerate parties to a transaction from exercising all their rights and obligations under the transaction documents. This document cannot be reproduced except in full, without prior written approval of the Company. Any unauthorized alteration, forgery or falsification of the content or appearance of this document is unlawful and offenders may be prosecuted to the fullest extent of the law. Unless otherwise stated the results shown in this test report refer only to the sample(s) tested and such sample(s) are retained for 30 days only.  
**Attention: To check the authenticity of testing /inspection report & certificate, please contact us at telephone: (86-755) 8307 1443, or email: CN.Doccheck@sgs.com**

No.10, Weiye Road, Innovation Park, Kunshan, Jiangsu, China 215300  
 中国·江苏·昆山市留学生创业园伟业路10号 邮编 215300

t(86-512)57355888 f(86-512)57370818 www.sgsgroup.com.cn  
 t(86-512)57355888 f(86-512)57370818 sgs.china@sgs.com

Test Mode: 04; Polarity: Vertical; Modulation:802.11n; Bandwidth:20MHz; Channel:High

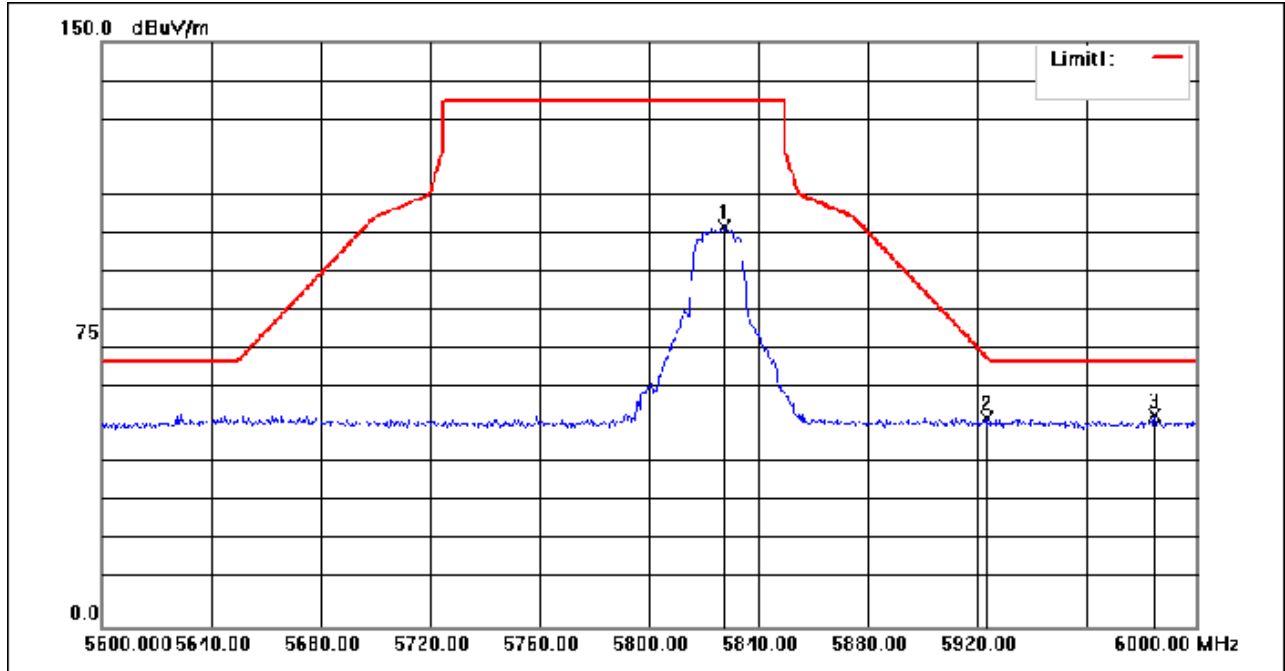

No.	Frequency (MHz)	Reading (dBuV)	Correction factor(dB/m)	Result (dBuV/m)	Limit (dBuV/m)	Margin (dB)	Remark
1	5827.600	111.06	-8.57	102.49	135.00	-32.51	peak
2	5923.200	61.45	-8.14	53.31	69.53	-16.22	peak
3	5984.800	61.89	-7.87	54.02	68.20	-14.18	peak



Unless otherwise agreed in writing, this document is issued by the Company subject to its General Conditions of Service printed overleaf, available on request or accessible at <http://www.sgs.com/en/Terms-and-Conditions.aspx> and, for electronic format documents, subject to Terms and Conditions for Electronic Documents at <http://www.sgs.com/en/Terms-and-Conditions/Terms-e-Document.aspx>. Attention is drawn to the limitation of liability, indemnification and jurisdiction issues defined therein. Any holder of this document is advised that information contained hereon reflects the Company's findings at the time of its intervention only and within the limits of Client's instructions, if any. The Company's sole responsibility is to its Client and this document does not exonerate parties to a transaction from exercising all their rights and obligations under the transaction documents. This document cannot be reproduced except in full, without prior written approval of the Company. Any unauthorized alteration, forgery or falsification of the content or appearance of this document is unlawful and offenders may be prosecuted to the fullest extent of the law. Unless otherwise stated the results shown in this test report refer only to the sample(s) tested and such sample(s) are retained for 30 days only.  
**Attention: To check the authenticity of testing /inspection report & certificate, please contact us at telephone: (86-755) 8307 1443, or email: CN.Doccheck@sgs.com**

No.10, Weiye Road, Innovation Park, Kunshan, Jiangsu, China 215300  
 中国·江苏·昆山市留学生创业园伟业路10号 邮编 215300

t(86-512)57355888 f(86-512)57370818 www.sgsgroup.com.cn  
 t(86-512)57355888 f(86-512)57370818 sgs.china@sgs.com

Test Mode: 04; Polarity: Horizontal; Modulation:802.11n; Bandwidth:40MHz; Channel:Low

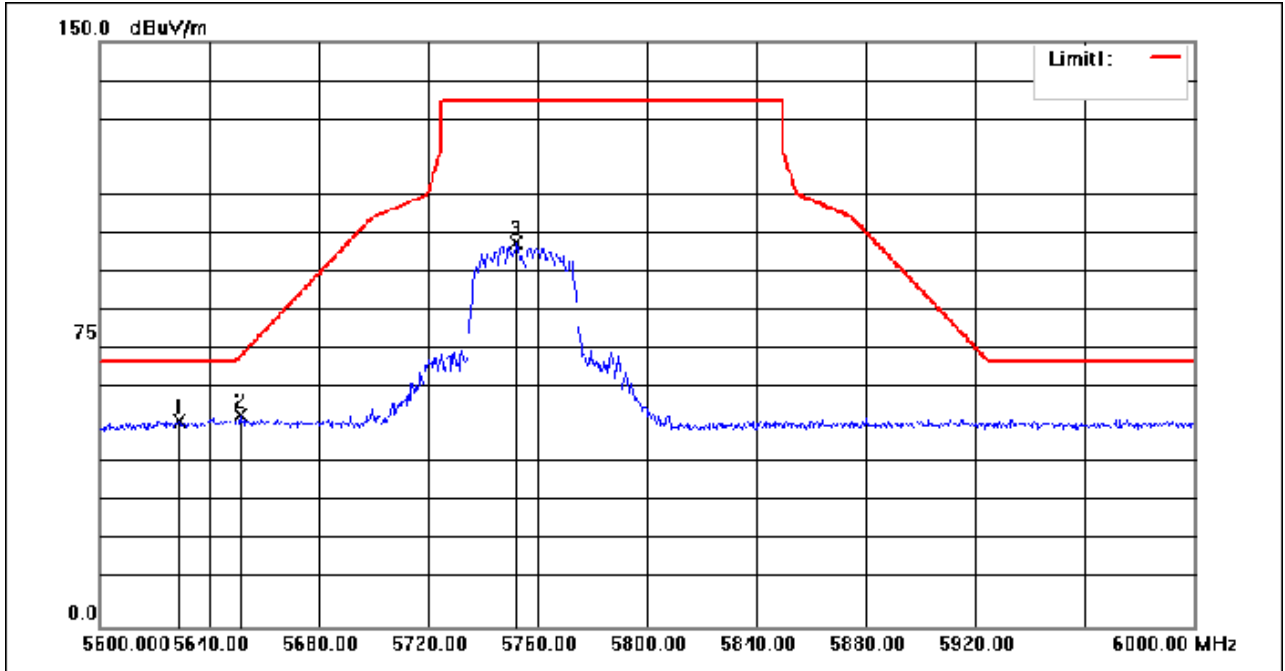

No.	Frequency (MHz)	Reading (dBuV)	Correction factor(dB/m)	Result (dBuV/m)	Limit (dBuV/m)	Margin (dB)	Remark
1	5629.200	62.06	-9.24	52.82	68.20	-15.38	peak
2	5651.200	63.21	-9.17	54.04	69.09	-15.05	peak
3	5752.400	107.14	-8.84	98.30	135.00	-36.70	peak



Unless otherwise agreed in writing, this document is issued by the Company subject to its General Conditions of Service printed overleaf, available on request or accessible at <http://www.sgs.com/en/Terms-and-Conditions.aspx> and, for electronic format documents, subject to Terms and Conditions for Electronic Documents at <http://www.sgs.com/en/Terms-and-Conditions/Terms-e-Documents.aspx>. Attention is drawn to the limitation of liability, indemnification and jurisdiction issues defined therein. Any holder of this document is advised that information contained hereon reflects the Company's findings at the time of its intervention only and within the limits of Client's instructions, if any. The Company's sole responsibility is to its Client and this document does not exonerate parties to a transaction from exercising all their rights and obligations under the transaction documents. This document cannot be reproduced except in full, without prior written approval of the Company. Any unauthorized alteration, forgery or falsification of the content or appearance of this document is unlawful and offenders may be prosecuted to the fullest extent of the law. Unless otherwise stated the results shown in this test report refer only to the sample(s) tested and such sample(s) are retained for 30 days only.  
**Attention: To check the authenticity of testing /inspection report & certificate, please contact us at telephone: (86-755) 8307 1443, or email: CN.Doccheck@sgs.com**

No.10, Weiye Road, Innovation Park, Kunshan, Jiangsu, China 215300  
 中国·江苏·昆山市留学生创业园伟业路10号 邮编 215300

t(86-512)57355888 f(86-512)57370818 www.sgsgroup.com.cn  
 t(86-512)57355888 f(86-512)57370818 sgs.china@sgs.com

Test Mode: 04; Polarity: Vertical; Modulation:802.11n; Bandwidth:40MHz; Channel:Low

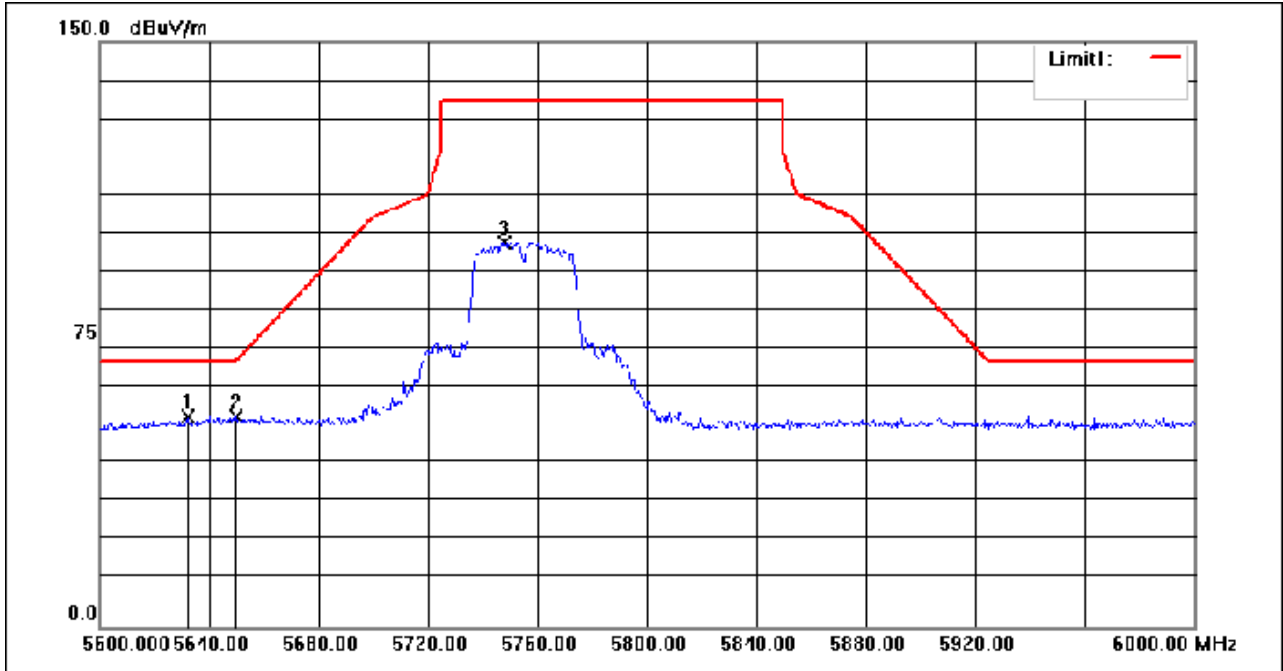

No.	Frequency (MHz)	Reading (dBuV)	Correction factor(dB/m)	Result (dBuV/m)	Limit (dBuV/m)	Margin (dB)	Remark
1	5632.000	62.86	-9.23	53.63	68.20	-14.57	peak
2	5650.000	62.96	-9.17	53.79	68.20	-14.41	peak
3	5748.000	107.43	-8.85	98.58	135.00	-36.42	peak



Unless otherwise agreed in writing, this document is issued by the Company subject to its General Conditions of Service printed overleaf, available on request or accessible at <http://www.sgs.com/en/Terms-and-Conditions.aspx> and, for electronic format documents, subject to Terms and Conditions for Electronic Documents at <http://www.sgs.com/en/Terms-and-Conditions/Terms-e-Document.aspx>. Attention is drawn to the limitation of liability, indemnification and jurisdiction issues defined therein. Any holder of this document is advised that information contained hereon reflects the Company's findings at the time of its intervention only and within the limits of Client's instructions, if any. The Company's sole responsibility is to its Client and this document does not exonerate parties to a transaction from exercising all their rights and obligations under the transaction documents. This document cannot be reproduced except in full, without prior written approval of the Company. Any unauthorized alteration, forgery or falsification of the content or appearance of this document is unlawful and offenders may be prosecuted to the fullest extent of the law. Unless otherwise stated the results shown in this test report refer only to the sample(s) tested and such sample(s) are retained for 30 days only.  
**Attention: To check the authenticity of testing /inspection report & certificate, please contact us at telephone: (86-755) 8307 1443, or email: CN.Doccheck@sgs.com**

No.10, Weiye Road, Innovation Park, Kunshan, Jiangsu, China 215300  
 中国·江苏·昆山市留学生创业园伟业路10号 邮编 215300

t(86-512)57355888 f(86-512)57370818 www.sgs.com.cn  
 t(86-512)57355888 f(86-512)57370818 sgs.china@sgs.com

Test Mode: 04; Polarity: Horizontal; Modulation:802.11ac; Bandwidth:80MHz; Channel:Low

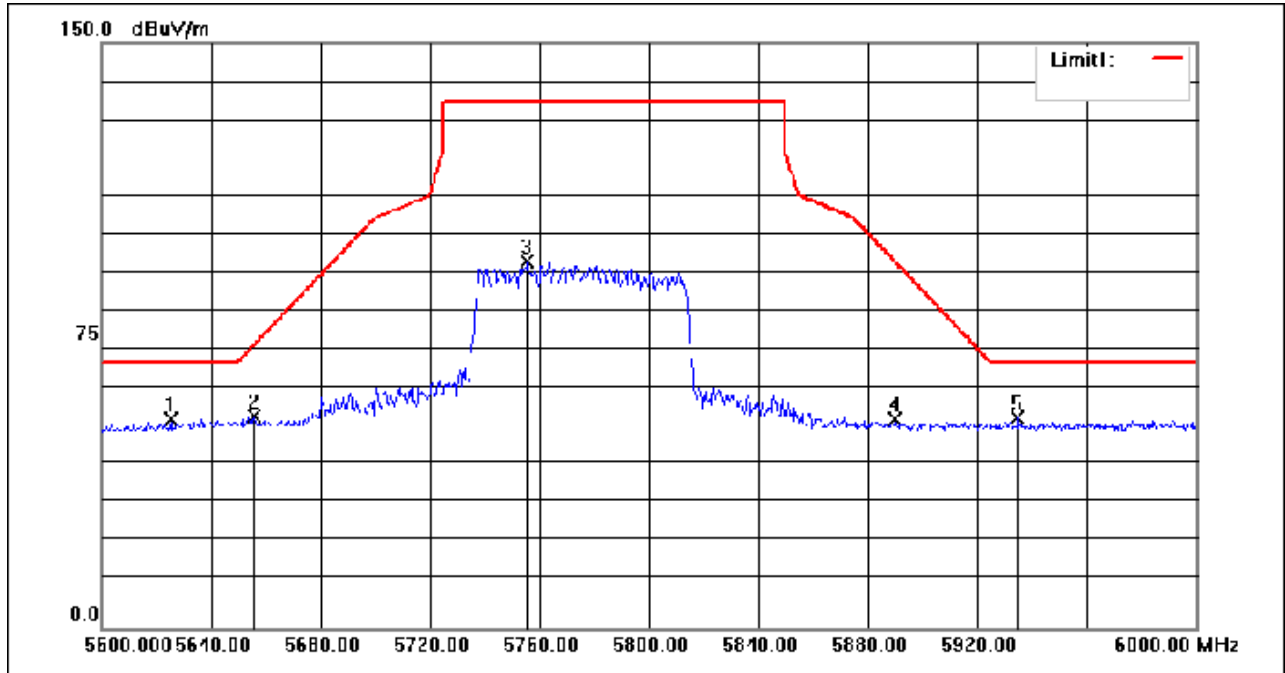

No.	Frequency (MHz)	Reading (dBuV)	Correction factor(dB/m)	Result (dBuV/m)	Limit (dBuV/m)	Margin (dB)	Remark
1	5625.200	62.62	-9.25	53.37	68.20	-14.83	peak
2	5655.600	63.49	-9.15	54.34	72.34	-18.00	peak
3	5755.600	102.70	-8.84	93.86	135.00	-41.14	peak
4	5890.000	61.67	-8.29	53.38	94.10	-40.72	peak
5	5934.800	62.04	-8.09	53.95	68.20	-14.25	peak



Unless otherwise agreed in writing, this document is issued by the Company subject to its General Conditions of Service printed overleaf, available on request or accessible at <http://www.sgs.com/en/Terms-and-Conditions.aspx> and, for electronic format documents, subject to Terms and Conditions for Electronic Documents at <http://www.sgs.com/en/Terms-and-Conditions/Terms-e-Documents.aspx>. Attention is drawn to the limitation of liability, indemnification and jurisdiction issues defined therein. Any holder of this document is advised that information contained hereon reflects the Company's findings at the time of its intervention only and within the limits of Client's instructions, if any. The Company's sole responsibility is to its Client and this document does not exonerate parties to a transaction from exercising all their rights and obligations under the transaction documents. This document cannot be reproduced except in full, without prior written approval of the Company. Any unauthorized alteration, forgery or falsification of the content or appearance of this document is unlawful and offenders may be prosecuted to the fullest extent of the law. Unless otherwise stated the results shown in this test report refer only to the sample(s) tested and such sample(s) are retained for 30 days only.  
**Attention: To check the authenticity of testing /inspection report & certificate, please contact us at telephone: (86-755) 8307 1443, or email: CN.Doccheck@sgs.com**

No.10, Weiye Road, Innovation Park, Kunshan, Jiangsu, China 215300  
中国·江苏·昆山市留学生创业园伟业路10号 邮编 215300

t(86-512)57355888 f(86-512)57370818 www.sgsgroup.com.cn  
t(86-512)57355888 f(86-512)57370818 sgs.china@sgs.com



Test Mode: 04; Polarity: Horizontal; Modulation:802.11n; Bandwidth:40MHz; Channel:High

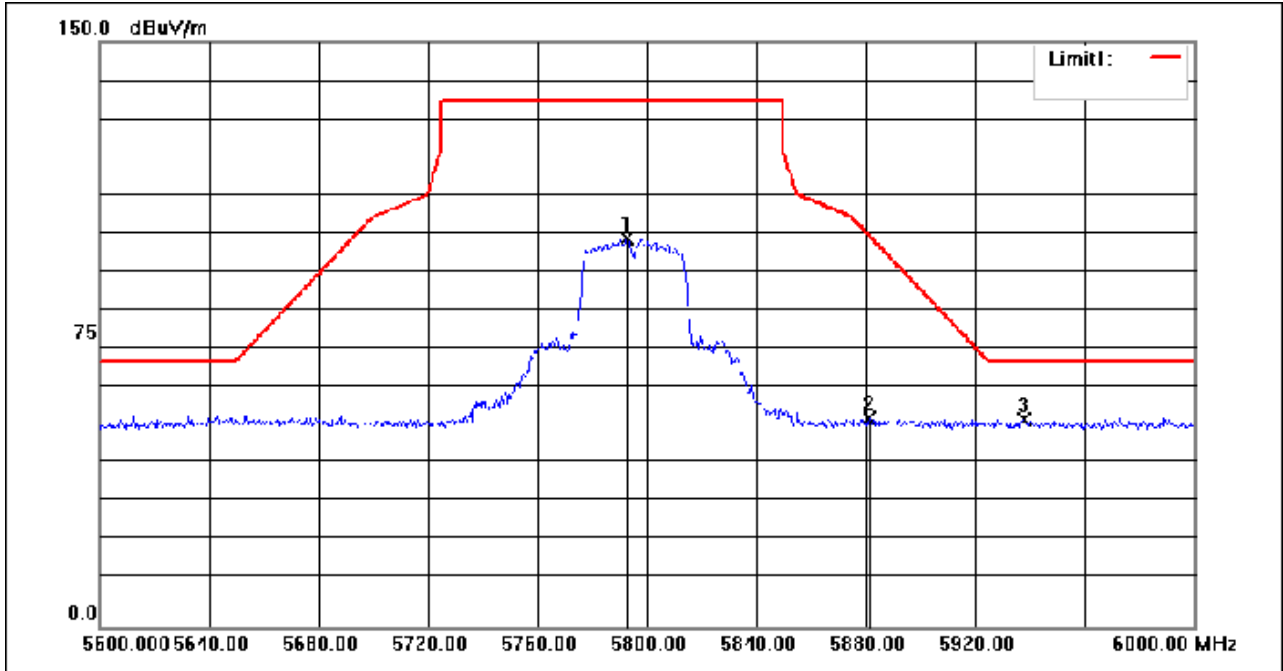

No.	Frequency (MHz)	Reading (dBuV)	Correction factor(dB/m)	Result (dBuV/m)	Limit (dBuV/m)	Margin (dB)	Remark
1	5792.800	108.37	-8.72	99.65	135.00	-35.35	peak
2	5881.200	61.76	-8.33	53.43	100.61	-47.18	peak
3	5937.600	61.17	-8.07	53.10	68.20	-15.10	peak



Unless otherwise agreed in writing, this document is issued by the Company subject to its General Conditions of Service printed overleaf, available on request or accessible at <http://www.sgs.com/en/Terms-and-Conditions.aspx> and, for electronic format documents, subject to Terms and Conditions for Electronic Documents at <http://www.sgs.com/en/Terms-and-Conditions/Terms-e-Documents.aspx>. Attention is drawn to the limitation of liability, indemnification and jurisdiction issues defined therein. Any holder of this document is advised that information contained hereon reflects the Company's findings at the time of its intervention only and within the limits of Client's instructions, if any. The Company's sole responsibility is to its Client and this document does not exonerate parties to a transaction from exercising all their rights and obligations under the transaction documents. This document cannot be reproduced except in full, without prior written approval of the Company. Any unauthorized alteration, forgery or falsification of the content or appearance of this document is unlawful and offenders may be prosecuted to the fullest extent of the law. Unless otherwise stated the results shown in this test report refer only to the sample(s) tested and such sample(s) are retained for 30 days only.  
Attention: To check the authenticity of testing /inspection report & certificate, please contact us at telephone: (86-755) 8307 1443, or email: [CN.Doccheck@sgs.com](mailto:CN.Doccheck@sgs.com)

No.10, Weiye Road, Innovation Park, Kunshan, Jiangsu, China 215300  
中国·江苏·昆山市留学生创业园伟业路10号 邮编 215300

t(86-512)57355888 f(86-512)57370818 www.sgsgroup.com.cn  
t(86-512)57355888 f(86-512)57370818 sgs.china@sgs.com

Test Mode: 04; Polarity: Vertical; Modulation:802.11n; Bandwidth:40MHz; Channel:High

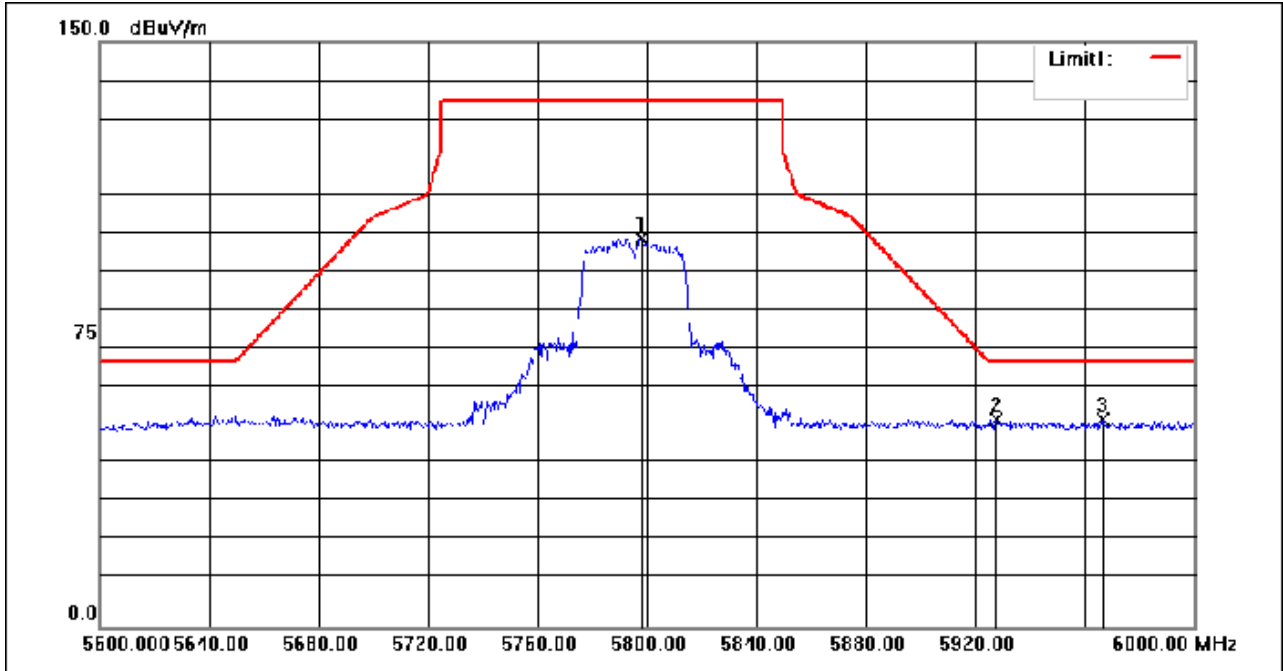

No.	Frequency (MHz)	Reading (dBuV)	Correction factor(dB/m)	Result (dBuV/m)	Limit (dBuV/m)	Margin (dB)	Remark
1	5798.000	108.32	-8.69	99.63	135.00	-35.37	peak
2	5927.600	61.26	-8.13	53.13	68.20	-15.07	peak
3	5966.400	60.97	-7.95	53.02	68.20	-15.18	peak



Unless otherwise agreed in writing, this document is issued by the Company subject to its General Conditions of Service printed overleaf, available on request or accessible at <http://www.sgs.com/en/Terms-and-Conditions.aspx> and, for electronic format documents, subject to Terms and Conditions for Electronic Documents at <http://www.sgs.com/en/Terms-and-Conditions/Terms-e-Documents.aspx>. Attention is drawn to the limitation of liability, indemnification and jurisdiction issues defined therein. Any holder of this document is advised that information contained hereon reflects the Company's findings at the time of its intervention only and within the limits of Client's instructions, if any. The Company's sole responsibility is to its Client and this document does not exonerate parties to a transaction from exercising all their rights and obligations under the transaction documents. This document cannot be reproduced except in full, without prior written approval of the Company. Any unauthorized alteration, forgery or falsification of the content or appearance of this document is unlawful and offenders may be prosecuted to the fullest extent of the law. Unless otherwise stated the results shown in this test report refer only to the sample(s) tested and such sample(s) are retained for 30 days only.  
**Attention: To check the authenticity of testing /inspection report & certificate, please contact us at telephone: (86-755) 8307 1443, or email: CN.Doccheck@sgs.com**

No.10, Weiye Road, Innovation Park, Kunshan, Jiangsu, China 215300  
 中国·江苏·昆山市留学生创业园伟业路10号 邮编 215300

t(86-512)57355888 f(86-512)57370818 www.sgsgroup.com.cn  
 t(86-512)57355888 f(86-512)57370818 sgs.china@sgs.com

Test Mode: 04; Polarity: Horizontal; Modulation:802.11ac; Bandwidth:20MHz; Channel:Low

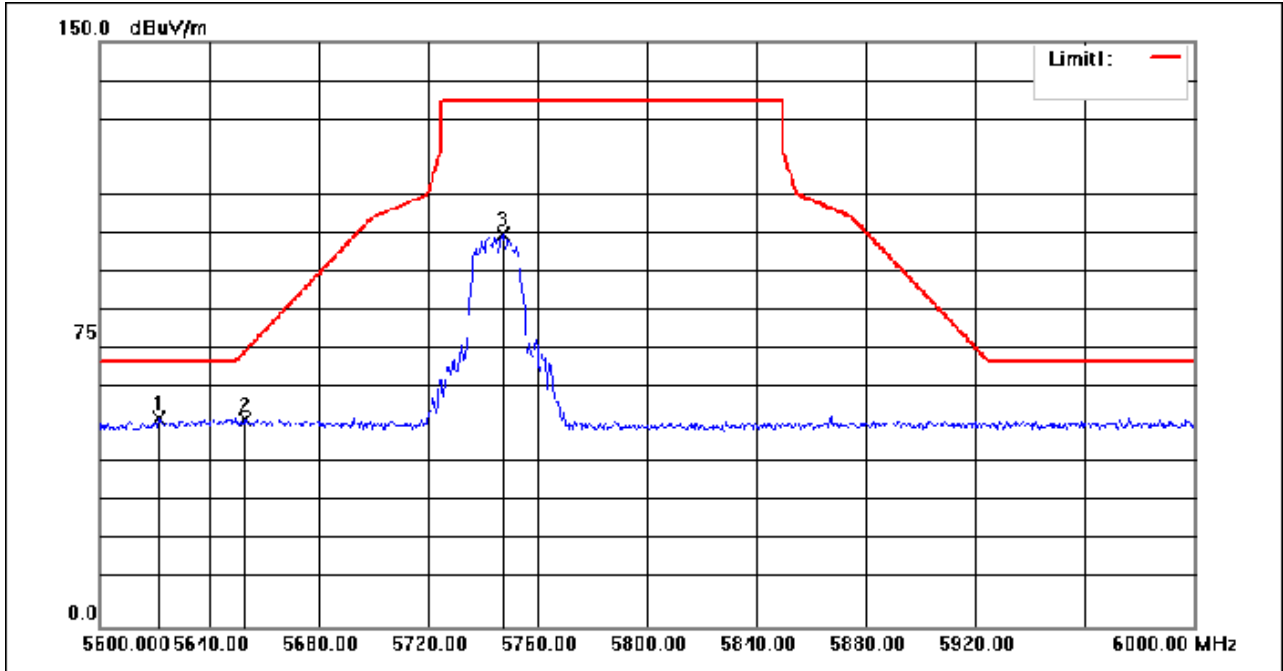

No.	Frequency (MHz)	Reading (dBuV)	Correction factor(dB/m)	Result (dBuV/m)	Limit (dBuV/m)	Margin (dB)	Remark
1	5621.600	62.52	-9.26	53.26	68.20	-14.94	peak
2	5653.200	62.32	-9.16	53.16	70.57	-17.41	peak
3	5747.200	109.43	-8.86	100.57	135.00	-34.43	peak



Unless otherwise agreed in writing, this document is issued by the Company subject to its General Conditions of Service printed overleaf, available on request or accessible at <http://www.sgs.com/en/Terms-and-Conditions.aspx> and, for electronic format documents, subject to Terms and Conditions for Electronic Documents at <http://www.sgs.com/en/Terms-and-Conditions/Terms-e-Documents.aspx>. Attention is drawn to the limitation of liability, indemnification and jurisdiction issues defined therein. Any holder of this document is advised that information contained hereon reflects the Company's findings at the time of its intervention only and within the limits of Client's instructions, if any. The Company's sole responsibility is to its Client and this document does not exonerate parties to a transaction from exercising all their rights and obligations under the transaction documents. This document cannot be reproduced except in full, without prior written approval of the Company. Any unauthorized alteration, forgery or falsification of the content or appearance of this document is unlawful and offenders may be prosecuted to the fullest extent of the law. Unless otherwise stated the results shown in this test report refer only to the sample(s) tested and such sample(s) are retained for 30 days only.  
**Attention: To check the authenticity of testing /inspection report & certificate, please contact us at telephone: (86-755) 8307 1443, or email: CN.Doccheck@sgs.com**

No.10, Weiye Road, Innovation Park, Kunshan, Jiangsu, China 215300  
 中国·江苏·昆山市留学生创业园伟业路10号 邮编 215300

t(86-512)57355888 f(86-512)57370818 www.sgsgroup.com.cn  
 t(86-512)57355888 f(86-512)57370818 sgs.china@sgs.com

Test Mode: 04; Polarity: Vertical; Modulation:802.11ac; Bandwidth:20MHz; Channel:Low

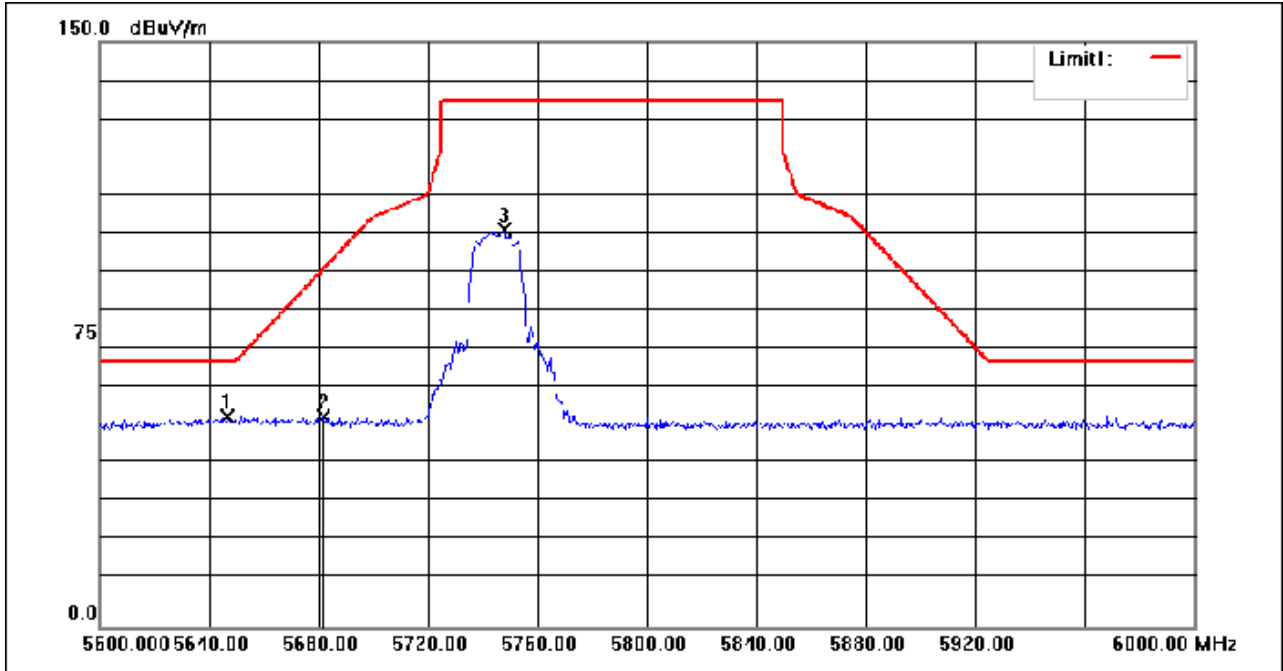

No.	Frequency (MHz)	Reading (dBuV)	Correction factor(dB/m)	Result (dBuV/m)	Limit (dBuV/m)	Margin (dB)	Remark
1	5646.800	63.09	-9.18	53.91	68.20	-14.29	peak
2	5682.000	63.00	-9.06	53.94	91.88	-37.94	peak
3	5748.000	110.84	-8.85	101.99	135.00	-33.01	peak



Unless otherwise agreed in writing, this document is issued by the Company subject to its General Conditions of Service printed overleaf, available on request or accessible at <http://www.sgs.com/en/Terms-and-Conditions.aspx> and, for electronic format documents, subject to Terms and Conditions for Electronic Documents at <http://www.sgs.com/en/Terms-and-Conditions/Terms-e-Documents.aspx>. Attention is drawn to the limitation of liability, indemnification and jurisdiction issues defined therein. Any holder of this document is advised that information contained hereon reflects the Company's findings at the time of its intervention only and within the limits of Client's instructions, if any. The Company's sole responsibility is to its Client and this document does not exonerate parties to a transaction from exercising all their rights and obligations under the transaction documents. This document cannot be reproduced except in full, without prior written approval of the Company. Any unauthorized alteration, forgery or falsification of the content or appearance of this document is unlawful and offenders may be prosecuted to the fullest extent of the law. Unless otherwise stated the results shown in this test report refer only to the sample(s) tested and such sample(s) are retained for 30 days only.  
**Attention: To check the authenticity of testing /inspection report & certificate, please contact us at telephone: (86-755) 8307 1443, or email: CN.Doccheck@sgs.com**

No.10, Weiye Road, Innovation Park, Kunshan, Jiangsu, China 215300  
 中国·江苏·昆山市留学生创业园伟业路10号 邮编 215300

t(86-512)57355888 f(86-512)57370818 www.sgs.com.cn  
 t(86-512)57355888 f(86-512)57370818 sgs.china@sgs.com

Test Mode: 04; Polarity: Horizontal; Modulation:802.11ac; Bandwidth:20MHz; Channel:High

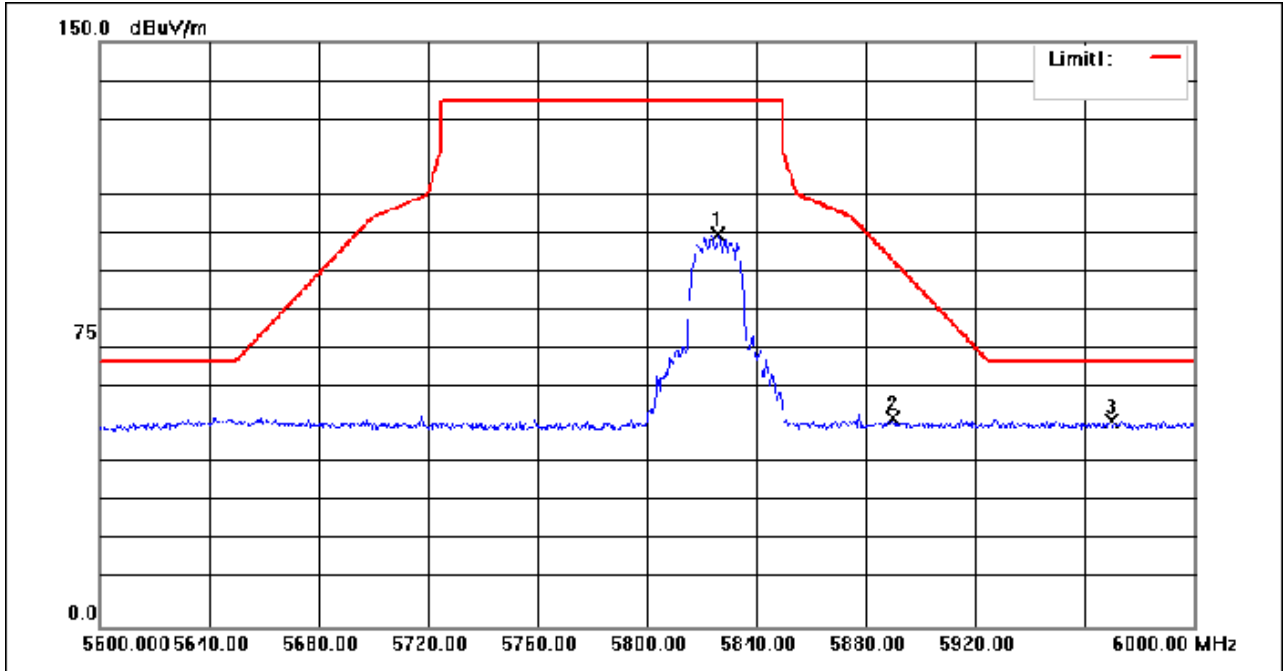

No.	Frequency (MHz)	Reading (dBuV)	Correction factor(dB/m)	Result (dBuV/m)	Limit (dBuV/m)	Margin (dB)	Remark
1	5826.000	109.15	-8.58	100.57	135.00	-34.43	peak
2	5890.000	61.57	-8.29	53.28	94.10	-40.82	peak
3	5969.600	60.56	-7.93	52.63	68.20	-15.57	peak



Unless otherwise agreed in writing, this document is issued by the Company subject to its General Conditions of Service printed overleaf, available on request or accessible at <http://www.sgs.com/en/Terms-and-Conditions.aspx> and, for electronic format documents, subject to Terms and Conditions for Electronic Documents at <http://www.sgs.com/en/Terms-and-Conditions/Terms-e-Documents.aspx>. Attention is drawn to the limitation of liability, indemnification and jurisdiction issues defined therein. Any holder of this document is advised that information contained hereon reflects the Company's findings at the time of its intervention only and within the limits of Client's instructions, if any. The Company's sole responsibility is to its Client and this document does not exonerate parties to a transaction from exercising all their rights and obligations under the transaction documents. This document cannot be reproduced except in full, without prior written approval of the Company. Any unauthorized alteration, forgery or falsification of the content or appearance of this document is unlawful and offenders may be prosecuted to the fullest extent of the law. Unless otherwise stated the results shown in this test report refer only to the sample(s) tested and such sample(s) are retained for 30 days only.  
**Attention: To check the authenticity of testing /inspection report & certificate, please contact us at telephone: (86-755) 8307 1443, or email: CN.Doccheck@sgs.com**

No.10, Weiye Road, Innovation Park, Kunshan, Jiangsu, China 215300  
 中国·江苏·昆山市留学生创业园伟业路10号 邮编 215300

t(86-512)57355888 f(86-512)57370818 www.sgsgroup.com.cn  
 t(86-512)57355888 f(86-512)57370818 sgs.china@sgs.com



Test Mode: 04; Polarity: Vertical; Modulation:802.11ac; Bandwidth:20MHz; Channel:High

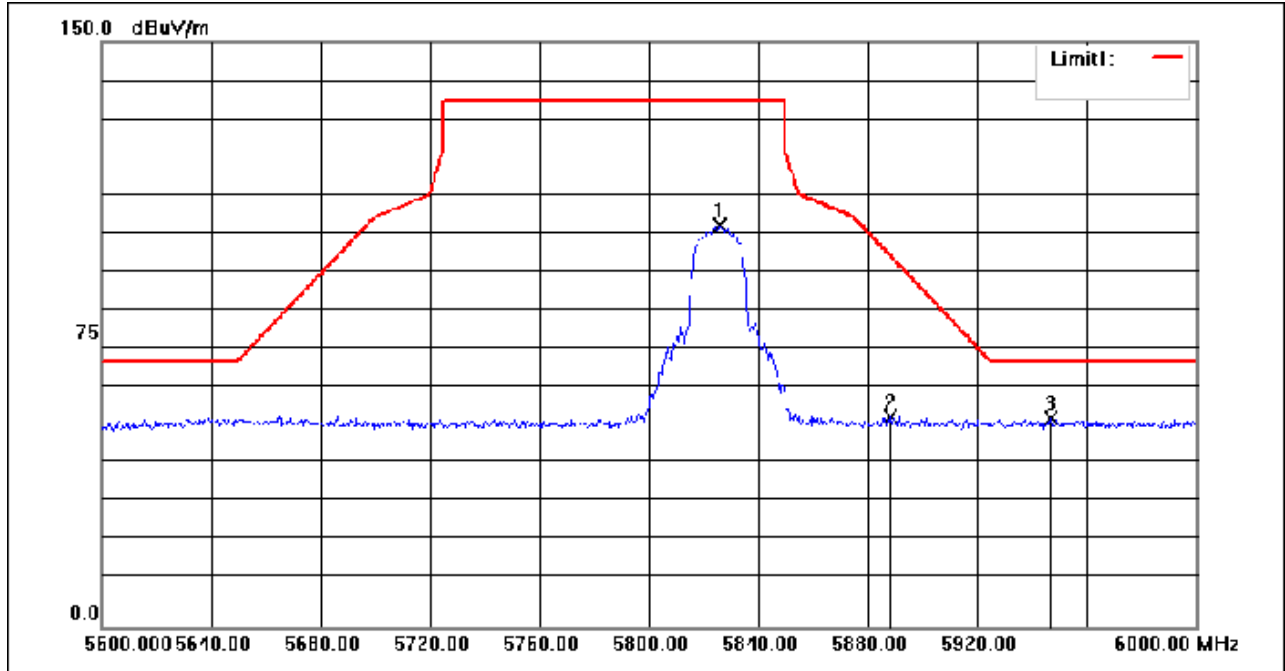

No.	Frequency (MHz)	Reading (dBuV)	Correction factor(dB/m)	Result (dBuV/m)	Limit (dBuV/m)	Margin (dB)	Remark
1	5825.600	111.44	-8.58	102.86	135.00	-32.14	peak
2	5888.000	61.96	-8.30	53.66	95.58	-41.92	peak
3	5946.800	61.43	-8.04	53.39	68.20	-14.81	peak



Unless otherwise agreed in writing, this document is issued by the Company subject to its General Conditions of Service printed overleaf, available on request or accessible at <http://www.sgs.com/en/Terms-and-Conditions.aspx> and, for electronic format documents, subject to Terms and Conditions for Electronic Documents at <http://www.sgs.com/en/Terms-and-Conditions/Terms-e-Documents.aspx>. Attention is drawn to the limitation of liability, indemnification and jurisdiction issues defined therein. Any holder of this document is advised that information contained hereon reflects the Company's findings at the time of its intervention only and within the limits of Client's instructions, if any. The Company's sole responsibility is to its Client and this document does not exonerate parties to a transaction from exercising all their rights and obligations under the transaction documents. This document cannot be reproduced except in full, without prior written approval of the Company. Any unauthorized alteration, forgery or falsification of the content or appearance of this document is unlawful and offenders may be prosecuted to the fullest extent of the law. Unless otherwise stated the results shown in this test report refer only to the sample(s) tested and such sample(s) are retained for 30 days only.  
**Attention: To check the authenticity of testing /inspection report & certificate, please contact us at telephone: (86-755) 8307 1443, or email: CN.Doccheck@sgs.com**

No.10, Weiye Road, Innovation Park, Kunshan, Jiangsu, China 215300  
 中国·江苏·昆山市留学生创业园伟业路10号 邮编 215300

t(86-512)57355888 f(86-512)57370818 www.sgsgroup.com.cn  
 t(86-512)57355888 f(86-512)57370818 sgs.china@sgs.com

Test Mode: 04; Polarity: Horizontal; Modulation:802.11ac; Bandwidth:40MHz; Channel:Low

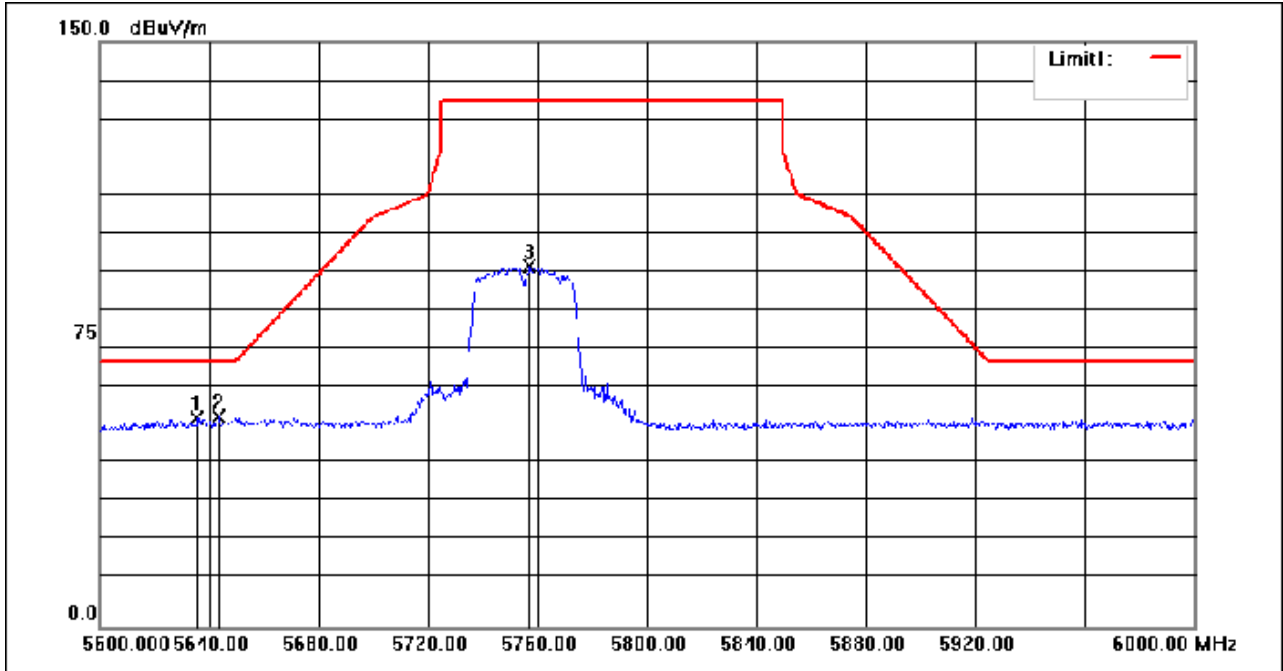

No.	Frequency (MHz)	Reading (dBuV)	Correction factor(dB/m)	Result (dBuV/m)	Limit (dBuV/m)	Margin (dB)	Remark
1	5635.600	62.48	-9.21	53.27	68.20	-14.93	peak
2	5643.600	63.07	-9.19	53.88	68.20	-14.32	peak
3	5757.200	101.10	-8.82	92.28	135.00	-42.72	peak



Unless otherwise agreed in writing, this document is issued by the Company subject to its General Conditions of Service printed overleaf, available on request or accessible at <http://www.sgs.com/en/Terms-and-Conditions.aspx> and, for electronic format documents, subject to Terms and Conditions for Electronic Documents at <http://www.sgs.com/en/Terms-and-Conditions/Terms-e-Document.aspx>. Attention is drawn to the limitation of liability, indemnification and jurisdiction issues defined therein. Any holder of this document is advised that information contained hereon reflects the Company's findings at the time of its intervention only and within the limits of Client's instructions, if any. The Company's sole responsibility is to its Client and this document does not exonerate parties to a transaction from exercising all their rights and obligations under the transaction documents. This document cannot be reproduced except in full, without prior written approval of the Company. Any unauthorized alteration, forgery or falsification of the content or appearance of this document is unlawful and offenders may be prosecuted to the fullest extent of the law. Unless otherwise stated the results shown in this test report refer only to the sample(s) tested and such sample(s) are retained for 30 days only.  
**Attention: To check the authenticity of testing /inspection report & certificate, please contact us at telephone: (86-755) 8307 1443, or email: CN.Doccheck@sgs.com**

No.10, Weiye Road, Innovation Park, Kunshan, Jiangsu, China 215300  
 中国·江苏·昆山市留学生创业园伟业路10号 邮编 215300

t(86-512)57355888 f(86-512)57370818 www.sgsgroup.com.cn  
 t(86-512)57355888 f(86-512)57370818 sgs.china@sgs.com

Test Mode: 04; Polarity: Vertical; Modulation:802.11ac; Bandwidth:40MHz; Channel:Low

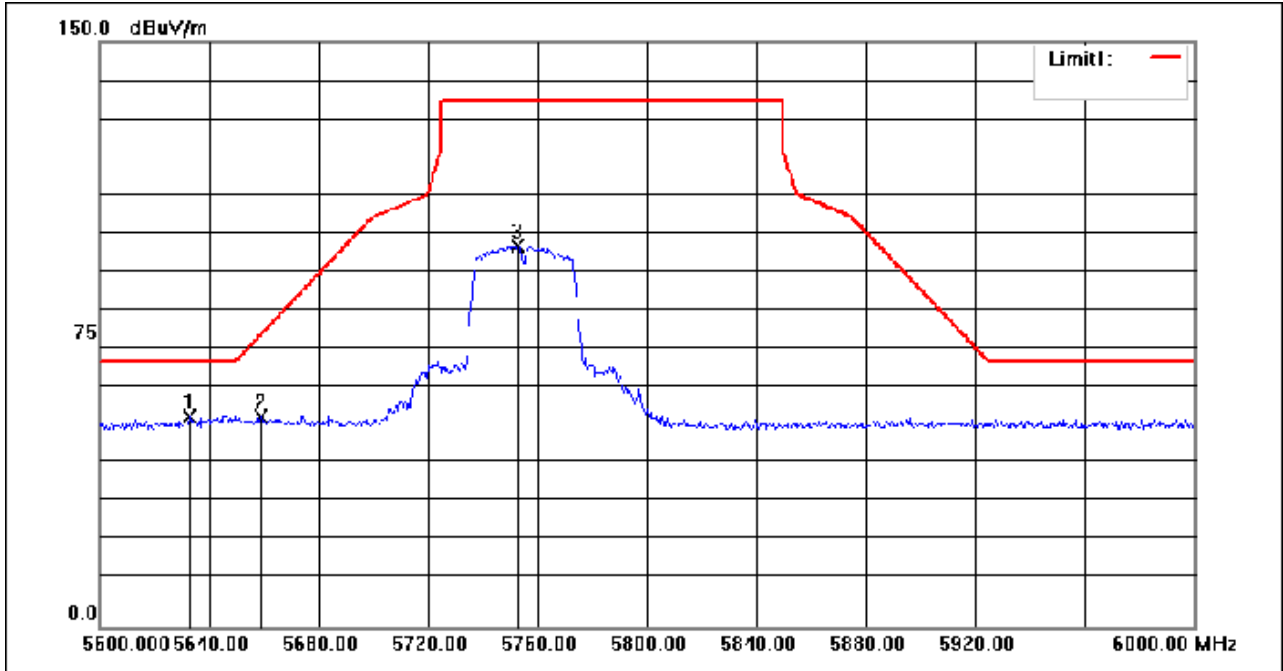

No.	Frequency (MHz)	Reading (dBuV)	Correction factor(dB/m)	Result (dBuV/m)	Limit (dBuV/m)	Margin (dB)	Remark
1	5632.800	62.92	-9.23	53.69	68.20	-14.51	peak
2	5658.800	63.10	-9.14	53.96	74.71	-20.75	peak
3	5752.800	106.56	-8.84	97.72	135.00	-37.28	peak



Unless otherwise agreed in writing, this document is issued by the Company subject to its General Conditions of Service printed overleaf, available on request or accessible at <http://www.sgs.com/en/Terms-and-Conditions.aspx> and, for electronic format documents, subject to Terms and Conditions for Electronic Documents at <http://www.sgs.com/en/Terms-and-Conditions/Terms-e-Documents.aspx>. Attention is drawn to the limitation of liability, indemnification and jurisdiction issues defined therein. Any holder of this document is advised that information contained hereon reflects the Company's findings at the time of its intervention only and within the limits of Client's instructions, if any. The Company's sole responsibility is to its Client and this document does not exonerate parties to a transaction from exercising all their rights and obligations under the transaction documents. This document cannot be reproduced except in full, without prior written approval of the Company. Any unauthorized alteration, forgery or falsification of the content or appearance of this document is unlawful and offenders may be prosecuted to the fullest extent of the law. Unless otherwise stated the results shown in this test report refer only to the sample(s) tested and such sample(s) are retained for 30 days only.  
**Attention: To check the authenticity of testing /inspection report & certificate, please contact us at telephone: (86-755) 8307 1443, or email: CN.Doccheck@sgs.com**

No.10, Weiye Road, Innovation Park, Kunshan, Jiangsu, China 215300  
 中国·江苏·昆山市留学生创业园伟业路10号 邮编 215300

t(86-512)57355888 f(86-512)57370818 www.sgsgroup.com.cn  
 t(86-512)57355888 f(86-512)57370818 sgs.china@sgs.com

Test Mode: 04; Polarity: Horizontal; Modulation:802.11ac; Bandwidth:40MHz; Channel:High

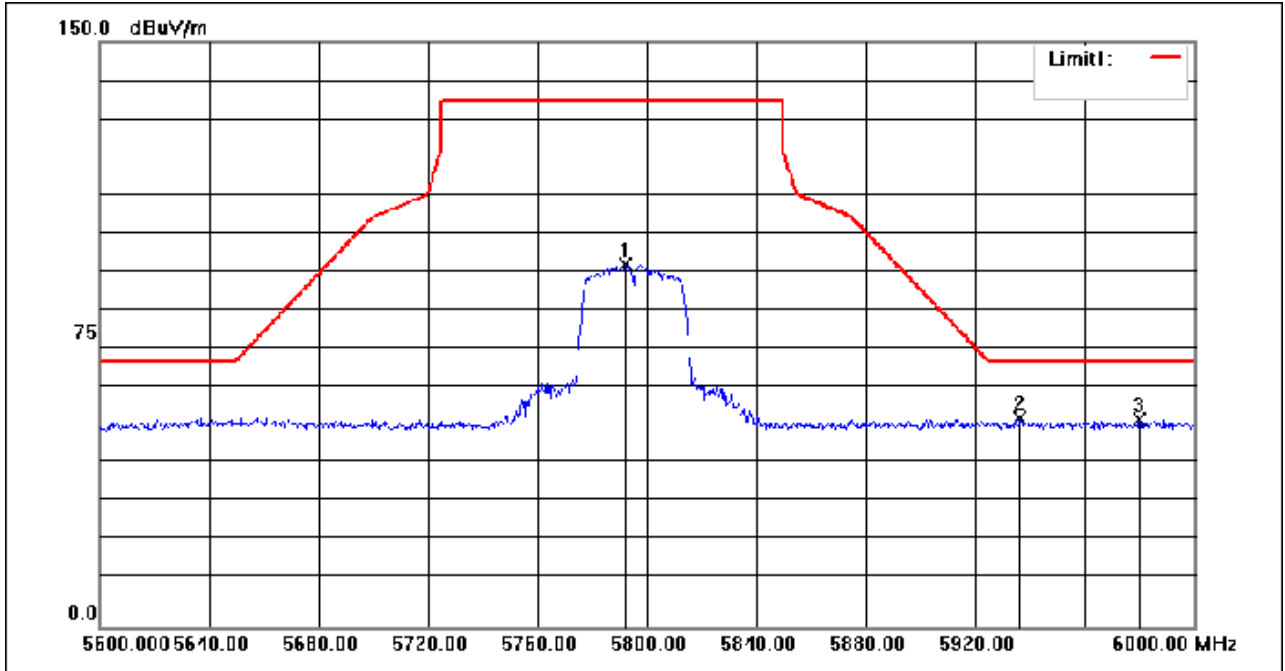

No.	Frequency (MHz)	Reading (dBuV)	Correction factor(dB/m)	Result (dBuV/m)	Limit (dBuV/m)	Margin (dB)	Remark
1	5792.400	101.55	-8.72	92.83	135.00	-42.17	peak
2	5936.400	61.46	-8.08	53.38	68.20	-14.82	peak
3	5980.000	61.03	-7.89	53.14	68.20	-15.06	peak



Unless otherwise agreed in writing, this document is issued by the Company subject to its General Conditions of Service printed overleaf, available on request or accessible at <http://www.sgs.com/en/Terms-and-Conditions.aspx> and, for electronic format documents, subject to Terms and Conditions for Electronic Documents at <http://www.sgs.com/en/Terms-and-Conditions/Terms-e-Documents.aspx>. Attention is drawn to the limitation of liability, indemnification and jurisdiction issues defined therein. Any holder of this document is advised that information contained hereon reflects the Company's findings at the time of its intervention only and within the limits of Client's instructions, if any. The Company's sole responsibility is to its Client and this document does not exonerate parties to a transaction from exercising all their rights and obligations under the transaction documents. This document cannot be reproduced except in full, without prior written approval of the Company. Any unauthorized alteration, forgery or falsification of the content or appearance of this document is unlawful and offenders may be prosecuted to the fullest extent of the law. Unless otherwise stated the results shown in this test report refer only to the sample(s) tested and such sample(s) are retained for 30 days only.  
**Attention: To check the authenticity of testing /inspection report & certificate, please contact us at telephone: (86-755) 8307 1443, or email: CN.Doccheck@sgs.com**

No.10, Weiye Road, Innovation Park, Kunshan, Jiangsu, China 215300  
 中国·江苏·昆山市留学生创业园伟业路10号 邮编 215300

t(86-512)57355888 f(86-512)57370818 www.sgsgroup.com.cn  
 t(86-512)57355888 f(86-512)57370818 sgs.china@sgs.com

Test Mode: 04; Polarity: Vertical; Modulation:802.11ac; Bandwidth:40MHz; Channel:High

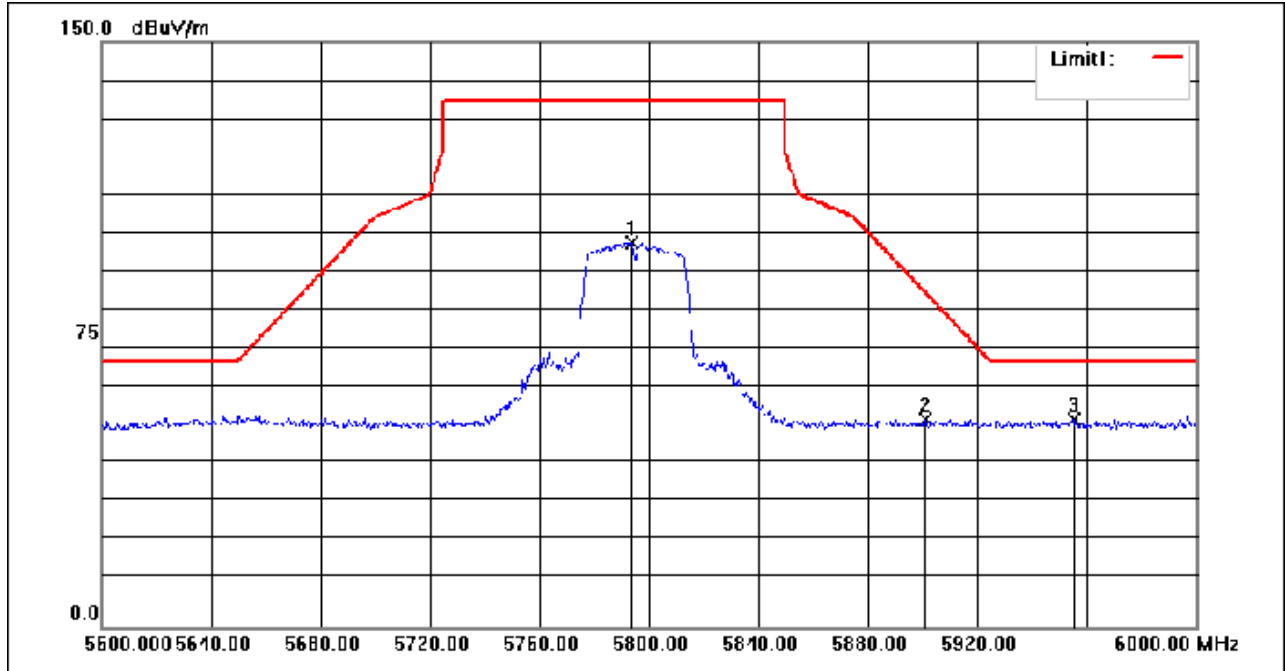

No.	Frequency (MHz)	Reading (dBuV)	Correction factor(dB/m)	Result (dBuV/m)	Limit (dBuV/m)	Margin (dB)	Remark
1	5793.600	107.14	-8.71	98.43	135.00	-36.57	peak
2	5900.800	61.26	-8.24	53.02	86.11	-33.09	peak
3	5955.200	61.01	-8.00	53.01	68.20	-15.19	peak



Unless otherwise agreed in writing, this document is issued by the Company subject to its General Conditions of Service printed overleaf, available on request or accessible at <http://www.sgs.com/en/Terms-and-Conditions.aspx> and, for electronic format documents, subject to Terms and Conditions for Electronic Documents at <http://www.sgs.com/en/Terms-and-Conditions/Terms-e-Documents.aspx>. Attention is drawn to the limitation of liability, indemnification and jurisdiction issues defined therein. Any holder of this document is advised that information contained hereon reflects the Company's findings at the time of its intervention only and within the limits of Client's instructions, if any. The Company's sole responsibility is to its Client and this document does not exonerate parties to a transaction from exercising all their rights and obligations under the transaction documents. This document cannot be reproduced except in full, without prior written approval of the Company. Any unauthorized alteration, forgery or falsification of the content or appearance of this document is unlawful and offenders may be prosecuted to the fullest extent of the law. Unless otherwise stated the results shown in this test report refer only to the sample(s) tested and such sample(s) are retained for 30 days only.  
Attention: To check the authenticity of testing /inspection report & certificate, please contact us at telephone: (86-755) 8307 1443, or email: [CN.Doccheck@sgs.com](mailto:CN.Doccheck@sgs.com)

No.10, Weiye Road, Innovation Park, Kunshan, Jiangsu, China 215300  
中国·江苏·昆山市留学生创业园伟业路10号 邮编 215300

t(86-512)57355888 f(86-512)57370818 www.sgsgroup.com.cn  
t(86-512)57355888 f(86-512)57370818 sgs.china@sgs.com



Test Mode: 04; Polarity: Horizontal; Modulation:802.11ac; Bandwidth:80MHz; Channel:Low

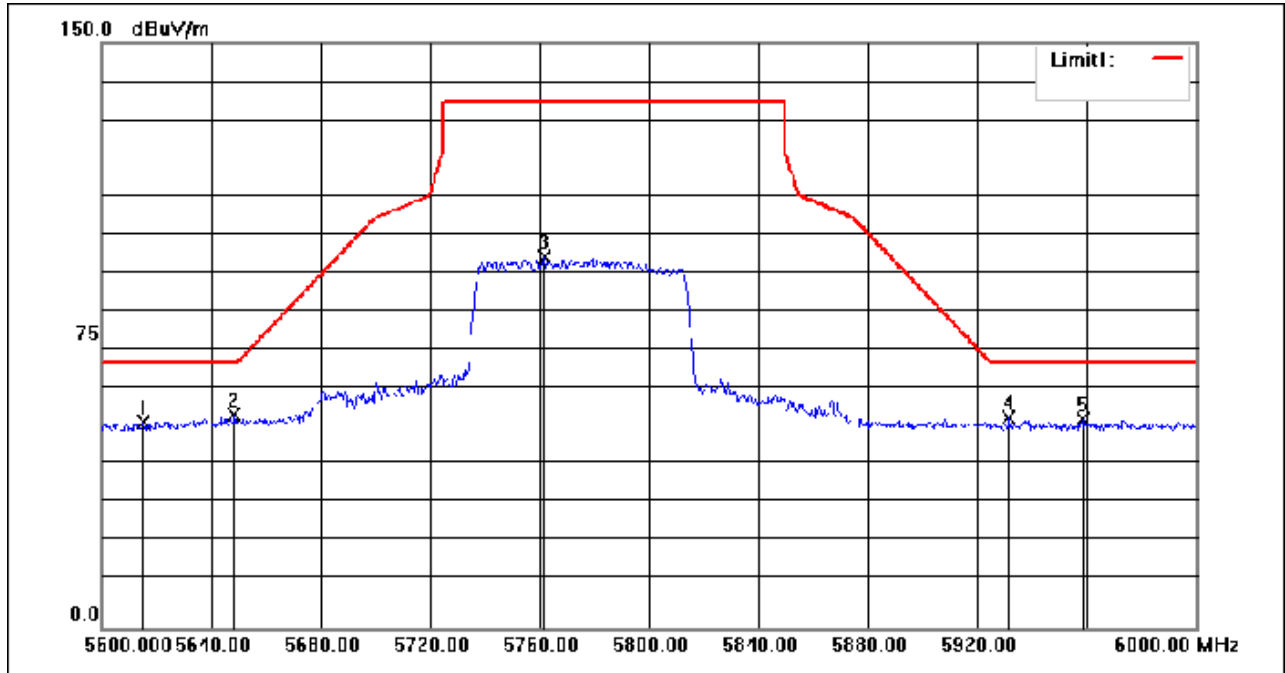

No.	Frequency (MHz)	Reading (dBuV)	Correction factor(dB/m)	Result (dBuV/m)	Limit (dBuV/m)	Margin (dB)	Remark
1	5615.200	61.93	-9.28	52.65	68.20	-15.55	peak
2	5648.400	63.58	-9.18	54.40	68.20	-13.80	peak
3	5761.600	103.74	-8.81	94.93	135.00	-40.07	peak
4	5931.600	61.77	-8.10	53.67	68.20	-14.53	peak
5	5958.400	61.29	-7.98	53.31	68.20	-14.89	peak



Unless otherwise agreed in writing, this document is issued by the Company subject to its General Conditions of Service printed overleaf, available on request or accessible at <http://www.sgs.com/en/Terms-and-Conditions.aspx> and, for electronic format documents, subject to Terms and Conditions for Electronic Documents at <http://www.sgs.com/en/Terms-and-Conditions/Terms-e-Document.aspx>. Attention is drawn to the limitation of liability, indemnification and jurisdiction issues defined therein. Any holder of this document is advised that information contained hereon reflects the Company's findings at the time of its intervention only and within the limits of Client's instructions, if any. The Company's sole responsibility is to its Client and this document does not exonerate parties to a transaction from exercising all their rights and obligations under the transaction documents. This document cannot be reproduced except in full, without prior written approval of the Company. Any unauthorized alteration, forgery or falsification of the content or appearance of this document is unlawful and offenders may be prosecuted to the fullest extent of the law. Unless otherwise stated the results shown in this test report refer only to the sample(s) tested and such sample(s) are retained for 30 days only.  
**Attention: To check the authenticity of testing /inspection report & certificate, please contact us at telephone: (86-755) 8307 1443, or email: CN.Doccheck@sgs.com**

No.10, Weiye Road, Innovation Park, Kunshan, Jiangsu, China 215300  
 中国·江苏·昆山市留学院创业园伟业路10号 邮编 215300

t(86-512)57355888 f(86-512)57370818 www.sgsgroup.com.cn  
 t(86-512)57355888 f(86-512)57370818 sgs.china@sgs.com

Test Mode: 04; Polarity: Vertical; Modulation:802.11ac; Bandwidth:80MHz; Channel:Low

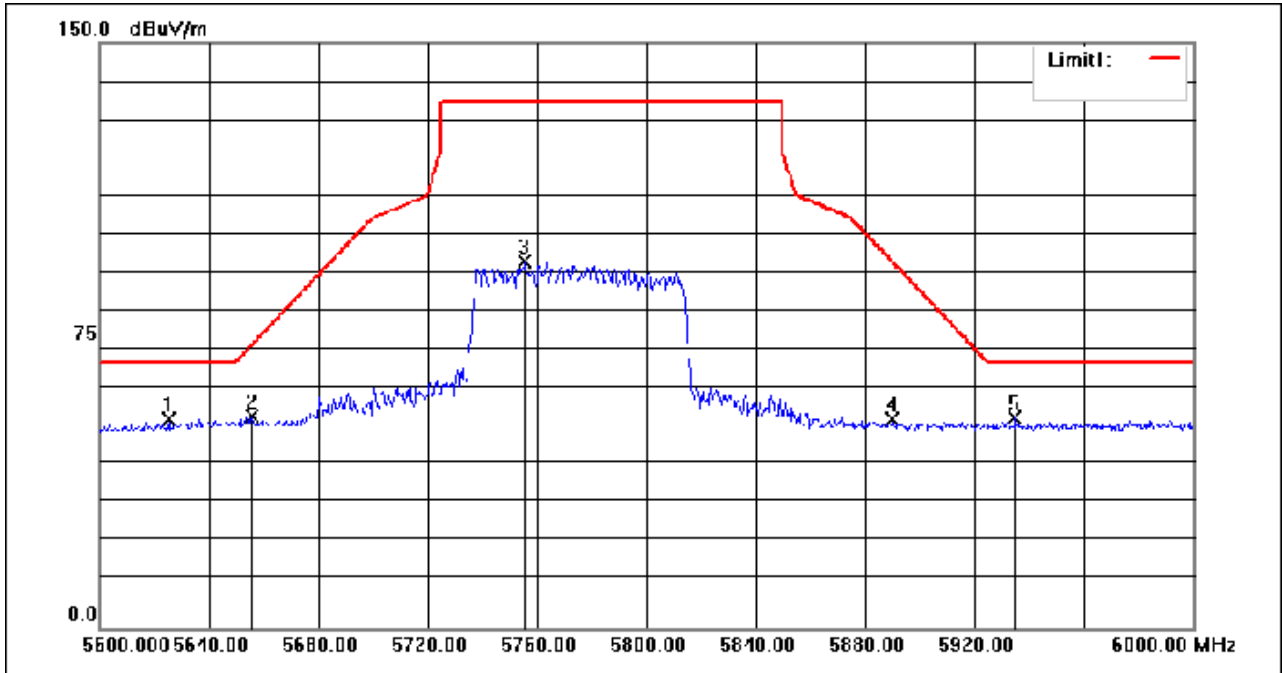

No.	Frequency (MHz)	Reading (dBuV)	Correction factor(dB/m)	Result (dBuV/m)	Limit (dBuV/m)	Margin (dB)	Remark
1	5625.200	62.62	-9.25	53.37	68.20	-14.83	peak
2	5655.600	63.49	-9.15	54.34	72.34	-18.00	peak
3	5755.600	102.70	-8.84	93.86	135.00	-41.14	peak
4	5890.000	61.67	-8.29	53.38	94.10	-40.72	peak
5	5934.800	62.04	-8.09	53.95	68.20	-14.25	peak



Unless otherwise agreed in writing, this document is issued by the Company subject to its General Conditions of Service printed overleaf, available on request or accessible at <http://www.sgs.com/en/Terms-and-Conditions.aspx> and, for electronic format documents, subject to Terms and Conditions for Electronic Documents at <http://www.sgs.com/en/Terms-and-Conditions/Terms-e-Documents.aspx>. Attention is drawn to the limitation of liability, indemnification and jurisdiction issues defined therein. Any holder of this document is advised that information contained hereon reflects the Company's findings at the time of its intervention only and within the limits of Client's instructions, if any. The Company's sole responsibility is to its Client and this document does not exonerate parties to a transaction from exercising all their rights and obligations under the transaction documents. This document cannot be reproduced except in full, without prior written approval of the Company. Any unauthorized alteration, forgery or falsification of the content or appearance of this document is unlawful and offenders may be prosecuted to the fullest extent of the law. Unless otherwise stated the results shown in this test report refer only to the sample(s) tested and such sample(s) are retained for 30 days only.  
**Attention: To check the authenticity of testing /inspection report & certificate, please contact us at telephone: (86-755) 8307 1443, or email: CN.Doccheck@sgs.com**

No.10, Weiye Road, Innovation Park, Kunshan, Jiangsu, China 215300  
 中国·江苏·昆山市留学生创业园伟业路10号 邮编 215300

t(86-512)57355888 f(86-512)57370818 www.sgsgroup.com.cn  
 t(86-512)57355888 f(86-512)57370818 sgs.china@sgs.com

**7.10 Frequency Stability**

Test Requirement 47 CFR Part 15, Subpart E 15.407 (g)

Test Method: ANSI C63.10 (2013) Section 6.8

**7.10.1 E.U.T. Operation**

Operating Environment:

Temperature: 34.3 °C Humidity: 39.6 % RH Atmospheric Pressure: 1010 mbar

**7.10.2 Test Mode Description**

Pre-scan / Final test	Mode Code	Description
Final test	01	Charge + TX mode (U-NII-1)_Keep the EUT in charging and continuously transmitting mode with all modulation types. All data rates for each modulation type have been tested and found the data rate @ 6Mbps is the worst case of IEEE 802.11a; data rate @ MCS0 is the worst case of IEEE 802.11n(HT20); data rate @ MCS0 is the worst case of IEEE 802.11n(HT40); data rate @ MCS0 is the worst case of IEEE 802.11ac(VHT20); data rate @ MCS0 is the worst case of IEEE 802.11ac(VHT40); data rate @ MCS0 is the worst case of IEEE 802.11ac(VHT80), Only the data of worst case is recorded in the report.
Final test	02	Charge + TX mode (U-NII-2A)_Keep the EUT in charging and continuously transmitting mode with all modulation types. All data rates for each modulation type have been tested and found the data rate @ 6Mbps is the worst case of IEEE 802.11a; data rate @ MCS0 is the worst case of IEEE 802.11n(HT20); data rate @ MCS0 is the worst case of IEEE 802.11n(HT40); data rate @ MCS0 is the worst case of IEEE 802.11ac(VHT20); data rate @ MCS0 is the worst case of IEEE 802.11ac(VHT40); data rate @ MCS0 is the worst case of IEEE 802.11ac(VHT80), final test modes are considering the modulation and worst data rates. Only the data of worst case is recorded in the report.
Final test	03	Charge + TX mode (U-NII-2C)_Keep the EUT in charging and continuously transmitting mode with all modulation types. All data rates for each modulation type have been tested and found the data rate @ 6Mbps is the worst case of IEEE 802.11a; data rate @ MCS0 is the worst case of IEEE 802.11n(HT20); data rate @ MCS0 is the worst case of IEEE 802.11n(HT40); data rate @ MCS0 is the worst case of IEEE 802.11ac(VHT20); data rate @ MCS0 is the worst case of IEEE 802.11ac(VHT40); data rate @ MCS0 is the worst case of IEEE 802.11ac(VHT80), Only the data of worst case is recorded in the report.
Final test	04	Charge + TX mode (U-NII-3)_Keep the EUT in charging and continuously transmitting mode with all modulation types. All data rates for each modulation type have been tested and found the data rate @ 6Mbps is the worst case of IEEE 802.11a; data rate @ MCS0 is the worst case of IEEE 802.11n(HT20); data rate @ MCS0 is the worst case of IEEE 802.11n(HT40); data rate @ MCS0 is the worst case of IEEE 802.11ac(VHT20); data rate @ MCS0 is the worst case of IEEE 802.11ac(VHT40); data rate @ MCS0 is the worst case of IEEE 802.11ac(VHT80), Only the data of worst case is recorded in the report.



Unless otherwise agreed in writing, this document is issued by the Company subject to its General Conditions of Service printed overleaf, available on request or accessible at <http://www.sgs.com/en/Terms-and-Conditions.aspx> and, for electronic format documents, subject to Terms and Conditions for Electronic Documents at <http://www.sgs.com/en/Terms-and-Conditions/Terms-e-Documents.aspx>. Attention is drawn to the limitation of liability, indemnification and jurisdiction issues defined therein. Any holder of this document is advised that information contained hereon reflects the Company's findings at the time of its intervention only and within the limits of Client's instructions, if any. The Company's sole responsibility is to its Client and this document does not exonerate parties to a transaction from exercising all their rights and obligations under the transaction documents. This document cannot be reproduced except in full, without prior written approval of the Company. Any unauthorized alteration, forgery or falsification of the content or appearance of this document is unlawful and offenders may be prosecuted to the fullest extent of the law. Unless otherwise stated the results shown in this test report refer only to the sample(s) tested and such sample(s) are retained for 30 days only.  
**Attention: To check the authenticity of testing /inspection report & certificate, please contact us at telephone: (86-755) 8307 1443, or email: CN.Doccheck@sgs.com**

No.10, Weiye Road, Innovation Park, Kunshan, Jiangsu, China 215300  
 中国·江苏·昆山市留学生创业园伟业路10号 邮编 215300

t(86-512)57355888 f(86-512)57370818 www.sgsgroup.com.cn  
 t(86-512)57355888 f(86-512)57370818 sgs.china@sgs.com

## Compliance Certification Services (Kunshan) Inc.

Report No.: KSCR221000189002

Page: 245 of 607

### 7.10.3 Test Setup Diagram

### 7.10.4 Measurement Procedure and Data

Please Refer to Appendix for Details



Unless otherwise agreed in writing, this document is issued by the Company subject to its General Conditions of Service printed overleaf, available on request or accessible at <http://www.sgs.com/en/Terms-and-Conditions.aspx> and, for electronic format documents, subject to Terms and Conditions for Electronic Documents at <http://www.sgs.com/en/Terms-and-Conditions/Terms-e-Documents.aspx>. Attention is drawn to the limitation of liability, indemnification and jurisdiction issues defined therein. Any holder of this document is advised that information contained hereon reflects the Company's findings at the time of its intervention only and within the limits of Client's instructions, if any. The Company's sole responsibility is to its Client and this document does not exonerate parties to a transaction from exercising all their rights and obligations under the transaction documents. This document cannot be reproduced except in full, without prior written approval of the Company. Any unauthorized alteration, forgery or falsification of the content or appearance of this document is unlawful and offenders may be prosecuted to the fullest extent of the law. Unless otherwise stated the results shown in this test report refer only to the sample(s) tested and such sample(s) are retained for 30 days only.  
**Attention: To check the authenticity of testing / inspection report & certificate, please contact us at telephone: (86-755) 8307 1443, or email: CN.Doccheck@sgs.com**

No.10, Weiye Road, Innovation Park, Kunshan, Jiangsu, China 215300  
中国·江苏·昆山市留学生创业园伟业路10号 邮编 215300

t(86-512)57355888 f(86-512)57370818 www.sgsgroup.com.cn  
t(86-512)57355888 f(86-512)57370818 sgs.china@sgs.com



**7.11 Non-occupancy period**

Test Requirement KDB 905462 D02 Section 5.1  
 Test Method: KDB 905462 D02 Section 7.8.3

Limit:

Test item	Limit	Applicability	
		Master Device or client with Radar Detection	Client without Radar Detection
Non-occupancy period	Minimum 30 minutes	Yes	Not required
Channel Availability Check Time	60 seconds	Yes	Not required
Channel Move Time	10 seconds See Note 1.	Yes	Yes
Channel Closing Transmission Time	200 milliseconds + an aggregate of 60 milliseconds over remaining 10 second period. See Notes 1 and 2.	Yes	Yes
U-NII Detection Bandwidth	Minimum 100% of the U-NII 99% transmission power bandwidth. See Note 3.	Yes	Not required

Note 1: Channel Move Time and the Channel Closing Transmission Time should be performed with Radar Type 0. The measurement timing begins at the end of the Radar Type 0 burst.

Note 2: The Channel Closing Transmission Time is comprised of 200 milliseconds starting at the beginning of the Channel Move Time plus any additional intermittent control signals required to facilitate a Channel move (an aggregate of 60 milliseconds) during the remainder of the 10 second period. The aggregate duration of control signals will not count quiet periods in between transmissions.

Note 3: During the U-NII Detection Bandwidth detection test, radar type 0 should be used. For each frequency step the minimum percentage of detection is 90 percent. Measurements are performed with no data traffic.

**7.11.1 E.U.T. Operation**

Operating Environment:

Temperature: 34.3 °C Humidity: 39.6 % RH Atmospheric Pressure: 1010 mbar



Unless otherwise agreed in writing, this document is issued by the Company subject to its General Conditions of Service printed overleaf, available on request or accessible at <http://www.sgs.com/en/Terms-and-Conditions.aspx> and, for electronic format documents, subject to Terms and Conditions for Electronic Documents at <http://www.sgs.com/en/Terms-and-Conditions/Terms-e-Documents.aspx>. Attention is drawn to the limitation of liability, indemnification and jurisdiction issues defined therein. Any holder of this document is advised that information contained hereon reflects the Company's findings at the time of its intervention only and within the limits of Client's instructions, if any. The Company's sole responsibility is to its Client and this document does not exonerate parties to a transaction from exercising all their rights and obligations under the transaction documents. This document cannot be reproduced except in full, without prior written approval of the Company. Any unauthorized alteration, forgery or falsification of the content or appearance of this document is unlawful and offenders may be prosecuted to the fullest extent of the law. Unless otherwise stated the results shown in this test report refer only to the sample(s) tested and such sample(s) are retained for 30 days only.  
**Attention: To check the authenticity of testing /inspection report & certificate, please contact us at telephone: (86-755) 8307 1443, or email: CN.Doccheck@sgs.com**  
 No.10, Weiye Road, Innovation Park, Kunshan, Jiangsu, China 215300 t(86-512)57355888 f(86-512)57370818 www.sgsgroup.com.cn  
 中国·江苏·昆山市留学院创业园伟业路10号 邮编 215300 t(86-512)57355888 f(86-512)57370818 sgs.china@sgs.com



### 7.11.2 Test Mode Description

Pre-scan / Final test	Mode Code	Description
Final test	02	Charge + TX mode (U-NII-2A)_Keep the EUT in charging and continuously transmitting mode with all modulation types. All data rates for each modulation type have been tested and found the data rate @ 6Mbps is the worst case of IEEE 802.11a; data rate @ MCS0 is the worst case of IEEE 802.11n(HT20); data rate @ MCS0 is the worst case of IEEE 802.11n(HT40); data rate @ MCS0 is the worst case of IEEE 802.11ac(VHT20); data rate @ MCS0 is the worst case of IEEE 802.11ac(VHT40); data rate @ MCS0 is the worst case of IEEE 802.11ac(VHT80), Only the data of worst case is recorded in the report.
Final test	03	Charge + TX mode (U-NII-2C)_Keep the EUT in charging and continuously transmitting mode with all modulation types. All data rates for each modulation type have been tested and found the data rate @ 6Mbps is the worst case of IEEE 802.11a; data rate @ MCS0 is the worst case of IEEE 802.11n(HT20); data rate @ MCS0 is the worst case of IEEE 802.11n(HT40); data rate @ MCS0 is the worst case of IEEE 802.11ac(VHT20); data rate @ MCS0 is the worst case of IEEE 802.11ac(VHT40); data rate @ MCS0 is the worst case of IEEE 802.11ac(VHT80),. Only the data of worst case is recorded in the report.

### 7.11.3 Test Setup Diagram

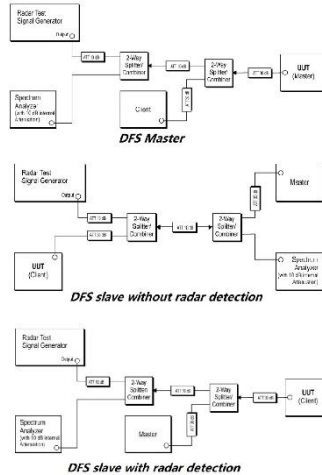

Unless otherwise agreed in writing, this document is issued by the Company subject to its General Conditions of Service printed overleaf, available on request or accessible at <http://www.sgs.com/en/Terms-and-Conditions.aspx> and, for electronic format documents, subject to Terms and Conditions for Electronic Documents at <http://www.sgs.com/en/Terms-and-Conditions/Terms-e-Documents.aspx>. Attention is drawn to the limitation of liability, indemnification and jurisdiction issues defined therein. Any holder of this document is advised that information contained hereon reflects the Company's findings at the time of its intervention only and within the limits of Client's instructions, if any. The Company's sole responsibility is to its Client and this document does not exonerate parties to a transaction from exercising all their rights and obligations under the transaction documents. This document cannot be reproduced except in full, without prior written approval of the Company. Any unauthorized alteration, forgery or falsification of the content or appearance of this document is unlawful and offenders may be prosecuted to the fullest extent of the law. Unless otherwise stated the results shown in this test report refer only to the sample(s) tested and such sample(s) are retained for 30 days only.

**Attention: To check the authenticity of testing / inspection report & certificate, please contact us at telephone: (86-755) 8307 1443, or email: CN.Doccheck@sgs.com**

No.10, Weiye Road, Innovation Park, Kunshan, Jiangsu, China 215300  
 中国·江苏·昆山市留学生创业园伟业路10号 邮编 215300

t(86-512)57355888 f(86-512)57370818 www.sgsgroup.com.cn  
 t(86-512)57355888 f(86-512)57370818 sgs.china@sgs.com

**7.11.4 Measurement Procedure and Data**

- 1) The radar pulse generator is setup to provide a pulse at frequency that the master and client are operating. A type 0 radar pulse with a 1us pulse width and a 1428us PRI is used for the testing.
- 2) The vector signal generator is adjusted to provide the radar burst (18 pulses) at the level of approximately -61dBm at the antenna port of the master device.
- 3) A trigger is provided from the pulse generator to the DFS monitoring system in order to capture the traffic and the occurrence of the radar pulse.
- 4) EUT will associate with the master at channel. The file “iperf.exe” specified by the FCC is streamed from the PC 2 through the master and the client device to the PC 1 and played in full motion video using Media Player Classic Ver. 6.4.8.6 in order to properly load the network for the entire period of the test.
- 5) When radar burst with a level equal to the DFS Detection Threshold +1dB is generated on the operating channel of the U-NII device. At time T0 the radar waveform generator sends a burst of pulse of the radar waveform at Detection Threshold +1dB.
- 6) Observe the transmissions of the EUT at the end of the radar Burst on the Operating Channel. Measure and record the transmissions from the UUT during the observation time (Channel Move Time). One 15 seconds plot is reported for the Short Pulse Radar Type 0. The plot for the Short Pulse Radar Types start at the end of the radar burst. The Channel Move Time will be calculated based on the zoom in 600ms plot of the Short Pulse Radar Type.
- 7) Measurement of the aggregate duration of the Channel Closed Transmission Time method. With the spectrum analyzer set to zero span tuned to the center frequency of the EUT operating channel at the radar simulated frequency, peak detection, and max hold, the dwell time per bin is given by:  $Dwell (0.3ms) = S (12000ms) / B (4000)$ ; where Dwell is the dwell time per spectrum analyzer sampling bin, S is sweep time and B is the number of spectrum analyzer sampling bins. An upper bound of the aggregate duration of the intermittent control signals of Channel Closing Transmission Time is calculated by:  $C (ms) = N \times Dwell (0.3ms)$ ; where C is the Closing Time, N is the number of spectrum analyzer sampling bins (intermittent control signals) showing a U-NII transmission and Dwell is the dwell time per bin.
- 8) Measurement the EUT for more than 30 minutes following the channel move time to verify that no transmission or beacons occur on this channel.

Please Refer to Appendix for Details



Unless otherwise agreed in writing, this document is issued by the Company subject to its General Conditions of Service printed overleaf, available on request or accessible at <http://www.sgs.com/en/Terms-and-Conditions.aspx> and, for electronic format documents, subject to Terms and Conditions for Electronic Documents at <http://www.sgs.com/en/Terms-and-Conditions/Terms-e-Documents.aspx>. Attention is drawn to the limitation of liability, indemnification and jurisdiction issues defined therein. Any holder of this document is advised that information contained hereon reflects the Company's findings at the time of its intervention only and within the limits of Client's instructions, if any. The Company's sole responsibility is to its Client and this document does not exonerate parties to a transaction from exercising all their rights and obligations under the transaction documents. This document cannot be reproduced except in full, without prior written approval of the Company. Any unauthorized alteration, forgery or falsification of the content or appearance of this document is unlawful and offenders may be prosecuted to the fullest extent of the law. Unless otherwise stated the results shown in this test report refer only to the sample(s) tested and such sample(s) are retained for 30 days only.  
**Attention: To check the authenticity of testing /inspection report & certificate, please contact us at telephone: (86-755) 8307 1443, or email: CN.Doccheck@sgs.com**

No.10, Weiye Road, Innovation Park, Kunshan, Jiangsu, China 215300      t(86-512)57355888      f(86-512)57370818      www.sgsgroup.com.cn  
 中国·江苏·昆山市留学生创业园伟业路10号 邮编 215300      t(86-512)57355888      f(86-512)57370818      sgs.china@sgs.com

**7.12 Channel Move Time**

Test Requirement KDB 905462 D02 Section 5.1  
 Test Method: KDB 905462 D02 Section 7.8.3

Limit:

Test item	Limit	Applicability	
		Master Device or client with Radar Detection	Client without Radar Detection
Non-occupancy period	Minimum 30 minutes	Yes	Not required
Channel Availability Check Time	60 seconds	Yes	Not required
Channel Move Time	10 seconds See Note 1.	Yes	Yes
Channel Closing Transmission Time	200 milliseconds + an aggregate of 60 milliseconds over remaining 10 second period. See Notes 1 and 2.	Yes	Yes
U-NII Detection Bandwidth	Minimum 100% of the U-NII 99% transmission power bandwidth. See Note 3.	Yes	Not required

Note 1: Channel Move Time and the Channel Closing Transmission Time should be performed with Radar Type 0. The measurement timing begins at the end of the Radar Type 0 burst.

Note 2: The Channel Closing Transmission Time is comprised of 200 milliseconds starting at the beginning of the Channel Move Time plus any additional intermittent control signals required to facilitate a Channel move (an aggregate of 60 milliseconds) during the remainder of the 10 second period. The aggregate duration of control signals will not count quiet periods in between transmissions.

Note 3: During the U-NII Detection Bandwidth detection test, radar type 0 should be used. For each frequency step the minimum percentage of detection is 90 percent. Measurements are performed with no data traffic.

**7.12.1 E.U.T. Operation**

Operating Environment:

Temperature: 34.3 °C Humidity: 39.7 % RH Atmospheric Pressure: 1010 mbar



Unless otherwise agreed in writing, this document is issued by the Company subject to its General Conditions of Service printed overleaf, available on request or accessible at <http://www.sgs.com/en/Terms-and-Conditions.aspx> and, for electronic format documents, subject to Terms and Conditions for Electronic Documents at <http://www.sgs.com/en/Terms-and-Conditions/Terms-e-Documents.aspx>. Attention is drawn to the limitation of liability, indemnification and jurisdiction issues defined therein. Any holder of this document is advised that information contained hereon reflects the Company's findings at the time of its intervention only and within the limits of Client's instructions, if any. The Company's sole responsibility is to its Client and this document does not exonerate parties to a transaction from exercising all their rights and obligations under the transaction documents. This document cannot be reproduced except in full, without prior written approval of the Company. Any unauthorized alteration, forgery or falsification of the content or appearance of this document is unlawful and offenders may be prosecuted to the fullest extent of the law. Unless otherwise stated the results shown in this test report refer only to the sample(s) tested and such sample(s) are retained for 30 days only.  
**Attention: To check the authenticity of testing /inspection report & certificate, please contact us at telephone: (86-755) 8307 1443, or email: CN.Doccheck@sgs.com**

No.10, Weiye Road, Innovation Park, Kunshan, Jiangsu, China 215300 t(86-512)57355888 f(86-512)57370818 www.sgsgroup.com.cn  
 中国·江苏·昆山市留学院创业园伟业路10号 邮编 215300 t(86-512)57355888 f(86-512)57370818 sgs.china@sgs.com

### 7.12.2 Test Mode Description

Pre-scan / Final test	Mode Code	Description
Final test	02	Charge + TX mode (U-NII-2A)_Keep the EUT in charging and continuously transmitting mode with all modulation types. All data rates for each modulation type have been tested and found the data rate @ 6Mbps is the worst case of IEEE 802.11a; data rate @ MCS0 is the worst case of IEEE 802.11n(HT20); data rate @ MCS0 is the worst case of IEEE 802.11n(HT40); data rate @ MCS0 is the worst case of IEEE 802.11ac(VHT20); data rate @ MCS0 is the worst case of IEEE 802.11ac(VHT40); data rate @ MCS0 is the worst case of IEEE 802.11ac(VHT80), Only the data of worst case is recorded in the report.
Final test	03	Charge + TX mode (U-NII-2C)_Keep the EUT in charging and continuously transmitting mode with all modulation types. All data rates for each modulation type have been tested and found the data rate @ 6Mbps is the worst case of IEEE 802.11a; data rate @ MCS0 is the worst case of IEEE 802.11n(HT20); data rate @ MCS0 is the worst case of IEEE 802.11n(HT40); data rate @ MCS0 is the worst case of IEEE 802.11ac(VHT20); data rate @ MCS0 is the worst case of IEEE 802.11ac(VHT40); data rate @ MCS0 is the worst case of IEEE 802.11ac(VHT80), Only the data of worst case is recorded in the report.

### 7.12.3 Test Setup Diagram

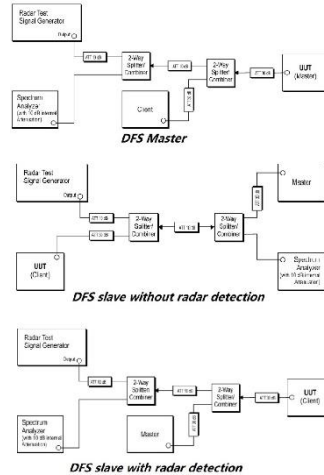

Unless otherwise agreed in writing, this document is issued by the Company subject to its General Conditions of Service printed overleaf, available on request or accessible at <http://www.sgs.com/en/Terms-and-Conditions.aspx> and, for electronic format documents, subject to Terms and Conditions for Electronic Documents at <http://www.sgs.com/en/Terms-and-Conditions/Terms-e-Documents.aspx>. Attention is drawn to the limitation of liability, indemnification and jurisdiction issues defined therein. Any holder of this document is advised that information contained hereon reflects the Company's findings at the time of its intervention only and within the limits of Client's instructions, if any. The Company's sole responsibility is to its Client and this document does not exonerate parties to a transaction from exercising all their rights and obligations under the transaction documents. This document cannot be reproduced except in full, without prior written approval of the Company. Any unauthorized alteration, forgery or falsification of the content or appearance of this document is unlawful and offenders may be prosecuted to the fullest extent of the law. Unless otherwise stated the results shown in this test report refer only to the sample(s) tested and such sample(s) are retained for 30 days only.

Attention: To check the authenticity of testing / inspection report & certificate, please contact us at telephone: (86-755) 8307 1443, or email: [CN.Doccheck@sgs.com](mailto:CN.Doccheck@sgs.com)

No.10, Weiye Road, Innovation Park, Kunshan, Jiangsu, China 215300  
中国·江苏·昆山市留学生创业园伟业路10号 邮编 215300

t(86-512)57355888 f(86-512)57370818 www.sgsgroup.com.cn  
t(86-512)57355888 f(86-512)57370818 sgs.china@sgs.com



**7.12.4 Measurement Procedure and Data**

- 1) The radar pulse generator is setup to provide a pulse at frequency that the master and client are operating. A type 0 radar pulse with a 1us pulse width and a 1428us PRI is used for the testing.
- 2) The vector signal generator is adjusted to provide the radar burst (18 pulses) at the level of approximately -61dBm at the antenna port of the master device.
- 3) A trigger is provided from the pulse generator to the DFS monitoring system in order to capture the traffic and the occurrence of the radar pulse.
- 4) EUT will associate with the master at channel. The file “iperf.exe” specified by the FCC is streamed from the PC 2 through the master and the client device to the PC 1 and played in full motion video using Media Player Classic Ver. 6.4.8.6 in order to properly load the network for the entire period of the test.
- 5) When radar burst with a level equal to the DFS Detection Threshold +1dB is generated on the operating channel of the U-NII device. At time T0 the radar waveform generator sends a burst of pulse of the radar waveform at Detection Threshold +1dB.
- 6) Observe the transmissions of the EUT at the end of the radar Burst on the Operating Channel. Measure and record the transmissions from the UUT during the observation time (Channel Move Time). One 15 seconds plot is reported for the Short Pulse Radar Type 0. The plot for the Short Pulse Radar Types start at the end of the radar burst. The Channel Move Time will be calculated based on the zoom in 600ms plot of the Short Pulse Radar Type.
- 7) Measurement of the aggregate duration of the Channel Closed Transmission Time method. With the spectrum analyzer set to zero span tuned to the center frequency of the EUT operating channel at the radar simulated frequency, peak detection, and max hold, the dwell time per bin is given by:  $Dwell (0.3ms) = S (12000ms) / B (4000)$ ; where Dwell is the dwell time per spectrum analyzer sampling bin, S is sweep time and B is the number of spectrum analyzer sampling bins. An upper bound of the aggregate duration of the intermittent control signals of Channel Closing Transmission Time is calculated by:  $C (ms) = N \times Dwell (0.3ms)$ ; where C is the Closing Time, N is the number of spectrum analyzer sampling bins (intermittent control signals) showing a U-NII transmission and Dwell is the dwell time per bin.
- 8) Measurement the EUT for more than 30 minutes following the channel move time to verify that no transmission or beacons occur on this channel.

Please Refer to Appendix for Details



Unless otherwise agreed in writing, this document is issued by the Company subject to its General Conditions of Service printed overleaf, available on request or accessible at <http://www.sgs.com/en/Terms-and-Conditions.aspx> and, for electronic format documents, subject to Terms and Conditions for Electronic Documents at <http://www.sgs.com/en/Terms-and-Conditions/Terms-e-Documents.aspx>. Attention is drawn to the limitation of liability, indemnification and jurisdiction issues defined therein. Any holder of this document is advised that information contained hereon reflects the Company's findings at the time of its intervention only and within the limits of Client's instructions, if any. The Company's sole responsibility is to its Client and this document does not exonerate parties to a transaction from exercising all their rights and obligations under the transaction documents. This document cannot be reproduced except in full, without prior written approval of the Company. Any unauthorized alteration, forgery or falsification of the content or appearance of this document is unlawful and offenders may be prosecuted to the fullest extent of the law. Unless otherwise stated the results shown in this test report refer only to the sample(s) tested and such sample(s) are retained for 30 days only.  
**Attention: To check the authenticity of testing /inspection report & certificate, please contact us at telephone: (86-755) 8307 1443, or email: CN.Doccheck@sgs.com**

No.10, Weiye Road, Innovation Park, Kunshan, Jiangsu, China 215300      t(86-512)57355888      f(86-512)57370818      www.sgsgroup.com.cn  
 中国·江苏·昆山市留学院创业园伟业路10号 邮编 215300      t(86-512)57355888      f(86-512)57370818      sgs.china@sgs.com