

Attendance Standalone

Quick Start Guide







Foreword

General

This manual introduces the functions and operations of the Attendance Standalone (hereinafter referred to as the "Device"). Read carefully before using the Device, and keep the manual safe for future reference.

Safety Instructions

The following signal words might appear in the manual.

Signal Words	Meaning
 DANGER	Indicates a high potential hazard which, if not avoided, will result in death or serious injury.
 WARNING	Indicates a medium or low potential hazard which, if not avoided, could result in slight or moderate injury.
 CAUTION	Indicates a potential risk which, if not avoided, could result in property damage, data loss, reductions in performance, or unpredictable results.
 TIPS	Provides methods to help you solve a problem or save time.
 NOTE	Provides additional information as a supplement to the text.

Revision History

Version	Revision Content	Release Time
V1.0.1	Updated the manual.	November 2022
V1.0.1	Updated the manual.	September 2022
V1.0.0	First Release.	April 2019

Privacy Protection Notice

As the device user or data controller, you might collect the personal data of others such as their face, fingerprints, and license plate number. You need to be in compliance with your local privacy protection laws and regulations to protect the legitimate rights and interests of other people by implementing measures which include but are not limited: Providing clear and visible identification to inform people of the existence of the surveillance area and provide required contact information.

About the Manual

- The manual is for reference only. Slight differences might be found between the manual and the product.
- We are not liable for losses incurred due to operating the product in ways that are not in compliance with the manual.
- The manual will be updated according to the latest laws and regulations of related jurisdictions. For detailed information, see the paper user's manual, use our CD-ROM, scan the QR code or visit our official website. The manual is for reference only. Slight differences might be found between the electronic version and the paper version.
- All designs and software are subject to change without prior written notice. Product updates might result in some differences appearing between the actual product and the manual. Please contact customer service for the latest program and supplementary documentation.
- There might be errors in the print or deviations in the description of the functions, operations and technical data. If there is any doubt or dispute, we reserve the right of final explanation.
- Upgrade the reader software or try other mainstream reader software if the manual (in PDF format) cannot be opened.
- All trademarks, registered trademarks and company names in the manual are properties of their respective owners.
- Please visit our website, contact the supplier or customer service if any problems occur while using the device.
- If there is any uncertainty or controversy, we reserve the right of final explanation.

Important Safeguards and Warnings

This section introduces content covering the proper handling of the Device, hazard prevention, and prevention of property damage. Read carefully before using the Device, and comply with the guidelines when using it.

Transportation Requirement



Transport, use and store the Device under allowed humidity and temperature conditions.

Storage Requirement



Store the Device under allowed humidity and temperature conditions.

Installation Requirements



- Do not connect the power adapter to the Device while the adapter is powered on.
- Strictly comply with the local electric safety code and standards. Make sure the ambient voltage is stable and meets the power supply requirements of the Device.
- Do not connect the Device to two or more kinds of power supplies, to avoid damage to the Device.
- Improper use of the battery might result in a fire or explosion.
- The Device is only suitable for mounting at heights ≤ 2 m.



- Personnel working at heights must take all necessary measures to ensure personal safety including wearing a helmet and safety belts.
- Do not place the Device in a place exposed to sunlight or near heat sources.
- Keep the Device away from dampness, dust, and soot.
- Install the Device on a stable surface to prevent it from falling.
- Install the Device in a well-ventilated place, and do not block its ventilation.
- Use an adapter or cabinet power supply provided by the manufacturer.

- Use the power cords that are recommended for the region and conform to the rated power specifications.
- The power supply must conform to the requirements of ES1 in IEC 62368-1 standard and be no higher than PS2. Please note that the power supply requirements are subject to the Device label.
- The Device is a class I electrical appliance. Make sure that the power supply of the Device is connected to a power socket with protective earthing.

Operation Requirements



- Check whether the power supply is correct before use.
- Do not unplug the power cord on the side of the Device while the adapter is powered on.
- Operate the Device within the rated range of power input and output.
- Use the Device under allowed humidity and temperature conditions.
- Do not drop or splash liquid onto the Device, and make sure that there is no object filled with liquid on the Device to prevent liquid from flowing into it.
- Do not disassemble the Device without professional instruction.

Table of Contents

1 Overview	1
1.1 Introduction.....	1
1.2 Features.....	1
1.3 Appearance.....	1
1.4 Dimensions.....	3
2 Installation	4
2.1 Installation Methods.....	4
2.2 Cable Connection.....	5
3 Operation	6
3.1 Notice.....	6
3.2 Main Menu.....	6
3.3 Attendance Check Methods.....	7
3.4 User.....	9
3.4.1 Add New Users.....	9
3.4.2 Query & Edit User.....	10
3.4.3 Edit Department.....	11
3.4.4 Add Cards in Batch.....	12
3.5 Data.....	12
3.5.1 Query User ATT. Log.....	12
3.5.2 Export Monthly User ATT. Log/Export Monthly ATT. Report.....	13
3.6 Shift.....	13
3.6.1 Shift Setting.....	13
3.6.2 Schedule Setup.....	14
3.6.3 Late-in/Early-out Allowed.....	16
3.7 USB.....	16
3.7.1 Import/Export User Info.....	16
3.7.2 Import/Export User FP.....	16
3.7.3 Import/Export Bell Info.....	17
3.7.4 Import/Export Auto Switch Time.....	17
3.8 Feature.....	17
3.8.1 Date & Time.....	17
3.8.2 Communication.....	18
3.8.3 Features.....	18
3.8.4 System.....	21
3.8.5 Language.....	22
3.9 System.....	22
4 Attendance Configuration on SmartPSS	23
4.1 Creating Departments and Adding Users.....	23
4.1.1 Creating Departments.....	23
4.1.2 Adding Users.....	24
4.2 Attendance Setting.....	25
4.2.1 Attendance Time Zone.....	25
4.2.2 Attendance Shift.....	27
4.2.3 Holiday.....	28

4.2.4 Attendance Event.....	29
4.3 Shift Schedule	30
4.4 Viewing Real-Time Attendance Check Detail.....	32
4.5 Attendance Report.....	34
Appendix 1 Fingerprint Record Description.....	35
Appendix 2 Text Input.....	37
Appendix 3 FAQ.....	38
Appendix 4 Cybersecurity Recommendations.....	40

1 Overview

1.1 Introduction

The Device can be used to check attendance. The attendance check can be completed through three methods: fingerprint, password, and card.

1.2 Features

- High capacity standby battery works for upto 10 hours in the standby mode.
- Can be connected to the third party access control device.
- 1, 000 user information (ID, name, fingerprint, password, card number) can be recorded on Device.
- Stores up to 100, 000 attendance record reports and 10, 000 management records.
- All users can query their own attendance records.
- Only administrators can add new users, edit user information, query, import or export attendance logs and attendance reports.
- USB disk update firmware.
- T9 text input.
- 24 groups of shift.
- 20 departments.

1.3 Appearance

Figure 1-1



Table 1-1 Key description

Icon	Description
0-9	Number keys for number and letter input.

Icon	Description
ESC/F1	<ul style="list-style-type: none"> Press the key to exit or go to the previous menu. On the standby interface, press the button to check in.
^/F2	<ul style="list-style-type: none"> In the standby mode, press the key, BREAK OUT will be displayed on the screen. Up (direction key; attendance type switch).
∨/F3	<ul style="list-style-type: none"> In the standby mode, press the key, BREAK IN will be displayed on the screen. Down (direction key; attendance type switch).
OK/F4	<ul style="list-style-type: none"> Enter or confirm. On the standby interface, press the key to check out.
#	Delete key or shortcut key for reviewing records.
	<ul style="list-style-type: none"> When the Device is off/on, press the key to turn the Device on/off (press the key for over three seconds to turn the Device off). On the standby mode, press the key, and then administrators can go to the main menu by fingerprints, passwords, or cards. When you need to enter text, press the key, and then you can switch text input types (numbers, letters and punctuation).

Figure 1-2

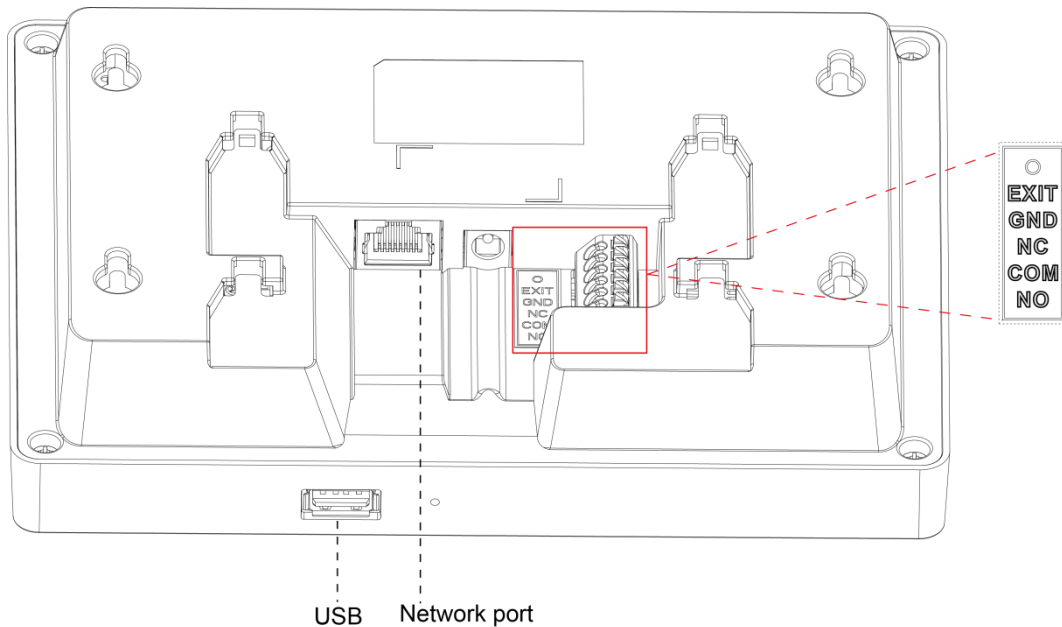

Table 1-2 Port description

Port	Description
EXIT	Connected to the door exit button.
GND	Connected to the ground line.
NC	Makes the relay normally closed.
COM	COM port.

Port	Description
NO	Makes the relay normally on.

1.4 Dimensions

Figure 1-3 Dimensions (mm)

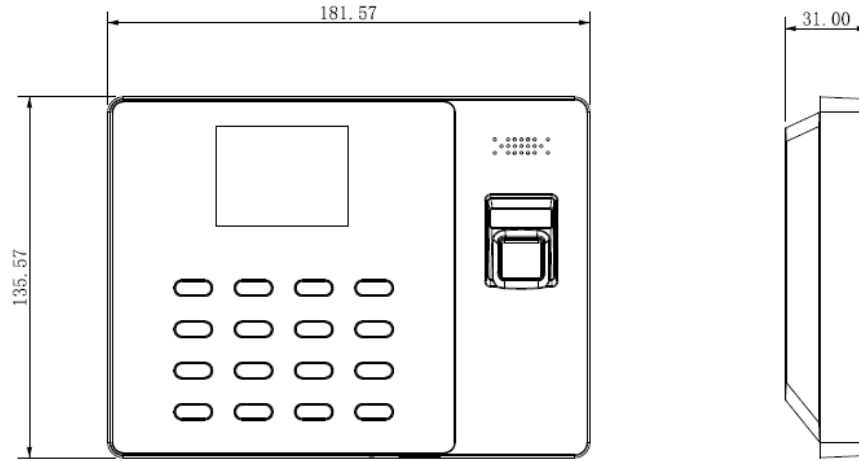

2 Installation

2.1 Installation Methods

Installed through the 86 electrical box

Figure 2-1 Installed through 86 electrical box

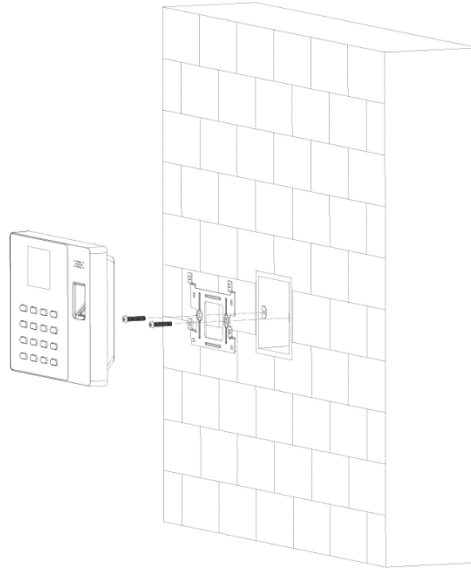

Directly installed on the wall

Figure 2-2 Directly installed on the wall

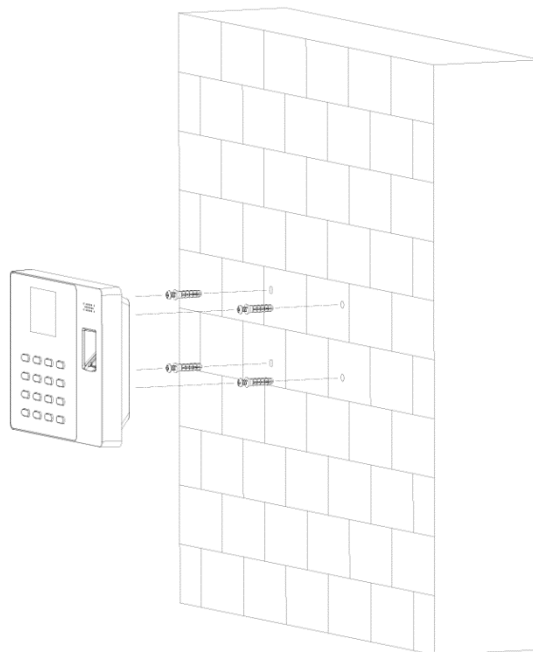

Installed through the bracket

Figure 2-3 Installed through bracket

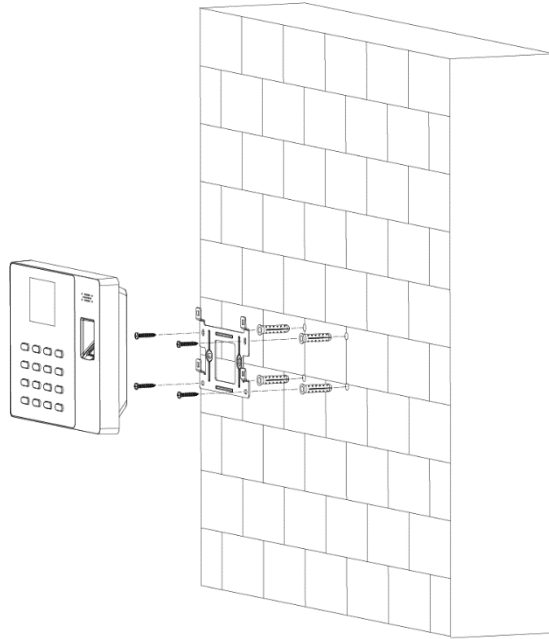

2.2 Cable Connection

The Device can be connected to exit button to control the door. See Figure 2-4.

Figure 2-4 Cable connection

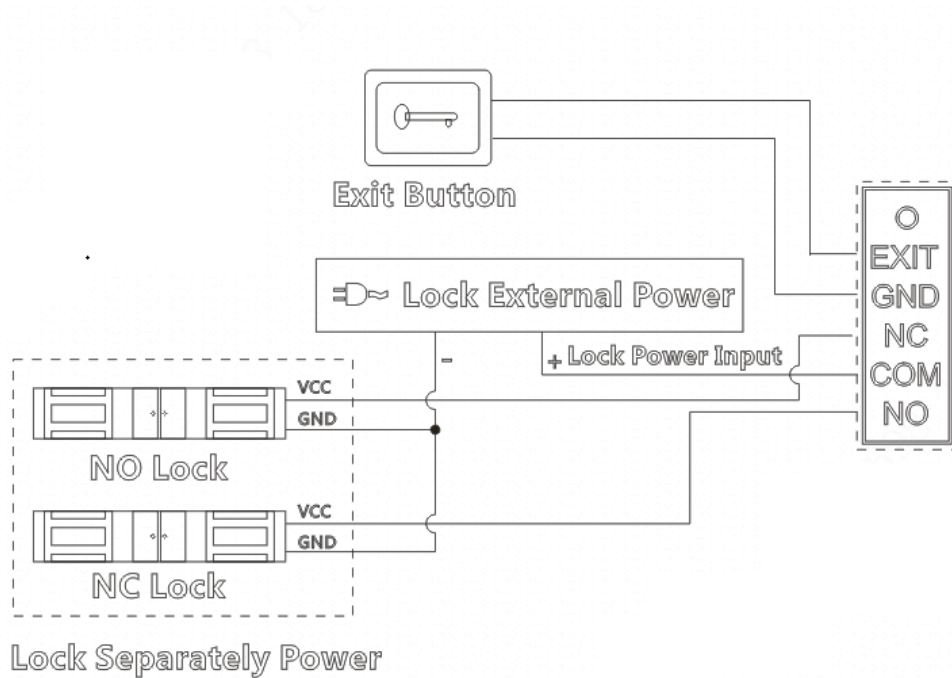

3 Operation

3.1 Notice

- When the Device is connected to the power source, you need to press  to turn it on.
- Before an administrator is created, anyone can enter the main menu and do settings for the Device. For the sake of information security, you need to create administrators first (Select **1 User** > **Add New User**, and then select a user ID. Select **User Level**, press **OK/F4** and then **^/F2** or **∇/F3** to select **Administrator**).
- When you need to connect the Device to SmartPSS (the management platform), the default ID is "admin" and the default password is also "admin".
- Settings about shifts, schedules, and departments in the Device are independent of those on SmartPSS.
- For standalone system framework, see Figure 3-1.

Figure 3-1 System framework



3.2 Main Menu

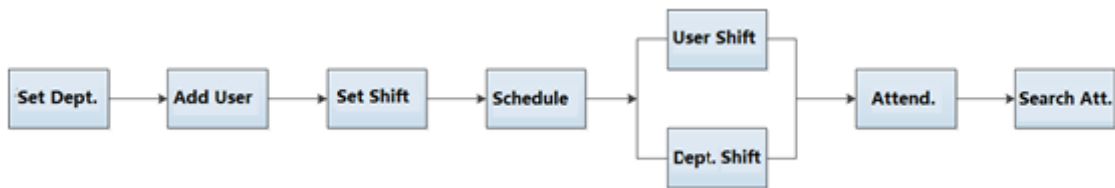

Standby mode

Before you enter the main page, the interface below is displayed. See Figure 3-2.

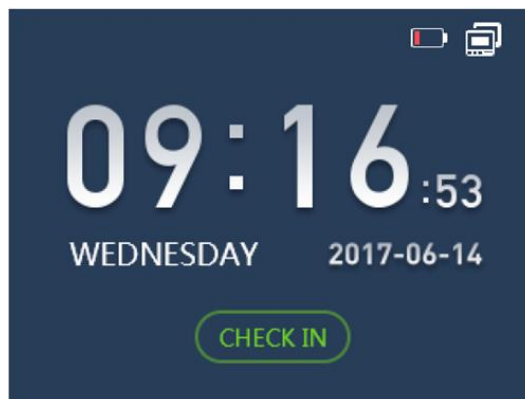
Figure 3-2 Standby interface





-  indicates that the network is disconnected.
-  indicates that the network is connected.
-  indicates the battery level and network connection condition. When you turn the Device on for the first time, the battery level is 25% (can last for about one hour). As time goes by the battery life reduces.

Main menu



Press , and then the main menu will be displayed. See Figure 3-3.

Figure 3-3 Main menu

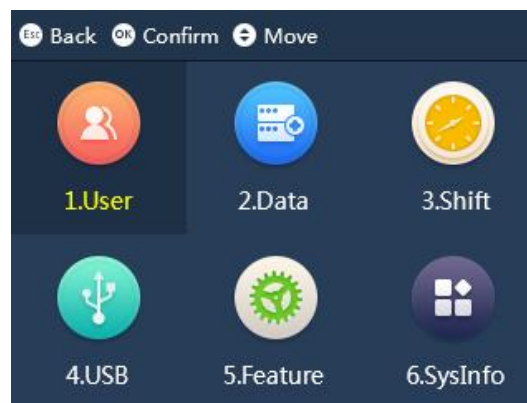

- After you have created administrators, you need to press  first, and then you can go to the main menu by the following methods:
 - ◇ Press your finger tip at the fingerprint sensor;
 - ◇ Enter the administrator's user ID and password;
 - ◇ Swipe your card at the card reader.
- You can select icon by the following two methods:
 - ◇ Press \wedge /F2 or \vee /F3;
 - ◇ Press number keys.

3.3 Attendance Check Methods

On the standby interface, you can get your attendance checked by fingerprint, password, or card.

Fingerprint

- Step 1** Press your finger tip at the fingerprint sensor.
There are six options (Check in, Break out, Break in, Check out, OT-In, and OT-Out) displayed on the screen.

Step 2 Select one of the six according to your requirement.

Step 3 Press **OK/F4**.
The attendance is checked.

Password

Step 1 Press the user ID number on the keyboard.

Step 2 Press **OK/F4**.

Step 3 Enter the password.

Step 4 Press **OK/F4**.

There are six options (Check in, Break out, Break in, Check out, OT-In, and OT-Out) displayed on the screen.

Step 5 Select one of the six according to your requirement.

Step 6 Press **OK/F4**.
The attendance is checked.

Card

Swipe the card at the card reader below the fingerprint sensor to get your attendance checked. Your user ID, name, card swiping time, attendance events will all be displayed on the screen. See Figure 3-4.

Figure 3-4 Swipe card

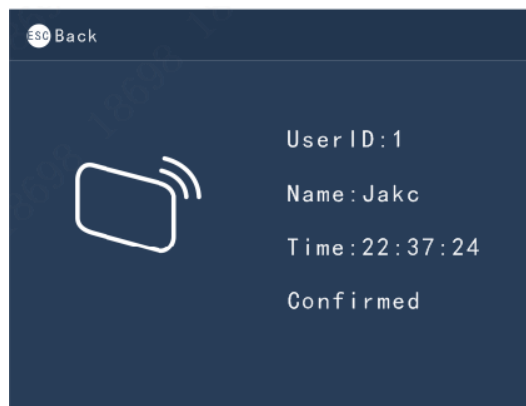

Press **^/F2** or **∨/F3** continuously, **BREAK OUT, CHECK IN, OT-OUT, OT-IN, CHECK OUT, BREAK IN** will be displayed in turn.

There are shortcut keys for check-in, check-out, break-in, and break-out.

- ◇ **Esc/F1**: Press **Esc/F1**, **CHECK IN** will be displayed on the screen, and then you can check-in by fingerprint, password, or card.
- ◇ **^/F2**: Press **^/F2**, **BREAK OUT** will be displayed on the screen, and then you can make an attendance when you need to go out during work time by fingerprint, password, or card.
- ◇ **∨/F3**: Press **∨/F3**, **BREAK IN** will be displayed on the screen, and then you can make an attendance when you return to the company during the work time by fingerprint, password, or card.
- ◇ **OK/F4**: Press **OK/F4**, **CHECK OUT** will be displayed on the screen, and then you can check out by fingerprint, password, or card.

- ◇ **OT-IN:** You can make an attendance record before you need to work overtime.
- ◇ **OT-OUT:** You can make an attendance record after you have worked overtime.

3.4 User

On the main menu, select **1 User**, and then you can add new users, query and edit user, edit department, and add cards in batches.

3.4.1 Add New Users

You can add users one by one or you can add users in batches.

3.4.1.1 Add One by One

Step 1 On the main menu, select **1 User > Add New User**, and then the adding new user interface is displayed. See Figure 3-5 and Figure 3-6.

Figure 3-5 Adding new user (1)

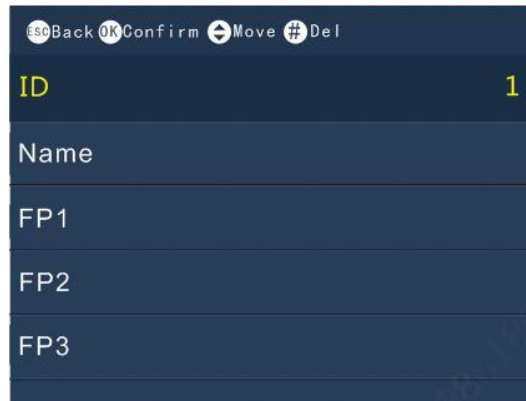
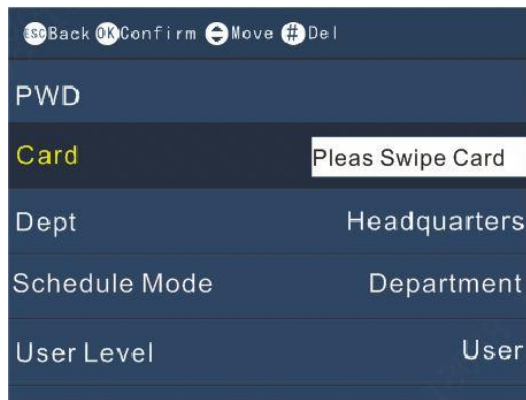

Figure 3-6 Adding new user (2)



- Step 2 Do the following operations:
- 1) Enter user ID and name;
 - 2) Record user's fingerprints;
 - 3) Let users set passwords;
 - 4) Register a card for the new user;
 - 5) Select a department;
 - 6) Select a schedule mode;
 - 7) Select a user level.

A new user is added.



- Maximum user ID length is 8 digits (the user ID length range can be 1–99999999).
- Maximum user name length is 16 letters.
- Passwords can be numbers of 1–8 digits (Zero alone cannot be set as password and cannot be the first number of a password.).
- At most three fingerprints can be recorded for one user.

3.4.1.2 Add in Batches

Add users by swiping cards

Select **1 User > Add Cards in Batch**, swipe cards at the card reader, and then user ID, and card number will be automatically saved. You need to edit user names, add fingerprints and passwords separately. See Figure 3-7.

Figure 3-7 Swipe cards to add users

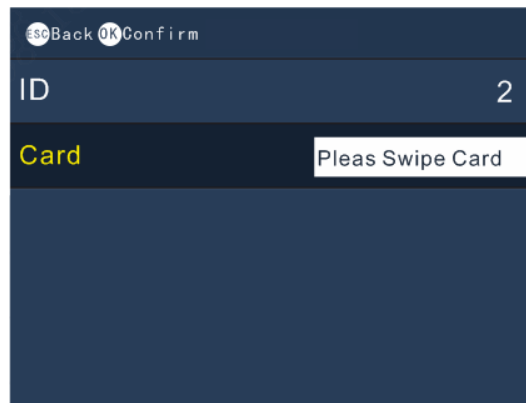

Add users through USB

Excel charts with special format are stored in the USB flash drive. You need to export the excel chart first, and then enter user information (including user ID, user name, password, card number, department, user level and schedule mode) into the charts, and then import the charts to the Device. User information with the same User ID will be overwritten.

Step 1 On the main menu, select **4 USB > Import User Info**.

The prompt **New info will cover the before one** will be displayed.

Step 2 Press **Confirm-OK**.

And then user information will be imported.





3.4.2 Query & Edit User

Step 1 On the main menu, select **1 User > Query & Edit User**.

Step 2 Press **OK/F4**.

See Figure 3-8.

Figure 3-8 Query & edit users

ID	Name	Auth. Method
1	Jakc	   

Step 3 Press \wedge /**F2** or \vee /**F3** to select a user.

Step 4 Press **OK/F4**.

Information of the user you selected will be displayed.

Step 5 Press **OK/4**.

And then you can edit user name, add fingerprints, register a card, modify department and schedule mode, and user level.

3.4.3 Edit Department

Step 1 On the main menu, select **1 User > Edit Dept.**

Step 2 Press **OK/F4**.

Department ID and Department name will be displayed. See Figure 3-9.

Figure 3-9 Edit department

Dept.ID	Dept.
01	HQ
02	PM1
03	PM2
04	
05	

Step 3 Press \wedge /**F2** or \vee /**F3** to select a user.

Step 4 Press **OK/F4**.

And then you can press letter keys to create department names.

Step 5 Press **OK/F4** to save names you entered.



- There are 20 departments in total and departments cannot be deleted.
- Department names cannot be null.

3.4.4 Add Cards in Batch

See "3.4.1.2 Add in Batches".

3.5 Data



Before you export attendance record, make sure the USB is inserted. During exporting, do not remove the USB or operate the Device, otherwise the exporting will fail and system malfunction will occur.

You can query and export attendance record.

3.5.1 Query User ATT. Log

Step 1 On the main menu, select **2 Data > Query User ATT. Log**.
See Figure 3-10.

Figure 3-10 Query user ATT.Log

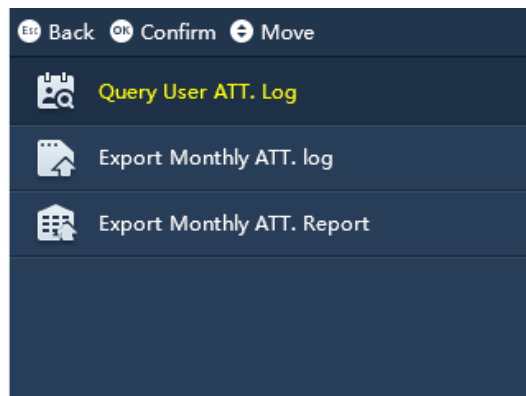

Step 2 Press **OK/F4**.

Step 3 Enter the **User ID** (**Name** will be displayed automatically). See Figure 3-11.

Figure 3-11 Enter user ID

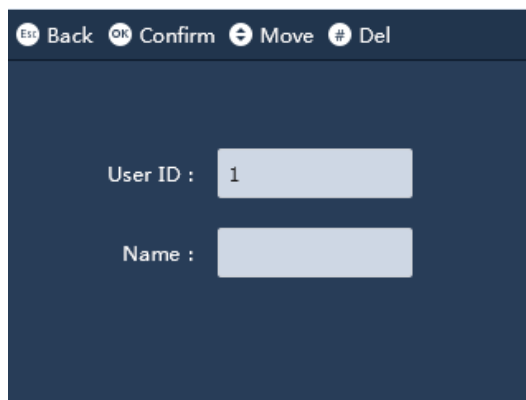

Step 4 Press **OK/F4**.

Attendance record of the user will be displayed. See Figure 3-12.

Figure 3-12 Attendance record

Back Confirm		
UserID : 1	1-1 (1)	
2017/06/06-09:06	FP	Check In

3.5.2 Export Monthly User ATT. Log/Export Monthly ATT. Report

- Step 1 On the main menu, select **2 Data > Export Monthly ATT. Log or Export Monthly ATT. Report.**
- Step 2 Press **OK/F4.**
- Step 3 Select a date.
See Figure 3-13.

Figure 3-13 Export logs/reports

Back Confirm Move EXP			
Export Time	2017	-	06

- Step 4 Press **OK/F4.**
- Step 5 Press **☰|*|⏻**.

The logs and reports will be exported.

3.6 Shift

You can set shift periods. There are 24 shifts in total.

3.6.1 Shift Setting

On the main menu, select **3 Shift > Shift Setting > Shift.** You can set 24 shifts at most. See Figure 3-14.

Figure 3-14 Shift setting

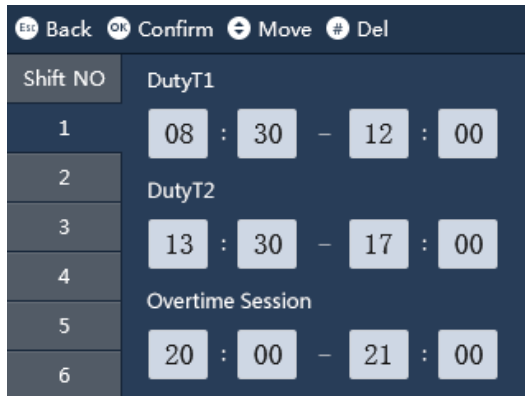

Table 3-1 Shift setting description

Duty	Description
Duty T1	You can set duration for duty time in each shift. For example 08:30–12:00.
Duty T2	You can set duration for duty time in each shift. For example 13:30–17:00.
Overtime Session	You can set overtime duration. For example 20:00–21:00.



- There are two periods in which you may need to sign in and sign out, because there is an interval between Duty T1 and Duty T2.
- If you signed in for more than once, the system takes the earliest sign in records as effective; if you signed out for more than once, the system only takes the latest sign out records as effective.
- In Overtime Session, there is no late/early leave time setup.

Import/Export shift

Once you have done shift settings on a Device, you can export the settings through flash drives and then import them to other Devices, thus you do not need to do settings repeatedly.

3.6.2 Schedule Setup

On the main menu, select **3 Shift > Schedule Setup**, and then you can set schedule in each month (only the current month and the next month) for users and set schedules in each week for departments.

User schedule

- Step 1 On the main menu, select **Shift > Schedule Setup > User Schedule**.
- Step 2 Press **OK/F4**.
- Step 3 Enter the user ID.
User name and department name will be displayed automatically.
- Step 4 Press **OK/F4**.
See Figure 3-15.

Figure 3-15 User schedule

User:1 2017/6 schedules						
Sun	Mon	Tue	Wed	Thu	Fri	Sat
				1 1	2 1	3
4	5 1	6 1	7 1	8 1	9 1	10
11	12 1	13 1	14 1	15 1	16 1	17
18	19 1	20 1	21 1	22 1	23 1	24
25	26 1	27 1	28 1	29 1	30 1	



- Numbers at the center of each box are shift numbers. There are 24 shifts in total.
- Numbers at the top left corner of each box are days.
- Null and 0 means off duty.
- 25 means business trip.
- 26 means leave.

Department Schedule

Step 1 On the main menu, select **Shift > Schedule Setup > Department**.

Step 2 Select a department.

Step 3 Press **OK/F4**.

See Figure 3-16.

Figure 3-16 Department schedule

Dept:Product schedules						
Sun	Mon	Tue	Wed	Thu	Fri	Sat
	1	1	1	1	1	

Import/Export Schedule



Before you export or import schedules, make sure the USB is inserted. During exporting or importing, do not remove the USB or operate the Device, otherwise exporting or importing will fail and system malfunction will occur.

Once you have done schedule settings on a Device, you can export the settings through flash drives and then import them to other Devices, thus you do not need to do settings repeatedly.

3.6.3 Late-in/Early-out Allowed

Late-in Allowed is used to set flexible working hours. For example, the permitted start working time is 8:30, and the late time is 5 minutes, then if a user gets his/her attendance checked before 8:35, he/she is not considered to be late.

Early-out Allowed is used to set flexible working hours, too. For example, the permitted finishing working time is 17:30, and the early leave time is 5 minutes, then if a user gets his/her attendance checked after 17:25, he/she is not considered to have left early.



- During Duty 1 and Duty 2 period, you have only one chance to get your attendance checked late and one chance to leave early.
- If you arrive late or leave early within the time period permitted, overtime will still be counted.

3.7 USB

Select **4 USB**, and then you can import/export user Information, fingerprints, bell information, and auto switch time. See Figure 3-17.

Figure 3-17 USB

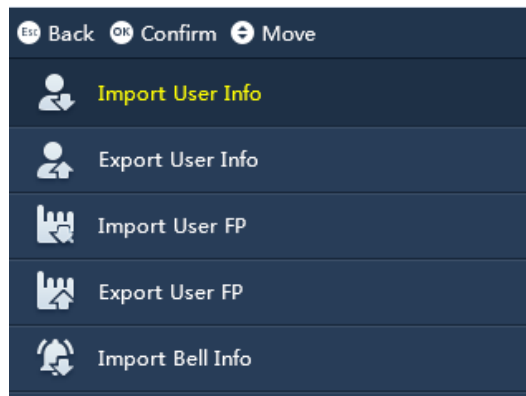

3.7.1 Import/Export User Info

Excel charts with special format are stored in the USB flash drive. You can enter user information (including user ID, user name, password, card number, department, user level and schedule mode) into the charts, and then import/export the charts to/from the Device. User information with the same user ID will be overwritten.

3.7.2 Import/Export User FP

Fingerprints collected can be imported and exported to/from the Device.

3.7.3 Import/Export Bell Info

Bell information can be imported and exported to/from the Device. The bell will ring in the periods you set.

3.7.4 Import/Export Auto Switch Time

Auto switch time can be imported and exported to/from the Device. Check in, Break out, Break in, Check out, OT-In, and OT-Out will be displayed on the screen during the period you set.

3.8 Feature

On the main menu, select **5 Feature**, and then you can do settings and configurations about date and time, network communication, features (state switch time, bell time, recheck interval, verification method, system auto test, attendance event mode, fixed mode setup, and open door keep time).

3.8.1 Date & Time

On the main menu, select **5 Features > Date & Time**, and then you can do settings about date, time, time zone, DST setting, and network time protocol (NTP).

Date Format

There are three options: YY_MM_DD, DD_MM_YY, and MM_DD_YY.



Y stands for year. M stands for month. D stands for day.

Date Setting

Set a date for the Device. The date will be displayed on the screen.

Time Setting

Set time for the Device. The time will be displayed on the screen.

Time Zone

Set time zone for the Device. The time zone range is GMT-12:00 to GMT+13:00.

DST

You can set daylight saving time.

- If you select **By Date**, you can set start/end date and start/end time of the DST.
- If you select **By Week**, you can set start/end time, month and week of the DST.

NTP Setting

You can set IP, port, and update period (min) for the NTP server.

3.8.2 Communication

On the main menu, select **5 Feature > Communication**, and then you can configure IP address, mask, gateway, MAC, and port. See Figure 3-18.

Figure 3-18 Communication



The screenshot shows a configuration menu with the following settings:

Parameter	Value
IP	171.4.200.13
Mask	255.255.0.0
Gateway	171.4.0.1
Mac	36:c4:9f:4b:c3:bb
Port	3777

Table 3-2 Parameter description

Parameter	Description
IP	It is 192.168.1.108 by default.
Mask	It is 255.255.255.0 by default.
Gateway	It is 192.168.1.1 by default.
MAC	MAC address of the Device and it cannot be modified.
Port	Port number, used to login the Device on the SmartPSS.

3.8.3 Features

Select **5 Feature > Features**, and then you can set state switch time, bell time, recheck interval, verification method, system auto test, attendance event mode, fixed mode setup, and open door keep time.

3.8.3.1 State Switch Time

You can set state switch time. There are 24 options and six states: Check in, Break out, Break in, Check out, OT-In, and OT-Out. See Figure 3-19.

Figure 3-19 State switch time

Esc Back OK Confirm ← Move # Del		
NO.	Time	State
1	08:00	Check In
2	17:30	Check Out
3	00:00	NULL
4	00:00	NULL
5	00:00	NULL
6	00:00	NULL

3.8.3.2 Bell Time

You can set bell time, ringing cycle, and ringing duration for the bell. See Figure 3-20.

Figure 3-20 Bell time

Esc Back OK Confirm			
	Time	Cycle	Duration(s)
1	00:00	Every Day	00
2	00:00	Every Day	00
3	00:00	Every Day	00
4	00:00	Every Day	00
5	00:00	Every Day	00

3.8.3.3 Recheck Interval

Recheck interval is used to set the interval in which you can get your attendance checked. For example, if you select 3, then you can get your attendance checked only once in every three minutes. There are ten options: 0, 1, 2, 3, 4, 5, 6, 7, 8, and 9.

3.8.3.4 Verification Method

There are four options: FP or PWD or Card, FP, PWD, and Card.

- If you select **FP or PWD or Card**, your attendance will be checked by fingerprint, password, or card.
- If you select **FP**, your attendance can only be checked by fingerprint.
- If you select **PWD**, your attendance can only be checked by password.
- If you select **Card**, your attendance can only be checked by card.

3.8.3.5 System Auto Test

There are six options: auto test, FP, display, voice, key, and USB.

3.8.3.6 Att.Event Mode

There are three attendance check mode: Auto/Manual. Fixed, and Forced.

Auto/Manual

In **Auto/Manual** mode, there are three methods:

- You can get your attendance checked directly by pressing your finger at the fingerprint sensor, by entering your user ID and password, or by swiping your card;



You need to do shift settings in advance in **3 Shift > Shift Setting > Shift**. See "3.6.1 Shift Setting".

- You can select an attendance event by pressing **Esc/F1**, **^/F2**, **∨/F3**, and **OK/F4**, and then do fingerprint, password, or card attendance check;
- You can get your attendance recorded without doing shift settings and without selecting attendance events.

Fixed

In the Fixed mode, you can select a fixed attendance event for a Device, and then users can sign in at one Device and sign out at another Device.

Step 1 On the standby interface, select **5 Feature > Features > Att. Event Mode**.

Step 2 Press **OK/F4**.

The white text box appears.

Step 3 Press **^/F2** or **∨/F3** to select Fixed.

Step 4 Press **OK/F4**.

Step 5 Press **∨/F3**.

Step 6 Press **OK/F4**.

The white text box appears.

Step 7 Press **^/F2** or **∨/F3** to select among Check in, Break out, Break in, Check out, OT-In, and OT-Out.

Forced

In the Forced mode, you need to select your attendance type (1.Check in; 2.Break out; 3.Break in; 4.Check out; 5.OT-In; 6.OT-Out) after you press your finger tip at the fingerprint sensor, enter your user ID and password, or swiping your card.

Step 1 On the standby interface, select **5 Feature > Features > Att. Event Mode**.

Step 2 Press **OK/F4**.

The white text box appears.

Step 3 Press **^/F2** or **∨/F3** to select Forced.

Step 4 Press **OK/F4**.

Fixed Mode

If you selected **Forced** in **5 Feature > Features > Att.Event Mode**, you can select a fixed attendance event, then users can sign in at one Device and sign out at another Device.

Open Door Keep Time (SEC)

The Device can be connected to access control devices to unlock doors. The time range that the doors will be open is 0–600 seconds.

3.8.4 System

Select **5 Feature > System**, and then you can turn on/off tone switch and broadcast volume switch, adjust volume, restore the Device to the factory settings, restore the Device to the factory settings with user information and logs saved, reboot the Device, do firmware update, set device ID, and set screen sleep time (min). See Figure 3-21 and Figure 3-22.

Figure 3-21 System (1)

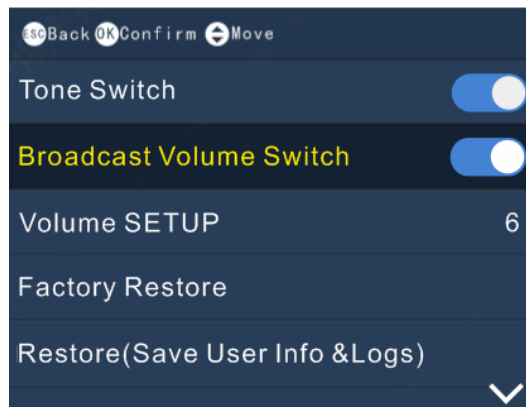
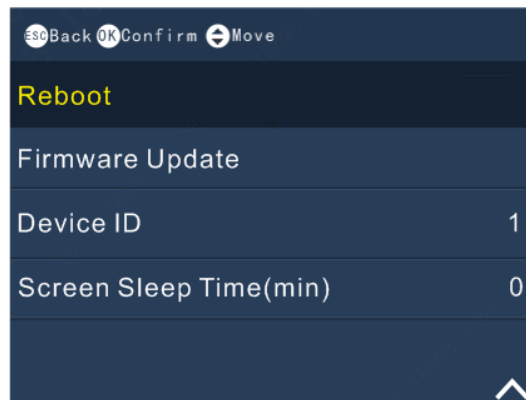

Figure 3-22 System (2)



- Factory Restore: you can restore the Device to the factory settings.
- Restore (Save User Info & Logs): restore the Device to the factory settings with user information and logs saved.
- When doing firmware update, you need to modify the file name to Update.bin.
- The range of screen sleep time is 0–60min.

3.8.5 Language

There is only one language: English.

3.9 System

Select **6 System**, and then you can do admin level management, view registration information and device information.

Admin Level Management

Select **6 SysInfo > Admin Level Management**, the administrator information is displayed. You can modify the administrator level. After you have modified the user level to **user**, the user used to be the administrator will not be displayed in the Admin Level Management.



You can also modify user level by selecting **1 User > Query & Edit User**, and then selecting a user to modify the user level.

Management

Select **6 SysInfo > Management**, and then you can view administrators' operational records (for example user information modification and system setting modification records).

Registration Info

Select **6 SysInfo > Registration Info**, and then you can view registration information (users that can be registered, administrator number, fingerprint number, password number, card number, attendance record report number, and management records the Device can restore). See Figure 3-23.

Figure 3-23 Registration info

esO Back	
User	1/1000
Administrator	0/5
FP	0/2000
PWD	1/1000
Card	1/1000
Att.record report	4/10000

Device Info

Select **6 SysInfo > Registration Info**, and then you can view Device version number and device ID.

4 Attendance Configuration on SmartPSS

You can create departments and add users; set attendance time period, shift, holiday, and attendance event; view real-time attendance information; view and download attendance statistics through the SmartPSS.

4.1 Creating Departments and Adding Users

You need to create departments and add users, and then you can do attendance settings for departments and users.

4.1.1 Creating Departments

Step 1 Click  on the **New** interface.
The **Attendance** interface is displayed.

Step 2 Click  on the Attendance interface.
And the **User** interface is displayed. See Figure 4-1.

Figure 4-1 User



Step 3 Click the right mouse button on the **Default Department** and then click **Add Department**.
The **New Department** interface is displayed. See Figure 4-2.

Figure 4-2 New department

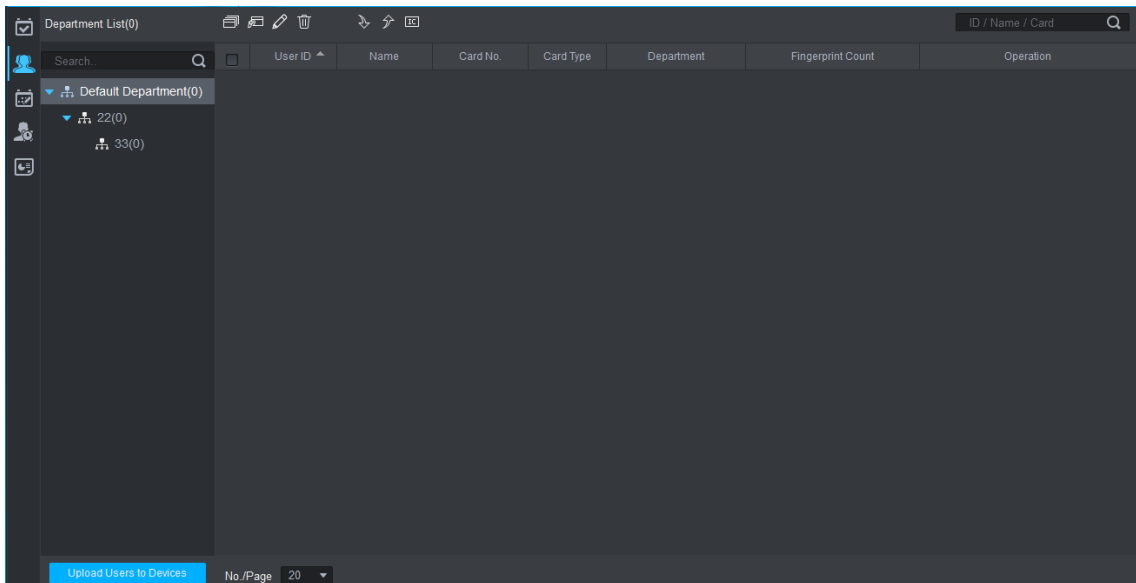
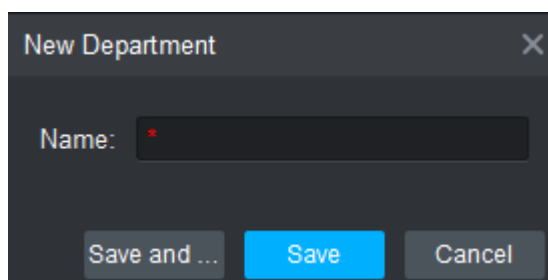

Step 4 Enter department name and click **Save**.

A department is created. See Figure 4-3.

Figure 4-3 A department is created

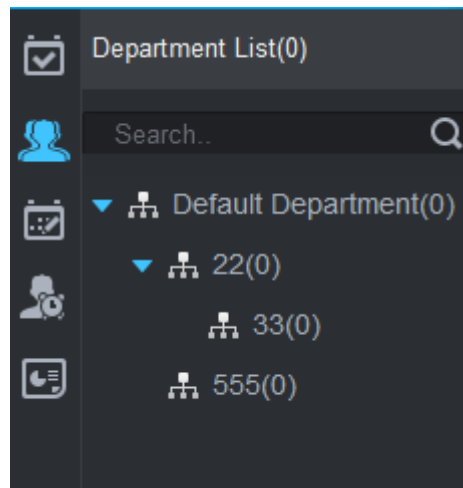

4.1.2 Adding Users

Step 1 Click  on the **Attendance** interface.

The **Add User** interface is displayed. See Figure 4-4.

Figure 4-4 Add user

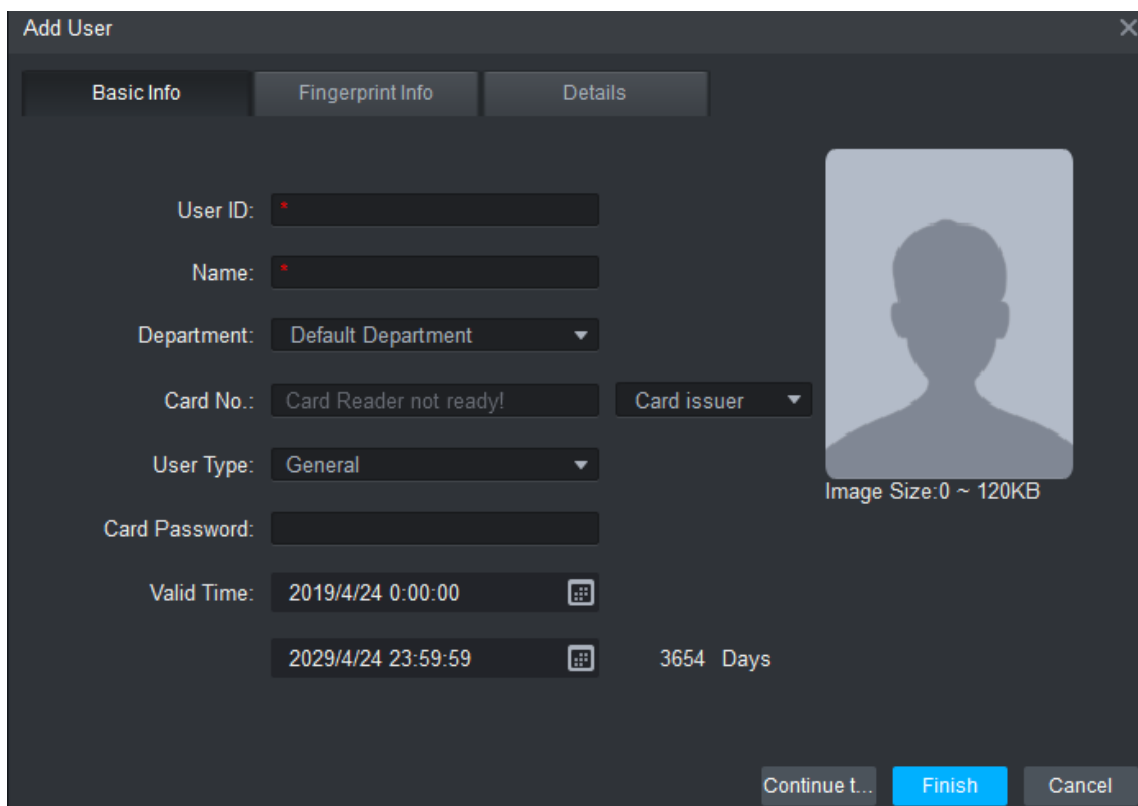
A screenshot of the "Add User" interface. The window has a title bar "Add User" and a close button. It contains three tabs: "Basic Info", "Fingerprint Info", and "Details". The "Basic Info" tab is active. The form includes the following fields:



- User ID: * (required)
- Name: * (required)
- Department: Default Department (dropdown menu)
- Card No.: Card Reader not ready! (text field)
- Card issuer: (dropdown menu)
- User Type: General (dropdown menu)
- Card Password: (password field)
- Valid Time: 2019/4/24 0:00:00 (calendar icon)
- 2029/4/24 23:59:59 (calendar icon)
- 3654 Days (text field)

On the right side, there is a placeholder for a user profile picture with the text "Image Size:0 ~ 120KB". At the bottom right, there are three buttons: "Continue t...", "Finish" (highlighted in blue), and "Cancel".

Step 2 Enter basic information, fingerprint info, and details, and then click **Finish**.

A new user is added.



- You can upload users in the SmartPSS to the Time & Attendance Device by clicking **Upload Users to Devices** on the bottom left corner of the **User** interface.
- You can import and export users by clicking  or .

4.2 Attendance Setting

4.2.1 Attendance Time Zone

By setting attendance time zone, you can configure in which periods users need to get their attendance checked according to company regulations.

Step 1 Click  on the Attendance interface.

Figure 4-5 is displayed.

Figure 4-5 Attendance setting

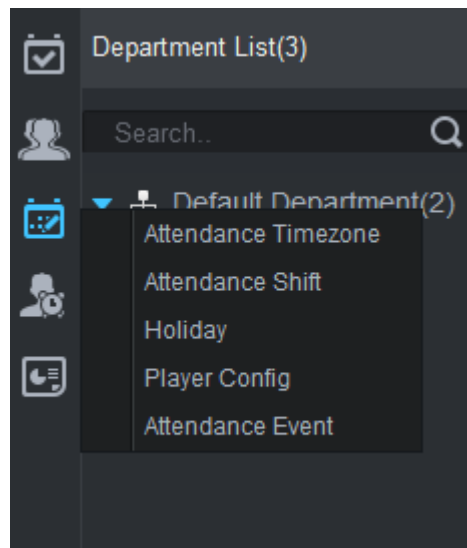

Step 2 Click **Attendance Timezone**.

The attendance timezone interface is displayed. See Figure 4-6.

Figure 4-6 Attendance timezone

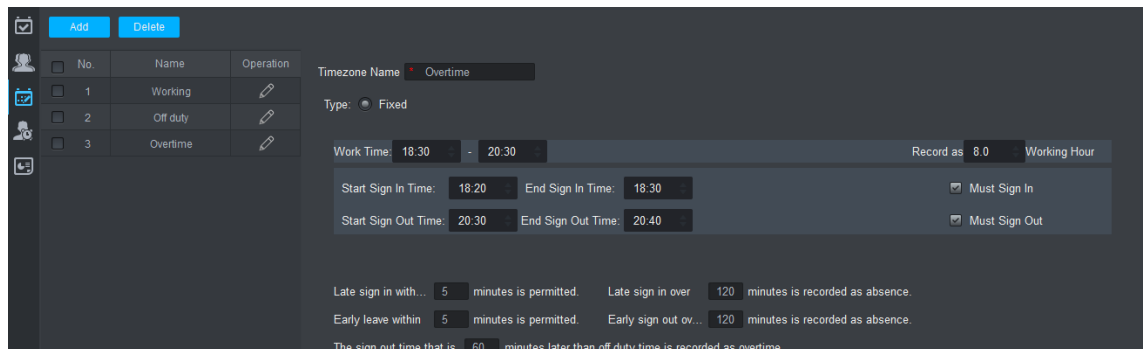

Step 3 Click **Add** on the top left corner of the interface.

The **New Timezone** interface is displayed. See Figure 4-7.

Figure 4-7 New Timezone

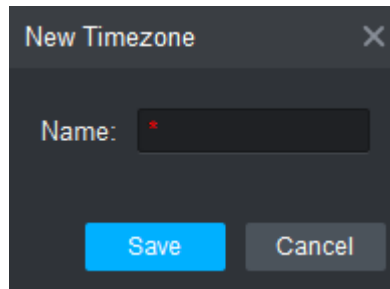

Step 4 Enter timezone name and click **Save**.

Step 5 The timezone setting interface is displayed. See Figure 4-8.

Figure 4-8 Timezone setting

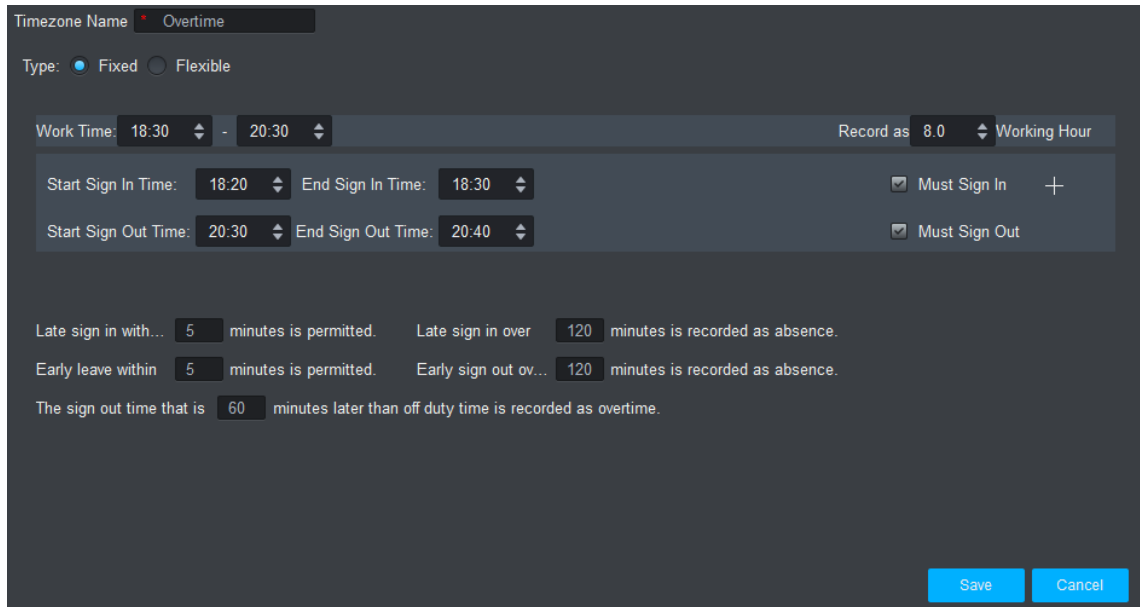



Table 4-1 Timezone setting description

Parameter	Description
Time Zone Name	Customize period name.
Type	<p>Select work attendance type, including fix and free.</p> <ul style="list-style-type: none"> ● Attendance type is set to fix attendance. For more info, please see the rest of this chart. ● Attendance type is free attendance, and you only need to set duration and whether to limit the latest sign in time.
Work Time	Set work time of this period, meantime please select day of week.
Record as X Workday	One week time is recorded as how many weekdays.
Start Sign In Time	<p>Sign in only within set period on attendance device.</p> <p>Sign out only within set period on attendance device.</p> <ul style="list-style-type: none"> ● If this period of attendance time zone has two separate sub periods, then you shall click  to set second work time sign in/out time. ● If you set two work time, then both time shall have sign in/out to be valid for normal attendance.
End Sign In Time	
Start Sign Out Time	
End Sign Out Time	

Parameter	Description
Late sign in within X minutes is permitted.	Define late, early leave and absence.
Late sign in over X minutes is recorded as absence.	You can set different time ranges, the followings are example only. Set start time of work time has standard sign in time. Actual time later is than this time, within $5 \text{ min} < X \leq 30 \text{ min}$, will be late.
Early leave within X minutes is permitted.	Set start time of work time has standard sign in time. Actual time later is than this time, $X > 30 \text{ min}$, will be absence.
Early sign out over X minutes is recorded as absence.	Set end time of work time has standard sign out time. Actual sign out is earlier than this time, and $0 \text{ min} < X \leq 5 \text{ min}$, will be early leave. Set end time of work time has standard sign out time. Actual sign out is earlier than this time, and $5 \text{ min} < X \leq 30 \text{ min}$, will be absence.
The sign out time that is X minutes later than off duty time is recorded as overtime.	Set end time of work is standard off duty time. Actual sign out time later than this time, and over set value will be overtime.

Step 6 set timezone settings and click **Save**.
A new timezone is created.

4.2.2 Attendance Shift

Attendance shifts are the status of days, weeks or months. You can set status for each day within a week and a month, or you can set working status for every single day.



- There are four statuses: **Rest**, **Working**, **Off Duty**, and **Overtime**.
- There are three types of attendance shifts: **Week**, **Month**, and **Day**.

See Figure 4-9 to Figure 4-11 for attendance shift types.

Figure 4-9 Attendance shift (Week)

No.	Date	Timezone	Operation
1	Sun	Working	Enable all
2	Mon	Working	Enable all
3	Tue	Working	Enable all
4	Wed	Working	Enable all
5	Thu	Working	Enable all
6	Fri	Working	Enable all
7	Sat	Rest	Enable all

Figure 4-10 Attendance shift (Month)

No.	Date	Timezone	Operation
1	1	Working	Enable all
2	2	Working	Enable all
3	3	Working	Enable all
4	4	Working	Enable all
5	5	Working	Enable all
6	6	Working	Enable all
7	7	Working	Enable all
8	8	Working	Enable all
9	9	Working	Enable all
10	10	Working	Enable all
11	11	Working	Enable all
12	12	Working	Enable all
13	13	Working	Enable all
14	14	Working	Enable all
15	15	Working	Enable all
16	16	Working	Enable all
17	17	Working	Enable all

Figure 4-11 Attendance shift (Day)

No.	Date	Timezone	Operation
1	Day 1	Working	Enable all
2	Day 2	Working	Enable all
3	Day 3	Working	Enable all
4	Day 4	Working	Enable all
5	Day 5	Working	Enable all
6	Day 6	Working	Enable all
7	Day 7	Working	Enable all
8	Day 8	Working	Enable all
9	Day 9	Working	Enable all
10	Day 10	Working	Enable all
11	Day 11	Working	Enable all
12	Day 12	Working	Enable all
13	Day 13	Working	Enable all
14	Day 14	Working	Enable all
15	Day 15	Working	Enable all
16	Day 16	Working	Enable all
17	Day 17	Working	Enable all

Save Cancel

4.2.3 Holiday

When doing attendance shift setting, you need to set holidays so that users do not need to get their attendance checked.

Step 1 Select **Attendance Setting > Holiday**.

The **Holiday** interface is displayed. See Figure 4-12.

Figure 4-12 Holiday (1)

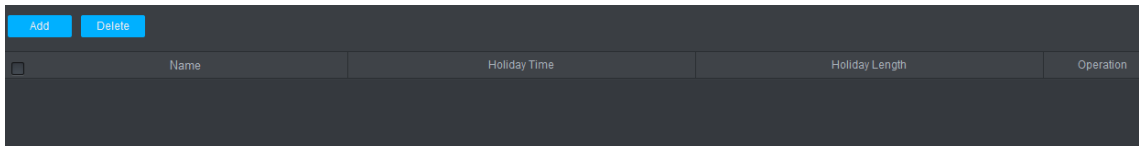

- Step 2** Click **Add** on the top left corner of the interface.
The **Holiday** interface is displayed. See Figure 4-13.

Figure 4-13 Holiday (2)

- Step 3** Enter holiday name, select holiday time, enter holiday length, and then click **OK**.
A holiday is added. See Figure 4-14.

Figure 4-14 A holiday is created

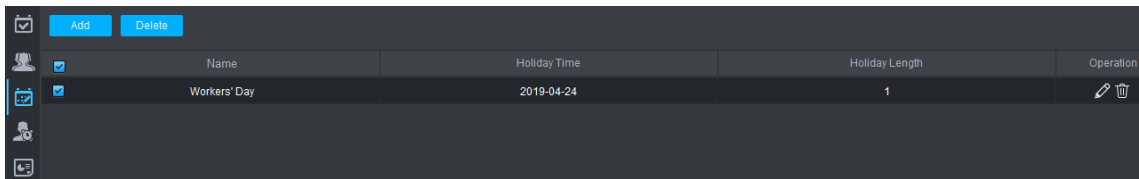

4.2.4 Attendance Event

There are seven default attendance events: Punch the Clock, Sign In, Go Out, Come back, Sign Out, Overtime work sign out, and Overtime work sign in.

- Step 1** Select **Attendance Setting > Attendance Event**.
The **Attendance Event** interface is displayed. See Figure 4-15.

Figure 4-15 Attendance Event

	Encode	Att.Events	Operation
<input type="checkbox"/>	0	Punch The Clock	
	1	Sign In	
	2	Go Out	
	3	Come Back	
	4	Sign Out	
	5	Overtime work sign out	
	6	1	

- Step 2** Click and you can edit attendance event names. See Figure 4-16.

Figure 4-16 Edit attendance event name

Dialog box titled "Edit Name" with the following fields:

- Encode: 6
- Original Name: Overtime work sign in
- Modify Name: 1

Buttons: OK, Cancel

4.3 Shift Schedule

You can set shift schedules and temporary shift for users.

Step 1 Click  on the Attendance interface.

The **Shift Schedule** interface is displayed. See Figure 4-17.

Figure 4-17 Shift schedule

Sun	Mon	Tue	Wed	Thu	Fri	Sat
31	1	2	3	4	5	6
7	8	9	10	11	12	13
14	15	16	17	18	19	20
21	22	23	24	25	26	27
28	29	30	1	2	3	4
5	6	7	8	9	10	11

Step 2 Select a department from the Default Department drop-down list.

Step 3 Select users. See Figure 4-18.

Figure 4-18 Select department and users

Interface showing the "Default Department" dropdown and a list of users:

User ID	Name
55	55
66	66

Step 4 Click  at the bottom left corner of the interface.

The **Shift Select** interface is displayed. See Figure 4-19

Figure 4-19 Shift select

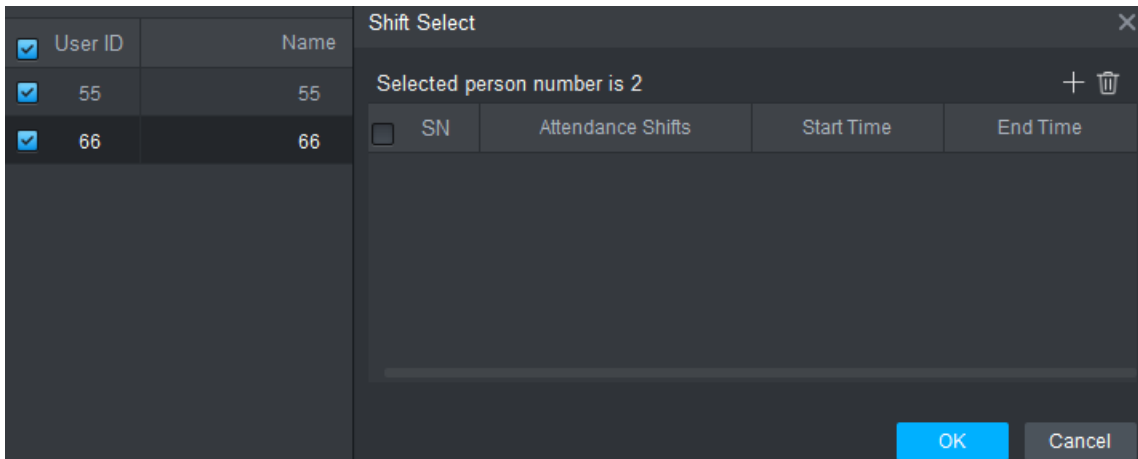

Step 5 Click  at the top right corner of the interface.

And then you can set attendance shift, start time, and end time for the user you have selected.

Figure 4-20 Set attendance shift

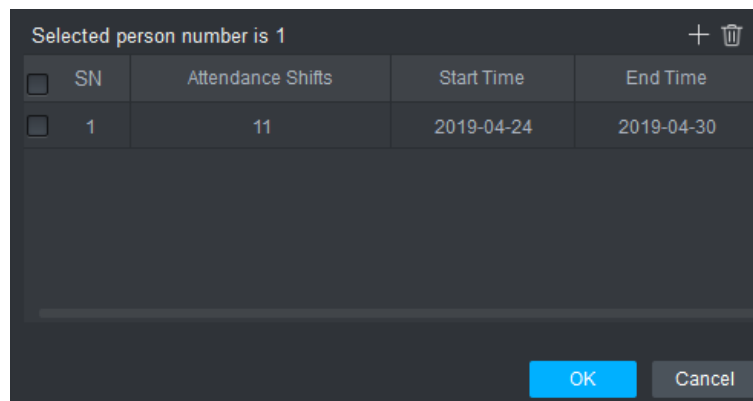

Double-click the attendance shift names, start time, and end time, and then you can select attendance shifts, set start time and end time.



Step 6 Click **OK**.

The attendance shift of the user or users you selected will be displayed on the attendance interface. See Figure 4-21.

Figure 4-21 Attendance shift of the user (s) you selected

2019-04						
Sun	Mon	Tue	Wed	Thu	Fri	Sat
31	1	2	3	4	5	6
7	8	9	10	11	12	13
14	15	16	17	18	19	20
21	22	23 Take Working Days Off T	24 Overtime T	25 H	26 Working	27 Working
28 Working	29 Working	30 Working	1	2	3	4
5	6	7	8	9	10	11



-  Select users, and then click this icon, then you can set temporary for users.
-  Select users and select a temporary shift (with blue T), and then you can delete a temporary.
-  Means the day is a holiday.

4.4 Viewing Real-Time Attendance Check Detail

When users are checking their attendance, their information will be displayed on the Console interface. See Figure 4-22.

Figure 4-22 View real-time attendance check detail

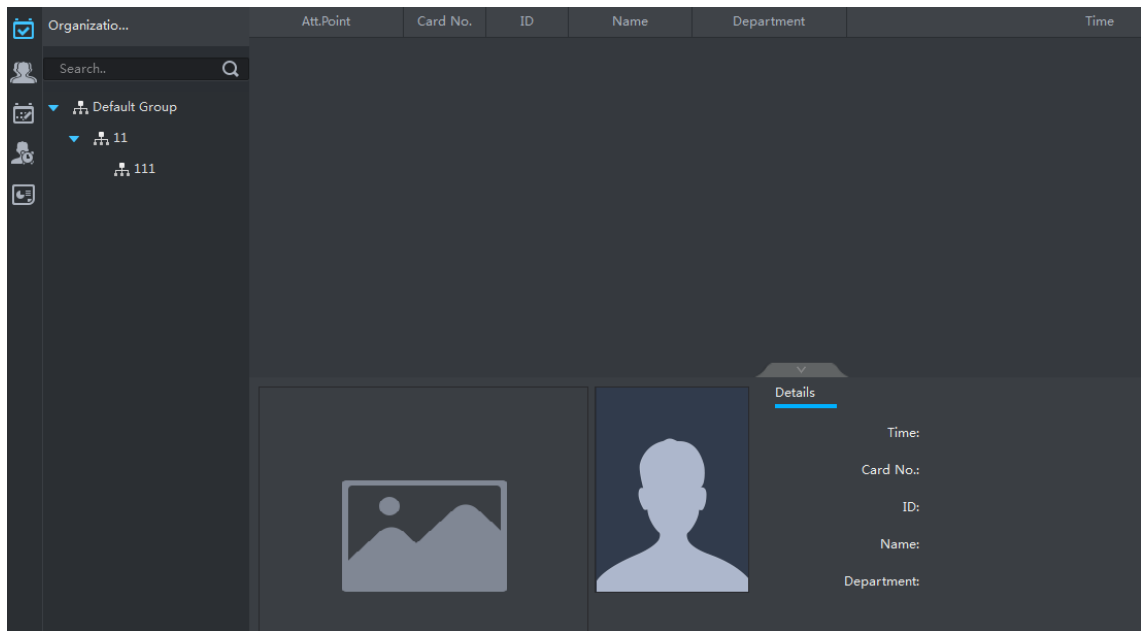

4.5 Attendance Report

You can view the following information on the **Report** interface: attendance statistics, attendance detail, overtime, exception, break, leave, first-in last-out, and logs.

Click . The **Report** interface is displayed. See Figure 4-23.

Figure 4-23 Report



The screenshot shows a web interface for generating an attendance report. At the top, there are filters for 'Time' (2019/03/23-2019/04/23), 'Personnel/Name' (33), and 'Department' (All). There are 'Search' and 'Export' buttons. A 'Deduct out time' checkbox is checked. Below the filters is a navigation bar with tabs for 'Statistics', 'Detail', 'Overtime', 'Exception', 'Break', 'Leave', 'First-In Last-Out', and 'Logs'. A 'Download' button is visible on the right. The main content area displays a table with the following columns: Department, User ID, Name, Exception (Standard (Hour)), Break (Actual (Hour)), Leave (Late In Times/Hour, Early Out Times/Hour), Break (Times/Hour), Leave (Times/Hour), Absent (Times/Hour), Overtime (Times/Hour), and Days Off. The table contains one row with the following data: Department: Default Departm..., User ID: 33, Name: 33, and Overtime: 33.

Department	User ID	Name	Exception Standard (Hour)	Break Actual (Hour)	Leave Late In Times/Hour	Leave Early Out Times/Hour	Break Times/Hour	Leave Times/Hour	Absent Times/Hour	Overtime Times/Hour	Days Off
Default Departm...	33	33								33	

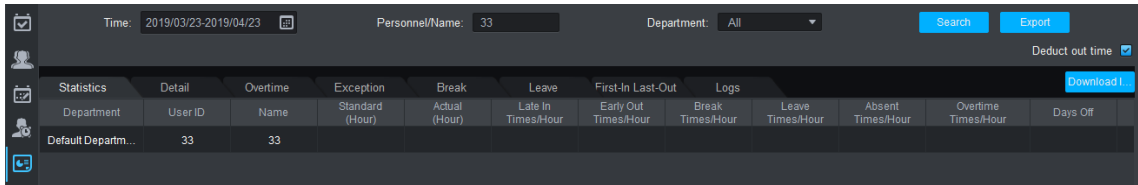
Appendix 1 Fingerprint Record Description

Notice

- Make sure that your fingers are clean and dry before recording your fingerprints.
- Press you finger to the fingerprint recording area, and make your fingerprint is centered on the recording area.

Fingers recommended

Forefingers, middle fingers, and ring fingers are recommended. Thumbs and little fingers cannot be put at the recording center easily.

Appendix Figure 1-1 Recommended fingers

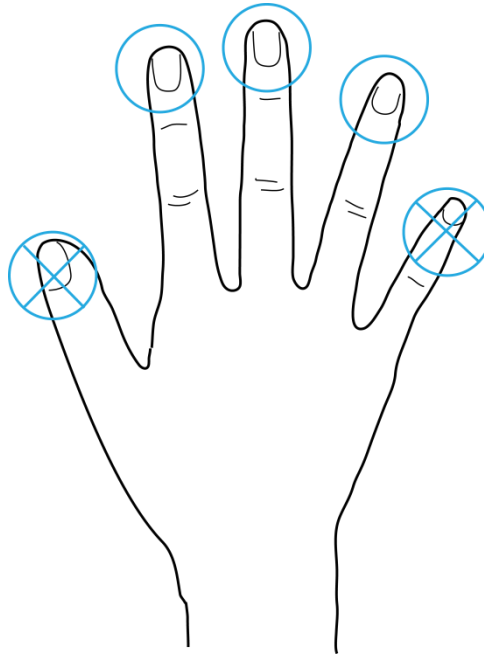

Finger pressing method

- Correct method

Appendix Figure 1-2 Correct finger pressing

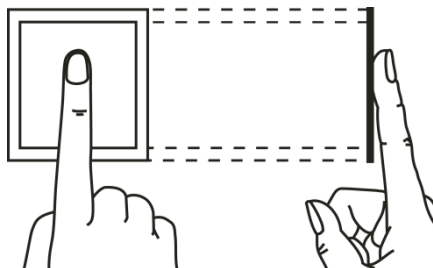

- Incorrect method

Appendix Figure 1-3 Wrong finger pressing

Fingertip perpendicular to the record area

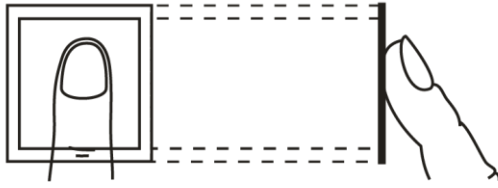

Fingertip not at the center of the record area

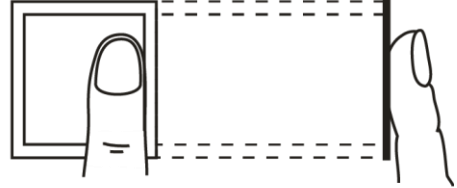

Fingertip not at the center of the record area

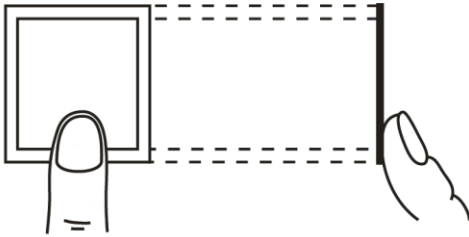

Fingertip inclination

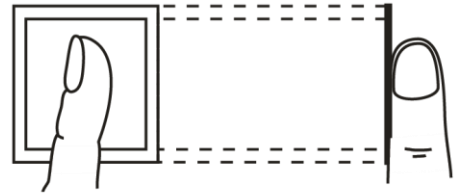

Appendix 2 Text Input

You can type English letters, numbers and punctuation. You need to click  to switch.

Number

Step 1 Press  until **123** is displayed on the screen.

Step 2 Enter numbers.
See Appendix Figure 2-1.

Appendix Figure 2-1



Step 3 Press **OK/F4** to confirm.

Letter

Step 1 Press  until **ABC** is displayed on the screen.

Step 2 Enter letters.
See Appendix Figure 2-1.

Appendix Figure 2-2

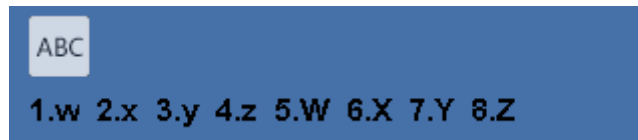

Step 3 Press **OK/F4** to confirm.

Punctuation

Step 1 Press  until **:-)** is displayed on the screen.

Step 2 Press number key.
Punctuations will be displayed on the screen.

Step 3 Press **^/F2** or **∨/F3** to select.

Step 4 Press **OK/F4** to confirm.

Appendix 3 FAQ

- Q: After I have got my fingerprint read by the fingerprint sensor, the system asks me to re-press my finger, and attendance check failed.
A: Check if your fingerprints have been recorded.
- Q: The bell does not work.
A: Check if bell setup is correct and if the broadcast volume switch is on.
- Q: I cannot update the Device by USB flash drive.
A: Check if the Device has recognized the USB flash drive and check update file name.
- Q: Failed to export by USB flash drive.
A: Use USB flash drive in FAT32 format.
- Q: I forget administrator password.
A: Contact the manufacturer.
- Q: I want to search for user attendance record.
A: In the standby interface, press #, and then press your finger at the fingerprint sensor, or enter the user ID and password, or swipe the card.

Establish the 802.1x access authentication system to reduce the risk of unauthorized access to private networks. **OK/F4**, select a month, and then press **OK/F4** to export logs and reports.

Appendix 4 Cybersecurity Recommendations

Mandatory actions to be taken for basic device network security:

1. Use Strong Passwords

Please refer to the following suggestions to set passwords:

- The length should not be less than 8 characters.
- Include at least two types of characters; character types include upper and lower case letters, numbers and symbols.
- Do not contain the account name or the account name in reverse order.
- Do not use continuous characters, such as 123, abc, etc.
- Do not use overlapped characters, such as 111, aaa, etc.

2. Update Firmware and Client Software in Time

- According to the standard procedure in Tech-industry, we recommend to keep your device (such as NVR, DVR, IP camera, etc.) firmware up-to-date to ensure the system is equipped with the latest security patches and fixes. When the device is connected to the public network, it is recommended to enable the "auto-check for updates" function to obtain timely information of firmware updates released by the manufacturer.
- We suggest that you download and use the latest version of client software.

"Nice to have" recommendations to improve your device network security:

1. Physical Protection

We suggest that you perform physical protection to device, especially storage devices. For example, place the device in a special computer room and cabinet, and implement well-done access control permission and key management to prevent unauthorized personnel from carrying out physical contacts such as damaging hardware, unauthorized connection of removable device (such as USB flash disk, serial port), etc.

2. Change Passwords Regularly

We suggest that you change passwords regularly to reduce the risk of being guessed or cracked.

3. Set and Update Passwords Reset Information Timely

The device supports password reset function. Please set up related information for password reset in time, including the end user's mailbox and password protection questions. If the information changes, please modify it in time. When setting password protection questions, it is suggested not to use those that can be easily guessed.

4. Enable Account Lock

The account lock feature is enabled by default, and we recommend you to keep it on to guarantee the account security. If an attacker attempts to log in with the wrong password several times, the corresponding account and the source IP address will be locked.

5. Change Default HTTP and Other Service Ports

We suggest you to change default HTTP and other service ports into any set of numbers between 1024–65535, reducing the risk of outsiders being able to guess which ports you are using.

6. Enable HTTPS

We suggest you to enable HTTPS, so that you visit Web service through a secure communication channel.

7. MAC Address Binding

We recommend you to bind the IP and MAC address of the gateway to the device, thus reducing

the risk of ARP spoofing.

8. Assign Accounts and Privileges Reasonably

According to business and management requirements, reasonably add users and assign a minimum set of permissions to them.

9. Disable Unnecessary Services and Choose Secure Modes

If not needed, it is recommended to turn off some services such as SNMP, SMTP, UPnP, etc., to reduce risks.

If necessary, it is highly recommended that you use safe modes, including but not limited to the following services:

- SNMP: Choose SNMP v3, and set up strong encryption passwords and authentication passwords.
- SMTP: Choose TLS to access mailbox server.
- FTP: Choose SFTP, and set up strong passwords.
- AP hotspot: Choose WPA2-PSK encryption mode, and set up strong passwords.

10. Audio and Video Encrypted Transmission

If your audio and video data contents are very important or sensitive, we recommend that you use encrypted transmission function, to reduce the risk of audio and video data being stolen during transmission.

Reminder: encrypted transmission will cause some loss in transmission efficiency.

11. Secure Auditing

- Check online users: we suggest that you check online users regularly to see if the device is logged in without authorization.
- Check device log: By viewing the logs, you can know the IP addresses that were used to log in to your devices and their key operations.

12. Network Log

Due to the limited storage capacity of the device, the stored log is limited. If you need to save the log for a long time, it is recommended that you enable the network log function to ensure that the critical logs are synchronized to the network log server for tracing.

13. Construct a Safe Network Environment

In order to better ensure the safety of device and reduce potential cyber risks, we recommend:

- Disable the port mapping function of the router to avoid direct access to the intranet devices from external network.
- The network should be partitioned and isolated according to the actual network needs. If there are no communication requirements between two sub networks, it is suggested to use VLAN, network GAP and other technologies to partition the network, so as to achieve the network isolation effect.
- Establish the 802.1x access authentication system to reduce the risk of unauthorized access to private networks.
- Enable IP/MAC address filtering function to limit the range of hosts allowed to access the device.