



**FCC 47 CFR PART 15 SUBPART C**  
**CERTIFICATION TEST REPORT**

*For*

**Thermal Camera**

**MODEL NUMBER: DH-TPC-BF1241**

**ADDITIONAL MODEL NUMBER:**

**DHa-TPC-BFxyzmn-bcdef-gh-i-jk; TPC-BFxyzmn-bcdef-gh-i-jk (a=l or blank;  
x=1~9; y=1~9; z=0~9;m=0~9; n=P, N or blank; b=T or blank; c=A~Z or blank;  
d=1~36 or blank; e=F or blank; f=1~36 or blank; g=A~Z or blank; h=A~Z or blank;  
i=L, R, NRE, WIFI, AC, DC, LED, 4G, HTM or blank; j=S or blank; k=1-99 or blank)**

**PROJECT NUMBER: 4790181283**

**REPORT NUMBER: 4790181283-1**

**FCC ID: SVN-TPC-BFXYZMN**

**ISSUE DATE: Mar. 18, 2022**

*Prepared for*

**Zhejiang Dahua Vision Technology Co., Ltd.**

*Prepared by*

**UL-CCIC COMPANY LIMITED**

**No. 2, Chengwan Road, Suzhou Industrial Park, People's Republic of China**

**Tel: +86 512-6808 6400**

**Fax: +86 512-6808 4099**

**Website: [www.ul.com](http://www.ul.com)**

Form-ULID-008536-9 V1.0

The results reported herein have been performed in accordance with the laboratory's terms of accreditation. This report shall not be reproduced except in full without the written approval of the Laboratory. The results in this report apply to the test sample(s) mentioned above at the time of the testing period only and are not to be used to indicate applicability to other similar products.



Revision History

<u>Rev.</u>	<u>Issue Date</u>	<u>Revisions</u>	<u>Revised By</u>
V0	03/18/2022	Initial Issue	



## TABLE OF CONTENTS

<b>1. ATTESTATION OF TEST RESULTS .....</b>	<b>4</b>
<b>2. TEST METHODOLOGY .....</b>	<b>6</b>
<b>3. FACILITIES AND ACCREDITATION .....</b>	<b>6</b>
<b>4. CALIBRATION AND UNCERTAINTY .....</b>	<b>7</b>
4.1. <i>MEASURING INSTRUMENT CALIBRATION .....</i>	<i>7</i>
4.2. <i>MEASUREMENT UNCERTAINTY.....</i>	<i>7</i>
<b>5. EQUIPMENT UNDER TEST .....</b>	<b>8</b>
5.1. <i>DESCRIPTION OF EUT .....</i>	<i>8</i>
5.2. <i>MAXIMUM OUTPUT POWER.....</i>	<i>9</i>
5.3. <i>CHANNEL LIST .....</i>	<i>9</i>
5.4. <i>TEST CHANNEL CONFIGURATION.....</i>	<i>10</i>
5.5. <i>THE WORSE CASE POWER SETTING PARAMETER.....</i>	<i>10</i>
5.6. <i>DESCRIPTION OF AVAILABLE ANTENNAS .....</i>	<i>11</i>
5.7. <i>THE WORSE CASE CONFIGURATIONS .....</i>	<i>11</i>
5.8. <i>TEST ENVIRONMENT .....</i>	<i>12</i>
5.9. <i>DESCRIPTION OF TEST SETUP.....</i>	<i>12</i>
5.10. <i>MEASURING INSTRUMENT AND SOFTWARE USED .....</i>	<i>14</i>
<b>6. MEASUREMENT METHODS .....</b>	<b>14</b>
<b>7. ANTENNA PORT TEST RESULTS .....</b>	<b>16</b>
7.1. <i>ON TIME AND DUTY CYCLE.....</i>	<i>16</i>
7.2. <i>6 dB BANDWIDTH.....</i>	<i>19</i>
7.3. <i>CONDUCTED OUTPUT POWER.....</i>	<i>27</i>
7.4. <i>POWER SPECTRAL DENSITY.....</i>	<i>29</i>
7.5. <i>CONDUCTED BANDEDGE AND SPURIOUS EMISSIONS.....</i>	<i>37</i>
7.6. <i>RADIATED TEST RESULTS .....</i>	<i>68</i>
7.6.1. <i>LIMITS AND PROCEDURE .....</i>	<i>68</i>
7.6.2. <i>TEST ENVIRONMENT .....</i>	<i>74</i>
7.6.3. <i>RESTRICTED BANDEDGE .....</i>	<i>74</i>
7.6.4. <i>SPURIOUS EMISSIONS .....</i>	<i>91</i>
<b>8. AC POWER LINE CONDUCTED EMISSIONS .....</b>	<b>147</b>
<b>9. ANTENNA REQUIREMENTS.....</b>	<b>150</b>



# 1. ATTESTATION OF TEST RESULTS

## Applicant Information

Company Name: Zhejiang Dahua Vision Technology Co., Ltd.  
Address: No.1199, Bin'an road, Binjiang District, Hangzhou, P.R. China.

## Manufacturer Information

Company Name: Zhejiang Dahua Vision Technology Co., Ltd.  
Address: No.1199, Bin'an road, Binjiang District, Hangzhou, P.R. China.

## EUT Description

Product Name: Thermal Camera  
Model Name: DH-TPC-BF1241  
Additional No.: DHa-TPC-BFxyzmn-bcdef-gh-i-jk; TPC-BFxyzmn-bcdef-gh-i-jk (a=l or blank; x=1~9; y=1~9;z=0~9; m=0~9; n=P, N or blank; b=T or blank; c=A~Z or blank; d=1~36 or blank; e=F or blank; f=1~36 or blank; g=A~Z or blank; h=A~Z or blank; i=L, R, NRE, WIFI, AC, DC, LED, 4G, HTM or blank; j=S or blank; k=1-99 or blank)  
Model Difference: The difference between models is name of the model.  
Sample Number: 4617825  
Data of Receipt Sample: Jan. 20, 2022  
Test Date: Jan. 20, 2022 ~ Mar. 16, 2022

APPLICABLE STANDARDS	
STANDARD	TEST RESULTS
CFR 47 Part 15 Subpart C	PASS



Summary of Test Results			
Clause	Test Items	FCC Rules	Test Results
1	6db DTS Bandwidth	FCC 15.247 (a) (2)	PASS
2	Conducted Power	FCC 15.247 (b) (3)	PASS
3	Power Spectral Density	FCC 15.247 (e)	PASS
4	Conducted Band edge And Spurious emission	FCC 15.247 (d)	PASS
5	Radiated Band edges and Spurious emission	FCC 15.247 (d) FCC 15.209 FCC 15.205	PASS
6	Conducted Emission Test for AC Power Port	FCC 15.207	PASS
7	Antenna Requirement	FCC 15.203	PASS
Remark: 1) The measurement result for the sample received is <Pass> according to < ANSI C63.10-2013, FCC CFR 47 Part 2, FCC CFR 47 Part 15C> when <Accuracy Method> decision rule is applied. 2) The EUT can be powered by adapter and PoE, both the adapter and PoE were test, the result of the adapter was worse case and recorded in this report.			

Prepared By:

*Kitty Li*

Kitty Li  
Engineer

Reviewed By:

*Leon Wu*

Leon Wu  
Senior Project Engineer

Authorized By:

*Chris Zhong*

Chris Zhong  
Laboratory Leader



## 2. TEST METHODOLOGY

The tests documented in this report were performed in accordance with FCC KDB 558074 D01 15.247 Meas Guidance v05r02, KDB 414788 D01 Radiated Test Site v01r01, ANSI C63.10-2013, FCC CFR 47 Part 2, FCC CFR 47 Part 15.

## 3. FACILITIES AND ACCREDITATION

Accreditation Certificate	<p><b>A2LA (Certificate No.: 4829.01)</b>  <b>UL-CCIC COMPANY LIMITED has been assessed and proved to be in compliance with A2LA.</b></p> <p><b>FCC (FCC Designation No.: CN1247)</b>  <b>UL-CCIC COMPANY LIMITED has been recognized to perform compliance testing on equipment subject to the Commission's Declaration of Conformity (DoC) and Certification rules.</b></p> <p><b>IC (IC Designation No.: 25056; CAB No.: CN0073)</b>  <b>UL-CCIC COMPANY LIMITED has been recognized to perform compliance testing on equipment subject to the Commission's Declaration of Conformity (DoC) and Certification rules.</b></p>
---------------------------	---

Note 1: All tests measurement facilities use to collect the measurement data are located at No. 2, Chengwan Road, Suzhou Industrial Park, Suzhou 215122, People's Republic of China

Note 2: For below 30MHz, lab had performed measurements at test anechoic chamber and comparing to measurements obtained on an open field site. These measurements below 30MHz had been correlated to measurements performed on an OFS.

Note 3: The test anechoic chamber in UL-CCIC COMPANY LIMITED had been calibrated and compared to the open field sites and the test anechoic chamber is shown to be equivalent to or worst case from the open field site.



## 4. CALIBRATION AND UNCERTAINTY

### 4.1. MEASURING INSTRUMENT CALIBRATION

The measuring equipment utilized to perform the tests documented in this report has been calibrated in accordance with the manufacturer's recommendations and is traceable to recognized national standards.

### 4.2. MEASUREMENT UNCERTAINTY

Where relevant, the following measurement uncertainty levels have been estimated for tests performed on the apparatus:

Test Item	Uncertainty
Conduction emission	3.1dB
Radiation Emission test (include Fundamental emission) (9kHz-30MHz)	3.4dB
Radiation Emission test (include Fundamental emission) (30MHz-1GHz)	3.4dB
Radiation Emission test (1GHz to 26.5GHz) (include Fundamental emission)	3.9dB (1GHz-18GHz)
	4.2dB (18GHz-26.5GHz)
Note: This uncertainty represents an expanded uncertainty expressed at approximately the 95% confidence level using a coverage factor of k=2.	



## 5. EQUIPMENT UNDER TEST

### 5.1. DESCRIPTION OF EUT

Product Name:	Thermal Camera
Model No.:	DH-TPC-BF1241
Operating Frequency:	IEEE 802.11B/G/N(HT20): 2412MHz to 2462MHz IEEE 802.11N(HT40): 2422MHz to 2452MHz
Type of Modulation:	IEEE for 802.11B: DSSS (CCK, DQPSK, DBPSK) IEEE for 802.11G: OFDM (64QAM, 16QAM, QPSK, BPSK) IEEE for 802.11N(HT20 and HT40): OFDM (64QAM, 16QAM, QPSK, BPSK)
Channels Step:	Channels with 5MHz step
Sample Type:	Fixed production
Test power grade:	/
Test software of EUT:	Secure CRT (manufacturer declare)
Antenna Type:	Rod Antenna
Antenna Gain:	2.34 dBi
Test Voltage	AC 120V





### 5.2. MAXIMUM OUTPUT POWER

Number of Transmit Chains (NTX)	IEE Std. 802.11	Channel Number	Max AVG Conducted Power (dBm)
1	IEEE 802.11B	1-11[11]	14.41
1	IEEE 802.11G	1-11[11]	13.82
1	IEEE 802.11N HT20	1-11[11]	12.84
1	IEEE 802.11N HT40	3-9[7]	12.42

### 5.3. CHANNEL LIST

Channel List for 802.11B/G/N(20 MHz)							
Channel	Frequency (MHz)	Channel	Frequency (MHz)	Channel	Frequency (MHz)	Channel	Frequency (MHz)
1	2412	4	2427	7	2442	10	2457
2	2417	5	2432	8	2447	11	2462
3	2422	6	2437	9	2452		

Channel List for 802.11N (40 MHz)							
Channel	Frequency (MHz)	Channel	Frequency (MHz)	Channel	Frequency (MHz)	Channel	Frequency (MHz)
3	2422	5	2432	7	2442	9	2452
4	2427	6	2437	8	2447		



#### 5.4. TEST CHANNEL CONFIGURATION

Test Mode	Test Channel (MHz)
IEEE 802.11B	LCH: CH01 2412
	MCH: CH06 2437
	HCH: CH11 2462
IEEE 802.11G	LCH: CH01 2412
	MCH: CH06 2437
	HCH: CH11 2462
IEEE 802.11N HT20	LCH: CH01 2412
	MCH: CH06 2437
	HCH: CH11 2462
IEEE 802.11N HT40	LCH: CH03 2422
	MCH: CH06 2437
	HCH: CH09 2452

#### 5.5. THE WORSE CASE POWER SETTING PARAMETER

The Worse Case Power Setting Parameter under 2400 ~ 2483.5MHz Band							
Test Software		SecureCRT					
Modulation Mode	Transmit Antenna Number	Test Channel					
		NCB: 20MHz			NCB: 40MHz		
		CH 1	CH 6	CH 11	CH 3	CH 6	CH 9
802.11B	1	N/A	N/A	N/A	/		
802.11G	1	46	46	46			
802.11N HT20	1	44	44	44			
802.11N HT40	1	/			44	44	44



### 5.6. DESCRIPTION OF AVAILABLE ANTENNAS

Ant.	Frequency (MHz)	Antenna Type	Antenna Gain (dBi)
1	2400-2483.5	Rod Antenna	2.34

Note: This data is provided by customer and our lab isn't responsible for this data.

Test Mode	Transmit and Receive Mode	Description
IEEE 802.11B	<input checked="" type="checkbox"/> 1TX, 1RX	Antenna1 can be used as transmitting/receiving antenna independently.
IEEE 802.11G	<input checked="" type="checkbox"/> 1TX, 1RX	Antenna1 can be used as transmitting/receiving antenna independently.
IEEE 802.11N HT20	<input checked="" type="checkbox"/> 1TX, 1RX	Antenna1 can be used as transmitting/receiving antenna independently.
IEEE 802.11N HT40	<input checked="" type="checkbox"/> 1TX, 1RX	Antenna1 can be used as transmitting/receiving antenna independently.

### 5.7. THE WORSE CASE CONFIGURATIONS

For WIFI module, the worst-case data rates as provided by the client were:

- 802.11B mode: 1 Mbps
- 802.11G mode: 6 Mbps
- 802.11N HT20 mode: MCS0
- 802.11N HT40 mode: MCS0



## 5.8. DESCRIPTION OF TEST SETUP

### SUPPORT EQUIPMENT

Item	Equipment	Brand Name	Model Name	Description
1	Laptop	ThinkPad	E550c	/
2	Power Adapter	HONOR	ADS-24S-12 1224GPCU	INPUT: 100-240V~50/60Hz max. 0.7A OUTPUT: 12.0V=2.0 A

### I/O PORT

Cable No	Port	Connector Type	Cable Type	Cable Length(m)	Remarks
1	USB	USB to TTL	USB to TTL	100cm Length	/
2	LAN	LAN	Lan Cable	100cm Length	/

### ACCESSORY

Item	Accessory	Brand Name	Model Name	Description
1	Alarm Light	Q-light	S80L	Supply by UL Lab
2	Headset	SENICC	ST2688	Supply by UL Lab
3	Micro SD card	Sandisk	A1	32GB

**TEST SETUP**

The EUT can work in an engineer mode with a software through a table PC.

**SETUP DIAGRAM FOR TESTS**

Power by the adapter:

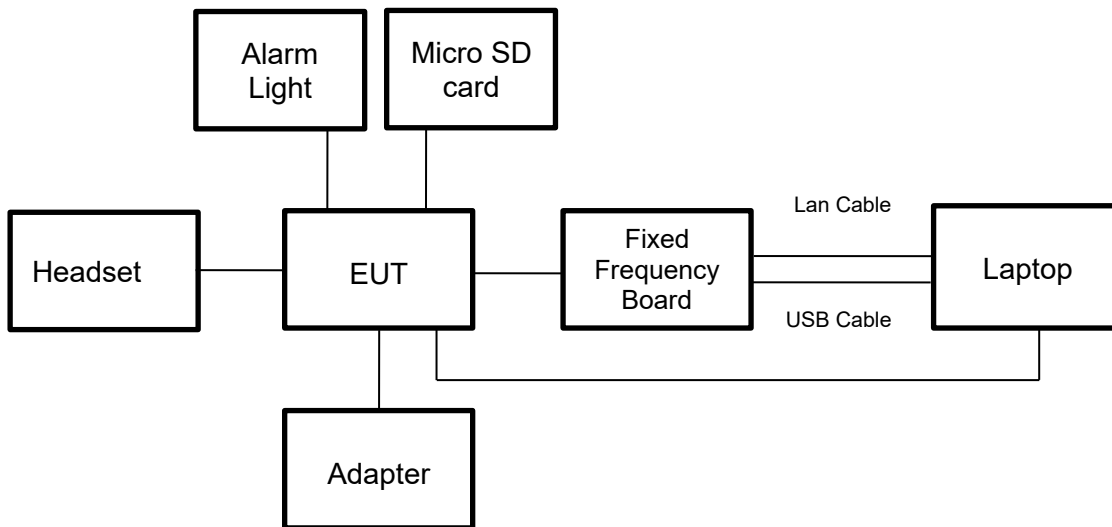

Power by the PoE:

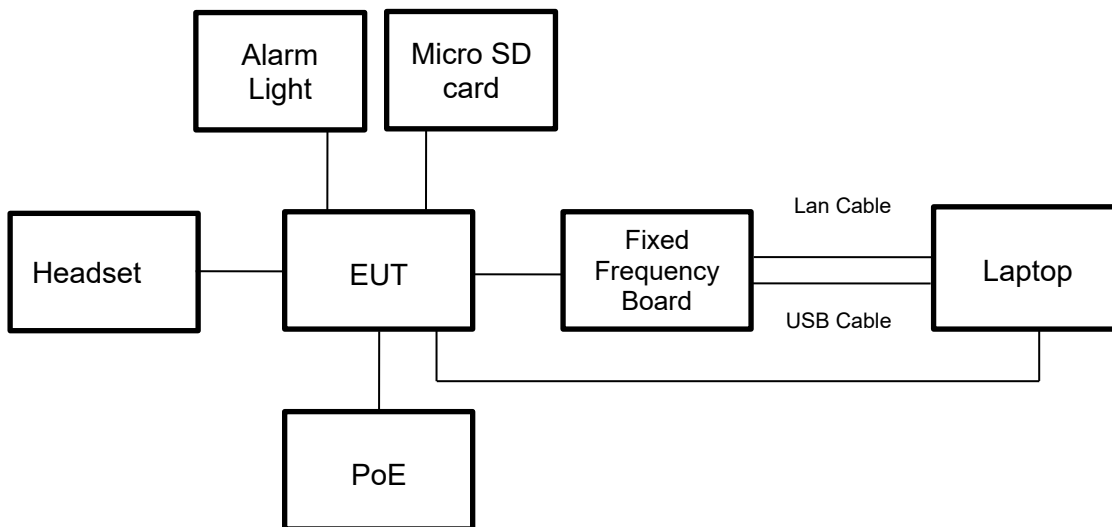



### 5.9. MEASURING INSTRUMENT AND SOFTWARE USED

Conducted Emissions (Instrument)							
Used	Equipment	Manufacturer	Model No.	Serial No.	Upper Last Cal.	Last Cal.	Next Cal.
<input checked="" type="checkbox"/>	EMI Test Receiver	R&S	ESR3	126700	2020-12-05	2021-12-04	2022-12-03
<input checked="" type="checkbox"/>	Two-Line V-Network	R&S	ENV216	126701	2020-12-05	2021-12-04	2022-12-03
<input checked="" type="checkbox"/>	Artificial Mains Networks	R&S	ENY81	126711	2020-10-13	2021-10-12	2022-10-11
Software							
Used	Description	Manufacturer	Name	Version			
<input checked="" type="checkbox"/>	Test Software for Conducted disturbance	R&S	EMC32	Ver. 9.25			
Radiated Emissions (Instrument)							
Used	Equipment	Manufacturer	Model No.	Serial No.	Upper Last Cal.	Last Cal.	Next Cal.
<input checked="" type="checkbox"/>	Spectrum Analyzer	Keysight	N9010B	155727	2020-05-10	2021-05-09	2022-05-08
<input checked="" type="checkbox"/>	EMI test receiver	R&S	ESR26	126703	2020-12-05	2021-12-04	2022-12-03
<input checked="" type="checkbox"/>	Receiver Antenna (9kHz-30MHz)	Schwarzbeck	FMZB 1513	155456	2018-06-15	2021-06-03	2024-06-02
<input checked="" type="checkbox"/>	Receiver Antenna (30MHz-1GHz)	SunAR RF Motion	JB1	177821	N/A	2022-01-18	2025-01-17
<input checked="" type="checkbox"/>	Receiver Antenna (1GHz-18GHz)	R&S	HF907	126705	2019-01-27	2022-02-28	2025-02-27
<input checked="" type="checkbox"/>	Receiver Antenna (18GHz-26.5GHz)	Schwarzbeck	BBHA9170	135391	2020-12-05	2021-12-04	2022-12-03
<input checked="" type="checkbox"/>	Pre-amplification (To 18GHz)	Compliance Direction System Inc.	PAP-1G18-50	177825	2020-02-20	2021-03-26	2022-03-25
<input checked="" type="checkbox"/>	Pre-amplification (To 26.5GHz)	R&S	SCU-26D	135391	2020-12-05	2021-12-04	2022-12-03
<input checked="" type="checkbox"/>	Band Reject Filter	Wainwright	WRCJV8-2350-2400-2483.5-2533.5-40SS	1	2020-05-10	2021-05-09	2022-05-08
<input checked="" type="checkbox"/>	Highpass Filter	Wainwright	WHKX10-2700-3000-18000-40SS	2	2020-05-10	2021-05-09	2022-05-08
Software							
Used	Description	Manufacturer	Name	Version			
<input checked="" type="checkbox"/>	Test Software for Radiated disturbance	Tonscend	TS+	Ver. 2.5			
Other instruments							
Used	Equipment	Manufacturer	Model No.	Serial No.	Upper Last Cal.	Last Cal.	Next Cal.
<input checked="" type="checkbox"/>	Spectrum Analyzer	Keysight	N9010B	155368	2020-05-10	2021-05-09	2022-05-08
<input checked="" type="checkbox"/>	Power Meter	Keysight	U2021XA	155370	2020-05-10	2021-05-09	2022-05-08



## 6. MEASUREMENT METHODS

No.	Test Item	KDB Name	Section
1	6dB Bandwidth	KDB 558074 D01 15.247 Meas Guidance v05r02	8.2
2	Output Power	KDB 558074 D01 15.247 Meas Guidance v05r02	8.3.1.3/8.3.2.3
3	Power Spectral Density	KDB 558074 D01 15.247 Meas Guidance v05r02	8.4
4	Out-of-band emissions in non-restricted bands	KDB 558074 D01 15.247 Meas Guidance v05r02	8.5
5	Out-of-band emissions in restricted bands	KDB 558074 D01 15.247 Meas Guidance v05r02	8.6
6	Band-edge	KDB 558074 D01 15.247 Meas Guidance v05r02	8.7
7	Conducted Emission Test for AC Power Port	ANSI C63.10-2013	6.2



## 7. ANTENNA PORT TEST RESULTS

### 7.1. ON TIME AND DUTY CYCLE

#### LIMITS

None; for reporting purposes only

#### PROCEDURE

FCC KDB 558074 Zero-Span Spectrum Analyzer Method

#### TEST SETUP

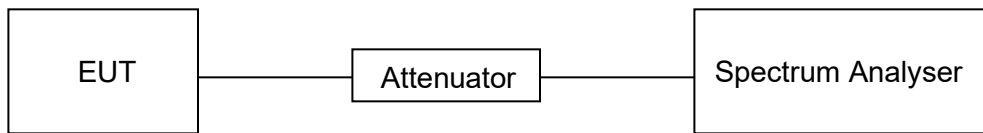

#### TEST ENVIRONMENT

Temperature	19.8°C	Relative Humidity	55.4%
Atmosphere Pressure	103.1kPa	Test Date	2022-02-10

#### TEST RESULTS TABLE

Mode	On Time (msec)	Period (msec)	Duty Cycle x (Linear)	Duty Cycle (%)	Duty Cycle Correction Factor (db)	1/T Minimum VBW (kHz)	Final VBW (kHz)
11B	40	40	1	100%	0	0.01	0.01
11G	100.3	100.3	1	100%	0	0.01	0.01
802.11N HT20	100.3	100.3	1	100%	0	0.01	0.01
802.11N HT40	100.3	100.3	1	100%	0	0.01	0.01

Note: 1) Duty Cycle Correction Factor=10log(1/x).  
 2) Where: x is Duty Cycle (Linear)  
 3) Where: T is On Time (transmit duration)





**TEST GRAPHS**

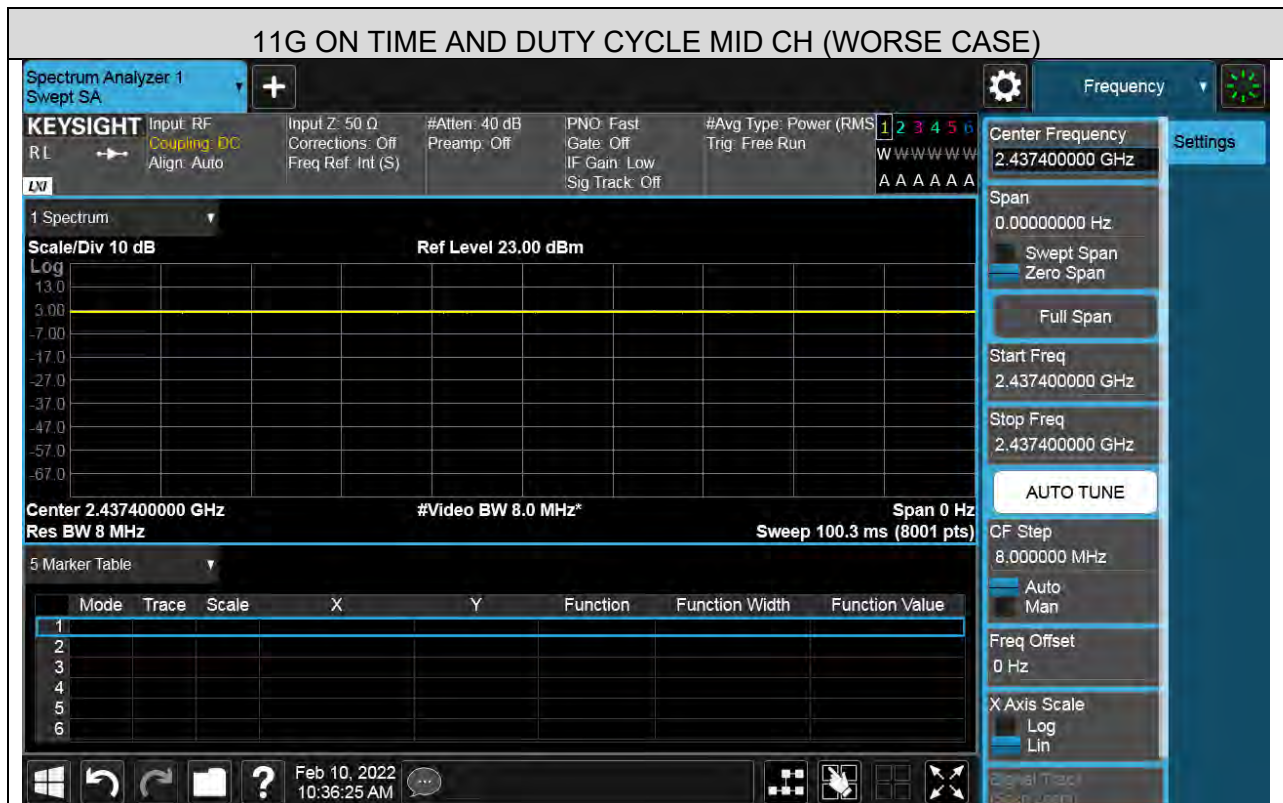
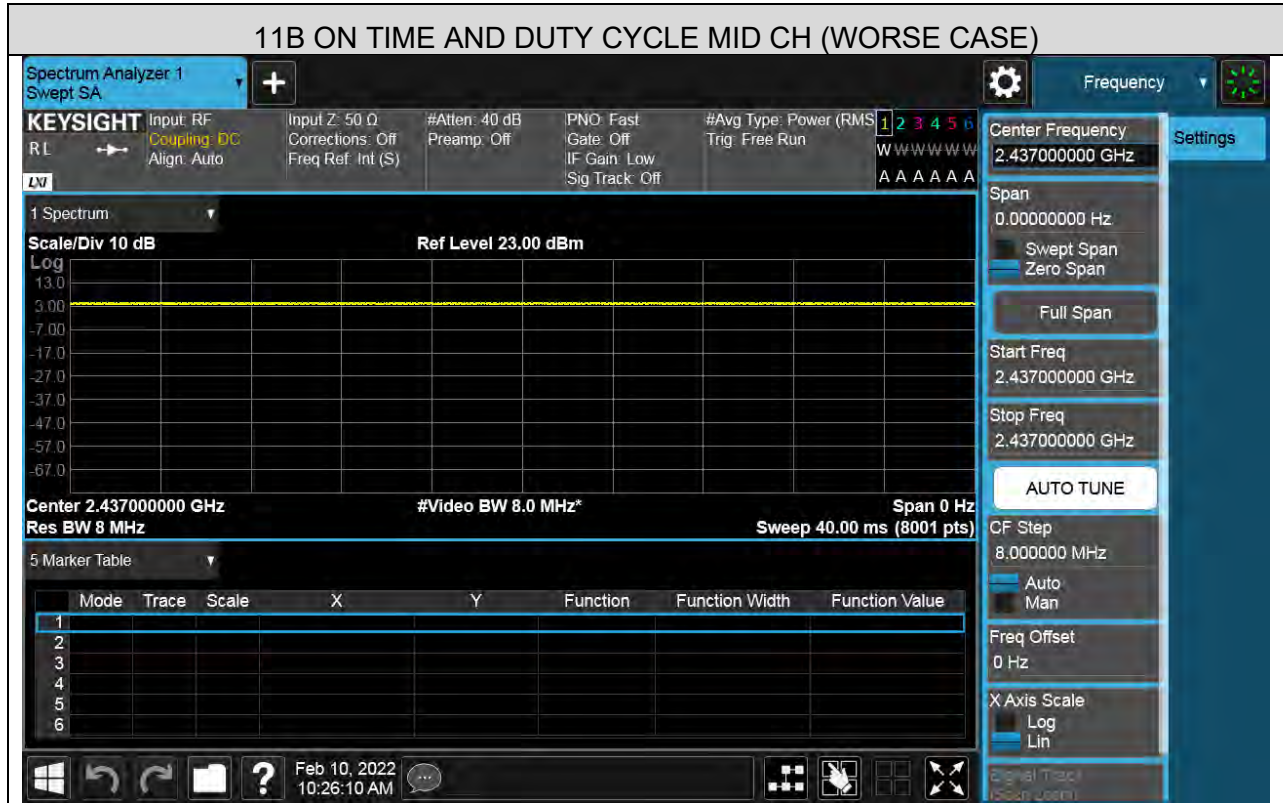

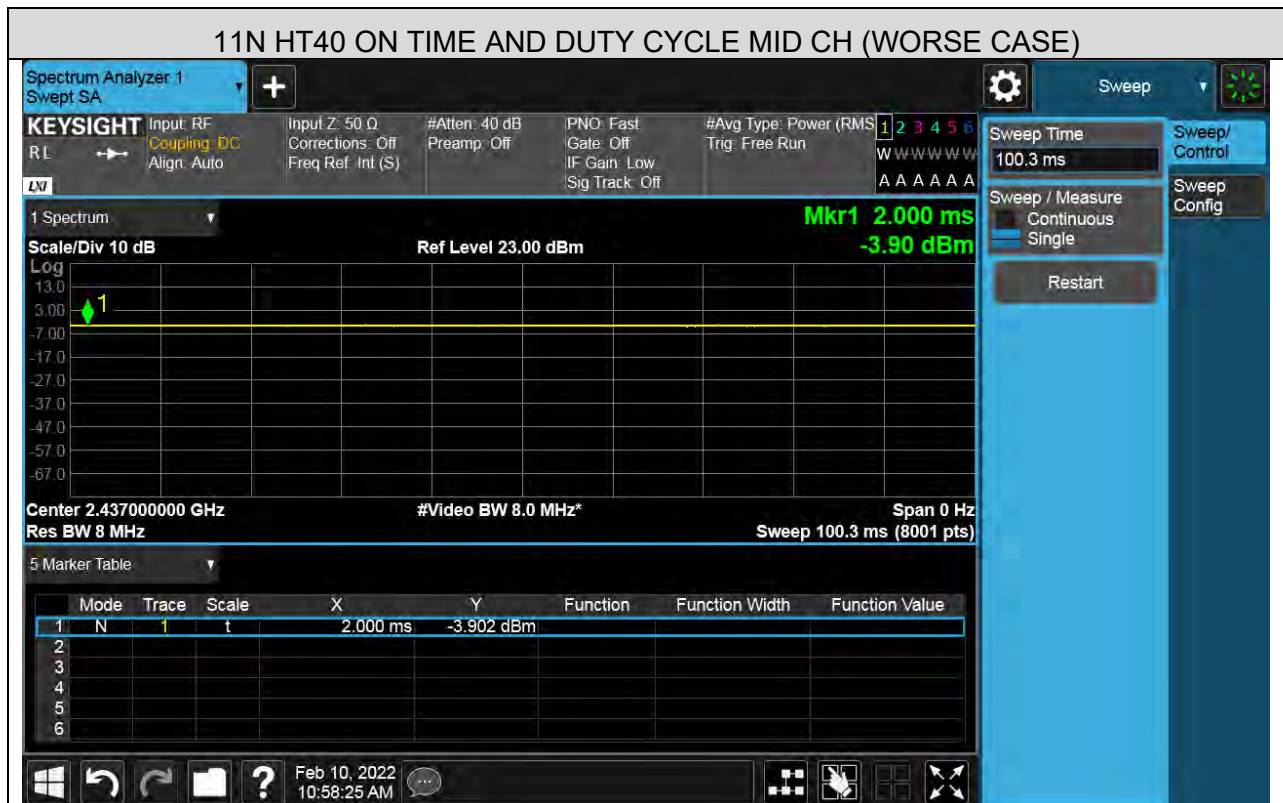
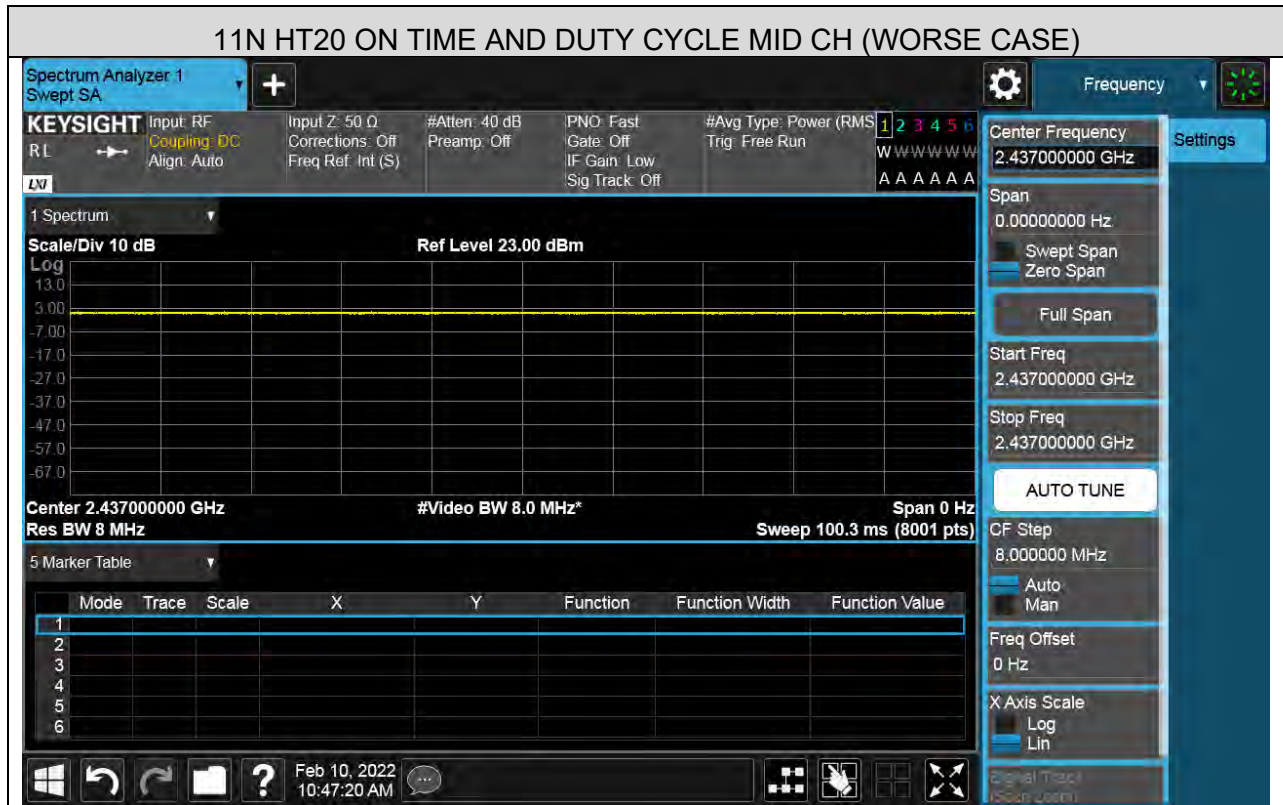

## 7.2. 6 dB BANDWIDTH

### LIMITS

FCC Part15 (15.247), Subpart C			
Section	Test Item	Limit	Frequency Range (MHz)
FCC 15.247(a)(2)	6dB Bandwidth	$\geq 500\text{KHz}$	2400-2483.5

### TEST PROCEDURE

Refer to ANSI C63.10-2013 clause 11.8 for DTS bandwidth.

Connect the EUT to the spectrum analyser and use the following settings:

Center Frequency	The centre frequency of the channel under test
Detector	Peak
RBW	For 6 dB Bandwidth :100K
VBW	For 6dB Bandwidth: $\geq 3 \times \text{RBW}$
Trace	Max hold
Sweep	Auto couple

Allow the trace to stabilize and measure the maximum width of the emission that is constrained by the frequencies associated with the two outermost amplitude points (upper and lower frequencies) that are attenuated by 6 dB relative to the maximum level measured in the fundamental emission.

### TEST SETUP

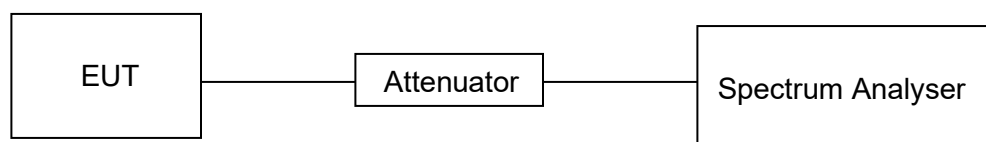



**TEST ENVIRONMENT**

Temperature	19.8°C	Relative Humidity	55.4%
Atmosphere Pressure	103.1kPa	Test Date	2022-02-10

**TEST RESULTS TABLE**

Test Mode	Test Channel	6dB bandwidth (MHz)	Result
11B	LCH	9.072	Pass
	MCH	9.061	Pass
	HCH	9.044	Pass
11G	LCH	16.56	Pass
	MCH	16.55	Pass
	HCH	16.57	Pass
11N HT20	LCH	17.78	Pass
	MCH	17.70	Pass
	HCH	17.72	Pass
11N HT40	LCH	36.48	Pass
	MCH	36.44	Pass
	HCH	36.46	Pass



**TEST GRAPHS**

**6dB Bandwidth**

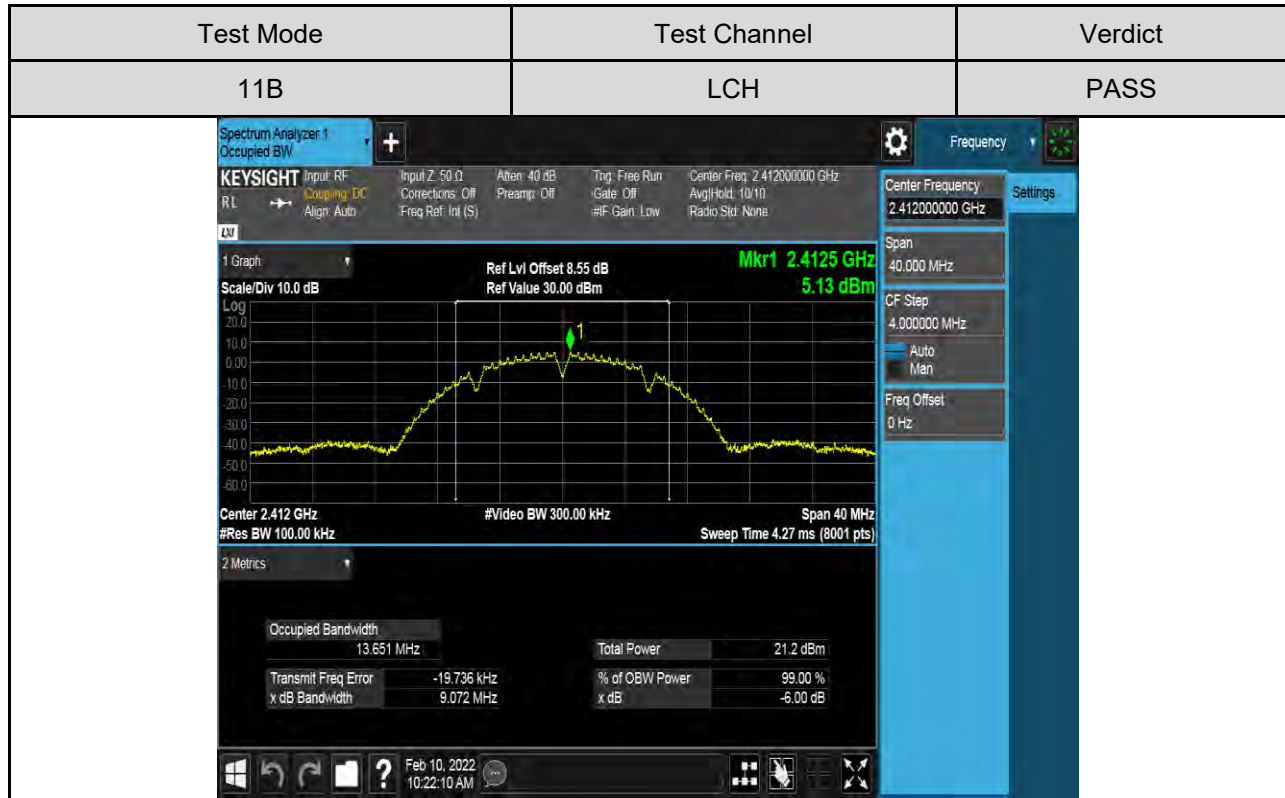



Test Mode	Test Channel	Verdict												
11B	HCH	PASS												
<p><b>Keysight Spectrum Analyzer 1 Occupied BW</b></p> <p>Center Freq: 2.46200000 GHz Span: 40.000 MHz CF Step: 4.000000 MHz Auto/Man Freq Offset: 0 Hz</p> <p>Ref Lvl Offset 8.51 dB Ref Value 30.00 dBm Mkr1 2.4615 GHz 4.08 dBm</p> <p>Center 2.462 GHz #Video BW 300.00 kHz Span 40 MHz #Res BW 100.00 kHz Sweep Time 4.27 ms (8001 pts)</p> <table border="1"> <tr> <td>Occupied Bandwidth</td> <td>13.293 MHz</td> <td>Total Power</td> <td>20.0 dBm</td> </tr> <tr> <td>Transmit Freq Error</td> <td>-88.113 kHz</td> <td>% of OBW Power</td> <td>99.00 %</td> </tr> <tr> <td>x dB Bandwidth</td> <td>9.044 MHz</td> <td>x dB</td> <td>-6.00 dB</td> </tr> </table> <p>Feb 10, 2022 10:28:29 AM</p>			Occupied Bandwidth	13.293 MHz	Total Power	20.0 dBm	Transmit Freq Error	-88.113 kHz	% of OBW Power	99.00 %	x dB Bandwidth	9.044 MHz	x dB	-6.00 dB
Occupied Bandwidth	13.293 MHz	Total Power	20.0 dBm											
Transmit Freq Error	-88.113 kHz	% of OBW Power	99.00 %											
x dB Bandwidth	9.044 MHz	x dB	-6.00 dB											

Test Mode	Test Channel	Verdict												
11G	LCH	PASS												
<p><b>Keysight Spectrum Analyzer 1 Occupied BW</b></p> <p>Center Freq: 2.41200000 GHz Span: 40.000 MHz CF Step: 4.000000 MHz Auto/Man Freq Offset: 0 Hz</p> <p>Ref Lvl Offset 8.55 dB Ref Value 30.00 dBm Mkr1 2.4095 GHz 1.17 dBm</p> <p>Center 2.412 GHz #Video BW 300.00 kHz Span 40 MHz #Res BW 100.00 kHz Sweep Time 4.27 ms (8001 pts)</p> <table border="1"> <tr> <td>Occupied Bandwidth</td> <td>16.477 MHz</td> <td>Total Power</td> <td>21.4 dBm</td> </tr> <tr> <td>Transmit Freq Error</td> <td>-29.503 kHz</td> <td>% of OBW Power</td> <td>99.00 %</td> </tr> <tr> <td>x dB Bandwidth</td> <td>16.56 MHz</td> <td>x dB</td> <td>-6.00 dB</td> </tr> </table> <p>Feb 10, 2022 10:31:30 AM</p>			Occupied Bandwidth	16.477 MHz	Total Power	21.4 dBm	Transmit Freq Error	-29.503 kHz	% of OBW Power	99.00 %	x dB Bandwidth	16.56 MHz	x dB	-6.00 dB
Occupied Bandwidth	16.477 MHz	Total Power	21.4 dBm											
Transmit Freq Error	-29.503 kHz	% of OBW Power	99.00 %											
x dB Bandwidth	16.56 MHz	x dB	-6.00 dB											



Test Mode	Test Channel	Verdict
11G	MCH	PASS
<p><b>Keysight Spectrum Analyzer 1 - Occupied BW</b></p> <p>Center Freq: 2.43700000 GHz Span: 40.000 MHz CF Step: 4.000000 MHz #Res BW: 100.00 kHz #Video BW: 300.00 kHz Sweep Time: 4.27 ms (8001 pts)</p> <p><b>Mkr1 2.4345 GHz -0.13 dBm</b></p> <p>Ref Lvj Offset 8.12 dB Ref Value 30.00 dBm</p> <p>Occupied Bandwidth: 16.459 MHz Total Power: 20.1 dBm Transmit Freq Error: -33.606 kHz % of OBW Power: 99.00 % x dB Bandwidth: 16.55 MHz x dB: -6.00 dB</p> <p>Feb 10, 2022 10:35:17 AM</p>		

Test Mode	Test Channel	Verdict
11G	HCH	PASS
<p><b>Keysight Spectrum Analyzer 1 - Occupied BW</b></p> <p>Center Freq: 2.46200000 GHz Span: 40.000 MHz CF Step: 4.000000 MHz #Res BW: 100.00 kHz #Video BW: 300.00 kHz Sweep Time: 4.27 ms (8001 pts)</p> <p><b>Mkr1 2.4595 GHz -1.31 dBm</b></p> <p>Ref Lvj Offset 8.51 dB Ref Value 30.00 dBm</p> <p>Occupied Bandwidth: 16.467 MHz Total Power: 19.0 dBm Transmit Freq Error: -32.926 kHz % of OBW Power: 99.00 % x dB Bandwidth: 16.57 MHz x dB: -6.00 dB</p> <p>Feb 10, 2022 10:40:14 AM</p>		



Test Mode	Test Channel	Verdict												
11N HT20	LCH	PASS												
<p><b>Keysight Spectrum Analyzer 1 - Occupied BW</b></p> <p>Center Freq: 2.41200000 GHz Span: 40.000 MHz CF Step: 4.000000 MHz #Res BW: 100.00 kHz #Video BW: 300.00 kHz Sweep Time: 4.27 ms (8001 pts)</p> <p><b>Mkr1 2.4066 GHz -0.05 dBm</b></p> <p>Ref Lvl Offset 8.55 dB Ref Value 30.00 dBm</p> <table border="1"> <tr> <td>Occupied Bandwidth</td> <td>17.643 MHz</td> <td>Total Power</td> <td>20.1 dBm</td> </tr> <tr> <td>Transmit Freq Error</td> <td>-11.693 kHz</td> <td>% of OBW Power</td> <td>99.00 %</td> </tr> <tr> <td>x dB Bandwidth</td> <td>17.78 MHz</td> <td>x dB</td> <td>-6.00 dB</td> </tr> </table>			Occupied Bandwidth	17.643 MHz	Total Power	20.1 dBm	Transmit Freq Error	-11.693 kHz	% of OBW Power	99.00 %	x dB Bandwidth	17.78 MHz	x dB	-6.00 dB
Occupied Bandwidth	17.643 MHz	Total Power	20.1 dBm											
Transmit Freq Error	-11.693 kHz	% of OBW Power	99.00 %											
x dB Bandwidth	17.78 MHz	x dB	-6.00 dB											

Test Mode	Test Channel	Verdict												
11N HT20	MCH	PASS												
<p><b>Keysight Spectrum Analyzer 1 - Occupied BW</b></p> <p>Center Freq: 2.43700000 GHz Span: 40.000 MHz CF Step: 4.000000 MHz #Res BW: 100.00 kHz #Video BW: 300.00 kHz Sweep Time: 4.27 ms (8001 pts)</p> <p><b>Mkr1 2.4316 GHz -0.96 dBm</b></p> <p>Ref Lvl Offset 8.12 dB Ref Value 30.00 dBm</p> <table border="1"> <tr> <td>Occupied Bandwidth</td> <td>17.628 MHz</td> <td>Total Power</td> <td>18.9 dBm</td> </tr> <tr> <td>Transmit Freq Error</td> <td>-14.531 kHz</td> <td>% of OBW Power</td> <td>99.00 %</td> </tr> <tr> <td>x dB Bandwidth</td> <td>17.70 MHz</td> <td>x dB</td> <td>-6.00 dB</td> </tr> </table>			Occupied Bandwidth	17.628 MHz	Total Power	18.9 dBm	Transmit Freq Error	-14.531 kHz	% of OBW Power	99.00 %	x dB Bandwidth	17.70 MHz	x dB	-6.00 dB
Occupied Bandwidth	17.628 MHz	Total Power	18.9 dBm											
Transmit Freq Error	-14.531 kHz	% of OBW Power	99.00 %											
x dB Bandwidth	17.70 MHz	x dB	-6.00 dB											





Test Mode	Test Channel	Verdict												
11N HT20	HCH	PASS												
<p><b>Keysight Spectrum Analyzer 1 - Occupied BW</b></p> <p>Center Freq: 2.46200000 GHz, Span: 40.000 MHz, #Res BW: 100.00 kHz, #Video BW: 300.00 kHz, Sweep Time: 4.27 ms (8001 pts)</p> <p><b>Metrics:</b></p> <table border="1"> <tr> <td>Occupied Bandwidth</td> <td>17.640 MHz</td> <td>Total Power</td> <td>17.8 dBm</td> </tr> <tr> <td>Transmit Freq Error</td> <td>-15.236 kHz</td> <td>% of OBW Power</td> <td>99.00 %</td> </tr> <tr> <td>x dB Bandwidth</td> <td>17.72 MHz</td> <td>x dB</td> <td>-6.00 dB</td> </tr> </table>			Occupied Bandwidth	17.640 MHz	Total Power	17.8 dBm	Transmit Freq Error	-15.236 kHz	% of OBW Power	99.00 %	x dB Bandwidth	17.72 MHz	x dB	-6.00 dB
Occupied Bandwidth	17.640 MHz	Total Power	17.8 dBm											
Transmit Freq Error	-15.236 kHz	% of OBW Power	99.00 %											
x dB Bandwidth	17.72 MHz	x dB	-6.00 dB											

Test Mode	Test Channel	Verdict												
11N HT40	LCH	PASS												
<p><b>Keysight Spectrum Analyzer 1 - Occupied BW</b></p> <p>Center Freq: 2.42200000 GHz, Span: 80.000 MHz, #Res BW: 100.00 kHz, #Video BW: 300.00 kHz, Sweep Time: 8.00 ms (8001 pts)</p> <p><b>Metrics:</b></p> <table border="1"> <tr> <td>Occupied Bandwidth</td> <td>36.101 MHz</td> <td>Total Power</td> <td>18.4 dBm</td> </tr> <tr> <td>Transmit Freq Error</td> <td>-38.910 kHz</td> <td>% of OBW Power</td> <td>99.00 %</td> </tr> <tr> <td>x dB Bandwidth</td> <td>36.48 MHz</td> <td>x dB</td> <td>-6.00 dB</td> </tr> </table>			Occupied Bandwidth	36.101 MHz	Total Power	18.4 dBm	Transmit Freq Error	-38.910 kHz	% of OBW Power	99.00 %	x dB Bandwidth	36.48 MHz	x dB	-6.00 dB
Occupied Bandwidth	36.101 MHz	Total Power	18.4 dBm											
Transmit Freq Error	-38.910 kHz	% of OBW Power	99.00 %											
x dB Bandwidth	36.48 MHz	x dB	-6.00 dB											

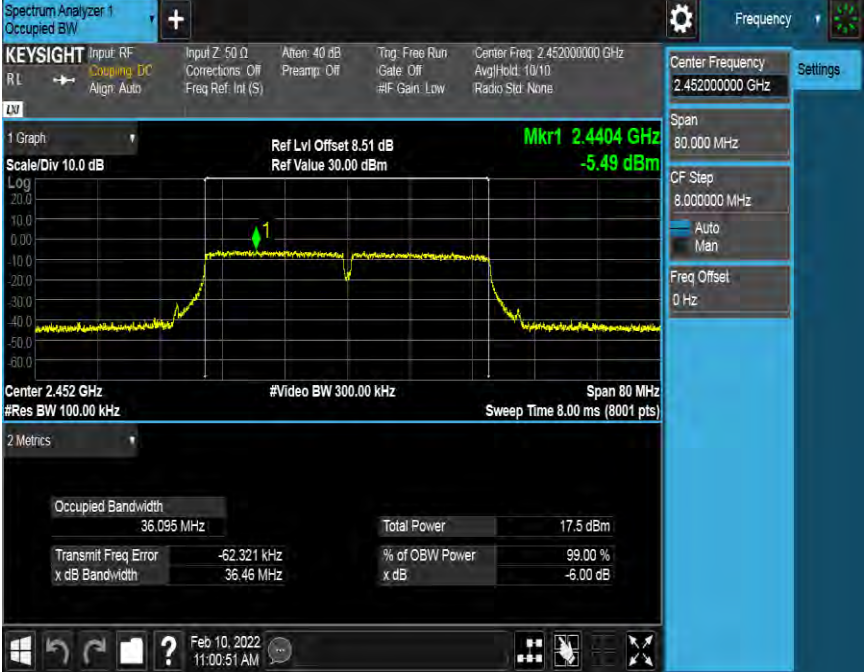

Test Mode	Test Channel	Verdict
11N HT40	MCH	PASS
		

Test Mode	Test Channel	Verdict
11N HT40	HCH	PASS
		



### 7.3. CONDUCTED OUTPUT POWER

#### LIMITS

FCC Part15 (15.247), Subpart C			
Section	Test Item	Limit	Frequency Range (MHz)
FCC 15.247(b)(3)	Output Power	1 watt or 30dBm	2400-2483.5

#### TEST PROCEDURE

Place the EUT on the table and set it in the transmitting mode.  
Remove the antenna from the EUT and then connect a low loss RF cable from the antenna port to the Power sensor.  
Measure the power of each channel.  
AVG Detector used for AVG result.

#### TEST ENVIRONMENT

Temperature	19.8°C	Relative Humidity	55.4%
Atmosphere Pressure	103.1kPa	Test Date	2022-02-10

#### TEST SETUP

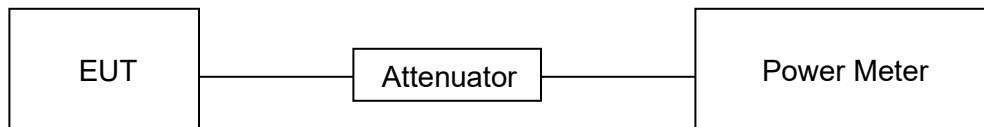



**TEST RESULTS TABLE**

Test Mode	Test Channel	Measurement Output Power (AV)	10log(1/x) Factor	Maximum Average Conducted Output Power (dBm)	LIMIT
		dBm	dBm	dBm	dBm
11B	LCH	14.41	0	14.41	30
	MCH	13.45	0	13.45	30
	HCH	13.26	0	13.26	30
11G	LCH	13.82	0	13.82	30
	MCH	13.68	0	13.68	30
	HCH	12.68	0	12.68	30
11N HT20	LCH	12.84	0	12.84	30
	MCH	12.69	0	12.69	30
	HCH	11.66	0	11.66	30
11N HT40	LCH	12.42	0	12.42	30
	MCH	11.84	0	11.84	30
	HCH	11.50	0	11.50	30

## 7.4. POWER SPECTRAL DENSITY

### LIMITS

FCC Part15 (15.247), Subpart C			
Section	Test Item	Limit	Frequency Range (MHz)
FCC §15.247 (e)	Power Spectral Density	8 dBm/3 kHz	2400-2483.5

### TEST PROCEDURE

Refer to FCC KDB 558074, connect the UUT to the spectrum analyser and use the following settings:

Center Frequency	The centre frequency of the channel under test
Detector	Peak
RBW	$3 \text{ kHz} \leq \text{RBW} \leq 100 \text{ kHz}$
VBW	$\geq 3 \times \text{RBW}$
Span	1.5 x DTS bandwidth
Trace	Max hold
Sweep time	Auto couple.

Allow trace to fully stabilize and use the peak marker function to determine the maximum amplitude level within the RBW.

If measured value exceeds limit, reduce RBW (no less than 3 kHz) and repeat.

### TEST ENVIRONMENT

Temperature	19.8°C	Relative Humidity	55.4%
Atmosphere Pressure	103.1kPa	Test Date	2022-02-10

### TEST SETUP

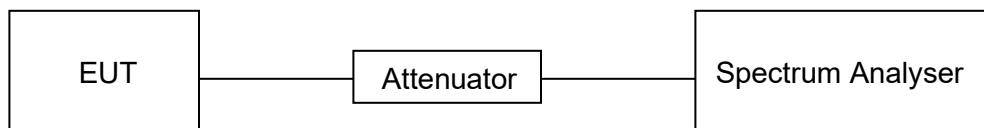



**TEST RESULTS TABLE**

Test Mode	Test Channel	Maximum Peak power spectral density (dBm/30kHz)	Result
11B	LCH	0.03	Pass
	MCH	-0.92	Pass
	HCH	-1.10	Pass
11G	LCH	-3.37	Pass
	MCH	-2.98	Pass
	HCH	-4.25	Pass
11N HT20	LCH	-3.66	Pass
	MCH	-3.74	Pass
	HCH	-4.87	Pass
11N HT40	LCH	-7.71	Pass
	MCH	-8.09	Pass
	HCH	-8.23	Pass



**TEST GRAPHS**



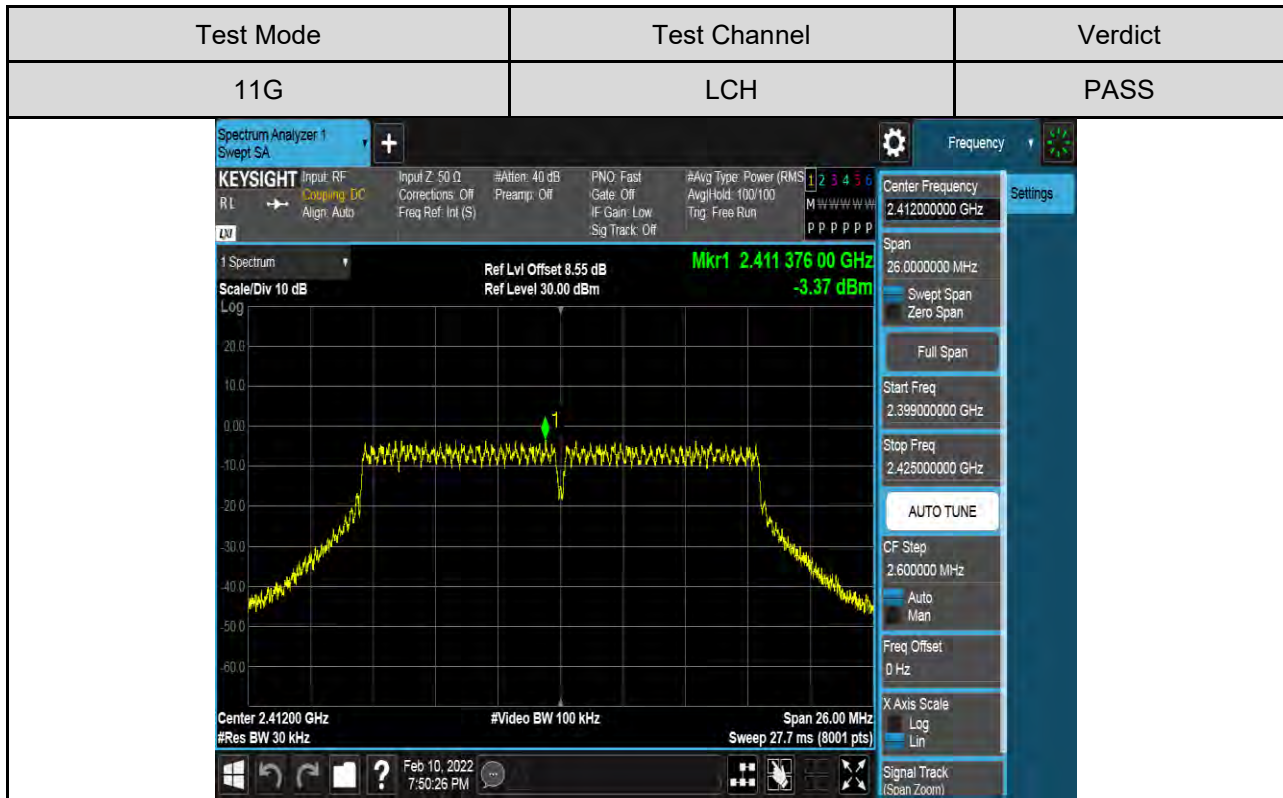



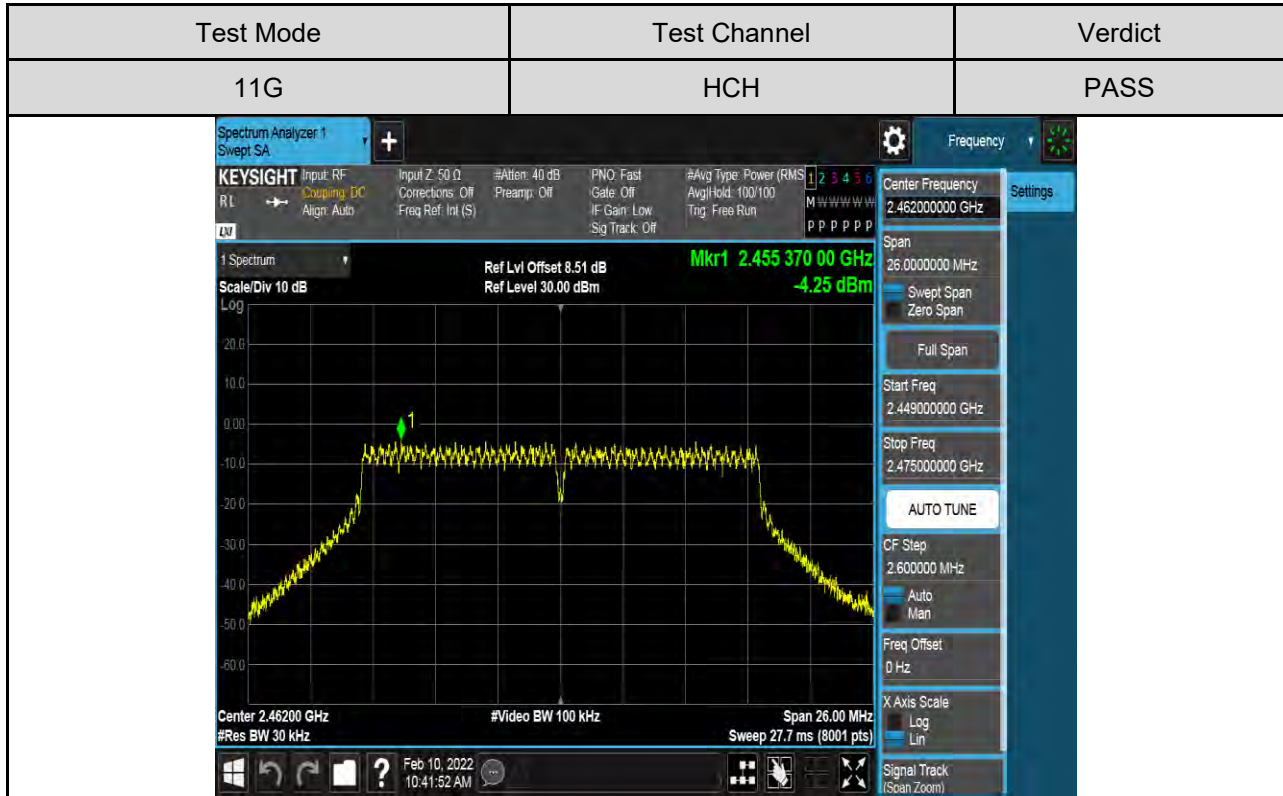
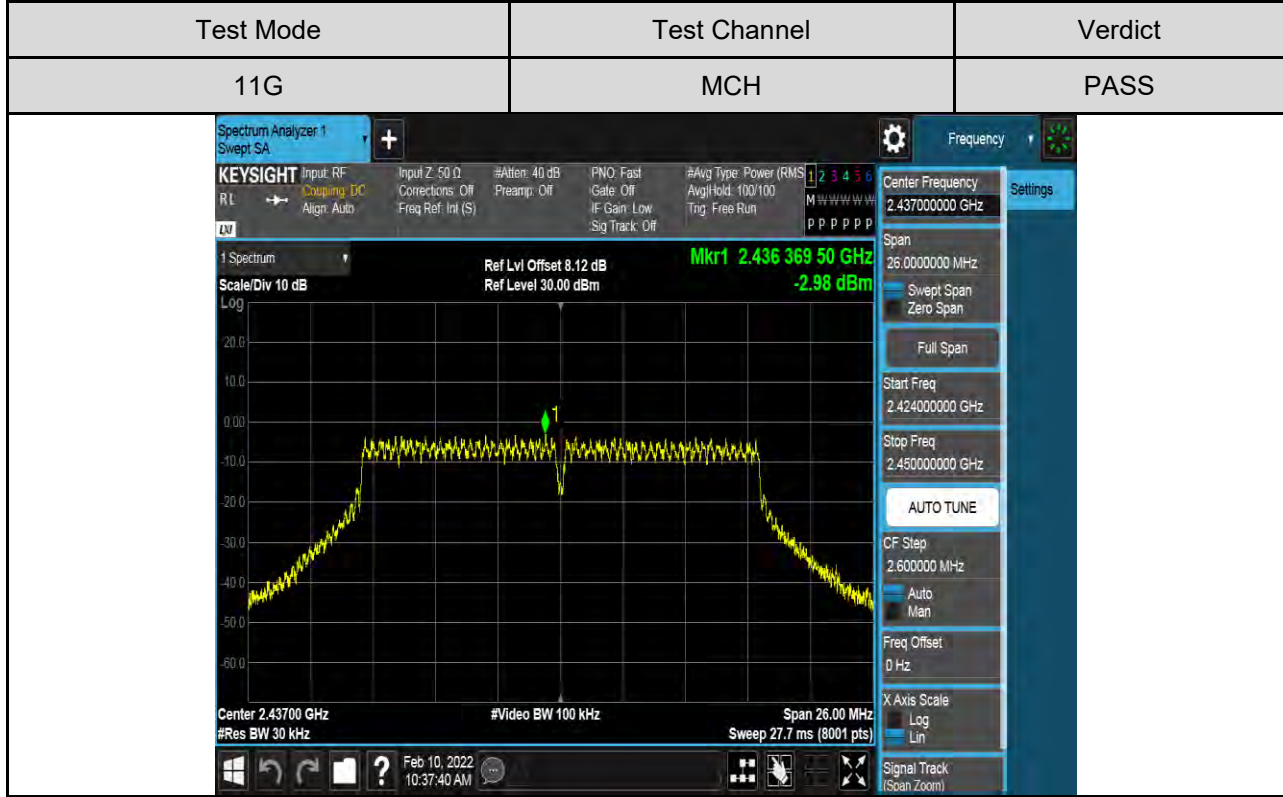

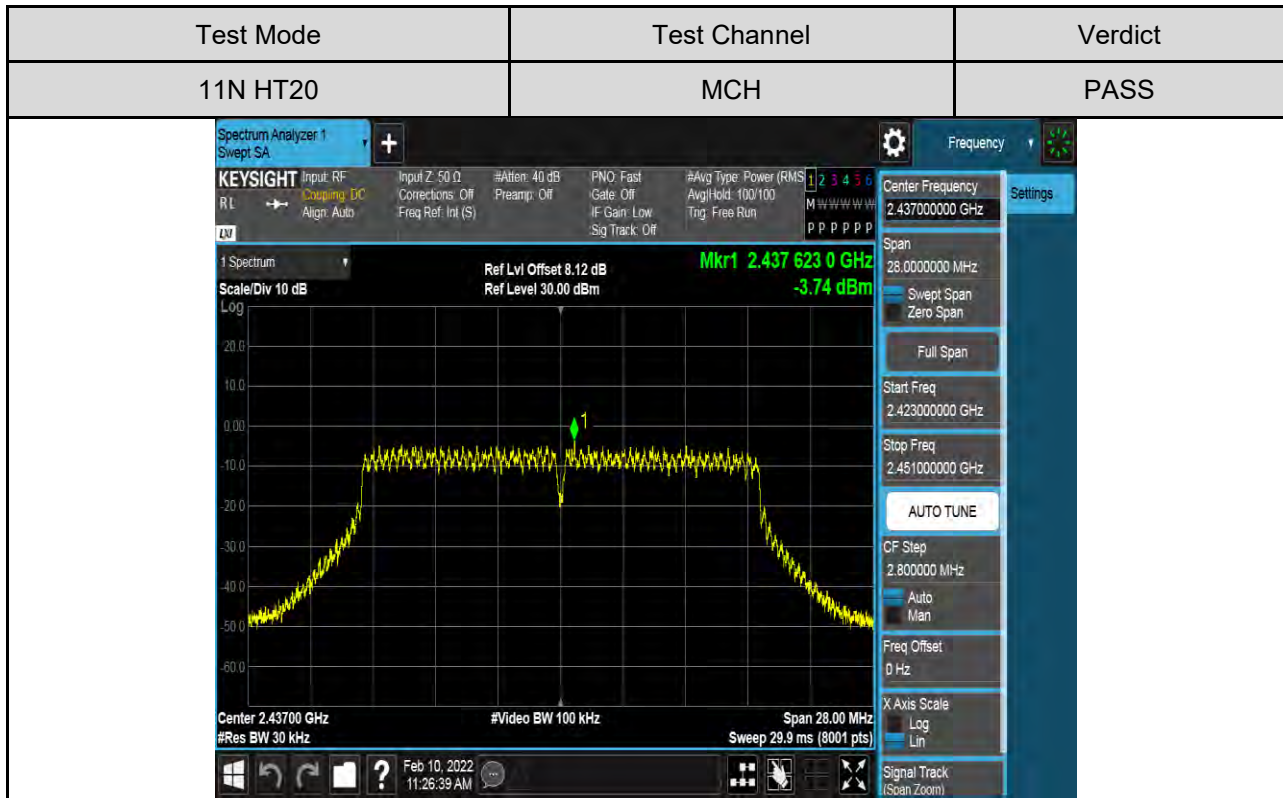
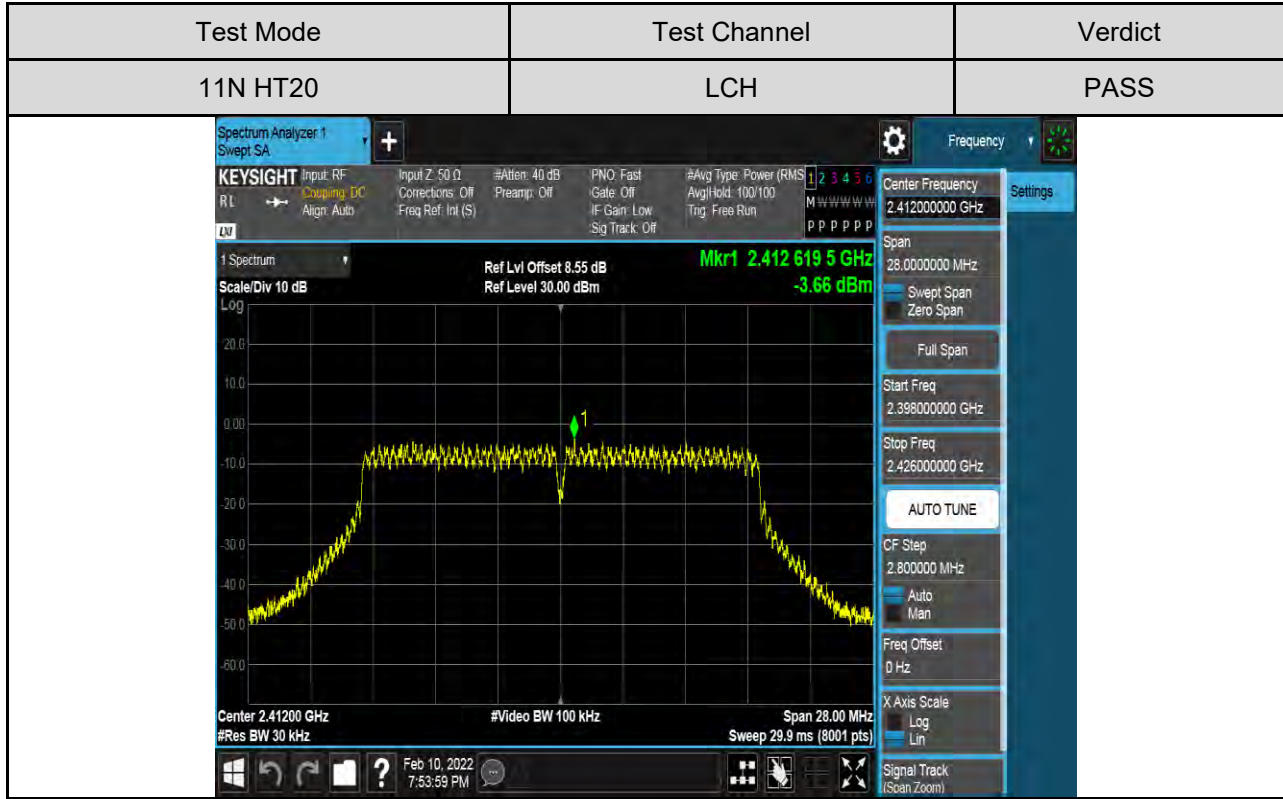

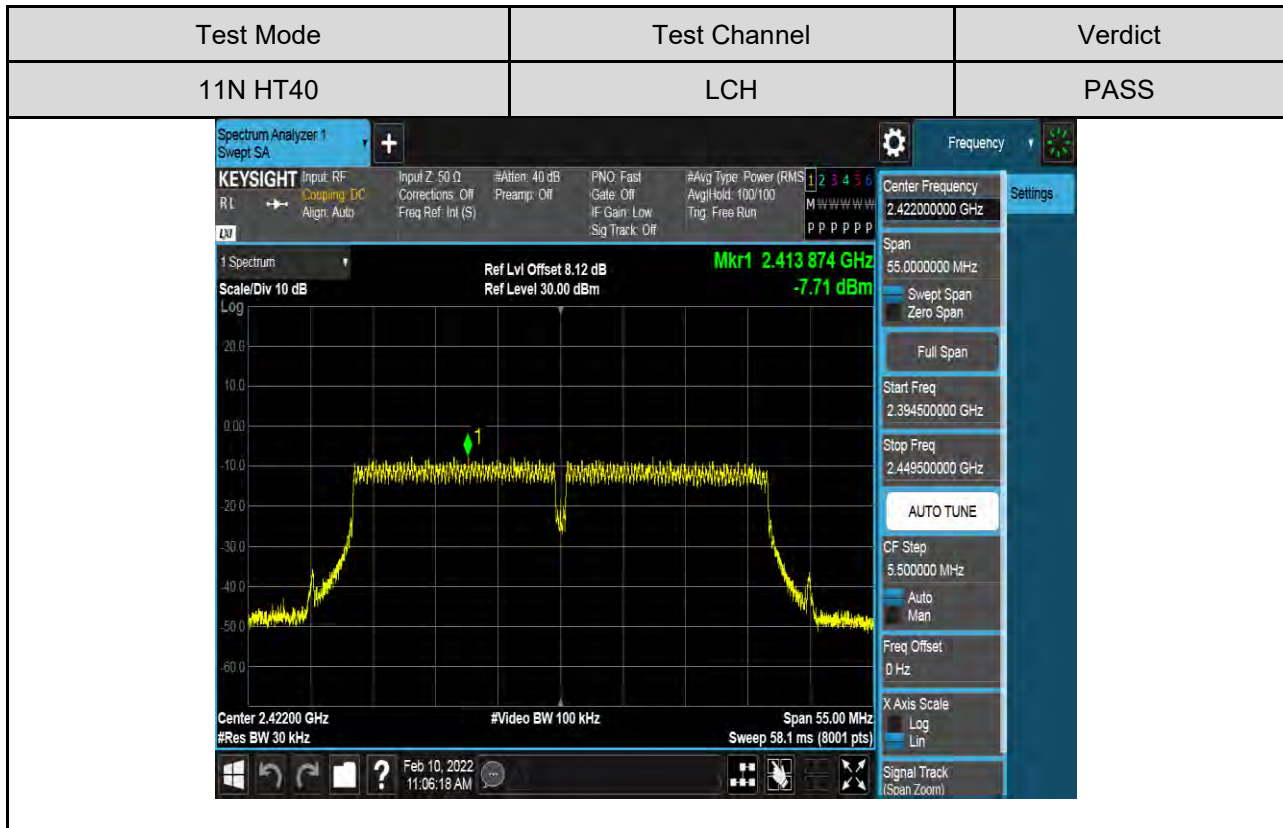
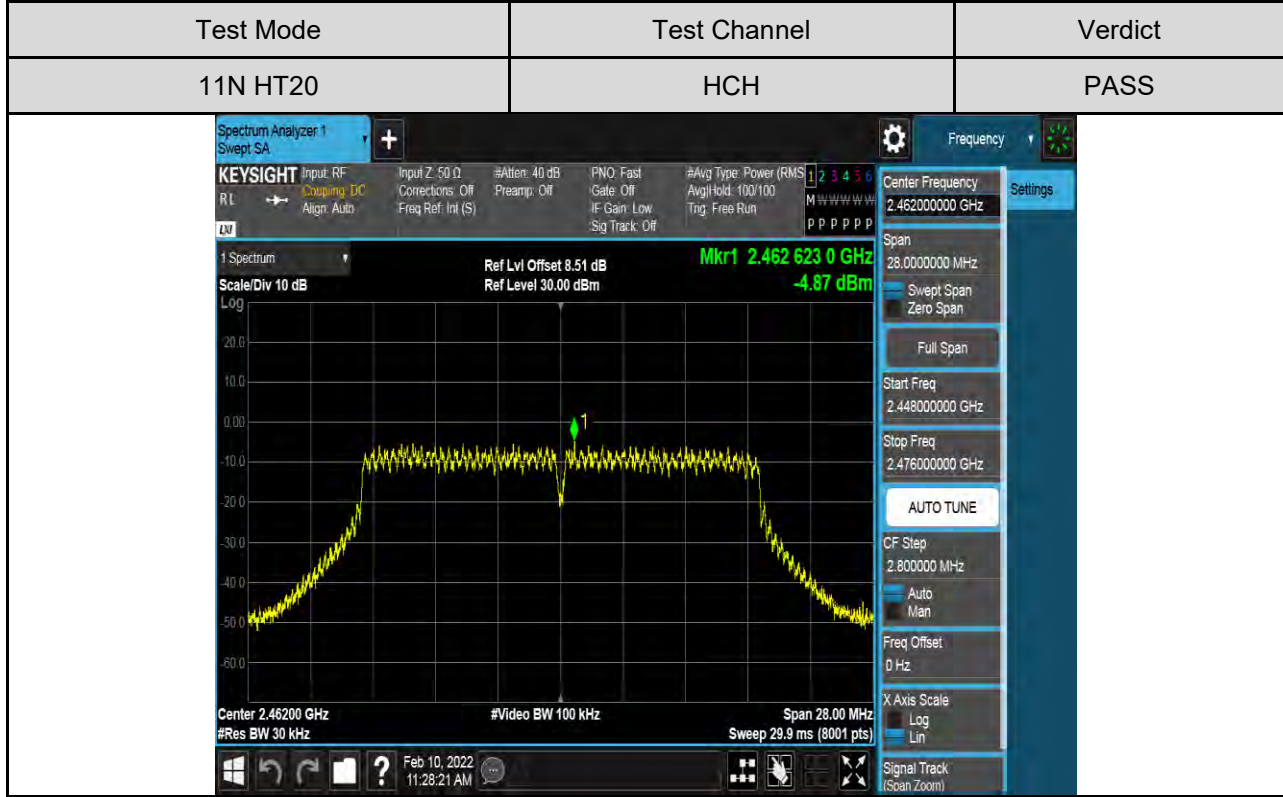

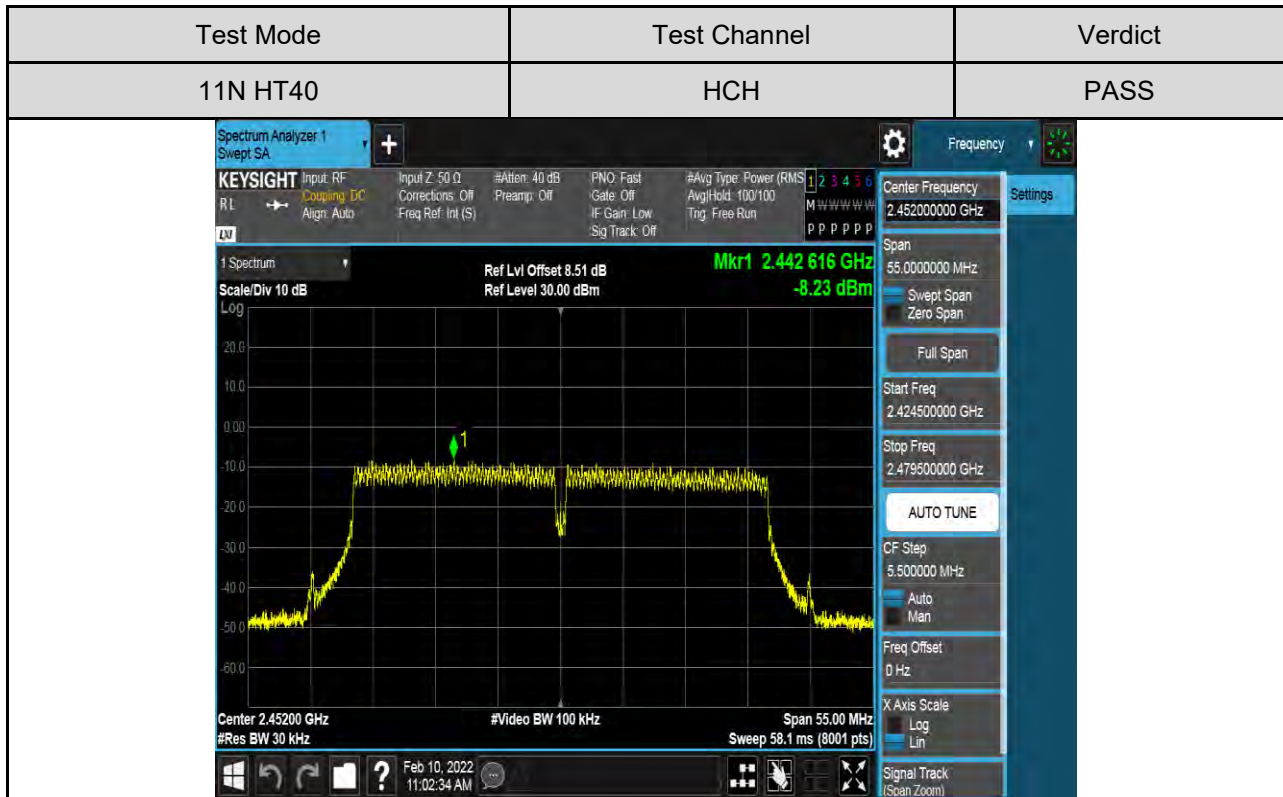
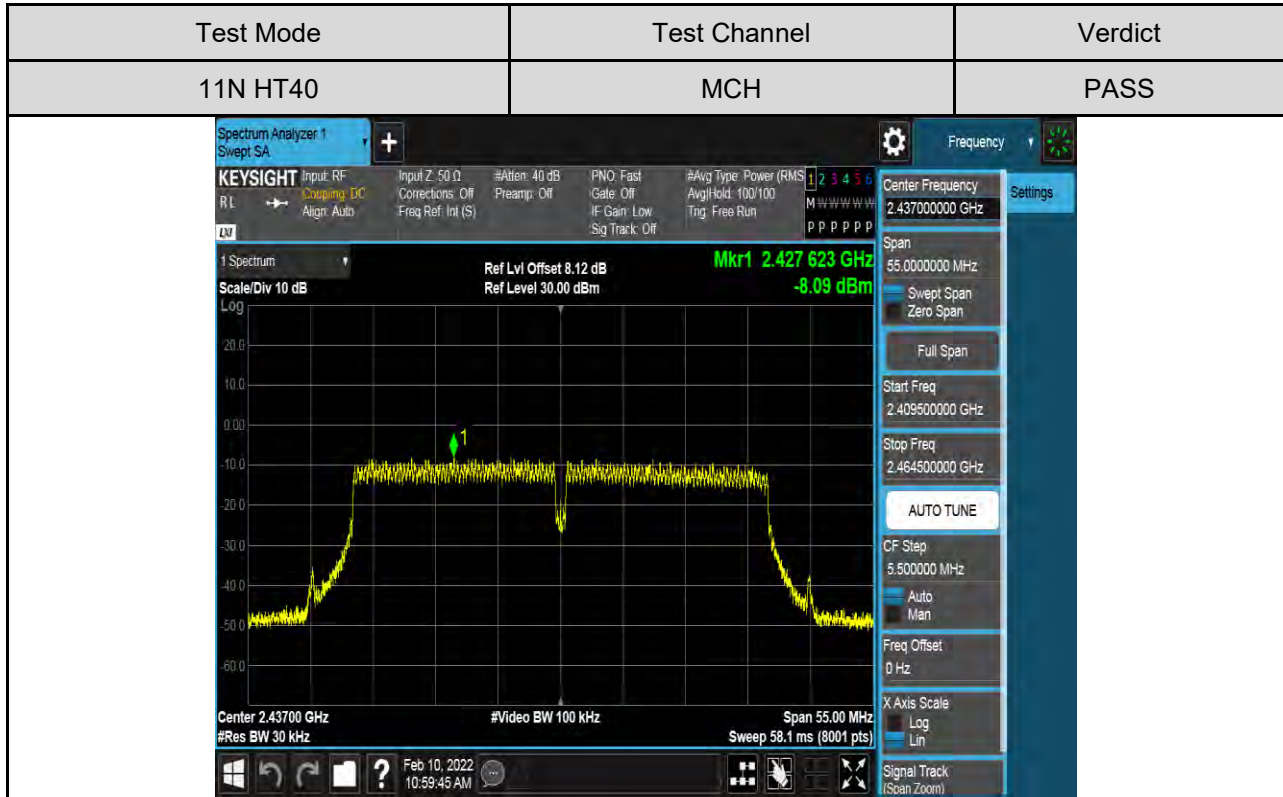

## 7.5. CONDUCTED BANDEGE AND SPURIOUS EMISSIONS

### LIMITS

FCC Part15 (15.247), Subpart C		
Section	Test Item	Limit
FCC §15.247 (d)	Conducted Bandedge and Spurious Emissions	30 dB below that in the 100 kHz bandwidth within the band that contains the highest level of the desired power

### TEST PROCEDURE

Refer to FCC KDB 558074, connect the UUT to the spectrum analyzer and use the following

Center Frequency	The center frequency of the channel under test
Detector	Peak
RBW	100K
VBW	$\geq 3 \times \text{RBW}$
Span	1.5 x DTS bandwidth
Trace	Max hold
Sweep time	Auto couple.

settings:

Use the peak marker function to determine the maximum PSD level.

Span	Set the center frequency and span to encompass frequency range to be measured
Detector	Peak
RBW	100K
VBW	$\geq 3 \times \text{RBW}$
measurement points	$\geq \text{span}/\text{RBW}$
Trace	Max hold
Sweep time	Auto couple.

Use the peak marker function to determine the maximum amplitude level.

### TEST SETUP

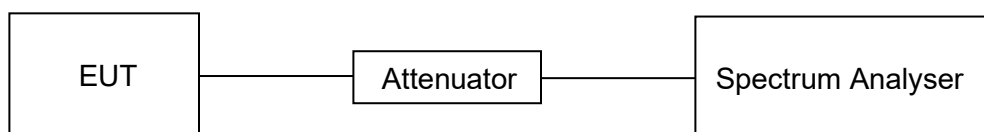



**TEST ENVIRONMENT**

Temperature	19.8°C	Relative Humidity	55.4%
Atmosphere Pressure	103.1kPa	Test Date	2022-02-10

**PART I: CONDUCTED BANDEDGE**

**TEST RESULTS TABLE**

Test Mode	Test Channel	Result	Verdict
11B	LCH	Refer to the Test Graph	PASS
	HCH	Refer to the Test Graph	PASS
11G	LCH	Refer to the Test Graph	PASS
	HCH	Refer to the Test Graph	PASS
11N HT20	LCH	Refer to the Test Graph	PASS
	HCH	Refer to the Test Graph	PASS
11N HT40	LCH	Refer to the Test Graph	PASS
	HCH	Refer to the Test Graph	PASS



**TEST GRAPHS**

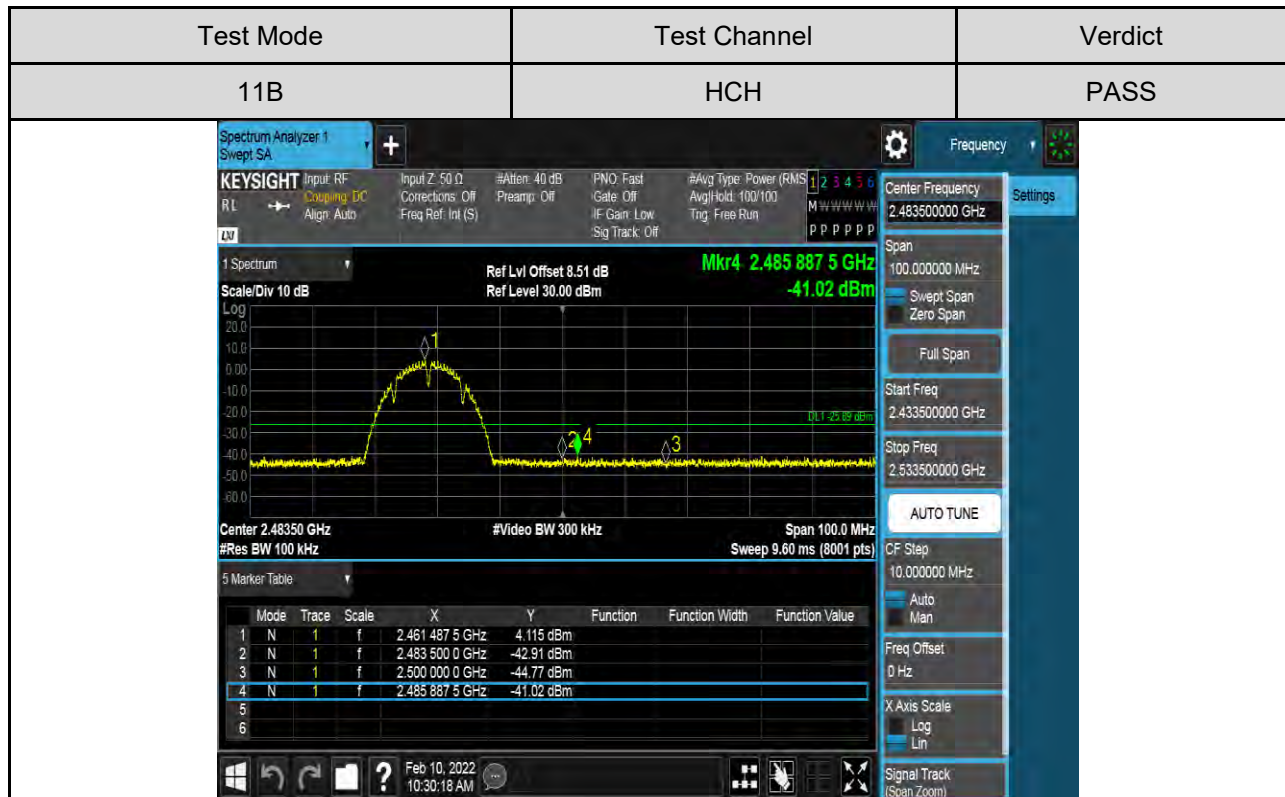
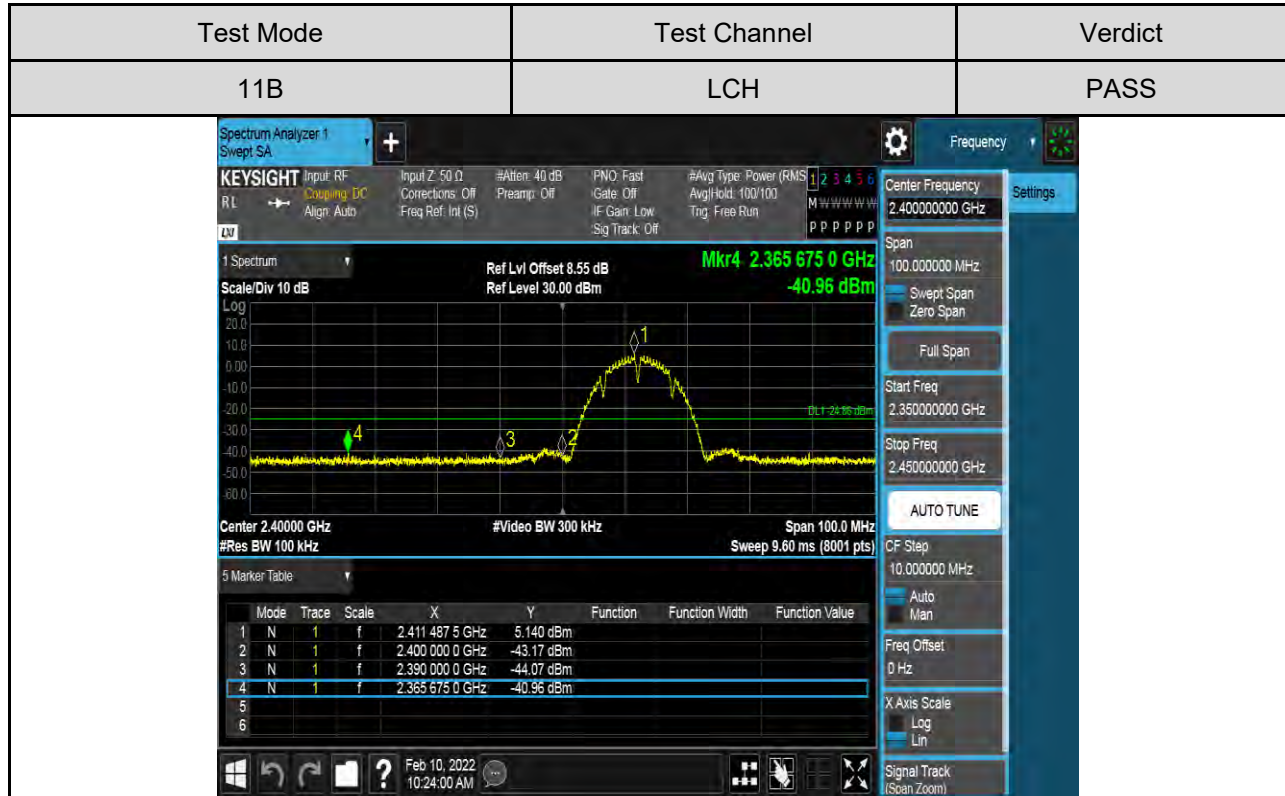

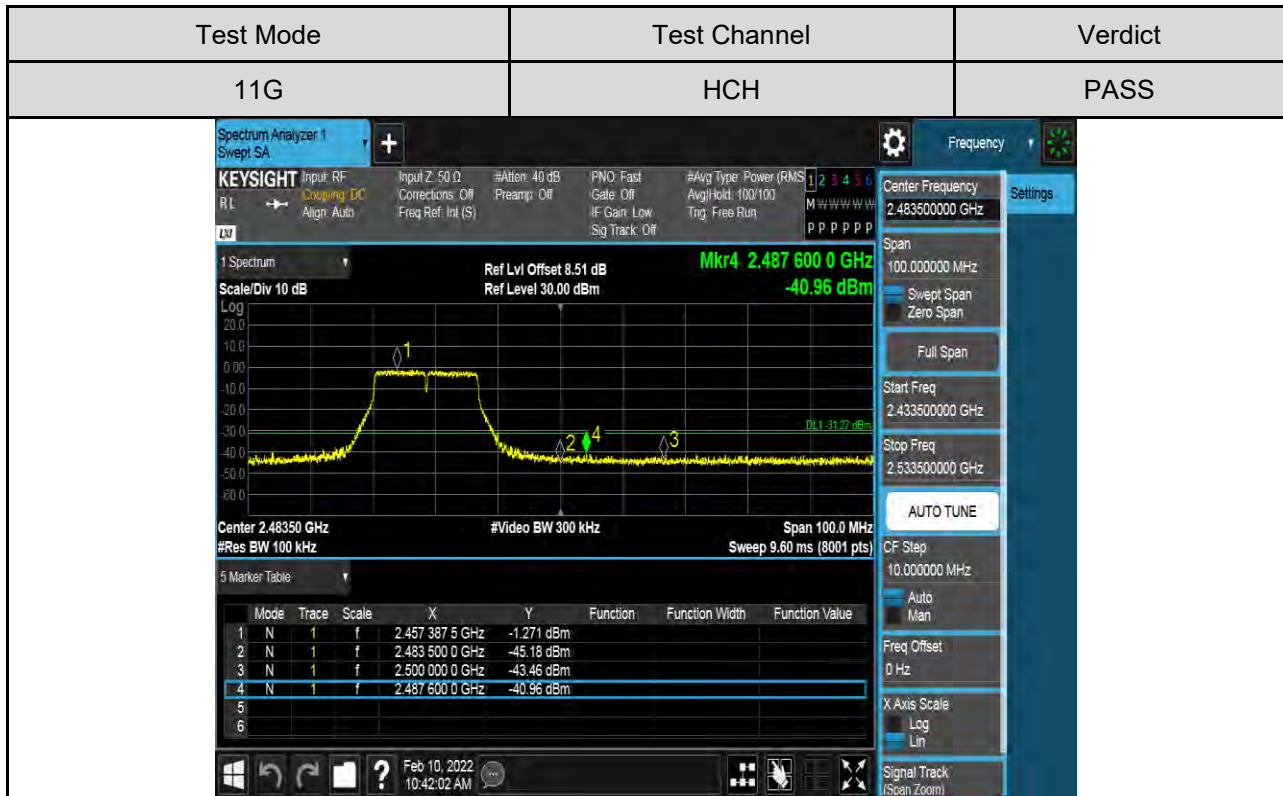
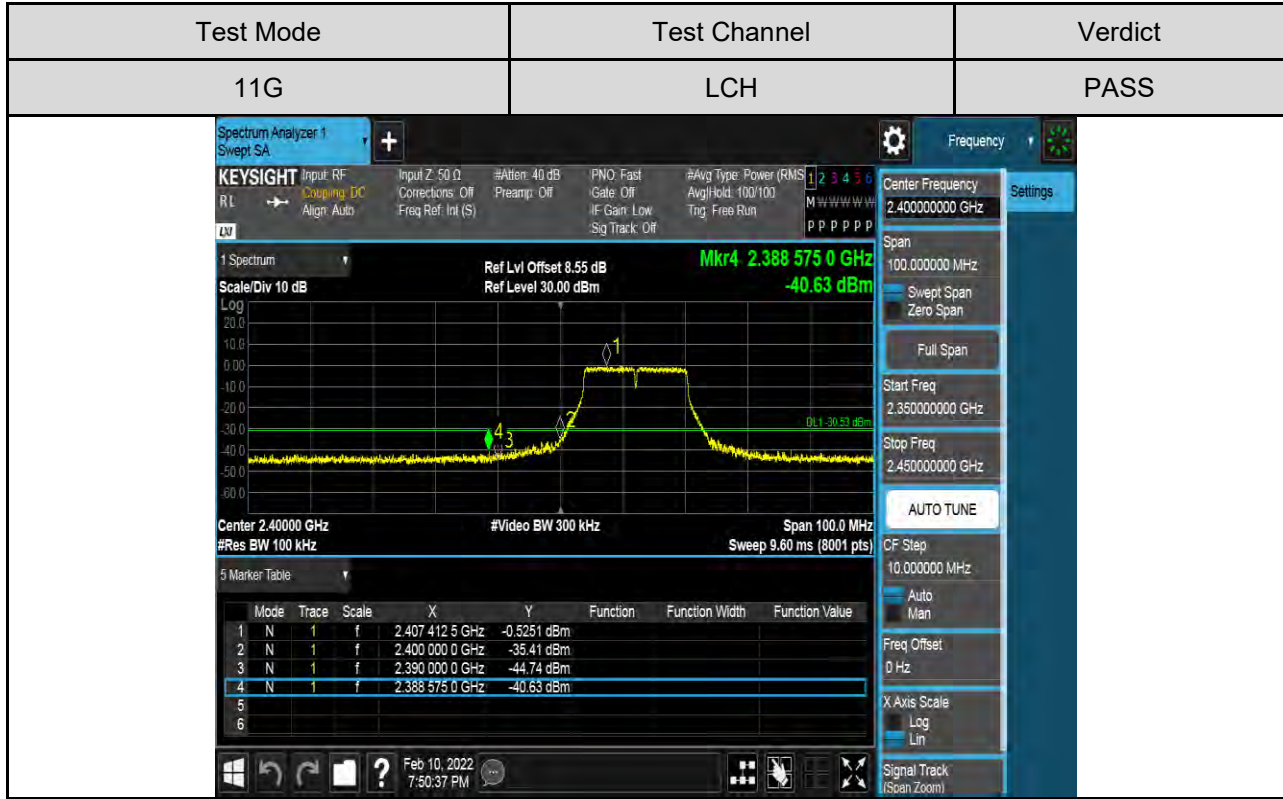



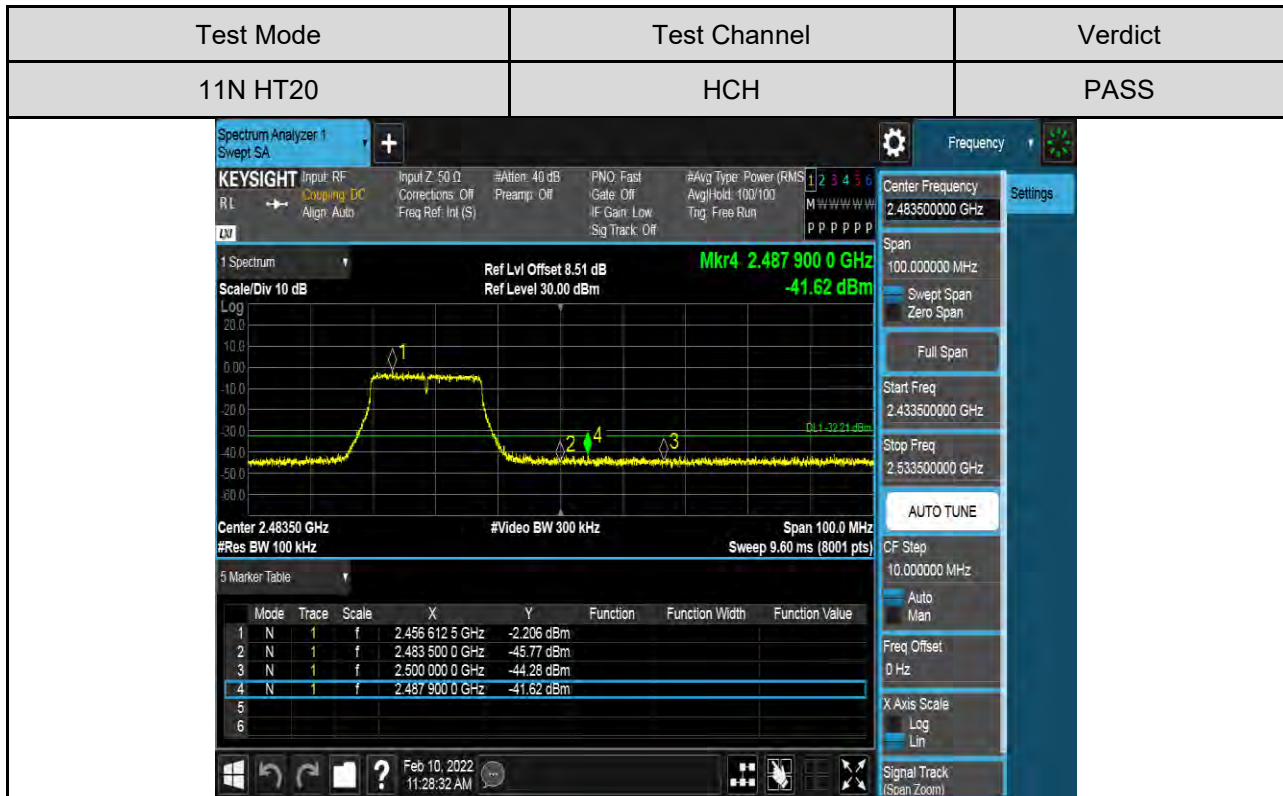
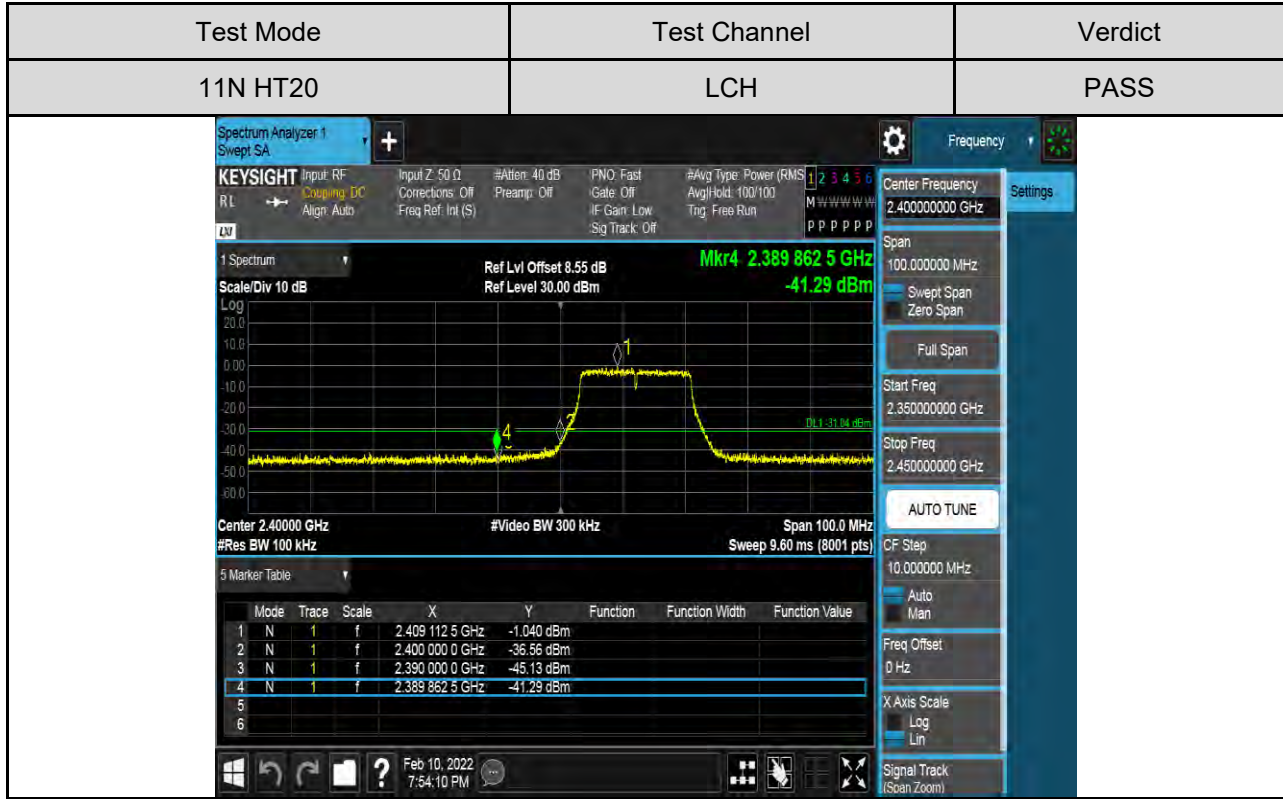

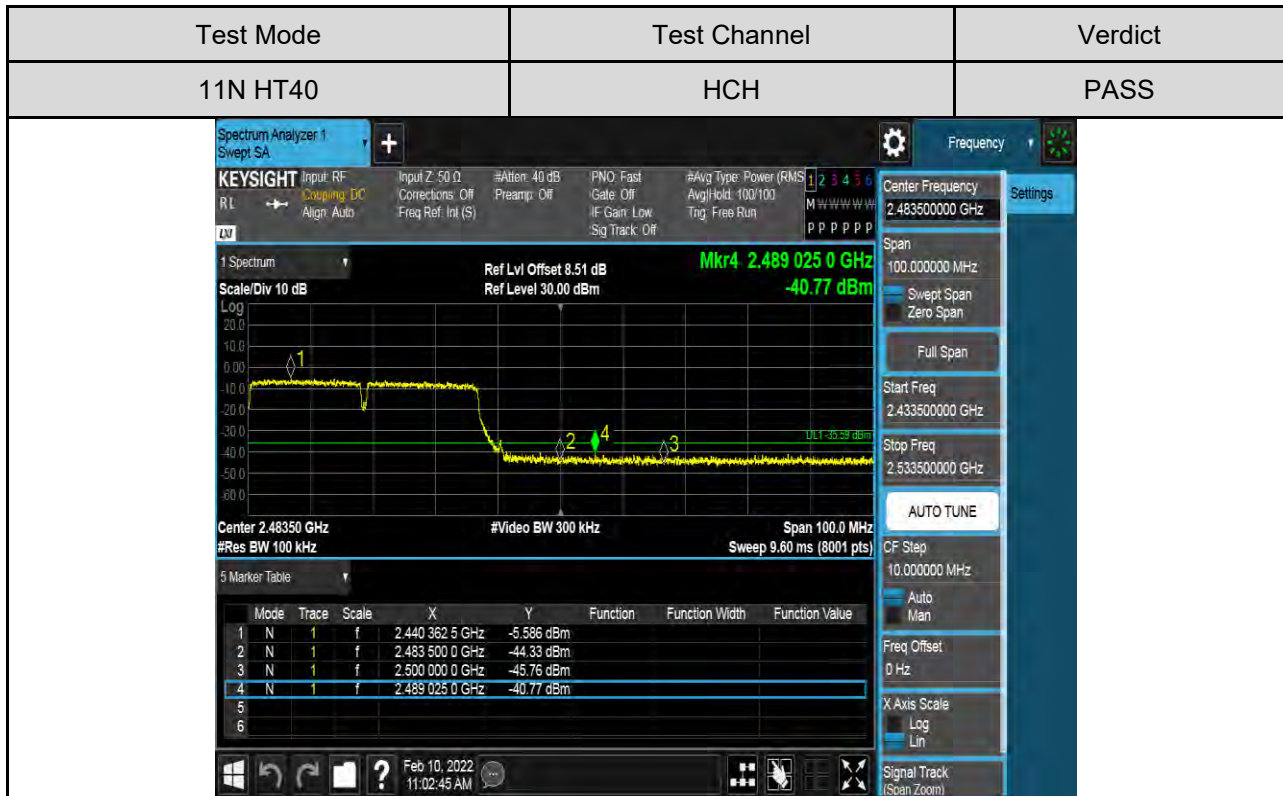
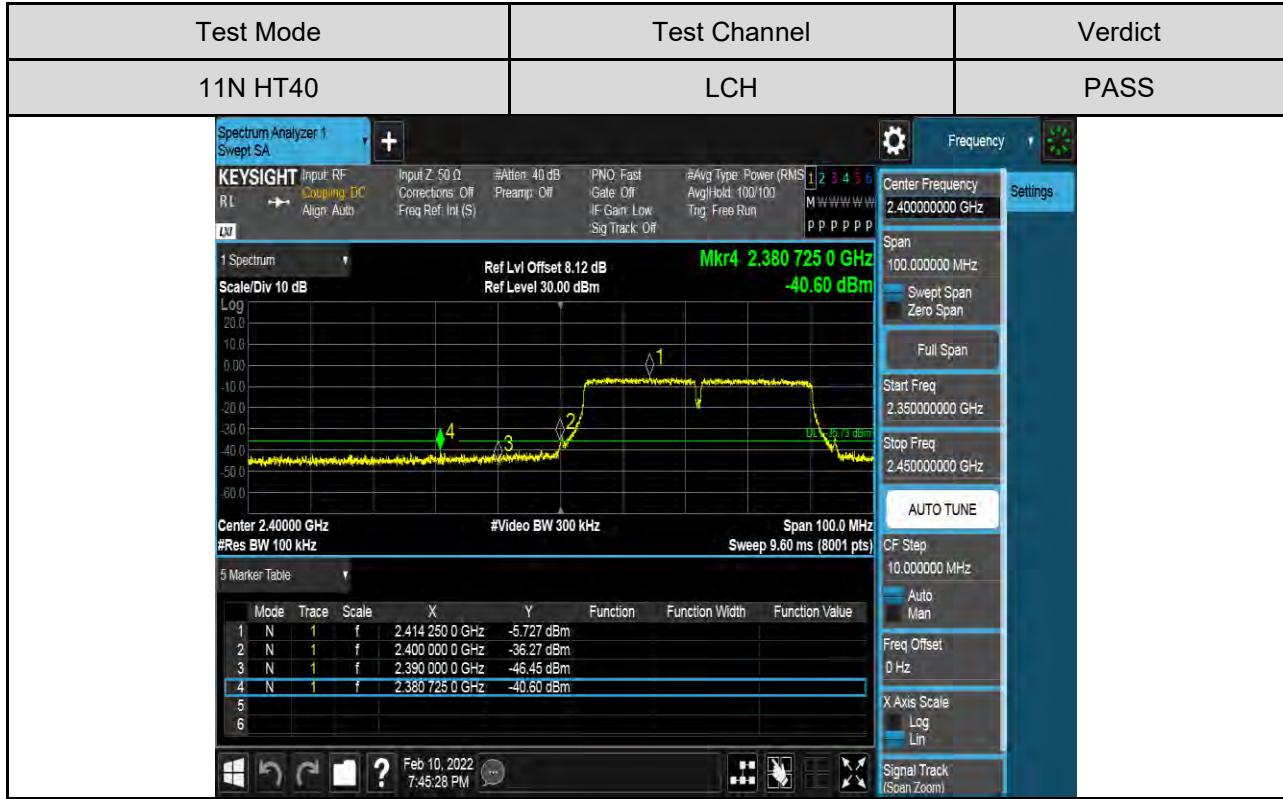



**PART II: CONDUCTED EMISSION**

**TEST RESULTS TABLE**

Test Mode	Test Channel	Result	Verdict
11B	LCH	Refer to the Test Graph	PASS
	MCH	Refer to the Test Graph	PASS
	HCH	Refer to the Test Graph	PASS
11G	LCH	Refer to the Test Graph	PASS
	MCH	Refer to the Test Graph	PASS
	HCH	Refer to the Test Graph	PASS
11N HT20	LCH	Refer to the Test Graph	PASS
	MCH	Refer to the Test Graph	PASS
	HCH	Refer to the Test Graph	PASS
11N HT40	LCH	Refer to the Test Graph	PASS
	MCH	Refer to the Test Graph	PASS
	HCH	Refer to the Test Graph	PASS



**TEST GRAPHS**

Test Mode	Channel	Verdict
11B	LCH	PASS

Pref test Plot





Puw test Plot

LCH SPURIOUS EMISSION 30MHz~10GHz



LCH SPURIOUS EMISSION 10GHz~26GHz





Test Mode	Channel	Verdict
11B	MCH	PASS

Pref test Plot





Puw test Plot

MCH SPURIOUS EMISSION 30MHz~10GHz



MCH SPURIOUS EMISSION 10GHz~26GHz





Test Mode	Channel	Verdict
11B	HCH	PASS

Pref test Plot







Puw test Plot

HCH SPURIOUS EMISSION 30MHz~10GHz

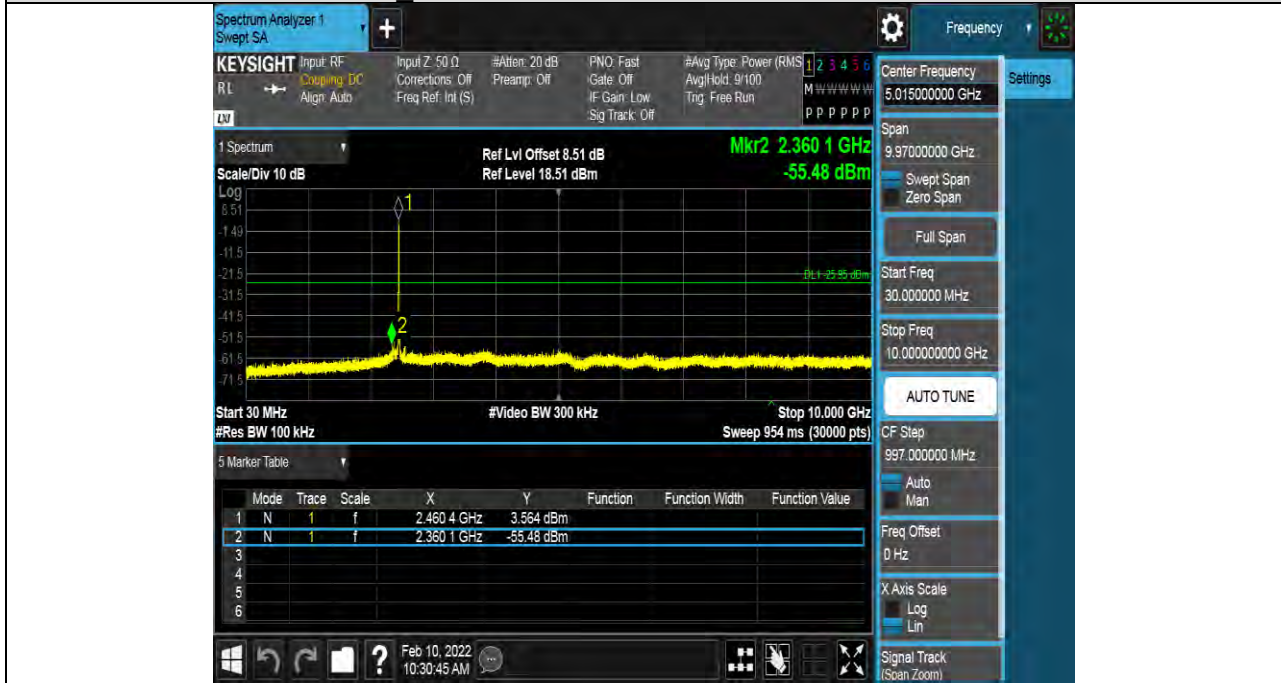

HCH SPURIOUS EMISSION 10GHz~26GHz





Test Mode	Channel	Verdict
11G	LCH	PASS

Pref test Plot

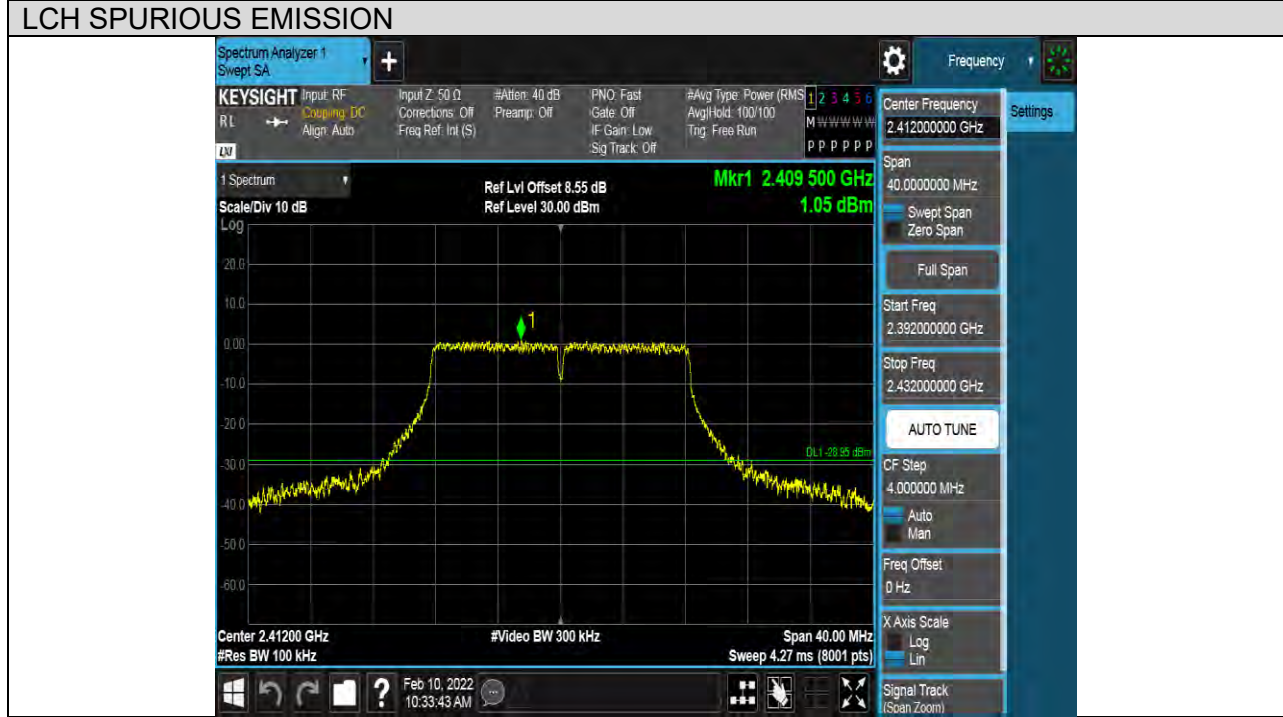



Puw test Plot

LCH SPURIOUS EMISSION 30MHz~10GHz

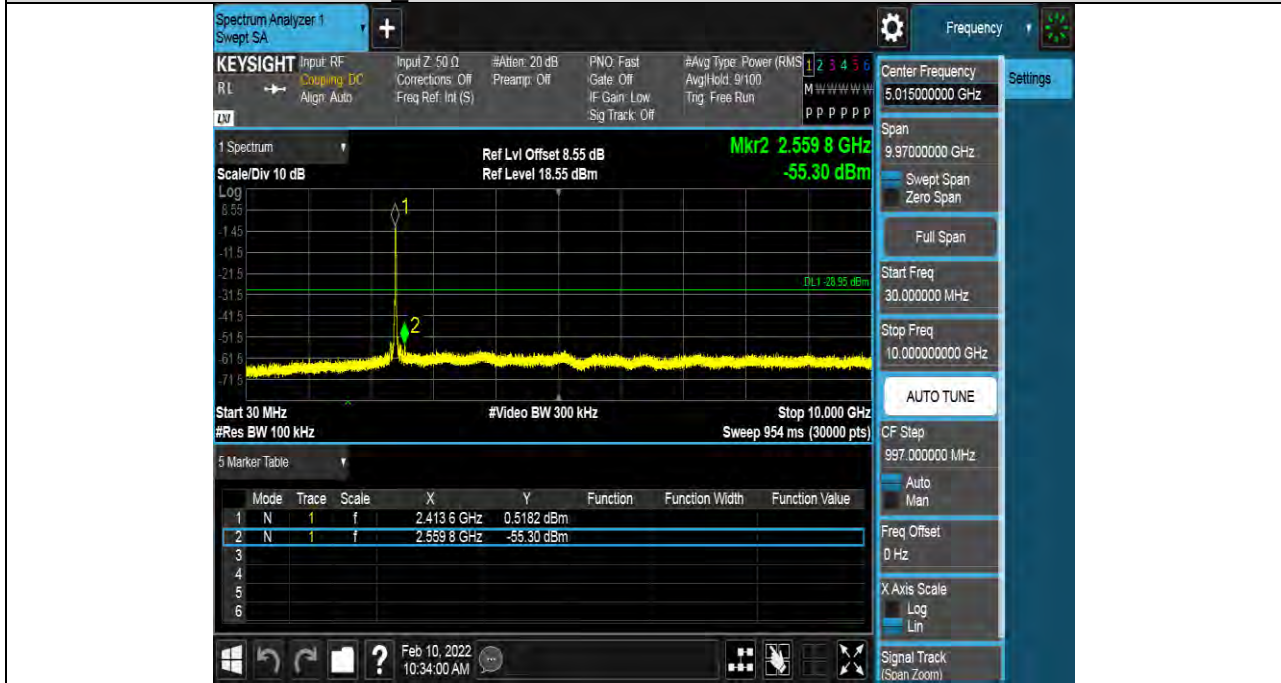

LCH SPURIOUS EMISSION 10GHz~26GHz





Test Mode	Channel	Verdict
11G	MCH	PASS

Pref test Plot

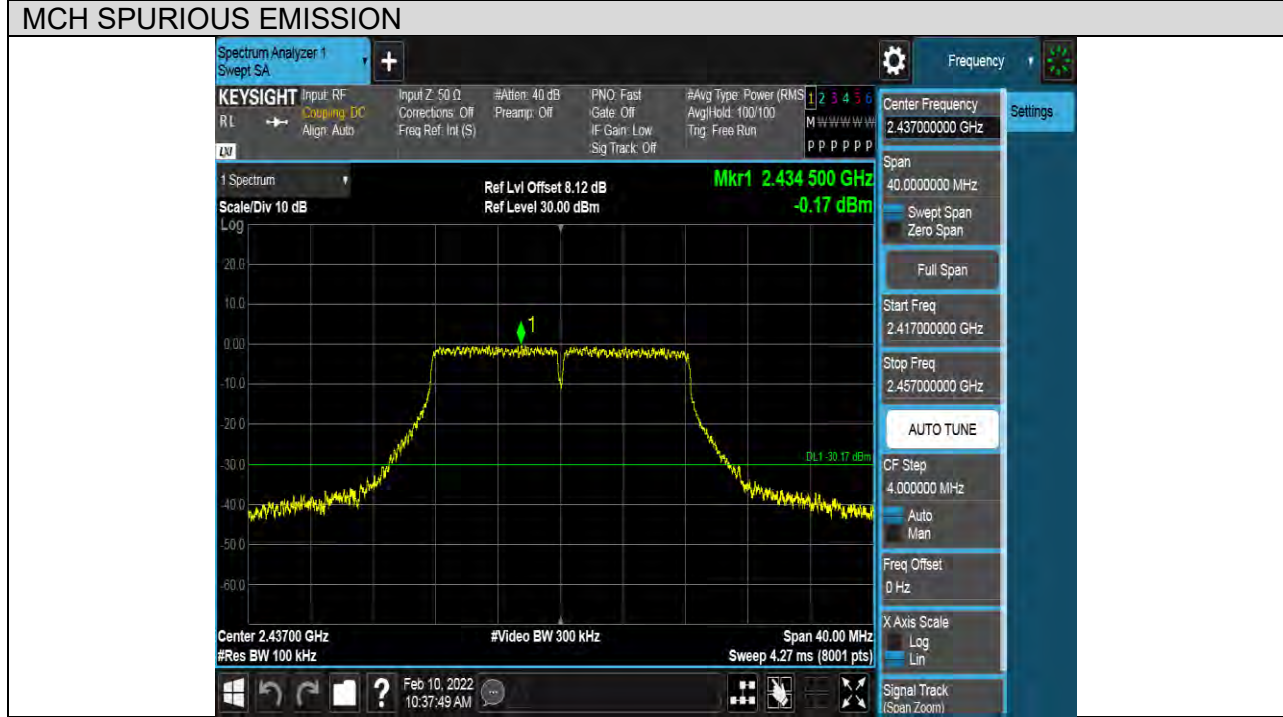



Puw test Plot

MCH SPURIOUS EMISSION 30MHz~10GHz

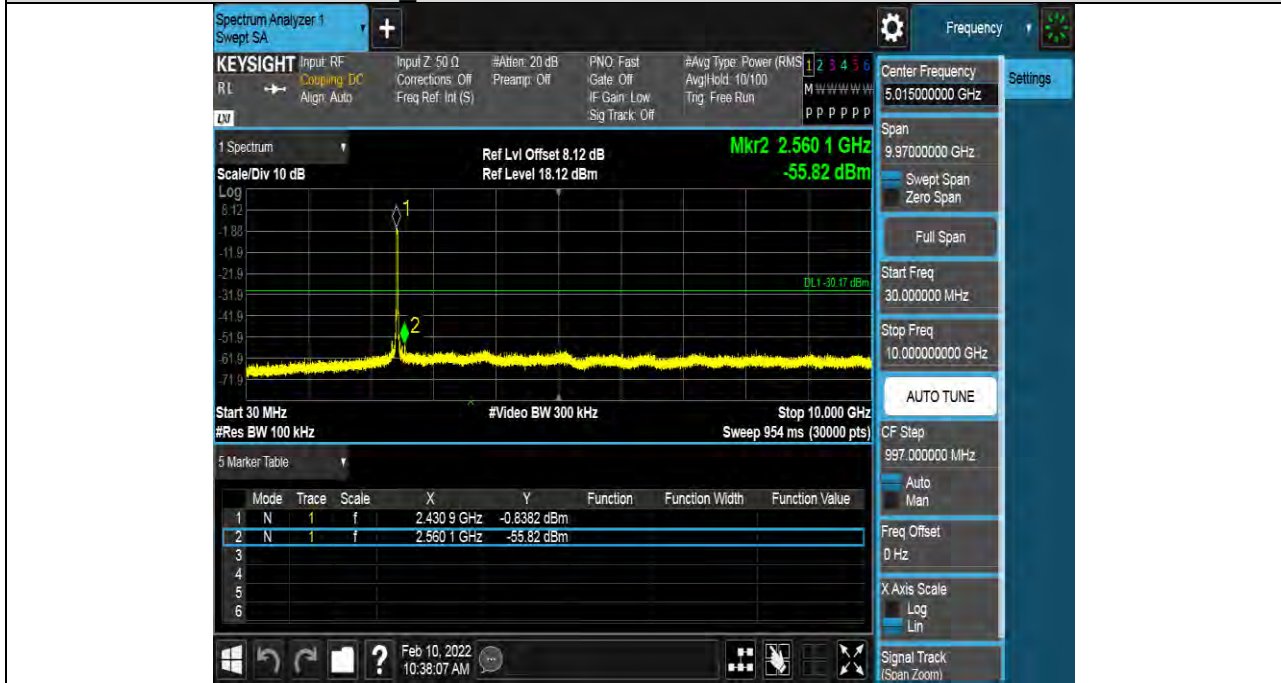

MCH SPURIOUS EMISSION 10GHz~26GHz





Test Mode	Channel	Verdict
11G	HCH	PASS

Pref test Plot

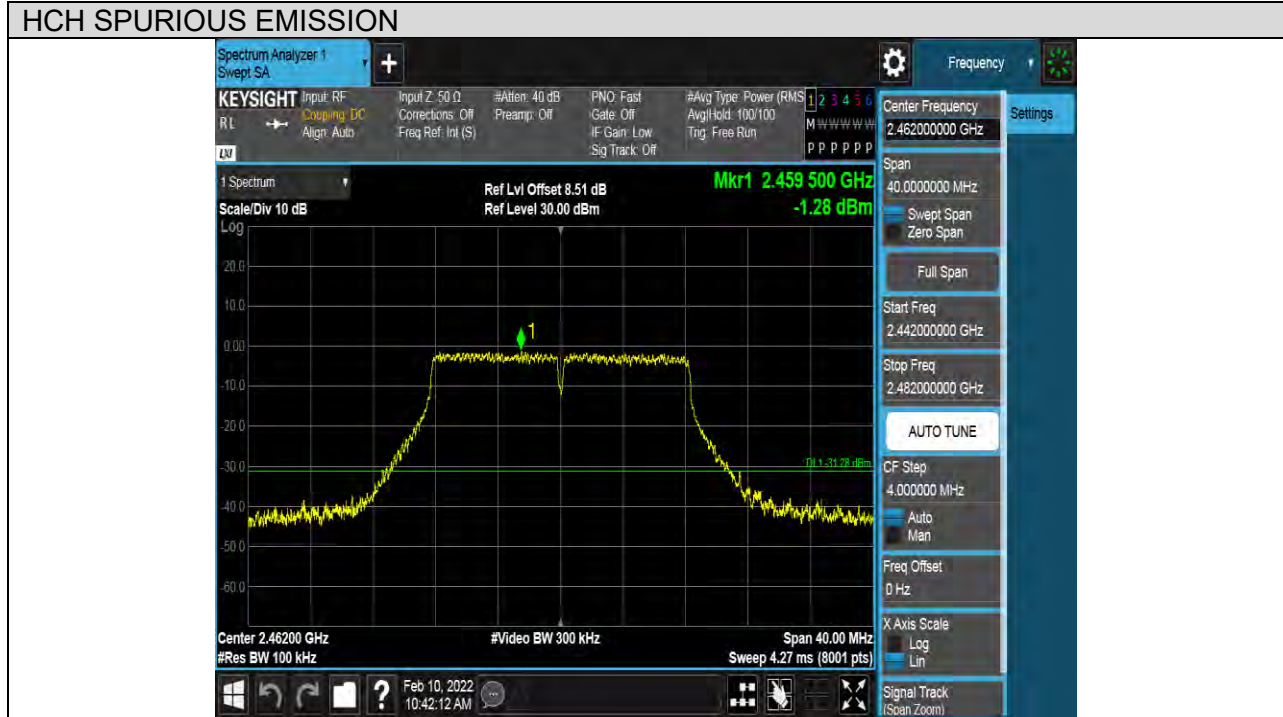



Puw test Plot

HCH SPURIOUS EMISSION 30MHz~10GHz

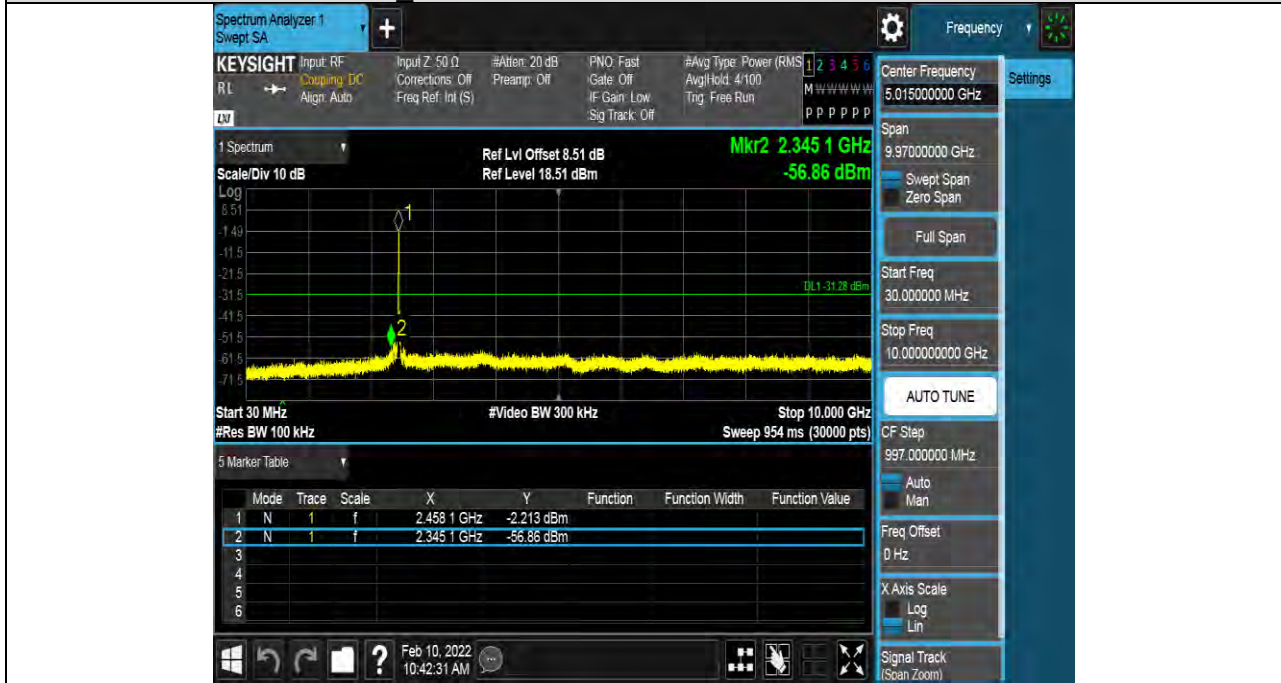

HCH SPURIOUS EMISSION 10GHz~26GHz





Test Mode	Channel	Verdict
11N HT20	LCH	PASS

### Pref test Plot

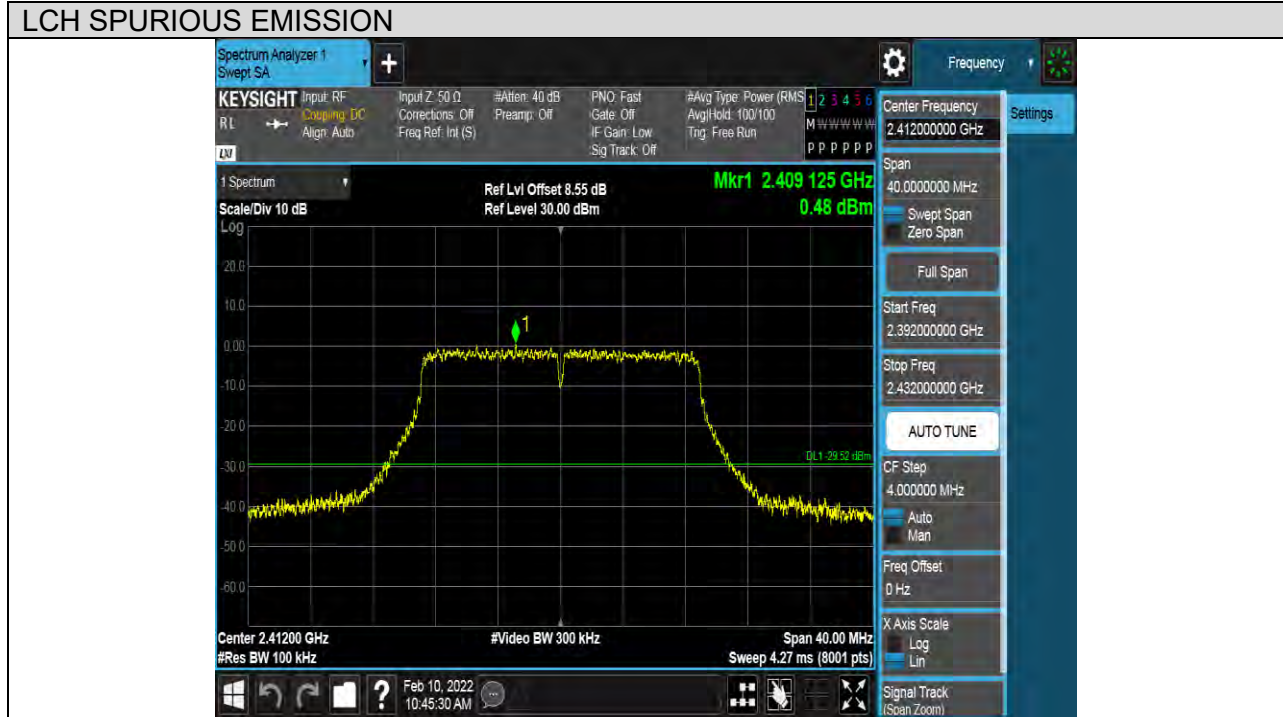





Puw test Plot

LCH SPURIOUS EMISSION 30MHz~10GHz



LCH SPURIOUS EMISSION 10GHz~26GHz





Test Mode	Channel	Verdict
11N HT20	MCH	PASS

Pref test Plot

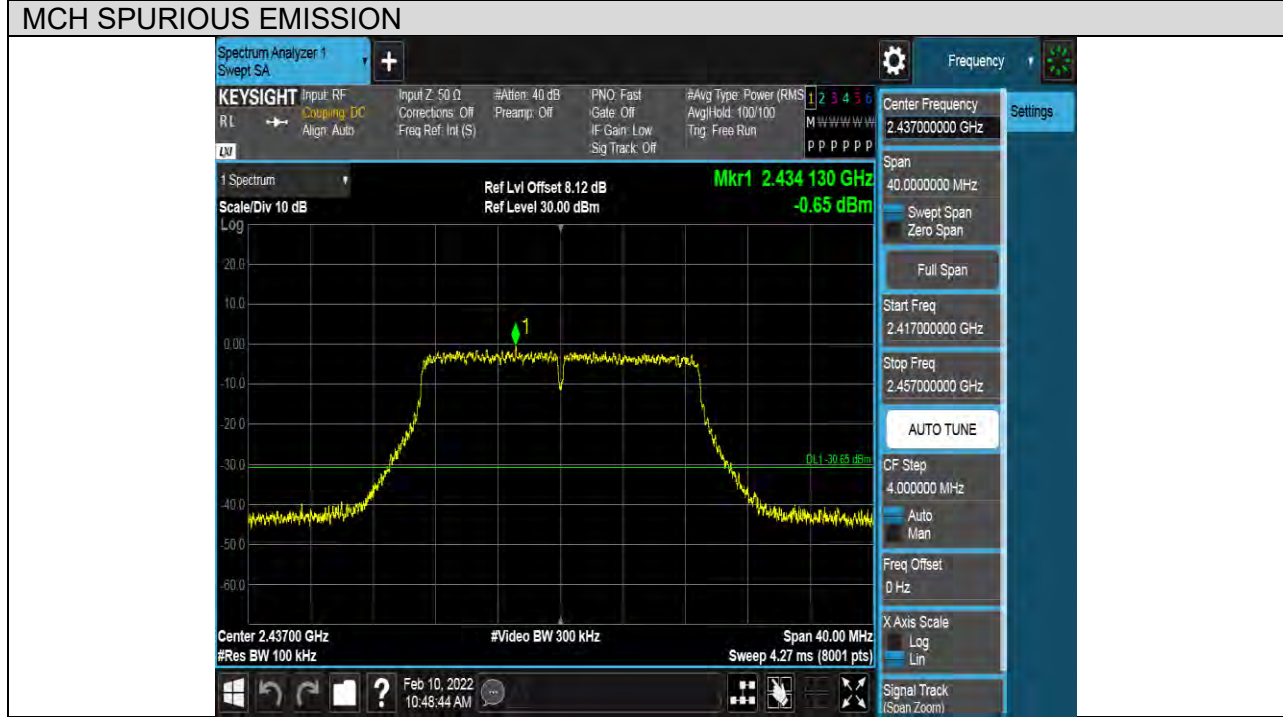



Puw test Plot

MCH SPURIOUS EMISSION 30MHz~10GHz



MCH SPURIOUS EMISSION 10GHz~26GHz





Test Mode	Channel	Verdict
11N HT20	HCH	PASS

Pref test Plot

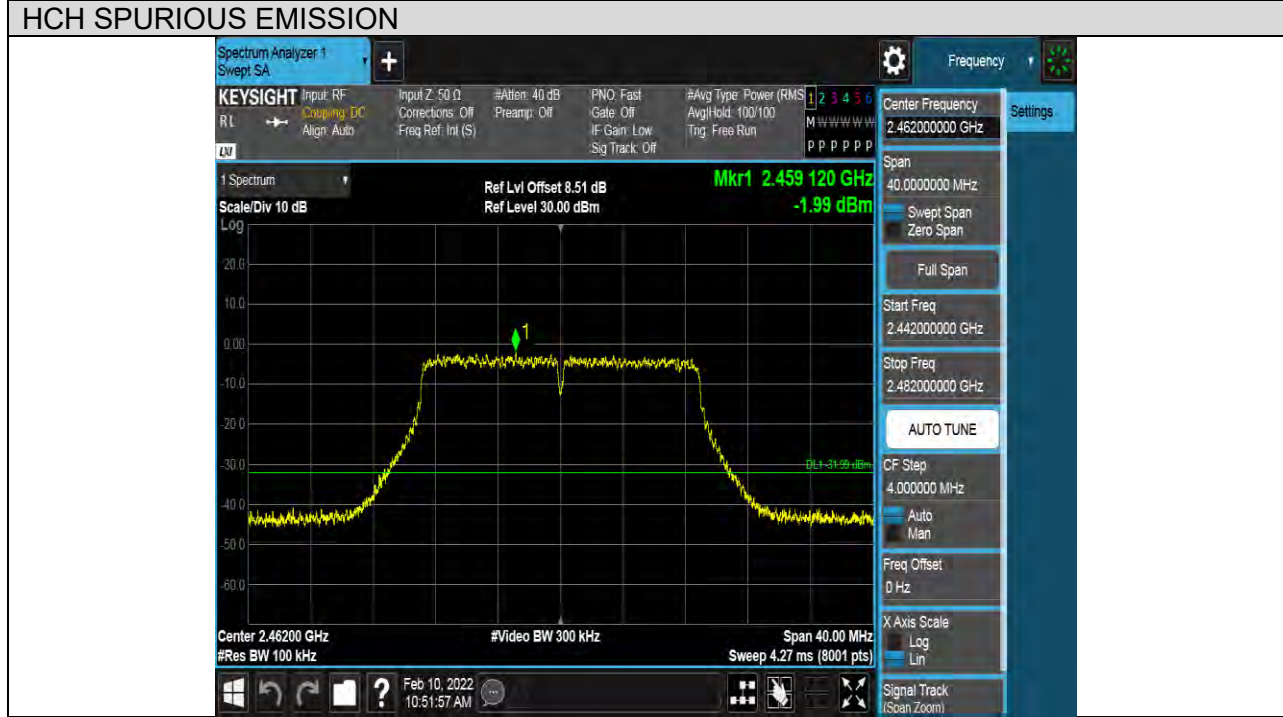



Puw test Plot

HCH SPURIOUS EMISSION 30MHz~10GHz

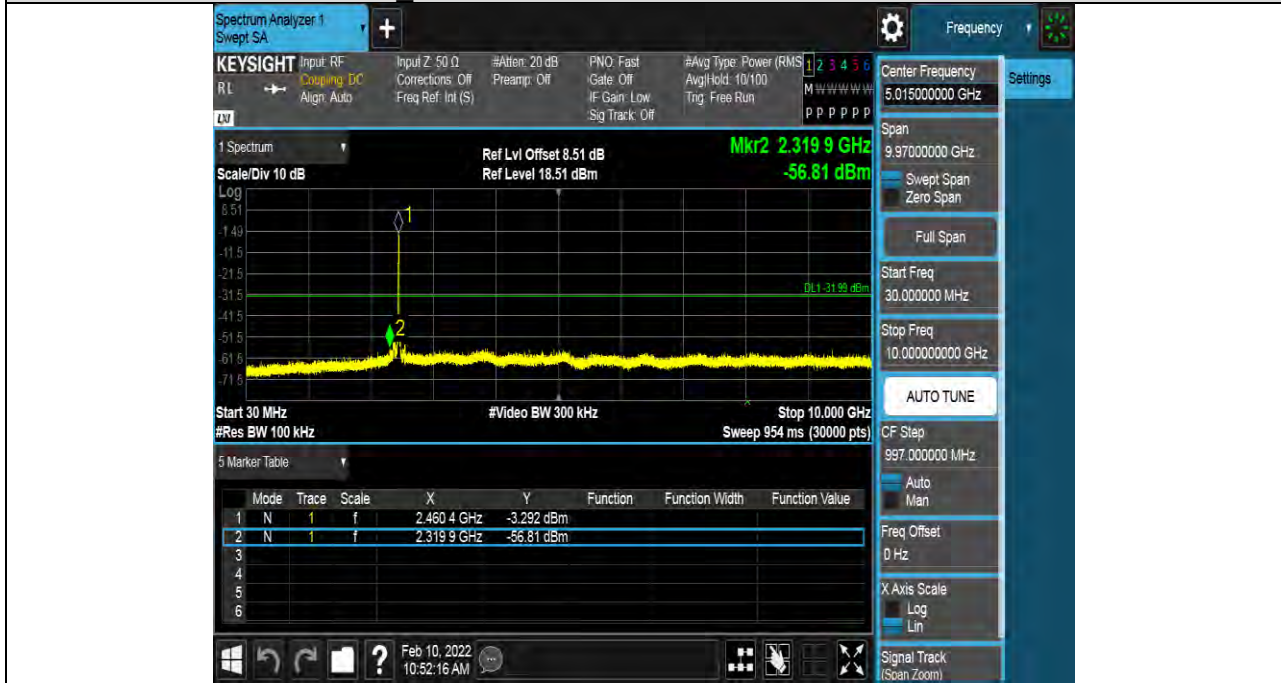

HCH SPURIOUS EMISSION 10GHz~26GHz





Test Mode	Channel	Verdict
11N HT40	LCH	PASS

Pref test Plot





Puw test Plot

LCH SPURIOUS EMISSION 30MHz~10GHz



LCH SPURIOUS EMISSION 10GHz~26GHz





Test Mode	Channel	Verdict
11N HT40	MCH	PASS

Pref test Plot

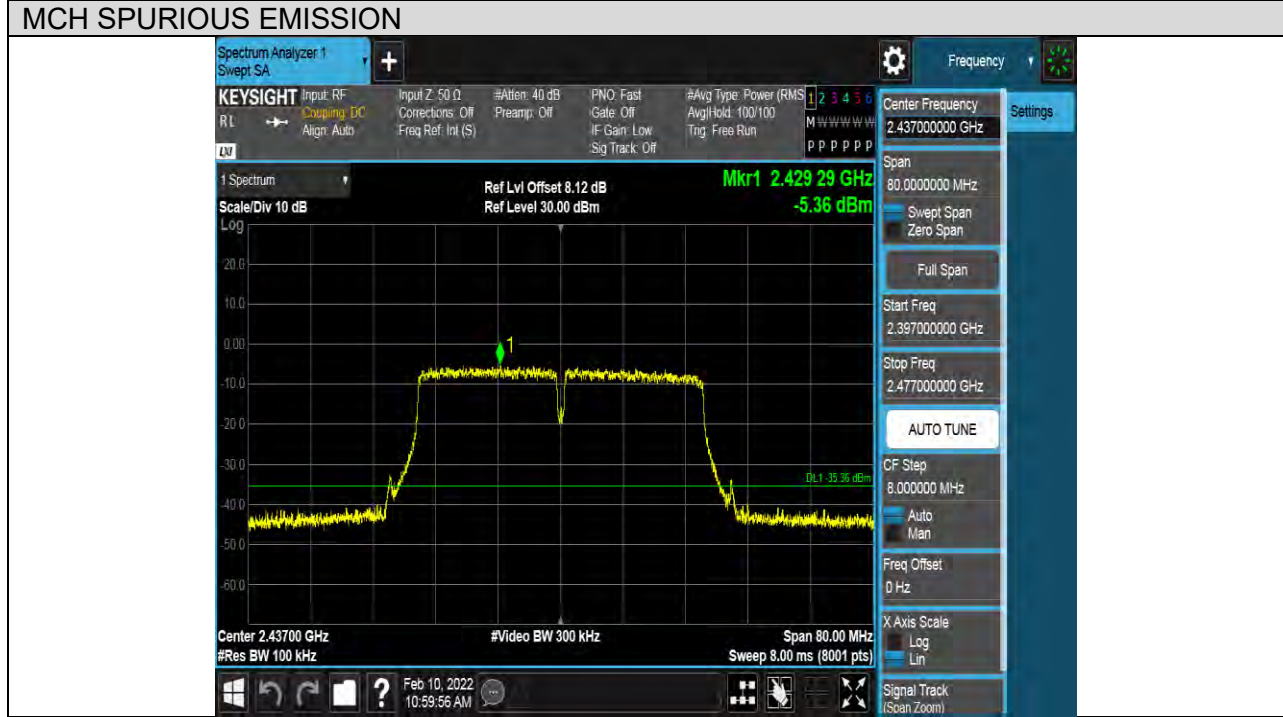





Puw test Plot

MCH SPURIOUS EMISSION 30MHz~10GHz



MCH SPURIOUS EMISSION 10GHz~26GHz





Test Mode	Channel	Verdict
11N HT40	HCH	PASS

Pref test Plot

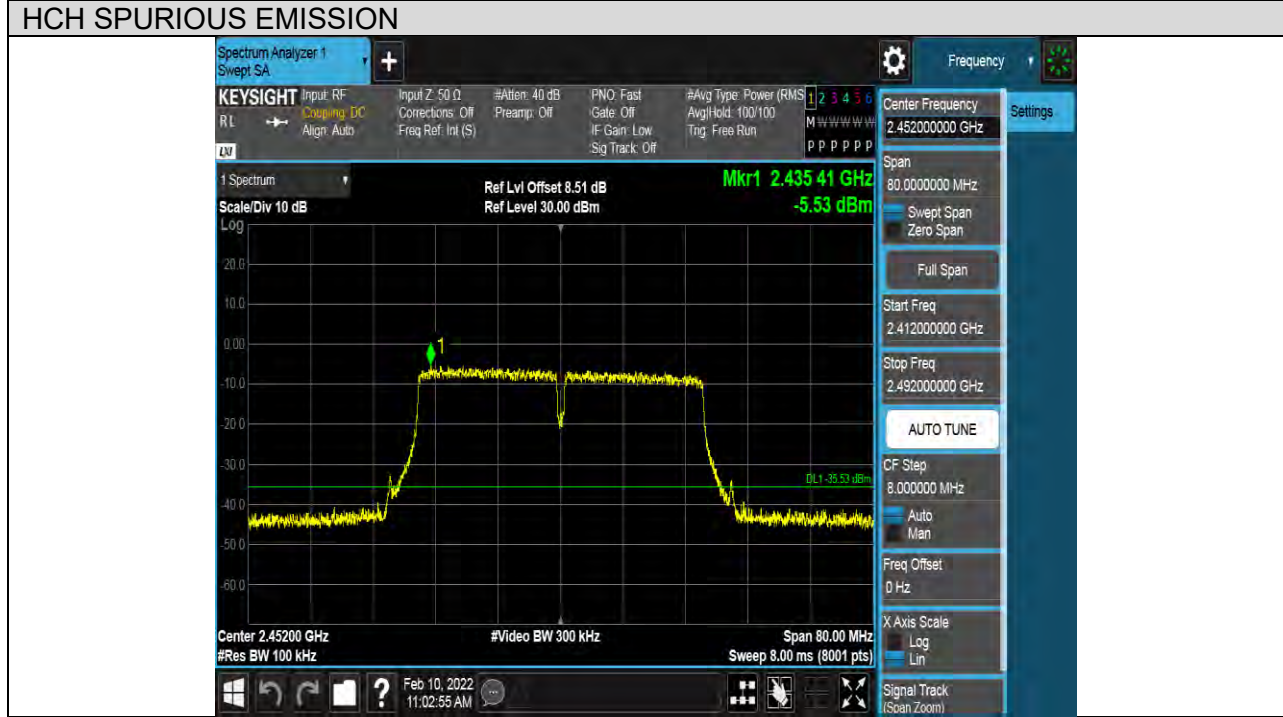



Puw test Plot

HCH SPURIOUS EMISSION 30MHz~10GHz



HCH SPURIOUS EMISSION 10GHz~26GHz



## 7.6. RADIATED TEST RESULTS

### 7.6.1. LIMITS AND PROCEDURE

#### LIMITS

Please refer to FCC §15.205 and §15.209

Please refer to FCC KDB 558074

Radiation Disturbance Test Limit for FCC (Class B)(9KHz-1GHz)

Frequency (MHz)	Field Strength (microvolts/meter)	Measurement Distance (meters)
0.009~0.490	2400/F(KHz)	300
0.490~1.705	24000/F(KHz)	30
1.705~30.0	30	30
30~88	100	3
88~216	150	3
216~960	200	3
960~1000	500	3

Note: 1) At frequencies at or above 30 MHz, measurements may be performed at a distance other than what is specified provided: measurements are not made in the near field except where it can be shown that near field measurements are appropriate due to the characteristics of the device; and it can be demonstrated that the signal levels needed to be measured at the distance employed can be detected by the measurement equipment. Measurements shall not be performed at a distance greater than 30 meters unless it can be further demonstrated that measurements at a distance of 30 meters or less are impractical. When performing measurements at a distance other than that specified, the results shall be extrapolated to the specified distance using an extrapolation factor of 20 dB/decade (inverse linear-distance for field strength measurements; inverse-linear-distance-squared for power density measurements).

(2) At frequencies below 30 MHz, measurements may be performed at a distance closer than that specified in the regulations; however, an attempt should be made to avoid making measurements in the near field. Pending the development of an appropriate measurement procedure for measurements performed below 30 MHz, when performing measurements at a closer distance than specified, the results shall be extrapolated to the specified distance by either making measurements at a minimum of two distances on at least one radial to determine the proper extrapolation factor or by using the square of an inverse linear distance extrapolation factor (40 dB/decade). This paragraph (f) shall not apply to Access BPL devices operating below 30 MHz.



Radiation Disturbance Test Limit for FCC (Above 1G)

Frequency (MHz)	dB(uV/m) (at 3 meters)	
	Peak	Average
Above 1000	74	54

Restricted bands of operation

MHz	MHz	MHz	GHz
0.090-0.110	16.42-16.423	399.9-410	4.5-5.15
<sup>1</sup> 0.495-0.505	16.69475-16.69525	608-614	5.35-5.46
2.1735-2.1905	16.80425-16.80475	960-1240	7.25-7.75
4.125-4.128	25.5-25.67	1300-1427	8.025-8.5
4.17725-4.17775	37.5-38.25	1435-1626.5	9.0-9.2
4.20725-4.20775	73-74.6	1645.5-1646.5	9.3-9.5
6.215-6.218	74.8-75.2	1660-1710	10.6-12.7
6.26775-6.26825	108-121.94	1718.8-1722.2	13.25-13.4
6.31175-6.31225	123-138	2200-2300	14.47-14.5
8.291-8.294	149.9-150.05	2310-2390	15.35-16.2
8.362-8.366	156.52475-156.52525	2483.5-2500	17.7-21.4
8.37625-8.38675	156.7-156.9	2690-2900	22.01-23.12
8.41425-8.41475	162.0125-167.17	3260-3267	23.6-24.0
12.29-12.293	167.72-173.2	3332-3339	31.2-31.8
12.51975-12.52025	240-285	3345.8-3358	36.43-36.5
12.57675-12.57725	322-335.4	3600-4400	( <sup>2</sup> )
13.36-13.41			

Note: <sup>1</sup>Until February 1, 1999, this restricted band shall be 0.490-0.510 MHz.

<sup>2</sup>Above 38.6c

**TEST SETUP AND PROCEDURE**

Below 30MHz

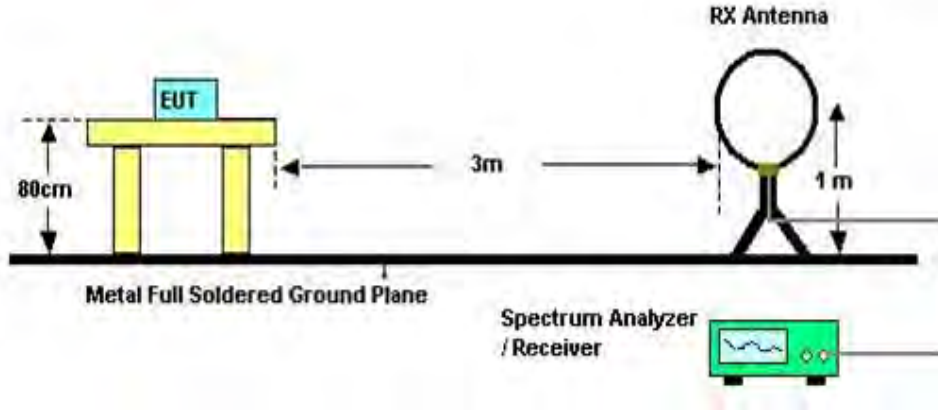

The setting of the spectrum analyser

RBW	200Hz (From 9kHz to 0.15MHz)/ 9KHz (From 0.15MHz to 30MHz)
VBW	200Hz (From 9kHz to 0.15MHz)/ 9KHz (From 0.15MHz to 30MHz)
Sweep	Auto
Detector	Peak/QP/ Average
Trace	Max hold

1. The testing follows the guidelines in ANSI C63.10-2013
2. The EUT was arranged to its worst case and then turntable (from 0 degree to 360 degrees) to find the maximum reading. A pre-amp and a high pass filter are used for the test in order to get better signal level. Both Horizontal, Face-on and Face-off polarizations of the antenna are set to make the measurement.
3. The EUT was placed on a turntable with 0.8 meter above ground.
4. The EUT was set 3 meters from the interference receiving antenna, which was mounted on the top of a 1m height antenna tower.
5. The radiated emission limits are based on measurements employing a CISPR quasi-peak detector except for the frequency bands 9-90 kHz, 110-490 kHz and above 1000 MHz. Radiated emission limits in these three bands are based on measurements employing an average detector
6. For measurement below 1GHz, the initial step in collecting conducted emission data is a spectrum analyzer peak detector mode pre-scanning the measurement frequency range. Significant peaks are then marked and then Quasi Peak detector mode re-measured. If the emission level of the EUT measured by the peak detector is 3 dB lower than the applicable limit, the peak emission level will be reported. Otherwise, the emission measurement will be repeated using the quasi-peak detector and reported.
7. For the actual test configuration, please refer to the related item in this test report (Photographs of the Test Configuration)

Below 1G

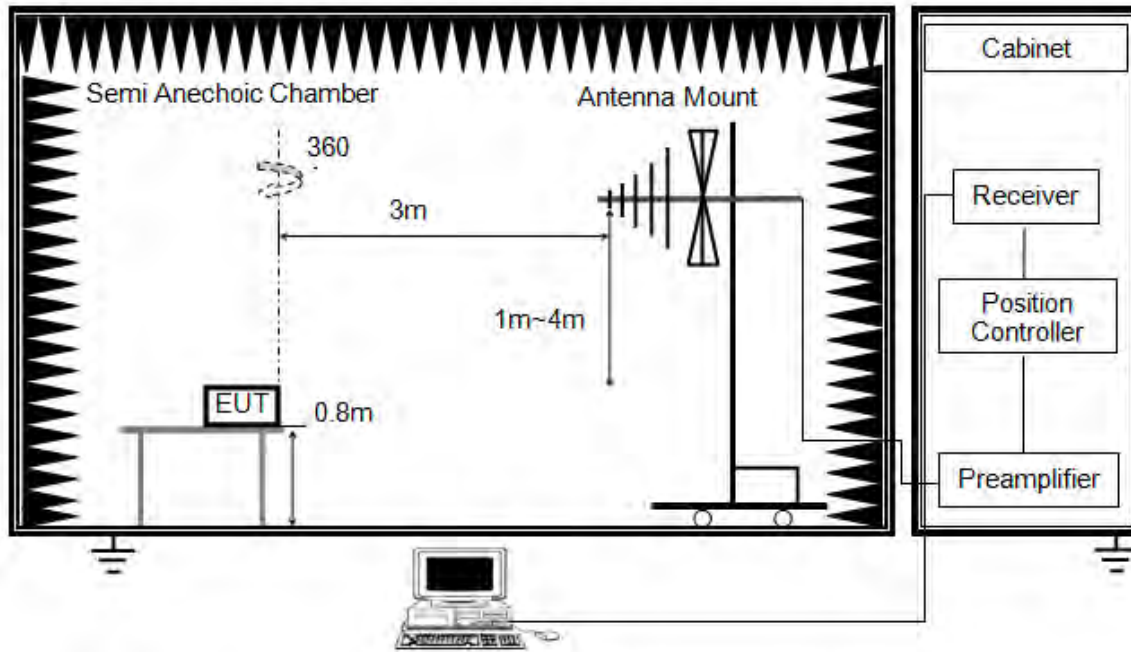

The setting of the spectrum analyser

RBW	120K
VBW	300K
Sweep	Auto
Detector	Peak/QP
Trace	Max hold

1. The testing follows the guidelines in ANSI C63.10-2013.
2. The EUT was arranged to its worst case and then tune the antenna tower (from 1 m to 4 m) and turntable (from 0 degree to 360 degrees) to find the maximum reading. A pre-amp and a high pass filter are used for the test in order to get better signal level. Both horizontal and vertical polarizations of the antenna are set to make the measurement.
3. The EUT was placed on a turntable with 0.8 meter above ground.
4. The EUT was set 3 meters from the interference receiving antenna, which was mounted on the top of a variable height antenna tower.
5. For measurement below 1GHz, the initial step in collecting conducted emission data is a spectrum analyzer peak detector mode pre-scanning the measurement frequency range. Significant peaks are then marked and then Quasi Peak detector mode re-measured. If the emission level of the EUT measured by the peak detector is 3 dB lower than the applicable limit, the peak emission level will be reported. Otherwise, the emission measurement will be repeated using the quasi-peak detector and reported.
6. For the actual test configuration, please refer to the related item in this test report (Photographs of the Test Configuration)

Above 1G

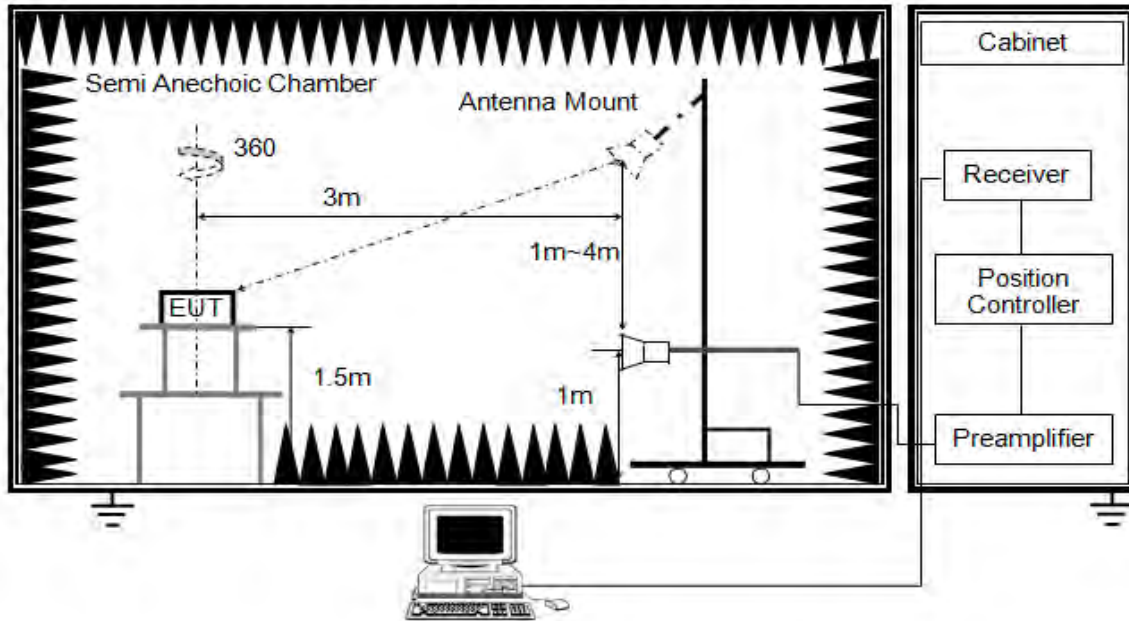

The setting of the spectrum analyser

RBW	1M
VBW	PEAK:3M AVG: See note6
Sweep	Auto
Detector	Peak/Average(10Hz)
Trace	Max hold

1. The testing follows the guidelines in ANSI C63.10-2013.
2. The EUT was arranged to its worst case and then tune the antenna tower (from 1 m to 4 m) and turntable (from 0 degree to 360 degrees) to find the maximum reading. A pre-amp and a high pass filter are used for the test in order to get better signal level. Both horizontal and vertical polarizations of the antenna are set to make the measurement.
3. The EUT was placed on a turntable with 1.5m above ground.
4. The EUT was set 3 meters from the interference receiving antenna, which was mounted on the top of a variable height antenna tower.
5. For measurement above 1GHz, the emission measurement will be measured by the peak detector. This peak level, once corrected, must comply with the limit specified in Section 15.209.
6. For measurements above 1 GHz the resolution bandwidth is set to 1 MHz, then the video bandwidth is set to 3 MHz for peak measurements and 1 MHz resolution bandwidth with set  $VBW \leq RBW/100$ , but not less than list in section 7.1 with average detector, max hold to run for at least 50 traces for average measurements.
7. For the actual test configuration, please refer to the related item in this test report (Photographs of the Test Configuration)



X axis, Y axis, Z axis positions:

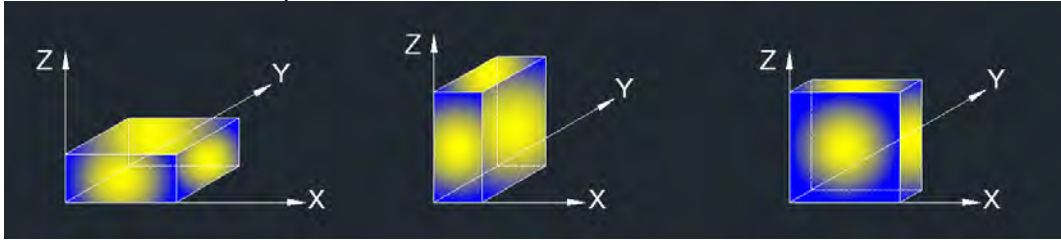

Note: For all radiated test, EUT in each of three orthogonal axis emissions had been tested, but only the worse case (Y axis) data recorded in the report.



### 7.6.2. TEST ENVIRONMENT

Temperature	20.0°C	Relative Humidity	56.1%
Atmosphere Pressure	103.1kPa	Test Date	2022-01-21

### 7.6.3. RESTRICTED BANDEDGE

#### TEST RESULT TABLE

Test Mode	Channel	Puw(dBm)	Verdict
11B	LCH	<Limit	PASS
	MCH	<Limit	PASS
	HCH	<Limit	PASS
11G	LCH	<Limit	PASS
	MCH	<Limit	PASS
	HCH	<Limit	PASS
11N HT20	LCH	<Limit	PASS
	MCH	<Limit	PASS
	HCH	<Limit	PASS
11N HT40	LCH	<Limit	PASS
	MCH	<Limit	PASS
	HCH	<Limit	PASS



**TEST GRAPHS**

Test Mode	Channel	Polarization	Verdict
11B	LCH	Horizontal	PASS

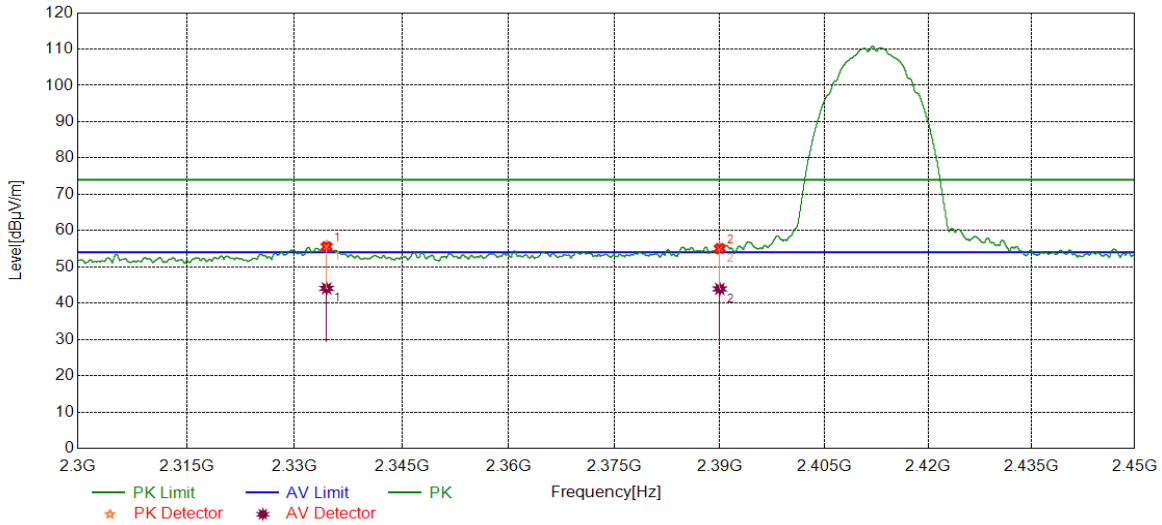

**PK Result:**

No.	Frequency	Reading Level	Correct Factor	Result	Limit	Margin	Remark
	[MHz]	[dBuV/m]	[dB]	[dBuV/m]	[dBuV/m]	[dB]	
1	2334.4668	43.2	12.53	55.73	74.00	-18.27	Horizontal
2	2390.0000	42.04	13.07	55.11	74.00	-18.89	Horizontal

**AV Result:**

No.	Frequency	Reading Level	Correct Factor	Result	Limit	Margin	Remark
	[MHz]	[dBuV/m]	[dB]	[dBuV/m]	[dBuV/m]	[dB]	
1	2334.4668	31.54	12.53	44.07	54.00	-9.93	Horizontal
2	2390.0000	30.86	13.07	43.93	54.00	-10.07	Horizontal

- Note: 1. Peak detector: RBW: 1 MHz, VBW: 3 MHz.  
 2. Average detector: RBW: 1 MHz, VBW: 1/T MHz(refer to clause 7.1.).  
 3. Measurement = Reading Level + Correct Factor.  
 4. Only the worst case emission was recorded, if it complies with the limit, the other emissions deemed to comply with the limit.



Test Mode	Channel	Polarization	Verdict
11B	LCH	Vertical	PASS

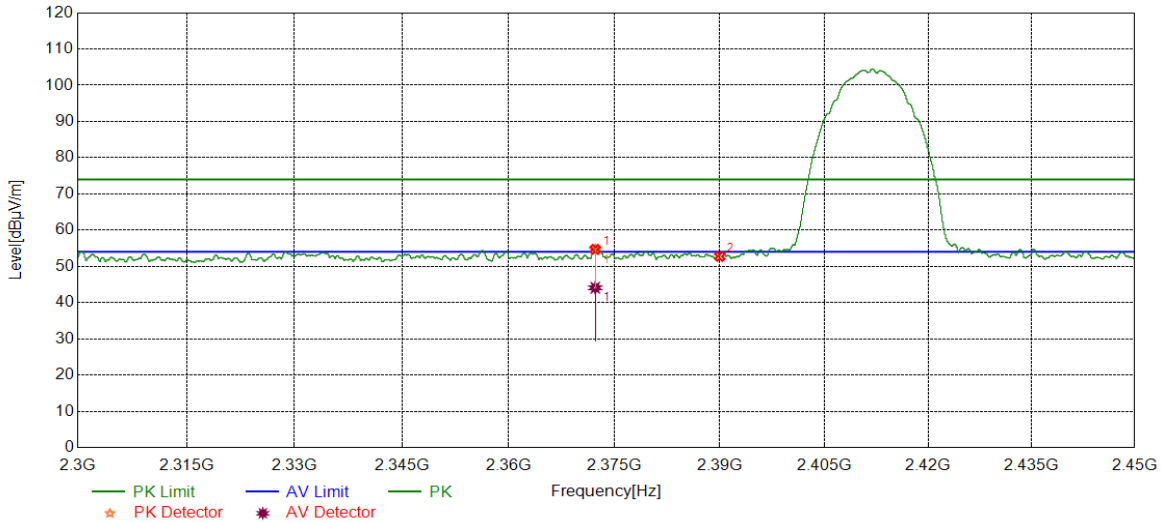

PK Result:

No.	Frequency	Reading Level	Correct Factor	Result	Limit	Margin	Remark
	[MHz]	[dBuV/m]	[dB]	[dBuV/m]	[dBuV/m]	[dB]	
1	2372.2715	41.62	12.96	54.58	74.00	-19.42	Vertical
2	2390.0000	39.67	13.07	52.74	74.00	-21.26	Vertical

AV Result:

No.	Frequency	Reading Level	Correct Factor	Result	Limit	Margin	Remark
	[MHz]	[dBuV/m]	[dB]	[dBuV/m]	[dBuV/m]	[dB]	
1	2372.2715	31.13	12.96	44.09	54.00	-9.91	Vertical

- Note: 1. Peak detector: RBW: 1 MHz, VBW: 3 MHz.  
 2. Average detector: RBW: 1 MHz, VBW: 1/T MHz(refer to clause 7.1.).  
 3. Measurement = Reading Level + Correct Factor.  
 4. Only the worst case emission was recorded, if it complies with the limit, the other emissions deemed to comply with the limit.



Test Mode	Channel	Polarization	Verdict
11B	HCH	Horizontal	PASS

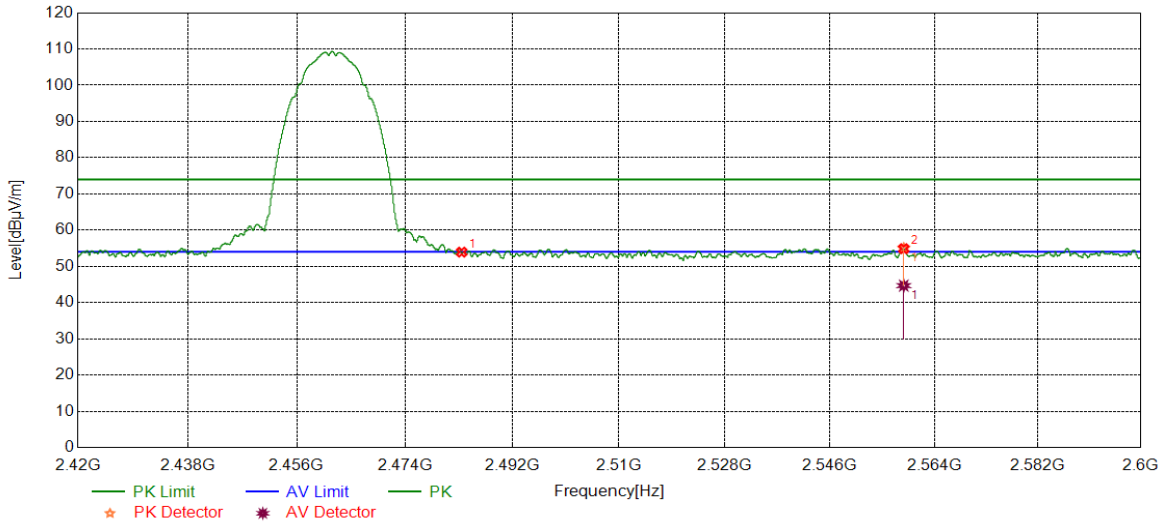

PK Result:

No.	Frequency	Reading Level	Correct Factor	Result	Limit	Margin	Remark
	[MHz]	[dBuV/m]	[dB]	[dBuV/m]	[dBuV/m]	[dB]	
1	2483.5000	40.96	12.97	53.93	74.00	-20.07	Horizontal
2	2558.7073	41.54	13.41	54.95	74.00	-19.05	Horizontal

AV Result:

No.	Frequency	Reading Level	Correct Factor	Result	Limit	Margin	Remark
	[MHz]	[dBuV/m]	[dB]	[dBuV/m]	[dBuV/m]	[dB]	
1	2558.7073	31.27	13.41	44.68	54.00	-9.32	Horizontal

- Note: 1. Peak detector: RBW: 1 MHz, VBW: 3 MHz.  
 2. Average detector: RBW: 1 MHz, VBW: 1/T MHz(refer to clause 7.1.).  
 3. Measurement = Reading Level + Correct Factor.  
 4. Only the worst case emission was recorded, if it complies with the limit, the other emissions deemed to comply with the limit.



Test Mode	Channel	Polarization	Verdict
11B	HCH	Vertical	PASS

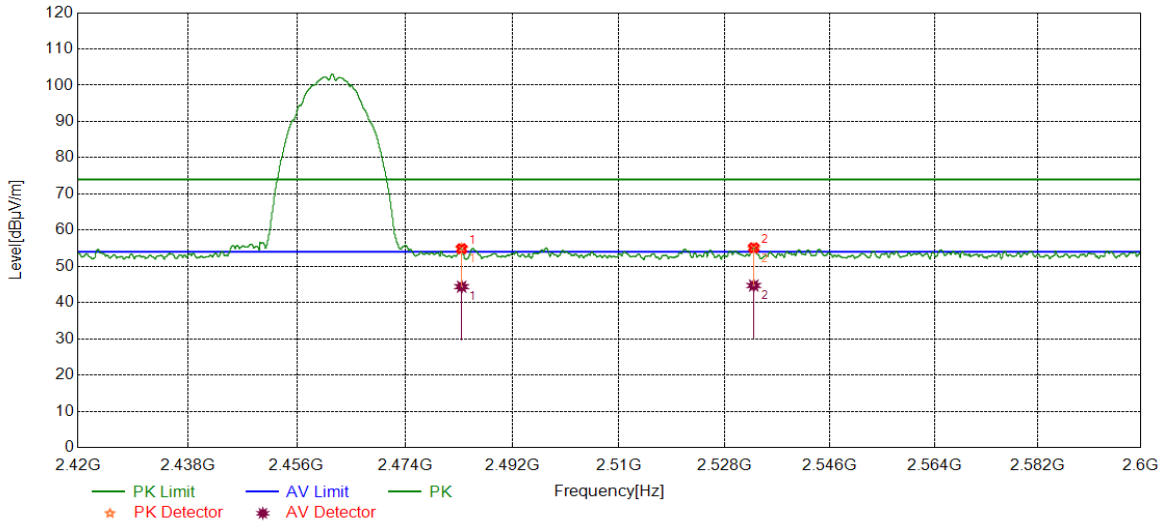

PK Result:

No.	Frequency	Reading Level	Correct Factor	Result	Limit	Margin	Remark
	[MHz]	[dBuV/m]	[dB]	[dBuV/m]	[dBuV/m]	[dB]	
1	2483.5000	41.88	12.97	54.85	74.00	-19.15	Vertical
2	2532.9416	41.47	13.42	54.89	74.00	-19.11	Vertical

AV Result:

No.	Frequency	Reading Level	Correct Factor	Result	Limit	Margin	Remark
	[MHz]	[dBuV/m]	[dB]	[dBuV/m]	[dBuV/m]	[dB]	
1	2483.5000	31.42	12.97	44.39	54.00	-9.61	Vertical
2	2532.9416	31.29	13.42	44.71	54.00	-9.29	Vertical

- Note: 1. Peak detector: RBW: 1 MHz, VBW: 3 MHz.  
 2. Average detector: RBW: 1 MHz, VBW: 1/T MHz(refer to clause 7.1.).  
 3. Measurement = Reading Level + Correct Factor.  
 4. Only the worst case emission was recorded, if it complies with the limit, the other emissions deemed to comply with the limit.



Test Mode	Channel	Polarization	Verdict
11G	LCH	Horizontal	PASS

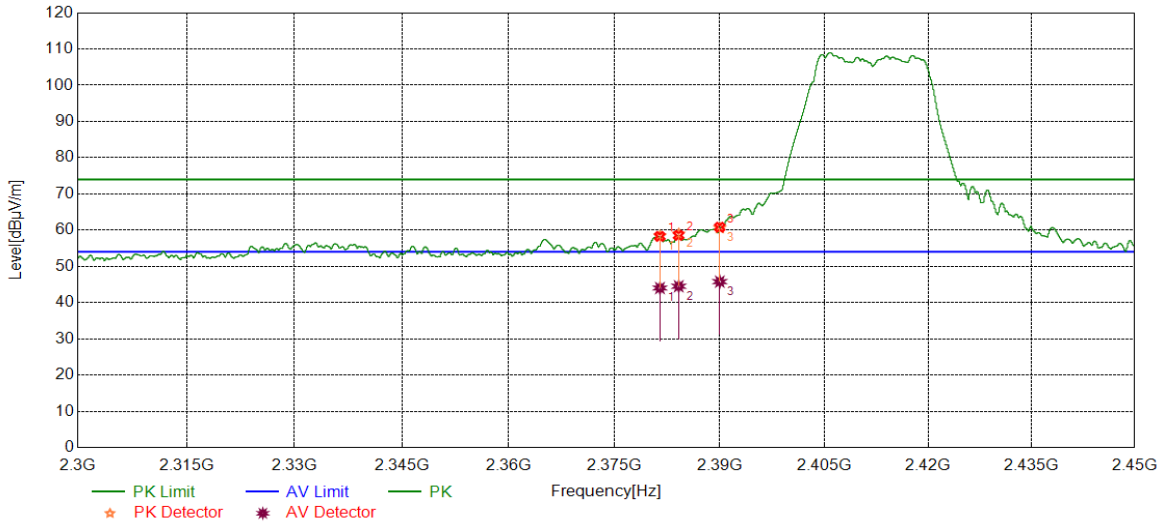

PK Result:

No.	Frequency	Reading Level	Correct Factor	Result	Limit	Margin	Remark
	[MHz]	[dBuV/m]	[dB]	[dBuV/m]	[dBuV/m]	[dB]	
1	2381.4643	45.34	13.06	58.40	74.00	-15.60	Horizontal
2	2384.1427	45.89	13.06	58.95	74.00	-15.05	Horizontal
3	2390.0000	47.54	13.07	60.61	74.00	-13.39	Horizontal

AV Result:

No.	Frequency	Reading Level	Correct Factor	Result	Limit	Margin	Remark
	[MHz]	[dBuV/m]	[dB]	[dBuV/m]	[dBuV/m]	[dB]	
1	2381.4643	30.96	13.06	44.02	54.00	-9.98	Horizontal
2	2384.1427	31.45	13.06	44.51	54.00	-9.49	Horizontal
3	2390.0000	32.71	13.07	45.78	54.00	-8.22	Horizontal

- Note: 1. Peak detector: RBW: 1 MHz, VBW: 3 MHz.  
 2. Average detector: RBW: 1 MHz, VBW: 1/T MHz(refer to clause 7.1.).  
 3. Measurement = Reading Level + Correct Factor.  
 4. Only the worst case emission was recorded, if it complies with the limit, the other emissions deemed to comply with the limit.



Test Mode	Channel	Polarization	Verdict
11G	LCH	Vertical	PASS

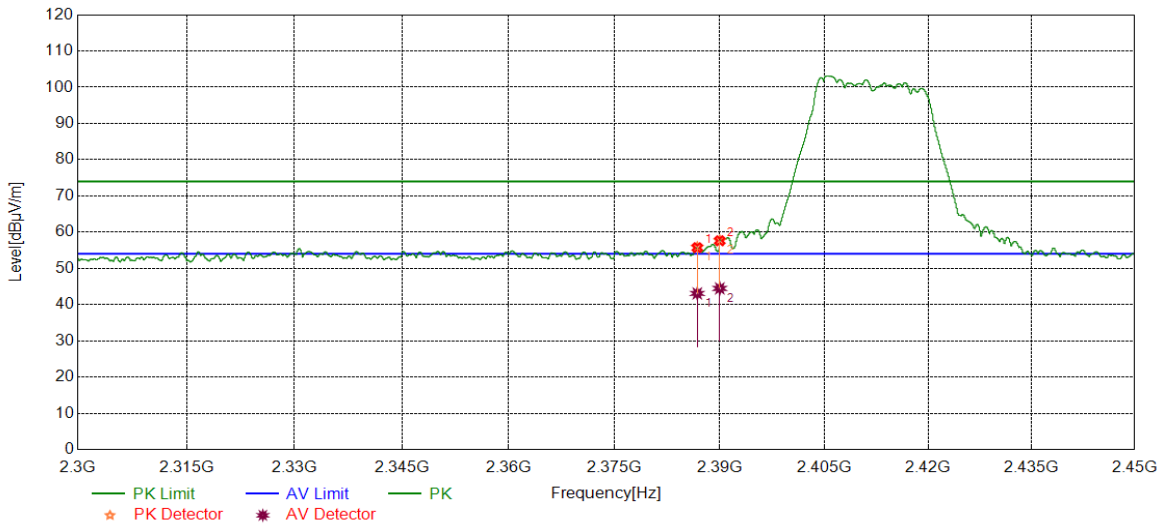

PK Result:

No.	Frequency	Reading Level	Correct Factor	Result	Limit	Margin	Remark
	[MHz]	[dBuV/m]	[dB]	[dBuV/m]	[dBuV/m]	[dB]	
1	2386.7858	42.74	13.06	55.80	74.00	-18.20	Vertical
2	2390.0000	44.56	13.07	57.63	74.00	-16.37	Vertical

AV Result:

No.	Frequency	Reading Level	Correct Factor	Result	Limit	Margin	Remark
	[MHz]	[dBuV/m]	[dB]	[dBuV/m]	[dBuV/m]	[dB]	
1	2386.7858	30.02	13.06	43.08	54.00	-10.92	Vertical
2	2390.0000	31.40	13.07	44.47	54.00	-9.53	Vertical

- Note: 1. Peak detector: RBW: 1 MHz, VBW: 3 MHz.  
 2. Average detector: RBW: 1 MHz, VBW: 1/T MHz(refer to clause 7.1.).  
 3. Measurement = Reading Level + Correct Factor.  
 4. Only the worst case emission was recorded, if it complies with the limit, the other emissions deemed to comply with the limit.





Test Mode	Channel	Polarization	Verdict
11G	HCH	Horizontal	PASS

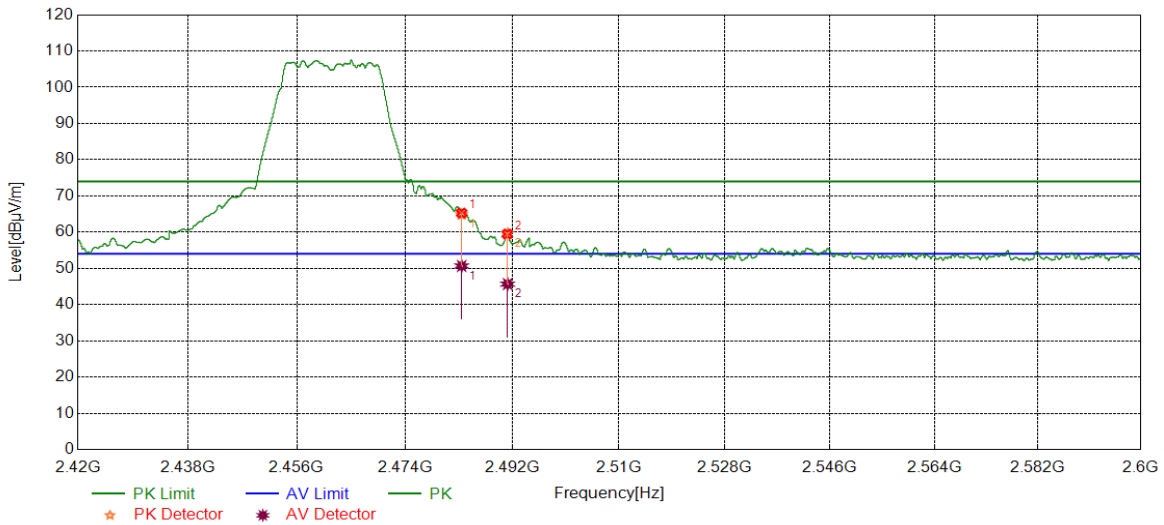

PK Result:

No.	Frequency	Reading Level	Correct Factor	Result	Limit	Margin	Remark
	[MHz]	[dBuV/m]	[dB]	[dBuV/m]	[dBuV/m]	[dB]	
1	2483.5000	51.91	12.97	64.88	74.00	-9.12	Horizontal
2	2491.2038	46.62	13.01	59.63	74.00	-14.37	Horizontal

AV Result:

No.	Frequency	Reading Level	Correct Factor	Result	Limit	Margin	Remark
	[MHz]	[dBuV/m]	[dB]	[dBuV/m]	[dBuV/m]	[dB]	
1	2483.5000	37.69	12.97	50.66	54.00	-3.34	Horizontal
2	2491.2038	32.65	13.01	45.66	54.00	-8.34	Horizontal

- Note: 1. Peak detector: RBW: 1 MHz, VBW: 3 MHz.  
 2. Average detector: RBW: 1 MHz, VBW: 1/T MHz(refer to clause 7.1.).  
 3. Measurement = Reading Level + Correct Factor.  
 4. Only the worst case emission was recorded, if it complies with the limit, the other emissions deemed to comply with the limit.



Test Mode	Channel	Polarization	Verdict
11G	HCH	Vertical	PASS

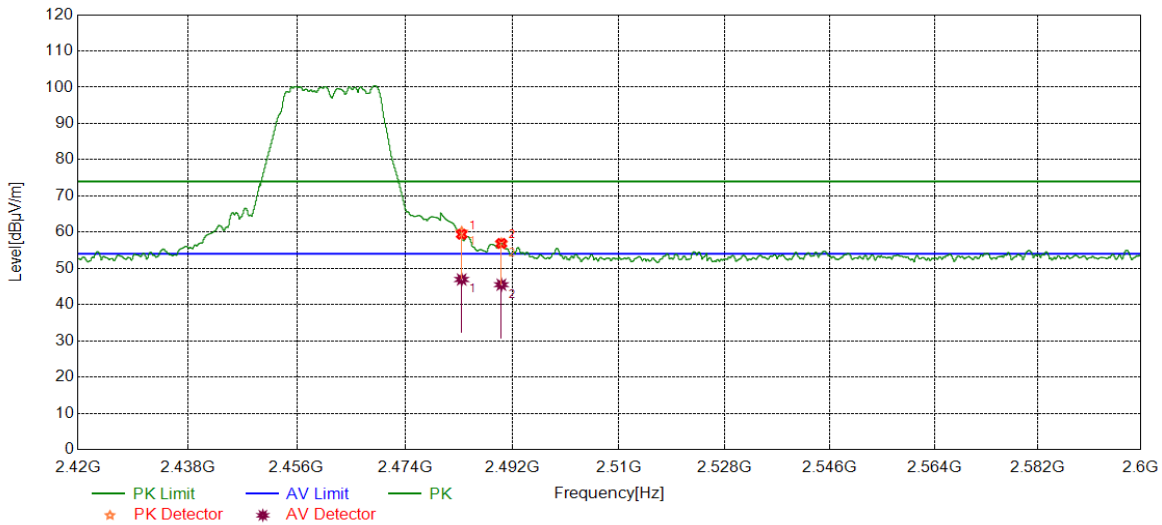

PK Result:

No.	Frequency	Reading Level	Correct Factor	Result	Limit	Margin	Remark
	[MHz]	[dBuV/m]	[dB]	[dBuV/m]	[dBuV/m]	[dB]	
1	2483.5000	47.05	12.97	60.02	74.00	-13.98	Vertical
2	2490.1638	43.83	13.00	56.83	74.00	-17.17	Vertical

AV Result:

No.	Frequency	Reading Level	Correct Factor	Result	Limit	Margin	Remark
	[MHz]	[dBuV/m]	[dB]	[dBuV/m]	[dBuV/m]	[dB]	
1	2483.5000	33.97	12.97	46.94	54.00	-7.06	Vertical
2	2490.1638	32.49	13.00	45.49	54.00	-8.51	Vertical

- Note: 1. Peak detector: RBW: 1 MHz, VBW: 3 MHz.  
 2. Average detector: RBW: 1 MHz, VBW: 1/T MHz(refer to clause 7.1.).  
 3. Measurement = Reading Level + Correct Factor.  
 4. Only the worst case emission was recorded, if it complies with the limit, the other emissions deemed to comply with the limit.



Test Mode	Channel	Polarization	Verdict
11N HT20	LCH	Horizontal	PASS

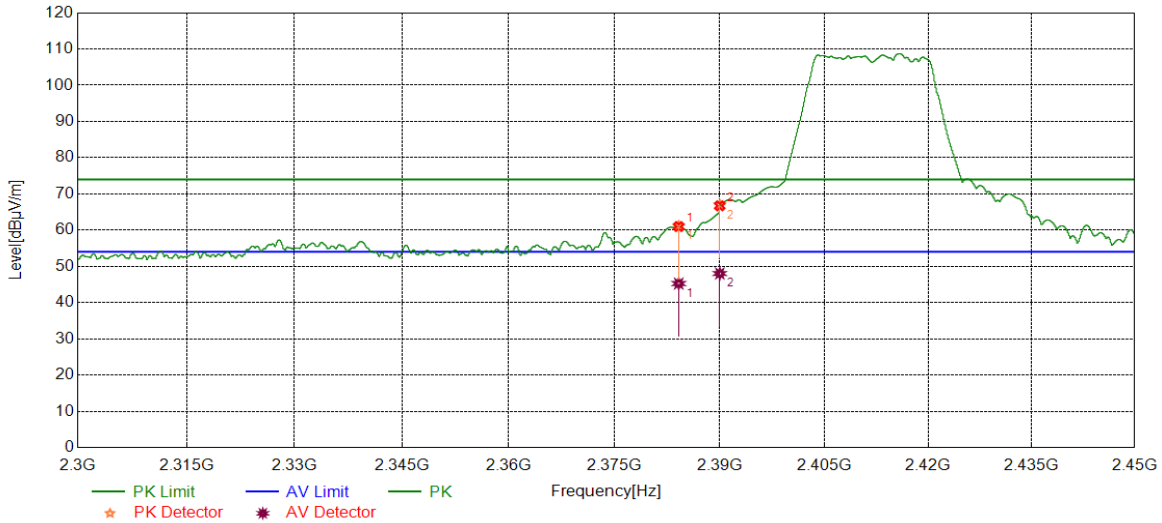

PK Result:

No.	Frequency	Reading Level	Correct Factor	Result	Limit	Margin	Remark
	[MHz]	[dBuV/m]	[dB]	[dBuV/m]	[dBuV/m]	[dB]	
1	2384.1418	48.05	13.06	61.11	74.00	-12.89	Horizontal
2	2390.0000	53.88	13.07	66.95	74.00	-7.05	Horizontal

AV Result:

No.	Frequency	Reading Level	Correct Factor	Result	Limit	Margin	Remark
	[MHz]	[dBuV/m]	[dB]	[dBuV/m]	[dBuV/m]	[dB]	
1	2384.1418	32.19	13.06	45.25	54.00	-8.75	Horizontal
2	2390.0000	34.96	13.07	48.03	54.00	-5.97	Horizontal

- Note: 1. Peak detector: RBW: 1 MHz, VBW: 3 MHz.  
 2. Average detector: RBW: 1 MHz, VBW: 1/T MHz(refer to clause 7.1.).  
 3. Measurement = Reading Level + Correct Factor.  
 4. Only the worst case emission was recorded, if it complies with the limit, the other emissions deemed to comply with the limit.



Test Mode	Channel	Polarization	Verdict
11N HT20	LCH	Vertical	PASS

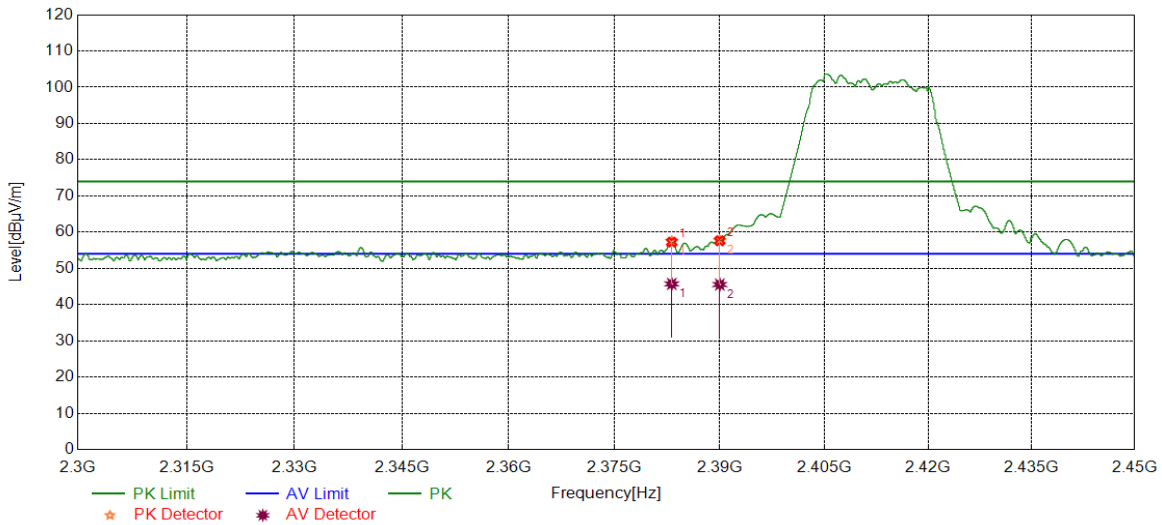

PK Result:

No.	Frequency	Reading Level	Correct Factor	Result	Limit	Margin	Remark
	[MHz]	[dBuV/m]	[dB]	[dBuV/m]	[dBuV/m]	[dB]	
1	2383.1479	44.37	13.06	57.43	74.00	-16.57	Vertical
2	2390.0000	44.56	13.07	57.63	74.00	-16.37	Vertical

AV Result:

No.	Frequency	Reading Level	Correct Factor	Result	Limit	Margin	Remark
	[MHz]	[dBuV/m]	[dB]	[dBuV/m]	[dBuV/m]	[dB]	
1	2383.1479	32.65	13.06	45.71	54.00	-8.29	Vertical
2	2390.0000	32.47	13.07	45.54	54.00	-8.46	Vertical

- Note: 1. Peak detector: RBW: 1 MHz, VBW: 3 MHz.  
 2. Average detector: RBW: 1 MHz, VBW: 1/T MHz(refer to clause 7.1.).  
 3. Measurement = Reading Level + Correct Factor.  
 4. Only the worst case emission was recorded, if it complies with the limit, the other emissions deemed to comply with the limit.



Test Mode	Channel	Polarization	Verdict
11N HT20	HCH	Horizontal	PASS

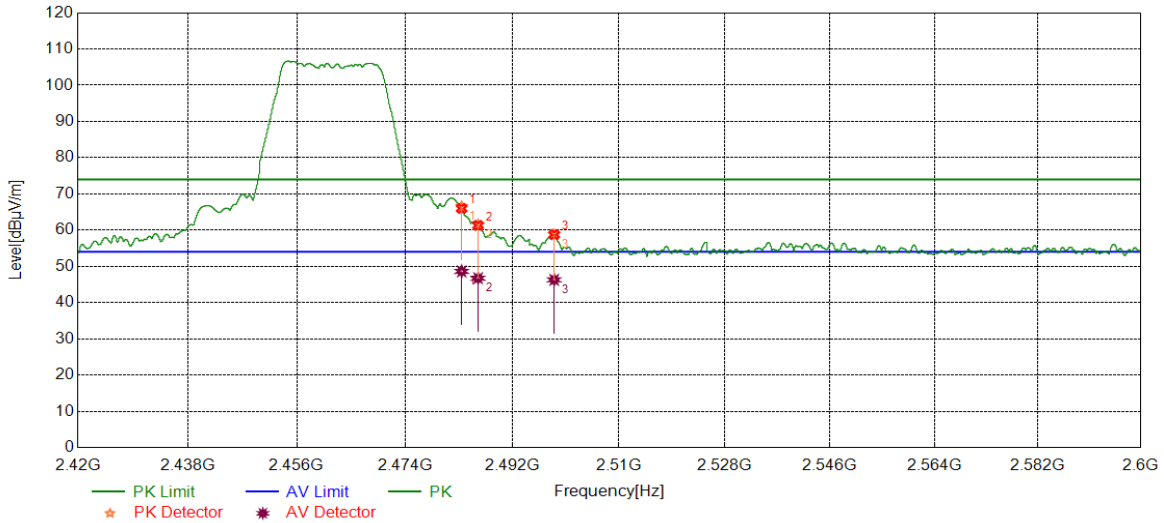

PK Result:

No.	Frequency	Reading Level	Correct Factor	Result	Limit	Margin	Remark
	[MHz]	[dBuV/m]	[dB]	[dBuV/m]	[dBuV/m]	[dB]	
1	2483.5000	53.53	12.97	66.50	74.00	-7.50	Horizontal
2	2486.2483	48.5	12.98	61.48	74.00	-12.52	Horizontal
3	2499.0524	45.68	13.13	58.81	74.00	-15.19	Horizontal

AV Result:

No.	Frequency	Reading Level	Correct Factor	Result	Limit	Margin	Remark
	[MHz]	[dBuV/m]	[dB]	[dBuV/m]	[dBuV/m]	[dB]	
1	2483.5000	35.64	12.97	48.61	54.00	-5.39	Horizontal
2	2486.2483	33.76	12.98	46.74	54.00	-7.26	Horizontal
3	2499.0524	33.15	13.13	46.28	54.00	-7.72	Horizontal

- Note: 1. Peak detector: RBW: 1 MHz, VBW: 3 MHz.  
 2. Average detector: RBW: 1 MHz, VBW: 1/T MHz(refer to clause 7.1.).  
 3. Measurement = Reading Level + Correct Factor.  
 4. Only the worst case emission was recorded, if it complies with the limit, the other emissions deemed to comply with the limit.



Test Mode	Channel	Polarization	Verdict
11N HT20	HCH	Vertical	PASS

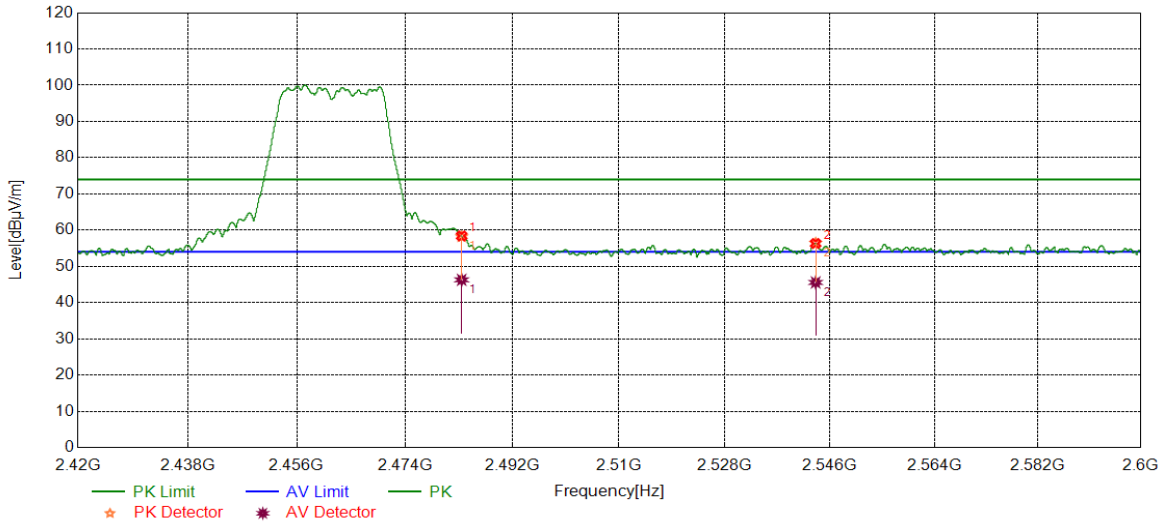

PK Result:

No.	Frequency	Reading Level	Correct Factor	Result	Limit	Margin	Remark
	[MHz]	[dBuV/m]	[dB]	[dBuV/m]	[dBuV/m]	[dB]	
1	2483.5000	45.23	12.97	58.20	74.00	-15.80	Vertical
2	2543.5404	43.02	13.39	56.41	74.00	-17.59	Vertical

AV Result:

No.	Frequency	Reading Level	Correct Factor	Result	Limit	Margin	Remark
	[MHz]	[dBuV/m]	[dB]	[dBuV/m]	[dBuV/m]	[dB]	
1	2483.5000	33.31	12.97	46.28	54.00	-7.72	Vertical
2	2543.5404	32.17	13.39	45.56	54.00	-8.44	Vertical

- Note: 1. Peak detector: RBW: 1 MHz, VBW: 3 MHz.  
 2. Average detector: RBW: 1 MHz, VBW: 1/T MHz(refer to clause 7.1.).  
 3. Measurement = Reading Level + Correct Factor.  
 4. Only the worst case emission was recorded, if it complies with the limit, the other emissions deemed to comply with the limit.



Test Mode	Channel	Polarization	Verdict
11N HT40	LCH	Horizontal	PASS

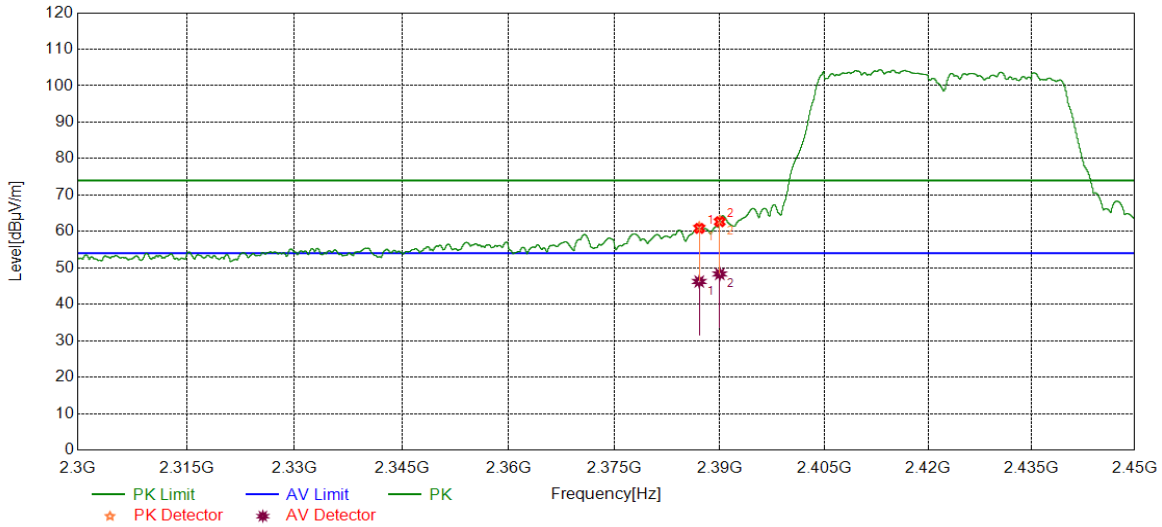

PK Result:

No.	Frequency	Reading Level	Correct Factor	Result	Limit	Margin	Remark
	[MHz]	[dBuV/m]	[dB]	[dBuV/m]	[dBuV/m]	[dB]	
1	2387.0661	49.08	13.06	61.14	74.00	-11.86	Horizontal
2	2390.0000	51.80	13.07	62.87	74.00	-9.13	Horizontal

AV Result:

No.	Frequency	Reading Level	Correct Factor	Result	Limit	Margin	Remark
	[MHz]	[dBuV/m]	[dB]	[dBuV/m]	[dBuV/m]	[dB]	
1	2387.0661	33.19	13.06	46.25	54.00	-7.75	Horizontal
2	2390.0000	35.25	13.07	48.32	54.00	-5.68	Horizontal

- Note: 1. Peak detector: RBW: 1 MHz, VBW: 3 MHz.  
 2. Average detector: RBW: 1 MHz, VBW: 1/T MHz(refer to clause 7.1.).  
 3. Measurement = Reading Level + Correct Factor.  
 4. Only the worst case emission was recorded, if it complies with the limit, the other emissions deemed to comply with the limit.



Test Mode	Channel	Polarization	Verdict
11N HT40	LCH	Vertical	PASS

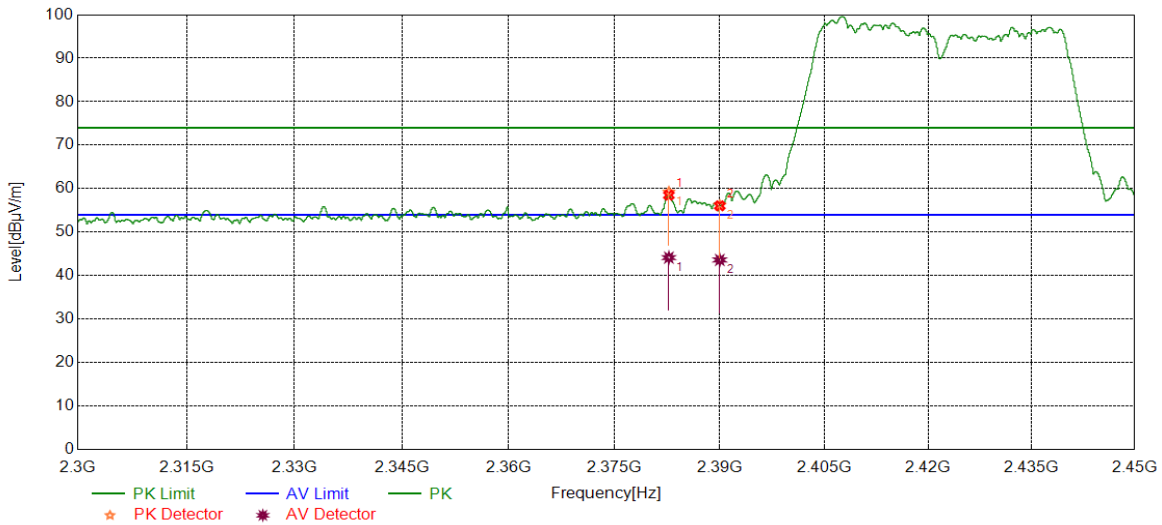

PK Result:

No.	Frequency	Reading Level	Correct Factor	Result	Limit	Margin	Remark
	[MHz]	[dBuV/m]	[dB]	[dBuV/m]	[dBuV/m]	[dB]	
1	2382.7328	46.15	13.07	59.22	74.00	-14.78	Vertical
2	2390.0000	43.1	13.07	56.17	74.00	-17.83	Vertical

AV Result:

No.	Frequency	Reading Level	Correct Factor	Result	Limit	Margin	Remark
	[MHz]	[dBuV/m]	[dB]	[dBuV/m]	[dBuV/m]	[dB]	
1	2382.7328	31.07	13.07	44.14	54.00	-9.86	Vertical
2	2390.0000	30.54	13.07	43.61	54.00	-10.39	Vertical

- Note: 1. Peak detector: RBW: 1 MHz, VBW: 3 MHz.  
 2. Average detector: RBW: 1 MHz, VBW: 1/T MHz(refer to clause 7.1.).  
 3. Measurement = Reading Level + Correct Factor.  
 4. Only the worst case emission was recorded, if it complies with the limit, the other emissions deemed to comply with the limit.





Test Mode	Channel	Polarization	Verdict
11N HT40	HCH	Horizontal	PASS

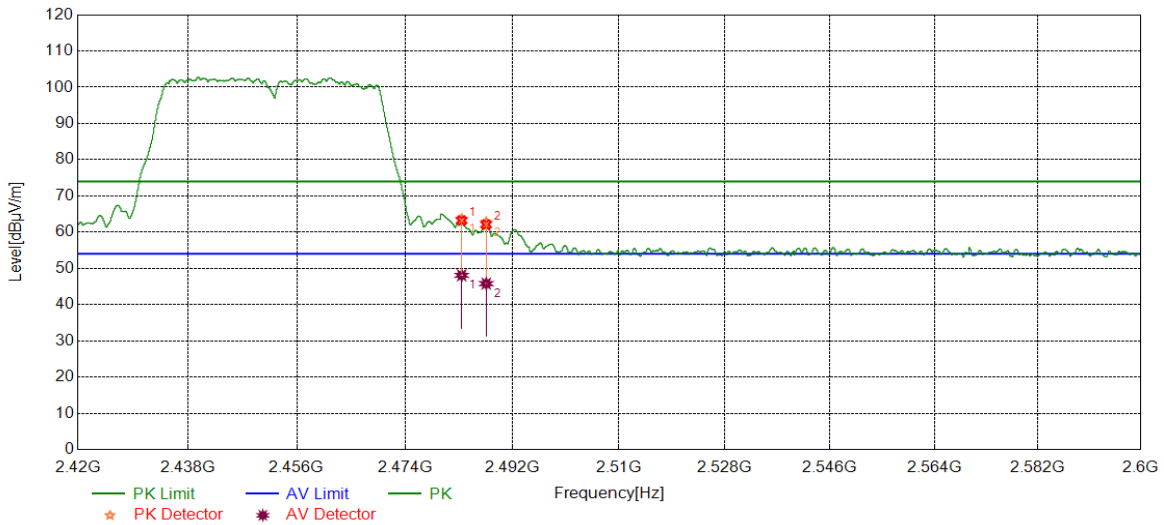

PK Result:

No.	Frequency	Reading Level	Correct Factor	Result	Limit	Margin	Remark
	[MHz]	[dBuV/m]	[dB]	[dBuV/m]	[dBuV/m]	[dB]	
1	2483.5000	50.57	12.97	63.54	74.00	-10.46	Horizontal
2	2487.6201	49.68	12.98	62.66	74.00	-11.34	Horizontal

AV Result:

No.	Frequency	Reading Level	Correct Factor	Result	Limit	Margin	Remark
	[MHz]	[dBuV/m]	[dB]	[dBuV/m]	[dBuV/m]	[dB]	
1	2483.5000	35.11	12.97	48.08	54.00	-5.92	Horizontal
2	2487.6201	32.81	12.98	45.79	54.00	-8.21	Horizontal

- Note: 1. Peak detector: RBW: 1 MHz, VBW: 3 MHz.  
 2. Average detector: RBW: 1 MHz, VBW: 1/T MHz(refer to clause 7.1.).  
 3. Measurement = Reading Level + Correct Factor.  
 4. Only the worst case emission was recorded, if it complies with the limit, the other emissions deemed to comply with the limit.



Test Mode	Channel	Polarization	Verdict
11N HT40	HCH	Vertical	PASS

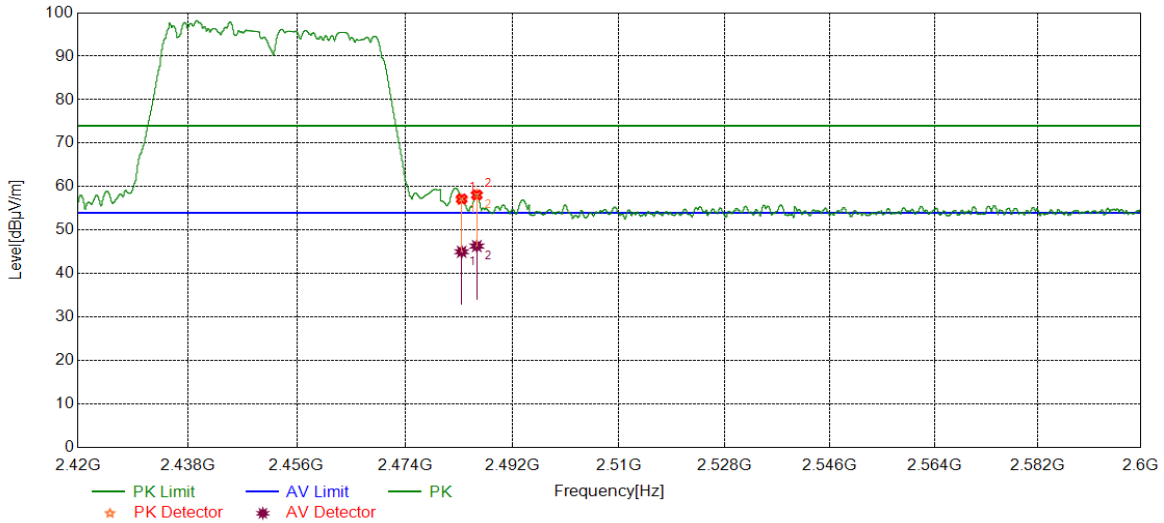

PK Result:

No.	Frequency	Reading Level	Correct Factor	Result	Limit	Margin	Remark
	[MHz]	[dBuV/m]	[dB]	[dBuV/m]	[dBuV/m]	[dB]	
1	2483.5000	44	12.97	56.97	74.00	-17.03	Vertical
2	2486.0458	45.16	12.98	58.14	74.00	-15.86	Vertical

AV Result:

No.	Frequency	Reading Level	Correct Factor	Result	Limit	Margin	Remark
	[MHz]	[dBuV/m]	[dB]	[dBuV/m]	[dBuV/m]	[dB]	
1	2483.5000	32.06	12.97	45.03	54.00	-8.97	Vertical
2	2486.0458	33.35	12.98	46.33	54.00	-7.67	Vertical

- Note: 1. Peak detector: RBW: 1 MHz, VBW: 3 MHz.  
 2. Average detector: RBW: 1 MHz, VBW: 1/T MHz(refer to clause 7.1.).  
 3. Measurement = Reading Level + Correct Factor.  
 4. Only the worst case emission was recorded, if it complies with the limit, the other emissions deemed to comply with the limit.



## 7.6.4. SPURIOUS EMISSIONS

### TEST RESULTS TABLE

1) For 1GHz~18GHz

Test Mode	Channel	Puw(dBm)	Verdict
11B	LCH	<Limit	PASS
	MCH	<Limit	PASS
	HCH	<Limit	PASS
11G	LCH	<Limit	PASS
	MCH	<Limit	PASS
	HCH	<Limit	PASS
11N HT20	LCH	<Limit	PASS
	MCH	<Limit	PASS
	HCH	<Limit	PASS
11N HT40	LCH	<Limit	PASS
	MCH	<Limit	PASS
	HCH	<Limit	PASS

2) For 9KHz~30MHz

Test Mode	Channel	Puw(dBm)	Verdict
11B	LCH	<Limit	PASS

Remark:

1) Through pre-testing all the test modes and test channels, but only the data of the worst case is included in this test report.

3) For 30MHz~1GHz

Test Mode	Channel	Puw(dBm)	Verdict
11B	LCH	<Limit	PASS

Remark:

1) Through pre-testing all the test modes and test channels, but only the data of the worst case is included in this test report.

4) For 18GHz~26.5GHz

Test Mode	Channel	Puw(dBm)	Verdict
11B	LCH	<Limit	PASS

Remark:

1) Through pre-testing all the test modes and test channels, but only the data of the worst case is included in this test report.



**Part I: 1GHz~3GHz**

**HARMONICS AND SPURIOUS EMISSIONS**

Test Mode	Channel	Polarization	Verdict
11B	LCH	Horizontal	PASS

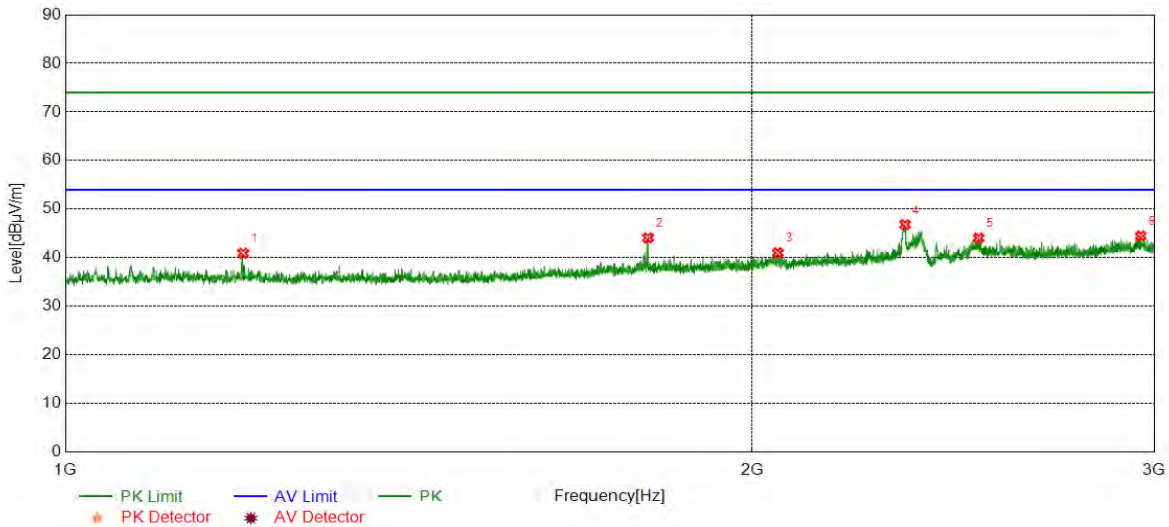

No.	Frequency	Reading Level	Correct Factor	Result	Limit	Margin	Remark
	[MHz]	[dBuV/m]	[dB]	[dBuV/m]	[dBuV/m]	[dB]	
1	1196.5000	46.48	-5.56	40.92	74.00	-33.08	Horizontal
2	1800.2500	47.93	-3.85	44.08	74.00	-29.92	Horizontal
3	2052.0000	43.45	-2.43	41.02	74.00	-32.98	Horizontal
4	2333.2500	48.63	-1.82	46.81	74.00	-27.19	Horizontal
5	2513.0000	44.43	-0.37	44.06	74.00	-29.94	Horizontal
6	2959.7500	43.49	0.99	44.48	74.00	-29.52	Horizontal

- Note: 1. Measurement = Reading Level + Correct Factor.  
 2. If Peak Result complies with AV limit, AV Result is deemed to comply with AV limit.  
 3. Test setup: RBW: 1 MHz, VBW: 3 MHz, Sweep time: auto.  
 4. Peak: Peak detector.  
 5. For below 3GHz part, filter losses were only considered in the spurious frequency bands and the authorized band was not corrected for Band Reject Filter losses.  
 6. Only the worst case emission was recorded, if it complies with the limit, the other emissions deemed to comply with the limit.



Test Mode	Channel	Polarization	Verdict
11B	LCH	Vertical	PASS

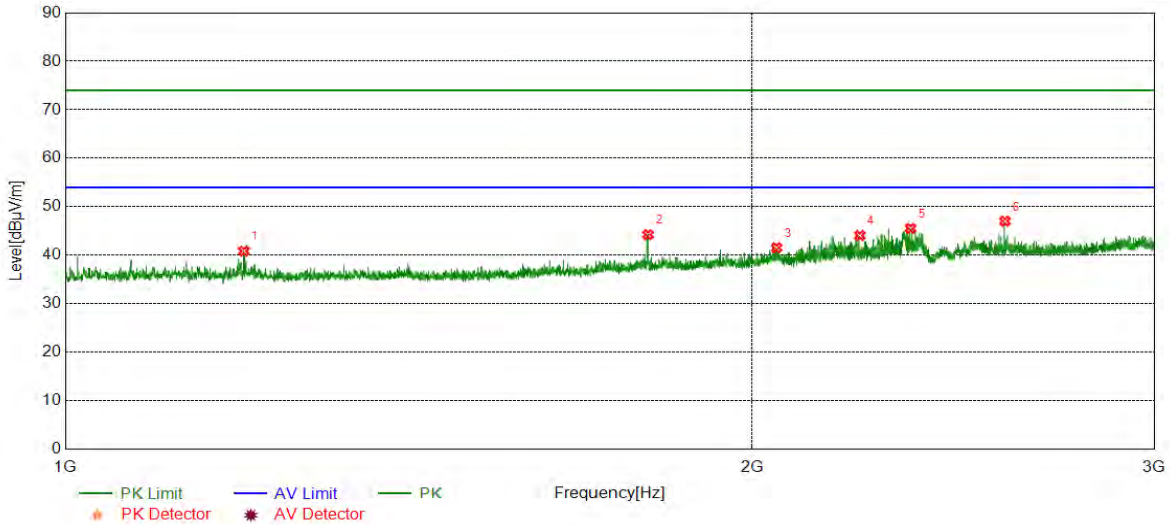

No.	Frequency	Reading Level	Correct Factor	Result	Limit	Margin	Remark
	[MHz]	[dBuV/m]	[dB]	[dBuV/m]	[dBuV/m]	[dB]	
1	1197.5000	46.41	-5.56	40.85	74.00	-33.15	Vertical
2	1800.2500	48.09	-3.85	44.24	74.00	-29.76	Vertical
3	2049.5000	43.93	-2.38	41.55	74.00	-32.45	Vertical
4	2229.2500	46.24	-2.17	44.07	74.00	-29.93	Vertical
5	2346.2500	47.28	-1.73	45.55	74.00	-28.45	Vertical
6	2580.7500	47.97	-0.96	47.01	74.00	-26.99	Vertical

- Note: 1. Measurement = Reading Level + Correct Factor.  
 2. If Peak Result complies with AV limit, AV Result is deemed to comply with AV limit.  
 3. Test setup: RBW: 1 MHz, VBW: 3 MHz, Sweep time: auto.  
 4. Peak: Peak detector.  
 5. For below 3GHz part, filter losses were only considered in the spurious frequency bands and the authorized band was not corrected for Band Reject Filter losses.  
 6. Only the worst case emission was recorded, if it complies with the limit, the other emissions deemed to comply with the limit.