

# 1 Cover Page

# TEST REPORT

**Application No.:** SHEM2106006039CR  
**FCC ID:** SVN-ARC3000H-W2  
**Applicant:** Zhejiang Dahua Vision Technology Co., Ltd  
**Address of Applicant:** No.1199, Bin'an Road, Binjiang District, Hangzhou, P.R. 310053 China  
**Manufacturer:** Zhejiang Dahua Vision Technology Co., Ltd  
**Address of Manufacturer:** No.1199, Bin'an Road, Binjiang District, Hangzhou, P.R. 310053 China  
**Equipment Under Test (EUT):**  
**EUT Name:** Alarm Hub  
**Model No.:** DHI-ARC3000H-FW2;ARC3000H-FW2;DH-ARC3000H-FW2;DHI-ARC3000H-GW2;ARC3000H-GW2;DH-ARC3000H-GW2;DHI-ARC3000H-W2; ARC3000H-W2;DH-ARC3000H-W2

☐ Please refer to section 2 of this report which indicates which model was actually tested and which were electrically identical.

**Standard(s) :** 47 CFR Part 15, Subpart C 15.231  
**Date of Receipt:** 2021-06-11  
**Date of Test:** 2021-06-14 to 2021-06-15  
**Date of Issue:** 2021-06-16

<b>Test Result:</b>	<b>Pass*</b>
---------------------	--------------

\* In the configuration tested, the EUT complied with the standards specified above.

*Parlan Zhan*

Parlan Zhan  
Laboratory Manager

The manufacturer should ensure that all products in series production are in conformity with the product sample detailed in this report. If the product in this report is used in any configuration other than that detailed in the report, the manufacturer must ensure the new system complies with all relevant standards. Any mention of SGS International Electrical Approvals or testing done by SGS International Electrical Approvals in connection with, distribution or use of the product described in this report must be approved by SGS International Electrical Approvals in writing.



Unless otherwise agreed in writing, this document is issued by the Company subject to its General Conditions of Service printed overleaf, available on request or accessible at <http://www.sgs.com/en/Terms-and-Conditions.aspx> and, for electronic format documents, subject to Terms and Conditions for Electronic Documents at <http://www.sgs.com/en/Terms-and-Conditions/Terms-e-Documents.aspx>. Attention is drawn to the limitation of liability, indemnification and jurisdiction issues defined therein. Any holder of this document is advised that information contained hereon reflects the Company's findings at the time of its intervention only and within the limits of Client's instructions, if any. The Company's sole responsibility is to its Client and this document does not exonerate parties to a transaction from exercising all their rights and obligations under the transaction documents. This document cannot be reproduced except in full, without prior written approval of the Company. Any unauthorized alteration, forgery or falsification of the content or appearance of this document is unlawful and offenders may be prosecuted to the fullest extent of the law. Unless otherwise stated the results shown in this test report refer only to the sample(s) tested and such sample(s) are retained for 30 days only.

**Attention: To check the authenticity of testing / inspection report & certificate, please contact us at telephone: (86-755) 8307 1443, or email: CN.Doccheck@sgs.com**



Revision Record			
Version	Description	Date	Remark
00	Original	2021-06-16	/

Authorized for issue by:			
		<i>Michael Niu</i>	
		<b>Micheal Niu / Project Engineer</b>	
		<i>Parlam zhan</i>	
		<b>Parlam Zhan / Reviewer</b>	



Unless otherwise agreed in writing, this document is issued by the Company subject to its General Conditions of Service printed overleaf, available on request or accessible at <http://www.sgs.com/en/Terms-and-Conditions.aspx> and, for electronic format documents, subject to Terms and Conditions for Electronic Documents at <http://www.sgs.com/en/Terms-and-Conditions/Terms-e-Documents.aspx>. Attention is drawn to the limitation of liability, indemnification and jurisdiction issues defined therein. Any holder of this document is advised that information contained hereon reflects the Company's findings at the time of its intervention only and within the limits of Client's instructions, if any. The Company's sole responsibility is to its Client and this document does not exonerate parties to a transaction from exercising all their rights and obligations under the transaction documents. This document cannot be reproduced except in full, without prior written approval of the Company. Any unauthorized alteration, forgery or falsification of the content or appearance of this document is unlawful and offenders may be prosecuted to the fullest extent of the law. Unless otherwise stated the results shown in this test report refer only to the sample(s) tested and such sample(s) are retained for 30 days only.

Attention: To check the authenticity of testing /inspection report & certificate, please contact us at telephone: (86-755) 8307 1443, or email: [CN.Doccheck@sgs.com](mailto:CN.Doccheck@sgs.com)

## 2 Test Summary

Test Item	FCC Requirement	Test method	Result
Antenna Requirement	Part 15.203	/	PASS
Conducted Emission	Part 15.207	ANSI C63.10 (2013) Section 6.2	PASS
Field Strength of the Fundamental	Part 15.231 (b)	ANSI C63.10 (2013) Section 6.4	PASS
Radiated Spurious emissions	Part 15.209 15.231(b)	ANSI C63.10 (2013) Section 6.4&6.5&6.6	PASS
20dB Bandwidth	Part 15.231 (c)	ANSI C63.10 (2013) Section 6.9.2	PASS
Dwell Time	Part 15.231 (a)	ANSI C63.10 (2013) Section 7.8.4	PASS

### Declaration of EUT Family Grouping:

Note: There are series models mentioned in this report, and they are the similar in electrical and electronic characters. Only the model DHI-ARC3000H-FW2 was tested since their differences were the model number and appearance.



Unless otherwise agreed in writing, this document is issued by the Company subject to its General Conditions of Service printed overleaf, available on request or accessible at <http://www.sgs.com/en/Terms-and-Conditions.aspx> and, for electronic format documents, subject to Terms and Conditions for Electronic Documents at <http://www.sgs.com/en/Terms-and-Conditions/Terms-e-Documents.aspx>. Attention is drawn to the limitation of liability, indemnification and jurisdiction issues defined therein. Any holder of this document is advised that information contained hereon reflects the Company's findings at the time of its intervention only and within the limits of Client's instructions, if any. The Company's sole responsibility is to its Client and this document does not exonerate parties to a transaction from exercising all their rights and obligations under the transaction documents. This document cannot be reproduced except in full, without prior written approval of the Company. Any unauthorized alteration, forgery or falsification of the content or appearance of this document is unlawful and offenders may be prosecuted to the fullest extent of the law. Unless otherwise stated the results shown in this test report refer only to the sample(s) tested and such sample(s) are retained for 30 days only.

Attention: To check the authenticity of testing /inspection report & certificate, please contact us at telephone: (86-755) 8307 1443, or email: [CN.Doccheck@sgs.com](mailto:CN.Doccheck@sgs.com)



### 3 Contents

	Page
1 COVER PAGE.....	1
2 TEST SUMMARY.....	3
3 CONTENTS .....	4
4 GENERAL INFORMATION.....	5
4.1 GENERAL DESCRIPTION OF E.U.T. ....	5
4.2 TECHNICAL SPECIFICATIONS:.....	5
4.3 DESCRIPTION OF SUPPORT UNITS.....	5
4.4 TEST LOCATION .....	6
4.5 TEST FACILITY .....	6
4.6 MEASUREMENT UNCERTAINTY .....	7
5 EQUIPMENTS USED DURING TEST .....	8
6 TEST RESULTS AND MEASUREMENT DATA .....	10
6.1 ANTENNA REQUIREMENT .....	10
6.2 CONDUCTED EMISSIONS AT AC POWER LINE (150kHz-30MHz) .....	11
<b>6.2.1</b> E.U.T. Operation.....	11
<b>6.2.2</b> Test Setup Diagram.....	11
<b>6.2.3</b> Measurement Procedure and Data .....	12
6.3 SPURIOUS EMISSIONS .....	15
<b>6.3.1</b> Field Strength of the Fundamental Signal .....	17
<b>6.3.2</b> Spurious Emissions .....	19
6.4 20DB BANDWIDTH .....	26
6.5 DWELL TIME .....	30
7 TEST SETUP PHOTOGRAPHS .....	34
8 EUT CONSTRUCTIONAL DETAILS .....	34



Unless otherwise agreed in writing, this document is issued by the Company subject to its General Conditions of Service printed overleaf, available on request or accessible at <http://www.sgs.com/en/Terms-and-Conditions.aspx> and, for electronic format documents, subject to Terms and Conditions for Electronic Documents at <http://www.sgs.com/en/Terms-and-Conditions/Terms-e-Documents.aspx>. Attention is drawn to the limitation of liability, indemnification and jurisdiction issues defined therein. Any holder of this document is advised that information contained hereon reflects the Company's findings at the time of its intervention only and within the limits of Client's instructions, if any. The Company's sole responsibility is to its Client and this document does not exonerate parties to a transaction from exercising all their rights and obligations under the transaction documents. This document cannot be reproduced except in full, without prior written approval of the Company. Any unauthorized alteration, forgery or falsification of the content or appearance of this document is unlawful and offenders may be prosecuted to the fullest extent of the law. Unless otherwise stated the results shown in this test report refer only to the sample(s) tested and such sample(s) are retained for 30 days only.

Attention: To check the authenticity of testing /inspection report & certificate, please contact us at telephone: (86-755) 8307 1443, or email: [CN.Doccheck@sgs.com](mailto:CN.Doccheck@sgs.com)

## 4 General Information

### 4.1 General Description of E.U.T.

Power supply:	DC 12V by adapter Adapter model:EVSF+24120-1500 Input:100-240V 50/60Hz 0.6A Output :12V 1.5A  DC 3.6V by two Li-ion batteries Battery information: Model:MZ852LI Rating:3.6V,2150mAh Charge Threshold:4.2V
Test voltage:	AC 120V/60Hz

### 4.2 Technical Specifications:

Modulation Type	FSK
Number of Channels	3
Operation Frequency	433.1MHz-434.6MHz
Antenna Type	Spring Antenna

### 4.3 Description of Support Units

Description	Manufacturer	Model No.	Serial No.
Note Book	LENOVO	Y510P	SZSMT55INP141501639



Unless otherwise agreed in writing, this document is issued by the Company subject to its General Conditions of Service printed overleaf, available on request or accessible at <http://www.sgs.com/en/Terms-and-Conditions.aspx> and, for electronic format documents, subject to Terms and Conditions for Electronic Documents at <http://www.sgs.com/en/Terms-and-Conditions/Terms-e-Documents.aspx>. Attention is drawn to the limitation of liability, indemnification and jurisdiction issues defined therein. Any holder of this document is advised that information contained hereon reflects the Company's findings at the time of its intervention only and within the limits of Client's instructions, if any. The Company's sole responsibility is to its Client and this document does not exonerate parties to a transaction from exercising all their rights and obligations under the transaction documents. This document cannot be reproduced except in full, without prior written approval of the Company. Any unauthorized alteration, forgery or falsification of the content or appearance of this document is unlawful and offenders may be prosecuted to the fullest extent of the law. Unless otherwise stated the results shown in this test report refer only to the sample(s) tested and such sample(s) are retained for 30 days only.

Attention: To check the authenticity of testing /inspection report & certificate, please contact us at telephone: (86-755) 8307 1443, or email: [CN.Doccheck@sgs.com](mailto:CN.Doccheck@sgs.com)

#### 4.4 Test Location

All tests were performed at:

Compliance Certification Services (Kunshan) Inc.

No.10 Weiye Rd, Innovation park, Eco&Tec, Development Zone, Kunshan City, Jiangsu, China.

Tel: +86 512 5735 5888

Fax: +86 512 5737 0818

No tests were sub-contracted.

#### 4.5 Test Facility

The test facility is recognized, certified, or accredited by the following organizations:

• **CNAS (No. CNAS L4354)**

CNAS has accredited Compliance Certification Services (Kunshan) Inc. to ISO/IEC 17025:2017 General Requirements for the Competence of Testing and Calibration Laboratories (CNAS-CL01 Accreditation Criteria for the Competence of Testing and Calibration Laboratories) for the competence in the field of testing.

• **A2LA (Certificate No. 2541.01)**

Compliance Certification Services (Kunshan) Inc. is accredited by the American Association for Laboratory Accreditation (A2LA). Certificate No. 2541.01.

• **FCC (Designation Number: CN1172)**

Compliance Certification Services Inc. has been recognized as an accredited testing laboratory. Designation Number: CN1172.

• **ISED (CAB Identifier: CN0072)**

Compliance Certification Services (Kunshan) Inc. has been recognized by Innovation, Science and Economic Development (ISED) Canada as an accredited testing laboratory. CAB Identifier: CN0072.

• **VCCI (Member No.: 1938)**

The 3m and 10m Semi-anechoic chamber and Shielded Room of Compliance Certification Services (Kunshan) Inc. has been registered in accordance with the Regulations for Voluntary Control Measures with Registration No.: R-11600, C-11707, T-11499, G-10216 respectively.



Unless otherwise agreed in writing, this document is issued by the Company subject to its General Conditions of Service printed overleaf, available on request or accessible at <http://www.sgs.com/en/Terms-and-Conditions.aspx> and, for electronic format documents, subject to Terms and Conditions for Electronic Documents at <http://www.sgs.com/en/Terms-and-Conditions/Terms-e-Documents.aspx>. Attention is drawn to the limitation of liability, indemnification and jurisdiction issues defined therein. Any holder of this document is advised that information contained hereon reflects the Company's findings at the time of its intervention only and within the limits of Client's instructions, if any. The Company's sole responsibility is to its Client and this document does not exonerate parties to a transaction from exercising all their rights and obligations under the transaction documents. This document cannot be reproduced except in full, without prior written approval of the Company. Any unauthorized alteration, forgery or falsification of the content or appearance of this document is unlawful and offenders may be prosecuted to the fullest extent of the law. Unless otherwise stated the results shown in this test report refer only to the sample(s) tested and such sample(s) are retained for 30 days only.

Attention: To check the authenticity of testing /inspection report & certificate, please contact us at telephone: (86-755) 8307 1443, or email: [CN.Doccheck@sgs.com](mailto:CN.Doccheck@sgs.com)

#### 4.6 Measurement Uncertainty

No.	Item	Measurement Uncertainty
1	Radio Frequency	8.4 x 10 <sup>-8</sup>
2	Timeout	2s
3	Duty cycle	0.4%
4	Occupied Bandwidth	3%
5	RF conducted power	0.6dB
6	RF power density	2.9dB
7	Conducted Spurious emissions	0.75dB
8	RF Radiated power	5.1dB (Below 1GHz)
		5.9dB (Above 1GHz)
9	Radiated Spurious emission test	4.2dB (Below 30MHz)
		4.5dB (30MHz-1GHz)
		5.1dB (1GHz-6GHz)
		5.4dB (6GHz-18GHz)
10	Temperature test	1°C
11	Humidity test	3%
12	Supply voltages	1.5%
13	Time	3%

Note: The measurement uncertainty represents an expanded uncertainty expressed at approximately the 95% confidence level using a coverage factor of k=2.



Unless otherwise agreed in writing, this document is issued by the Company subject to its General Conditions of Service printed overleaf, available on request or accessible at <http://www.sgs.com/en/Terms-and-Conditions.aspx> and, for electronic format documents, subject to Terms and Conditions for Electronic Documents at <http://www.sgs.com/en/Terms-and-Conditions/Terms-e-Document.aspx>. Attention is drawn to the limitation of liability, indemnification and jurisdiction issues defined therein. Any holder of this document is advised that information contained hereon reflects the Company's findings at the time of its intervention only and within the limits of Client's instructions, if any. The Company's sole responsibility is to its Client and this document does not exonerate parties to a transaction from exercising all their rights and obligations under the transaction documents. This document cannot be reproduced except in full, without prior written approval of the Company. Any unauthorized alteration, forgery or falsification of the content or appearance of this document is unlawful and offenders may be prosecuted to the fullest extent of the law. Unless otherwise stated the results shown in this test report refer only to the sample(s) tested and such sample(s) are retained for 30 days only.

Attention: To check the authenticity of testing /inspection report & certificate, please contact us at telephone: (86-755) 8307 1443, or email: [CN\\_Doccheck@sgs.com](mailto:CN_Doccheck@sgs.com)



## 5 Equipments Used during Test

Item	Equipment	Manufacturer	Model	Serial Number	Cal Date	Cal. Due Date
<b>Conducted Emission at Mains Terminals (150kHz-30MHz)</b>						
1	EMI Test Receive	R&S	ESCI	100781	02/01/2021	01/31/2022
2	LISN	R&S	ENV216	101604	10/19/2020	10/18/2021
3	LISN	Schwarzbeck	NNLK 8129	8129-143	10/19/2020	10/18/2021
4	Pulse Limiter	R&S	ESH3-Z2	100609	02/01/2021	01/31/2022
5	CE test Cable	Thermax	/	14	10/17/2020	10/16/2021
6	Test Software	Farad	EZ-EMC	CCS-03A1	N.C.R	N.C.R
<b>RF Conducted Test</b>						
1	Spectrum Analyzer	Agilent	E4446A	MY44020154	04/16/2021	04/15/2022
2	Spectrum Analyzer	Keysight	N9020A	MY55370209	12/02/2020	12/01/2021
3	Spectrum Analyzer	Keysight	N9010A	MY56480443	02/01/2021	01/31/2022
4	Signal Generator	Agilent	N5182A	MY50142015	09/25/2020	09/24/2021
5	Radio Communication Test Station	Anritsu	MT8000A	6262012849	N/A	N/A
6	Radio Communication Analyzer	Anritsu	MT8821C	6201692222	N/A	N/A
7	Universal Radio Communication Tester	R&S	CMW500	159275	10/19/2020	10/18/2021
8	Universal Radio Communication Tester	R&S	CMW500	167239	04/16/2021	04/15/2022
9	Power Meter	Anritsu	ML2495A	1445010	04/15/2021	04/14/2022
10	Switcher	CCSRF	FY562	KUS2001M001-3	10/19/2020	10/18/2021
11	AC Power Source	EXTECH	6605	1570106	N.C.R	N.C.R
12	DC Power Supply	Agilent	E3632A	MY50340053	N.C.R	N.C.R
13	6dB Attenuator	Mini-Circuits	NAT-6-2W	15542-1	N.C.R	N.C.R
14	Power Divider	AISI	IOWOPE2068	PE2068	N.C.R	N.C.R
15	Filter	MICRO-TRONICS	BRM50701	5	N.C.R	N.C.R
16	Conducted test cable	/	RF01-RF04	/	04/15/2021	04/14/2022
17	Software	BST	TST-PASS	N/A	N/A	N/A
18	Temp. / Humidity Chamber	TERCHY	MHK-120AK	X30109	04/15/2021	04/14/2022
19	Thermometer	Anymetre	TH603	CCS007	10/16/2020	10/15/2021
<b>RF Radiated Test</b>						
1	Spectrum Analyzer	R&S	FSV40	101493	10/19/2020	10/18/2021
2	Signal Generator	Agilent	E8257C	MY43321570	10/19/2020	10/18/2021
3	Loop Antenna	Schwarzbeck	HXYZ9170	9170-108	02/22/2021	02/21/2022
4	Bilog Antenna	TESEQ	CBL 6112D	35403	06/22/2019	06/21/2021
5	Bilog Antenna	SCHWARZBECK	VULB9160	9160-3342	04/13/2021	04/12/2023
6	Horn-antenna(1-18GHz)	Schwarzbeck	BBHA9120D	267	10/26/2020	10/25/2022
7	Horn-antenna(1-18GHz)	ETS-LINDGREN	3117	00143290	02/22/2021	02/21/2023
8	Horn Antenna(18-40GHz)	Schwarzbeck	BBHA9170	BBHA9170171	02/22/2021	02/21/2022
9	Horn-antenna(40-60GHz)	REBES	SAZ-2410-19-S1	06299-01	N/A	N/A
10	Horn-antenna(50-75GHz)	REBES	SAZ-2410-15-S1	01731-01	N/A	N/A
11	Horn-antenna(75-110GHz)	REBES	SAZ-2410-10-S1	01773-09	N/A	N/A
12	Horn-antenna(110-170GHz)	REBES	SAZ-2410-06-S1	01776-05	N/A	N/A
13	Horn-antenna(140-220GHz)	REBES	SAZ-2410-05-S1	01759-04	N/A	N/A
14	Horn-antenna(220-325GHz)	REBES	SAR-2309-03-S2	06300-01	N/A	N/A



Unless otherwise agreed in writing, this document is issued by the Company subject to its General Conditions of Service printed overleaf, available on request or accessible at <http://www.sgs.com/en/Terms-and-Conditions.aspx> and, for electronic format documents, subject to Terms and Conditions for Electronic Documents at <http://www.sgs.com/en/Terms-and-Conditions/Terms-e-Documents.aspx>. Attention is drawn to the limitation of liability, indemnification and jurisdiction issues defined therein. Any holder of this document is advised that information contained hereon reflects the Company's findings at the time of its intervention only and within the limits of Client's instructions, if any. The Company's sole responsibility is to its Client and this document does not exonerate parties to a transaction from exercising all their rights and obligations under the transaction documents. This document cannot be reproduced except in full, without prior written approval of the Company. Any unauthorized alteration, forgery or falsification of the content or appearance of this document is unlawful and offenders may be prosecuted to the fullest extent of the law. Unless otherwise stated the results shown in this test report refer only to the sample(s) tested and such sample(s) are retained for 30 days only.

Attention: To check the authenticity of testing / inspection report & certificate, please contact us at telephone: (86-755) 8307 1443, or email: [CN.Doccheck@sgs.com](mailto:CN.Doccheck@sgs.com)





15	Extended waveguide(40-60GHz)	REBES	SWG-19025-FB	06303-01	N/A	N/A
16	Extended waveguide(50-75GHz)	REBES	SWG-15025-FB	01525-09	N/A	N/A
17	Extended waveguide(75-110GHz)	REBES	SWG-10025-FB	01509-01	N/A	N/A
18	Extended waveguide(110-170GHz)	REBES	SWG-06025-FB	06302-01	N/A	N/A
19	Extended waveguide(140-220GHz)	REBES	SWG-05025-FB	06304-01	N/A	N/A
20	Extended waveguide(220-325GHz)	REBES	SWG-03025-FB	06301-01	N/A	N/A
21	Harmonic mixer(110-170GHz)	REBES	STH-06SF-S1	06110-01	N/A	N/A
22	Harmonic mixer(40-60GHz)	REBES	STH-19SF-S1	06937-01	N/A	N/A
23	Waveguide Harmonic Mixer(50-75GHz)	KEYSIGHT	M1970V	MY51390966	N/A	N/A
24	Waveguide Harmonic Mixer(50-75GHz) cable	Silverline	SLU18-SMSM -01.00M	99612	N/A	N/A
25	Waveguide Harmonic Mixer(75-110GHz)	KEYSIGHT	M1970W	MY51430883	N/A	N/A
26	Waveguide Harmonic Mixer(75-110GHz) cable	Silverline	SLU18-SMSM -01.00M	94202	N/A	N/A
27	Pre-Amplifier(30MHz~18GHz)	LNA	/	/	04/15/2021	04/14/2022
28	Amplifier(18~40GHz)	COM-POWER	PAM-840A	461332	10/23/2020	10/22/2021
29	Low Pass Filter	MICRO-TRONICS	VLFX-950	RV142900829	N.C.R	N.C.R
30	High Pass Filter	Mini-Circuits	VHF-1200	15542	N.C.R	N.C.R
31	Filter (5450MHz~5770 MHz)	MICRO-TRONICS	BRC50704-01	2	N.C.R	N.C.R
32	Filter (5690 MHz~5930 MHz)	MICRO-TRONICS	BRC50705-01	4	N.C.R	N.C.R
33	Filter (5150 MHz~5350 MHz)	MICRO-TRONICS	BRC50703-01	2	N.C.R	N.C.R
34	Filter (885 MHz~915 MHz)	MICRO-TRONICS	BRM14698	1	N.C.R	N.C.R
35	Filter (815 MHz~860 MHz)	MICRO-TRONICS	BRM14697	1	N.C.R	N.C.R
36	Filter (1745 MHz~1910 MHz)	MICRO-TRONICS	BRM14700	1	N.C.R	N.C.R
37	Filter (1922 MHz~1977 MHz)	MICRO-TRONICS	BRM50715	1	N.C.R	N.C.R
38	Filter (2550 MHz)	MICRO-TRONICS	HPM13362	5	N.C.R	N.C.R
39	Filter (1532 MHz~1845 MHz)	MICRO-TRONICS	BRM50713	1	N.C.R	N.C.R
40	Filter (2.4GHz)	MICRO-TRONICS	BRM50701	5	N.C.R	N.C.R
41	RE test cable	/	RE01-RE04	/	04/15/2021	04/14/2022
42	Software	Farad	EZ-EMC	CCS-03A1	N/A	N/A



Unless otherwise agreed in writing, this document is issued by the Company subject to its General Conditions of Service printed overleaf, available on request or accessible at <http://www.sgs.com/en/Terms-and-Conditions.aspx> and, for electronic format documents, subject to Terms and Conditions for Electronic Documents at <http://www.sgs.com/en/Terms-and-Conditions/Terms-e-Documents.aspx>. Attention is drawn to the limitation of liability, indemnification and jurisdiction issues defined therein. Any holder of this document is advised that information contained hereon reflects the Company's findings at the time of its intervention only and within the limits of Client's instructions, if any. The Company's sole responsibility is to its Client and this document does not exonerate parties to a transaction from exercising all their rights and obligations under the transaction documents. This document cannot be reproduced except in full, without prior written approval of the Company. Any unauthorized alteration, forgery or falsification of the content or appearance of this document is unlawful and offenders may be prosecuted to the fullest extent of the law. Unless otherwise stated the results shown in this test report refer only to the sample(s) tested and such sample(s) are retained for 30 days only.

Attention: To check the authenticity of testing /inspection report & certificate, please contact us at telephone: (86-755) 8307 1443, or email: [CN.Doccheck@sgs.com](mailto:CN.Doccheck@sgs.com)



## 6 Test results and Measurement Data

### 6.1 Antenna Requirement

15.203 Requirement:

An intentional radiator shall be designed to ensure that no antenna other than that furnished by the responsible party shall be used with the device. The use of a permanently attached antenna or of an antenna that uses a unique coupling to the intentional radiator, the manufacturer may design the unit so that a broken antenna can be replaced by the user, but the use of a standard antenna jack or electrical connector is prohibited.

The antenna is spring antenna and no consideration of replacement.

Antenna location: Refer to Appendix (Internal Photos)



Unless otherwise agreed in writing, this document is issued by the Company subject to its General Conditions of Service printed overleaf, available on request or accessible at <http://www.sgs.com/en/Terms-and-Conditions.aspx> and, for electronic format documents, subject to Terms and Conditions for Electronic Documents at <http://www.sgs.com/en/Terms-and-Conditions/Terms-e-Documents.aspx>. Attention is drawn to the limitation of liability, indemnification and jurisdiction issues defined therein. Any holder of this document is advised that information contained hereon reflects the Company's findings at the time of its intervention only and within the limits of Client's instructions, if any. The Company's sole responsibility is to its Client and this document does not exonerate parties to a transaction from exercising all their rights and obligations under the transaction documents. This document cannot be reproduced except in full, without prior written approval of the Company. Any unauthorized alteration, forgery or falsification of the content or appearance of this document is unlawful and offenders may be prosecuted to the fullest extent of the law. Unless otherwise stated the results shown in this test report refer only to the sample(s) tested and such sample(s) are retained for 30 days only.

Attention: To check the authenticity of testing /inspection report & certificate, please contact us at telephone: (86-755) 8307 1443, or email: [CN\\_Doccheck@sgs.com](mailto:CN_Doccheck@sgs.com)

### 6.2 Conducted Emissions at AC Power Line (150kHz-30MHz)

Test Requirement 47 CFR Part 15, Subpart C 15.207

Test Method: ANSI C63.10 (2013) Section 6.2

Limit:

Frequency of emission(MHz)	Conducted limit(dBμV)	
	Quasi-peak	Average
0.15-0.5	66 to 56*	56 to 46*
0.5-5	56	46
5-30	60	50

\*Decreases with the logarithm of the frequency.

#### 6.2.1 E.U.T. Operation

Operating Environment:

Temperature: 22 °C Humidity: 50 % RH Atmospheric Pressure: 1020 mbar

Test mode

b:TX mode\_Keep the EUT in transmitting with modulation mode.

#### 6.2.2 Test Setup Diagram

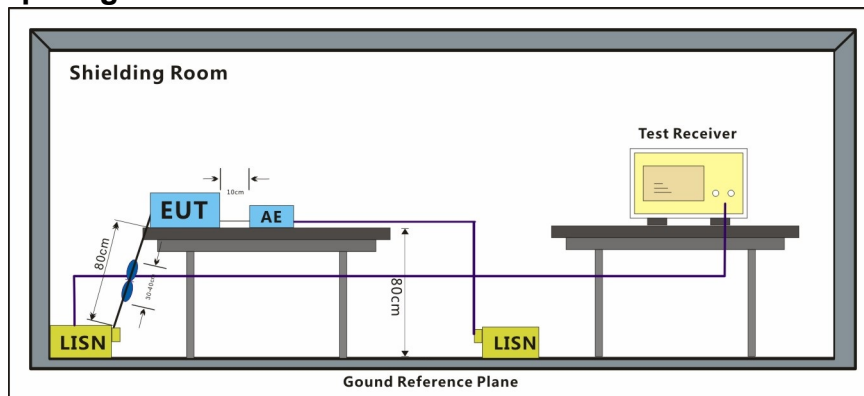

Unless otherwise agreed in writing, this document is issued by the Company subject to its General Conditions of Service printed overleaf, available on request or accessible at <http://www.sgs.com/en/Terms-and-Conditions.aspx> and, for electronic format documents, subject to Terms and Conditions for Electronic Documents at <http://www.sgs.com/en/Terms-and-Conditions/Terms-e-Document.aspx>. Attention is drawn to the limitation of liability, indemnification and jurisdiction issues defined therein. Any holder of this document is advised that information contained hereon reflects the Company's findings at the time of its intervention only and within the limits of Client's instructions, if any. The Company's sole responsibility is to its Client and this document does not exonerate parties to a transaction from exercising all their rights and obligations under the transaction documents. This document cannot be reproduced except in full, without prior written approval of the Company. Any unauthorized alteration, forgery or falsification of the content or appearance of this document is unlawful and offenders may be prosecuted to the fullest extent of the law. Unless otherwise stated the results shown in this test report refer only to the sample(s) tested and such sample(s) are retained for 30 days only.

Attention: To check the authenticity of testing /inspection report & certificate, please contact us at telephone: (86-755) 8307 1443, or email: [CN.Doccheck@sgs.com](mailto:CN.Doccheck@sgs.com)

SGS-CSTC Standards Technical Services (Shanghai) Co., Ltd.  
Testing Center EMC Laboratory

NO.588 West Jindu Road, Songjiang District, Shanghai, China 201612  
中国·上海·松江区金都西路588号 邮编: 201612

t(86-21) 61915666 f(86-21) 61915678 www.sgsgroup.com.cn  
t(86-21) 61915666 f(86-21) 61915678 e sgs.china@sgs.com

### 6.2.3 Measurement Procedure and Data

- 1) The mains terminal disturbance voltage test was conducted in a shielded room.
- 2) The EUT was connected to AC power source through a LISN 1 (Line Impedance Stabilization Network) which provides a 50ohm/50μH + 5ohm linear impedance. The power cables of all other units of the EUT were connected to a second LISN 2, which was bonded to the ground reference plane in the same way as the LISN 1 for the unit being measured. A multiple socket outlet strip was used to connect multiple power cables to a single LISN provided the rating of the LISN was not exceeded.
- 3) The tabletop EUT was placed upon a non-metallic table 0.8m above the ground reference plane. And for floor-standing arrangement, the EUT was placed on the horizontal ground reference plane,
- 4) The test was performed with a vertical ground reference plane. The rear of the EUT shall be 0.4 m from the vertical ground reference plane. The vertical ground reference plane was bonded to the horizontal ground reference plane. The LISN 1 was placed 0.8 m from the boundary of the unit under test and bonded to a ground reference plane for LISNs mounted on top of the ground reference plane. This distance was between the closest points of the LISN 1 and the EUT. All other units of the EUT and associated equipment was at least 0.8 m from the LISN 2.
- 5) In order to find the maximum emission, the relative positions of equipment and all of the interface cables must be changed according to ANSI C63.10 on conducted measurement.

Remark: LISN=Read Level+ Cable Loss+ LISN Factor



Unless otherwise agreed in writing, this document is issued by the Company subject to its General Conditions of Service printed overleaf, available on request or accessible at <http://www.sgs.com/en/Terms-and-Conditions.aspx> and, for electronic format documents, subject to Terms and Conditions for Electronic Documents at <http://www.sgs.com/en/Terms-and-Conditions/Terms-e-Documents.aspx>. Attention is drawn to the limitation of liability, indemnification and jurisdiction issues defined therein. Any holder of this document is advised that information contained hereon reflects the Company's findings at the time of its intervention only and within the limits of Client's instructions, if any. The Company's sole responsibility is to its Client and this document does not exonerate parties to a transaction from exercising all their rights and obligations under the transaction documents. This document cannot be reproduced except in full, without prior written approval of the Company. Any unauthorized alteration, forgery or falsification of the content or appearance of this document is unlawful and offenders may be prosecuted to the fullest extent of the law. Unless otherwise stated the results shown in this test report refer only to the sample(s) tested and such sample(s) are retained for 30 days only.

Attention: To check the authenticity of testing /inspection report & certificate, please contact us at telephone: (86-755) 8307 1443, or email: [CN.Doccheck@sgs.com](mailto:CN.Doccheck@sgs.com)

Mode:a; Line:Live Line

80.0 dBuV

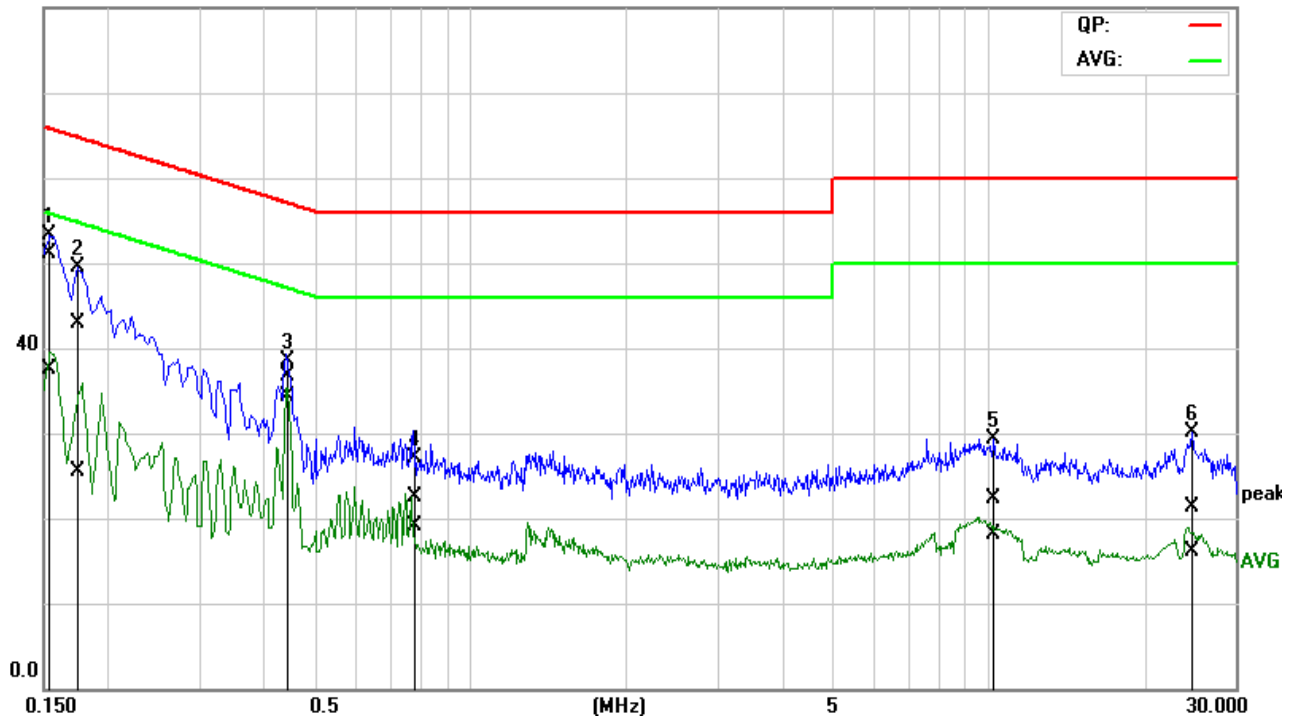

No.	Frequency (MHz)	QuasiPeak reading (dBuV)	Average reading (dBuV)	Correction factor (dB)	QuasiPeak result (dBuV)	Average result (dBuV)	QuasiPeak limit (dBuV)	Average limit (dBuV)	QuasiPeak margin (dB)	Average margin (dB)	Remark
1	0.1537	31.57	18.11	19.46	51.03	37.57	65.80	55.80	-14.77	-18.23	Pass
2	0.1758	23.36	5.98	19.46	42.82	25.44	64.68	54.68	-21.86	-29.24	Pass
3*	0.4466	17.20	14.87	19.51	36.71	34.38	56.94	46.94	-20.23	-12.56	Pass
4	0.7853	2.93	-0.48	19.54	22.47	19.06	56.00	46.00	-33.53	-26.94	Pass
5	10.2770	2.32	-1.81	19.99	22.31	18.18	60.00	50.00	-37.69	-31.82	Pass
6	24.6748	1.03	-4.29	20.36	21.39	16.07	60.00	50.00	-38.61	-33.93	Pass



Unless otherwise agreed in writing, this document is issued by the Company subject to its General Conditions of Service printed overleaf, available on request or accessible at <http://www.sgs.com/en/Terms-and-Conditions.aspx> and, for electronic format documents, subject to Terms and Conditions for Electronic Documents at <http://www.sgs.com/en/Terms-and-Conditions/Terms-e-Documents.aspx>. Attention is drawn to the limitation of liability, indemnification and jurisdiction issues defined therein. Any holder of this document is advised that information contained hereon reflects the Company's findings at the time of its intervention only and within the limits of Client's instructions, if any. The Company's sole responsibility is to its Client and this document does not exonerate parties to a transaction from exercising all their rights and obligations under the transaction documents. This document cannot be reproduced except in full, without prior written approval of the Company. Any unauthorized alteration, forgery or falsification of the content or appearance of this document is unlawful and offenders may be prosecuted to the fullest extent of the law. Unless otherwise stated the results shown in this test report refer only to the sample(s) tested and such sample(s) are retained for 30 days only.

Attention: To check the authenticity of testing /inspection report & certificate, please contact us at telephone: (86-755) 8307 1443, or email: [CN\\_Doccheck@sgs.com](mailto:CN_Doccheck@sgs.com)

Mode:a; Line:Neutral Line  
80.0 dBuV

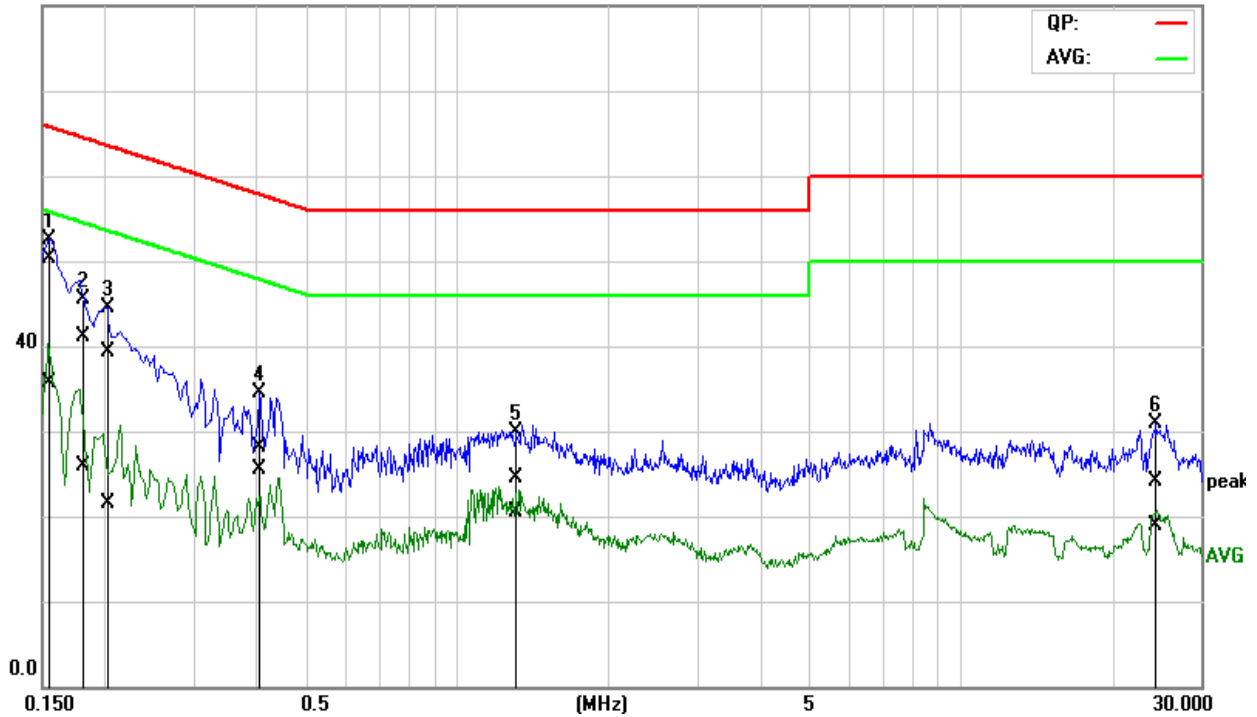

No.	Frequency (MHz)	QuasiPeak reading (dBuV)	Average reading (dBuV)	Correction factor (dB)	QuasiPeak result (dBuV)	Average result (dBuV)	QuasiPeak limit (dBuV)	Average limit (dBuV)	QuasiPeak margin (dB)	Average margin (dB)	Remark
1*	0.1570	30.87	16.22	19.42	50.29	35.64	65.62	55.62	-15.33	-19.98	Pass
2	0.1827	21.59	6.50	19.43	41.02	25.93	64.36	54.36	-23.34	-28.43	Pass
3	0.2029	19.87	2.16	19.43	39.30	21.59	63.49	53.49	-24.19	-31.90	Pass
4	0.4050	8.53	5.97	19.48	28.01	25.45	57.75	47.75	-29.74	-22.30	Pass
5	1.2909	4.99	1.02	19.54	24.53	20.56	56.00	46.00	-31.47	-25.44	Pass
6	24.4109	3.68	-1.50	20.35	24.03	18.85	60.00	50.00	-35.97	-31.15	Pass



Unless otherwise agreed in writing, this document is issued by the Company subject to its General Conditions of Service printed overleaf, available on request or accessible at <http://www.sgs.com/en/Terms-and-Conditions.aspx> and, for electronic format documents, subject to Terms and Conditions for Electronic Documents at <http://www.sgs.com/en/Terms-and-Conditions/Terms-e-Document.aspx>. Attention is drawn to the limitation of liability, indemnification and jurisdiction issues defined therein. Any holder of this document is advised that information contained hereon reflects the Company's findings at the time of its intervention only and within the limits of Client's instructions, if any. The Company's sole responsibility is to its Client and this document does not exonerate parties to a transaction from exercising all their rights and obligations under the transaction documents. This document cannot be reproduced except in full, without prior written approval of the Company. Any unauthorized alteration, forgery or falsification of the content or appearance of this document is unlawful and offenders may be prosecuted to the fullest extent of the law. Unless otherwise stated the results shown in this test report refer only to the sample(s) tested and such sample(s) are retained for 30 days only.

Attention: To check the authenticity of testing /inspection report and certificate, please contact us at telephone: (86-755) 8307 1443, or email: [CN.Doccheck@sgs.com](mailto:CN.Doccheck@sgs.com)

### 6.3 Spurious Emissions

**Test frequency range:** 9KHz – 5GHz

**Test Site:** Measurement Distance: 3m

**Receiver Setup:**

Frequency	Detector	RBW	VBW	Remark
0.009MHz-0.015MHz	Quasi-peak	200Hz	1KHz	Quasi-peak
0.015MHz-30MHz	Quasi-peak	9kHz	30KHz	Quasi-peak
30MHz-1GHz	Quasi-peak	120 kHz	300KHz	Quasi-peak
Above 1GHz	Peak	1MHz	3MHz	Peak
	Peak	1MHz	10Hz	Average

**Limit:  
(Spurious Emissions)**

Frequency	Field strength (microvolt/meter)	Limit (dBuV/m )	Remark	Measurement distance (m)
0.009MHz-0.490MHz	2400/F(kHz)	-	Quasi-peak	300
0.490MHz-1.705MHz	24000/F(kHz)	-	Quasi-peak	30
1.705MHz-30MHz	30	-	Quasi-peak	30
30MHz-88MHz	100	40.0	Quasi-peak	3
88MHz-216MHz	150	43.5	Quasi-peak	3
216MHz-960MHz	200	46.0	Quasi-peak	3
960MHz-1GHz	500	54.0	Quasi-peak	3
Above 1GHz	500	54.0	Average	3
		74.0	Peak	3

**Limit:  
(Field strength of the fundamental signal)**

Frequency	Limit (dBuV/m @3m)	Remark
433.09 - 434.61MHz	80.83	Average Value
	100.83	Peak Value

**Test Procedure:**

- The EUT was placed on the top of a rotating table 0.8 meters above the ground at a 3 meter semi-anechoic chamber. The table was rotated 360 degrees to determine the position of the highest radiation.
- The EUT was set 3 meters away from the interference-receiving antenna, which was mounted on the top of a variable-height antenna tower.
- The antenna height is varied from one meter to four meters above the ground to determine the maximum value of the field strength. Both horizontal and vertical polarizations of the antenna are set to make the measurement.
- For each suspected emission, the EUT was arranged to its worst case and then the antenna was tuned to heights from 1 meter to 4 meters (for the test frequency of below 30MHz, the antenna was tuned to heights 1 meter) and the rotatable table was turned from 0 degrees to 360 degrees to find the maximum reading.
- The test-receiver system was set to Peak Detect Function and Specified Bandwidth with Maximum Hold Mode.
- If the emission level of the EUT in peak mode was 10dB lower than the limit specified, then testing could be stopped and the peak values of the EUT would be reported. Otherwise the emissions that did not have 10dB margin would be re-tested one by one using peak, quasi-peak or average method as specified and then reported in a data sheet.
- The radiation measurements are performed in X, Y, Z axis positioning. And found the Z axis positioning which it is worse case, only the test worst case



Unless otherwise agreed in writing, this document is issued by the Company subject to its General Conditions of Service printed overleaf, available on request or accessible at <http://www.sgs.com/en/Terms-and-Conditions.aspx> and, for electronic format documents, subject to Terms and Conditions for Electronic Documents at <http://www.sgs.com/en/Terms-and-Conditions/Terms-e-Documents.aspx>. Attention is drawn to the limitation of liability, indemnification and jurisdiction issues defined therein. Any holder of this document is advised that information contained hereon reflects the Company's findings at the time of its intervention only and within the limits of Client's instructions, if any. The Company's sole responsibility is to its Client and this document does not exonerate parties to a transaction from exercising all their rights and obligations under the transaction documents. This document cannot be reproduced except in full, without prior written approval of the Company. Any unauthorized alteration, forgery or falsification of the content or appearance of this document is unlawful and offenders may be prosecuted to the fullest extent of the law. Unless otherwise stated the results shown in this test report refer only to the sample(s) tested and such sample(s) are retained for 30 days only.

Attention: To check the authenticity of testing /inspection report & certificate, please contact us at telephone: (86-755) 8307 1443, or email: CN.Doccheck@sgs.com

mode is recorded in the report.

**E.U.T. Operation**

Operating Environment:

Temperature: 22 °C Humidity: 50 % RH Atmospheric Pressure: 1020 mbar

Test mode

b:TX mode\_Keep the EUT in transmitting with modulation mode.

**Test Setup:**

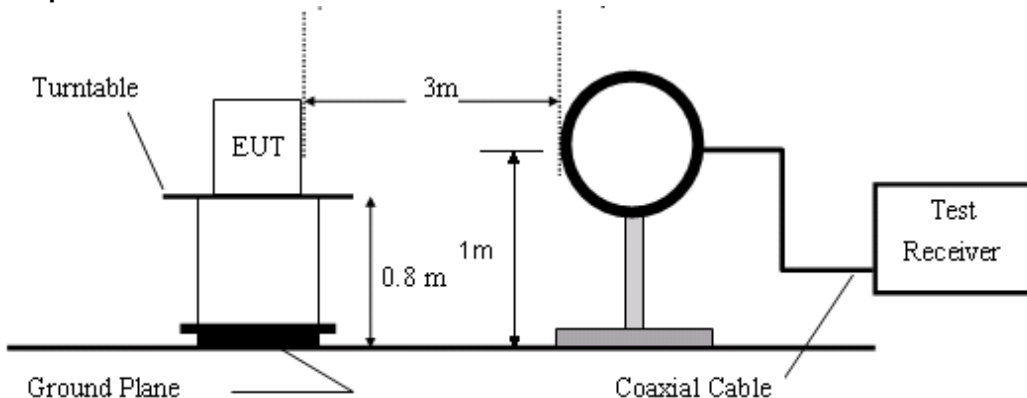

Figure1. Blow 30MHz radiated emissions test configuration

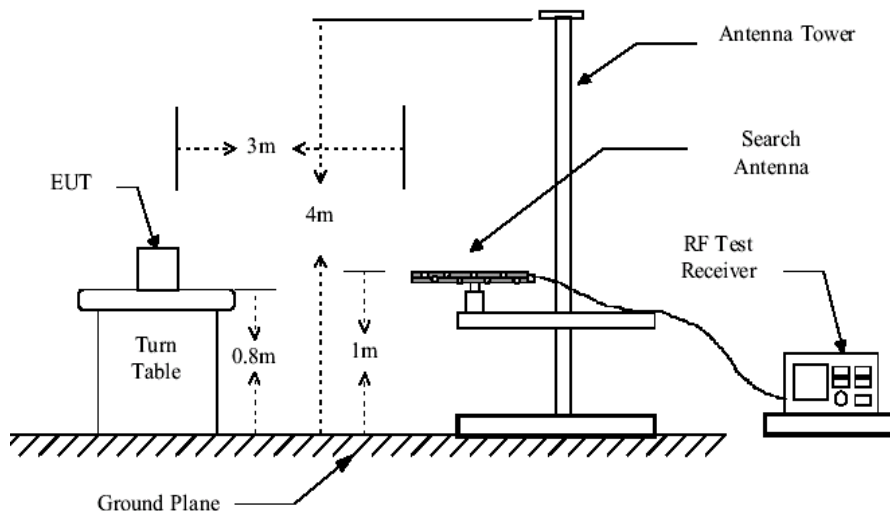

Figure2. 30MHz to 1GHz radiated emissions test configuration



Unless otherwise agreed in writing, this document is issued by the Company subject to its General Conditions of Service printed overleaf, available on request or accessible at <http://www.sgs.com/en/Terms-and-Conditions.aspx> and, for electronic format documents, subject to Terms and Conditions for Electronic Documents at <http://www.sgs.com/en/Terms-and-Conditions/Terms-e-Document.aspx>. Attention is drawn to the limitation of liability, indemnification and jurisdiction issues defined therein. Any holder of this document is advised that information contained hereon reflects the Company's findings at the time of its intervention only and within the limits of Client's instructions, if any. The Company's sole responsibility is to its Client and this document does not exonerate parties to a transaction from exercising all their rights and obligations under the transaction documents. This document cannot be reproduced except in full, without prior written approval of the Company. Any unauthorized alteration, forgery or falsification of the content or appearance of this document is unlawful and offenders may be prosecuted to the fullest extent of the law. Unless otherwise stated the results shown in this test report refer only to the sample(s) tested and such sample(s) are retained for 30 days only.

Attention: To check the authenticity of testing /inspection report and certificate, please contact us at telephone: (86-755) 8307 1443, or email: [CN\\_Doccheck@sgs.com](mailto:CN_Doccheck@sgs.com)



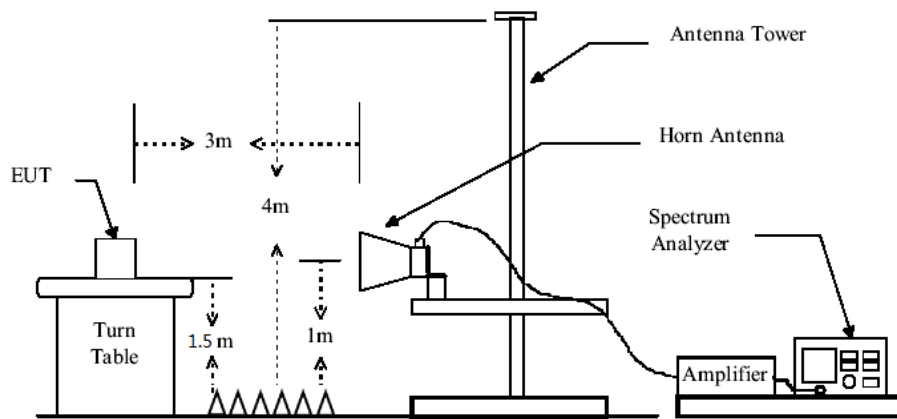

Figure3. Above 1GHz radiated emissions test configuration

Test Results: Pass

6.3.1 Field Strength of the Fundamental Signal

Test channel	Freq. (MHz)	Result Level (dBμV/m)	Limit Line (dBμV/m)	Over Limit (dB)	Detector	Polarization
Channel 1	433.1	89.81	100.83	-11.02	Peak	Vertical
		87.70	100.83	-13.13	Peak	Horizontal
		79.35	80.83	-1.48	AVG	Vertical
		-77.24	80.83	-3.59	AVG	Horizontal
Channel 2	433.85	88.58	100.83	-12.25	Peak	Vertical
		85.73	100.83	-15.10	Peak	Horizontal
		78.12	80.83	-2.71	AVG	Vertical
		75.27	80.83	-5.56	AVG	Horizontal
Channel 3	434.6	88.84	100.83	-11.99	Peak	Vertical
		88.51	100.83	-12.32	Peak	Horizontal
		78.38	80.83	-2.45	AVG	Vertical
		78.05	80.83	-2.78	AVG	Horizontal

Remark:

1. If the Peak value below the AV Limit, the AV test doesn't perform for this submission.
2. Average level=Peak level-Duty Cycle Factor
3. Duty Cycle Factor= 20log(Duty Cycle)=10.46dB



Unless otherwise agreed in writing, this document is issued by the Company subject to its General Conditions of Service printed overleaf, available on request or accessible at <http://www.sgs.com/en/Terms-and-Conditions.aspx> and, for electronic format documents, subject to Terms and Conditions for Electronic Documents at <http://www.sgs.com/en/Terms-and-Conditions/Terms-e-Document.aspx>. Attention is drawn to the limitation of liability, indemnification and jurisdiction issues defined therein. Any holder of this document is advised that information contained hereon reflects the Company's findings at the time of its intervention only and within the limits of Client's instructions, if any. The Company's sole responsibility is to its Client and this document does not exonerate parties to a transaction from exercising all their rights and obligations under the transaction documents. This document cannot be reproduced except in full, without prior written approval of the Company. Any unauthorized alteration, forgery or falsification of the content or appearance of this document is unlawful and offenders may be prosecuted to the fullest extent of the law. Unless otherwise stated the results shown in this test report refer only to the sample(s) tested and such sample(s) are retained for 30 days only.

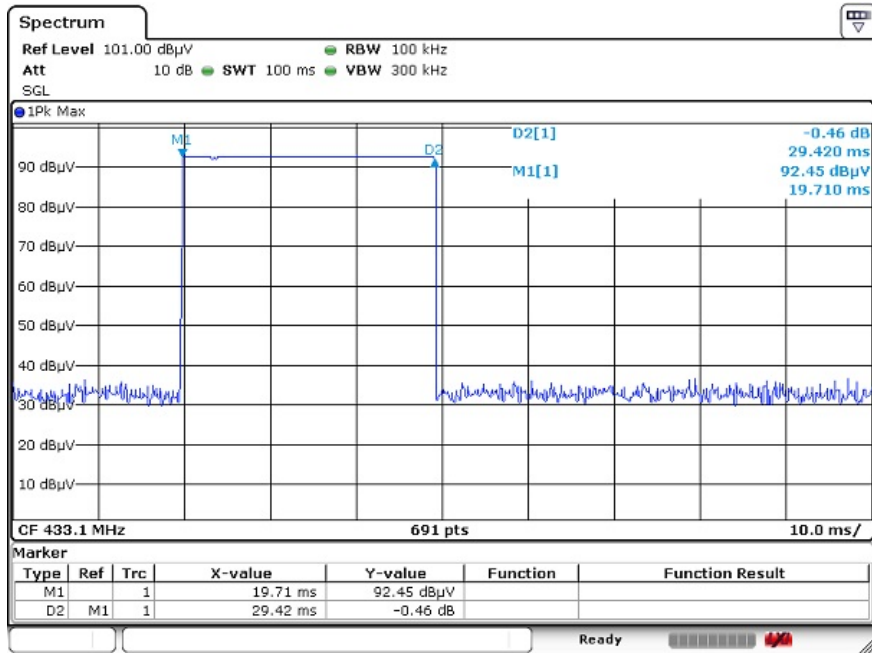

Unless otherwise agreed in writing, this document is issued by the Company subject to its General Conditions of Service printed overleaf, available on request or accessible at <http://www.sgs.com/en/Terms-and-Conditions.aspx> and, for electronic format documents, subject to Terms and Conditions for Electronic Documents at <http://www.sgs.com/en/Terms-and-Conditions/Terms-e-Document.aspx>. Attention is drawn to the limitation of liability, indemnification and jurisdiction issues defined therein. Any holder of this document is advised that information contained hereon reflects the Company's findings at the time of its intervention only and within the limits of Client's instructions, if any. The Company's sole responsibility is to its Client and this document does not exonerate parties to a transaction from exercising all their rights and obligations under the transaction documents. This document cannot be reproduced except in full, without prior written approval of the Company. Any unauthorized alteration, forgery or falsification of the content or appearance of this document is unlawful and offenders may be prosecuted to the fullest extent of the law. Unless otherwise stated the results shown in this test report refer only to the sample(s) tested and such sample(s) are retained for 30 days only.

6.3.2 Spurious Emissions

Below 1GHz

433.1MHz Vertical:

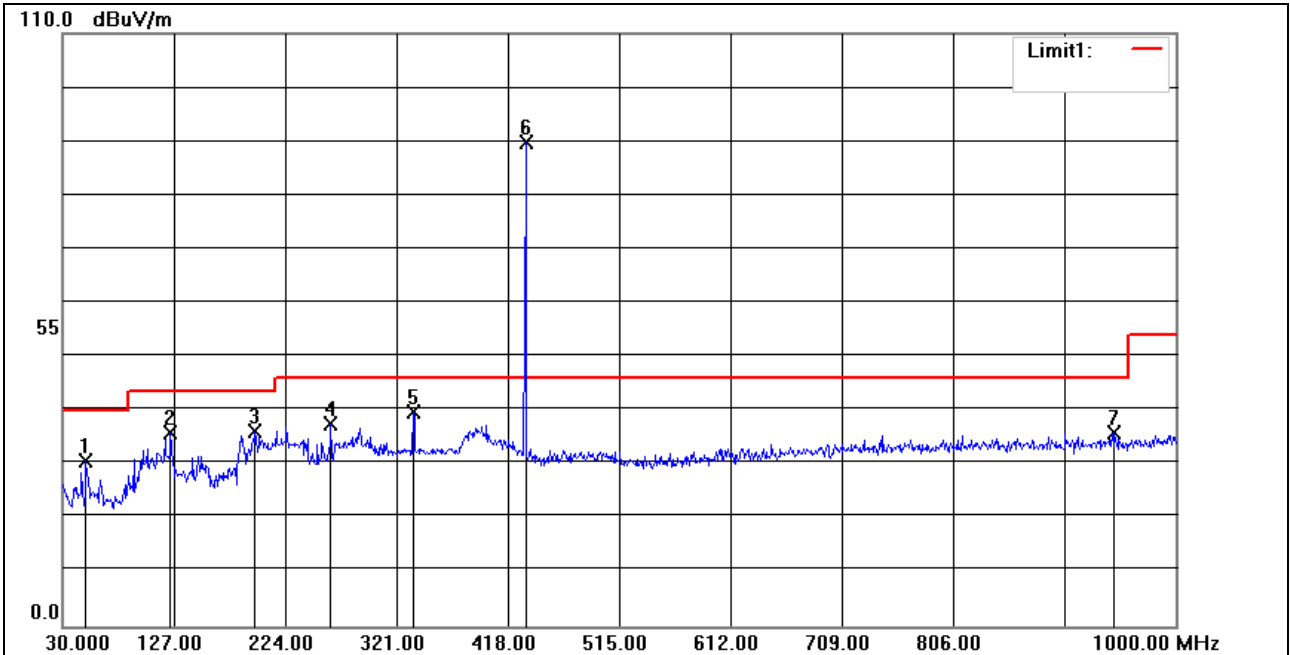

No.	Frequency (MHz)	Reading (dBuV)	Correct Factor(dB/m)	Result (dBuV/m)	Limit (dBuV/m)	Margin (dB)	Remark
1	50.3700	16.07	14.65	30.72	40.00	-9.28	QP
2	124.0900	16.38	19.43	35.81	43.50	-7.69	QP
3	197.8100	19.52	16.61	36.13	43.50	-7.37	QP
4	263.7700	17.77	19.90	37.67	46.00	-8.33	QP
5	335.5500	17.50	22.29	39.79	46.00	-6.21	QP
6	433.5200	65.33	24.48	89.81	100.83	-11.02	peak
7	946.6500	6.49	29.38	35.87	46.00	-10.13	QP



Unless otherwise agreed in writing, this document is issued by the Company subject to its General Conditions of Service printed overleaf, available on request or accessible at <http://www.sgs.com/en/Terms-and-Conditions.aspx> and, for electronic format documents, subject to Terms and Conditions for Electronic Documents at <http://www.sgs.com/en/Terms-and-Conditions/Terms-e-Documents.aspx>. Attention is drawn to the limitation of liability, indemnification and jurisdiction issues defined therein. Any holder of this document is advised that information contained hereon reflects the Company's findings at the time of its intervention only and within the limits of Client's instructions, if any. The Company's sole responsibility is to its Client and this document does not exonerate parties to a transaction from exercising all their rights and obligations under the transaction documents. This document cannot be reproduced except in full, without prior written approval of the Company. Any unauthorized alteration, forgery or falsification of the content or appearance of this document is unlawful and offenders may be prosecuted to the fullest extent of the law. Unless otherwise stated the results shown in this test report refer only to the sample(s) tested and such sample(s) are retained for 30 days only.

433.1MHz Horizontal:

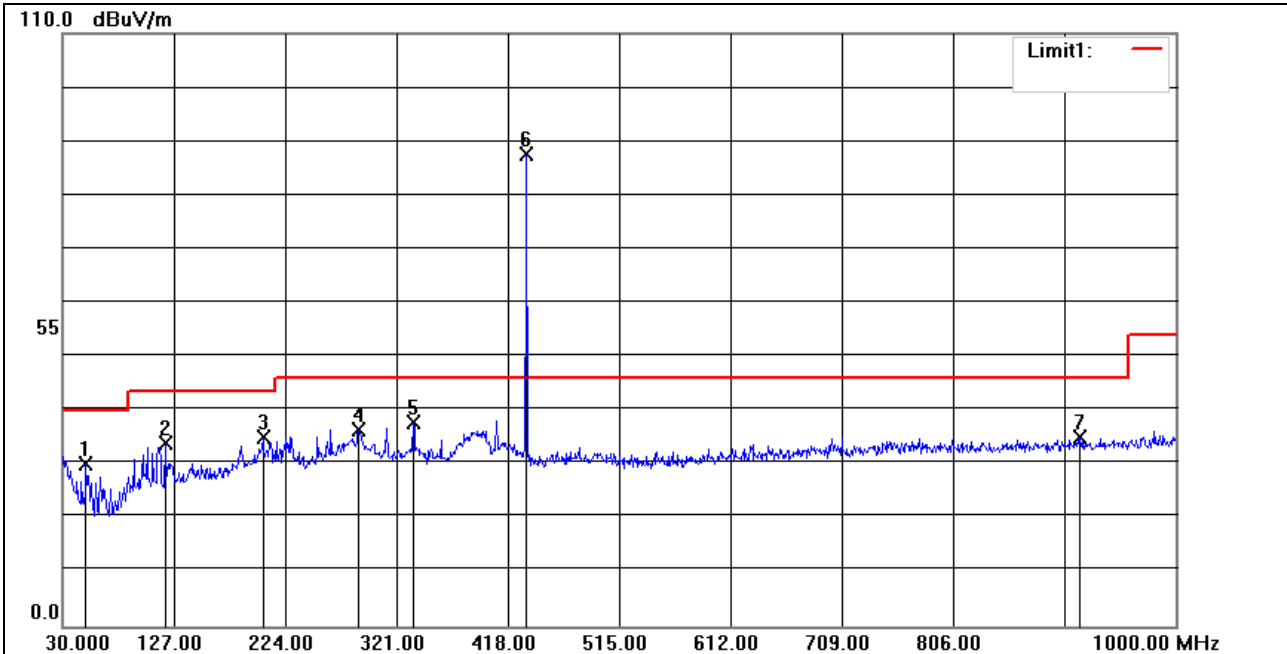

No.	Frequency (MHz)	Reading (dBuV)	Correct Factor(dB/m)	Result (dBuV/m)	Limit (dBuV/m)	Margin (dB)	Remark
1	50.3700	15.43	14.65	30.08	40.00	-9.92	QP
2	119.2400	14.60	19.28	33.88	43.50	-9.62	QP
3	204.6000	18.36	16.73	35.09	43.50	-8.41	QP
4	288.0200	15.98	20.51	36.49	46.00	-9.51	QP
5	335.5500	15.48	22.29	37.77	46.00	-8.23	QP
6	434.4900	63.21	24.49	87.70	100.83	-13.13	peak
7	916.5800	5.82	29.16	34.98	46.00	-11.02	QP



Unless otherwise agreed in writing, this document is issued by the Company subject to its General Conditions of Service printed overleaf, available on request or accessible at <http://www.sgs.com/en/Terms-and-Conditions.aspx> and, for electronic format documents, subject to Terms and Conditions for Electronic Documents at <http://www.sgs.com/en/Terms-and-Conditions/Terms-e-Documents.aspx>. Attention is drawn to the limitation of liability, indemnification and jurisdiction issues defined therein. Any holder of this document is advised that information contained hereon reflects the Company's findings at the time of its intervention only and within the limits of Client's instructions, if any. The Company's sole responsibility is to its Client and this document does not exonerate parties to a transaction from exercising all their rights and obligations under the transaction documents. This document cannot be reproduced except in full, without prior written approval of the Company. Any unauthorized alteration, forgery or falsification of the content or appearance of this document is unlawful and offenders may be prosecuted to the fullest extent of the law. Unless otherwise stated the results shown in this test report refer only to the sample(s) tested and such sample(s) are retained for 30 days only.

433.85MHz Vertical:

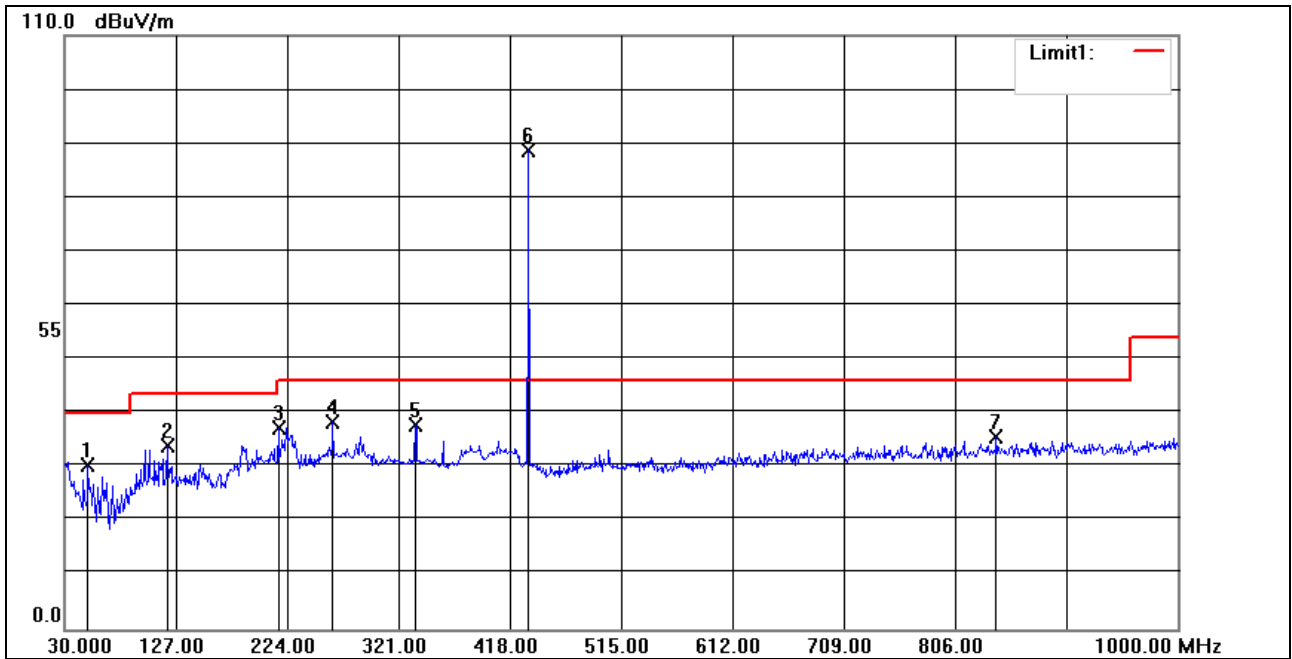

No.	Frequency (MHz)	Reading (dBuV)	Correct Factor(dB/m)	Result (dBuV/m)	Limit (dBuV/m)	Margin (dB)	Remark
1	50.3700	15.85	14.65	30.50	40.00	-9.50	QP
2	119.2400	14.66	19.28	33.94	43.50	-9.56	QP
3	216.2400	19.88	17.45	37.33	46.00	-8.67	QP
4	263.7700	18.49	19.90	38.39	46.00	-7.61	QP
5	335.5500	15.39	22.29	37.68	46.00	-8.32	QP
6	434.4900	64.09	24.49	88.58	100.83	-12.25	peak
7	841.8900	6.94	28.76	35.70	46.00	-10.30	QP



Unless otherwise agreed in writing, this document is issued by the Company subject to its General Conditions of Service printed overleaf, available on request or accessible at <http://www.sgs.com/en/Terms-and-Conditions.aspx> and, for electronic format documents, subject to Terms and Conditions for Electronic Documents at <http://www.sgs.com/en/Terms-and-Conditions/Terms-e-Documents.aspx>. Attention is drawn to the limitation of liability, indemnification and jurisdiction issues defined therein. Any holder of this document is advised that information contained hereon reflects the Company's findings at the time of its intervention only and within the limits of Client's instructions, if any. The Company's sole responsibility is to its Client and this document does not exonerate parties to a transaction from exercising all their rights and obligations under the transaction documents. This document cannot be reproduced except in full, without prior written approval of the Company. Any unauthorized alteration, forgery or falsification of the content or appearance of this document is unlawful and offenders may be prosecuted to the fullest extent of the law. Unless otherwise stated the results shown in this test report refer only to the sample(s) tested and such sample(s) are retained for 30 days only.

433.85MHz Horizontal:

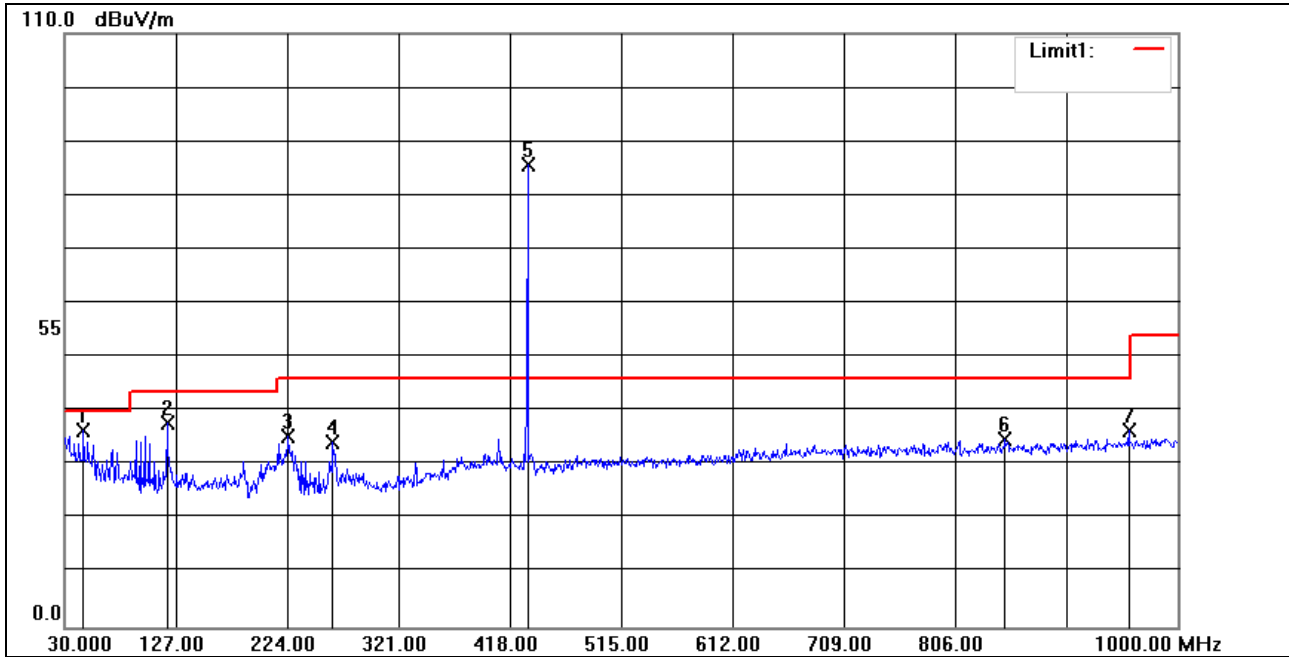

No.	Frequency (MHz)	Reading (dBuV)	Correct Factor(dB/m)	Result (dBuV/m)	Limit (dBuV/m)	Margin (dB)	Remark
1	46.4900	19.70	16.64	36.34	40.00	-3.66	QP
2	119.2400	18.45	19.28	37.73	43.50	-5.77	QP
3	224.9700	17.47	17.99	35.46	46.00	-10.54	QP
4	263.7700	14.47	19.90	34.37	46.00	-11.63	QP
5	433.5200	61.25	24.48	85.73	100.83	-15.10	peak
6	849.6500	5.88	28.81	34.69	46.00	-11.31	QP
7	957.3200	6.95	29.47	36.42	46.00	-9.58	QP



Unless otherwise agreed in writing, this document is issued by the Company subject to its General Conditions of Service printed overleaf, available on request or accessible at <http://www.sgs.com/en/Terms-and-Conditions.aspx> and, for electronic format documents, subject to Terms and Conditions for Electronic Documents at <http://www.sgs.com/en/Terms-and-Conditions/Terms-e-Documents.aspx>. Attention is drawn to the limitation of liability, indemnification and jurisdiction issues defined therein. Any holder of this document is advised that information contained hereon reflects the Company's findings at the time of its intervention only and within the limits of Client's instructions, if any. The Company's sole responsibility is to its Client and this document does not exonerate parties to a transaction from exercising all their rights and obligations under the transaction documents. This document cannot be reproduced except in full, without prior written approval of the Company. Any unauthorized alteration, forgery or falsification of the content or appearance of this document is unlawful and offenders may be prosecuted to the fullest extent of the law. Unless otherwise stated the results shown in this test report refer only to the sample(s) tested and such sample(s) are retained for 30 days only.

434.6MHz Vertical:

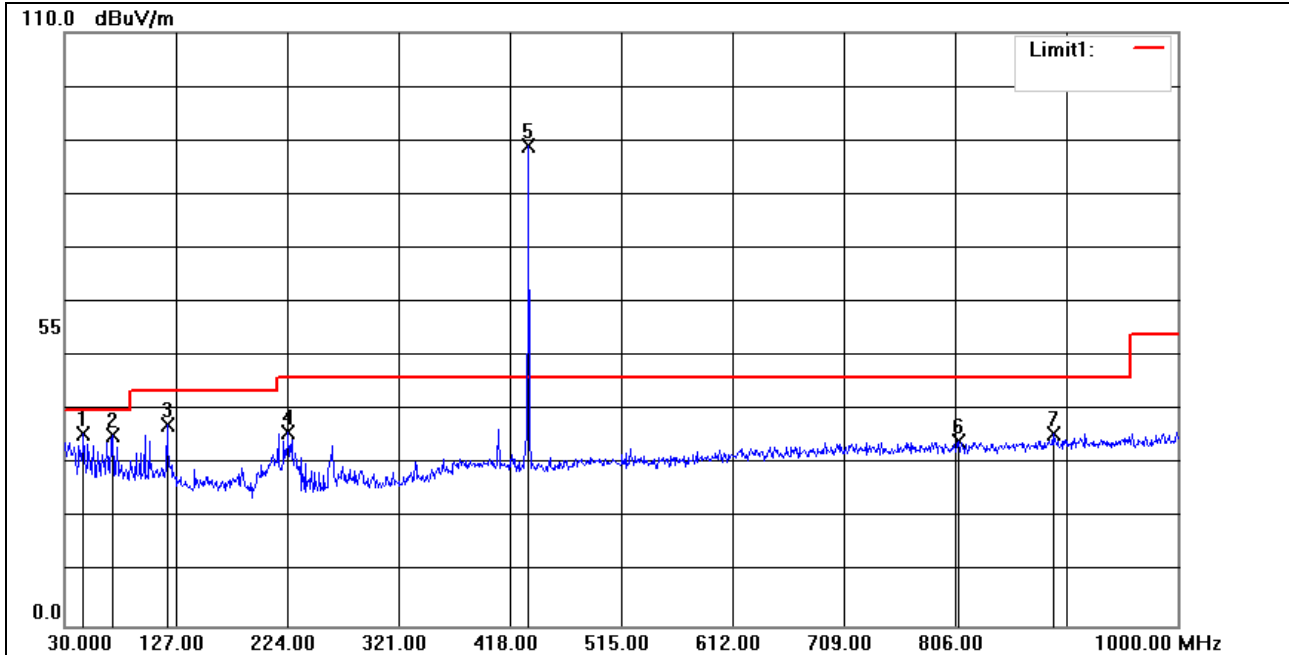

No.	Frequency (MHz)	Reading (dBuV)	Correct Factor (dB/m)	Result (dBuV/m)	Limit (dBuV/m)	Margin (dB)	Remark
1	46.4900	18.86	16.64	35.50	40.00	-4.50	QP
2	71.7100	21.53	13.86	35.39	40.00	-4.61	QP
3	119.2400	18.07	19.28	37.35	43.50	-6.15	QP
4	224.9700	17.88	17.99	35.87	46.00	-10.13	QP
5	434.4900	64.35	24.49	88.84	100.83	-11.99	peak
6	808.9100	5.61	28.55	34.16	46.00	-11.84	QP
7	891.3600	6.68	29.00	35.68	46.00	-10.32	QP



Unless otherwise agreed in writing, this document is issued by the Company subject to its General Conditions of Service printed overleaf, available on request or accessible at <http://www.sgs.com/en/Terms-and-Conditions.aspx> and, for electronic format documents, subject to Terms and Conditions for Electronic Documents at <http://www.sgs.com/en/Terms-and-Conditions/Terms-e-Documents.aspx>. Attention is drawn to the limitation of liability, indemnification and jurisdiction issues defined therein. Any holder of this document is advised that information contained hereon reflects the Company's findings at the time of its intervention only and within the limits of Client's instructions, if any. The Company's sole responsibility is to its Client and this document does not exonerate parties to a transaction from exercising all their rights and obligations under the transaction documents. This document cannot be reproduced except in full, without prior written approval of the Company. Any unauthorized alteration, forgery or falsification of the content or appearance of this document is unlawful and offenders may be prosecuted to the fullest extent of the law. Unless otherwise stated the results shown in this test report refer only to the sample(s) tested and such sample(s) are retained for 30 days only.

434.6MHz Horizontal:

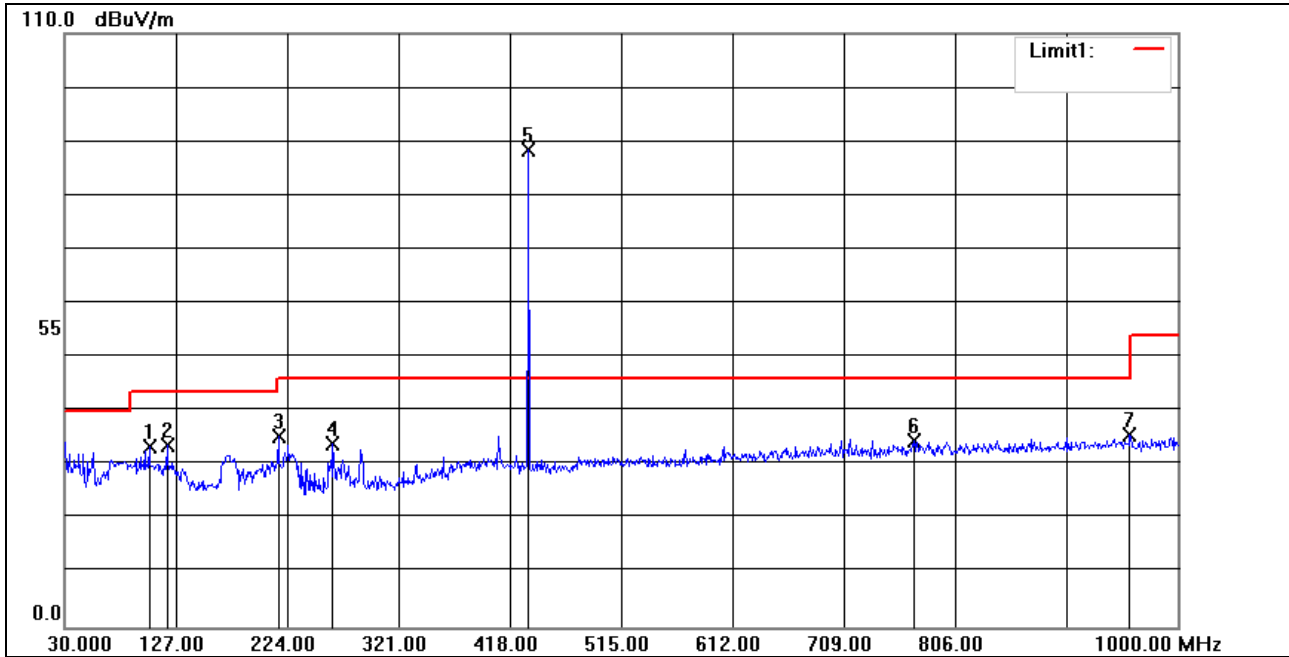

No.	Frequency (MHz)	Reading (dBuV)	Correct Factor(dB/m)	Result (dBuV/m)	Limit (dBuV/m)	Margin (dB)	Remark
1	103.7200	14.48	18.80	33.28	43.50	-10.22	QP
2	119.2400	14.54	19.28	33.82	43.50	-9.68	QP
3	216.2400	17.98	17.45	35.43	46.00	-10.57	QP
4	263.7700	13.97	19.90	33.87	46.00	-12.13	QP
5	434.4900	64.02	24.49	88.51	100.83	-12.32	peak
6	770.1100	6.19	28.28	34.47	46.00	-11.53	QP
7	958.2900	6.17	29.48	35.65	46.00	-10.35	QP



Unless otherwise agreed in writing, this document is issued by the Company subject to its General Conditions of Service printed overleaf, available on request or accessible at <http://www.sgs.com/en/Terms-and-Conditions.aspx> and, for electronic format documents, subject to Terms and Conditions for Electronic Documents at <http://www.sgs.com/en/Terms-and-Conditions/Terms-e-Documents.aspx>. Attention is drawn to the limitation of liability, indemnification and jurisdiction issues defined therein. Any holder of this document is advised that information contained hereon reflects the Company's findings at the time of its intervention only and within the limits of Client's instructions, if any. The Company's sole responsibility is to its Client and this document does not exonerate parties to a transaction from exercising all their rights and obligations under the transaction documents. This document cannot be reproduced except in full, without prior written approval of the Company. Any unauthorized alteration, forgery or falsification of the content or appearance of this document is unlawful and offenders may be prosecuted to the fullest extent of the law. Unless otherwise stated the results shown in this test report refer only to the sample(s) tested and such sample(s) are retained for 30 days only.

Attention: To check the authenticity of testing /inspection report & certificate, please contact us at telephone: (86-755) 8307 1443, or email: CN\_Doccheck@sgs.com



Above 1GHz

**433.1MHz**

Mark	Frequency (MHz)	Reading (dBuV)	Factor (dB)	Emission (dBuV/m)	Limit (dBuV/m)	Over Limit (dB)	Detector	polarization
1	2197.000	48.54	-7.79	40.75	74.00	-33.25	peak	Vertical
2	2701.000	49.97	-6.55	43.42	74.00	-30.58	peak	Vertical
3	3826.000	48.30	-3.65	44.65	74.00	-29.35	peak	Vertical
4	2089.000	49.29	-8.04	41.25	74.00	-32.75	peak	Horizontal
5	2593.000	49.91	-6.72	43.19	74.00	-30.81	peak	Horizontal
6	3097.000	47.61	-5.59	42.02	74.00	-31.98	peak	Horizontal

**438.85MHz**

Mark	Frequency (MHz)	Reading (dBuV)	Factor (dB)	Emission (dBuV/m)	Limit (dBuV/m)	Over Limit (dB)	Detector	polarization
1	1783.000	52.36	-10.91	41.45	74.00	-32.55	peak	Vertical
2	2593.000	49.91	-6.72	43.19	74.00	-30.81	peak	Vertical
3	3223.000	46.99	-5.26	41.73	74.00	-32.27	peak	Vertical
4	1837.000	50.55	-10.32	40.23	74.00	-33.77	peak	Horizontal
5	2467.000	47.91	-7.11	40.80	74.00	-33.20	peak	Horizontal
6	3601.000	47.56	-4.50	43.06	74.00	-30.94	peak	Horizontal

**434.6MHz**

Mark	Frequency (MHz)	Reading (dBuV)	Factor (dB)	Emission (dBuV/m)	Limit (dBuV/m)	Over Limit (dB)	Detector	polarization
1	2143.000	47.99	-7.91	40.08	74.00	-33.92	peak	Vertical
2	3097.000	47.61	-5.59	42.02	74.00	-31.98	peak	Vertical
3	4258.000	46.81	-2.90	43.91	74.00	-30.09	peak	Vertical
4	2134.000	48.98	-7.93	41.05	74.00	-32.95	peak	Horizontal
5	2854.000	48.81	-6.27	42.54	74.00	-31.46	peak	Horizontal
6	4015.000	47.92	-3.97	43.95	74.00	-30.05	peak	Horizontal



Unless otherwise agreed in writing, this document is issued by the Company subject to its General Conditions of Service printed overleaf, available on request or accessible at <http://www.sgs.com/en/Terms-and-Conditions.aspx> and, for electronic format documents, subject to Terms and Conditions for Electronic Documents at <http://www.sgs.com/en/Terms-and-Conditions/Terms-e-Documents.aspx>. Attention is drawn to the limitation of liability, indemnification and jurisdiction issues defined therein. Any holder of this document is advised that information contained hereon reflects the Company's findings at the time of its intervention only and within the limits of Client's instructions, if any. The Company's sole responsibility is to its Client and this document does not exonerate parties to a transaction from exercising all their rights and obligations under the transaction documents. This document cannot be reproduced except in full, without prior written approval of the Company. Any unauthorized alteration, forgery or falsification of the content or appearance of this document is unlawful and offenders may be prosecuted to the fullest extent of the law. Unless otherwise stated the results shown in this test report refer only to the sample(s) tested and such sample(s) are retained for 30 days only.

Attention: To check the authenticity of testing /inspection report & certificate, please contact us at telephone: (86-755) 8307 1443, or email: [CN.Doccheck@sgs.com](mailto:CN.Doccheck@sgs.com)

### 6.4 20dB Bandwidth

#### E.U.T. Operation

Operating Environment:

Temperature: 22 °C Humidity: 50 % RH Atmospheric Pressure: 1020 mbar

Test mode

b:TX mode\_Keep the EUT in transmitting with modulation mode.

#### Test Setup:

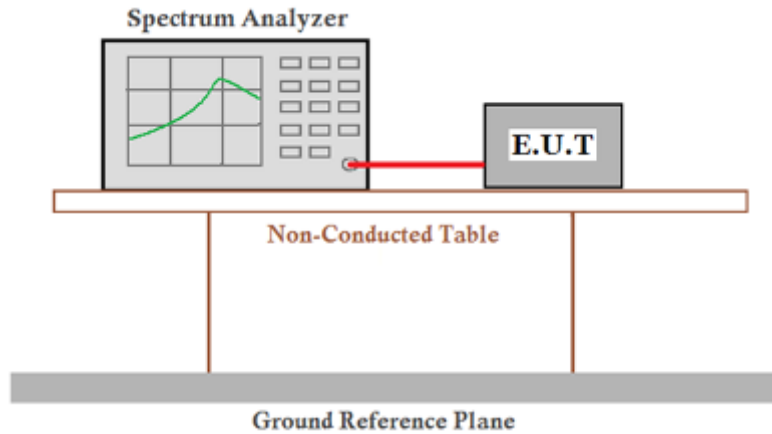

#### Limit:

The bandwidth of the emission shall be no wider than 0.25% of the center frequency for devices operating above 70 MHz and below 900 MHz. For devices operating above 900 MHz, the emission shall be no wider than 0.5% of the center frequency. Bandwidth is determined at the points 20 dB down from the modulated carrier.

#### Test Results:

Pass

Frequency(MHz)	20dB bandwidth (kHz)	Limit (kHz)	Results
433.10	64.23	1083	Pass
433.85	61.94	1085	Pass
434.60	61.65	1087	Pass



Unless otherwise agreed in writing, this document is issued by the Company subject to its General Conditions of Service printed overleaf, available on request or accessible at <http://www.sgs.com/en/Terms-and-Conditions.aspx> and, for electronic format documents, subject to Terms and Conditions for Electronic Documents at <http://www.sgs.com/en/Terms-and-Conditions/Terms-e-Document.aspx>. Attention is drawn to the limitation of liability, indemnification and jurisdiction issues defined therein. Any holder of this document is advised that information contained hereon reflects the Company's findings at the time of its intervention only and within the limits of Client's instructions, if any. The Company's sole responsibility is to its Client and this document does not exonerate parties to a transaction from exercising all their rights and obligations under the transaction documents. This document cannot be reproduced except in full, without prior written approval of the Company. Any unauthorized alteration, forgery or falsification of the content or appearance of this document is unlawful and offenders may be prosecuted to the fullest extent of the law. Unless otherwise stated the results shown in this test report refer only to the sample(s) tested and such sample(s) are retained for 30 days only.

Attention: To check the authenticity of testing /inspection report & certificate, please contact us at telephone: (86-755) 8307 1443, or email: CN\_Doccheck@sgs.com

Test plot as follows:  
433.1MHz

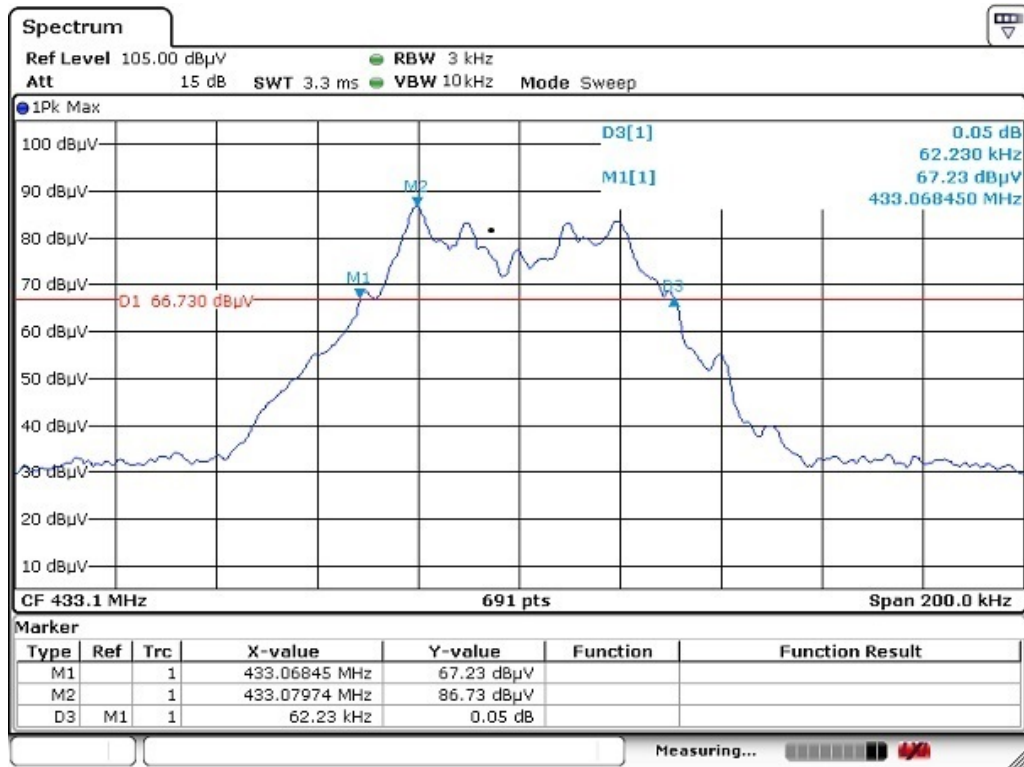

433.85MHz

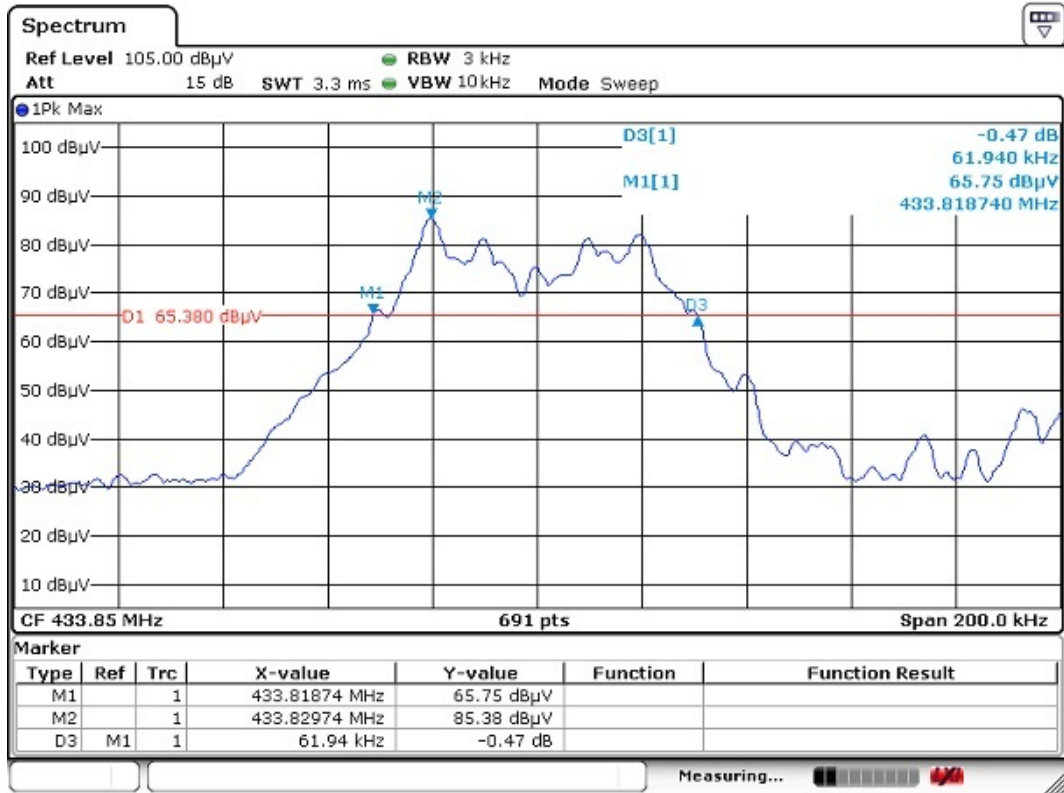

Unless otherwise agreed in writing, this document is issued by the Company subject to its General Conditions of Service printed overleaf, available on request or accessible at <http://www.sgs.com/en/Terms-and-Conditions.aspx> and, for electronic format documents, subject to Terms and Conditions for Electronic Documents at <http://www.sgs.com/en/Terms-and-Conditions/Terms-e-Documents.aspx>. Attention is drawn to the limitation of liability, indemnification and jurisdiction issues defined therein. Any holder of this document is advised that information contained hereon reflects the Company's findings at the time of its intervention only and within the limits of Client's instructions, if any. The Company's sole responsibility is to its Client and this document does not exonerate parties to a transaction from exercising all their rights and obligations under the transaction documents. This document cannot be reproduced except in full, without prior written approval of the Company. Any unauthorized alteration, forgery or falsification of the content or appearance of this document is unlawful and offenders may be prosecuted to the fullest extent of the law. Unless otherwise stated the results shown in this test report refer only to the sample(s) tested and such sample(s) are retained for 30 days only.

Attention: To check the authenticity of testing /inspection report & certificate, please contact us at telephone: (86-755) 8307 1443, or email: CN.Doccheck@sgs.com

434.6MHz

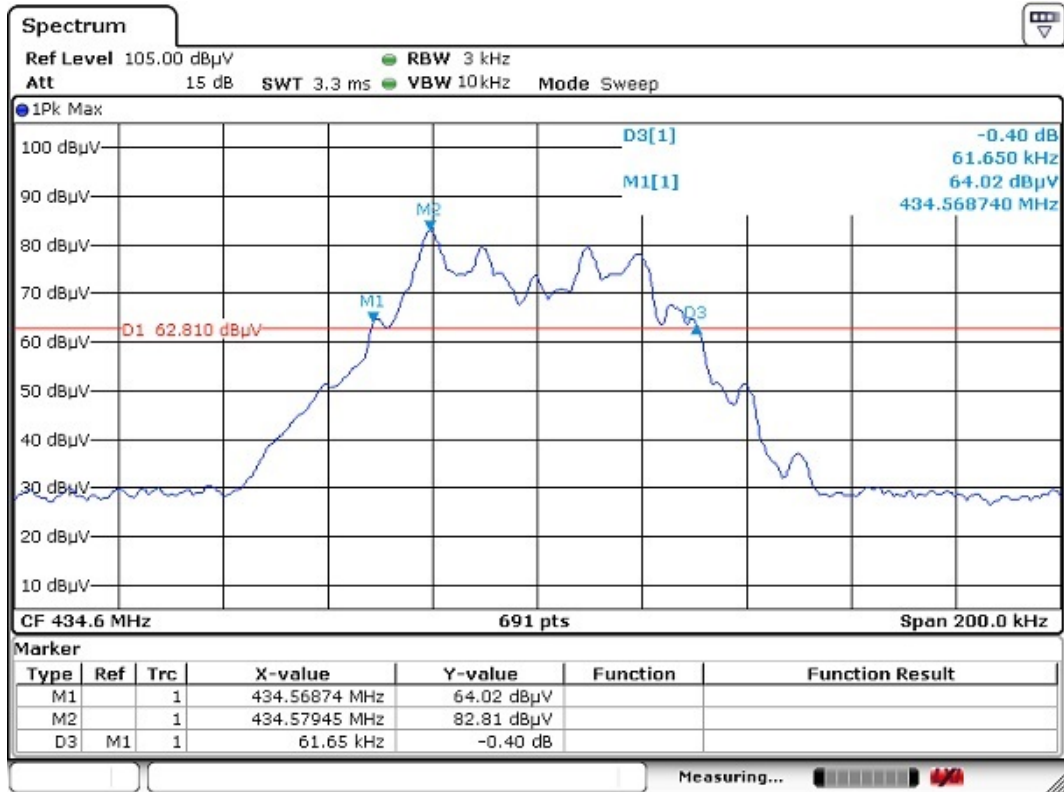

Unless otherwise agreed in writing, this document is issued by the Company subject to its General Conditions of Service printed overleaf, available on request or accessible at <http://www.sgs.com/en/Terms-and-Conditions.aspx> and, for electronic format documents, subject to Terms and Conditions for Electronic Documents at <http://www.sgs.com/en/Terms-and-Conditions/Terms-e-Document.aspx>. Attention is drawn to the limitation of liability, indemnification and jurisdiction issues defined therein. Any holder of this document is advised that information contained hereon reflects the Company's findings at the time of its intervention only and within the limits of Client's instructions, if any. The Company's sole responsibility is to its Client and this document does not exonerate parties to a transaction from exercising all their rights and obligations under the transaction documents. This document cannot be reproduced except in full, without prior written approval of the Company. Any unauthorized alteration, forgery or falsification of the content or appearance of this document is unlawful and offenders may be prosecuted to the fullest extent of the law. Unless otherwise stated the results shown in this test report refer only to the sample(s) tested and such sample(s) are retained for 30 days only.

### 6.5 Dwell Time

#### E.U.T. Operation

Operating Environment:

Temperature: 22 °C Humidity: 50 % RH Atmospheric Pressure: 1020 mbar

Test mode

b:TX mode\_Keep the EUT in transmitting with modulation mode.

#### Test Setup:

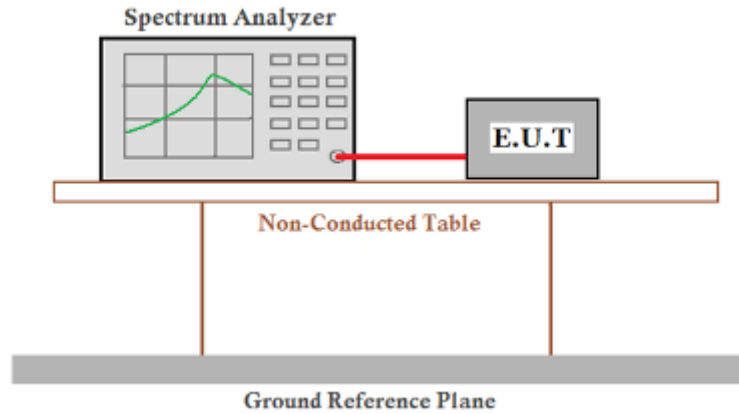

Limit: 15.231 (a): Not more than 5 seconds

Test Results: Pass

#### Measurement Data:

Test item	Limit (s)	Results
Transmission Duration	≤5s	Pass



Unless otherwise agreed in writing, this document is issued by the Company subject to its General Conditions of Service printed overleaf, available on request or accessible at <http://www.sgs.com/en/Terms-and-Conditions.aspx> and, for electronic format documents, subject to Terms and Conditions for Electronic Documents at <http://www.sgs.com/en/Terms-and-Conditions/Terms-e-Document.aspx>. Attention is drawn to the limitation of liability, indemnification and jurisdiction issues defined therein. Any holder of this document is advised that information contained hereon reflects the Company's findings at the time of its intervention only and within the limits of Client's instructions, if any. The Company's sole responsibility is to its Client and this document does not exonerate parties to a transaction from exercising all their rights and obligations under the transaction documents. This document cannot be reproduced except in full, without prior written approval of the Company. Any unauthorized alteration, forgery or falsification of the content or appearance of this document is unlawful and offenders may be prosecuted to the fullest extent of the law. Unless otherwise stated the results shown in this test report refer only to the sample(s) tested and such sample(s) are retained for 30 days only.

Attention: To check the authenticity of testing /inspection report & certificate, please contact us at telephone: (86-755) 8307 1443, or email: [CN\\_Doccheck@sgs.com](mailto:CN_Doccheck@sgs.com)

Test plot as follows: 433.1MHz

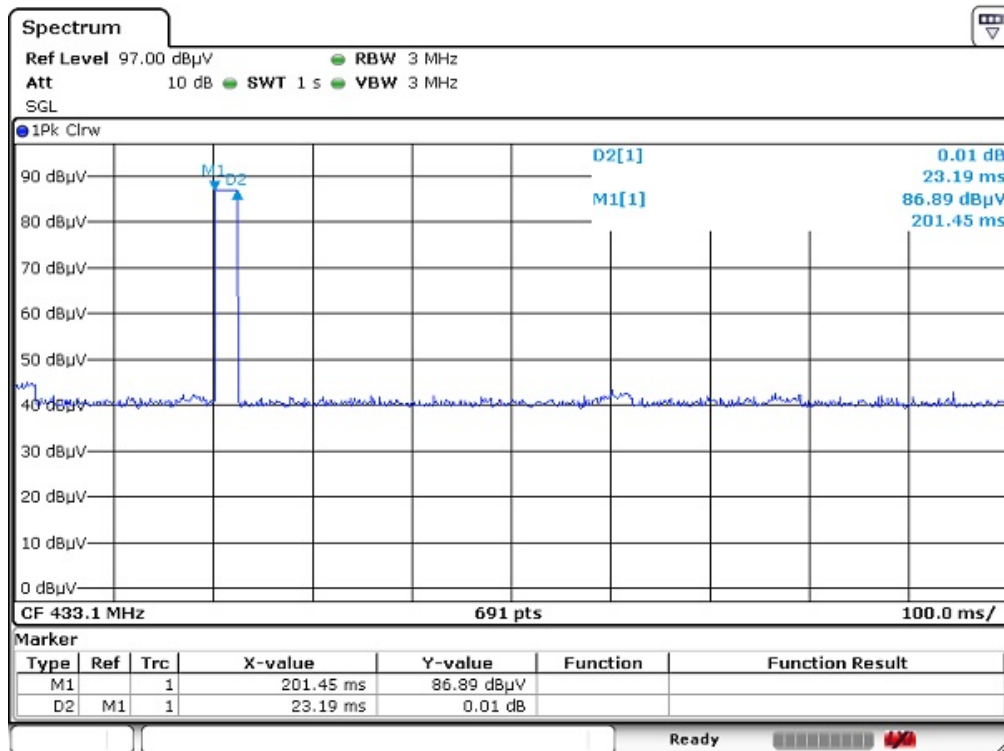
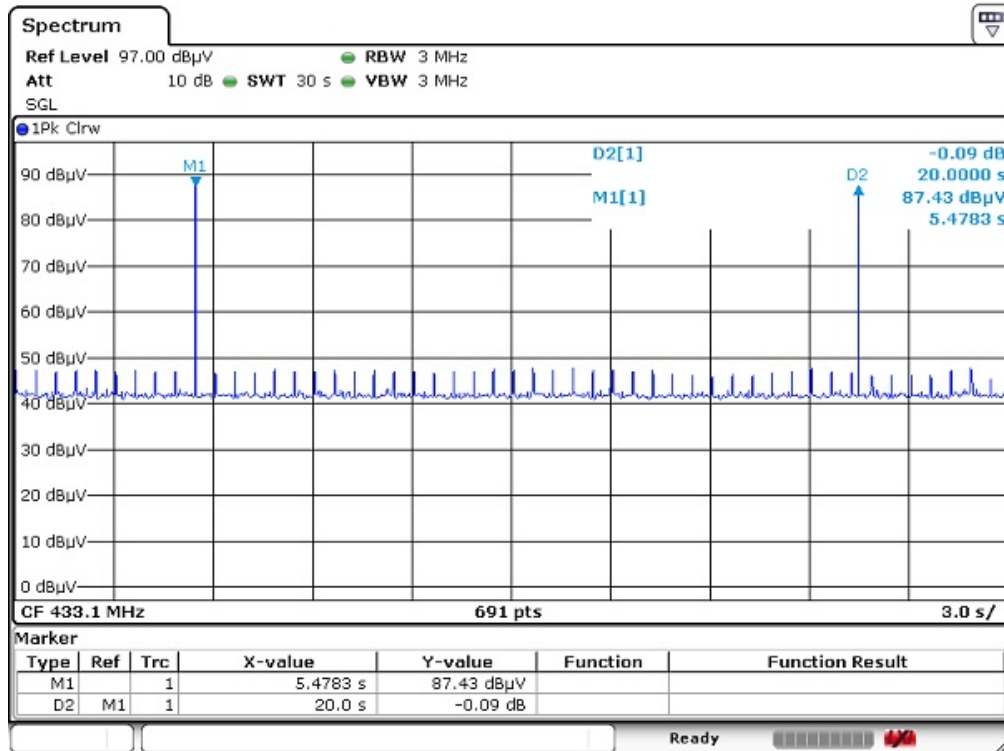

Unless otherwise agreed in writing, this document is issued by the Company subject to its General Conditions of Service printed overleaf, available on request or accessible at <http://www.sgs.com/en/Terms-and-Conditions.aspx> and, for electronic format documents, subject to Terms and Conditions for Electronic Documents at <http://www.sgs.com/en/Terms-and-Conditions/Terms-e-Document.aspx>. Attention is drawn to the limitation of liability, indemnification and jurisdiction issues defined therein. Any holder of this document is advised that information contained hereon reflects the Company's findings at the time of its intervention only and within the limits of Client's instructions, if any. The Company's sole responsibility is to its Client and this document does not exonerate parties to a transaction from exercising all their rights and obligations under the transaction documents. This document cannot be reproduced except in full, without prior written approval of the Company. Any unauthorized alteration, forgery or falsification of the content or appearance of this document is unlawful and offenders may be prosecuted to the fullest extent of the law. Unless otherwise stated the results shown in this test report refer only to the sample(s) tested and such sample(s) are retained for 30 days only.

Attention: To check the authenticity of testing /inspection report and certificate, please contact us at telephone: (86-755) 8307 1443, or email: [CN.Doccheck@sgs.com](mailto:CN.Doccheck@sgs.com)

433.85MHz

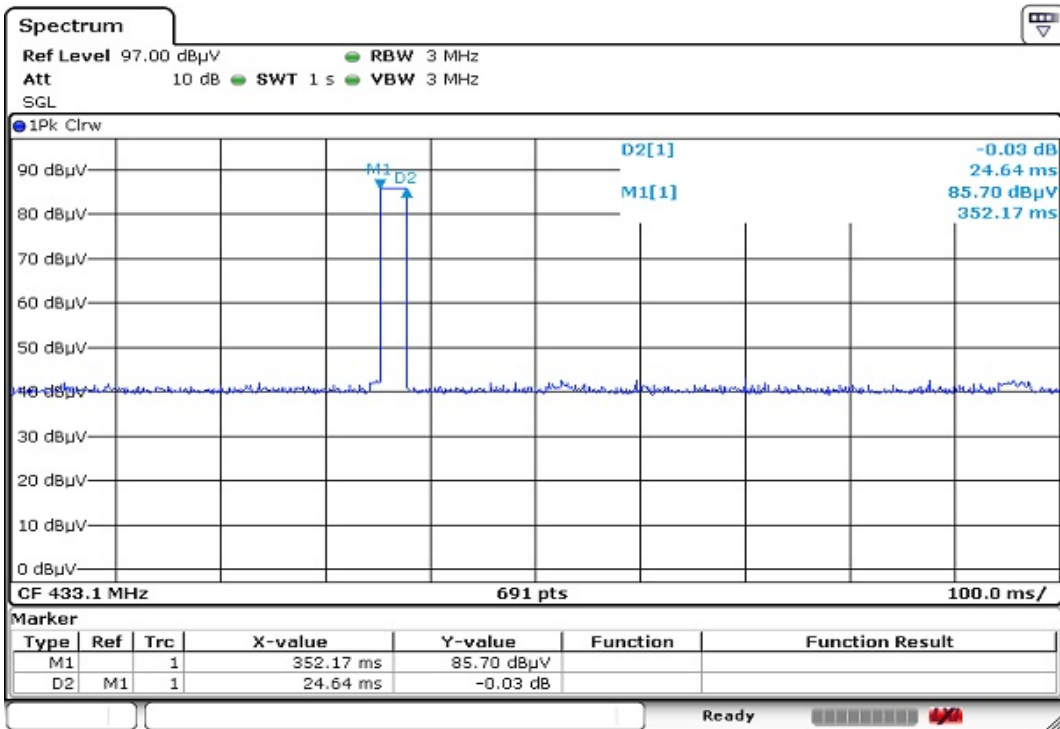
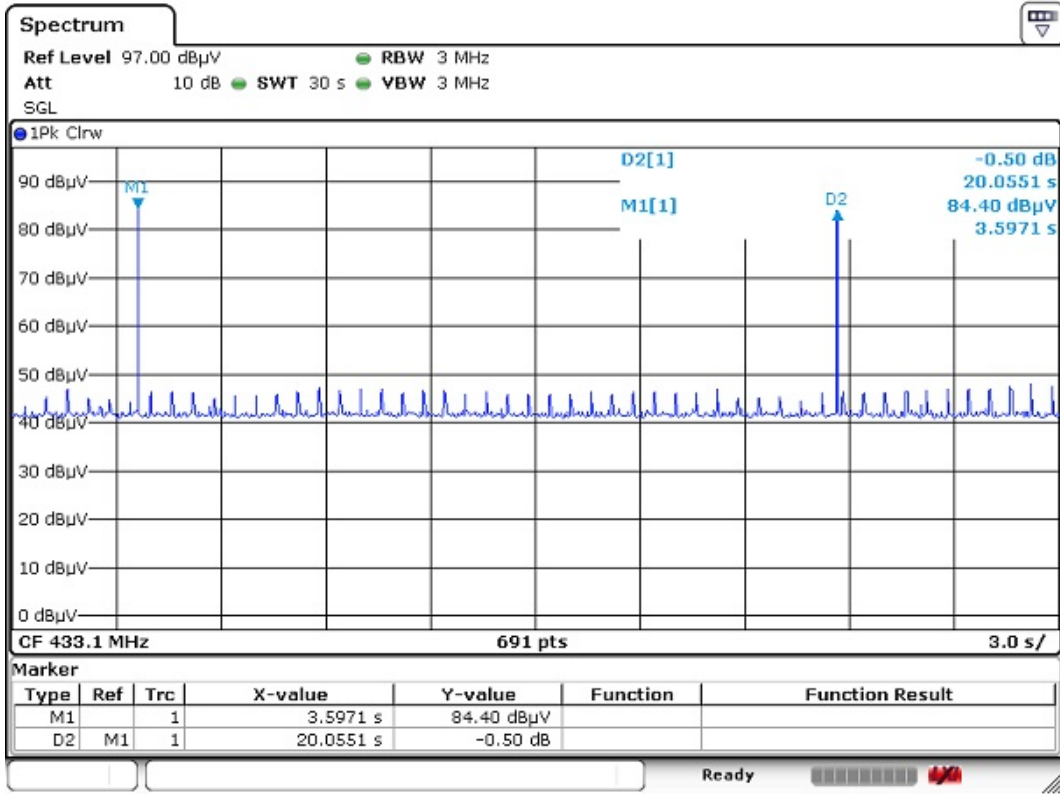

Unless otherwise agreed in writing, this document is issued by the Company subject to its General Conditions of Service printed overleaf, available on request or accessible at <http://www.sgs.com/en/Terms-and-Conditions.aspx> and, for electronic format documents, subject to Terms and Conditions for Electronic Documents at <http://www.sgs.com/en/Terms-and-Conditions/Terms-e-Documents.aspx>. Attention is drawn to the limitation of liability, indemnification and jurisdiction issues defined therein. Any holder of this document is advised that information contained hereon reflects the Company's findings at the time of its intervention only and within the limits of Client's instructions, if any. The Company's sole responsibility is to its Client and this document does not exonerate parties to a transaction from exercising all their rights and obligations under the transaction documents. This document cannot be reproduced except in full, without prior written approval of the Company. Any unauthorized alteration, forgery or falsification of the content or appearance of this document is unlawful and offenders may be prosecuted to the fullest extent of the law. Unless otherwise stated the results shown in this test report refer only to the sample(s) tested and such sample(s) are retained for 30 days only.

Attention: To check the authenticity of testing /inspection report & certificate, please contact us at telephone: (86-755) 8307 1443, or email: [CN.Doccheck@sgs.com](mailto:CN.Doccheck@sgs.com)



434.6MHz

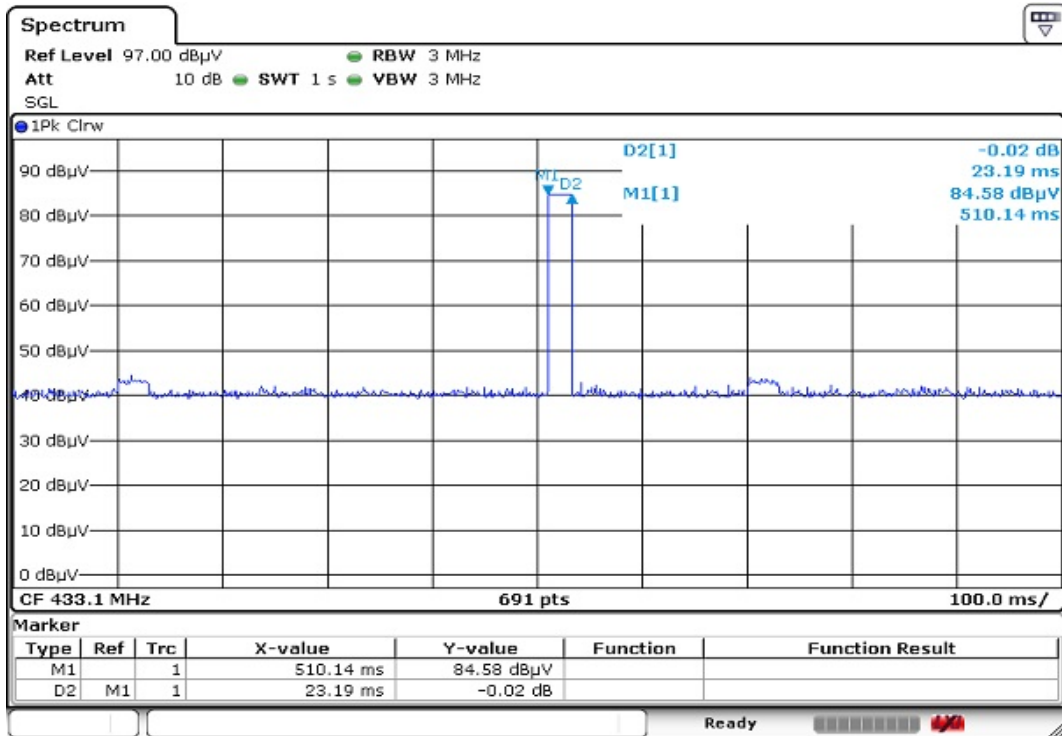
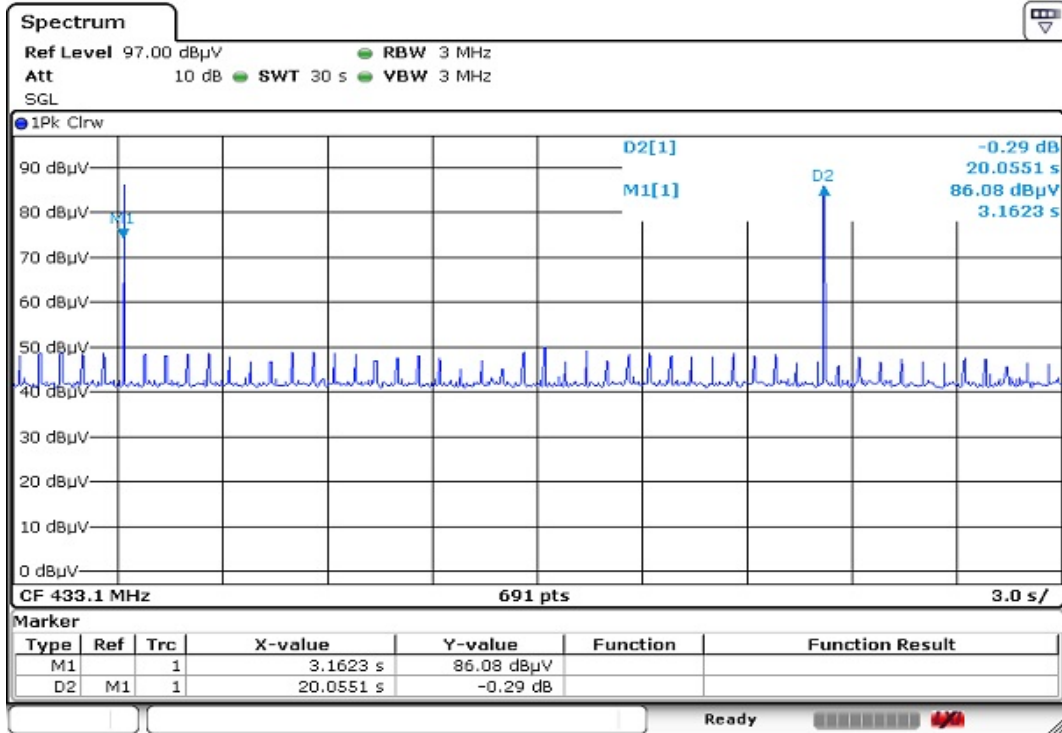

Unless otherwise agreed in writing, this document is issued by the Company subject to its General Conditions of Service printed overleaf, available on request or accessible at <http://www.sgs.com/en/Terms-and-Conditions.aspx> and, for electronic format documents, subject to Terms and Conditions for Electronic Documents at <http://www.sgs.com/en/Terms-and-Conditions/Terms-e-Documents.aspx>. Attention is drawn to the limitation of liability, indemnification and jurisdiction issues defined therein. Any holder of this document is advised that information contained hereon reflects the Company's findings at the time of its intervention only and within the limits of Client's instructions, if any. The Company's sole responsibility is to its Client and this document does not exonerate parties to a transaction from exercising all their rights and obligations under the transaction documents. This document cannot be reproduced except in full, without prior written approval of the Company. Any unauthorized alteration, forgery or falsification of the content or appearance of this document is unlawful and offenders may be prosecuted to the fullest extent of the law. Unless otherwise stated the results shown in this test report refer only to the sample(s) tested and such sample(s) are retained for 30 days only.

Attention: To check the authenticity of testing /inspection report & certificate, please contact us at telephone: (86-755) 8307 1443, or email: [CN.Doccheck@sgs.com](mailto:CN.Doccheck@sgs.com)



## 7 Test Setup Photographs

Refer to the < Test Setup photos-FCC >.

## 8 EUT Constructional Details

Refer to the < External Photos > & <Internal Photos >.

**--End of the Report--**



Unless otherwise agreed in writing, this document is issued by the Company subject to its General Conditions of Service printed overleaf, available on request or accessible at <http://www.sgs.com/en/Terms-and-Conditions.aspx> and, for electronic format documents, subject to Terms and Conditions for Electronic Documents at <http://www.sgs.com/en/Terms-and-Conditions/Terms-e-Document.aspx>. Attention is drawn to the limitation of liability, indemnification and jurisdiction issues defined therein. Any holder of this document is advised that information contained hereon reflects the Company's findings at the time of its intervention only and within the limits of Client's instructions, if any. The Company's sole responsibility is to its Client and this document does not exonerate parties to a transaction from exercising all their rights and obligations under the transaction documents. This document cannot be reproduced except in full, without prior written approval of the Company. Any unauthorized alteration, forgery or falsification of the content or appearance of this document is unlawful and offenders may be prosecuted to the fullest extent of the law. Unless otherwise stated the results shown in this test report refer only to the sample(s) tested and such sample(s) are retained for 30 days only.

Attention: To check the authenticity of testing /inspection report & certificate, please contact us at telephone: (86-755) 8307 1443, or email: [CN.Doccheck@sgs.com](mailto:CN.Doccheck@sgs.com)