



Wireless External Siren

User's Manual







Foreword

General

This manual introduces the functions and operations of the wireless outdoor siren (hereinafter referred to as "the siren").

Safety Instructions

The following signal words might appear in the manual.

Signal Words	Meaning
 DANGER	Indicates a high potential hazard which, if not avoided, will result in death or serious injury.
 WARNING	Indicates a medium or low potential hazard which, if not avoided, could result in slight or moderate injury.
 CAUTION	Indicates a potential risk which, if not avoided, could result in property damage, data loss, reductions in performance, or unpredictable results.
 TIPS	Provides methods to help you solve a problem or save time.
 NOTE	Provides additional information as a supplement to the text.

Revision History

Version	Revision Content	Release Time
V1.0.0	First release	December 2021

Privacy Protection Notice

As the device user or data controller, you might collect the personal data of others such as their face, fingerprints, and license plate number. You need to be in compliance with your local privacy protection laws and regulations to protect the legitimate rights and interests of other people by implementing measures which include but are not limited: Providing clear and visible identification to inform people of the existence of the surveillance area and provide required contact information.

About the Manual

- The manual is for reference only. Slight differences might be found between the manual and the product.
- We are not liable for losses incurred due to operating the product in ways that are not in compliance with the manual.
- The manual will be updated according to the latest laws and regulations of related jurisdictions. For detailed information, see the paper user's manual, use our CD-ROM, scan the QR code or visit our official website. The manual is for reference only. Slight differences might be found between the electronic version and the paper version.

- All designs and software are subject to change without prior written notice. Product updates might result in some differences appearing between the actual product and the manual. Please contact customer service for the latest program and supplementary documentation.
- There might be errors in the print or deviations in the description of the functions, operations and technical data. If there is any doubt or dispute, we reserve the right of final explanation.
- Upgrade the reader software or try other mainstream reader software if the manual (in PDF format) cannot be opened.
- All trademarks, registered trademarks and company names in the manual are properties of their respective owners.
- Please visit our website, contact the supplier or customer service if any problems occur while using the device.
- If there is any uncertainty or controversy, we reserve the right of final explanation.

Important Safeguards and Warnings

This section introduces content covering the proper handling of the Device, hazard prevention, and prevention of property damage. Read carefully before using the Device, comply with the guidelines when using it, and keep the manual safe for future reference.

Operation Requirements



- Make sure that the power supply of the device works properly before use.
- Do not pull out the power cable of the device while it is powered on.
- Only use the device within the rated power range.
- Transport, use and store the device under allowed humidity and temperature conditions.
- Prevent liquids from splashing or dripping on the device. Make sure that there are no objects filled with liquid on top of the device to avoid liquids flowing into it.
- Do not disassemble the device.

Installation Requirements



WARNING

- Connect the device to the adapter before power on.
- Strictly abide by local electrical safety standards, and make sure that the voltage in the area is steady and conforms to the power requirements of the device.
- Do not connect the device to more than one power supply. Otherwise, the device might become damaged.



- Observe all safety procedures and wear required protective equipment provided for your use while working at heights.
- Do not expose the device to direct sunlight or heat sources.
- Do not install the device in humid, dusty or smoky places.
- Install the device in a well-ventilated place, and do not block the ventilator of the device.
- Use the power adapter or case power supply provided by the device manufacturer.
- The power supply must conform to the requirements of ES1 in IEC 62368-1 standard and be no higher than PS2. Note that the power supply requirements are subject to the device label.
- Connect class I electrical appliances to a power socket with protective earthing.

Table of Contents

Foreword	I
Important Safeguards and Warnings	III
1 Introduction	1
1.1 Overview	1
1.2 Technical Specification	1
2 Checklist	3
3 Design	4
3.1 Appearance	4
3.2 Dimensions	5
4 Power On	6
5 Connecting to the Hub	7
6 Installation	8
7 Configuration	9
7.1 Viewing Status	9
7.2 Configuring the Siren	10

1 Introduction

1.1 Overview

Wireless outdoor siren is an outdoor siren that alarms loudly when an alarm event occurs, attracting the attention of everyone within its vicinity. It features danger warning, intrusion determent, and is used in outdoor scenes such as in villas, homes, and on streets.

1.2 Technical Specification

Please refer to the corresponding technical specifications according to the corresponding models.

Table 1-1 Technical specification

Type	Parameter	Description	
Function	Remote Update	Cloud update	
	Low Battery Alarm	Yes	
	Battery Level Display	Yes	
	Tamper	Yes	
	Signal Strength	Signal strength detection	
	Temperature Measurement	-30 °C to + 70°C (-22 °F to + 158 °F) (outdoor)	
Wireless	Carrier Frequency	868.0 MHz–868.6 MHz (DHI-ARA13-W2 (868))	433.1 MHz–434.6 MHz (DHI-ARA13-W2)
	Transmission Power	Limit 25 mW (DHI-ARA13-W2 (868))	Limit 10 mW (DHI-ARA13-W2)
	Communication Distance	Up to 1,600 m (5,249.34 ft) in an open space (DHI-ARA13-W2 (868))	Up to 1,200 m (3,937.01 ft) in an open space (DHI-ARA13-W2)
	Communication Mechanism	Two-way	
	Frequency Hopping	Yes	
	Encryption Mode	AES128	
General	Power Supply Mode	Battery (default), 12 VDC	
	Battery Model	4 × CR123A	
	Battery Voltage	3 VDC	
	Min. Voltage	2.6 VDC	
	Battery Low Threshold	2.8 VDC	

Type	Parameter	Description
	Consumption	<ul style="list-style-type: none"> Quiescent current: 92 uA Max. current: 420 mA
	PS Type	Type B
	Battery Life	4 CR123A batteries can be used for 3.4 years (if triggered fortnightly and the alarm sounds for 120 s each time with a battery efficiency of 80%)
	Operating Temperature	-20 °C to +65 °C (-4 °F to +149 °F)
	Operating Humidity	10%–90% (RH)
	Product Dimensions	200 mm × 200 mm × 52.5 mm (7.87" × 7.87" × 2.07") (L × W × H)
	Packaging Dimensions	255 mm × 239 mm × 64 mm (10.04" × 9.41" × 2.52") (L × W × H)
	Net Weight	610 g (1.34 lb)
	Gross Weight	920 g (2.03 lb)
	Installation	Wall mount
	Casing	PC + ABS
	Protection	IP65
Technical	Indicator Light	<ul style="list-style-type: none"> 1 × green pairing indicator 12 × alarm LED group
	Button	1 × power switch
	Scenario	Outdoor
	Sound and Light Alarm	Light alarm and multiple alarm sounds, including fire, medical, intrusion, panic, and more.
	Sound Pressure	110 dB
Certifications	CE DHI-ARA13-W2 (868)	FCC DHI-ARA13-W2

2 Checklist

Check the package according to the following checklist. If you find device damage or any loss, contact the after-sales service.

Figure 2-1 Checklist

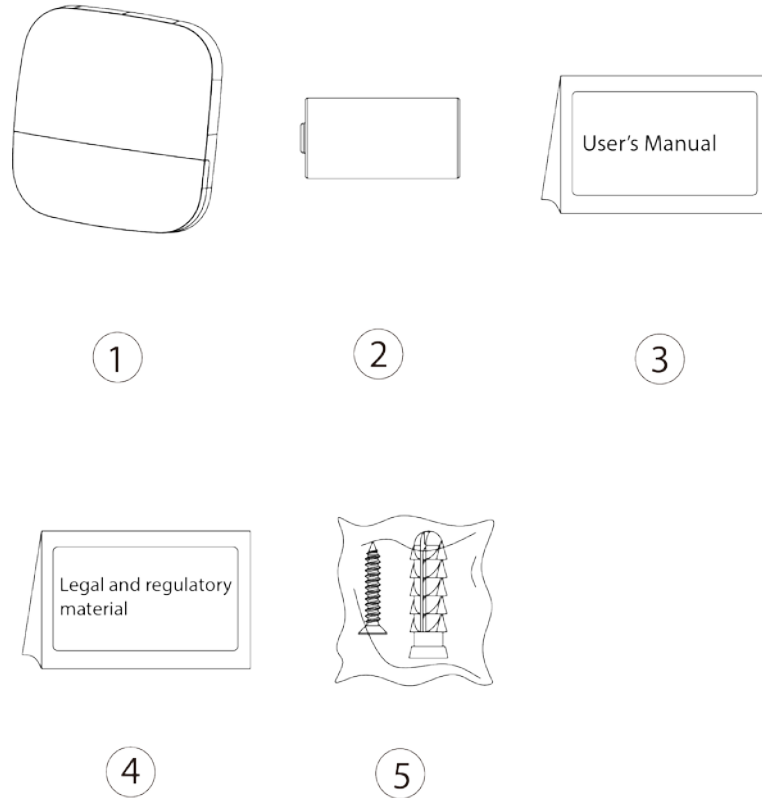

Table 2-1 Checklist

No.	Item	No.	Item
1	Wireless outdoor siren	4	Legal and regulatory information
2	CR123A battery × 4	5	Screw package
3	User's manual	—	—

3 Design

3.1 Appearance

Figure 3-1 Appearance

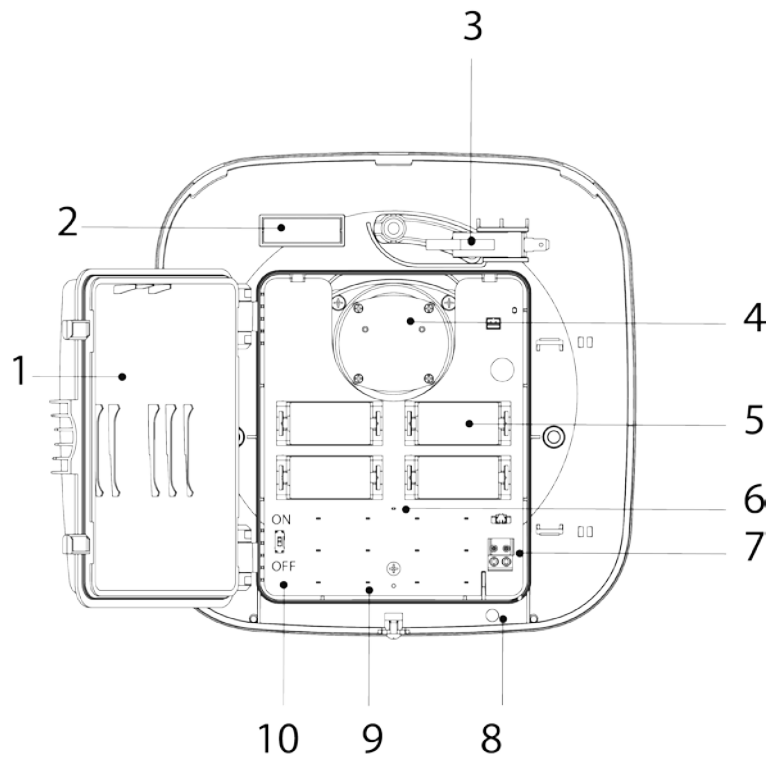

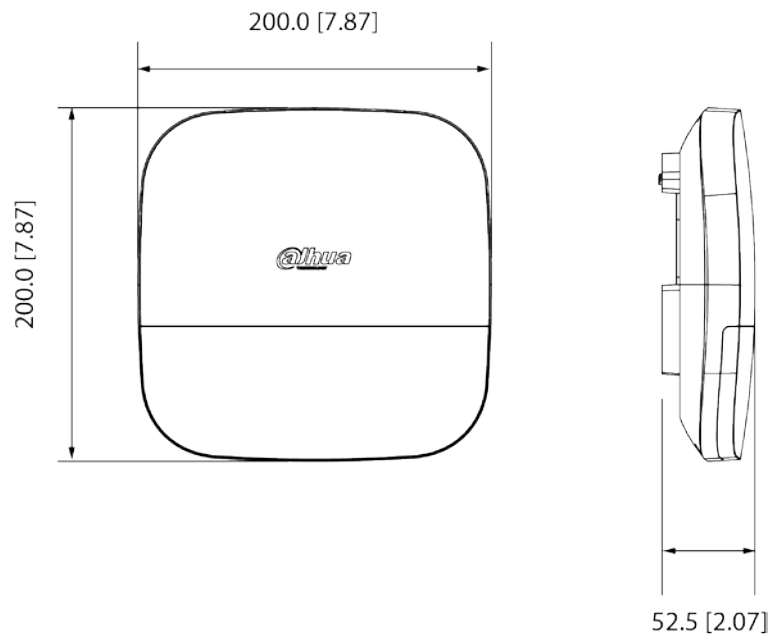

Table 3-1 Structure

No.	Name	Description
1	Waterproof cover	Protects the siren from water and dust.
2	Spirit level	Indicates whether the siren is horizontal and level.
3	Tamper switch	When the tamper switch is released, the tamper alarm will be triggered.
4	Buzzer	Alarms loudly when an alarm event occurs.
5	Battery	Install CR123A batteries according to the polarity mark.
6	Pairing indicator	<ul style="list-style-type: none"> Flashes green quickly: Pairing. Solid green for 2 seconds: Pairing successful. Slowly flashes green for 3 seconds: Pairing failed.
7	12 VDC power terminal	Insert the 12 VDC power cable.  The cable is not included in the package.
8	Power cable knockout	The entry for wiring the power cable.
9	Alarm indicator	Flashes quickly when an alarm event occurs.
10	On/Off switch	Turn on or turn off the siren.

3.2 Dimensions

Figure 3-2 Dimensions (mm [inch])



4 Power On

Step 1 Open the front panel of the siren.

Figure 4-1 Open the front panel

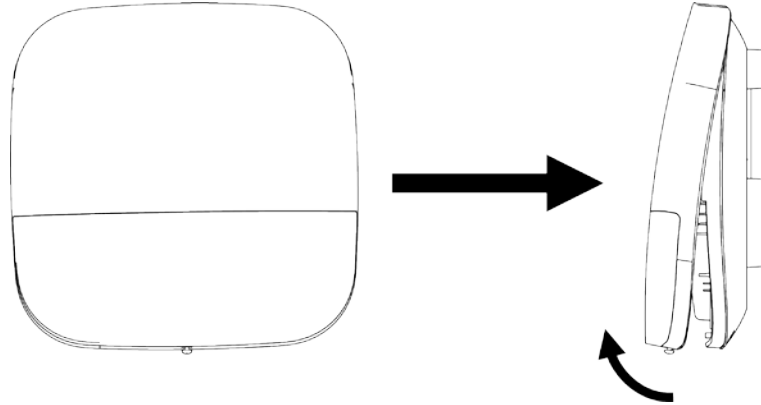

Step 2 Open the waterproof cover.

Figure 4-2 Open the waterproof cover

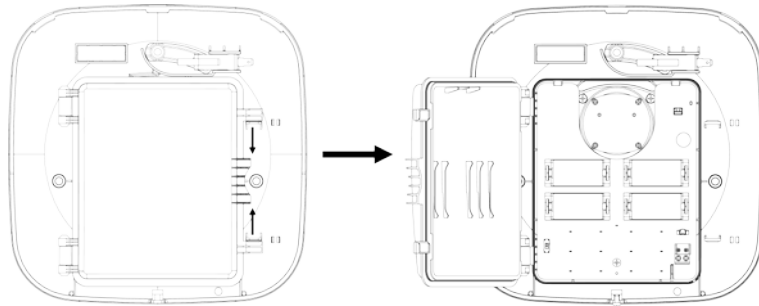

Step 3 Power on.

- Battery power: Install four CR123A batteries according to the polarity mark.
- 12 VDC power (Optional): Feed the 12 VDC power cable into the case through the power cable knockout.

Step 4 Push the power switch to ON.

5 Connecting to the Hub

Before you connect the siren to the hub, install the DMSS app to your phone. This manual uses iOS as an example.



- Make sure the version of the DMSS app is 1.96 or later, and the hub is V1.001.R.211209 or later.
- Make sure that you have already created an account, and added the hub to DMSS.
- Make sure that the hub has a stable internet connection.
- Make sure that the hub is disarmed.

Step 1 Go to the hub screen, and then tap  to add the siren.

Step 2 Tap  to scan the QR code at the bottom of the siren, and then tap **Next**.

Step 3 Tap **Next** after the siren has been found.

Step 4 Follow the on-screen instructions and switch the siren to on, and then tap **Next**.

Step 5 Wait for the pairing.

Step 6 Customize the name of the siren, and select the area, and then tap **Completed**.

6 Installation

Prior to installation, power on the siren, connect it to the hub, and then check the signal strength of the installation location. We recommend installing the siren in a place with a signal strength of at least 2 bars.

Figure 6-1 Installation

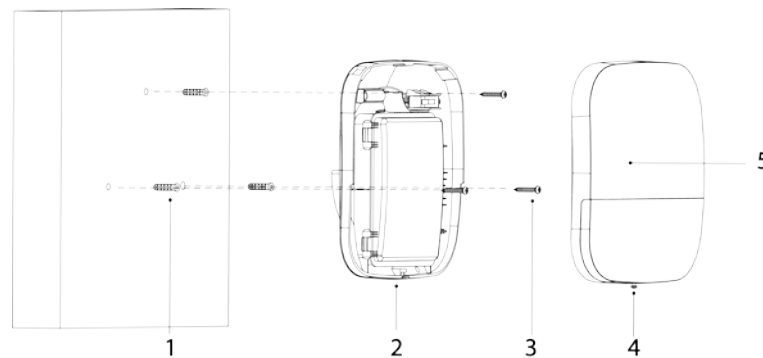

Table 6-1 Installation items

No.	Item Name	No.	Item Name
1	Expansion bolt	4	Screw
2	Rear panel	5	Front panel
3	ST4 × 25 mm self-tapping screw	—	—

- Step 1** Loosen the screw at the bottom of the siren to remove the front panel.
- Step 2** Set the siren into a horizontal position. Use the spirit level to make sure the siren is horizontal and level.
- Step 3** Put the expansion bolts into the holes.
- Step 4** Align the screw holes on the rear panel with the expansion bolts.
- Step 5** Secure the rear panel with three ST4 × 25 mm self-tapping screws.
- Step 6** Tighten the screw at the bottom of the front panel to secure the siren.

















7 Configuration

You can view and edit general information of the siren.

7.1 Viewing Status

On the **Hub** screen, select a siren from the accessory list, and then you can view the status of the siren.

Table 7-1 Status

Parameter	Description
Temporary Deactivate	The status for whether the functions of the siren are enabled or disabled. <ul style="list-style-type: none"> • : Enable. • : Only disable tamper alarm. • : Disable.
Temperature	The temperature of the environment.
Signal Strength	The signal strength between the hub and the siren. <ul style="list-style-type: none"> • : Low. • : Weak. • : Good. • : Excellent. • : No.
External Power Status	Whether there is a 12 VDC power failure alarm. <ul style="list-style-type: none"> • : No. • : Yes.
Battery Level	The battery level of the siren. <ul style="list-style-type: none"> • : Fully charged. • : Sufficient. • : Moderate. • : Insufficient.
Anti-tampering Status	The tamper mode of the accessory, which reacts to the detachment of the body.
Online Status	Online and offline status of the siren. <ul style="list-style-type: none"> • : Online. • : Offline.
Volume	Alarm volume level.
Alarm Duration	Duration of the alarm sound.
Enter/Exit Arming and Disarming Ringtone	The ringtone when entering or exiting arming mode.
Beep Volume	High, medium and low.

Parameter	Description
Relay Status	The status of whether the siren forwards accessory messages to the hub through the repeater.
Program Version	The program version of the siren.

7.2 Configuring the Siren



On the **Hub** screen, select a siren from the accessory list, and then tap  to configure the parameters of the siren.

Table 7-2 Siren parameter description

Parameter	Description
Device Configuration	<ul style="list-style-type: none"> View device name, type, SN and device model. Edit device name, and then tap Save to save your configurations.
Area	Select the area to which the siren is assigned.
Temporary Deactivate	<ul style="list-style-type: none"> Tap Enable, and then the function of the siren will be enabled. Enable is set by default. Tap Only Disable Tamper Alarm, and then the system will only ignore tamper alarm messages. Tap Disable, and then the function of the siren will be disabled.
Control Permissions	Select areas to which the siren will be linked when an alarm is triggered.
External Power Detection	If External Power Detection is enabled, power failure alarm messages will be pushed to the DMSS.
LED Indicator	<p>LED Indicator is enabled by default. For details on indicator behavior, see "3.1 Appearance".</p>  <p>If LED Indicator is disabled, the LED indicator will remain off regardless of whether the siren is functioning normally or not.</p>
Sound Settings	<ul style="list-style-type: none"> Configure volume level of the alarm sound. Select from low, medium, and high. Enable or disable the function of beep during arming and disarming, and enter and exit delay.
Alarm Duration	<ul style="list-style-type: none"> Configure the duration of the alarm sound. Select from 3 s through 80 s.
Alarm Status Indication	<p>If Alarm Status Indication is enabled, the LED indicator will turn on when an alarm is triggered in an armed area.</p> <p>The LED indicator will flash twice every minute if an area has not been disarmed, and an alarm event ended 30 seconds before.</p>

Parameter	Description
Beep Volume	Set beep volume during arming and disarming, and enter and exit delay. Select from High, Medium and Low .
Signal Strength Detection	Check the current signal strength.
Speaker Test	Tap Start Detection to test the volume level of the alarm.
Transmit Power	<ul style="list-style-type: none">• Select from high, low, and automatic.• The higher transmission power levels are, the further transmissions can travel, but power consumption increases.
Cloud Update	Update online.

ENABLING A SAFER SOCIETY AND SMARTER LIVING

ZHEJIANG DAHUA VISION TECHNOLOGY CO., LTD.

Address: No.1199 Bin'an Road, Binjiang District, Hangzhou, P. R. China | Website: www.dahuasecurity.com | Postcode: 310053

Email: overseas@dahuatech.com | Fax: +86-571-87688815 | Tel: +86-571-87688883

