



**FCC 47 CFR PART 15 SUBPART C  
CERTIFICATION TEST REPORT**

*For*

**Wi-Fi Villa Door Station**

**MODEL NUMBER: DHI-VTO3311Q-WP**

**ADDITIONAL MODEL NUMBER: VTO3311Q-WP**

**PROJECT NUMBER: 4790209817-3**

**REPORT NUMBER: 4790209817-3-17**

**FCC ID: SVN-3311Q-WP**

**ISSUE DATE: Jan. 20, 2022**

*Prepared for*

**Zhejiang Dahua Vision Technology Co., Ltd.**

*Prepared by*

**UL-CCIC COMPANY LIMITED**

**No. 2, Chengwan Road, Suzhou Industrial Park, People's Republic of China**

**T: + 86-512-6808 6400**

**F: + 86-512-6808 4099**

**Website: [www.ul.com](http://www.ul.com)**

10-EM-F0876 – Issue 1.0

The results reported herein have been performed in accordance with the laboratory's terms of accreditation. This report shall not be reproduced except in full without the written approval of the Laboratory. The results in this report apply to the test sample(s) mentioned above at the time of the testing period only and are not to be used to indicate applicability to other similar products.



Revision History

<u>Rev.</u>	<u>Issue Date</u>	<u>Revisions</u>	<u>Revised By</u>
V0	01/20/2022	Initial Issue	



Summary of Test Results			
Clause	Test Items	FCC Rules	Test Results
1	Transmitter AC Conducted Emissions	Part 15.207	PASS
2	Transmitter Fundamental Field Strength	Part 15.225(a)(b)(c)(d)	PASS
3	Transmitter Radiated Emissions	Part 15.209(a)/ 15.225(d)	PASS
4	Transmitter 20dB Bandwidth	Part 15.215 (c)	PASS
5	Transmitter Frequency Stability (Temperature & Voltage Variation)	Part 15.225(e)	PASS
6	Antenna Requirement	FCC 15.203	PASS
Remark: 1) The measurement result for the sample received is <Pass> according to < ANSI C63.10-2013, FCC CFR 47 Part 2, FCC CFR 47 Part 15C> when <Accuracy Method> decision rule is applied. 2) The EUT can be powered by adapter and PoE, both the adapter and PoE were test, the result of the adapter was worse case and recorded in this report.			



## TABLE OF CONTENTS

<b>1. ATTESTATION OF TEST RESULTS .....</b>	<b>5</b>
<b>2. TEST METHODOLOGY .....</b>	<b>6</b>
<b>3. FACILITIES AND ACCREDITATION .....</b>	<b>6</b>
<b>4. CALIBRATION AND UNCERTAINTY .....</b>	<b>7</b>
4.1. <i>MEASURING INSTRUMENT CALIBRATION .....</i>	<i>7</i>
4.2. <i>MEASUREMENT UNCERTAINTY.....</i>	<i>7</i>
<b>5. EQUIPMENT UNDER TEST .....</b>	<b>8</b>
5.1. <i>DESCRIPTION OF EUT.....</i>	<i>8</i>
5.2. <i>MAXIMUM FIELD STRENGTH.....</i>	<i>9</i>
5.3. <i>CHANNEL LIST.....</i>	<i>9</i>
5.4. <i>DESCRIPTION OF AVAILABLE ANTENNAS.....</i>	<i>9</i>
5.5. <i>TEST ENVIRONMENT.....</i>	<i>9</i>
5.6. <i>DESCRIPTION OF TEST SETUP .....</i>	<i>10</i>
5.7. <i>MEASURING INSTRUMENT AND SOFTWARE USED .....</i>	<i>12</i>
<b>6. ANTENNA PORT TEST RESULTS.....</b>	<b>13</b>
6.1. <i>AC Conducted Spurious Emissions .....</i>	<i>13</i>
6.2. <i>RADIATED EMISSION.....</i>	<i>18</i>
6.2.1. <i>FUNDAMENTAL FIELD STRENGTH .....</i>	<i>23</i>
6.2.2. <i>SPURIOUS EMISSIONS BELOW 1G .....</i>	<i>24</i>
6.2.3. <i>SPURIOUS EMISSIONS BELOW 30M.....</i>	<i>26</i>
6.3. <i>20dB BANDWIDTH .....</i>	<i>29</i>
6.4. <i>TRANSMITTER FREQUENCY STABILITY.....</i>	<i>31</i>
<b>7. ANTENNA REQUIREMENTS.....</b>	<b>34</b>



# 1. ATTESTATION OF TEST RESULTS

## Applicant Information

Company Name: Zhejiang Dahua Vision Technology Co., Ltd.  
Address: No.1199, Bin'an road, Binjiang District, Hangzhou, P.R. China.

## Manufacturer Information

Company Name: Zhejiang Dahua Vision Technology Co., Ltd.  
Address: No.1199, Bin'an road, Binjiang District, Hangzhou, P.R. China.

## EUT Description

Product Name: Wi-Fi Villa Door Station  
Model Name: DHI-VTO3311Q-WP  
Additional No.: VTO3311Q-WP  
Sample Number: 4445266  
Data of Receipt Sample: Dec. 01, 2021  
Test Date: Dec. 02, 2021 ~ Jan. 20, 2022

APPLICABLE STANDARDS	
STANDARD	TEST RESULTS
CFR 47 Part 15 Subpart C	PASS

Prepared By:

*Tom Tang*

Tom Tang  
Project Engineer

Reviewed By:

*Leon Wu*

Leon Wu  
Senior Project Engineer

Authorized By:

*Chris Zhong*

Chris Zhong  
Laboratory Leader



## 2. TEST METHODOLOGY

The tests documented in this report were performed in accordance with ANSI C63.10-2013, FCC CFR 47 Part 2, FCC CFR 47 Part 15, KDB414788 D01 Radiated Test Site v01r01.

## 3. FACILITIES AND ACCREDITATION

Accreditation Certificate	<p><b>A2LA (Certificate No.: 4829.01)</b>  <b>UL-CCIC COMPANY LIMITED has been assessed and proved to be in compliance with A2LA.</b></p> <p><b>FCC (FCC Designation No.: CN1247)</b>  <b>UL-CCIC COMPANY LIMITED has been recognized to perform compliance testing on equipment subject to the Commission's Declaration of Conformity (DoC) and Certification rules.</b></p> <p><b>IC (IC Designation No.: 25056 CAB No.: CN0073)</b>  <b>UL-CCIC COMPANY LIMITED has been recognized to perform compliance testing on equipment subject to the Commission's Declaration of Conformity (DoC) and Certification rules.</b></p>
---------------------------	--

Note 1: All tests measurement facilities use to collect the measurement data are located at No. 2, Chengwan Road, Suzhou Industrial Park, Suzhou 215122, People's Republic of China

Note 2: For below 30MHz, lab had performed measurements at test anechoic chamber and comparing to measurements obtained on an open field site. These measurements below 30MHz had been correlated to measurements performed on an OFS.

Note 3: The test anechoic chamber in UL-CCIC COMPANY LIMITED had been calibrated and compared to the open field sites and the test anechoic chamber is shown to be equivalent to or worst case from the open field site.



## 4. CALIBRATION AND UNCERTAINTY

### 4.1. MEASURING INSTRUMENT CALIBRATION

The measuring equipment utilized to perform the tests documented in this report has been calibrated in accordance with the manufacturer's recommendations and is traceable to recognize national standards.

### 4.2. MEASUREMENT UNCERTAINTY

Where relevant, the following measurement uncertainty levels have been estimated for tests performed on the apparatus:

Test Item	Uncertainty
Conduction emission	3.1dB
Radiation Emission test (include Fundamental emission) (9KHz-30MHz)	3.4dB
Radiation Emission test (include Fundamental emission) (30MHz-1GHz)	3.4dB
Radiation Emission test (1GHz to 26GHz) (include Fundamental emission)	3.9dB (1GHz-18Gz)
Note: This uncertainty represents an expanded uncertainty expressed at approximately the 95% confidence level using a coverage factor of k=2.	



## 5. EQUIPMENT UNDER TEST

### 5.1. DESCRIPTION OF EUT

Product Name:	Wi-Fi Villa Door Station
Model No.:	DHI-VTO3311Q-WP
Sample Type:	Normal production

Remark:

Model No.:

No.:	Name:	No.:	Name:	No.:	Name:
1	DHI-VTO3311Q-WP	2	VTO3311Q-WP	/	

Only the main model DHI-VTO3311Q-WP was tested and only the data of this model is shown in this test report. Since Their technical construction including circuit diagram, PCB Layout, components and component layout, all electrical construction and mechanical construction are identical, only the model name is different and the user can't change the RF parameters or others access the software setting.





### 5.2. MAXIMUM FIELD STRENGTH

Frequency (MHz)	Number of Transmit Chains (NTX)	Frequency (MHz)	Channel Number	Max. Field Strength (dB $\mu$ V/m)
13.56	1	13.56	1	10.78

### 5.3. CHANNEL LIST

Channel	Frequency (MHz)	Channel	Frequency (MHz)	Channel	Frequency (MHz)	Channel	Frequency (MHz)
1	13.56	2	N/A	3	N/A	4	N/A

### 5.4. DESCRIPTION OF AVAILABLE ANTENNAS

Ant.	Frequency (MHz)	Antenna Type	Antenna Gain (dBi)
1	13.56	PCB Antenna	0

Frequency (MHz)	Transmit and Receive Mode	Description
13.56	<input checked="" type="checkbox"/> 1TX, 1RX	Chain 1 can be used as transmitting/receiving antenna.

Remark: For the product, there is only one work mode and channel, and only data of the one mode was test and recorded in the report.

### 5.5. TEST ENVIRONMENT

Environment Parameter	Selected Values During Tests	
Relative Humidity	56%	
Atmospheric Pressure:	102KPa	
Temperature	TN	20 °C
Voltage:	VL	N/A
	VN	DC 12V
	VH	N/A

Note: VL= Lower Extreme Test Voltage  
VN= Nominal Voltage  
VH= Upper Extreme Test Voltage  
TN= Normal Temperature



## 5.6. DESCRIPTION OF TEST SETUP

### SUPPORT EQUIPMENT

Item	Equipment	Brand Name	Model Name	Description
1	Laptop	ThinkPad	E590	N/A
2	Alarm Light	N/A	N/A	Supply by UL Lab
3	Electric-magnetic Lock	N/A	N/A	Supply by UL Lab
4	Micro SD card	Sandisk	A1	32GB
5	Tag	/	/	Supply by Client

### I/O PORT

Cable No	Port	Connector Type	Cable Type	Cable Length(m)	Remarks
1	USB	USB to TTL	USB	100cm Length	N/A
2	LAN	LAN	LAN	100cm Length	N/A

### ACCESSORY

Item	Accessory	Brand Name	Model Name	Description
1	SWITCHING ADAPTER	HONOR	ADS-24S-12 1224GPCU	INPUT: 100-240V~50/60Hz max. 0.7A OUTPUT: 12.0V=2.0 A

The EUT can continue work normally when a card touched.

### TEST SETUP

The EUT can work in an engineering mode though the software inside.

Note: The EUT has two ways to transmit the NFC signal, one is work in an engineering mode though the software inside and the other one is used the tag to approach the NFC antenna. The two ways had been tested, but only the worst data (work in an engineering mode) was recorded in the report.

### SETUP DIAGRAM FOR TESTS

Power by the adapter:

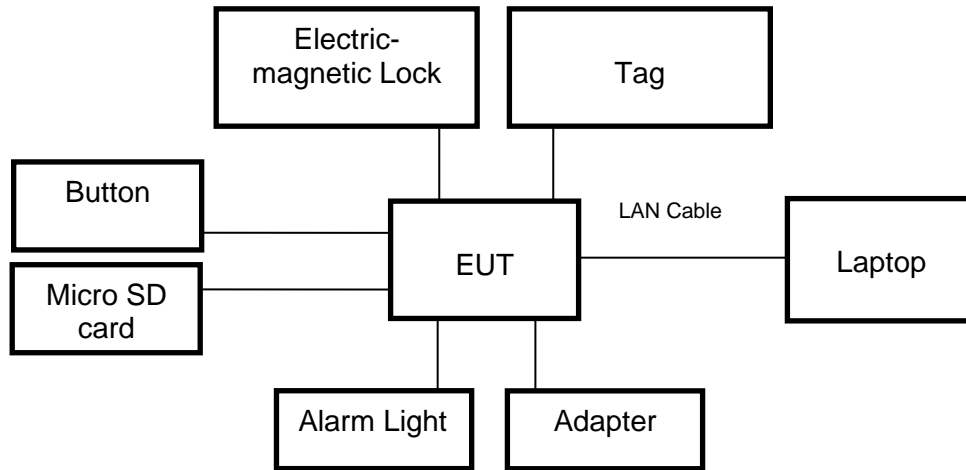

Power by the PoE

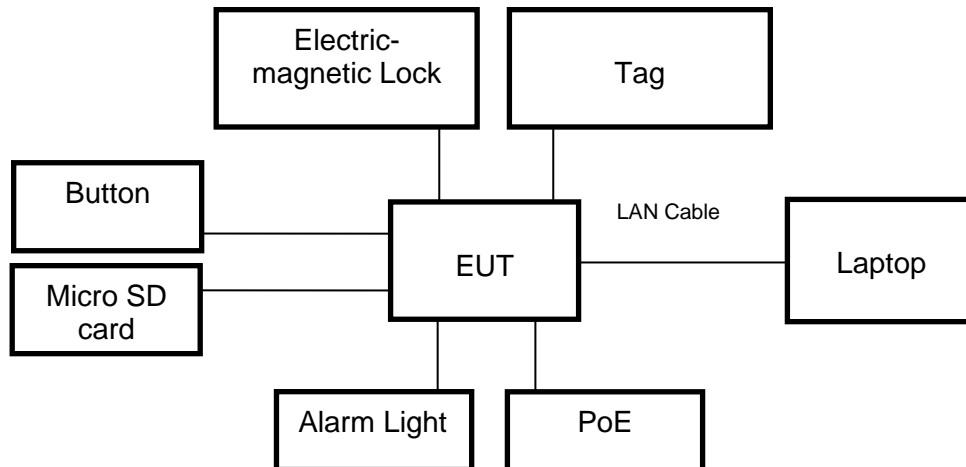



### 5.7. MEASURING INSTRUMENT AND SOFTWARE USED

Conducted Emissions (Instrument)							
Used	Equipment	Manufacturer	Model No.	Serial No.	Upper Last Cal.	Last Cal.	Next Cal.
<input checked="" type="checkbox"/>	EMI Test Receiver	R&S	ESR3	126700	2020-12-05	2021-12-04	2022-12-03
<input checked="" type="checkbox"/>	Two-Line V-Network	R&S	ENV216	126701	2020-12-05	2021-12-04	2022-12-03
<input checked="" type="checkbox"/>	Artificial Mains Networks	R&S	ENY81	126711	2020-10-13	2021-10-12	2022-10-11
Software							
Used	Description	Manufacturer	Name	Version			
<input checked="" type="checkbox"/>	Test Software for Conducted disturbance	R&S	EMC32	Ver. 9.25			
Radiated Emissions (Instrument)							
Used	Equipment	Manufacturer	Model No.	Serial No.	Upper Last Cal.	Last Cal.	Next Cal.
<input checked="" type="checkbox"/>	Spectrum Analyzer	Keysight	N9010B	155727	2020-05-10	2021-05-09	2022-05-08
<input checked="" type="checkbox"/>	EMI test receiver	R&S	ESR26	126703	2020-12-05	2021-12-04	2022-12-03
<input checked="" type="checkbox"/>	Receiver Antenna (9kHz-30MHz)	Schwarzbeck	FMZB 1513	155456	2018-06-15	2021-06-03	2024-06-02
<input checked="" type="checkbox"/>	Receiver Antenna (30MHz-1GHz)	SunAR RF Motion	JB1	177821	/	2019-01-28	2022-01-27
<input checked="" type="checkbox"/>	Receiver Antenna (1GHz-18GHz)	R&S	HF907	126705	2018-01-27	2019-01-27	2022-01-26
<input checked="" type="checkbox"/>	Pre-amplification (To 18GHz)	Compliance Direction System Inc.	PAP-1G18-50	178825	2020-02-20	2021-03-26	2022-03-25
<input checked="" type="checkbox"/>	Band Reject Filter	Wainwright	WRCJV8-2350-2400-2483.5-2533.5-40SS	1	2020-05-10	2021-05-09	2022-05-08
<input checked="" type="checkbox"/>	Highpass Filter	Wainwright	WHKX10-2700-3000-18000-40SS	2	2020-05-10	2021-05-09	2022-05-08
Software							
Used	Description	Manufacturer	Name	Version			
<input checked="" type="checkbox"/>	Test Software for Radiated disturbance	Tonscend	TS+	Ver. 2.5			
Other instruments							
Used	Equipment	Manufacturer	Model No.	Serial No.	Upper Last Cal.	Last Cal.	Next Cal.
<input checked="" type="checkbox"/>	Spectrum Analyzer	Keysight	N9010B	155368	2020-05-10	2021-05-09	2022-05-08
<input checked="" type="checkbox"/>	Power Meter	Keysight	U2021XA	155370	2020-05-10	2021-05-09	2022-05-08

## 6. ANTENNA PORT TEST RESULTS

### 6.1. AC Conducted Spurious Emissions

#### LIMITS

FCC Reference:	Part 15.207
Test Method Used:	ANSI C63.10 Section 6.2

FREQUENCY (MHz)	Limit (dBuV)	
	Quasi-peak	Average
0.15 -0.5	66 - 56 *	56 - 46 *
0.50 -5.0	56.00	46.00
5.0 -30.0	60.00	50.00

#### TEST SETUP AND PROCEDURE

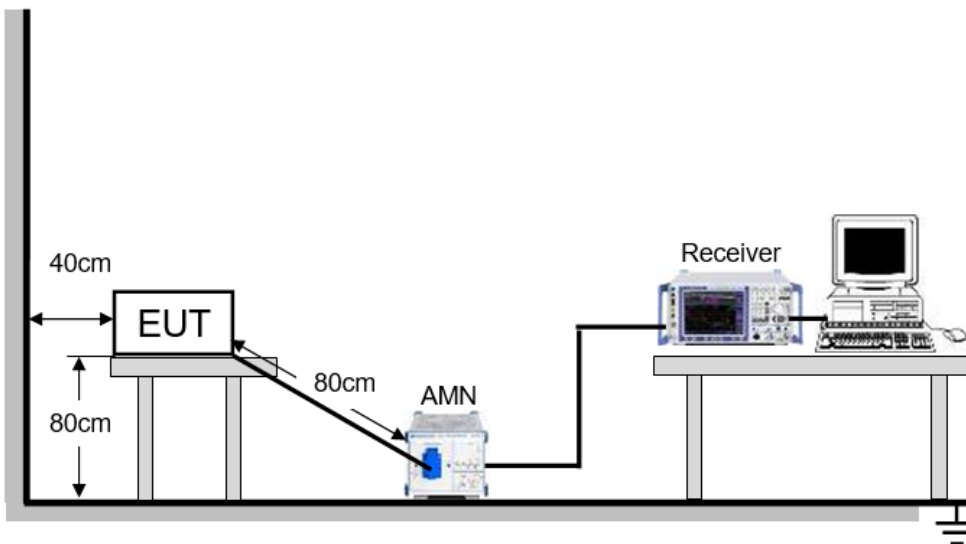

The EUT is put on a table of non-conducting material that is 80cm high. The vertical conducting wall of shielding is located 40cm to the rear of the EUT. The power line of the EUT is connected to the AC mains through a Artificial Mains Network (A.M.N.). A EMI Measurement Receiver (R&S Test Receiver ESR3) is used to test the emissions from both sides of AC line. According to the requirements in Section 6.2 of ANSI C63.10-2003. Conducted emissions from the EUT measured in the frequency range between 0.15 MHz and 30MHz using CISPR Quasi-Peak and average detector mode. The bandwidth of EMI test receiver is set at 9kHz.

The arrangement of the equipment is installed to meet the standards and operating in a manner, which tends to maximize its emission characteristics in a normal application.



**TEST ENVIRONMENT**

Temperature	20°C	Relative Humidity	56%
Atmosphere Pressure	101kPa	Test Voltage	AC 120V

**RESULTS WITH THE ANTENNA CONNECTED**

**LINE L RESULTS (WORST-CASE CONFIGURATION)**

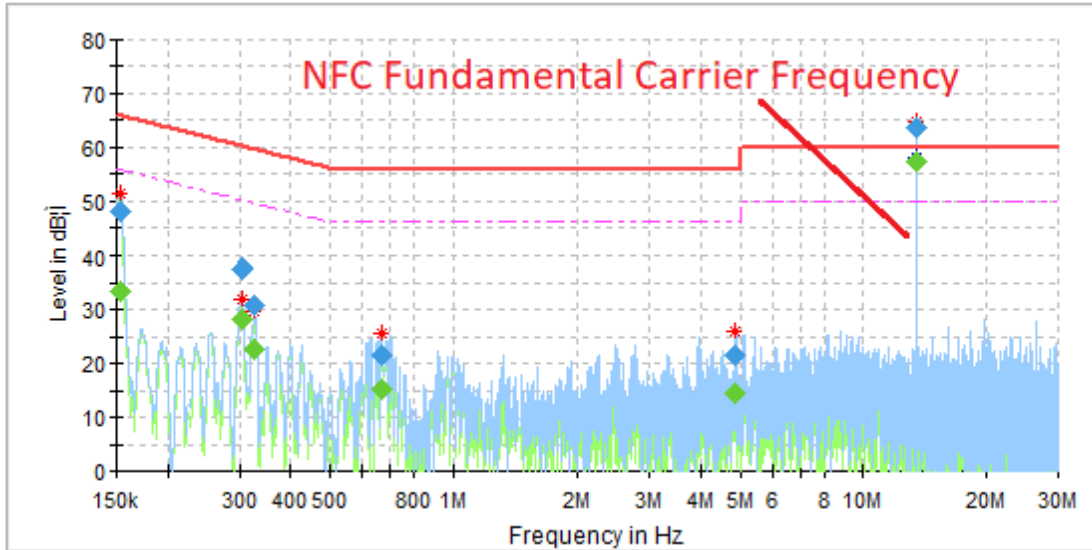

Frequency (MHz)	QuasiPeak (dBµV)	Average (dBµV)	Limit (dBµV)	Margin (dB)	Meas. Time (ms)	Bandwidth (kHz)	Line	Filter	Corr. (dB)
0.152985	---	33.42	55.84	22.42	1000.0	9.000	L1	OFF	9.6
0.152985	47.94	---	65.84	17.89	1000.0	9.000	L1	OFF	9.6
0.303728	---	28.27	50.14	21.87	1000.0	9.000	L1	OFF	9.5
0.303728	37.76	---	60.14	22.38	1000.0	9.000	L1	OFF	9.5
0.326115	---	22.53	49.55	27.02	1000.0	9.000	L1	OFF	9.5
0.327608	30.98	---	59.51	28.53	1000.0	9.000	L1	OFF	9.5
0.667898	21.60	---	56.00	34.40	1000.0	9.000	L1	OFF	9.5
0.667898	---	15.15	46.00	30.85	1000.0	9.000	L1	OFF	9.5
4.875255	21.47	---	56.00	34.53	1000.0	9.000	L1	OFF	9.8
4.875255	---	14.52	46.00	31.48	1000.0	9.000	L1	OFF	9.8
13.560113	---	57.32	50.00	-7.32	1000.0	9.000	L1	OFF	9.4
13.560113	63.45	---	60.00	-3.45	1000.0	9.000	L1	OFF	9.4

- Note: 1. If QP Result complies with AV limit, AV Result is deemed to comply with AV limit.  
 2. Test setup: RBW: 200 Hz (9 kHz—150 kHz), 9 kHz (150 kHz—30 MHz).  
 3. Step size: 80Hz (0.009MHz-0.15MHz), 4 kHz (0.15MHz-30MHz), Scan time: auto.  
 4. The extension cord/outlet strip was calibrated with the LISN as required by ANSI C63.10:2013 Clause 6.2.2.  
 5. The EUT can be powered by adapter and PoE, both the adapter and PoE were test, the result of the adapter was worse case and recorded in this report.

**LINE N RESULTS (WORST-CASE CONFIGURATION)**

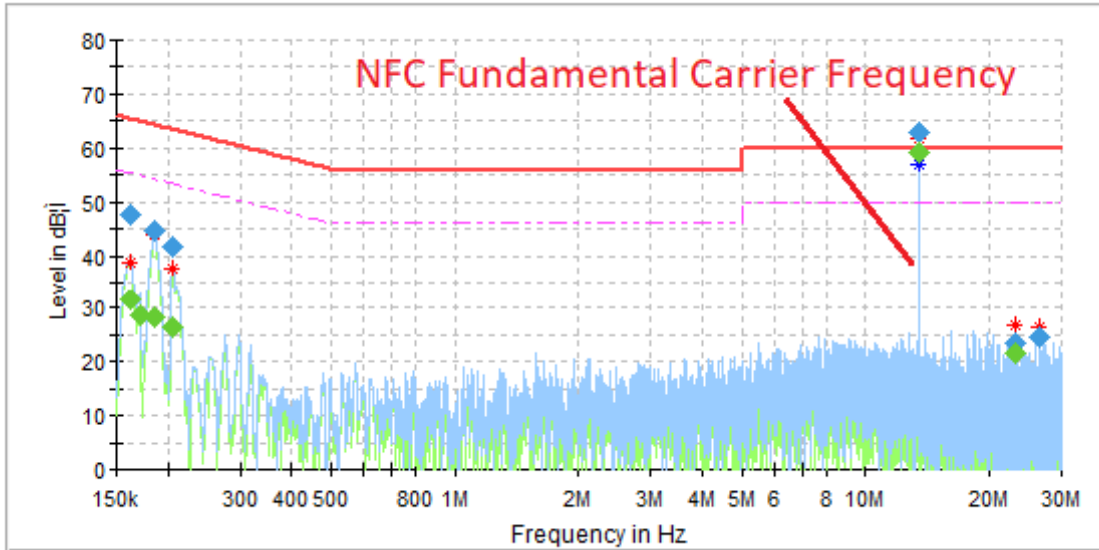

Frequency (MHz)	QuasiPeak (dBμV)	Average (dBμV)	Limit (dBμV)	Margin (dB)	Meas. Time (ms)	Bandwidth (kHz)	Line	Filter	Corr. (dB)
0.161940	---	31.55	55.36	23.82	1000.0	9.000	N	OFF	9.5
0.161940	47.72	---	65.36	17.64	1000.0	9.000	N	OFF	9.5
0.170895	---	28.70	54.92	26.22	1000.0	9.000	N	OFF	9.5
0.185820	---	28.32	54.22	25.90	1000.0	9.000	N	OFF	9.5
0.185820	44.70	---	64.22	19.52	1000.0	9.000	N	OFF	9.5
0.205223	---	26.27	53.40	27.13	1000.0	9.000	N	OFF	9.5
0.205223	41.55	---	63.40	21.84	1000.0	9.000	N	OFF	9.5
13.560113	62.77	---	60.00	-2.77	1000.0	9.000	N	OFF	9.7
13.560113	---	59.27	50.00	-9.27	1000.0	9.000	N	OFF	9.7
23.068830	23.38	---	60.00	36.62	1000.0	9.000	N	OFF	10.0
23.068830	---	21.56	50.00	28.44	1000.0	9.000	N	OFF	10.0
26.609040	24.64	---	60.00	35.36	1000.0	9.000	N	OFF	9.8

- Note: 1. If QP Result complies with AV limit, AV Result is deemed to comply with AV limit.  
 2. Test setup: RBW: 200 Hz (9 kHz—150 kHz), 9 kHz (150 kHz—30 MHz).  
 3. Step size: 80Hz (0.009MHz-0.15MHz), 4 kHz (0.15MHz-30MHz), Scan time: auto.  
 4. The extension cord/outlet strip was calibrated with the LISN as required by ANSI C63.10:2013 Clause 6.2.2.  
 5. The EUT can be powered by adapter and PoE, both the adapter and PoE were test, the result of the adapter was worse case and recorded in this report.

**RESULTS WITH A DUMMY LOAD IN LIEU OF THE ANTENNA**

**LINE L RESULTS (WORST-CASE CONFIGURATION)**

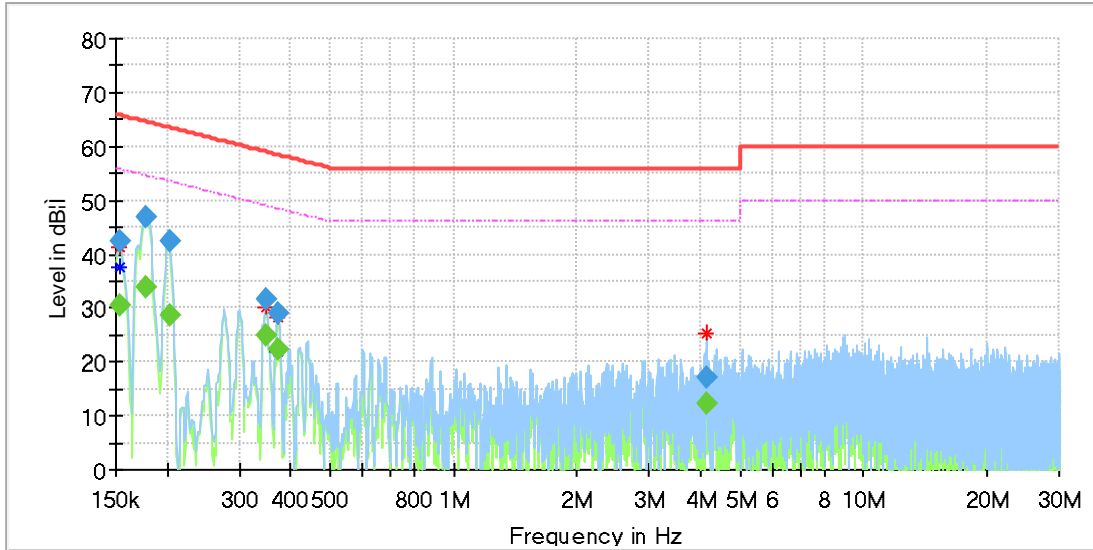

Frequency (MHz)	QuasiPeak (dBμV)	Average (dBμV)	Limit (dBμV)	Margin (dB)	Meas. Time (ms)	Bandwidth (kHz)	Line	Filter	Corr. (dB)
0.152985	---	30.45	55.84	18.38	1000.0	9.000	L1	OFF	9.6
0.152985	42.51	---	65.84	14.33	1000.0	9.000	L1	OFF	9.6
0.178358	---	33.79	54.56	20.78	1000.0	9.000	L1	OFF	9.5
0.178358	46.89	---	64.56	17.67	1000.0	9.000	L1	OFF	9.5
0.202238	---	28.73	53.52	24.79	1000.0	9.000	L1	OFF	9.5
0.202238	42.42	---	63.52	21.10	1000.0	9.000	L1	OFF	9.5
0.348503	31.51	---	59.00	27.49	1000.0	9.000	L1	OFF	9.5
0.348503	---	24.91	49.00	24.09	1000.0	9.000	L1	OFF	9.5
0.372383	29.03	---	58.45	29.42	1000.0	9.000	L1	OFF	9.6
0.372383	---	22.24	48.45	26.21	1000.0	9.000	L1	OFF	9.6
4.134975	---	12.24	46.00	33.76	1000.0	9.000	L1	OFF	9.8
4.134975	17.01	---	56.00	38.99	1000.0	9.000	L1	OFF	9.8

- Note: 1. If QP Result complies with AV limit, AV Result is deemed to comply with AV limit.  
 2. Test setup: RBW: 200 Hz (9 kHz—150 kHz), 9 kHz (150 kHz—30 MHz).  
 3. Step size: 80Hz (0.009MHz-0.15MHz), 4 kHz (0.15MHz-30MHz), Scan time: auto.  
 4. The extension cord/outlet strip was calibrated with the LISN as required by ANSI C63.10:2013 Clause 6.2.2.  
 5. The EUT can be powered by adapter and PoE, both the adapter and PoE were test, the result of the adapter was worse case and recorded in this report.



**LINE N RESULTS (WORST-CASE CONFIGURATION)**

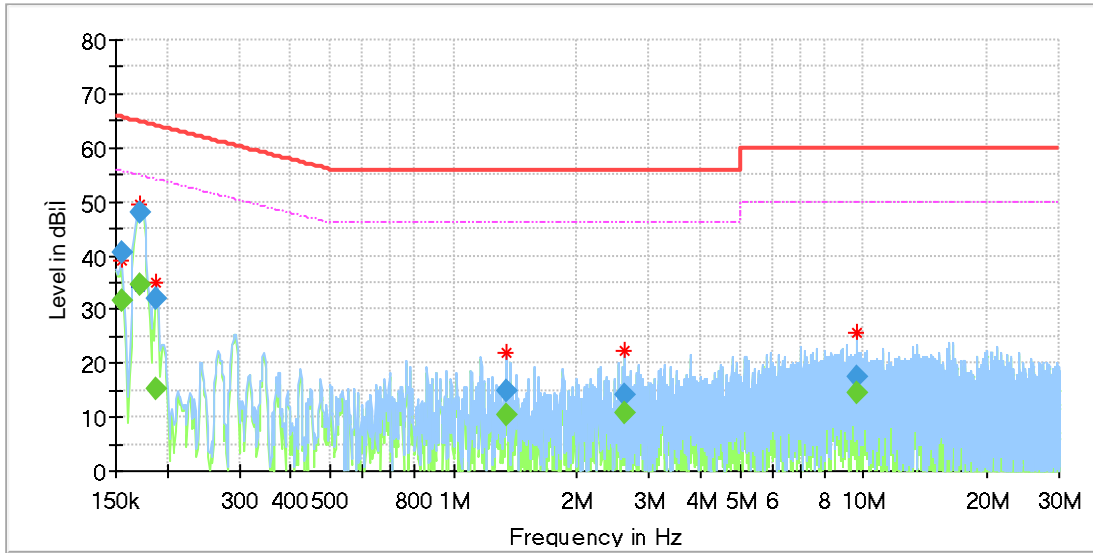

Frequency (MHz)	QuasiPeak (dBμV)	Average (dBμV)	Limit (dBμV)	Margin (dB)	Meas. Time (ms)	Bandwidth (kHz)	Line	Filter	Corr. (dB)
0.154478	---	31.64	55.76	24.12	1000.0	9.000	N	OFF	9.5
0.154478	40.60	---	65.76	17.15	1000.0	9.000	N	OFF	9.5
0.172388	---	34.61	54.85	20.23	1000.0	9.000	N	OFF	9.5
0.172388	47.98	---	64.85	16.87	1000.0	9.000	N	OFF	9.5
0.187313	32.05	---	64.16	32.10	1000.0	9.000	N	OFF	9.5
0.188805	---	15.16	54.09	38.93	1000.0	9.000	N	OFF	9.5
1.346985	---	10.57	46.00	35.43	1000.0	9.000	N	OFF	9.6
1.348478	14.85	---	56.00	41.15	1000.0	9.000	N	OFF	9.6
2.611133	14.11	---	56.00	41.89	1000.0	9.000	N	OFF	9.6
2.611133	---	10.76	46.00	35.24	1000.0	9.000	N	OFF	9.6
9.631853	---	14.61	50.00	35.39	1000.0	9.000	N	OFF	9.9
9.631853	17.52	---	60.00	42.48	1000.0	9.000	N	OFF	9.9

- Note: 1. If QP Result complies with AV limit, AV Result is deemed to comply with AV limit.  
 2. Test setup: RBW: 200 Hz (9 kHz—150 kHz), 9 kHz (150 kHz—30 MHz).  
 3. Step size: 80Hz (0.009MHz-0.15MHz), 4 kHz (0.15MHz-30MHz), Scan time: auto.  
 4. The extension cord/outlet strip was calibrated with the LISN as required by ANSI C63.10:2013 Clause 6.2.2.  
 5. The EUT can be powered by adapter and PoE, both the adapter and PoE were test, the result of the adapter was worse case and recorded in this report.



## 6.2. RADIATED EMISSION

### TEST PROCEDURE

Fundamental field strength

FCC Reference:	Part 15.225(a)(b)(c)(d) & 15.209(a)
Test Method Used:	ANSI C63.10 Sections 6.3, 6.4 and 6.5

Frequency (MHz)	Field Strength (uV/m)	Field Strength (dBuV/m) at 30M
13.553-13.567	15848	84
13.410-13.553/13.567-13.710	334	50.47
13.110-13.410/13.710-14.010	106	40.51

Note(s):

1. The field strength of any emissions appearing outside of the 13.110-14.010 MHz band shall not exceed the general radiated emission limits in §15.209.
2. The limit is specified at a test distance of 30 meters. However, as specified by FCC Section 15.31 (f)(2) / RSS-Gen Section 6.4, measurements may be performed at a closer distance and the measured level corrected to the specified measurement distance by using the square of an inverse linear distance extrapolation factor (40dB/decade).



Radiation Disturbance Test Limit for FCC (Class B) (9KHz-1GHz)

Frequency (MHz)	Field Strength (microvolts/meter)	Measurement Distance (meters)
0.009~0.490	2400/F(KHz)	300
0.490~1.705	24000/F(KHz)	30
1.705~30.0	30	30
30~88	100	3
88~216	150	3
216~960	200	3
960~1000	500	3

Note: 1) At frequencies at or above 30 MHz, measurements may be performed at a distance other than what is specified provided: measurements are not made in the near field except where it can be shown that near field measurements are appropriate due to the characteristics of the device; and it can be demonstrated that the signal levels needed to be measured at the distance employed can be detected by the measurement equipment. Measurements shall not be performed at a distance greater than 30 meters unless it can be further demonstrated that measurements at a distance of 30 meters or less are impractical. When performing measurements at a distance other than that specified, the results shall be extrapolated to the specified distance using an extrapolation factor of 20 dB/decade (inverse linear-distance for field strength measurements; inverse-linear-distance-squared for power density measurements).

(2) At frequencies below 30 MHz, measurements may be performed at a distance closer than that specified in the regulations; however, an attempt should be made to avoid making measurements in the near field. Pending the development of an appropriate measurement procedure for measurements performed below 30 MHz, when performing measurements at a closer distance than specified, the results shall be extrapolated to the specified distance by either making measurements at a minimum of two distances on at least one radial to determine the proper extrapolation factor or by using the square of an inverse linear distance extrapolation factor (40 dB/decade). This paragraph (f) shall not apply to Access BPL devices operating below 30 MHz.

Restricted bands of operation

MHz	MHz	MHz	GHz
0.090-0.110	16.42-16.423	399.9-410	4.5-5.15
<sup>1</sup> 0.495-0.505	16.69475-16.69525	608-614	5.35-5.46
2.1735-2.1905	16.80425-16.80475	960-1240	7.25-7.75
4.125-4.128	25.5-25.67	1300-1427	8.025-8.5
4.17725-4.17775	37.5-38.25	1435-1626.5	9.0-9.2
4.20725-4.20775	73-74.6	1645.5-1646.5	9.3-9.5
6.215-6.218	74.8-75.2	1660-1710	10.6-12.7
6.26775-6.26825	108-121.94	1718.8-1722.2	13.25-13.4
6.31175-6.31225	123-138	2200-2300	14.47-14.5
8.291-8.294	149.9-150.05	2310-2390	15.35-16.2
8.362-8.366	156.52475-156.52525	2483.5-2500	17.7-21.4
8.37625-8.38675	156.7-156.9	2690-2900	22.01-23.12
8.41425-8.41475	162.0125-167.17	3260-3267	23.6-24.0
12.29-12.293	167.72-173.2	3332-3339	31.2-31.8
12.51975-12.52025	240-285	3345.8-3358	36.43-36.5
12.57675-12.57725	322-335.4	3600-4400	( <sup>2</sup> )
13.36-13.41			

Note: <sup>1</sup>Until February 1, 1999, this restricted band shall be 0.490-0.510 MHz.

<sup>2</sup>Above 38.6c

<b>FCC Reference:</b>	Part 15.225(a)(b)(c)(d) & 15.209(a)
<b>Test Method Used:</b>	ANSI C63.10 Sections 6.3 and 6.5

**TEST SETUP**

Below 30MHz

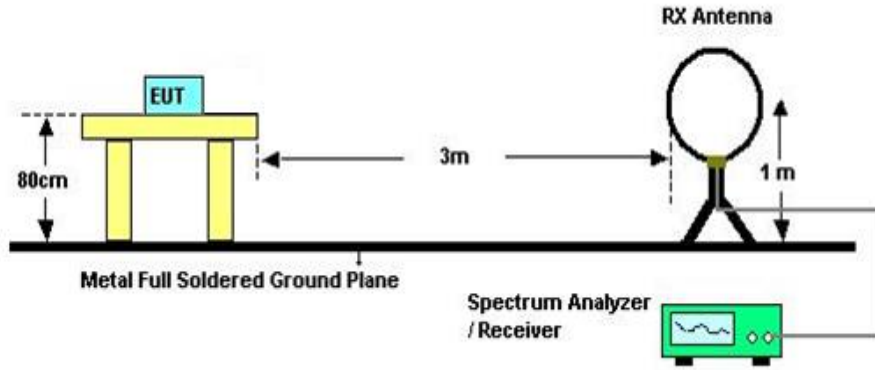

The setting of the spectrum analyser:

RBW	200Hz (From 9kHz to 0.15MHz)/ 9KHz (From 0.15MHz to 30MHz)
VBW	200Hz (From 9kHz to 0.15MHz)/ 9KHz (From 0.15MHz to 30MHz)
Sweep	Auto
Detector	Peak/QP/ Average
Trace	Max hold

1. The testing follows the guidelines in ANSI C63.10-2013
2. The EUT was arranged to its worst case and then turntable (from 0 degree to 360 degrees) to find the maximum reading. A pre-amp and a high pass filter are used for the test in order to get better signal level. Both Horizontal, Face-on and Face-off polarizations of the antenna are set to make the measurement.
3. The EUT was placed on a turntable with 80cm meter above ground.
4. The EUT was set 3 meters from the interference receiving antenna, which was mounted on the top of a 1m height antenna tower.
5. The radiated emission limits are based on measurements employing a CISPR quasi-peak detector except for the frequency bands 9-90 kHz, 110-490 kHz and above 1000 MHz. Radiated emission limits in these three bands are based on measurements employing an average detector.
6. For measurement below 1GHz, the initial step in collecting conducted emission data is a spectrum analyzer peak detector mode pre-scanning the measurement frequency range. Significant peaks are then marked and then Quasi Peak detector mode re-measured. If the emission level of the EUT measured by the peak detector is 3 dB lower than the applicable limit, the peak emission level will be reported. Otherwise, the emission measurement will be repeated using the quasi-peak detector and reported.
7. Although these tests were performed other than open area test site, adequate comparison measurements were confirmed against 30m OFS. Therefore sufficient tests were made to

demonstrate that the alternative site produces results that correlate with the ones of tests made in an open field based on KDB 414788.

Below 1G

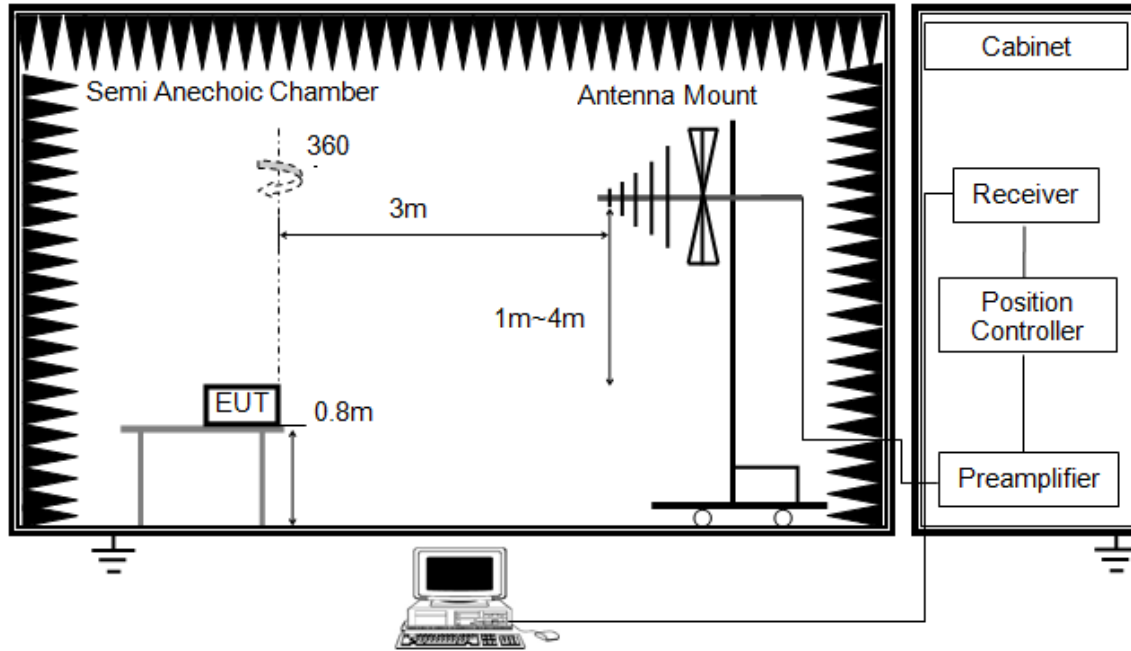

The setting of the spectrum analyser

RBW	120K
VBW	300K
Sweep	Auto
Detector	Peak/QP
Trace	Max hold

1. The testing follows the guidelines in ANSI C63.10-2013.
2. The EUT was arranged to its worst case and then tune the antenna tower (from 1 m to 4 m) and turntable (from 0 degree to 360 degrees) to find the maximum reading. A pre-amp and a high pass filter are used for the test in order to get better signal level. Both horizontal and vertical polarizations of the antenna are set to make the measurement.
3. The EUT was placed on a turntable with 0.8 meter above ground.
4. The EUT was set 3 meters from the interference receiving antenna, which was mounted on the top of a variable height antenna tower.

X axis, Y axis, Z axis positions:

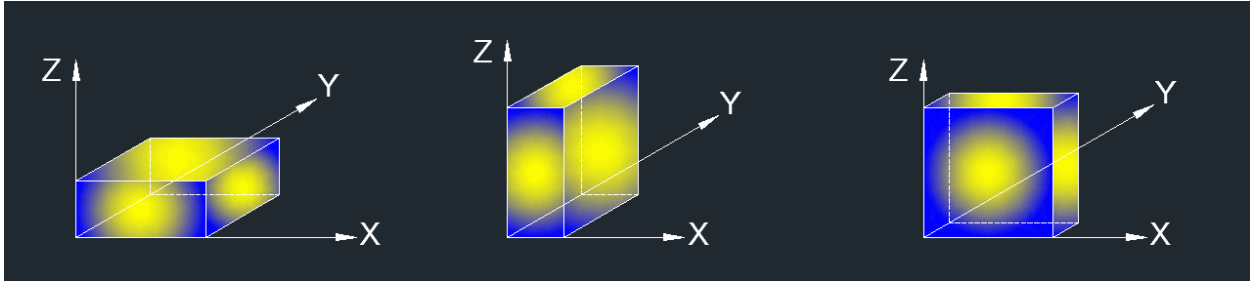

Note: For all radiated test, EUT in each of three orthogonal axis emissions had been tested, but only the worst case (X axis) data recorded in the report.



**RESULTS**

**TEST ENVIRONMENT**

Temperature	20°C	Relative Humidity	56%
Atmosphere Pressure	101kPa	Test Voltage	AC120V

Remark: Through pre-testing all test polarizations, including Horizontal, Face-on and Face-off polarizations of the antenna, but only the data of the worst case is included in this test report.

**6.2.1. FUNDAMENTAL FIELD STRENGTH**

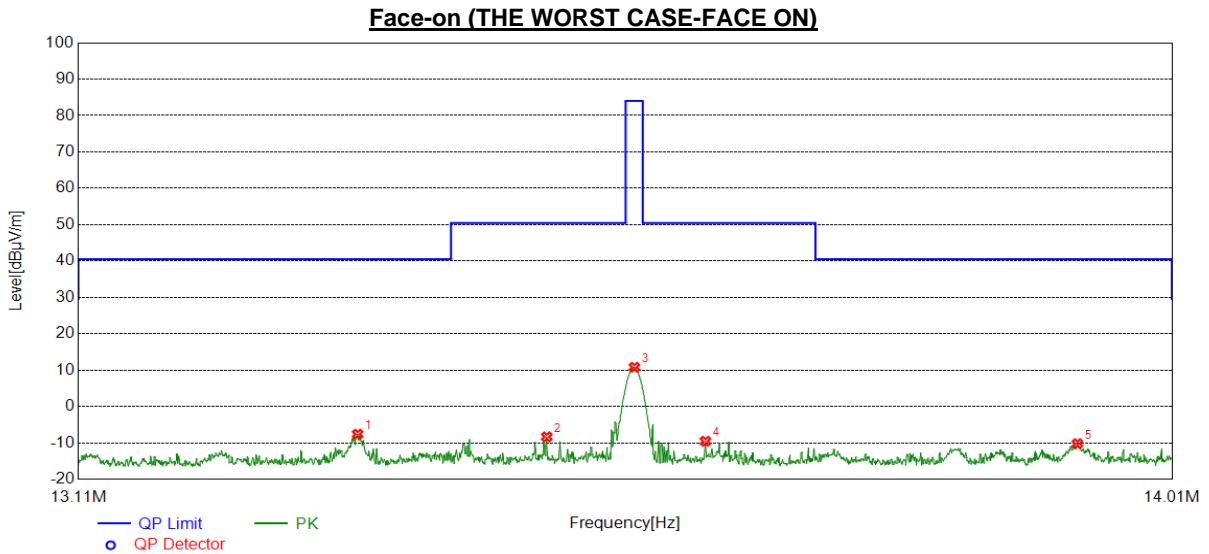

No.	Frequency (MHz)	Reading (dBuV/m)	Correct dB/m	Result (dBuV/m)	Limit (dBuV/m)	Margin (dB)	Remark
1	13.3342	14.00	-21.61	-7.61	40.51	-48.12	peak
2	13.4882	13.25	-21.60	-8.35	50.47	-58.82	peak
3	13.5602	32.39	-21.61	10.78	84.00	-73.22	peak
4	13.6188	12.06	-21.62	-9.56	50.47	-60.03	peak
5	13.9299	11.37	-21.60	-10.23	40.51	-50.74	peak

Note: Result = Reading + Correct Factor.



### 6.2.2. SPURIOUS EMISSIONS BELOW 1G

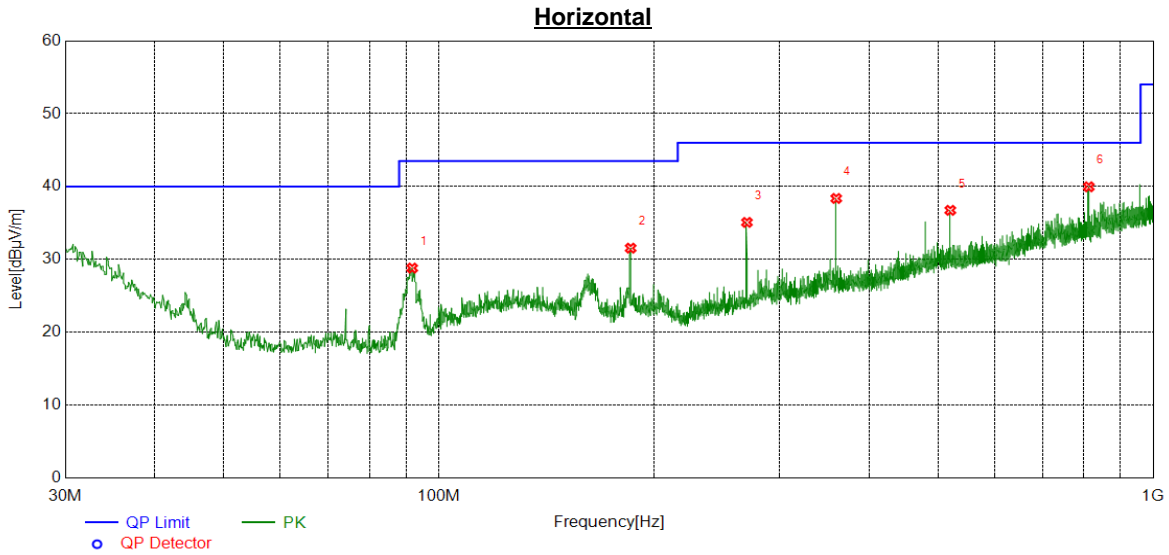

No.	Frequency (MHz)	Reading [dBuV/m]	Factor [dB]	Result (dBuV/m)	Limit (dBuV/m)	Margin (dB)	Remark
1	91.7952	13.94	14.87	28.81	43.50	-14.69	peak
2	185.6036	13.31	18.24	31.55	43.50	-11.95	peak
3	270.0020	15.28	19.80	35.08	46.00	-10.92	peak
4	360.0270	16.41	21.96	38.37	46.00	-7.63	peak
5	519.9960	10.82	25.92	36.74	46.00	-9.26	peak
6	812.5773	9.96	30.01	39.97	46.00	-6.03	peak

- Note: 1. Result Level = Read Level + Correct Factor.  
 2. Test setup: RBW: 120 kHz, VBW: 300 kHz, Sweep time: auto.  
 3. If Peak Result complies with QP limit, QP Result is deemed to comply with QP limit.



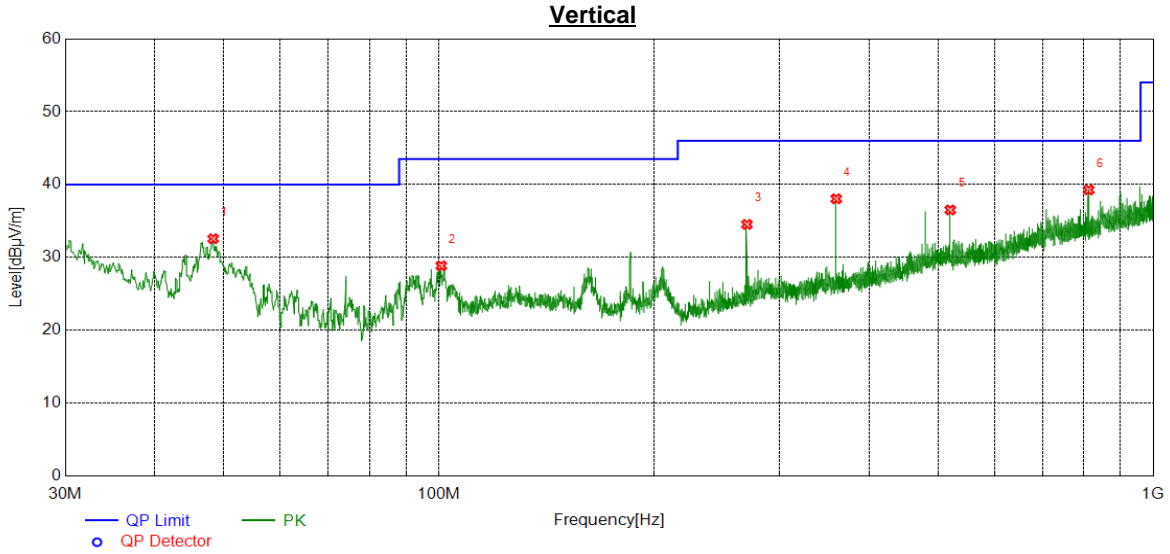

No.	Frequency (MHz)	Reading [ $\text{dB}\mu\text{V/m}$ ]	Factor [dB]	Result ( $\text{dB}\mu\text{V/m}$ )	Limit ( $\text{dB}\mu\text{V/m}$ )	Margin (dB)	Remark
1	48.3348	16.98	15.58	32.56	40.00	-7.44	peak
2	100.8171	11.81	17.04	28.85	43.50	-14.65	peak
3	270.0020	14.73	19.80	34.53	46.00	-11.47	peak
4	360.0270	16.08	21.96	38.04	46.00	-7.96	peak
5	519.9960	10.60	25.92	36.52	46.00	9.48	peak
6	812.5773	9.26	30.01	39.27	46.00	-6.73	peak

- Note: 1. Result Level = Read Level + Correct Factor.  
 2. Test setup: RBW: 120 kHz, VBW: 300 kHz, Sweep time: auto.  
 3. If Peak Result complies with QP limit, QP Result is deemed to comply with QP limit.

### 6.2.3. SPURIOUS EMISSIONS BELOW 30M

#### 9KHz~ 150KHz

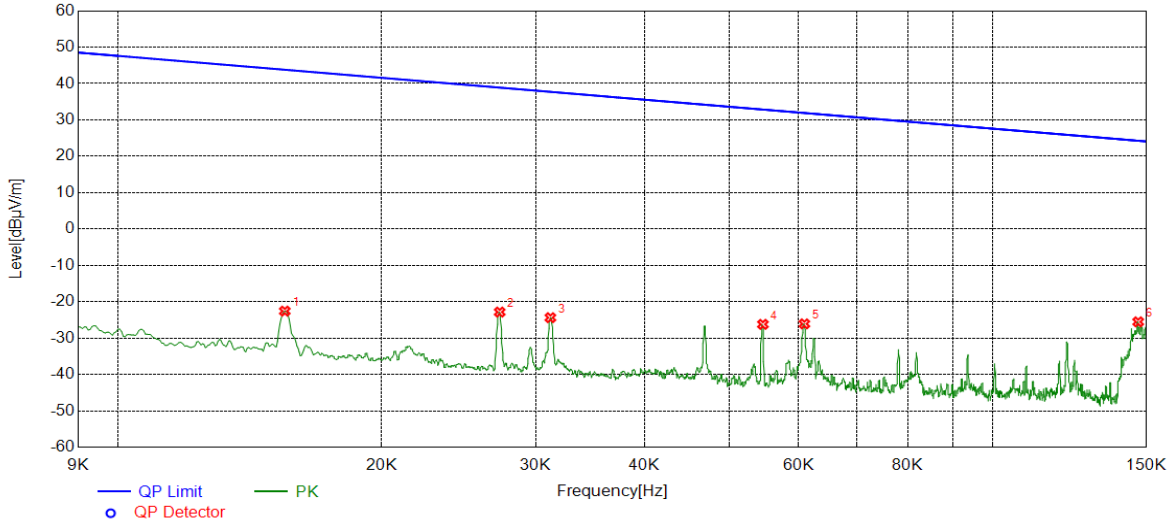

No.	Frequency (MHz)	Reading [dBµV/m]	Factor [dB]	Result (dBµV/m)	Limit (dBµV/m)	Margin (dB)	Remark
1	0.0155	39.31	-61.89	-22.58	43.77	-66.35	peak
2	0.0273	38.93	-61.77	-22.84	38.88	-61.72	peak
3	0.0312	37.36	-61.74	-24.38	37.71	-62.09	peak
4	0.0546	35.54	-61.75	-26.21	32.86	-59.07	peak
5	0.0609	35.69	-61.77	-26.08	31.91	-57.99	peak
6	0.1467	36.31	-61.84	-25.53	24.28	-49.81	peak

- Note: 1. Result = Reading Level + Correct Factor.  
 2. If Peak Result complies with AV and QP limit, AV and QP Result are deemed to comply with AV limit.  
 3. All 3 polarizations (Horizontal, Face-on and Face-off) of the loop antenna had been tested, but only the worst data recorded in the report.  
 4. The lab have verified that the result is noise which is coming from background noise not EUT's circuit.



**150KHz ~ 490KHz**

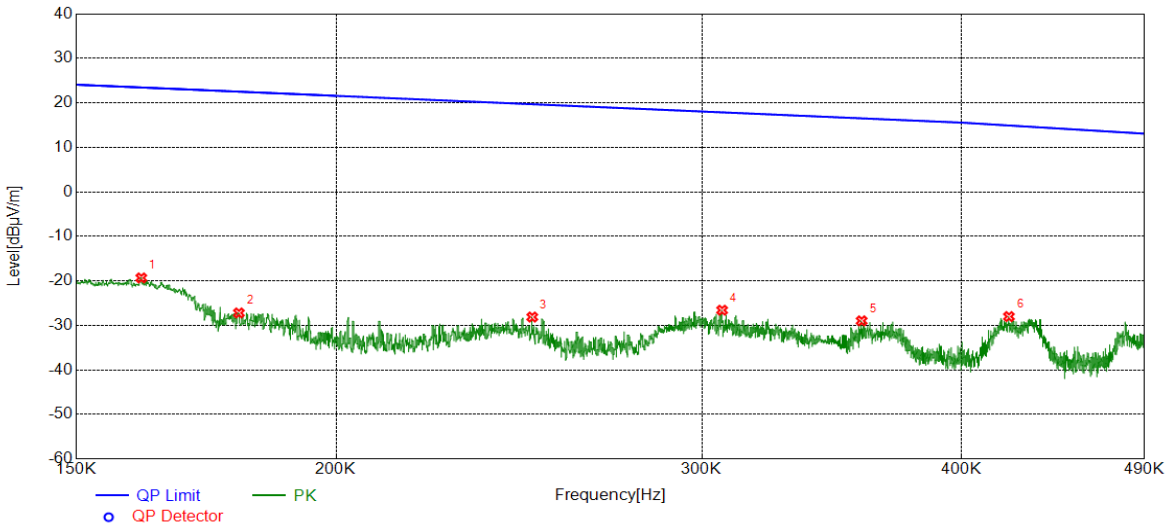

No.	Frequency (MHz)	Reading [dBµV/m]	Factor [dB]	Result (dBµV/m)	Limit (dBµV/m)	Margin (dB)	Remark
1	0.1612	42.52	-61.85	-19.33	23.45	-42.78	peak
2	0.1796	34.65	-61.85	-27.20	22.52	-49.72	peak
3	0.2486	33.76	-61.88	-28.12	19.69	-47.81	peak
4	0.3068	35.32	-61.90	-26.58	17.87	-44.45	peak
5	0.3581	32.93	-61.90	-28.97	16.52	-45.49	peak
6	0.4216	33.89	-61.90	-28.01	14.92	-42.93	peak

- Note:
1. Result = Reading Level + Correct Factor.
  2. If Peak Result complies with AV and QP limit, AV and QP Result are deemed to comply with AV limit.
  3. All 3 polarizations (Horizontal, Face-on and Face-off) of the loop antenna had been tested, but only the worst data recorded in the report.
  4. The lab have verified that the result is noise which is coming from background noise not EUT's circuit.



**490KHz ~ 30MHz**

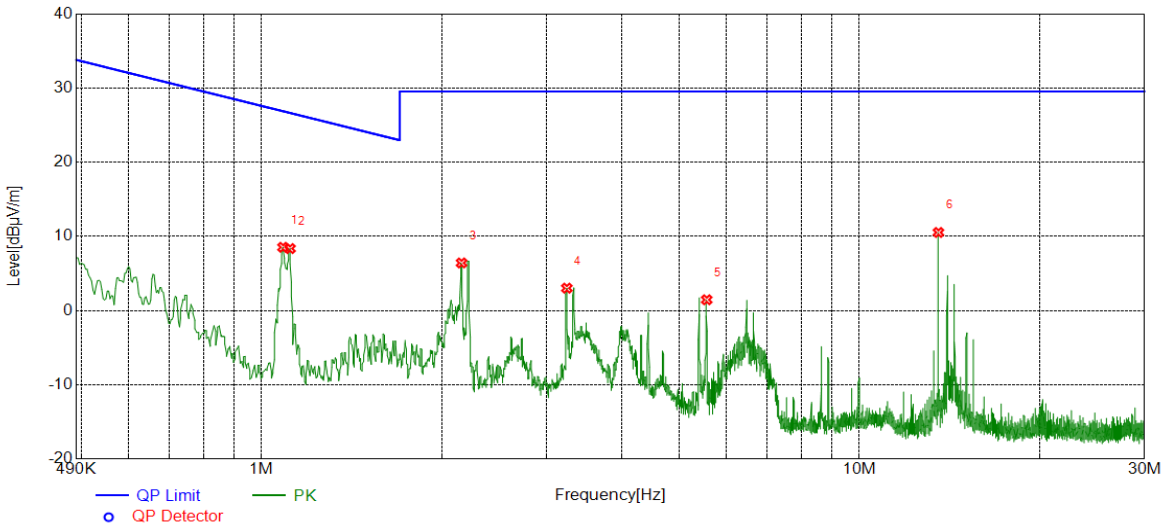

No.	Frequency (MHz)	Reading [dBµV/m]	Factor [dB]	Result (dBuV/m)	Limit (dBuV/m)	Margin (dB)	Remark
1	1.0862	30.38	-21.85	8.53	26.89	-18.36	peak
2	1.1157	30.21	-21.85	8.36	26.66	-18.30	peak
3	2.1604	28.22	-21.80	6.42	29.54	-23.12	peak
4	3.2406	24.78	-21.76	3.02	29.54	-26.52	peak
5	5.5544	23.17	-21.71	1.46	29.54	-28.08	peak
6	13.5583	32.14	-21.61	10.53	29.54	-19.01	peak

- Note:
1. Result = Reading Level + Correct Factor.
  2. If Peak Result complies with AV and QP limit, AV and QP Result are deemed to comply with AV limit.
  3. All 3 polarizations (Horizontal, Face-on and Face-off) of the loop antenna had been tested, but only the worst data recorded in the report.
  4. The lab have verified that the result is noise which is coming from background noise not EUT's circuit.



### 6.3. 20dB BANDWIDTH

#### LIMITS

FCC Part15 (15.247) Subpart C		
Section	Test Item	Limit
Part 15.215 (c)	20 Bandwidth	For reporting purposes only.
RSS-GEN Clause 6.7	99% Bandwidth (Just for reference only)	For reporting purposes only.

#### TEST PROCEDURE

Connect the UUT to the spectrum analyser and use the following settings:

Center Frequency	The center frequency of the channel under test
Detector	Peak
RBW	For 20dB Occupied Bandwidth: 1% to 5% of the 20 dB bandwidth For 99% Occupied Bandwidth: 1% to 5% of the occupied bandwidth
VBW	For 20dB Occupied Bandwidth: approximately 3xRBW For 99% Occupied Bandwidth: $\geq 3 \times \text{RBW}$
Span	Between 2 times and 5 times the 20dB OBW. Between 1.5 times and 5 times the 99% OBW.
Trace	Max hold
Sweep	Auto couple

Allow the trace to stabilize and measure the maximum width of the emission that is constrained by the frequencies associated with the two outermost amplitude points (upper and lower frequencies) that are attenuated by 99% relative to the maximum level measured in the fundamental emission.

**TEST SETUP**

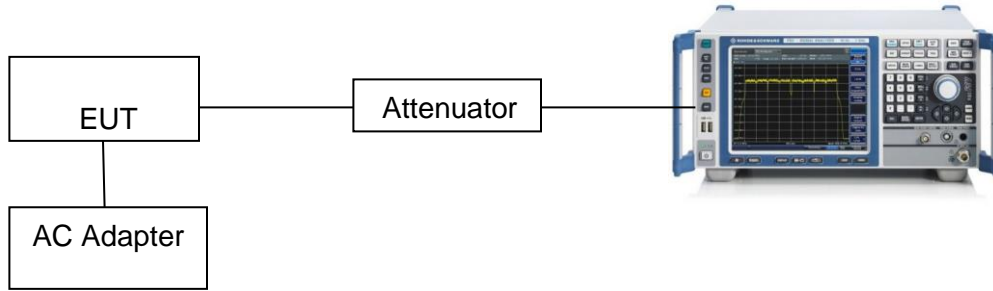

**TEST ENVIRONMENT**

Temperature	20°C	Relative Humidity	56%
Atmosphere Pressure	102kPa	Test Voltage	AC120V

**RESULTS**

Frequency (MHz)	99% bandwidth (KHz)	20dB bandwidth (KHz)
13.56	2.414	2.844



Remark: Because the measured signal is CW or CW-like adjusting the RBW per C63.10 would not be practical since measured bandwidth will always follow the RBW and the result will be approximately twice the RBW. And the signal was narrowband, therefore it was impossible to set RBW within 1% ~ 5%.

## 6.4. TRANSMITTER FREQUENCY STABILITY

### LIMITS

The frequency tolerance of the carrier signal shall be maintained within  $\pm 0.01\%$  of the operating frequency over a temperature variation of  $-20$  degrees to  $+ 50$  degrees C at normal supply voltage, and for a variation in the primary supply voltage from 85% to 115% of the rated supply voltage at a temperature of 20 degrees C.

### TEST SETUP AND PROCEDURE

Connect the UUT to the spectrum analyser and use the following settings:

Center Frequency	The center frequency of the channel under test
Detector	PEAK
RBW	10KHz
VBW	$\geq 3 \times$ RBW
Span	Encompass the entire emissions bandwidth (EBW) of the signal
Trace	Max hold
Sweep time	Auto

Allow the trace to stabilize, find the peak value of the power envelope and record the frequency, then calculated the frequency drift.

The test extreme voltage is to change the primary supply voltage from 85 to 115 percent of the nominal value.

### TEST SETUP

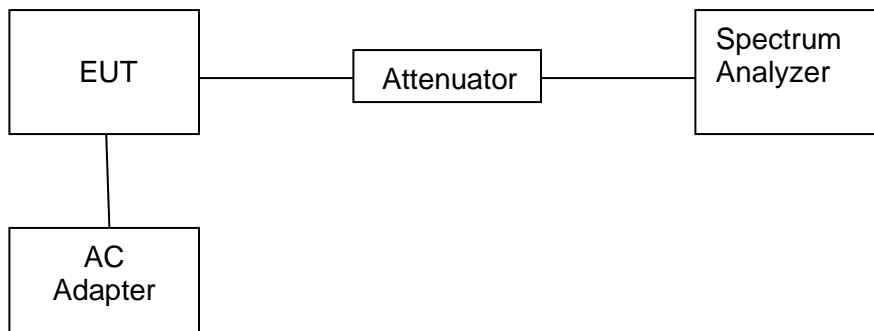



**TEST ENVIRONMENT**

Temperature	20°C	Relative Humidity	56%
Atmosphere Pressure	102kPa	Test Voltage	AC120V

**TEST RESULTS**

Maximum frequency error of the EUT with variations in ambient temperature

Temperature (°C)	Time After (Mins)	Measured Frequency (MHz)	Frequency Error (Hz)	Frequency Error (%)	Limit (%)	Margin (%)	Result
-20	0	13.5603	300	0.002	0.01	0.008	Pass
	2	13.5602	200	0.001	0.01	0.009	Pass
	5	13.5603	300	0.002	0.01	0.008	Pass
	10	13.5603	300	0.002	0.01	0.008	Pass
-10	0	13.5602	200	0.001	0.01	0.009	Pass
	2	13.5604	400	0.003	0.01	0.007	Pass
	5	13.5603	300	0.002	0.01	0.008	Pass
	10	13.5604	400	0.003	0.01	0.007	Pass
0	0	13.5604	400	0.003	0.01	0.007	Pass
	2	13.5604	400	0.003	0.01	0.007	Pass
	5	13.5605	500	0.004	0.01	0.006	Pass
	10	13.5603	300	0.002	0.01	0.008	Pass
10	0	13.5604	400	0.003	0.01	0.007	Pass
	2	13.5603	300	0.002	0.01	0.008	Pass
	5	13.5604	400	0.003	0.01	0.007	Pass
	10	13.5603	300	0.002	0.01	0.008	Pass
20	0	13.5604	400	0.003	0.01	0.007	Pass
	2	13.5606	600	0.004	0.01	0.006	Pass
	5	13.5605	500	0.004	0.01	0.006	Pass
	10	13.5603	300	0.002	0.01	0.008	Pass
30	0	13.5605	500	0.004	0.01	0.006	Pass
	2	13.5603	300	0.002	0.01	0.008	Pass
	5	13.5605	500	0.004	0.01	0.006	Pass
	10	13.5603	300	0.002	0.01	0.008	Pass
40	0	13.5603	300	0.002	0.01	0.008	Pass
	2	13.5604	400	0.003	0.01	0.007	Pass
	5	13.5604	400	0.003	0.01	0.007	Pass
	10	13.5603	300	0.002	0.01	0.008	Pass
50	0	13.5602	200	0.001	0.01	0.009	Pass
	2	13.5603	300	0.002	0.01	0.008	Pass
	5	13.5604	400	0.003	0.01	0.007	Pass
	10	13.5602	200	0.001	0.01	0.009	Pass

Maximum frequency error of the EUT with variations in nominal operating voltage at an ambient





Normal temperature

Supply Voltage (V)	Time After (Mins)	Nominal Frequency (MHz)	Measured Frequency (MHz)	Frequency Error (Hz)	Frequency Error (%)	Limit (%)	Margin (%)	Result
102	0	13.56	13.5603	300	0.002	0.01	0.008	Pass
	2	13.56	13.5603	300	0.002	0.01	0.008	Pass
	5	13.56	13.5603	300	0.002	0.01	0.008	Pass
	10	13.56	13.5604	400	0.003	0.01	0.007	Pass
120	0	13.56	13.5602	200	0.001	0.01	0.009	Pass
	2	13.56	13.5603	300	0.002	0.01	0.008	Pass
	5	13.56	13.5603	300	0.002	0.01	0.008	Pass
	10	13.56	13.5603	300	0.002	0.01	0.008	Pass
138	0	13.56	13.5603	300	0.002	0.01	0.008	Pass
	2	13.56	13.5605	500	0.004	0.01	0.006	Pass
	5	13.56	13.5603	300	0.002	0.01	0.008	Pass
	10	13.56	13.5604	400	0.003	0.01	0.007	Pass



## **7. ANTENNA REQUIREMENTS**

### **APPLICABLE REQUIREMENTS**

Please refer to FCC §15.203

If directional gain of transmitting antennas is greater than 6dBi, the power shall be reduced by the same level in dB comparing to gain minus 6dBi. For the fixed point-to-point operation, the power shall be reduced by one dB for every 3 dB that the directional gain of the antenna exceeds 6 dBi. The use of a permanently attached antenna or of an antenna that uses a unique coupling to the intentional radiator shall be considered sufficient to comply with the FCC rule.

### **ANTENNA CONNECTOR**

EUT has an PCB antenna without antenna connector.

### **ANTENNA GAIN**

The antenna gain of EUT is less than 6 dBi.

**END OF REPORT**