

USER MANUAL

Digital Satellite Receiver

ARIZA

700 / 750CX



IMPORTANT SAFETY INSTRUCTIONS

	CAUTION RISK OF ELECTRIC SHOCK DO NOT OPEN	
CAUTION : TO REDUCE THE RISK OF ELECTRIC SHOCK, DO NOT REMOVE COVER (OR BACK) NO USER-SERVICEABLE PARTS INSIDE. REFER SERVICING TO QUALIFIED SERVICE PERSONNEL.		



The lightning flash with arrowhead symbol, within an equilateral triangle, is intended to alert the user to the presence of uninsulated "dangerous voltage" within the product's enclosure that may be of sufficient magnitude to constitute a risk electric shock.



The exclamation point within an equilateral triangle is intended to alert the user to the presence of important operating and servicing instructions in the literature accompanying the appliance.

WARNING

TO REDUCE THE RISK OF FIRE OR SHOCK HAZARD, DO NOT EXPOSE THIS APPLIANCE TO RAIN OR MOISTURE.

CAUTION

CHANGES OR MODIFICATIONS NOT EXPRESSLY APPROVED BY THE MANUFACTURER COULD VOID THE USER'S AUTHORITY TO OPERATE THE EQUIPMENT.

NOTE TO CATV SYSTEM INSTALLER

THIS REMINDER IS PROVIDED TO CALL THE CATV SYSTEM INSTALLER'S ATTENTION TO ARTICLE 820-40 OF THE NEC THAT PROVIDES GUIDELINES FOR PROPER GROUNDING AND, IN PARTICULAR, SPECIFIES THAT THE CABLE GROUND SHALL BE CONNECTED TO THE GROUNDING SYSTEM OF THE BUILDING, AS CLOSE TO THE POINT OF CABLE ENTRY AS PRACTICAL.

CAUTION

The AC power cord provided with this product is polarized (one blade wider than the other).

To prevent electrical shock, match wide blade of plug to wide slot, fully insert the AC plug into a standard 120V~, 60Hz polarized outlet.

IMPORTANT SAFETY INSTRUCTIONS

NOTE

Never connect the plug to an electrical source other than one providing 120V~, 60Hz power. Use only the attached power cord. If the polarized AC cord does not fit into a non-polarized outlet, do not cut or file the blade. You are responsible for having the obsolete outlet replaced with a polarized outlet.

If you feel a static discharge when touching the unit, and the unit does not function, simply unplug the unit from the outlet. When you plug the unit back in, it should work normally.

Do not install power cords near any heating element or cooking appliances.

Important Safeguards

IMPORTANT SAFEGUARDS

PLEASE READ ALL THESE INSTRUCTIONS REGARDING YOUR SATELLITE RECEIVER EQUIPMENT AND RETAIN FOR FUTURE REFERENCE. FOLLOW ALL WARNINGS AND INSTRUCTIONS MARKED ON THE TV RECEIVER.

- 1 Read all of these instructions.
- 2 Save these instructions for later use.
- 3 Unplug this Satellite Receiver equipment from the wall outlet before cleaning. Do not use liquid cleaners or aerosol cleaners. Use a damp cloth for cleaning.
- 4 Do not use attachments not recommended by the Satellite Receiver equipment manufacturer as they may result in the risk of fire, electric shock or other personal injury.
- 5 Do not use this Satellite Receiver equipment near water, for example, near a bathtub, washbowl, kitchen sink, or laundry tub, in a wet basement, or near a swimming pool, or the like.
- 6 Do not place this Satellite Receiver equipment on an unstable cart, stand, or table. The Satellite Receiver equipment may fall, causing serious injury to a child or adult, and serious damage to the equipment. Use only with a cart or stand recommended by the manufacturer, or sold with the Satellite Receiver equipment. Wall or shelf mounting should follow the manufacturer's instructions, and should use a mounting kit approved by the manufacturer.
- 6A An appliance and cart combination should be moved with care. Quick stops, excessive force, and uneven surfaces may cause the appliance and cart combination to overturn.
- 7 Slots and openings in the cabinet and the back or bottom are provided for ventilation and to ensure reliable operation of the Satellite Receiver equipment; and to protect it from overheating, these openings, must not be blocked or covered. The openings should never be blocked by placing the



IMPORTANT SAFETY INSTRUCTIONS

Satellite Receiver equipment on a bed, sofa, rug, or other similar surface. (This equipment should never be placed near or over a radiator or heat register.) This Satellite Receiver equipment should not be placed in a built-in installation, such as a bookcase, unless proper ventilation is provided.

- 8 This Satellite Receiver equipment should be operated only from the type of power source indicated on the marking label. If you are not sure of the type of power supplied to your home, consult your Satellite Receiver dealer or local power company.
- 9 This Satellite Receiver equipment is equipped with a polarized alternating current line plug (a plug having one blade wider than the other). This plug will fit into the power outlet only one way. This is a safety feature. If you are unable to insert the plug fully into the outlet, try reversing the plug. If the plug should still fail to fit, contact your electrician to replace your obsolete outlet. Do not defeat the safety purpose of the polarized plug.
- 10 Do not allow anything to rest on the power cord. Do not locate this Satellite Receiver equipment where the cord will be abused by persons walking on it.
- 11 Follow all warnings and instructions marked on the Satellite Receiver equipment.
- 12 For added protection for this Satellite Receiver equipment during a lightning storm, or when it is left unattended and unused for long periods of time, unplug it from the wall outlet and disconnect the antenna or cable system. This will prevent damage to the equipment due to lightning and power-line surges.
Important Safeguards
- 13 An outside antenna system should not be located in the vicinity of overhead power lines or other electric light or power circuits, or where it can fall into such power lines or circuits. When installing an outside antenna system, extreme care should be taken to keep from touching such power lines or circuits, as contact with them might be fatal.
- 14 Do not overload wall outlets and extension cords, as this can result in fire or electric shock.
- 15 Never push objects of any kind into this Satellite Receiver equipment through openings, as they may touch dangerous voltage points or short-out parts that could result in a fire or electric shock. Never spill liquid of any kind on the Satellite Receiver equipment.
- 16 Do not attempt to service this Satellite Receiver equipment yourself, as opening or removing covers may expose you to dangerous voltage or other hazards. Refer all servicing to qualified service personnel.
- 17 Unplug this Satellite Receiver equipment from the wall outlet and refer servicing to qualified service personnel under the following conditions:
 - (a) When the power-supply cord or plug is damaged or frayed.
 - (b) If liquid has been spilled, or objects have fallen into the Satellite Receiver equipment.
 - (c) If the Satellite Receiver equipment has been exposed to rain or water.

IMPORTANT SAFETY INSTRUCTIONS

- (d) If the Satellite Receiver equipment does not operate normally by following the operating instructions. Adjust only those controls that are covered by the operating instructions as an improper adjustment of other controls may result in damage and will often require extensive work by a qualified technician to restore the TV receiver to its normal operation.
 - (e) If the Satellite Receiver equipment has been dropped or the cabinet has been damaged.
 - (f) When the Satellite Receiver equipment exhibits a distinct change in performance - this indicates a need for service.
- 18 When replacement parts are required, be sure the service technician has used replacement parts specified by the manufacturer that have the same characteristics as the original part. Unauthorized substitutions may result in fire, electric shock or other hazards.
 - 19 Upon completion of any service or repairs to this Satellite Receiver equipment, ask the service technician to perform safety checks to determine that the Satellite Receiver is in a safe operating condition.
 - 20 If an outside antenna or cable system is connected to the Satellite Receiver receiver, be sure the antenna or cable system is grounded so as to provide some protection against voltage surges and built-up static charges. Section 810 of the National Electrical Code, ANSI/NFPA N0.70-1984, provides information with respect to proper grounding of the mast and supporting structure, grounding of the lead-in wire to an antenna discharge unit, size of grounding conductors, location of antenna-discharge unit, connection to grounding electrodes, and requirements for the grounding electrode.
 - 21 Where the mains plug or and appliance coupler is used as the disconnect device, the disconnect device shall remain readily operable.

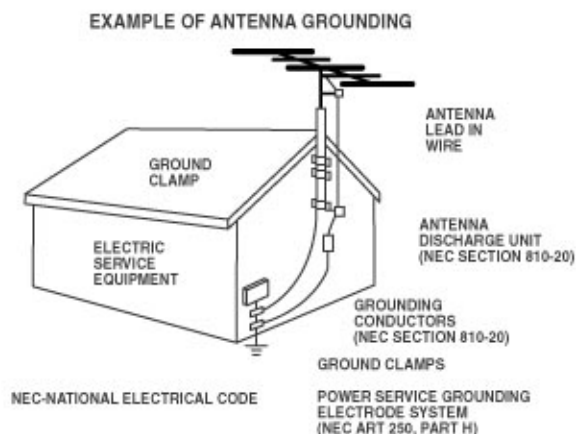

CONTENTS

PREFACE

1 OVERVIEW

- 1) How to use the REMOTE CONTROL KEY
- 2) FRONT PANEL
- 3) REAR PANEL
- 4) CONNECTION DIAGRAM
- 5) CONNECTION DIAGRAM(DISH)

2 OPERATING

1. Start Up
2. Installation
3. Parental Control
4. Channel Edit
5. User Setup
6. Factory Setting
7. System Information
8. Channel List
9. Program Guide
10. Audio Change
11. Embedded (Only for ARIZA 750CX)
12. Recall the Favorite Channel
13. Download Procedure between ARIZA 700/750CX & PC

3 SPECIFICATIONS

4 TROUBLE SHOOTING

PREFACE

1. WHAT IS THIS PRODUCT FOR?

This product is designed for using Digital Satellite Broadcasting and allows you to enjoy a lot of broadcasting whenever you want to watch it anytime. By simply pressing the button of the remote control unit, the vivid picture and life-like sound of digital broadcasting that your TV portrays through this product, allows you to watch whatever channel you wish of the digital broadcasting.

Throughout this manual you will notice that the operation is easy to use.

This manual will help you get the most from this product and guide you through installation, channel selection and many other functions.

In case you experience any difficulties to use this product, please consult the relevant section of this manual.

From now on, enjoy digital broadcasting with digital satellite receiver!!!

2. WHAT FEATURE DOES THIS PRODUCT OFFER?

Unique Features

- Power Scan : Fully Automated Satellite Scan
- Powerful scan & stable performance with easy user interface
- 5,000 Channels TV & Radio Programmable

Basic Features

- MPEG-2 Digital & Fully DVB-S Compatible
- Conax Embedded (Only for ARIZA 750CX)
- Free To Air (Only for ARIZA 700)
- 5 Favorite CH.Group
- Powerful Channel Control by Favorites, Parental Lock, Move, Delete, Skip, Rename
- Channel Sorting by Favorite, FTA, Scramble, TV & Radio channel*
- Fast Channel Change
- Power Scan, Manual PID Scan, Satellite & TP Scan, Network Scan
- Multi-Sat Scan : Simultaneous Scan for 4 Satellites
- USALS and DiSEqC1.0&1.2 Compatible
- Timer Function (Automatic Turn On/Off by Setting Function)
- Automatic PAL/NTSC Conversion
- Multi Language : English, Russian, German, French, Spanish, Turkish, Arabic, Portuguese
- User Friendly EPG (Electronic Program Guide)
- 256Colors (Graphic Use Interface)
- Full Picture in Graphic (PIG)
- Software upgrade via RS-232C (STB to STB, PC to STB)

PREFACE

3. FOR YOUR SAFETY

- Do not open the cover. It may cause malfunction or electric shock.
- When you do not use the product for a long time, please pull the power cord out from the outlet. Also do not use a damaged power cord that may cause fire or electric shock
- Do not use or install the product in a humid area.
- Do not cover the product or place anything heavy on the product, Keep clear space around the product for sufficient ventilation.
- Avoid using spray or liquid materials around the product.
- Do not plug in power cord before finishing all connections.

4. PLEASE CHECK THE FOLLOWING ACCESSORIES ARE ENCLOSED





- User Manual 1 set
- Remote Control Unit 1 Set
- Batteries(AAA Type) 2EA

Note

If any of the accessories listed above are missing, Please contact the sales outlet where this product was initially purchased.

OVERVIEW 1

1. How to use the REMOTE CONTROL KEY

Key	Function
	Turns this receiver on/off. In the standby mode, it is automatically changed to TV mode that enables to watch terrestrial TV broadcasting.
	Sounds Off/On
i	Shows channel information, such as channel number, channel name, Frequency, Polarity, Symbol Rate, Video PID, Audio PID and PCR PID
EPG	Shows program information
TV/RADIO	Toggless between the TV service and radio service
PAUSE	Holds the picture or release the pause
SIGNAL	Shows signal quality
AUDIO	Selects audio mode(Stereo, left only and right only). Selects language in case of Multilingual program.
MENU	Enters main menu screen. Or exits menu screen
EXIT	Moves to upper menu
CH ▲	Channel up/down.
CH ▼	Moves the cursor upward/downward in the menu screen.
OK	Shows channel list. Confirms selection
VOL ◀	Volume down/up.
VOL ▶	Changes the valu of a selected item
	Returns to previous program.
FAV	Enters favorite program or Exit from Favorite program.
0~9	Changes channel directly. Controls the numerical operation. Inputs the alphabet in the name edit screen.
	Execute page down function in the menu.
	Execute page up function in the menu.
SAT	Classifies satellite by satellite



1 OVERVIEW

Operating Principle

- Select an item by using up and down key and change the value of the highlighted (selected) item by using keys shown on the screen. Press OK key to enter the sub-menu if there is no instruction marked on the screen.
- The item is automatically stored and moved the upper menu by pressing the 'EXIT' key
- You can return to normal mode at any time by pressing the menu key from the menu mode

Note: This equipment has been tested and found to comply with the limits for a Class B digital device, pursuant to part 15 of the FCC Rules. These limits are designed to provide reasonable protection against harmful interference in a residential installation. This equipment generates, uses and can radiate radio frequency energy and, if not installed and used in accordance with the instructions, may cause harmful interference to radio communications. However, there is no guarantee that interference will not occur in a particular installation. If this equipment does cause harmful interference to radio or television reception, which can be determined by turning the equipment off and on, the user is encouraged to try to correct the interference by one or more of the following measures:

Reorient or relocate the receiving antenna.

Increase the separation between the equipment and receiver.

Connect the equipment into an outlet on a circuit different from that to which the receiver is connected.

Consult the dealer or an experienced radio/TV technician for help.

Modifications not expressly approved by the manufacturer could void the user's authority to operate the equipment under FCC rules.

2. FRONT PANEL

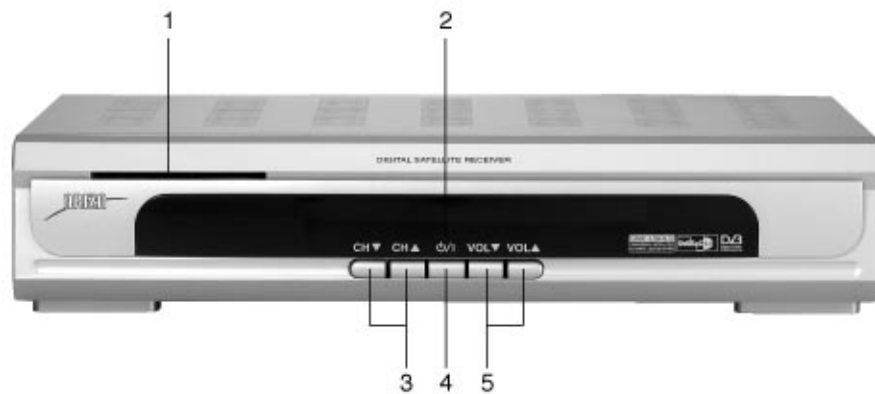

1. SMART CARD SLOT (Only for ARIZA 750CX)

2. CHANNEL DISPLAY (4 digit / 7 Segment)

After pressing the power button, "Init" is showed on screen.

After the receiver searches program, the program number is displayed as "0001~5000".

3. CH ▲, CH ▼

Changes Channel Up/Down

4. POWER

Switches Stand by mode and normal mode.

5. VOLUME ▲, VOLUME ▼

Changes Volume Up/Down

1 OVERVIEW

3. REAR PANEL

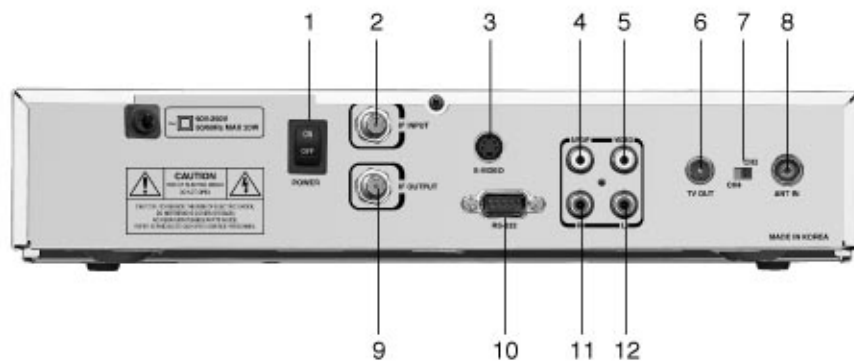

NO	NAME	FUNCTION
1	AC SWITCH	AC Power ON / OFF
2	IF INPUT	IF INPUT from LNB to receiver
3	S-VIDEO	Super Video Output to TV or VCR
4	S/PDIF	For digital audio out
5	VIDEO	Composite video output
6	TV OUT	Output to TV
7	CH3/CH4	
8	ANT IN	Input from terrestrial TV antenna
9	IF OUTPUT	IF Loop-through output to 2nd receiver
10	RS232	Serial port used for software upgrade
11	AUDIO L	Left audio output
12	AUDIO R	Right audio output

4. CONNECTION DIAGRAM

1) Receiver to TV with RF

Connect the TV antenna the ANT IN socket of the receiver.
 Connect the TV out of the receiver to the RF INPUT of the TV set.
 Search on the TV set for UHF Channel 3.
 Channel 3 is set at factory.
 If needed you can change it on the user set up mode.



2) Receiver to VCR and then to TV with RF

Connect the TV antenna to the ANT IN socket of the receiver.
 Connect the TV output Socket of the receiver to the RF IN of the VCR.
 Connect the RF output of the VCR to the RF IN of the TV set.
 Search on the TV set and the VCR for UHF channel 3.

Note

USE different UHF channels for VCR and receiver.

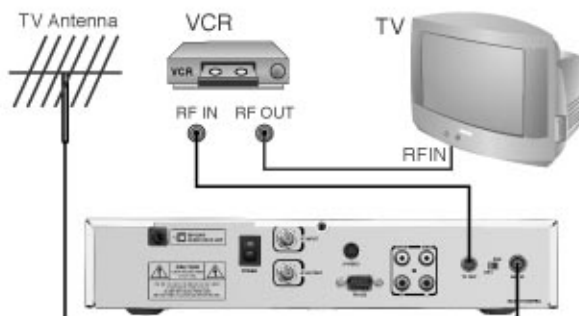

1 OVERVIEW

3) Receiver to TV with Audio and Video cables

Connect the TV antenna to the ANT IN socket of the receiver.

Connect the TV out socket of the receiver to the RF IN of the TV set.

Connect the Video and Audio outputs of the receiver to the Video and Audio inputs of the TV set.

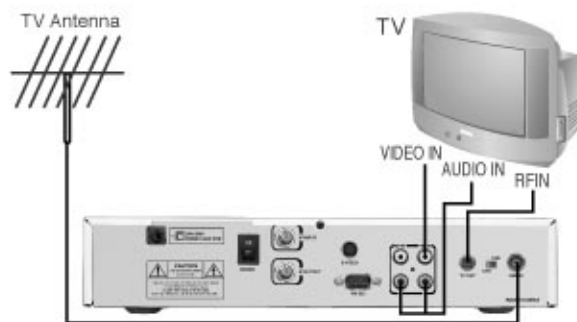

4) Receiver to TV and VCR with scart cable

Connect the TV antenna to the ANT IN socket of the receiver.

Connect the TV out socket of the receiver to the RF IN of the VCR.

Connect the RF out of the VCR to the RF IN of the TV set.

Search on the VCR for UHF channel 3.

Connect the SCART cable from the TV SCART of the receiver to the SCART of the TV set.

Connect the SCART cable from the VCR SCART of the receiver to the SCART of the VCR.

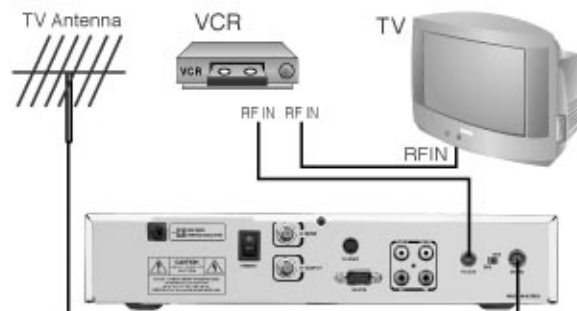

5. CONNECTION DIAGRAM(DISH)

1) One dish

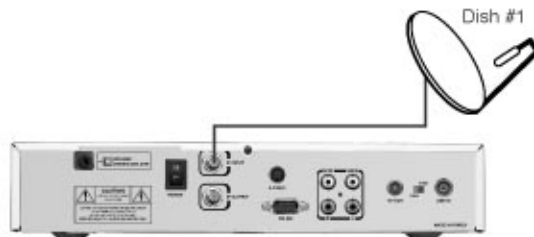

2) Two dishes using Diseqc mode

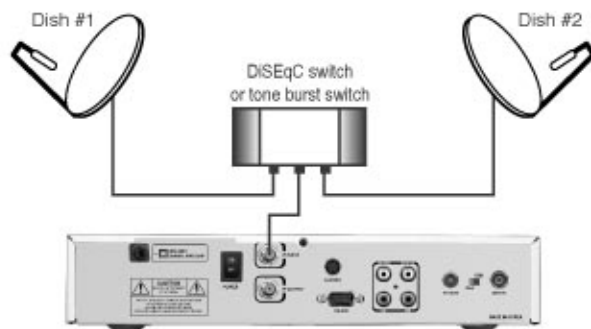

2 OPERATION

1. Start Up

If you are watching TV through the RF-cable, you need to adjust the Channel number. The type of TV and Channel numbers are set to PAL-G and Channel 38 at the factory. For Canada / USA, Ch 3 is factory preset.

Please follow the brief procedure below and watch the satellite programs.

- (1) Select the language
- (2) Select the installation in main menu screen
- (3) Select the antenna setup in install menu screen
- (4) Adjust LNB configuration per each satellite
- (5) Execute scanning to find program
- (6) Exit from installation after all programs are searched.

1.1 Language

When the receiver is turned on for the first time the language selection menu is appeared as in the Fig 1-1.

Select the desired language and press OK to confirm it.

This receiver supports 8 languages.

- English,
- German,
- French,
- Portugues,
- Spanish,
- Turkish,
- Arabic,
- Russian



1-1

Picture will be named by section number.

2. Installation

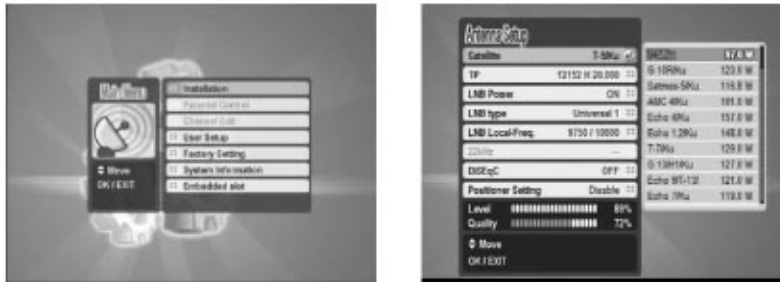

Press the OK key. Antenna setup is appeared on screen as upper second figure.

2.1 Antenna setup

In this section you could know how to operate LNB set-up.

2.1.1 Satellite

- When you adjust the LNB set-up, you select the satellite using ▲&▼ key.
- After selecting the satellite, Press OK
- Adjust LNB type, LNB Lo-Freq, 22kHz, DiSEqC, LNB power, TP, Positioner Setting.

2.1.2 TP

Select a specific transponder by using the CH ▲▼ keys.

2.1.3 LNB Power

Set LNB power on/off by using ◀▶ keys.

2.1.4 LNB type

Select LNB type using ◀ ▶ keys.

There are 5 LNB alternatives.

- Universal 1 (9750MHz & 10600 MHz)
- Universal 2 (9750MHz & 10750 MHz)
- Single-SL (5150MHz & 5750 MHz)
- Single-SH (5150MHz & 5750 MHz)
- Standard

22kHz control is automatically set for each LNB alternative.

If Universal 1 or 2 is selected, 22kHz control should be "off state."

2 OPERATION

2.1.5 LNB Lo-Freq

If the required LNB frequency is not available, select "Standard" and then enter the frequency manually using the numeric keys.

2.1.6 22kHz

In case you are using a Dual LNB or two antennas connected to a 22kHz tone switch box, make 22kHz tone switch "ON" or "OFF" to select an LNB or an antenna.

2.1.7 DiSEqC

• Full DiSEqC

If DiSEqC switching box is used in this Receiver, Select the port number to get the RF signal from the LNB, which is connected, to DiSEqC switching box.

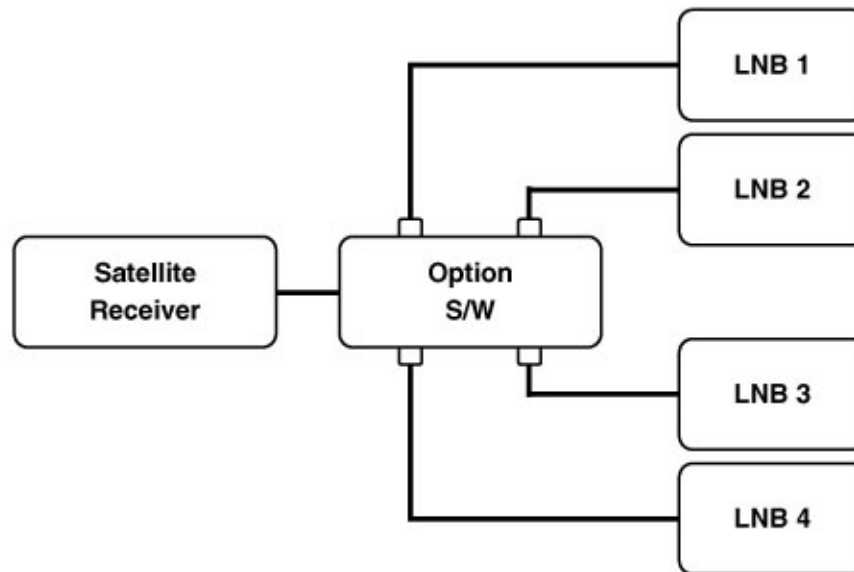

• Option DiSEqC box

If the option switch is only used as shown in below figure. There are two kinds of different ways to scan satellite depending on LNB type.

(1) For universal LNB.

Select a DiSEqC number to which the RF signal is fed the LNB.

(2) For standard LNB.

For low band scanning, "set 22kHz" to off and select a DiSEqC number.

For high band scanning, "set 22kHz" to off and select a DiSEqC number.

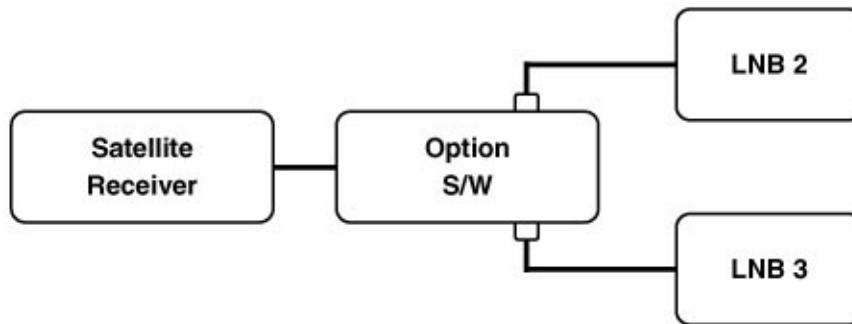

2.1.8 Positioner Setting

In case, when positioner set is OFF state, it is used to set the DiSEqC 1.2 moter & USALS. If you have no positioner equipment, you should be disable state, otherwise you can select either DiSEqC 1.2 or USALS.

Please concern page 20, 2.7 Motorized Antenna Setup.

1) DiSEqC 1.2

(1) Current position

Select the position number by using ◀▶ keys (#0~#26: default define, #27~#49: users define)

(2) Movement

Select East / West by using ◀▶ keys and press OK to stop

(3) Nudge East / West

Select Nudge East / West by using ◀▶ keys and press OK to save current position

(4) Recalculation

If it is used to shift the position for all satellites

Select Recalculation by using OK key and is makes above movement function

(5) East Limit Set

Move the position to the most eastern position and press OK then East Limit is stored

(6) West Limit Set

Move the position to the most western position OK then East Limit is stored

(7) Limits Disable

Select Disable limits by using OK key

(8) Go to reference

Select got to reference by using OK key

2 OPERATION

2) USALS (DiSEqC 1.3)

(1) Satellite Position

It points out the position of saved satellite.

You can change the position of the satellite by numeric keys

(2) My Longitude

Please input Local Longitude by numeric keys

(3) My latitude

Please input Local Latitude by numeric keys

(4) Reference position

This is same as DiSEqC 1.2 Reference

(5) Move

The satellite's position of (1) and the one calculated by value of (2) & (3) will be shown. Press OK key and it will move.

(6) Store

Please select "Store" and the present position will be saved.

2.1.9 Save

After all LNB setting is finished, press Exit and OK to save.

2.2 Channel scan

2.2.1 Satellite

Select a satellite by using CH▲▼ keys.

2.2.2 Down Frequency

Select a specific transponder by using CH▲▼ keys or input its value by using numeric keys.

2.2.3 Symbol rate

If the require Symbol rate is not available, enter the Symbol rate manually by using numeric keys.

2.2.4 Polarity

- Select Horizontal / Vertical with ◀▶ keys.
- All : Scan Horizontal and Vertical.
- Horizontal : Scan Horizontal TP only.
- Vertical : Scan Vertical TP only.

2.2.5 Scan

After all setting is finished, you can select in 4 way as following.

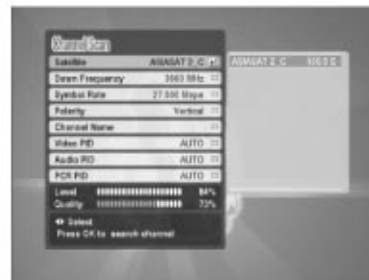

OPERATION 2

1) Multi Satellite Scan

Scan all the transponder of selected satellites.

- (1) Press Red key and Select wanted satellite by using ▼&▲key
(If you want to scan several satellites once, You can control by ◀▶ keys)
Then press OK key to execute scanning.
- (2) Select Scan type with ◀&▶ Key. (You can choose the scan option-Data, FTA only, Network scan)
- (3) You can select satellites whatever You chose though. It is possible to search only for 4 satellites among satellites you chose.
- (4) Transponder will be consecutively scanned all selected satellites.

2) Satellite Scan

Selected satellite is scanned in this menu.

Press Green key to scan.

- (1) Select satellite in the Channel Scan Menu.
- (2) Select Scan type with ◀&▶ Key. (You can choose the scan option-Data, FTA only, Network scan)
- (3) Press OK key to scan.

3) Multi TP Scan

Press Yellow key and select wanted TP by using CH▼▲keys.

(If you want to scan several TP once, you can control by keys.)

Select Scan type with ◀&▶ Key. Then press OK to execute scanning.

4) TP Scan

Selected TP is scanned in this menu.

- (1) Select TP on 'Down Frequency' in the channel scan menu.
- (2) Press OK key or Blue key on the Polarity in the channel scan menu.

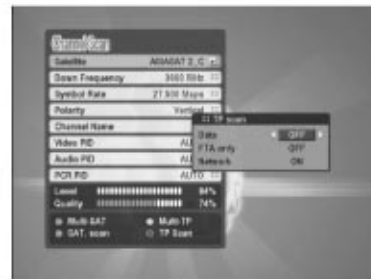

2 OPERATION

2.3 Power Scan

2.3.1 LNB Configuration

Please refer to 4.1 Antenna Setup.

2.3.2 Polarity

- Select Horizontal / Vertical with ◀▶ keys.
- All : Scan Horizontal and Vertical.
- Horizontal : Scan Horizontal TP only.
- Vertical : Scan Vertical TP only.



2.3.3 Scan

- Select Scan type with ◀▶ keys.
- When you select the OK key, the scanning will start.

2.4 Edit TP/ Satellite

In this mode, you can add the New- Satellite and the new transponder information.

Also you can update or delete the transponder information.

2.4.1 How to rename the satellite

- Press Red key after selecting a satellite of which you want to change name.
- Enter new name by using VOL ◀▶ or CH ▲▼ keys and press OK on the keyboard in the menu screen.

2.4.2 How to add a new transponder

- Press OK after selecting a satellite
- Press OK key selecting "NEW" in the transponder list or Red key
- Enter the Down frequency, Symbol Rate and LNB Polarity
- Press EXIT or OK, the new transponder information is stored

2.4.3 How to delete or update a transponder added

- Press OK key after selecting a satellite
- Select a transponder, or press Yellow key to Delete
- Press OK on the TP you want to Edit or Delete
- You can see the Edit or Delete in the small-menu
- In case you want to Edit a list TP
Select Green key and press "OK key
Enter Down frequency, LNB polarity and Symbol Rate and press "EXIT" or OK
Then New TP date is automatically updated

OPERATION 2

- In case you want to Delete a TP
Select Yellow key in the small menu, press OK key
Then the TP selected is deleted

2 OPERATION

3. Parental Control

After selecting Parental control and entering the correct password, the screen as shown in the right appears. The default password at the factory is "0-0-0-0".

You may change the PIN code, which is your password in other words, and lock the receiver to prevent children from watching program.



3.1 Change PIN Code

You can change the PIN Code (Password) if you want.

- (1) Enter the Old password. If you enter this mode for the first time after purchasing the receiver, the OLD PIN Code is the default password.
- (2) Enter the new password.
- (3) Reenter the new password to confirm.

Warning! You must remember the exchanged password because it is used in several Function as follows.

Password is required

- (1) To show parental locked channels
- (2) To enter main menu when Menu Lock is on
- (3) To enter channel edit menu
- (4) To execute factory setting

4. Channel Edit

In this mode.

- (1) You can sort the channels out upon your Preference.
- (2) You can rearrange the channel list.
- (3) You can delete channel.
- (4) You can adjust the favorite channel list, as required.
- (5) You can skip channels.
- (6) You can change the channel name, as you want.
- (7) To enter channel edit mode, you need to press 4 digit password (factory setting is "0-0-0-0")

4.1 How to sort the channel

- (1) Press OK after selecting Sort.
- (2) Sub mode will be appeared as follows
 - Alphabetic
 - FTA/Scramble
 - P-Lock
 - TP Order
- (3) Select the mode among the 4 kinds of mode that you want to sort and press OK
- (4) Press EXIT to exit from this mode.



Note

The Format of Sorted List

- Alphabetic : In Alphabetical order
- FTA/Scramble : The Free channels first & the scrambled channels later and vice-versa
- P-Lock : The channels of P-Lock first
- TP Order

4.2 How to store/release the favorite channel

- (1) Press Green key.
- (2) Press "OK", then this channel is included to the favorite channel list.
- (3) The mark stands for the favorite channel.
- (4) To delete a channel from the favorite list, go to the marked channel and Press "OK".

2 OPERATION

4.3 Edit

4.3.1 How to move the channel

- (1) After press Yellow key, press Red key.
- (2) Press OK to select a channel to move and then move the selected channel to the new position by using CH ▲▼ keys.
- (3) Repress "OK" key.

4.3.2 How to lock/unlock the channel

- (1) Select the channel that you want to lock and press Green key.
- (2) This channel is now locked and the symbol of lock will be shown as a locked channel.
- (3) You can release the locked channel if you press Green key after selecting the locked channel.
- (4) Once locked channel is selected while watching television, password is requested.
- (5) Picture and sound is appeared after the correct password is given by pressing the numeric key.

4.3.3 How to rename the channel

- (1) Select the channel of which you want to change name
- (2) Press Yellow key to enter the character input mode.
- (3) Put new names, as you want using the 4 arrows keys and numeric key.
The maximum number of characters is 20.
- (4) After completion of entering new, press OK on the keyboard in the menu screen

4.3.4 How to SKIP the channel

- (1) Select the channel you want to hide
- (2) Press Blue key

4.4 How to delete the channel

- (1) Press Blue key.
- (2) Select a channel you want to delete by using the ◀▶ key continuously.
- (3) Press OK key.
- (4) All channels that you selected are deleted.
- (5) You can delete all channel through pressing Red key (All-Ch).

5. User Setup

In this USER SETUP mode, you can select the sub-mode as shown on the [Fig 6] by pressing the OK key and CH ▲▼ key.

The changed set-up is activated and stored by pressing the EXIT key.

5.1 Language

Press the EXIT key after you select your preferable language by using VOL ◀▶ key.

English, German, French, Portugal, Spanish, Turkish, Arabic, Russian



5.2 Aspect ratio

You can set the TV aspect ratio (4:3 for normal TV & 16:9 for wide TV) by pressing VOL ◀▶ keys.

5.3 TV Type

You can set the TV type (PAL, NTSC and AUTO) by pressing VOL ◀▶ keys.

If the setting value is Auto, then TV is set automatically by source program.

So, the source program is PAL, TV set PAL source program is NTSC, TV set NTSC.

5.4 Time Setting

After selecting the Time Setting, you can adjust the time. Also you can set the wakeup time and sleeping time to turn receiver on and off automatically according to the time programmed.

If you want to use EPG, you must set the "Time Zone" (GMT+)



2 OPERATION

5.5 OSD setting

5.5.1 Transparency

You can adjust the transparency level by using ◀▶ key.

5.5.2 OSD Timeout

When you want to fix up the channel information box disappearing function, you have to set the time period at OSD Timeout Menu.

Timeout period is available for 3, 5, 7, 10 seconds and OFF state.

5.6 S/W Transfer

1) Adjust s/w transfer mode using ◀▶ key

2) In case of Code Mode, you should transfer "main s/w" from STB (Master) to STB (Slave).

3) In case of Data Mode, you should transfer "Channel Data" from STB (Master) to STB (Slave).

4) Press "OK" key on RCU and start transferring. Otherwise press EXIT key to cancel the transfer. While transferring, you can watch the procedure of processing shown by percentage

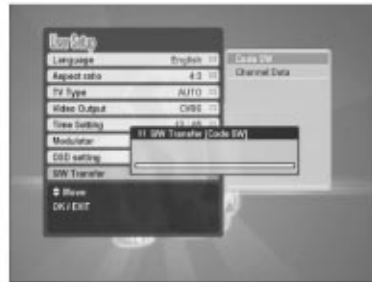

Warning! While transferring, you should not turn off.

2 OPERATION

9. Program Guide

- The title and start time of the program is shown as in the right figure after pressing EPG key.
- Select the particular channel you. The channel will be changed.
- Press OK key to see the EPG according to date. (Repress OK key to see the EPG according to time.)
- If you want to watch TV with full screen, Press EXIT.



10. Audio change

- In multilingual program, favorite language is selected by passing AUDIO key and CH ▲▼ keys
- Audio mode (L-left, R-right, L/R-stereo) can be Changed By pressing AUDIO key and VOL ◀▶ key.



11. Embedded

If you insert smart card inside the receiver's smart card reader, the receiver will recognize it automatically.

12. Recall the Favorite channel

- Press the FAV key to recall a stored favorite channel.
- Favorite channel is programmed and stored in the channel edit menu.

13. Download Procedure between ARIZA 700/750CX & PC

1. Turn the receiver power on.
2. Connect Null Modem RS232C cable (#2&3 twisted) between PC and the receiver.
3. Open the GTRom Loader model.
4. Press BIN FILE.
5. Open the file to download.
6. Press DOWNLOAD.
7. Wait until Download and the receiver Flash write are fully completed.

Warning: Do not interrupt the receiver power until download and flash write are fully completed. Otherwise the receiver will be damaged or dead.

3 SPECIFICATIONS

1. Tuner /LNB

Input Connector	F-type, IEC 169-24, Female
Loop Through Connector	F-type, IEC 169-24, Female
Frequency Range	950 ~ 2150MHz
Signal Level	- 65 ~ - 25 dbm
LNB power & Polarization	Vertical : +13V Horizontal :18V Current : Max. 500mA with Overload Protection
22KHz Tone	Frequency : 22±1KHz Amplitude : 0.6±0.2V
DiSEqC Control Demodulation	Version 1.3 Compatible QPSK
Symbol Rate	1-45Mpsps (SCPC, MCPC)
Viterbi Decoding Rate	1/2, 2/3, 3/4, 5/6, 7/8
Reed Solomon Decoding	FEC:204, 188 t=8

2. MPEG Transport Stream & A/V Decoding

Transport Stream	MPEG-2 ISO/IEC 13818-1
Profile Level	MPEG-2 MP@ML
Input stream	Max. 90Mbit/s
Aspect Ratio	4:3, 16:9
Video Resolution	720x480
Audio Decoding	MPEG layer I and II
Audio Mode	Single/Dual Channel, Stereo, Joint Stereo
Sampling Frequency	16/22.05/24/32/44.01/48 KHz

3. Microprocessor & Memories

Main Processor	Sti 5518 ST20 32 bit
CPU Clock	81 MHz
Flash Memory	2 Mbyte
SDRAM	8 Mbyte
EEPROM	32 Kbit

4. Data Port

Connector	9 Pin D-Sub Type
Protocol	RS232 Asynchronous
Data Rate	Max. 115, 2kbps

5. RF Modulator

RF Connector	75Ω, F-Type Female
Frequency	CH 3 (61.25MHz) / CH 4 (67.25MHz)
Output Channel	CH 3-4
TV Standard	NTSC
Preset Channel	Ch3, Changeable by Menu Screen

6. Front Panel

4 Digits LED Display	Channel Number Display
5 Keys	Power, Ch Up/Down Vol Up/Down
Smart Card Reader	1 Embedded Slot (Only for ARIZA 750CX)

7. Rear Panel

RCA A/V	Video, Audio L, Audio R, S/PDIF YES
S-VIDEO	
AC Power Switch	
RS232 Serial Port MODULATOR	9 Pin D-sub Type YES

8. Remote Control

Type	infra-red (Carrier Freq. 38KHz)
Battery	2x1.5V AAA Type

9. Physical Specification

Input Voltage	AC90-250V, 50/60Hz
Power Consumption	Max. 20 Watts
Standby Power	Less than 8 Watts
Dimension	270 x 160 x 50 mm 1.7 kg
Operating Temperature	0 ~ + 35°C
Storage Temperature	-20 + 60°C

TROUBLE SHOOTING **4**

There may be various reasons for the abnormal of the unit. Therefore, if the unit does not work properly.

check the unit according to the procedures shown in the table below.

Problem	Possible causes	Remedy
LED on front panel does not light	AC power cord disconnected	Connect power cord properly into the power socket
No Picture or sound	Wrong connection of the video/audio output to TV input terminal	Connect two terminals correctly with scart cable or RCA or RF cable
	Wrong connection of satellite antenna cable	Connect the antenna cable correctly
	Wrong direction of satellite antenna	Adjust the direction of antenna
	No signal or weak signal	Check the cable connections, LNB and other equipment connected between the LNB and the receiver or adjust the antenna
	Wrong setting of channel information in MENU screen	Type the setting value correctly
Black-and-white screen or V-Hold	Your TV mode is different from satellite broadcasting mode	Use TV of same mode Use the NTSC/PAL converter connected to the receiver and TV
The remote controller is not working	Battery exhausted	Change the batteries
	Fluorescent light interfering with the remote controller	Switch off the light
	Remote controller is incorrectly aimed	Aim the remote control at the receiver
Distorted menu screen	Too high brightness and contrast level of TV set	Adjust brightness and contrast to low level
Not working	Process Down	Remove the power code or AC switch OFF/ON