



D 7050

Direct Digital Network Amplifier

ENGLISH



Owner's Manual

IMPORTANT SAFETY INSTRUCTIONS

SAVE THESE INSTRUCTIONS FOR LATER USE.

FOLLOW ALL WARNINGS AND INSTRUCTIONS MARKED ON THE AUDIO EQUIPMENT.

- 1 Read instructions** - All the safety and operating instructions should be read before the product is operated.
- 2 Retain instructions** - The safety and operating instructions should be retained for future reference.
- 3 Heed Warnings** - All warnings on the product and in the operating instructions should be adhered to.
- 4 Follow Instructions** - All operating and use instructions should be followed.
- 5 Cleaning** - Unplug this product from the wall outlet before cleaning. Do not use liquid cleaners or aerosol cleaners. Clean only with a dry cloth.
- 6 Attachments** - Do not use attachments not recommended by the product manufacturer as they may cause hazards.
- 7 Water and Moisture** - Do not use this product near water—for example, near a bath tub, wash bowl, kitchen sink, or laundry tub; in a wet basement; or near a swimming pool; and the like.
- 8 Accessories** - Do not place this product on an unstable cart, stand, tripod, bracket, or table. The product may fall, causing serious injury to a child or adult, and serious damage to the product. Use only with a cart, stand, tripod, bracket, or table recommended by the manufacturer, or sold with the product. Any mounting of the product should follow the manufacturer's instructions, and should use a mounting accessory recommended by the manufacturer.
-  **9** A product and cart combination should be moved with care. Quick stops, excessive force, and uneven surfaces may cause the product and cart combination to overturn.
- 10 Ventilation** - Slots and openings in the cabinet are provided for ventilation and to ensure reliable operation of the product and to protect it from overheating, and these openings must not be blocked or covered. The openings should never be blocked by placing the product on a bed, sofa, rug, or other similar surface. This product should not be placed in a built-in installation such as a bookcase or rack unless proper ventilation is provided or the manufacturer's instructions have been adhered to.
- 11 Power Sources** - This product should be operated only from the type of power source indicated on the marking label. If you are not sure of the type of power supply to your home, consult your product dealer or local power company. The primary method of isolating the amplifier from the mains supply is to disconnect the mains plug. Ensure that the mains plug remains accessible at all times. Unplug the AC power cord from the AC outlet if the unit will not be used for several months or more.
- 12 Grounding or Polarization** - This product may be equipped with a polarized alternating current line plug (a plug having one blade wider than the other). This plug will fit into the power outlet only one way. This is a safety feature. If you are unable to insert the plug fully into the outlet, try reversing the plug. If the plug should still fail to fit, contact your electrician to replace your obsolete outlet. Do not defeat the safety purpose of the polarized plug.
- 13 Power Cord Protection** - Power supply cords should be routed so that they are not likely to be walked on or pinched by items placed upon or against them, paying particular attention to cords at plugs, convenience receptacles, and the point where they exit from the product.
- 14 Outdoor Antenna Grounding** - If an outside antenna or cable system is connected to the product, be sure the antenna or cable system is grounded so as to provide some protection against voltage surges and built-up static charges. Article 810 of the National Electrical Code, ANSI/NFPA 70, provides information with regard to proper grounding of the mast and supporting structure, grounding of the lead-in wire to an antenna discharge unit, size of grounding conductors, location of antenna discharge unit, connection to grounding electrodes, and requirements for the grounding electrode.

NOTE TO CATV SYSTEM INSTALLER

This reminder is provided to call the CATV system installer's attention to Section 820-40 of the NEC which provides guidelines for proper grounding and, in particular, specifies that the cable ground shall be connected to the grounding system of the building, as close to the point of cable entry as practical.

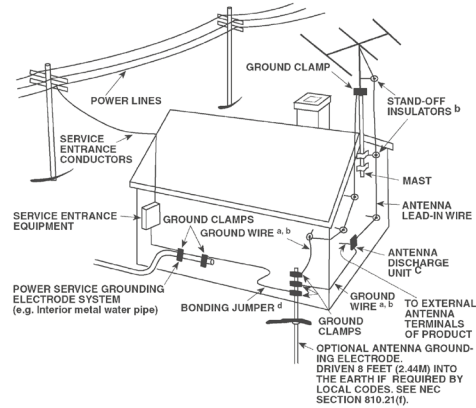

- 15 Lightning** - For added protection for this product during a lightning storm, or when it is left unattended and unused for long periods of time, unplug it from the wall outlet and disconnect the antenna or cable system. This will prevent damage to the product due to lightning and power line surges.
- 16 Power Lines** - An outside antenna system should not be located in the vicinity of overhead power lines or other electric light or power circuits, or where it can fall into such power lines or circuits. When installing an outside antenna system, extreme care should be taken to keep from touching such power lines or circuits as contact with them might be fatal.
- 17 Overloading** - Do not overload wall outlets, extension cords, or integral convenience receptacles as this can result in a risk of fire or electric shock.
- 18 Object and Liquid Entry** - Never push objects of any kind into this product through openings as they may touch dangerous voltage points or short-out parts that could result in a fire or electric shock. Never spill liquid of any kind on the product.

WARNING: THE APPARATUS SHOULD NOT BE EXPOSED TO DRIPPING OR SPLASHING, AND OBJECTS FILLED WITH LIQUIDS, SUCH AS VASES, SHOULD NOT BE PLACED ON THE APPARATUS. AS WITH ANY ELECTRONIC PRODUCTS, USE CARE NOT TO SPILL LIQUIDS INTO ANY PART OF THE SYSTEM. LIQUIDS CAN CAUSE A FAILURE AND/OR A FIRE HAZARD.

- 19 Damage Requiring Service** - Unplug this product from the wall outlet and refer servicing to qualified service personnel under the following conditions:
 - a) When the power supply cord or plug is damaged.
 - b) If liquid has been spilled, or objects have fallen into the product.
 - c) If the product has been exposed to rain or water.
 - d) If the product does not operate normally by following the operating instructions. Adjust only those controls that are covered by the operating instructions as an improper adjustment of other controls may result in damage and will often require extensive work by a qualified technician to restore the product to its normal operation.
 - e) If the product has been dropped or damaged in any way.
 - f) when the product exhibits a distinct change in performance-this indicates a need for service.
- 20 Replacement Parts** - When replacement parts are required, be sure the service technician has used replacement parts specified by the manufacturer or have the same characteristics as the original part. Unauthorized substitutions may result in fire, electric shock, or other hazards.
- 21 Safety Check** - Upon completion of any service or repairs to this product, ask the service technician to perform safety checks to determine that the product is in proper operating condition.
- 22 Wall or Ceiling Mounting** - The product should be mounted to a wall or ceiling only as recommended by the manufacturer.
- 23 Heat** - The product should be situated away from heat sources such as radiators, heat registers, stoves or other products (including amplifiers) that produce heat.
- 24 Headphones** - Excessive sound pressure from earphones and headphones can cause hearing loss.

IMPORTANT SAFETY INSTRUCTIONS

25 Battery Disposal - When disposing of used batteries, please comply with governmental regulations or environmental public instruction's rules that apply in your country or area. Batteries (battery pack or batteries installed) must not be exposed to excessive heat such as sunshine, fire or the like.

FCC STATEMENT

This device complies with Part 15 of the FCC Rules. Its operation is subject to the following two conditions:

- (1) This device may not cause harmful interference, and
- (2) This device must accept any interference received, including interference that may cause undesired operation.

DÉCLARATION DE LA FCC

Cet appareil est conforme à la section 15 des réglementations de la FCC. Le fonctionnement de l'appareil est sujet aux deux conditions suivantes :

- (1) cet appareil ne doit pas provoquer d'interférences néfastes, et
- (2) cet appareil doit tolérer les interférences reçues, y compris celles qui risquent de provoquer un fonctionnement indésirable.

IC STATEMENT

This device complies with Industry Canada license-exempt RSS standard(s). Operation is subject to the following two conditions:

- (1) This device may not cause interference, and
- (2) This device must accept any interference, including interference that may cause undesired operation of the device.

DECLARATION DE L'IC

Cet appareil s'accorde avec Industrie Canada licence-exempte RSS standard. Le fonctionnement de l'appareil est sujet aux deux conditions suivantes :

- (1) cet appareil ne doit pas provoquer d'interférences néfastes, et
- (2) cet appareil doit tolérer les interférences reçues, y compris celles qui risquent de provoquer un fonctionnement indésirable.

WARNING

TO REDUCE THE RISK OF FIRE OR ELECTRIC SHOCK, DO NOT EXPOSE THIS PRODUCT TO RAIN OR MOISTURE.

CAUTION

TO PREVENT ELECTRIC SHOCK, MATCH WIDE BLADE OF PLUG TO WIDE SLOT, FULLY INSERT.



THE LIGHTNING FLASH WITH ARROWHEAD SYMBOL, WITHIN AN EQUILATERAL TRIANGLE, IS INTENDED TO ALERT THE USER TO THE PRESENCE OF UNINSULATED "DANGEROUS VOLTAGE" WITHIN THE PRODUCT'S ENCLOSURE THAT MAYBE OF SUFFICIENT MAGNITUDE TO CONSTITUTE A RISK OF ELECTRIC SHOCK TO PERSONS.



THE EXCLAMATION POINT WITHIN AN EQUILATERAL TRIANGLE IS INTENDED TO ALERT THE USER TO THE PRESENCE OF IMPORTANT OPERATING AND MAINTENANCE (SERVICING) INSTRUCTIONS IN THE LITERATURE ACCOMPANYING THE APPLIANCE.



CAUTION

Changes or modifications to this equipment not expressly approved by NAD Electronics for compliance could void the user's authority to operate this equipment.

CAUTION REGARDING PLACEMENT

To maintain proper ventilation, be sure to leave a space around the unit (from the largest outer dimensions including projections) that is equal to or greater than shown below.

Left and Right Panels: 10 cm

Rear Panel: 10 cm

Top Panel: 10 cm

NOTES ON ENVIRONMENTAL PROTECTION



At the end of its useful life, this product must not be disposed of with regular household waste but must be returned to a collection point for the recycling of electrical and electronic equipment. The symbol on the product, user's manual and packaging, point this out.



The materials can be reused in accordance with their markings.

Through re-use, recycling of raw materials or other forms of recycling of old products, you are making an important contribution to the protection of our environment. Your local administrative office can advise you of the responsible waste disposal point.

INFORMATION ABOUT COLLECTION AND DISPOSAL OF WASTE BATTERIES (DIRECTIVE 2006/66/EC OF THE EUROPEAN PARLIAMENT AND THE COUNCIL OF EUROPEAN UNION) (FOR EUROPEAN CUSTOMERS ONLY)



Pb

Batteries bearing any of these symbols indicate that they should be treated as "separate collection" and not as municipal waste. It is encouraged that necessary measures are implemented to maximize the separate collection of waste batteries and to minimize the disposal of batteries as mixed municipal waste.

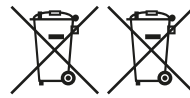

Hg

Cd

End-users are exhorted not to dispose waste batteries as unsorted municipal waste. In order to achieve a high level of recycling waste batteries, discard waste batteries separately and properly through an accessible collection

point in your vicinity. For more information about collection and recycling of waste batteries, please contact your local municipality, your waste disposal service or the point of sale where you purchased the items.

By ensuring compliance and conformance to proper disposal of waste batteries, potential hazardous effects on human health is prevented and the negative impact of batteries and waste batteries on the environment is minimized, thus contributing to the protection, preservation and quality improvement of the environment.

RECORD YOUR MODEL NUMBER (NOW, WHILE YOU CAN SEE IT)

The model and serial number of your new D 7050 are located on the back of the cabinet. For your future convenience, we suggest that you record these numbers here:

Model no.:

Serial no.:

INTRODUCTION

GETTING STARTED

UNPACKING AND SETUP

WHAT'S IN THE BOX

Packed with your D 7050 you will find:

- Detachable mains power cord
- Remote control with 3V CR2025 battery
- Eight pieces of dome-shaped feet
- Quick Setup Guide

SAVE THE PACKAGING

Please save the box and all the packaging in which your D 7050 arrived. Should you move or otherwise need to transport your D 7050, this is by far the safest container in which to do so. We've seen too many otherwise perfect components damaged in transit for lack of a proper shipping carton, so please: Save that box!

QUICK SETUP

This simple guide will help you get started with your D 7050.

Place the D 7050 on a firm, level surface. Do not place the unit on a soft surface like a carpet.

Make all the connections to your D 7050 with the unit unplugged from the mains power source. It is also advisable to power down or unplug all associated components while making or breaking any signal or AC power connections.

- 1 Using applicable connectors (not supplied), connect source devices to corresponding input sockets of D 7050.
S/PDIF sources → OPTICAL 1, OPTICAL 2, COAXIAL 1, COAXIAL 2
Analog sources → AUX 1, AUX 2
iOS device → DOCK
Other sources → AirPlay, Bluetooth, Computer
- 2 Using applicable connectors (not supplied), connect the digital audio input and analog audio input ports to the corresponding audio input sockets of other devices like receivers, amplifiers, audio processors or music system.
- 3 Connect corresponding end of the mains power cord to the AC mains input of the D 7050 and the plug connected to a mains power source.
- 4 With all applicable sources hooked up with D 7050 and powered up, press  (Standby) to switch ON the D 7050 from standby mode.
- 5 Start listening to your preferred Source by repeatedly pressing "S" to cycle through the Sources (COAXIAL 1, COAXIAL 2, OPTICAL 1, OPTICAL 2, COMPUTER, AIRPLAY, DOCK and BT) and select desired Source.

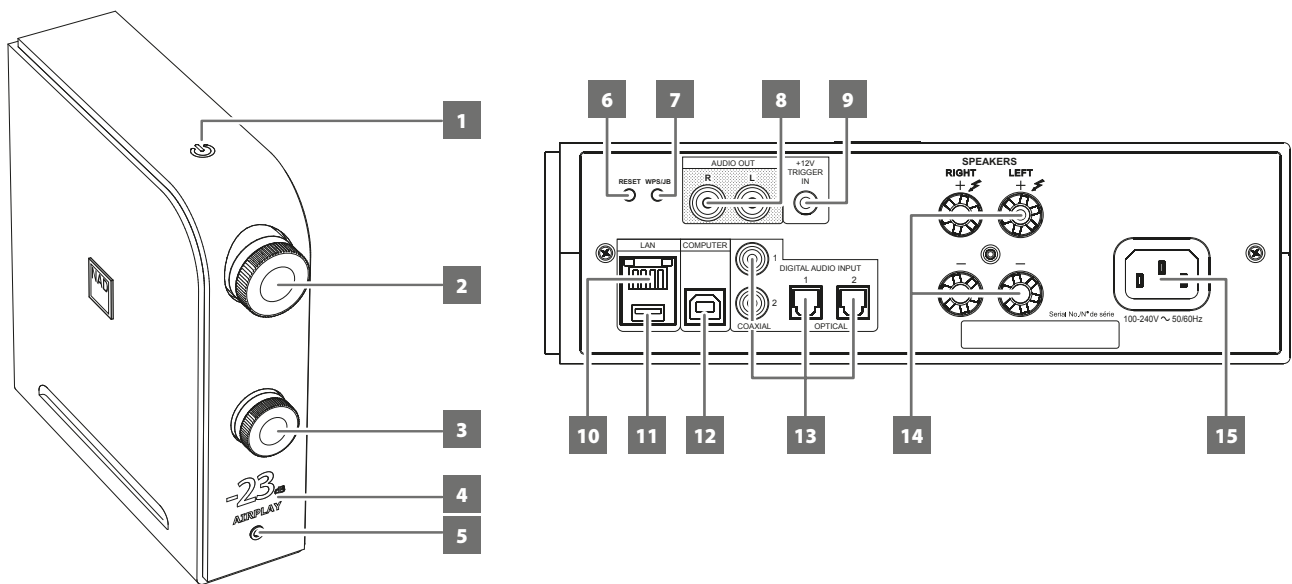

1 **⏻ (STANDBY)**

- With the corresponding end of the mains power cord connected to the AC mains input of the D 7050 and the plug connected to a mains power source, press **⏻ (Standby)** to switch ON the D 7050 from standby mode. The Standby indicator will turn from amber to bright/white color. Pressing **⏻ (Standby)** again turns the unit back to standby mode.

2 **VOLUME**

- Adjust audio level by turning clockwise or counterclockwise.

3 **S (SOURCE)**

- Toggle to cycle through the Sources (COAXIAL 1, COAXIAL 2, OPTICAL 1, OPTICAL 2, COMPUTER, AIRPLAY, DOCK, BT) and select desired Source.

4 **DISPLAY**

- Illuminate the selected or active Source (OPT1, OPT2, COAX, DOCK, AUX 1, AUX 2, BT) and current audio level.
- Display follows the orientation of the unit - vertical and horizontal view as shown on the front cover.

5 **PHONES**

- A 3.5 mm stereo jack socket is supplied for headphone listening.
- Specially designed low noise headphone circuitry can accommodate a wide range of phones, even 600 Ohm studio models.
- Ensure that the volume control is turned to minimum (fully counterclockwise) before connecting or disconnecting headphones. Listening at high levels can damage your hearing.
- Inserting a headphone jack into this socket automatically switches off the loudspeakers.

6 **RESET**

- Restore factory default settings.

7 **WPS/JB**

- Use to setup wireless network connection.

8 **AUDIO OUT**

- Use a twin RCA-to-RCA lead to connect these sockets to the left and right analog output of a CD player, preamplifier, processor or other applicable devices.

9 **+12V TRIGGER IN**

- Connect this +12V Trigger input to the remote device's corresponding +12V DC output jack using a mono cable with 3.5mm male plug. The controlling device must be equipped with a +12V trigger output to use this feature.

10 **LAN**

- LAN connection must be setup for wired connection to be established. Set up a Wired Ethernet broadband router with broadband internet connection. Your router or home network should have a built-in DHCP server to consummate the connection.
- Using a standard straight-through Ethernet cable (not supplied), connect one end of the Ethernet cable to the LAN port of your wired Ethernet broadband router and the other end to D 7050's LAN port.

11 **DOCK**

- Applicable for direct playback only of iOS device. Using applicable Apple USB connector, connect your iOS device to this input.
- Allow direct charging of smartphone or android devices using applicable connector (not supplied).

IDENTIFICATION OF CONTROLS

12 COMPUTER

- Asynchronous USB 24 bit/96 kHz input assures lowest jitter for best musical performance.
- Using Type A to Type B cable connector (not supplied), interface computer audio to this asynchronous Type B USB input to directly stream 24/96 PCM content from your PC or MAC.
- Ensure that the Sound or Audio device setting of your computer is set to "NAD USB Audio".

MINIMUM PC SYSTEM REQUIREMENT

Microsoft Windows XP Service Pack 2 or higher, Microsoft Windows 7

FOR MAC USERS

Minimum Mac OS X Snow Leopard (version 10.6) and later versions

NOTE

Download and install to your PC the NAD USB Audio driver from the Manuals/Downloads tab of the NAD web address <http://nadelectronics.com/products/digital-music/D-7050-Direct-Digital-Network-Amplifier>.

13 DIGITAL AUDIO INPUT

(COAXIAL 1, COAXIAL 2, OPTICAL 1, OPTICAL 2)

- Connect to the corresponding optical or coaxial digital output of sources such as CD or BD/DVD players, digital cable box, digital tuners and other applicable components.

14 SPEAKERS

- Connect the right speaker to the terminals marked "R +" and "R-" ensuring that the "R+" is connected to the "+" terminal on your loudspeaker and the "R-" is connected to the loudspeaker's "-" terminal. Connect the left speaker to the terminals marked "L +" and "L-" ensuring that the "L+" is connected to the "+" terminal on your loudspeaker and the "L-" is connected to the loudspeaker's "-" terminal.

15 AC MAINS INPUT

- The D 7050 comes supplied with a separate detachable mains power cord. Before connecting the plug to the mains power source, ensure that it is firmly connected to the D 7050's AC Mains input socket first.
- Always disconnect the mains power plug from the mains power source first, before disconnecting the cable from the D 7050's AC Mains input socket.

IDENTIFICATION OF CONTROLS

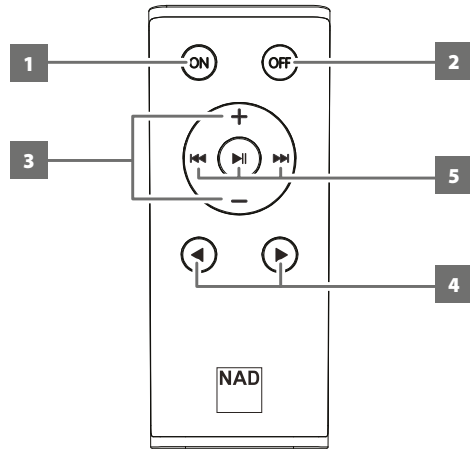

REMOTE CONTROL

- 1 ON:** Switch D 7050 from Standby mode to operating mode.
- 2 OFF:** Switch D 7050 to standby mode.
- 3 +/- :** Increase or decrease audio level.
- 4 ◀ ▶ :** Select source.
- 5 TUNER CONTROLS** (applicable for NAD products with Tuner section)
 - ◀▶▶▶ :** Step up or down Presets.
 - ▶|| :** Select applicable Tuner bands.

BATTERY INSERTION PROCEDURE

- 1 Insert a hooked tip into the battery door release hole.

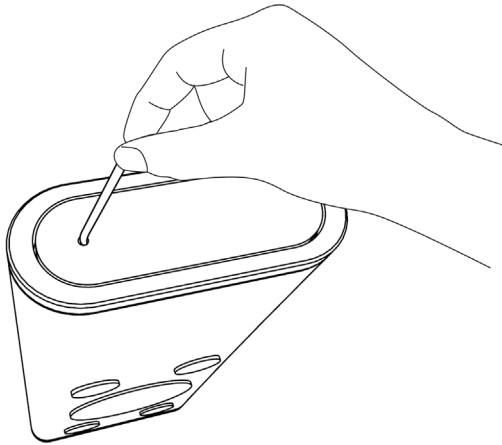

- 2 Slide out the battery tray.

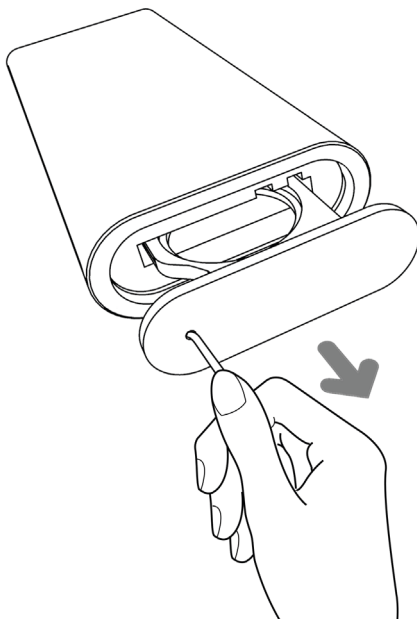

- 3 Place the supplied CR2025 battery into the tray. Ensure the "+" symbol is facing upwards.



- 4 Slide the tray back until it clicks into place.

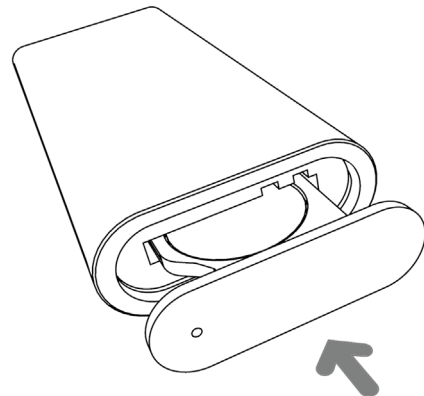

CONNECT AIRPLAY

AirPlay lets you stream music from your AirPlay-enabled device to the D 7050. The AirPlay-enabled device and the D 7050 must be in the same network to send and receive streaming audio with AirPlay. This connection could be wired, using Ethernet cable, or wireless.

SETTING UP NETWORK CONNECTION

The D 7050 can be connected to a network using any of the following methods

- A Wired connection
- B Wireless connection
- C Share Wi-Fi setting

Start playback of your device after successful network connection using any of the above methods.

WIRED CONNECTION

Network connection using Ethernet broadband connection. Set up a Wired Ethernet broadband router with broadband internet connection. Your router or home network should have a built-in DHCP server to consummate the connection.

- 1 Using a standard straight-through Ethernet cable, connect one end of the Ethernet cable (not supplied) to the LAN port of your wired Ethernet broadband router and the other end to D 7050's LAN port.
- 2 Connection is established when a solid signal strength bar indicator  appears in the upper right corner of the D 7050 display.



It is advisable that wired connection is utilized when possible. Wired connection is less likely to have "drop-out" or range problem and not vulnerable to interference or eavesdropping.

WIRELESS CONNECTION

Wireless (WiFi) broadband router with broadband internet connection is required for wireless connection to be established. D 7050 can be connected wirelessly via two methods

- A WPS key pairing
- B Access point mode

WPS KEY PAIRING

- 1 Short press the **WPS** button located at the real panel of D 7050. Press also the corresponding **WPS** button in your router. A flashing signal strength bar indicator  appears in the upper right corner of the D 7050 display.
- 2 The D 7050 will attempt to detect the WPS signal from the router and establish a wireless connection.
- 3 Wireless connection is established when the flashing signal bar indicator  turns to solid bar.

ACCESS POINT MODE

The D 7050 can act as an Access Point (AP) enabling it to connect to a wired network wirelessly.

- 1 Press and hold **WPS** button located at the real panel of D 7050 for about 3 seconds and then release it. A flashing signal strength bar indicator  appears in the upper right corner of the D 7050 display.
- 2 Using your iOS device (iPad is used here for reference), select among the list of available network connections the unique network ID (**D7050 00EBC8** in this example) of your D 7050.

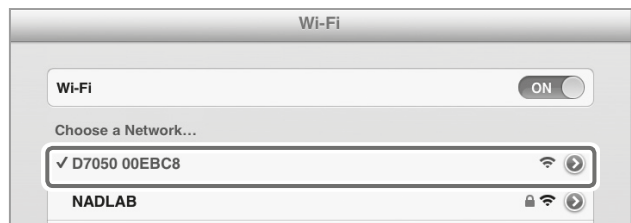

- 3 Launch Safari and enter <http://192.168.1.1>. The NAD AirPlay Setup menu window will appear. While at **Network Configuration** section, select **Select Option** at **Service Set ID (SSID)**.

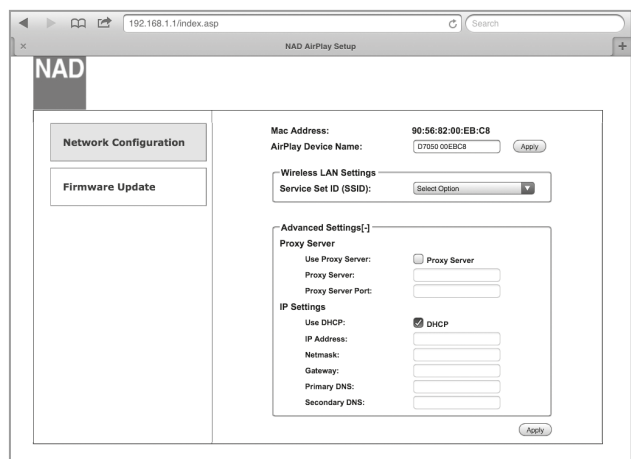

- Select your local network from the drop down **SSID** list - **NADLAB (WPA2 CCMP)** in this example.

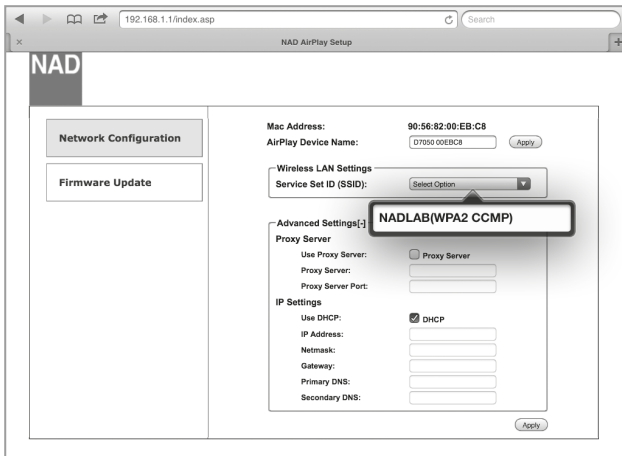

- Type the **WPA Passphrase** (if it is password protected) of your local network in the field provided and then select **Go** to join in.

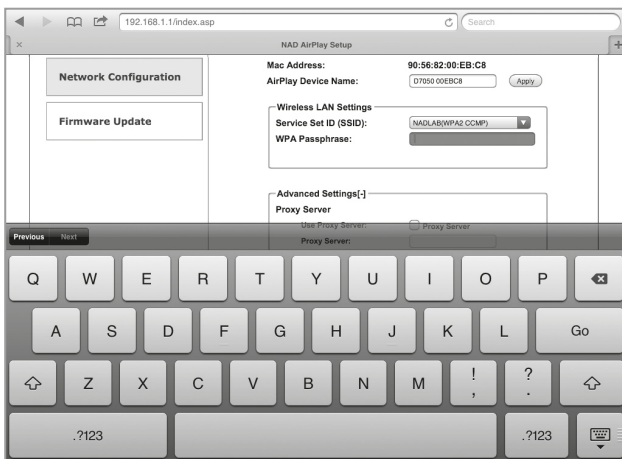

- A Warning notice will pop-up. Select **OK** to save the new settings. The flashing signal bar indicator  turns to solid bar. Your iOS device (iPad) is now interfaced with the D 7050.

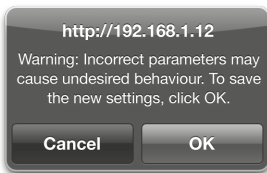

- Return to the **Wi-Fi** settings of your iOS (iPad) device and ensure that it is set to the same network setting as above (**NADLAB**).

SHARE WIFI SETTINGS

WiFi connection can also be achieved by directly connecting your iOS device to the DOCK input of the D 7050. Follow below procedure for automatic network detection and connection.

- Using applicable Apple USB cable (not supplied), connect iOS device to DOCK input at the rear panel of D 7050 to share WiFi settings.
- Short press **WPS** button located at the rear panel of D 7050. A flashing signal strength bar indicator  appears in the upper right corner of the D 7050 display.
- A **Share Wi-Fi Settings** notice will pop-up.



- Select **Allow** to complete sharing of WiFi settings.
- Wireless connection is established when the flashing signal bar indicator  turns to solid bar. Upon successful WiFi sharing, you can disconnect the iOS device from the D 7050.

AIRPLAY PLAYBACK

After your AirPlay-enabled device and D 7050 are connected to the same network, the Airplay source will detect the D 7050. Select the AirPlay icon () that appears in the application display and select the unique ID of your D 7050 (**D7050 00EBC8** in the example below).

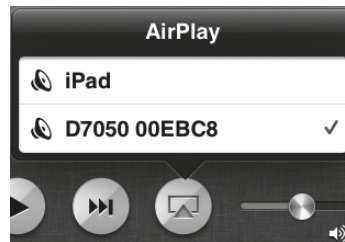

Audio from your AirPlay-enabled device will be streamed to the D 7050.

CONNECT TO BLUETOOTH DEVICE

Pair Bluetooth device with the unique device ID of D 7050 (D7050 BT 010DB6 in this example). Start playback of Bluetooth device upon successful pairing.

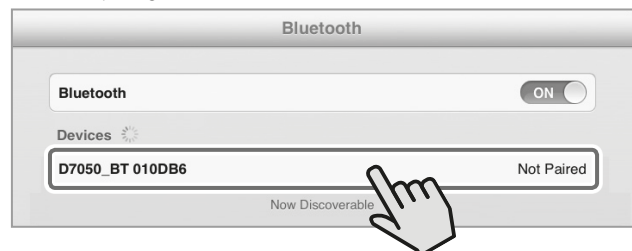

OTHER FEATURES

FEET INSTALLATION GUIDE

The dome-shaped feet are supplied for optional installation. There are two ways of installing the feet as per suggested methods below. You may generate a template for proper placement of the feet.

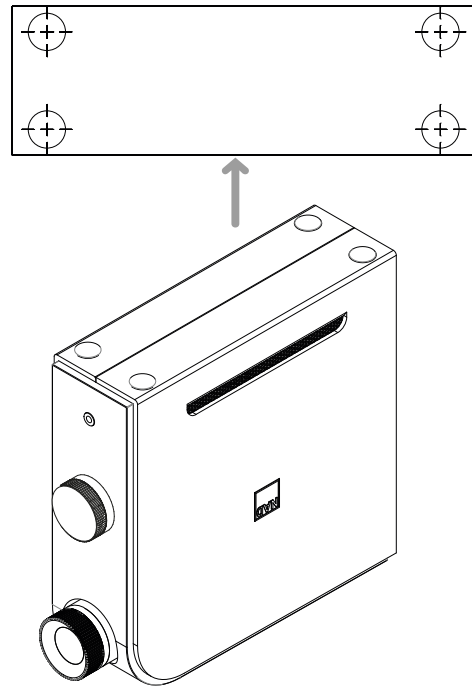
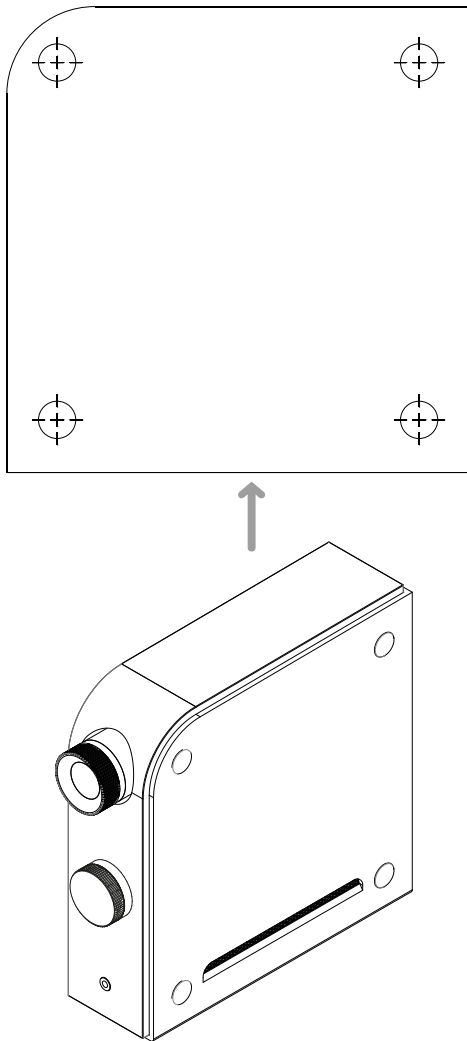

NOTE

Ensure that with the feet installed, the D 7050 is stable, balanced and will not tip over.

AUDIO SPECIFICATIONS

Rated power at 4 ohms	50W
Signal-to-Noise ratio (A-weighted)	≥ 90 dB
Crosstalk (1 kHz)	≥ 85dB
Crosstalk (10 kHz)	≥ 70 dB
Frequency response (20 Hz – 96 kHz)	0 dB to - 0.3 dB
Total Harmonic Distortion	≤ 0.004 %
IMD (SMPTE)	0.02 %
IMD (CCIF)	0.003 %

GENERAL SPECIFICATIONS

Standby power	≤ 0.5W
Supports bit rate/sample rate	up to 24/192
Unit dimensions W x H x D (Gross)	70 x 235 x 275 mm 2 ¹³ / ₁₆ x 9 ⁵ / ₁₆ x 10 ⁷ / ₈ inches
Shipping weight	3.3 kg (7.3 lbs)

NAD SHALL NOT BE HELD LIABLE FOR ANY TECHNICAL OR USER INTERFACE DISCREPANCIES IN THIS MANUAL. THE D 7050 OWNER'S MANUAL MAY BE SUBJECT TO CHANGE WITHOUT PRIOR NOTICE. CHECK OUT WWW.NADELECTRONICS.COM FOR THE LATEST VERSION OF THE D 7050 OWNER'S MANUAL.



www.NADelectronics.com

**©2013 NAD ELECTRONICS INTERNATIONAL
A DIVISION OF LENBROOK INDUSTRIES LIMITED**

All rights reserved. NAD and the NAD logo are trademarks of NAD Electronics International, a division of Lenbrook Industries Limited.
No part of this publication may be reproduced, stored or transmitted in any form without the written permission of NAD Electronics International.
While every effort has been made to ensure the contents are accurate at the time of publication, features and specifications may be subject to change without prior notice.

D7050_ENG_OM_V08 - JUL 2013