



TEST REPORT

Report Reference No...... : **TRE1709020601** R/C.....: 66854

FCC ID..... : **SVC-HP70**

Applicant's name..... : **Lenbrook Industries Limited**

Address.....: 633 Granite Court, Pickering, Ontario L1W 3K1, Canada

Manufacturer.....: Wata Electronics Co., Ltd.

Address.....: No 142, South Tanshen Road, Tanzhou Town, Zhongshan City, Guangdong, China

Test item description : **Bluetooth Headphone**

Trade Mark: NAD

Model/Type reference.....: HP70

Listed Model(s): -

Standard : **FCC CFR Title 47 Part 15 Subpart C Section 15.247**

Date of receipt of test sample.....: Sept. 22, 2017

Date of testing.....: Sept. 23, 2017 - Oct. 15, 2017

Date of issue.....: Oct. 16, 2017

Result.....: **PASS**

Compiled by
(Position+Printed name+Signature): File administrators Becky Liang

Supervised by
(Position+Printed name+Signature): Project Engineer Jerry Wang

Approved by
(Position+Printed name+Signature): RF Manager Hans Hu

Testing Laboratory Name : **Shenzhen Huatongwei International Inspection Co., Ltd.**

Address.....: 1/F, Bldg 3, Hongfa Hi-tech Industrial Park, Genyu Road, Tianliao, Gongming, Shenzhen, China

Shenzhen Huatongwei International Inspection Co., Ltd. All rights reserved.

This publication may be reproduced in whole or in part for non-commercial purposes as long as the Shenzhen Huatongwei International Inspection Co., Ltd. is acknowledged as copyright owner and source of the material. Shenzhen Huatongwei International Inspection Co., Ltd. takes no responsibility for and will not assume liability for damages resulting from the reader's interpretation of the reproduced material due to its placement and context.

The test report merely correspond to the test sample.

Contents

1.	<u>TEST STANDARDS AND REPORT VERSION</u>	3
1.1.	Test Standards	3
1.2.	Report version	3
2.	<u>TEST DESCRIPTION</u>	4
3.	<u>SUMMARY</u>	5
3.1.	Client Information	5
3.2.	Product Description	5
3.3.	Operation state	6
3.4.	EUT configuration	6
3.5.	Modifications	6
4.	<u>TEST ENVIRONMENT</u>	7
4.1.	Address of the test laboratory	7
4.2.	Test Facility	7
4.3.	Environmental conditions	8
4.4.	Statement of the measurement uncertainty	8
4.5.	Equipments Used during the Test	9
5.	<u>TEST CONDITIONS AND RESULTS</u>	10
5.1.	Antenna requirement	10
5.2.	Conducted Emissions (AC Main)	11
5.3.	Conducted Peak Output Power	12
5.4.	20 dB Bandwidth	16
5.5.	Carrier Frequencies Separation	20
5.6.	Hopping Channel Number	22
5.7.	Dwell Time	24
5.8.	Pseudorandom Frequency Hopping Sequence	28
5.9.	Restricted band (radiated)	29
5.10.	Band edge and Spurious Emissions (conducted)	31
5.11.	Spurious Emissions (radiated)	51
6.	<u>TEST SETUP PHOTOS</u>	55
7.	<u>EXTERANAL AND INTERNAL PHOTOS</u>	56

1. TEST STANDARDS AND REPORT VERSION

1.1. Test Standards

The tests were performed according to following standards:

[FCC Rules Part 15.247](#): Frequency Hopping, Direct Spread Spectrum and Hybrid Systems that are in operation within the bands of 902-928 MHz, 2400-2483.5 MHz, and 5725-5850 MHz

[ANSI C63.10-2013](#): American National Standard for Testing Unlicensed Wireless Devices

1.2. Report version

Version No.	Date of issue	Description
00	Oct. 16, 2017	Original

2. TEST DESCRIPTION

Test Item	Section in CFR 47	Result	Test Engineer
Antenna Requirement	15.203/15.247 (c)	Pass	William Wang
AC Power Line Conducted Emissions	15.207	N/A	N/A
Conducted Peak Output Power	15.247 (b)(1)	Pass	William Wang
20 dB Bandwidth	15.247 (a)(1)	Pass	William Wang
Carrier Frequencies Separation	15.247 (a)(1)	Pass	William Wang
Hopping Channel Number	15.247 (a)(1)	Pass	William Wang
Dwell Time	15.247 (a)(1)	Pass	William Wang
Pseudorandom Frequency Hopping Sequence	15.247(b)(4)	Pass	William Wang
Restricted band	15.247(d)/15.205	Pass	William Wang
Radiated Emissions	15.247(d)/15.209	Pass	William Wang

Note: The measurement uncertainty is not included in the test result.
N/A means not applicable

3. SUMMARY

3.1. Client Information

Applicant:	Lenbrook Industries Limited
Address:	633 Granite Court, Pickering, Ontario L1W 3K1, Canada
Manufacturer:	Wata Electronics Co., Ltd.
Address:	No 142, South Tanshen Road, Tanzhou Town, Zhongshan City, Guangdong, China

3.2. Product Description

Name of EUT:	Bluetooth Headphone
Trade Mark:	NAD
Model No.:	HP70
Listed Model(s):	-
Power supply:	AC 120V/60Hz
Adapter information:	-
Hardware version:	VM1.0
Software version:	V0226
Bluetooth	
Version:	Supported BT4.1+EDR
Modulation:	GFSK, $\pi/4$ DQPSK, 8DPSK
Operation frequency:	2402MHz~2480MHz
Channel number:	79
Channel separation:	1MHz
Antenna type:	Internal Antenna
Antenna gain:	2.80 dBi

3.3. Operation state

➤ Test frequency list

According to section 15.31(m), regards to the operating frequency range over 10 MHz, must select three channel which were tested. the Lowest frequency, the middle frequency, and the highest frequency of channel were selected to perform the test, please see the above gray bottom.

Channel	Frequency (MHz)
00	2402
01	2403
⋮	⋮
39	2441
⋮	⋮
77	2479
78	2480

➤ TEST MODE

For RF test items:
The engineering test program was provided and enabled to make EUT continuous transmit
For AC power line conducted emissions:
The EUT was set to connect with the Bluetooth instrument under large package sizes transmission.
For Radiated suprious emissions test item:
The EUT in each of three orthogonal axis emissions had been tested ,but only the worst case (X axis) data recorded in the report.

3.4. EUT configuration

The following peripheral devices and interface cables were connected during the measurement:

- - supplied by the manufacturer
- - supplied by the lab

○	PC	Manufacturer:	TOSHIBA
		Model No.:	Satellite M800
	/	Manufacturer:	/
		Model No.:	/

3.5. Modifications

No modifications were implemented to meet testing criteria.

4. TEST ENVIRONMENT

4.1. Address of the test laboratory

Laboratory: Shenzhen Huatongwei International Inspection Co., Ltd.

Address: 1/F, Bldg 3, Hongfa Hi-tech Industrial Park, Genyu Road, Tianliao, Gongming, Shenzhen, China

4.2. Test Facility

CNAS-Lab Code: L1225

Shenzhen Huatongwei International Inspection Co., Ltd. has been assessed and proved to be in compliance with CNAS-CL01 Accreditation Criteria for Testing and Calibration Laboratories (identical to ISO/IEC17025: 2005 General Requirements) for the Competence of Testing and Calibration Laboratories.

A2LA-Lab Cert. No.: 3902.01

Shenzhen Huatongwei International Inspection Co., Ltd. EMC Laboratory has been accredited by A2LA for technical competence in the field of electrical testing, and proved to be in compliance with ISO/IEC 17025: 2005 General Requirements for the Competence of Testing and Calibration Laboratories and any additional program requirements in the identified field of testing.

FCC-Registration No.: 762235

Shenzhen Huatongwei International Inspection Co., Ltd. EMC Laboratory has been registered and fully described in a report filed with the FCC (Federal Communications Commission). The acceptance letter from the FCC is maintained in our files.

IC-Registration No.:5377B-1

Two 3m Alternate Test Site of Shenzhen Huatongwei International Inspection Co., Ltd. has been registered by Certification and Engineering Bureau of Industry Canada for the performance of radiated measurements with Registration No.: 5377B-1.

ACA

Shenzhen Huatongwei International Inspection Co., Ltd. EMC Laboratory can also perform testing for the Australian C-Tick mark as a result of our A2LA accreditation.

4.3. Environmental conditions

During the measurement the environmental conditions were within the listed ranges:

Temperature:	15~35°C
Relative Humidity:	30~60 %
Air Pressure:	950~1050mba

4.4. Statement of the measurement uncertainty

The data and results referenced in this document are true and accurate. The reader is cautioned that there may be errors in calibration limits of the equipment and facilities. The measurement uncertainty was calculated for all measurements listed in this test report according to TR-100028-01 "Electromagnetic compatibility and Radio spectrum Matters (ERM); Uncertainties in the measurement of mobile radio equipment characteristics; Part 1" and TR-100028-02 "Electromagnetic compatibility and Radio spectrum Matters (ERM); Uncertainties in the measurement of mobile radio equipment characteristics; Part 2" and is documented in the Shenzhen Huatongwei International Inspection Co., Ltd. quality system according to ISO/IEC 17025. Furthermore, component and process variability of devices similar to that tested may result in additional deviation. The manufacturer has the sole responsibility of continued compliance of the device.

Here after the best measurement capability for Shenzhen Huatongwei International Inspection Co., Ltd. is reported:

Test Items	Measurement Uncertainty	Notes
Transmitter power conducted	0.57 dB	(1)
Transmitter power Radiated	2.20 dB	(1)
Conducted spurious emissions 9kHz~40GHz	1.60 dB	(1)
Radiated spurious emissions 9kHz~40GHz	2.20 dB	(1)
Conducted Emissions 9kHz~30MHz	3.39 dB	(1)
Radiated Emissions 30~1000MHz	4.24 dB	(1)
Radiated Emissions 1~18GHz	5.16 dB	(1)
Radiated Emissions 18~40GHz	5.54 dB	(1)
Occupied Bandwidth	-----	(1)

(1) This uncertainty represents an expanded uncertainty expressed at approximately the 95% confidence level using a coverage factor of k=1.96.

4.5. Equipments Used during the Test

Conducted Emissions					
Item	Test Equipment	Manufacturer	Model No.	Serial No.	Last Cal.
1	Artificial Mains	Rohde&Schwarz	ESH2-Z5	100028	2016/11/13
2	EMI Test Receiver	Rohde&Schwarz	ESCI3	100038	2016/11/13
3	Pulse Limiter	Rohde&Schwarz	ESHSZ2	100044	2016/11/13
4	EMI Test Software	Rohde&Schwarz	ES-K1 V1.71	-	-

Radiated Emissions					
Item	Test Equipment	Manufacturer	Model No.	Serial No.	Last Cal.
1	EMI test receiver	Rohde&Schwarz	ESI 26	100009	2016/11/13
2	Loop Antenna	Rohde&Schwarz	HFH2-Z2	100020	2016/11/13
3	Ultra-Broadband Antenna	ShwarzBeck	VULB9163	538	2016/11/13
4	Horn antenna	ShwarzBeck	9120D	1011	2016/11/13
5	Horn Antenna	SCHWARZBECK	BBHA9170	25841	2016/11/13
6	Amplifier	Sonoma	310N	E009-13	2016/11/13
7	JS Amplifier	Rohde&Schwarz	JS4-00101800-28-5A	F201504	2016/11/13
8	Amplifier	Compliance Direction systems	PAP1-4060	120	2016/11/13
9	High pass filter	Compliance Direction systems	BSU-6	34202	2016/11/13
10	EMI test Software	Rohde&Schwarz	ESK1	-	-
11	EMI test Software	Audix	E3	-	-
12	TURNTABLE	MATURO	TT2.0	-	-
13	ANTENNA MAST	MATURO	TAM-4.0-P	-	-

RF Conducted methods					
Item	Test Equipment	Manufacturer	Model No.	Serial No.	Last Cal.
1	Spectrum Analyzer	Rohde&Schwarz	FSP	1164.4391.40	2016/11/13
2	MXA Signal Analyzer	Agilent Technologies	N9020A	MY5050187	2016/11/13

The Cal.Interval was one year.

5. TEST CONDITIONS AND RESULTS

5.1. Antenna requirement

Requirement

FCC CFR Title 47 Part 15 Subpart C Section 15.203:

An intentional radiator shall be designed to ensure that no antenna other than that furnished by the responsible party shall be used with the device. The use of a permanently attached antenna or of an antenna that uses a unique coupling to the intentional radiator, the manufacturer may design the unit so that a broken antenna can be replaced by the user, but the use of a standard antenna jack or electrical connector is prohibited.

FCC CFR Title 47 Part 15 Subpart C Section 15.247(c) (1)(i):

(i) Systems operating in the 2400~2483.5 MHz band that is used exclusively for fixed. Point-to-point operations may employ transmitting antennas with directional gain greater than 6 dBi provided the maximum conducted output power of the intentional radiator is reduced by 1 dB for every 3 dB that the directional gain of the antenna exceeds 6 dBi.

Test Result:

Passed **Not Applicable**

The directional gain of the antenna less than 6 dBi, please refer to the below antenna photo.

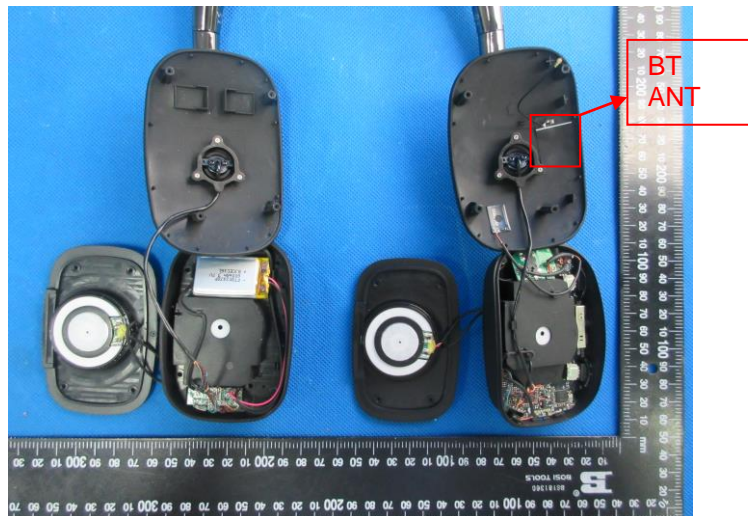

5.2. Conducted Emissions (AC Main)

LIMIT

FCC CFR Title 47 Part 15 Subpart C Section 15.207

Frequency range (MHz)	Limit (dBuV)	
	Quasi-peak	Average
0.15-0.5	66 to 56*	56 to 46*
0.5-5	56	46
5-30	60	50

* Decreases with the logarithm of the frequency.

TEST CONFIGURATION

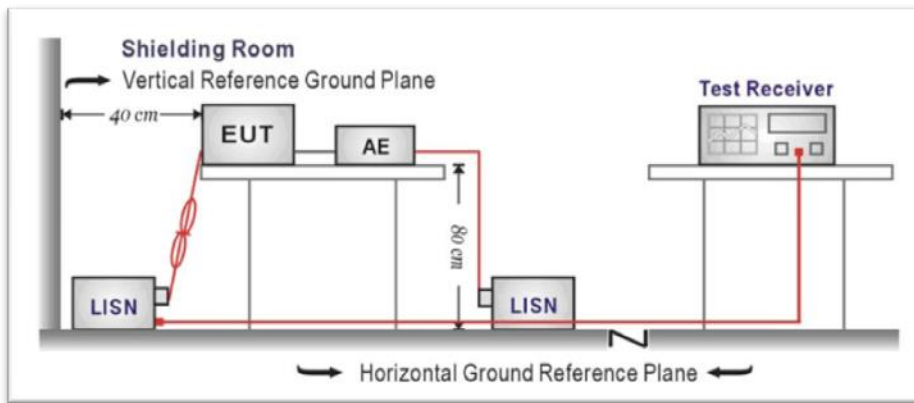

TEST PROCEDURE

1. The EUT was setup according to ANSI C63.10:2013 requirements.
2. The EUT was placed on a platform of nominal size, 1 m by 1.5 m, raised 80 cm above the conducting ground plane. The vertical conducting plane was located 40 cm to the rear of the EUT. All other surfaces of EUT were at least 80 cm from any other grounded conducting surface.
3. The EUT and simulators are connected to the main power through a line impedances stabilization network (LISN). The LISN provides a 50 ohm /50uH coupling impedance for the measuring equipment.
4. The peripheral devices are also connected to the main power through a LISN. (Please refer to the block diagram of the test setup and photographs)
5. Each current-carrying conductor of the EUT power cord, except the ground (safety) conductor, was individually connected through a LISN to the input power source.
6. The excess length of the power cord between the EUT and the LISN receptacle were folded back and forth at the center of the lead to form a bundle not exceeding 40 cm in length.
7. Conducted emissions were investigated over the frequency range from 0.15MHz to 30MHz using a receiver bandwidth of 9 kHz.
8. During the above scans, the emissions were maximized by cable manipulation.

TEST RESULTS

Passed Not Applicable

5.3. Conducted Peak Output Power

LIMIT

FCC CFR Title 47 Part 15 Subpart C Section 15.247 (b)(1): For frequency hopping systems operating in the 2400-2483.5 MHz band employing at least 75 non-overlapping hopping channels, and all frequency hopping systems in the 5725-5850 MHz band: 1 watt. For all other frequency hopping systems in the 2400-2483.5 MHz band: 0.125 watts.

TEST CONFIGURATION

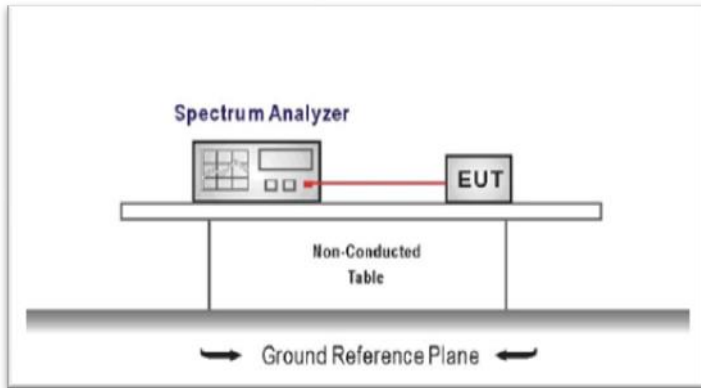

TEST PROCEDURE

1. The transmitter output was connected to the spectrum analyzer through an attenuator, the pathloss was compensated to the results for each measurement.
2. Set to the maximum power setting and enable the EUT transmit continuously
3. Use the following spectrum analyzer settings:
 Span = approximately 5 times the 20 dB bandwidth, centered on a hopping channel
 RBW ≥ the 20 dB bandwidth of the emission being measured, VBW ≥ RBW
 Sweep = auto, Detector function = peak, Trace = max hold
4. Measure and record the results in the test report.



TEST MODE:

Please refer to the clause 3.3

TEST RESULTS

Passed Not Applicable

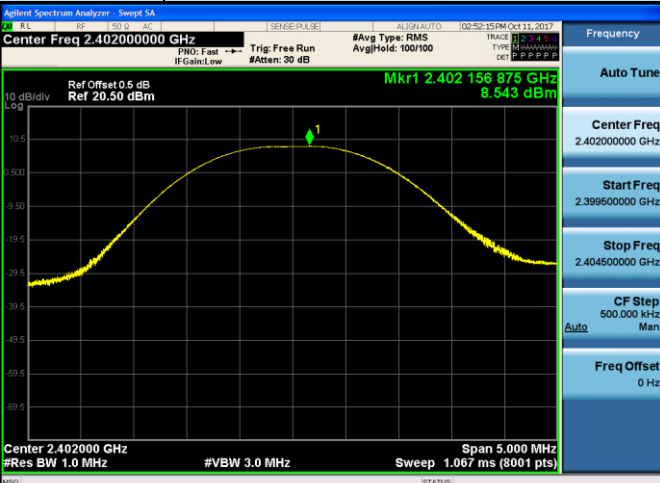
Modulation type	Channel	Output power (dBm)	Limit (dBm)	Result
GFSK	00	8.543	≤ 30.00	Pass
	39	8.841		
	78	8.781		
π/4DQPSK	00	6.977	≤ 21.00	Pass
	39	7.460		
	78	7.532		
8DPSK	00	7.277	≤ 21.00	Pass
	39	7.793		
	78	7.783		

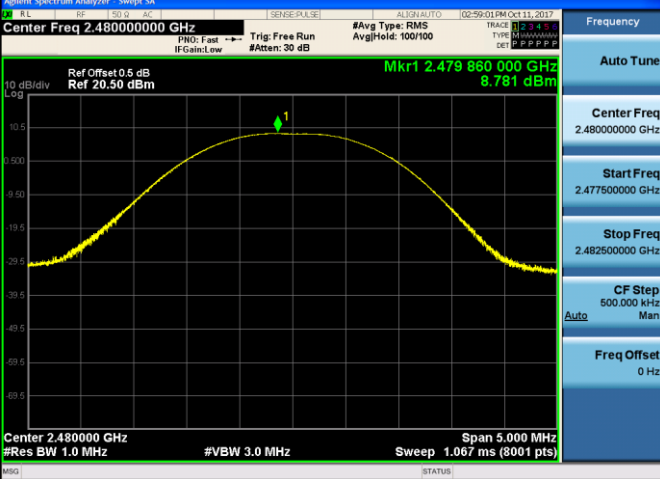
Modulation Type:		GFSK	
CH00		<p>Agilent Spectrum Analyzer - Sweep SA</p> <p>Center Freq 2.40200000 GHz</p> <p>Mkr1 2.402 156 875 GHz 8.543 dBm</p> <p>Center Freq 2.40200000 GHz</p> <p>Start Freq 2.399500000 GHz</p> <p>Stop Freq 2.404500000 GHz</p> <p>CF Step 500.000 kHz</p> <p>Freq Offset 0 Hz</p>	
CH39		<p>Agilent Spectrum Analyzer - Sweep SA</p> <p>Center Freq 2.44100000 GHz</p> <p>Mkr1 2.440 810 625 GHz 8.841 dBm</p> <p>Center Freq 2.44100000 GHz</p> <p>Start Freq 2.438500000 GHz</p> <p>Stop Freq 2.443500000 GHz</p> <p>CF Step 500.000 kHz</p> <p>Freq Offset 0 Hz</p>	
CH78		<p>Agilent Spectrum Analyzer - Sweep SA</p> <p>Center Freq 2.48000000 GHz</p> <p>Mkr1 2.479 860 000 GHz 8.781 dBm</p> <p>Center Freq 2.48000000 GHz</p> <p>Start Freq 2.477500000 GHz</p> <p>Stop Freq 2.482500000 GHz</p> <p>CF Step 500.000 kHz</p> <p>Freq Offset 0 Hz</p>	

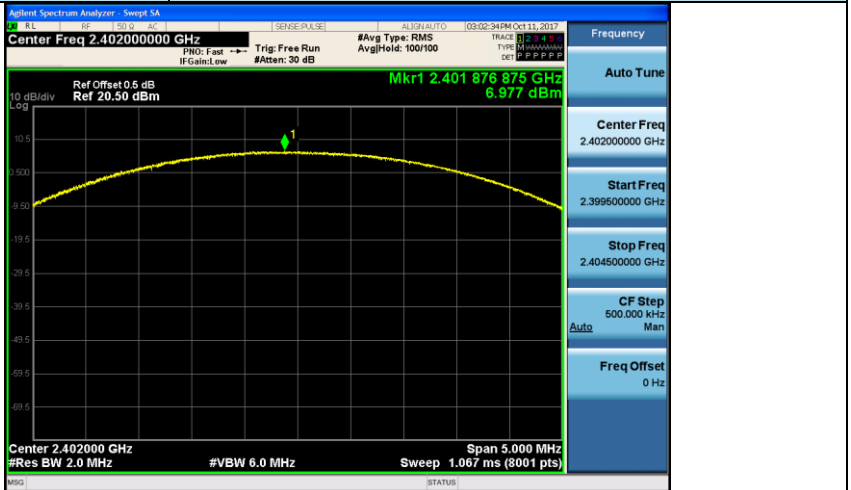
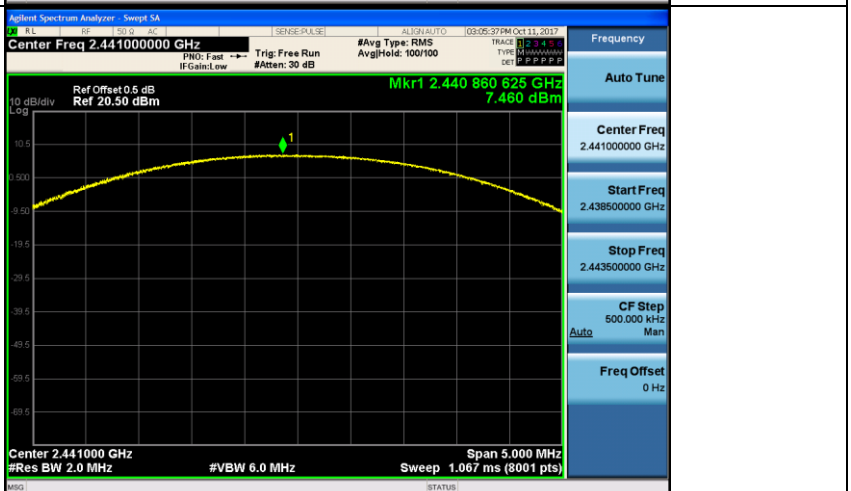
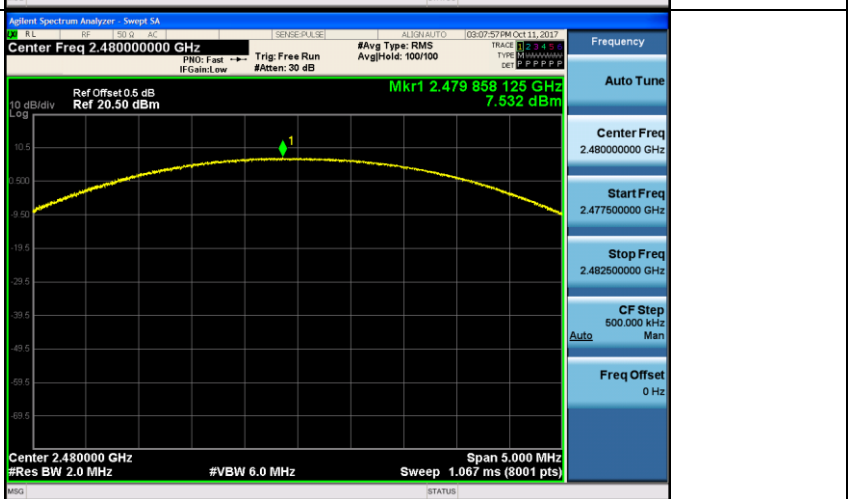
Modulation Type:		$\pi/4$ DQPSK
CH00		
CH39		
CH78		

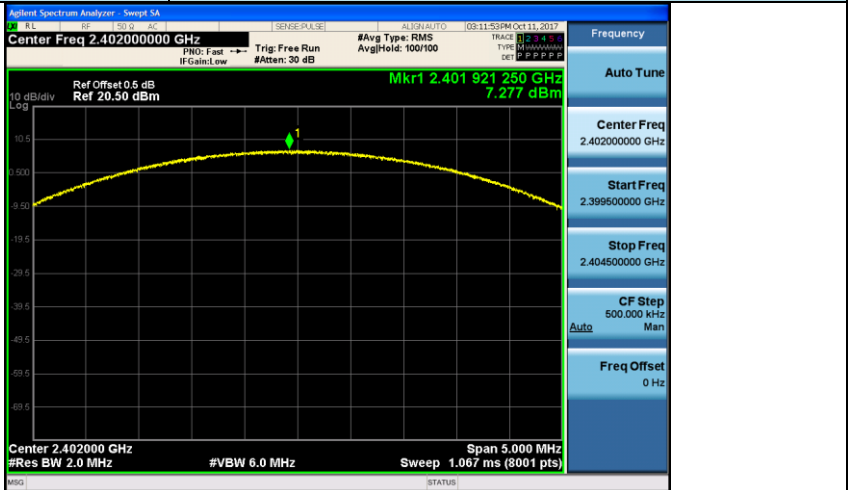
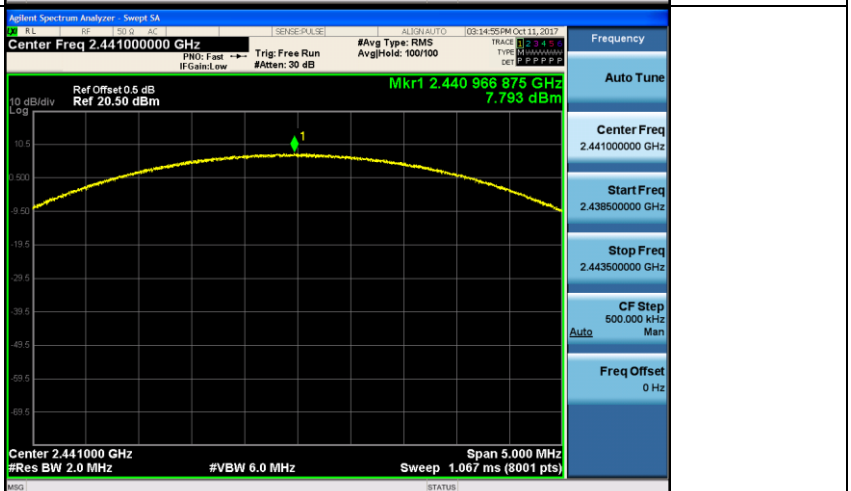
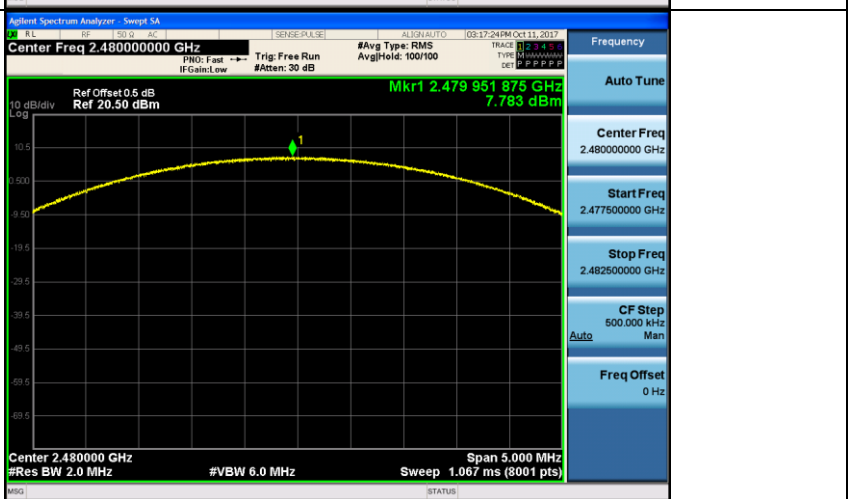
Modulation Type:		8DPSK
CH00		
CH39		
CH78		

5.4. 20 dB Bandwidth

LIMIT

N/A

TEST CONFIGURATION

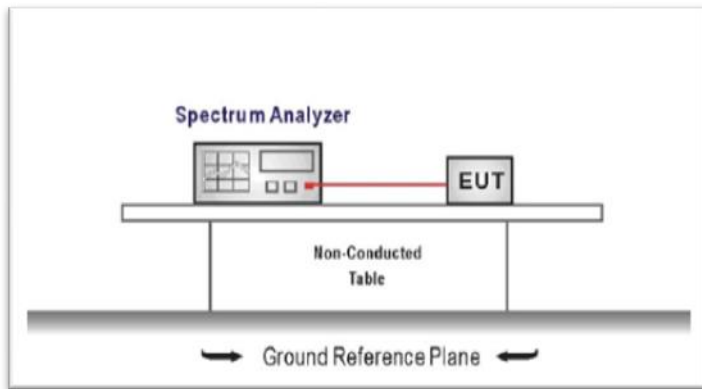

TEST PROCEDURE

1. The transmitter output was connected to the spectrum analyzer through an attenuator, the path loss was compensated to the results for each measurement.
2. Set to the maximum power setting and enable the EUT transmit continuously
3. Use the following spectrum analyzer settings:
Span = approximately 2 to 3 times the 20 dB bandwidth, centered on a hopping channel
RBW \geq 1% of the 20 dB bandwidth, VBW \geq RBW
Sweep = auto, Detector function = peak, Trace = max hold
4. Measure and record the results in the test report.

TEST MODE:

Please refer to the clause 3.3

TEST RESULTS

 Passed Not Applicable

Modulation type	Channel	20 dB Bandwidth (MHz)	Limit (MHz)	Result
GFSK	00	0.9213	-	Pass
	39	0.9279		
	78	0.9240		
$\pi/4$ DQPSK	00	1.231	-	Pass
	39	1.231		
	78	1.231		
8DPSK	00	1.263	-	Pass
	39	1.261		
	78	1.263		

Modulation Type:		GFSK	
CH00		<p>Frequency</p> <p>Center Freq 2.402000000 GHz</p> <p>CF Step 200.000 kHz</p> <p>Freq Offset 0 Hz</p>	
CH39		<p>Frequency</p> <p>Center Freq 2.441000000 GHz</p> <p>CF Step 200.000 kHz</p> <p>Freq Offset 0 Hz</p>	
CH78		<p>Frequency</p> <p>Center Freq 2.480000000 GHz</p> <p>CF Step 200.000 kHz</p> <p>Freq Offset 0 Hz</p>	

Modulation Type:		$\pi/4$ DQPSK
CH00	<p>Agilent Spectrum Analyzer - Occupied BW</p> <p>Center Freq 2.40200000 GHz</p> <p>Center 2.402 GHz #Res BW 30 kHz</p> <p>Occupied Bandwidth 1.1630 MHz</p> <p>Total Power 13.0 dBm</p> <p>Transmit Freq Error -20.111 kHz</p> <p>x dB Bandwidth 1.231 MHz</p>	<p>Frequency</p> <p>Center Freq 2.40200000 GHz</p> <p>CF Step 250.000 kHz</p> <p>Freq Offset 0 Hz</p>
CH39	<p>Agilent Spectrum Analyzer - Occupied BW</p> <p>Center Freq 2.441000000 GHz</p> <p>Center 2.441 GHz #Res BW 30 kHz</p> <p>Occupied Bandwidth 1.1640 MHz</p> <p>Total Power 13.6 dBm</p> <p>Transmit Freq Error -21.615 kHz</p> <p>x dB Bandwidth 1.231 MHz</p>	<p>Frequency</p> <p>Center Freq 2.441000000 GHz</p> <p>CF Step 250.000 kHz</p> <p>Freq Offset 0 Hz</p>
CH78	<p>Agilent Spectrum Analyzer - Occupied BW</p> <p>Center Freq 2.480000000 GHz</p> <p>Center 2.48 GHz #Res BW 30 kHz</p> <p>Occupied Bandwidth 1.1633 MHz</p> <p>Total Power 13.6 dBm</p> <p>Transmit Freq Error -20.578 kHz</p> <p>x dB Bandwidth 1.231 MHz</p>	<p>Frequency</p> <p>Center Freq 2.480000000 GHz</p> <p>CF Step 250.000 kHz</p> <p>Freq Offset 0 Hz</p>

Modulation Type:		8DPSK
CH00	<p>Agilent Spectrum Analyzer - Occupied BW</p> <p>Center Freq 2.40200000 GHz</p> <p>Center Freq: 2.40200000 GHz</p> <p>Occupied Bandwidth 1.1556 MHz</p> <p>Total Power 13.6 dBm</p> <p>Transmit Freq Error -16.497 kHz</p> <p>OBW Power 99.00 %</p>	<p>Frequency</p> <p>Center Freq 2.40200000 GHz</p> <p>CF Step 250.000 kHz</p> <p>Freq Offset 0 Hz</p>
CH39	<p>Agilent Spectrum Analyzer - Occupied BW</p> <p>Center Freq 2.44100000 GHz</p> <p>Center Freq: 2.44100000 GHz</p> <p>Occupied Bandwidth 1.1557 MHz</p> <p>Total Power 14.2 dBm</p> <p>Transmit Freq Error -17.338 kHz</p> <p>OBW Power 99.00 %</p>	<p>Frequency</p> <p>Center Freq 2.44100000 GHz</p> <p>CF Step 250.000 kHz</p> <p>Freq Offset 0 Hz</p>
CH78	<p>Agilent Spectrum Analyzer - Occupied BW</p> <p>Center Freq 2.48000000 GHz</p> <p>Center Freq: 2.48000000 GHz</p> <p>Occupied Bandwidth 1.1562 MHz</p> <p>Total Power 14.3 dBm</p> <p>Transmit Freq Error -15.864 kHz</p> <p>OBW Power 99.00 %</p>	<p>Frequency</p> <p>Center Freq 2.48000000 GHz</p> <p>CF Step 250.000 kHz</p> <p>Freq Offset 0 Hz</p>

5.5. Carrier Frequencies Separation

LIMIT

FCC CFR Title 47 Part 15 Subpart C Section 15.247 (a)(1):Frequency hopping systems shall have hopping channel carrier frequencies separated by minimum of 25 kHz or the 2/3*20 dB bandwidth of the hopping channel, whichever is greater.

TEST CONFIGURATION

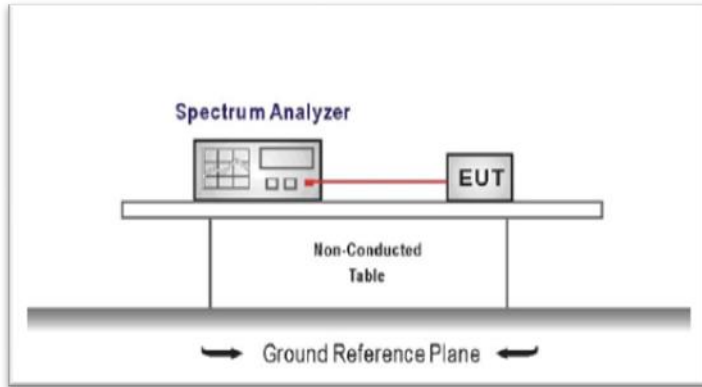

TEST PROCEDURE

1. The transmitter output was connected to the spectrum analyzer through an attenuator, the path loss was compensated to the results for each measurement.
2. Set to the maximum power setting and enable the EUT transmit continuously
3. Use the following spectrum analyzer settings:
 Span = wide enough to capture the peaks of two adjacent channels
 RBW ≥ 1% of the span, VBW ≥ RBW
 Sweep = auto, Detector function = peak, Trace = max hold
4. Measure and record the results in the test report.

TEST MODE:

Please refer to the clause 3.3



TEST RESULTS

Passed Not Applicable

Modulation type	Channel	Carrier Frequencies Separation (MHz)	Limit (MHz) *	Result
GFSK	39	0.981	≥0.924	Pass
π/4DQPSK	39	1.006	≥0.821	Pass
8DPSK	39	1.009	≥0.842	Pass

Note:

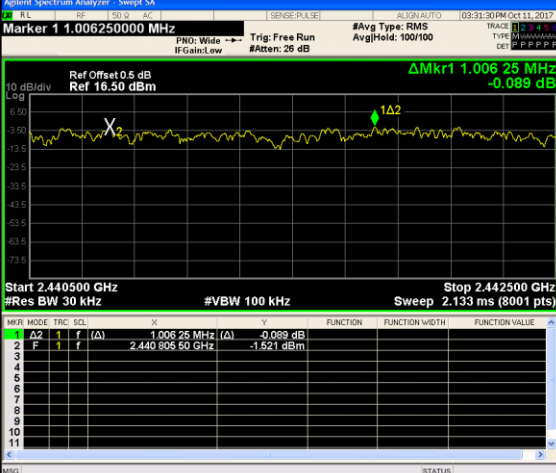
- *: GFSK limit = The maximum 20 dB Bandwidth for GFSK modulation on the section 5.4.
- π/4DQPSK limit = 2/3 * The maximum 20 dB Bandwidth for π/4DQPSK modulation on the section 5.4.
- 8DPSK limit = 2/3 * The maximum 20 dB Bandwidth for 8DPSK modulation on the section 5.4

<p>GFSK</p>	 <table border="1" data-bbox="678 504 1236 660"> <thead> <tr> <th>MKR MODE</th> <th>TRC</th> <th>SCL</th> <th>X</th> <th>Y</th> <th>FUNCTION</th> <th>FUNCTION WIDTH</th> <th>FUNCTION VALUE</th> </tr> </thead> <tbody> <tr> <td>1</td> <td>Δ2</td> <td>f</td> <td>980.75 kHz (Δ)</td> <td>0.368 dB</td> <td></td> <td></td> <td></td> </tr> <tr> <td>2</td> <td>F</td> <td>f</td> <td>2.440 998 50 GHz</td> <td>5.964 dBm</td> <td></td> <td></td> <td></td> </tr> </tbody> </table>	MKR MODE	TRC	SCL	X	Y	FUNCTION	FUNCTION WIDTH	FUNCTION VALUE	1	Δ2	f	980.75 kHz (Δ)	0.368 dB				2	F	f	2.440 998 50 GHz	5.964 dBm				<p>Peak Search</p> <p>Next Peak</p> <p>Next Pk Right</p> <p>Next Pk Left</p> <p>Marker Delta</p> <p>Mkr--CF</p> <p>Mkr--Ref Lvl</p> <p>More 1 of 2</p>
MKR MODE	TRC	SCL	X	Y	FUNCTION	FUNCTION WIDTH	FUNCTION VALUE																			
1	Δ2	f	980.75 kHz (Δ)	0.368 dB																						
2	F	f	2.440 998 50 GHz	5.964 dBm																						
<p>$\pi/4$DQPSK</p>	 <table border="1" data-bbox="678 996 1236 1153"> <thead> <tr> <th>MKR MODE</th> <th>TRC</th> <th>SCL</th> <th>X</th> <th>Y</th> <th>FUNCTION</th> <th>FUNCTION WIDTH</th> <th>FUNCTION VALUE</th> </tr> </thead> <tbody> <tr> <td>1</td> <td>Δ2</td> <td>f</td> <td>1.006 25 MHz (Δ)</td> <td>-0.089 dB</td> <td></td> <td></td> <td></td> </tr> <tr> <td>2</td> <td>F</td> <td>f</td> <td>2.440 998 50 GHz</td> <td>-1.621 dBm</td> <td></td> <td></td> <td></td> </tr> </tbody> </table>	MKR MODE	TRC	SCL	X	Y	FUNCTION	FUNCTION WIDTH	FUNCTION VALUE	1	Δ2	f	1.006 25 MHz (Δ)	-0.089 dB				2	F	f	2.440 998 50 GHz	-1.621 dBm				<p>Peak Search</p> <p>Next Peak</p> <p>Next Pk Right</p> <p>Next Pk Left</p> <p>Marker Delta</p> <p>Mkr--CF</p> <p>Mkr--Ref Lvl</p> <p>More 1 of 2</p>
MKR MODE	TRC	SCL	X	Y	FUNCTION	FUNCTION WIDTH	FUNCTION VALUE																			
1	Δ2	f	1.006 25 MHz (Δ)	-0.089 dB																						
2	F	f	2.440 998 50 GHz	-1.621 dBm																						
<p>8DPSK</p>	 <table border="1" data-bbox="678 1489 1236 1646"> <thead> <tr> <th>MKR MODE</th> <th>TRC</th> <th>SCL</th> <th>X</th> <th>Y</th> <th>FUNCTION</th> <th>FUNCTION WIDTH</th> <th>FUNCTION VALUE</th> </tr> </thead> <tbody> <tr> <td>1</td> <td>Δ2</td> <td>f</td> <td>1.008 50 MHz (Δ)</td> <td>-0.717 dB</td> <td></td> <td></td> <td></td> </tr> <tr> <td>2</td> <td>F</td> <td>f</td> <td>2.440 998 75 GHz</td> <td>5.217 dBm</td> <td></td> <td></td> <td></td> </tr> </tbody> </table>	MKR MODE	TRC	SCL	X	Y	FUNCTION	FUNCTION WIDTH	FUNCTION VALUE	1	Δ2	f	1.008 50 MHz (Δ)	-0.717 dB				2	F	f	2.440 998 75 GHz	5.217 dBm				<p>Peak Search</p> <p>Next Peak</p> <p>Next Pk Right</p> <p>Next Pk Left</p> <p>Marker Delta</p> <p>Mkr--CF</p> <p>Mkr--Ref Lvl</p> <p>More 1 of 2</p>
MKR MODE	TRC	SCL	X	Y	FUNCTION	FUNCTION WIDTH	FUNCTION VALUE																			
1	Δ2	f	1.008 50 MHz (Δ)	-0.717 dB																						
2	F	f	2.440 998 75 GHz	5.217 dBm																						

5.6. Hopping Channel Number

LIMIT

FCC CFR Title 47 Part 15 Subpart C Section 15.247 (a)(1):Frequency hopping systems in the 2400–2483.5 MHz band shall use at least **15** channels.

TEST CONFIGURATION

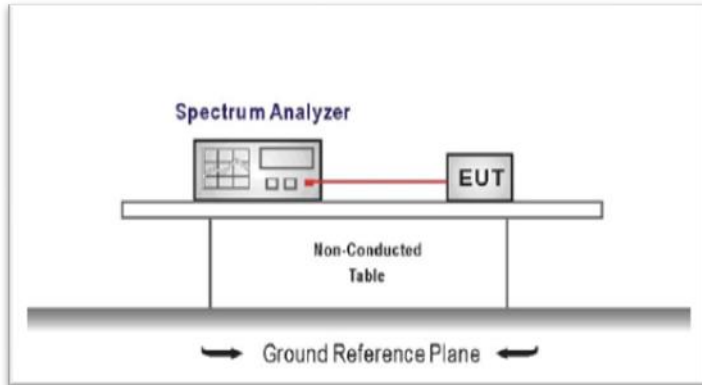

TEST PROCEDURE

1. The transmitter output was connected to the spectrum analyzer through an attenuator, the path loss was compensated to the results for each measurement.
2. Set to the maximum power setting and enable the EUT transmit continuously
3. Use the following spectrum analyzer settings:
 Span = the frequency band of operation
 RBW \geq 1% of the span, VBW \geq RBW
 Sweep = auto, Detector function = peak, Trace = max hold
4. Measure and record the results in the test report.

TEST MODE:

Please refer to the clause 3.3

TEST RESULTS

Passed Not Applicable

Modulation type	Channel number	Limit	Result
GFSK	79	≥ 15.00	Pass
$\pi/4$ DQPSK	79		
8DPSK	79		

<p>GFSK</p>	 <table border="1"><thead><tr><th>MKR MODE</th><th>TRC</th><th>SCL</th><th>X</th><th>Y</th><th>FUNCTION</th><th>FUNCTION WIDTH</th><th>FUNCTION VALUE</th></tr></thead><tbody><tr><td>1</td><td>Δ2</td><td>f</td><td>77.719 MHz (Δ)</td><td>0.290 dB</td><td></td><td></td><td></td></tr><tr><td>2</td><td>F</td><td>f</td><td>2.402230 GHz</td><td>8.342 dBm</td><td></td><td></td><td></td></tr></tbody></table>	MKR MODE	TRC	SCL	X	Y	FUNCTION	FUNCTION WIDTH	FUNCTION VALUE	1	Δ2	f	77.719 MHz (Δ)	0.290 dB				2	F	f	2.402230 GHz	8.342 dBm				<p>Peak Search</p> <p>Next Peak</p> <p>Next Pk Right</p> <p>Next Pk Left</p> <p>Marker Delta</p> <p>Mkr--CF</p> <p>Mkr--Ref Lvl</p> <p>More 1 of 2</p>
MKR MODE	TRC	SCL	X	Y	FUNCTION	FUNCTION WIDTH	FUNCTION VALUE																			
1	Δ2	f	77.719 MHz (Δ)	0.290 dB																						
2	F	f	2.402230 GHz	8.342 dBm																						
<p>π/4DQPSK</p>	 <table border="1"><thead><tr><th>MKR MODE</th><th>TRC</th><th>SCL</th><th>X</th><th>Y</th><th>FUNCTION</th><th>FUNCTION WIDTH</th><th>FUNCTION VALUE</th></tr></thead><tbody><tr><td>1</td><td>Δ2</td><td>f</td><td>78.049 MHz (Δ)</td><td>0.407 dB</td><td></td><td></td><td></td></tr><tr><td>2</td><td>F</td><td>f</td><td>2.401980 GHz</td><td>6.461 dBm</td><td></td><td></td><td></td></tr></tbody></table>	MKR MODE	TRC	SCL	X	Y	FUNCTION	FUNCTION WIDTH	FUNCTION VALUE	1	Δ2	f	78.049 MHz (Δ)	0.407 dB				2	F	f	2.401980 GHz	6.461 dBm				<p>Peak Search</p> <p>Next Peak</p> <p>Next Pk Right</p> <p>Next Pk Left</p> <p>Marker Delta</p> <p>Mkr--CF</p> <p>Mkr--Ref Lvl</p> <p>More 1 of 2</p>
MKR MODE	TRC	SCL	X	Y	FUNCTION	FUNCTION WIDTH	FUNCTION VALUE																			
1	Δ2	f	78.049 MHz (Δ)	0.407 dB																						
2	F	f	2.401980 GHz	6.461 dBm																						
<p>8DPSK</p>	 <table border="1"><thead><tr><th>MKR MODE</th><th>TRC</th><th>SCL</th><th>X</th><th>Y</th><th>FUNCTION</th><th>FUNCTION WIDTH</th><th>FUNCTION VALUE</th></tr></thead><tbody><tr><td>1</td><td>Δ2</td><td>f</td><td>77.849 MHz (Δ)</td><td>0.555 dB</td><td></td><td></td><td></td></tr><tr><td>2</td><td>F</td><td>f</td><td>2.402110 GHz</td><td>6.557 dBm</td><td></td><td></td><td></td></tr></tbody></table>	MKR MODE	TRC	SCL	X	Y	FUNCTION	FUNCTION WIDTH	FUNCTION VALUE	1	Δ2	f	77.849 MHz (Δ)	0.555 dB				2	F	f	2.402110 GHz	6.557 dBm				<p>Peak Search</p> <p>Next Peak</p> <p>Next Pk Right</p> <p>Next Pk Left</p> <p>Marker Delta</p> <p>Mkr--CF</p> <p>Mkr--Ref Lvl</p> <p>More 1 of 2</p>
MKR MODE	TRC	SCL	X	Y	FUNCTION	FUNCTION WIDTH	FUNCTION VALUE																			
1	Δ2	f	77.849 MHz (Δ)	0.555 dB																						
2	F	f	2.402110 GHz	6.557 dBm																						

5.7. Dwell Time

LIMIT

FCC CFR Title 47 Part 15 Subpart C Section 15.247 (a)(1):The average time of occupancy on any channel shall not be greater than 0.4 seconds within a pe-riod of 0.4 seconds multiplied by the number of hopping channels employed.

TEST CONFIGURATION

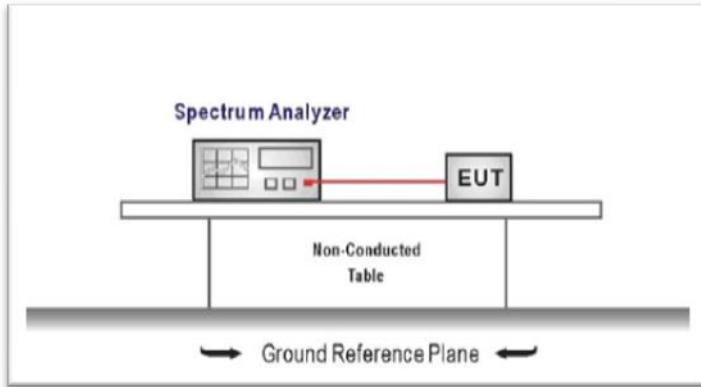

TEST PROCEDURE

1. The transmitter output was connected to the spectrum analyzer through an attenuator, the path loss was compensated to the results for each measurement.
2. Set to the maximum power setting and enable the EUT transmit continuously
3. Use the following spectrum analyzer settings:
 Span = zero span, centered on a hopping channel, RBW= 1 MHz, VBW ≥ RBW
 Sweep = as necessary to capture the entire dwell time per hopping channel,
 Detector function = peak, Trace = max hold
4. Measure and record the results in the test report.

TEST MODE:

Please refer to the clause 3.3

TEST RESULTS

Passed Not Applicable

Modulation type	Channel	Dwell time (Second)	Limit (Second)	Result
GFSK	DH1	0.128	≤ 0.40	Pass
	DH3	0.266		
	DH5	0.309		
π/4DQPSK	2DH1	0.131	≤ 0.40	Pass
	2DH3	0.266		
	2DH5	0.310		
8DPSK	3DH1	0.131	≤ 0.40	Pass
	3DH3	0.266		
	3DH5	0.310		

Note:

1. We have tested all mode at high,middle and low channel,and recoreded worst case at middle channel.
2. Dwell time=Pulse time (ms) × (1600 ÷ 2 ÷ 79) ×31.6 Second for DH1, 2DH1, 3DH1
 Dwell time=Pulse time (ms) × (1600 ÷ 4 ÷ 79) ×31.6 Second for DH3, 2DH3, 3DH3
 Dwell time=Pulse time (ms) × (1600 ÷ 6 ÷ 79) ×31.6 Second for DH5, 2DH5, 3DH5

Modulation Type:		GFSK																			
DH1			<table border="1"><tr><td>Frequency</td><td></td></tr><tr><td>Auto Tune</td><td></td></tr><tr><td>Center Freq</td><td>2.441000000 GHz</td></tr><tr><td>Start Freq</td><td>2.441000000 GHz</td></tr><tr><td>Stop Freq</td><td>2.441000000 GHz</td></tr><tr><td>CF Step</td><td>1.000000 MHz</td></tr><tr><td>Man</td><td></td></tr><tr><td>Auto</td><td></td></tr><tr><td>Freq Offset</td><td>0 Hz</td></tr></table>	Frequency		Auto Tune		Center Freq	2.441000000 GHz	Start Freq	2.441000000 GHz	Stop Freq	2.441000000 GHz	CF Step	1.000000 MHz	Man		Auto		Freq Offset	0 Hz
Frequency																					
Auto Tune																					
Center Freq	2.441000000 GHz																				
Start Freq	2.441000000 GHz																				
Stop Freq	2.441000000 GHz																				
CF Step	1.000000 MHz																				
Man																					
Auto																					
Freq Offset	0 Hz																				
DH3			<table border="1"><tr><td>Frequency</td><td></td></tr><tr><td>Auto Tune</td><td></td></tr><tr><td>Center Freq</td><td>2.441000000 GHz</td></tr><tr><td>Start Freq</td><td>2.441000000 GHz</td></tr><tr><td>Stop Freq</td><td>2.441000000 GHz</td></tr><tr><td>CF Step</td><td>1.000000 MHz</td></tr><tr><td>Man</td><td></td></tr><tr><td>Auto</td><td></td></tr><tr><td>Freq Offset</td><td>0 Hz</td></tr></table>	Frequency		Auto Tune		Center Freq	2.441000000 GHz	Start Freq	2.441000000 GHz	Stop Freq	2.441000000 GHz	CF Step	1.000000 MHz	Man		Auto		Freq Offset	0 Hz
Frequency																					
Auto Tune																					
Center Freq	2.441000000 GHz																				
Start Freq	2.441000000 GHz																				
Stop Freq	2.441000000 GHz																				
CF Step	1.000000 MHz																				
Man																					
Auto																					
Freq Offset	0 Hz																				
DH5			<table border="1"><tr><td>Frequency</td><td></td></tr><tr><td>Auto Tune</td><td></td></tr><tr><td>Center Freq</td><td>2.441000000 GHz</td></tr><tr><td>Start Freq</td><td>2.441000000 GHz</td></tr><tr><td>Stop Freq</td><td>2.441000000 GHz</td></tr><tr><td>CF Step</td><td>1.000000 MHz</td></tr><tr><td>Man</td><td></td></tr><tr><td>Auto</td><td></td></tr><tr><td>Freq Offset</td><td>0 Hz</td></tr></table>	Frequency		Auto Tune		Center Freq	2.441000000 GHz	Start Freq	2.441000000 GHz	Stop Freq	2.441000000 GHz	CF Step	1.000000 MHz	Man		Auto		Freq Offset	0 Hz
Frequency																					
Auto Tune																					
Center Freq	2.441000000 GHz																				
Start Freq	2.441000000 GHz																				
Stop Freq	2.441000000 GHz																				
CF Step	1.000000 MHz																				
Man																					
Auto																					
Freq Offset	0 Hz																				

Modulation Type:		$\pi/4$ DQPSK									
2DH1		<table border="1"> <tr><td>Frequency</td></tr> <tr><td>Auto Tune</td></tr> <tr><td>Center Freq 2.441000000 GHz</td></tr> <tr><td>Start Freq 2.441000000 GHz</td></tr> <tr><td>Stop Freq 2.441000000 GHz</td></tr> <tr><td>CF Step 1.000000 MHz</td></tr> <tr><td>Man</td></tr> <tr><td>Auto</td></tr> <tr><td>Freq Offset 0 Hz</td></tr> </table>	Frequency	Auto Tune	Center Freq 2.441000000 GHz	Start Freq 2.441000000 GHz	Stop Freq 2.441000000 GHz	CF Step 1.000000 MHz	Man	Auto	Freq Offset 0 Hz
Frequency											
Auto Tune											
Center Freq 2.441000000 GHz											
Start Freq 2.441000000 GHz											
Stop Freq 2.441000000 GHz											
CF Step 1.000000 MHz											
Man											
Auto											
Freq Offset 0 Hz											
2DH3		<table border="1"> <tr><td>Frequency</td></tr> <tr><td>Auto Tune</td></tr> <tr><td>Center Freq 2.441000000 GHz</td></tr> <tr><td>Start Freq 2.441000000 GHz</td></tr> <tr><td>Stop Freq 2.441000000 GHz</td></tr> <tr><td>CF Step 1.000000 MHz</td></tr> <tr><td>Man</td></tr> <tr><td>Auto</td></tr> <tr><td>Freq Offset 0 Hz</td></tr> </table>	Frequency	Auto Tune	Center Freq 2.441000000 GHz	Start Freq 2.441000000 GHz	Stop Freq 2.441000000 GHz	CF Step 1.000000 MHz	Man	Auto	Freq Offset 0 Hz
Frequency											
Auto Tune											
Center Freq 2.441000000 GHz											
Start Freq 2.441000000 GHz											
Stop Freq 2.441000000 GHz											
CF Step 1.000000 MHz											
Man											
Auto											
Freq Offset 0 Hz											
2DH5		<table border="1"> <tr><td>Frequency</td></tr> <tr><td>Auto Tune</td></tr> <tr><td>Center Freq 2.441000000 GHz</td></tr> <tr><td>Start Freq 2.441000000 GHz</td></tr> <tr><td>Stop Freq 2.441000000 GHz</td></tr> <tr><td>CF Step 1.000000 MHz</td></tr> <tr><td>Man</td></tr> <tr><td>Auto</td></tr> <tr><td>Freq Offset 0 Hz</td></tr> </table>	Frequency	Auto Tune	Center Freq 2.441000000 GHz	Start Freq 2.441000000 GHz	Stop Freq 2.441000000 GHz	CF Step 1.000000 MHz	Man	Auto	Freq Offset 0 Hz
Frequency											
Auto Tune											
Center Freq 2.441000000 GHz											
Start Freq 2.441000000 GHz											
Stop Freq 2.441000000 GHz											
CF Step 1.000000 MHz											
Man											
Auto											
Freq Offset 0 Hz											

Modulation Type:		8DPSK																											
3DH1	 <table border="1" data-bbox="678 548 1236 694"> <thead> <tr> <th>MNR</th> <th>MODE</th> <th>TRC</th> <th>SCL</th> <th>X</th> <th>Y</th> <th>FUNCTION</th> <th>FUNCTION WIDTH</th> <th>FUNCTION VALUE</th> </tr> </thead> <tbody> <tr> <td>1</td> <td>Δ2</td> <td>t</td> <td>t</td> <td>(Δ)</td> <td>0.000 s (Δ)</td> <td>0.00 dB</td> <td></td> <td></td> </tr> <tr> <td>2</td> <td>F</td> <td>t</td> <td>t</td> <td></td> <td>962.7 μs</td> <td>-1.33 dBm</td> <td></td> <td></td> </tr> </tbody> </table>		MNR	MODE	TRC	SCL	X	Y	FUNCTION	FUNCTION WIDTH	FUNCTION VALUE	1	Δ2	t	t	(Δ)	0.000 s (Δ)	0.00 dB			2	F	t	t		962.7 μs	-1.33 dBm		
MNR	MODE	TRC	SCL	X	Y	FUNCTION	FUNCTION WIDTH	FUNCTION VALUE																					
1	Δ2	t	t	(Δ)	0.000 s (Δ)	0.00 dB																							
2	F	t	t		962.7 μs	-1.33 dBm																							
3DH3	 <table border="1" data-bbox="678 1064 1236 1176"> <thead> <tr> <th>MNR</th> <th>MODE</th> <th>TRC</th> <th>SCL</th> <th>X</th> <th>Y</th> <th>FUNCTION</th> <th>FUNCTION WIDTH</th> <th>FUNCTION VALUE</th> </tr> </thead> <tbody> <tr> <td>1</td> <td>Δ2</td> <td>t</td> <td>t</td> <td>(Δ)</td> <td>0.000 s (Δ)</td> <td>0.00 dB</td> <td></td> <td></td> </tr> <tr> <td>2</td> <td>F</td> <td>t</td> <td>t</td> <td></td> <td>1.160 ms</td> <td>-3.60 dBm</td> <td></td> <td></td> </tr> </tbody> </table>		MNR	MODE	TRC	SCL	X	Y	FUNCTION	FUNCTION WIDTH	FUNCTION VALUE	1	Δ2	t	t	(Δ)	0.000 s (Δ)	0.00 dB			2	F	t	t		1.160 ms	-3.60 dBm		
MNR	MODE	TRC	SCL	X	Y	FUNCTION	FUNCTION WIDTH	FUNCTION VALUE																					
1	Δ2	t	t	(Δ)	0.000 s (Δ)	0.00 dB																							
2	F	t	t		1.160 ms	-3.60 dBm																							
3DH5	 <table border="1" data-bbox="678 1534 1236 1668"> <thead> <tr> <th>MNR</th> <th>MODE</th> <th>TRC</th> <th>SCL</th> <th>X</th> <th>Y</th> <th>FUNCTION</th> <th>FUNCTION WIDTH</th> <th>FUNCTION VALUE</th> </tr> </thead> <tbody> <tr> <td>1</td> <td>Δ2</td> <td>t</td> <td>t</td> <td>(Δ)</td> <td>0.000 s (Δ)</td> <td>0.00 dB</td> <td></td> <td></td> </tr> <tr> <td>2</td> <td>F</td> <td>t</td> <td>t</td> <td></td> <td>1.567 ms</td> <td>-3.66 dBm</td> <td></td> <td></td> </tr> </tbody> </table>		MNR	MODE	TRC	SCL	X	Y	FUNCTION	FUNCTION WIDTH	FUNCTION VALUE	1	Δ2	t	t	(Δ)	0.000 s (Δ)	0.00 dB			2	F	t	t		1.567 ms	-3.66 dBm		
MNR	MODE	TRC	SCL	X	Y	FUNCTION	FUNCTION WIDTH	FUNCTION VALUE																					
1	Δ2	t	t	(Δ)	0.000 s (Δ)	0.00 dB																							
2	F	t	t		1.567 ms	-3.66 dBm																							

5.8. Pseudorandom Frequency Hopping Sequence

LIMIT

FCC CFR Title 47 Part 15 Subpart C Section 15.247 (a)(1):Frequency hopping systems shall have hopping channel carrier frequencies separated by a minimum of 25 kHz or the 20 dB bandwidth of the hopping channel, whichever is greater. Alternatively, frequency hopping systems operating in the 2400–2483.5 MHz band may have hopping channel carrier frequencies that are separated by 25 kHz or two-thirds of the 20 dB bandwidth of the hopping channel, whichever is greater, provided the systems operate with an output power no greater than 125 mW. The system shall hop to channel frequencies that are selected at the system hopping rate from a pseudo-randomly ordered list of hopping frequencies. Each frequency must be used equally on the average by each transmitter. The system receivers shall have input bandwidths that match the hopping channel bandwidths of their corresponding transmitters and shall shift frequencies in synchronization with the transmitted signals.

TEST RESULTS

The pseudorandom frequency hopping sequence may be generated in a nine-stage shift register whose 5th and 9th stage outputs are added in a modulo-two addition stage. And the result is fed back to the input of the first stage. The sequence begins with the first one of 9 consecutive ones, for example: the shift register is initialized with nine ones.

- Number of shift register stages: 9
- Length of pseudo-random sequence: $2^9 - 1 = 511$ bits
- Longest sequence of zeros: 8 (non-inverted signal)

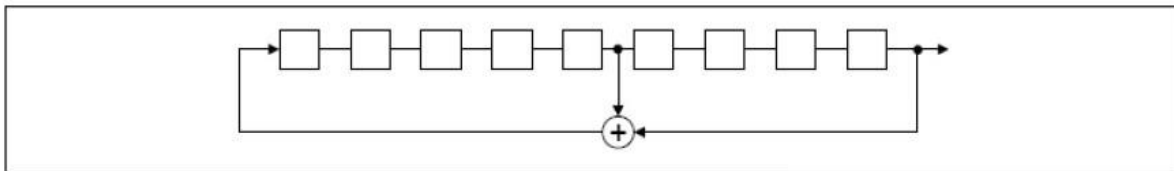

Linear Feedback Shift Register for Generation of the PRBS sequence

An example of pseudorandom frequency hopping sequence as follows:

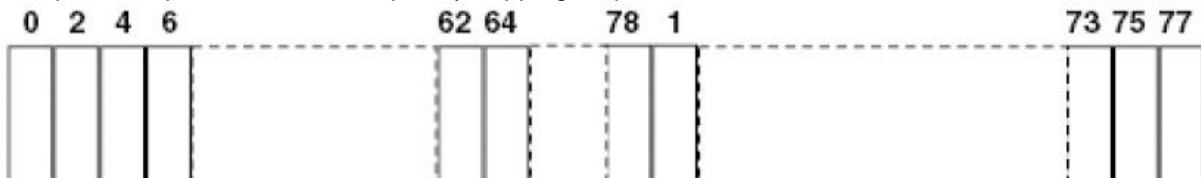

Each frequency used equally on the average by each transmitter. The system receiver has input bandwidths that match the hopping channel bandwidths of their corresponding transmitter and shift frequencies in synchronization with the transmitted signals.

5.9. Restricted band (radiated)

LIMIT

FCC CFR Title 47 Part 15 Subpart C Section 15.247 (d):

In any 100 kHz bandwidth outside the frequency band in which the spread spectrum or digitally modulated intentional radiator is operating, Radiated Emissions which fall in the restricted bands, as defined in §15.205(a), must also comply with the Radiated Emissions limits specified in §15.209(a) (see §15.205(c)).

TEST CONFIGURATION

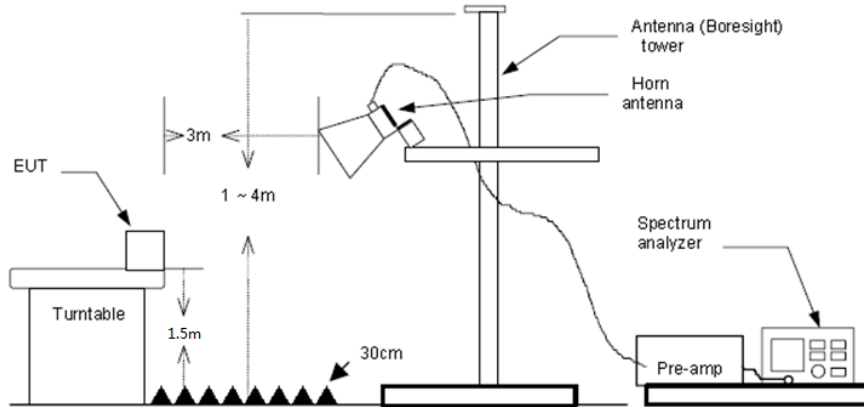

TEST PROCEDURE

1. The EUT was setup and tested according to ANSI C63.10:2013 for compliance to FCC 47CFR 15.247 requirements.
2. The EUT is placed on a turn table which is 1.5 meter above ground. The turn table is rotated 360 degrees to determine the position of the maximum emission level.
3. The EUT was positioned such that the distance from antenna to the EUT was 3 meters.
4. The antenna is scanned from 1 meter to 4 meters to find out the maximum emission level. This is repeated for both horizontal and vertical polarization of the antenna. In order to find the maximum emission, all of the interface cables were manipulated according to ANSI C63.10:2013 on radiated measurement.
5. The receiver set as follow:
 RBW=1 MHz, VBW=3 MHz Peak detector for Peak value
 RBW=1 MHz, VBW=10 Hz Peak detector for Average value.

TEST MODE:

Please refer to the clause 3.3

TEST RESULTS

Passed Not Applicable

Note:

- 1) Final level= Read level + Antenna Factor+ Cable Loss- Preamp Factor
- 2) Have pre-scan all modulation mode, found the GFSK modulation which it was worst case, so only the worst case's data on the test report.
- 3) The peak level is lower than average limit(54 dBuV/m), this data is the too weak instrument of signal is unable to test.

CH00									
Frequency (MHz)	Read Level (dBuV)	Antenna Factor (dB/m)	Cable Loss (dB)	Preamp Factor (dB)	Level (dBuV/m)	Limit Line (dBuV/m)	Over Limit (dB)	Polarization	Test value
2310.00	33.76	28.05	6.62	37.65	30.78	74.00	-43.22	Horizontal	Peak
2390.03	34.37	27.65	6.75	37.87	30.90	74.00	-43.10	Horizontal	Peak
2310.00	36.65	28.05	6.62	37.65	33.67	74.00	-40.33	Vertical	Peak
2390.03	37.67	27.65	6.75	37.87	34.20	74.00	-39.80	Vertical	Peak
2310.00	22.15	28.05	6.62	37.65	19.17	54.00	-34.83	Horizontal	Average
2390.03	22.46	27.65	6.75	37.87	18.99	54.00	-35.01	Horizontal	Average
2310.00	22.16	28.05	6.62	37.65	19.18	54.00	-34.82	Vertical	Average
2390.03	22.73	27.65	6.75	37.87	19.26	54.00	-34.74	Vertical	Average

CH78									
Frequency (MHz)	Read Level (dBuV)	Antenna Factor (dB/m)	Cable Loss (dB)	Preamp Factor (dB)	Level (dBuV/m)	Limit Line (dBuV/m)	Over Limit (dB)	Polarization	Test value
2483.50	44.78	27.26	6.83	37.87	41.00	74.00	-33.00	Horizontal	Peak
2500.00	35.06	27.20	6.84	37.87	31.23	74.00	-42.77	Horizontal	Peak
2483.50	44.83	27.26	6.83	37.87	41.05	74.00	-32.95	Vertical	Peak
2500.00	35.03	27.20	6.84	37.87	31.20	74.00	-42.80	Vertical	Peak
2483.50	24.59	27.26	6.83	37.87	20.81	54.00	-33.19	Horizontal	Average
2500.00	21.46	27.20	6.84	37.87	17.63	54.00	-36.37	Horizontal	Average
2483.50	29.11	27.26	6.83	37.87	25.33	54.00	-28.67	Vertical	Average
2500.00	22.60	27.20	6.84	37.87	18.77	54.00	-35.23	Vertical	Average

5.10. Band edge and Spurious Emissions (conducted)

LIMIT

FCC CFR Title 47 Part 15 Subpart C Section 15.247 (d): In any 100 kHz bandwidth outside the frequency band in which the spread spectrum intentional radiator is operating, the radio frequency power that is produced by the intentional radiator shall be at least 20 dB below that in the 100 kHz bandwidth within the band that contains the highest level of the desired power, based on either an RF conducted or a radiated measurement.

TEST CONFIGURATION

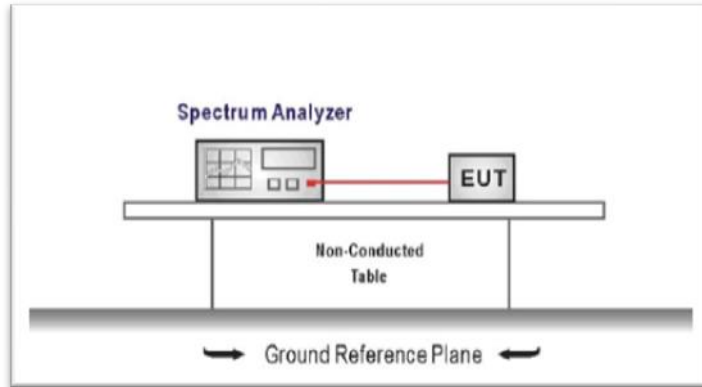

TEST PROCEDURE

1. The transmitter output was connected to the spectrum analyzer through an attenuator, the path loss was compensated to the results for each measurement.
2. Set to the maximum power setting and enable the EUT transmit continuously
3. Use the following spectrum analyzer settings:
RBW = 100 kHz, VBW \geq RBW
Sweep = auto, Detector function = peak, Trace = max hold
4. Measure and record the results in the test report.

TEST MODE:

Please refer to the clause 3.3

TEST RESULTS

Passed Not Applicable

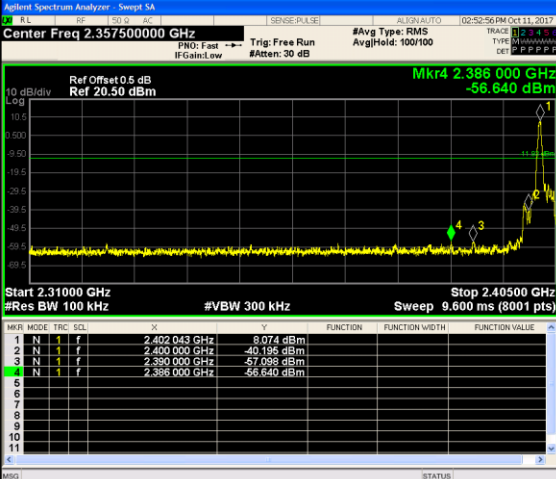
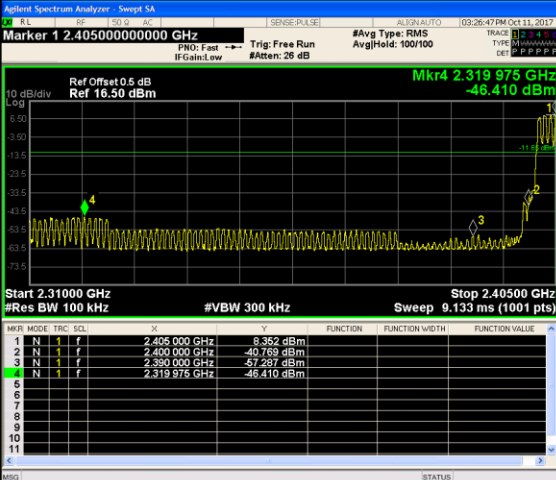
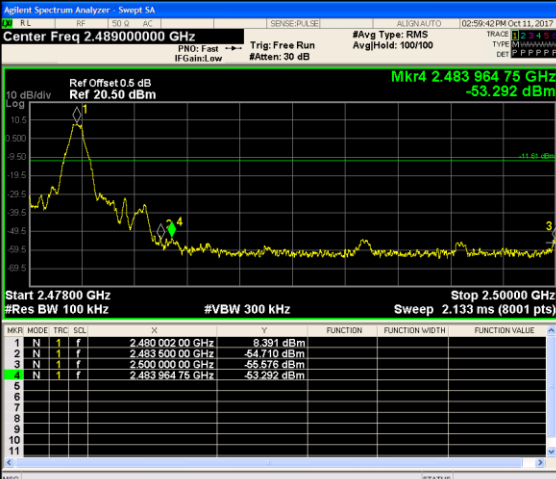
Test Item:	Band edge	Modulation type:	GFSK
<p>CH00 No hopping mode</p>		<p>Center Freq 2.357500000 GHz</p> <p>Start Freq 2.310000000 GHz</p> <p>Stop Freq 2.405000000 GHz</p> <p>CF Step 9.500000 MHz</p> <p>Freq Offset 0 Hz</p>	<p>Frequency</p> <p>Auto Tune</p> <p>Center Freq 2.357500000 GHz</p> <p>Start Freq 2.310000000 GHz</p> <p>Stop Freq 2.405000000 GHz</p> <p>CF Step 9.500000 MHz</p> <p>Freq Offset 0 Hz</p>
<p>CH00 Hopping mode</p>		<p>Marker 1 2.405000000000 GHz</p> <p>Start 2.310000 GHz</p> <p>Stop 2.405000 GHz</p>	<p>Peak Search</p> <p>Next Peak</p> <p>Next Pk Right</p> <p>Next Pk Left</p> <p>Marker Delta</p> <p>Mkr--CF</p> <p>Mkr--Ref Lvl</p> <p>More 1 of 2</p>
<p>CH78 No hopping mode</p>		<p>Center Freq 2.489000000 GHz</p> <p>Start Freq 2.478000000 GHz</p> <p>Stop Freq 2.500000000 GHz</p> <p>CF Step 2.200000 MHz</p> <p>Freq Offset 0 Hz</p>	<p>Frequency</p> <p>Auto Tune</p> <p>Center Freq 2.489000000 GHz</p> <p>Start Freq 2.478000000 GHz</p> <p>Stop Freq 2.500000000 GHz</p> <p>CF Step 2.200000 MHz</p> <p>Freq Offset 0 Hz</p>

CH78
Hopping mode

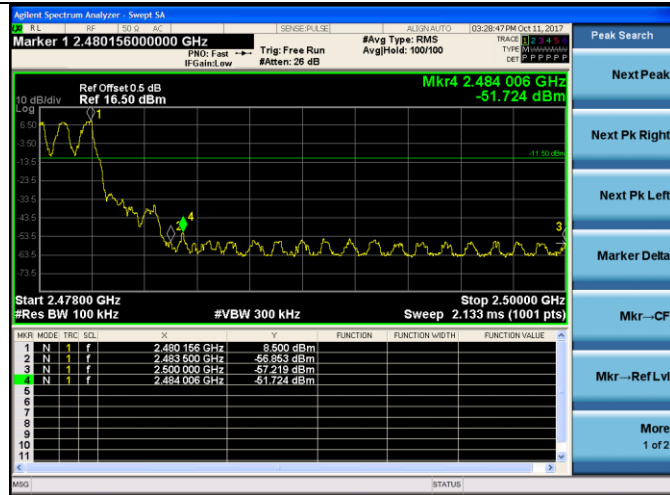

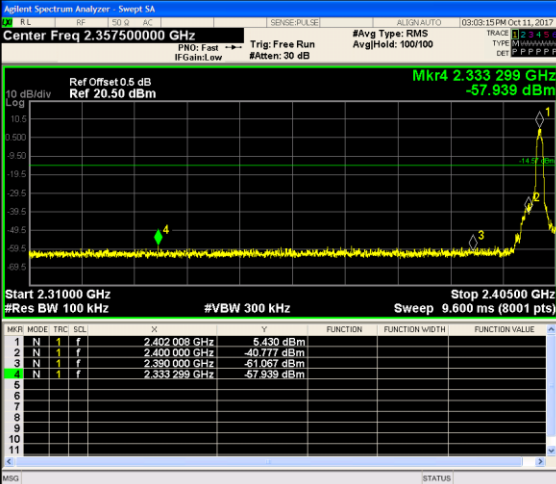
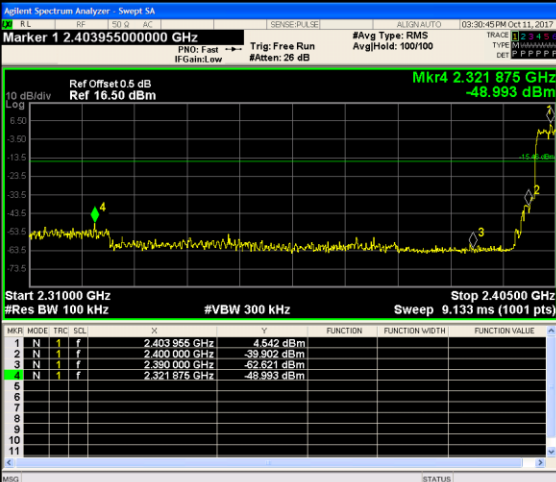
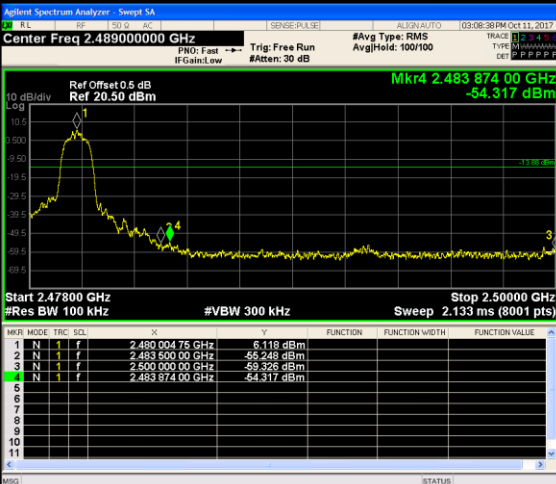
Test Item:	Band edge	Modulation type:	$\pi/4$ DQPSK
<p>CH00</p> <p>No hopping mode</p>		<p>Center Freq 2.357500000 GHz</p> <p>Start Freq 2.310000000 GHz</p> <p>Stop Freq 2.405000000 GHz</p> <p>CF Step 9.500000 MHz</p> <p>Freq Offset 0 Hz</p>	<p>Frequency</p> <p>Auto Tune</p> <p>Center Freq 2.357500000 GHz</p> <p>Start Freq 2.310000000 GHz</p> <p>Stop Freq 2.405000000 GHz</p> <p>CF Step 9.500000 MHz</p> <p>Freq Offset 0 Hz</p>
<p>CH00</p> <p>Hopping mode</p>		<p>Marker 1 2.403955000000 GHz</p> <p>Mkr4 2.321 875 GHz -48.993 dBm</p> <p>Start 2.31000 GHz</p> <p>Stop 2.40500 GHz</p> <p>Mkr--CF</p> <p>Mkr--Ref Lvl</p>	<p>Peak Search</p> <p>Next Peak</p> <p>Next Pk Right</p> <p>Next Pk Left</p> <p>Marker Delta</p> <p>Mkr--CF</p> <p>Mkr--Ref Lvl</p> <p>More 1 of 2</p>
<p>CH78</p> <p>No hopping mode</p>		<p>Center Freq 2.489000000 GHz</p> <p>Mkr4 2.483 874 00 GHz -54.317 dBm</p> <p>Start 2.47800 GHz</p> <p>Stop 2.50000 GHz</p>	<p>Frequency</p> <p>Auto Tune</p> <p>Center Freq 2.489000000 GHz</p> <p>Start Freq 2.478000000 GHz</p> <p>Stop Freq 2.500000000 GHz</p> <p>CF Step 2.200000 MHz</p> <p>Freq Offset 0 Hz</p>

CH78
Hopping mode

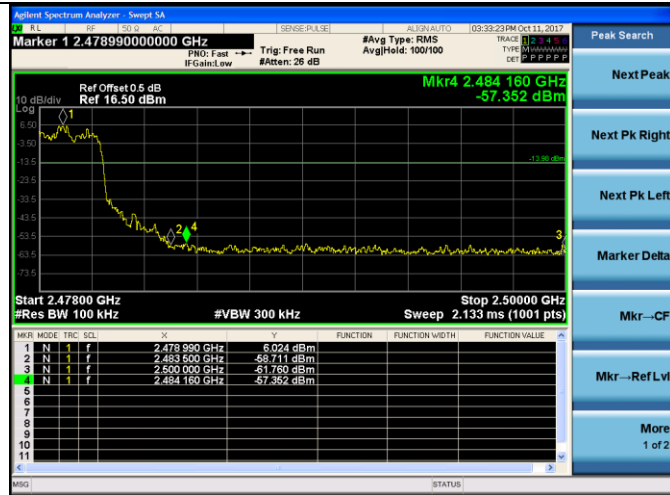

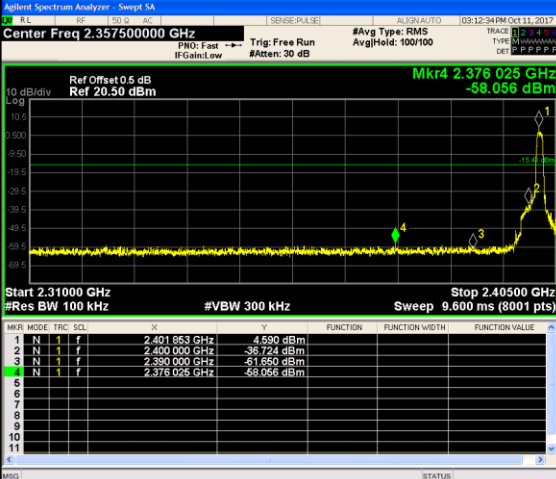
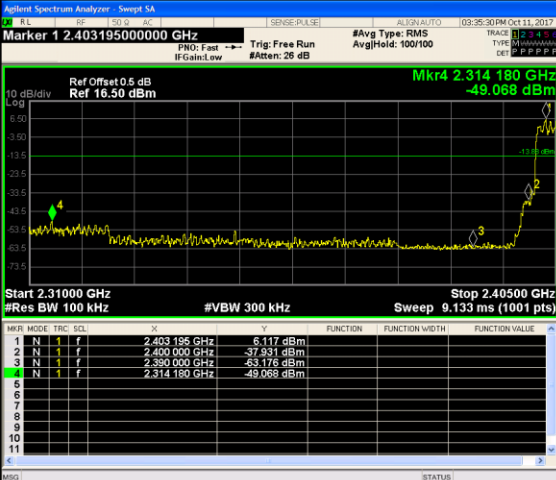
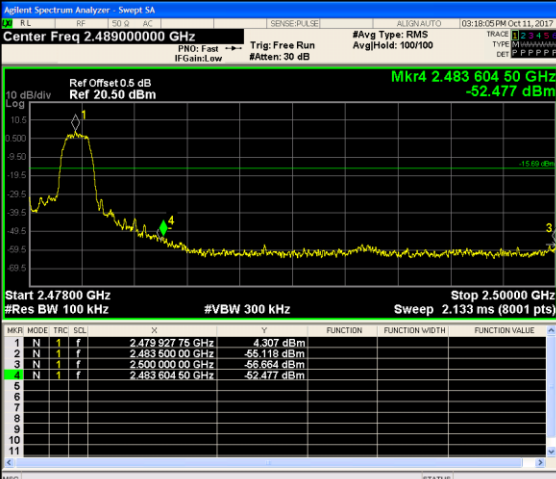
Test Item:	Band edge	Modulation type:	8DPSK
<p>CH00 No hopping mode</p>			<p>Frequency</p> <p>Auto Tune</p> <p>Center Freq 2.357500000 GHz</p> <p>Start Freq 2.310000000 GHz</p> <p>Stop Freq 2.405000000 GHz</p> <p>CF Step 9.500000 MHz</p> <p>Man</p> <p>Freq Offset 0 Hz</p>
<p>CH00 Hopping mode</p>			<p>Peak Search</p> <p>Next Peak</p> <p>Next Pk Right</p> <p>Next Pk Left</p> <p>Marker Delta</p> <p>Mkr--CF</p> <p>Mkr--Ref Lvl</p> <p>More 1 of 2</p>
<p>CH78 No hopping mode</p>			<p>Frequency</p> <p>Auto Tune</p> <p>Center Freq 2.489000000 GHz</p> <p>Start Freq 2.478000000 GHz</p> <p>Stop Freq 2.500000000 GHz</p> <p>CF Step 2.200000 MHz</p> <p>Man</p> <p>Freq Offset 0 Hz</p>

CH78
Hoppig mode

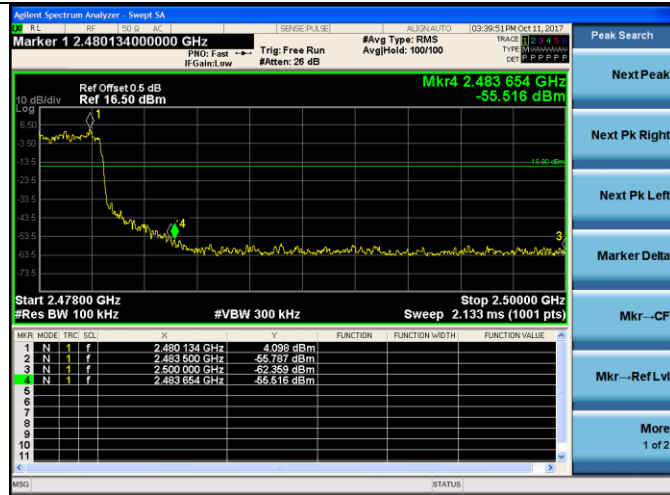

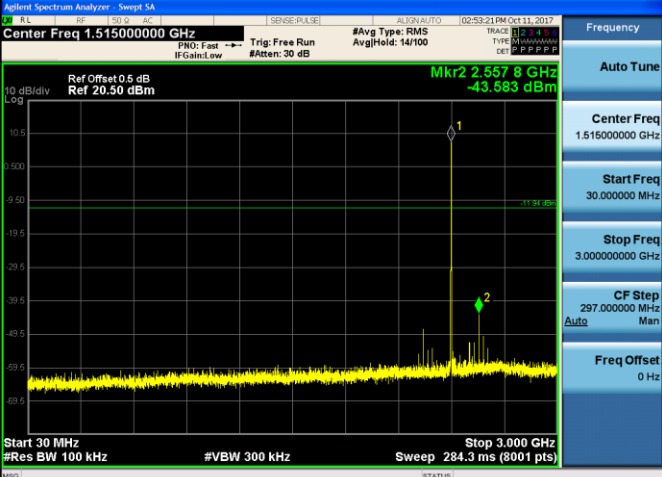
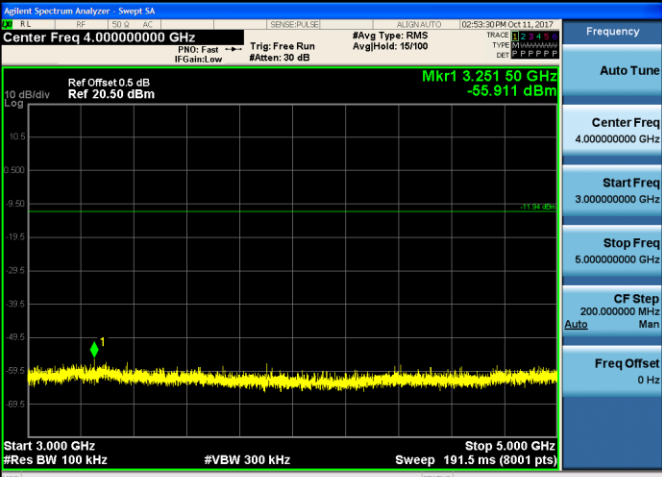
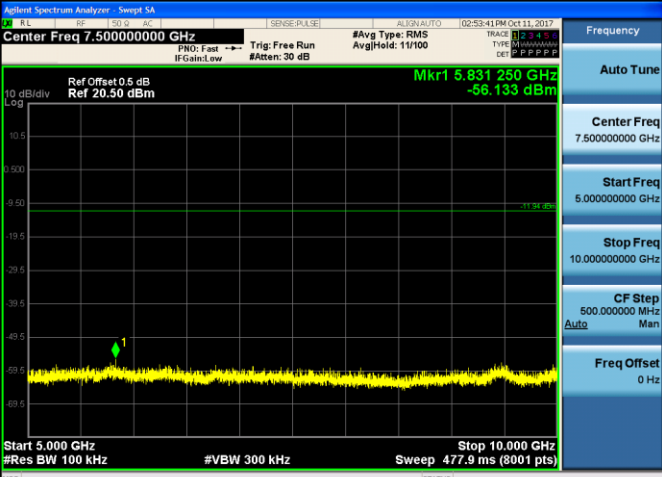
Test Item:	SE	Modulation type:	GFSK
<p>CH00 30MHz~3GHz</p>			<p>Frequency</p> <p>Auto Tune</p> <p>Center Freq 1.515000000 GHz</p> <p>Start Freq 30.0000000 MHz</p> <p>Stop Freq 3.000000000 GHz</p> <p>CF Step 297.000000 MHz Auto Man</p> <p>Freq Offset 0 Hz</p>
<p>CH00 3GHz~5GHz</p>			<p>Frequency</p> <p>Auto Tune</p> <p>Center Freq 4.000000000 GHz</p> <p>Start Freq 3.000000000 GHz</p> <p>Stop Freq 5.000000000 GHz</p> <p>CF Step 200.000000 MHz Auto Man</p> <p>Freq Offset 0 Hz</p>
<p>CH00 5GHz~10GHz</p>			<p>Frequency</p> <p>Auto Tune</p> <p>Center Freq 7.500000000 GHz</p> <p>Start Freq 5.000000000 GHz</p> <p>Stop Freq 10.000000000 GHz</p> <p>CF Step 500.000000 MHz Auto Man</p> <p>Freq Offset 0 Hz</p>