



# HP70

ENGLISH



Owner's Manual

# IMPORTANT SAFETY INSTRUCTIONS

## OSHA GUIDELINES FOR NOISE EXPOSURE LIMITS

The Occupational Safety Health Administration (OSHA) has issued headphone usage recommendations for maximum daily exposure and sound pressure levels [measured in decibels (dB)]. A decibel is a unit of sound measurement that increases exponentially with volume. For example, conversational speech is typically around 60dB and a rock concert in a stadium is often about 110dB.

<b>90dB</b>	8 hours
<b>95dB</b>	4 hours
<b>100dB</b>	2 hours
<b>105dB</b>	1 Hour
<b>110dB</b>	30 minutes
<b>115dB</b>	15 minutes
<b>120dB</b>	Avoid as damage may occur

## IC NOTICE

This device complies with Industry Canada licence-exempt RSS standard(s). Operation is subject to the following two conditions: (1) this device may not cause interference, and (2) this device must accept any interference, including interference that may cause undesired operation of the device.

Le présent appareil est conforme aux CNR d'Industrie Canada applicables aux appareils radio exempts de licence. L'exploitation est autorisée aux deux conditions suivantes : (1) l'appareil ne doit pas produire de brouillage, et (2) l'utilisateur de l'appareil doit accepter tout brouillage radioélectrique subi, même si le brouillage est susceptible d'en compromettre le fonctionnement.

## Radio Frequency Exposure Statement for IC

The device has been evaluated to meet general RF exposure requirements. The device can be used in mobile exposure conditions. The min separation distance is 25mm.

## WARNING!

- Warnings or announcements may be unnoticed when you are using the headphones. You should be aware of ambient sounds while wearing the headphones, and recognize them as needed.
- Long-term exposure to loud music may cause permanent hearing damage.
- Do not attempt to modify this product as it could result in personal injury and/or product failure.
- If water or other foreign substances enter inside the device, fire or electric shock may result.

## CAUTION

Changes or modifications to this equipment not expressly approved by NAD Electronics for compliance could void the user's authority to operate this equipment.

## Regulatory Information

Operating Temperature Range:	5°C – 40°C
Operating Frequency Range:	Bluetooth 2.4G
Input Rating:	5VDC, 1A
Battery Rating:	3.7V, 600mAh
Battery Charging Time:	4 hours
Weight:	330 grams

Is in compliance with the essential requirements and other relevant provisions of Directive 2014/53/EU.

Date of Manufacture: The second digit in the serial number indicates the year of manufacture; "7" is 2017.

Responsible Party: Lenbrook Industries Limited. 633 Granite Court, Pickering, Ontario, Canada L1W 3K1. Phone: (905) 831-6333, Facsimile: (905) 831-6936

Removal of the rechargeable lithium ion battery in this product should be conducted only by a qualified professional. Please contact your local NAD Electronics Dealer or visit the Customer Support section at [NADelectronics.com](http://NADelectronics.com) for further information.

The Bluetooth® word mark and logos are registered trademarks owned by Bluetooth SIG, Inc. and any use of such marks by NAD Electronics is under license.

The N-Mark is a trademark or registered trademark of the NFC Forum, Inc. in the United States and in other countries.

## Precautions for use

- To prevent possible hearing damage, do not listen at high volume levels for long periods
- These headphones should only be connected to a USB interface of version USB2.0 or higher 
- Risk of explosion if the battery is replaced by an incorrect type, dispose of used batteries according to the instructions.
- Be sure to read the Owner's Manual of the device that you want to connect to these headphones.
- Check the volume settings when using the headphones when in public places and ensure that you do not disturb people around you.
- These headphones are not guaranteed to work with all combinations of Bluetooth devices/mobile phones.
- These headphones do not support a connection with all Bluetooth devices/mobile phones.
- Bluetooth wireless technology can communicate up to approximately 10 m. Obstructions (people, metallic objects, walls, etc.) and radio wave conditions affect the actual range.
- The Bluetooth device that you want to connect with must support the same profile as these headphones in order to use the Bluetooth function. For details on profiles that the Bluetooth device is compatible with, see the Bluetooth device Owner's Manual.
- Due to features of Bluetooth wireless technology, playback of audio on the headphones is slightly delayed compared to the playback on the transmitting device.
- Do not use your headphones while driving.
- Remove the headphones immediately if you experience a warming sensation or loss of audio.
- Do not use mobile phone adaptors to connect these headphones to airplane seat jacks, as this could cause overheating and result in injury or property damage.
- The headphones and accessories contain small parts which may be a choking hazard. Not suitable for children under age 3.
- This product contains magnetic material. Consult your physician on whether this might affect your implanted medical device.
- Use this product only with an agency approved power supply which meets local regulatory requirements (e.g., UL, CSA, VDE, CCC).
- Do not expose products containing batteries to excessive heat (e.g. from storage in direct sunlight, fire or the like).

## NOTES ON ENVIRONMENTAL PROTECTION



At the end of its useful life, this product should not be disposed of with regular household waste and should be returned to a collection point for the recycling of electrical and electronic equipment. The symbol on the product, user's manual and packaging point this out.

The materials can be reused in accordance with their markings. Through re-use, recycling of raw materials, or other forms of recycling of old products, you are making an important contribution to the protection of our environment.

Your local administrative office can advise you of the responsible waste disposal point.

NAD VISO HP70 is the culmination of more than forty five years of dedicated audio innovation. Designed and driven by audiophiles, NAD VISO HP70 is made specifically for digital natives who understand the difference that clean, crisp sound makes to music lovers.

The HP70 headphones introduce best-in-class performance combined with incredible comfort and forward-thinking design in the world's next pair of over-ear headphones. Infused with the innovative RoomFeel™ technology, soundstages are dramatically expanded, adding warmth and open sound, without altering the audio signal. The HP70 also offers analogue and USB inputs, pivoting ear cups and a built in remote and microphone.

We hope you will read through this owner's guide to help assure that you are getting the most out of your new NAD VISO HP70.

## WHAT'S INSIDE THE BOX

NAD VISO HP70 Wireless Carton Contents

- HP70 Wireless Headphones
- Micro USB charging cable
- 3.5 mm to ¼ inch headphone adaptor
- Airline adaptor
- Standard 3.5 mm cable
- Carabineer
- Travel pouch

## INCLUDED ACCESSORIES

### 1 HEADPHONE ADAPTOR CABLE



For a complete listening experience on most devices not wirelessly supported, use the standard ribbon cable. Plug the straight end of the standard cable into the bottom of the right ear cup and the L-shaped end into the 1/8" (3.5mm) stereo socket on your music player.

- Each ear cup is marked with "L" and "R" to indicate the left and right sides of the headphones.
- A 1/4" (6.3mm) adaptor is also included for connecting to other audio equipment.

#### NOTES

- *Hold the plug at the end of the cable and pull to disconnect. Never pull on the headphone cable to disconnect the headphones from the music player.*
- *Turn the volume down to a comfortable listening level on your music player before putting on VISO HP70.*

### 2 AIRLINE ADAPTOR

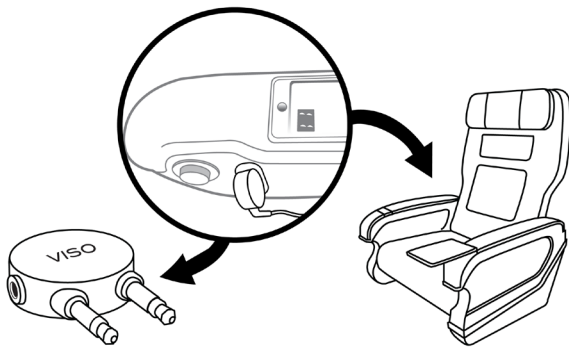

- Use the supplied dual 3.5mm airline adaptor to connect your VISO HP70 to in-flight stereo entertainment systems.

#### NOTES

- *The supplied conversion plug may not be usable depending on the type of aircraft.*
- *Do not use these headphones when the use of electric devices on the aircraft is prohibited, or when the use of personal headphones to listen to on-board music service is prohibited.*
- *Audio output jack configurations may vary on airplanes. Airline audio quality may not equal that of your home audio equipment, or portable sources provide.*



*NAD recommends not to use these headphones as aviation communication equipment. They are not engineered for many environmental conditions common in commercial or non-commercial aircraft (including, but not limited to: altitude, temperature, noise conditions, unpressurized aircraft) and could result in possible interference to critical communications.*

## WIRELESS PAIRING

### 3 USB CABLE



- Use the supplied USB cable to listen to music from your computer (audio only). This cable is used to charge your HP70 headphones.

#### Notes:

- When connecting the USB cable to the charging port, be sure to match the cable connector with the shape of the socket. Forcing the connector into the socket will cause damage.
- A rating of the charging output should be DC 5V, 2.4A or less
- -The usable time of the headphones differs depending on the temperature of the environment in which they are used and method of use.

#### Wireless Pairing

Pairing is the process required to create a link between Bluetooth devices to allow wireless connection. You must pair a device with the HP70 headphones to be able to make a BLUETOOTH connection for the first time. Before you start pairing operation, make sure that:

- The Bluetooth device is placed within 1 m (3 feet) of the headset.
- The HP70 is charged sufficiently.

#### To pair your device:

1. Turn on the Bluetooth feature on the source device.
2. Open the Bluetooth settings on the source device.
3. Press the pairing button for 3 seconds on the HP70. The LED will flash BLUE.
4. Select the HP70 headphones from the device list.
5. Once the HP70's link has been established with the source device, the LED will turn solid BLUE.
6. If pairing fails, the LED will turn solid RED.

#### NFC Wireless Pairing

HP70 supports Near Field Communication (NFC) so you can easily pair your headphones. For pairing follow the instructions below.

#### To pair your device using NFC:

1. Turn on NFC and Bluetooth on the device you are pairing.
2. Place your Bluetooth enabled device against the bottom of the right ear cup.
3. Accept the pairing on your device when prompted.

Note: NFC is a short-range wireless communication. Pairing devices are required to be within a few centimetres of the headphones to communicate. If pairing is unsuccessful, refer to the device's manual to find its NFC touchpoint. Repeat the steps shown and ensure the located touchpoint is placed against the right ear cup as directed in Step 2.

# USING THE NAD VISO HP70 HEADPHONES



The ear cups are marked with "L" and "R" to indicate the left and right sides of the headphones. Be sure to put them on correctly to enjoy your audio as originally intended and maximize your personal music experience.

## Earphone Mounted Controls

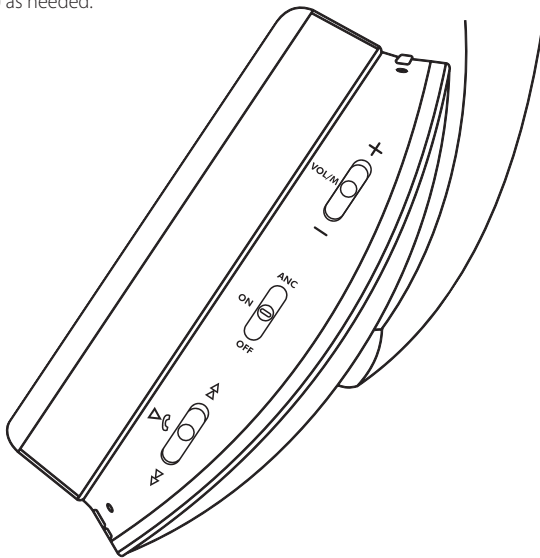

The main controls are located on the rear part of the right ear cup. They are used to control Volume, Noise Cancelling, and your smart device (tablet, iPod) as needed.







### Volume and Active Monitor

-  Slide up towards the + sign to increase the volume.
-  Slide down towards the - sign to lower the volume.
-  Press the button VOL/M to engage the Active Monitor and reduce your current audio track by 30dB. This will enable you to hear your surroundings, without leaving your personal space. The described function only works in Active Noise Cancelling mode. When activated, the surroundings will be amplified through the headphones.

### Active Noise Cancellation and Amplifier

-  The power modes use the internal (rechargeable) battery. In Active Noise Cancelling mode, the "Noise Cancelling" feature has been activated with the internal headphone amplifier. The 3-position Power Switch will be "GREEN".
-  In Active mode, the internal headphone amplifier is active. The 3-position Power Switch will be "BLUE".
-  In Passive mode (OFF), noise cancelling and amplifier are turned off. No power is required as the headphones are powered by your audio source. Note: Bluetooth connection will not work in this mode.

### Phone Function



-  If you receive a phone call during a listening session press the Phone button to answer the incoming call and pause your audio track. Once the call is complete, a single button press will end the call and resume audio play. The call answer only works when connected by Bluetooth. The player controls work when connected by Bluetooth or USB to a PC.
-  When listening to a handheld music device such as an iPod, the Audio Control Button can be used to change to the previous track, the next track or pause and resume music without reverting back to the controls of the handheld device.
-  Slide the button up for previous track.
-  Slide the button down for the next track.

## Additional Controls

Additional controls and connection points are on each earcup as follows:

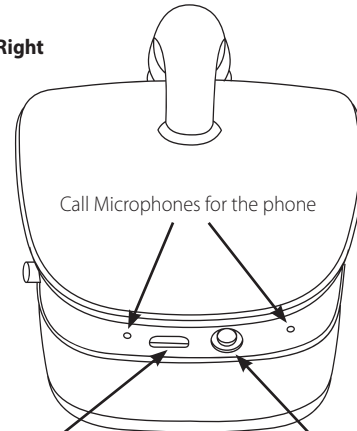
### Bottom Right



-  Micro USB plug, used to charge the internal battery. Can also be used as a PC connection for audio only
-  3.5mm jack for optional audio equipment

### Top Right

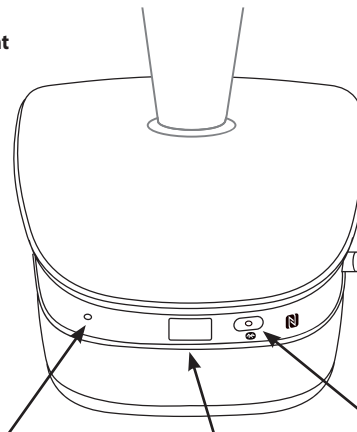

-  ANC Microphone
-  ANC Programming Connection (Service Use Only)
-  Bluetooth Pairing button

### Adjust the slider to the preferred length.

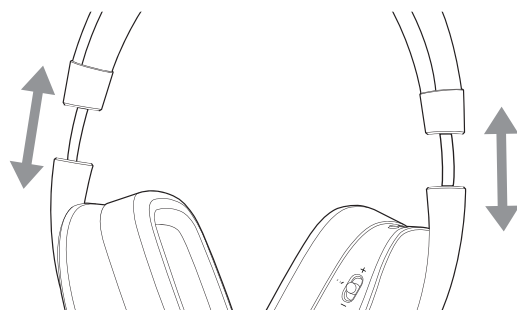

### Notes:

- Be careful not to trap your fingers, etc. in the moving parts
- Do not pull the slider too forcefully.
- In order to hear the best quality sound, be sure that the earpads correctly cover both the left and right ears. If there are gaps between your ears and the headphones earpads, sound will leak and the bass level and effectiveness of the noise cancelling function will be reduced.

# HANDLING AND MAINTENANCE

## EAR CUP ATTACHMENT AND REMOVAL

The ear cup cushions have been designed to be removable for cleaning and replacement purposes. Constant removal of the cushions is not recommended.

### TO DETACH THE EAR CUP CUSHION

1. Grip the ear cup that needs the cushion removed.
2. Using the other hand, grip the leather ear cup cushion and carefully stretch and pull the lip of the cushion away from the groove.



### TO REATTACH THE EAR CUP CUSHION

1. Grip the headband and cushion as described above.
2. Fit the lip of the ear cup cushion into the groove/slot, then slowly work the leather lip into the groove of the ear cup until firmly inserted.

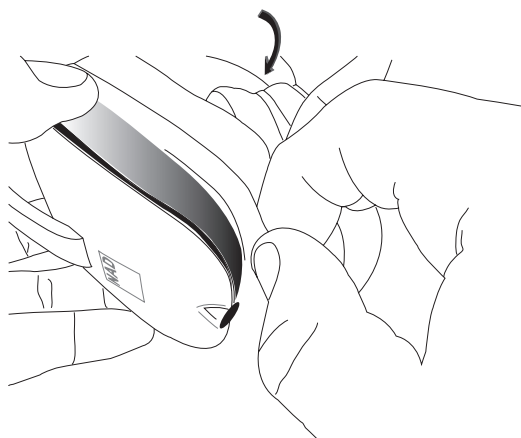

#### NOTE:

- Be careful not to press down on or remove any other components inside the earcup as this could damage the headphones.

## CARE AND CLEANING

For safe, sanitary use, it is essential to maintain and clean your NAD VISO HP70 periodically. However, excessive cleaning may cause damage and jeopardize the longevity of the product.

- When not in use, always store your VISO HP70 in the supplied protective case and store in a clean and dry environment.
- Remove the cable from the headphones, fold and insert them into the protective case.
- Do not force them into the protective case. Doing so may damage the headphones.
- Avoid storing in extreme heat or cold temperatures and humidity and avoid exposure to liquids.
- For regular cleaning, use a slightly damp cloth and gently clean each ear cup cushion, then using a dry cloth remove any residual moisture.
- If heavier cleaning is required, use standard cleaning practices and never apply harmful or corrosive cleaners to the headphones.

#### WARNING

*Never let liquid get in the speaker or electronics inside of the VISO HP70. Water or cleaning solvents may cause irreparable damage to the electronics inside your headphones.*

**NOTE:** The serial number is located beneath the Left earpad.

**TROUBLESHOOTING**

<b>CONDITION</b>	<b>POSSIBLE CAUSES</b>	<b>POSSIBLE SOLUTIONS</b>
<b>Low or no audio output.</b>	• Audio source is powered off.	• Power on audio source.
	• Audio volume level is set to minimum.	• Set audio to medium volume level.
	• No connection between audio source and ear cup.	• Ensure full ribbon cable connection between ear cup and audio source.
	• No Bluetooth connection.	• Check the source device to ensure that Bluetooth is turned on and the headphones are paired and connected.
<b>Crackling noise or intermittent audio.</b>	• Ribbon cable connection is not fully inserted or pushed home at the audio source or ear cup end.	• Ensure full cable connection between audio source and ear cup.
	• Connection at the audio source or ear cup end is damaged.	• Use new ribbon cable.
	• Source device is out of range of the headphones.	• Move within arms length to see if the audio signal improves.
<b>Bluetooth is not connected</b>	• Signal interference	• Check the source devices Bluetooth settings. • Dead battery – recharge.

## **FCC NOTICE**

**NOTE:** This equipment has been tested and found to comply with the limits for a Class B digital device, pursuant to part 15 of the FCC Rules. These limits are designed to provide reasonable protection against harmful interference in a residential installation. This equipment generates uses and can radiate radio frequency energy and, if not installed and used in accordance with the instructions, may cause harmful interference to radio communications. However, there is no guarantee that interference will not occur in a particular installation. If this equipment does cause harmful interference to radio or television reception, which can be determined by turning the equipment off and on, the user is encouraged to try to correct the interference by one or more of the following measures:

- Reorient or relocate the receiving antenna.
- Increase the separation between the equipment and receiver.
- Connect the equipment into an outlet on a circuit different from that to which the receiver is connected.
- Consult the dealer or an experienced radio/TV technician for help

Changes or modifications not expressly approved by the party responsible for compliance could void the user's authority to operate the equipment. This device complies with Part 15 of the FCC Rules. Operation is subject to the following two conditions:

- (1)** this device may not cause harmful interference, and
- (2)** this device must accept any interference received, including interference that may cause undesired operation.



[www.NADelectronics.com](http://www.NADelectronics.com)

**©2017 NAD ELECTRONICS INTERNATIONAL  
A DIVISION OF LENBROOK INDUSTRIES LIMITED**

All rights reserved. NAD and the NAD logo are trademarks of NAD Electronics International, a division of Lenbrook Industries Limited.  
No part of this publication may be reproduced, stored or transmitted in any form without the written permission of NAD Electronics International.  
While every effort has been made to ensure the contents are accurate at the time of publication, features and specifications may be subject to change without prior notice.