

FCC&ISED RF TEST REPORT

No. 170900965SHA-001

Applicant : Lenbrook Industries Limited
633 Granite Court, Pickering Ontario, L1W 3K1, Canada

Manufacturing site : Hansong (Nanjing) Technology Ltd.
8th Kangping Road, Jiangning Economy and Technology
Development Zone, Nanjing, 211106, China.

Product Name : Hybrid Digital Integrated Amplifier

Type/Model : C 328

TEST RESULT : PASS

SUMMARY

The equipment complies with the requirements according to the following standard(s):

47CFR Part 15 (2016): Radio Frequency Devices

ANSI C63.10 (2013): American National Standard for Testing Unlicensed Wireless Devices

RSS-247 Issue 2 (February 2017): Digital Transmission Systems (DTSs), Frequency Hopping Systems (FHSs) and Licence-Exempt Local Area Network (LE-LAN) Devices

RSS-Gen Issue 4 (November 2014): General Requirements for Compliance of Radio Apparatus

Date of issue: December 6, 2017

Prepared by:



Wade Zhang (Project engineer)

Reviewed by:

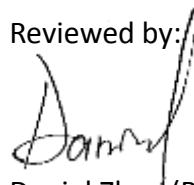

Daniel Zhao (Reviewer)

Description of Test Facility

Name: Intertek Testing Services Shanghai
Address: Building No.86, 1198 Qinzhou Road (North), Shanghai 200233, P.R. China

FCC Designation Number: CN1175
IC Assigned Code: 2042B-1

Name of contact: Leah Xu
Tel: 86 21 61278200
Fax: 86 21 54262353

Content

DESCRIPTION OF TEST FACILITY	2
1. GENERAL INFORMATION	5
1.1 APPLICANT INFORMATION.....	5
1.2 IDENTIFICATION OF THE EUT	5
1.3 TECHNICAL SPECIFICATION.....	6
1.4 MODE OF OPERATION DURING THE TEST / TEST PERIPHERALS USED.....	7
2. TEST SPECIFICATION	8
2.1 INSTRUMENT LIST	8
2.2 TEST STANDARD	8
2.3 TEST SUMMARY	9
2.4 FREQUENCY HOPPING SYSTEM REQUIREMENT	10
2.5 MEASUREMENT UNCERTAINTY	11
3. 20 DB BANDWIDTH.....	12
3.1 LIMIT	12
3.2 TEST CONFIGURATION	12
3.3 TEST PROCEDURE AND TEST SETUP	12
3.4 TEST PROTOCOL	13
4. CARRIER FREQUENCY SEPARATION	19
4.1 LIMIT	19
4.2 TEST CONFIGURATION	19
4.3 TEST PROCEDURE AND TEST SETUP	19
4.4 TEST PROTOCOL	20
5. MAXIMUM PEAK OUTPUT POWER.....	26
5.1 TEST LIMIT	26
5.2 TEST CONFIGURATION	26
5.3 TEST PROCEDURE AND TEST SETUP	26
5.4 TEST PROTOCOL	27
6. RADIATED SPURIOUS EMISSIONS	33
6.1 TEST LIMIT	33
6.2 TEST CONFIGURATION	33
6.3 TEST PROCEDURE AND TEST SETUP	34
6.4 TEST PROTOCOL	35
7. CONDUCTED SPURIOUS EMISSIONS & BAND EDGE	39
7.1 LIMIT	39
7.2 TEST CONFIGURATION	39
7.3 TEST PROCEDURE AND TEST SETUP	39
7.4 TEST PROTOCOL	40
8. POWER LINE CONDUCTED EMISSION.....	64
8.1 LIMIT	64
8.2 TEST CONFIGURATION	64
8.3 TEST PROCEDURE AND TEST SET UP	65
8.4 TEST PROTOCOL	66
9. NUMBER OF HOPPING FREQUENCIES	68
9.1 LIMIT	68
9.2 TEST CONFIGURATION	68

9.3 TEST PROCEDURE AND TEST SETUP 68

9.4 TEST PROTOCOL 68

10. DWELL TIME 71

10.1 LIMIT 71

10.2 TEST CONFIGURATION 71

10.3 TEST PROCEDURE AND TEST SETUP 71

10.4 TEST PROTOCOL..... 72

11. OCCUPIED BANDWIDTH.....76

11.1 TEST LIMIT 76

11.2 TEST CONFIGURATION 76

11.3 TEST PROCEDURE AND TEST SETUP 76

11.4 TEST PROTOCOL..... 77

12. SPURIOUS EMISSION FOR RECEIVER.....78

12.1 TEST LIMIT 78

12.2 TEST CONFIGURATION 78

12.3 TEST PROCEDURE AND TEST SETUP 78

12.4 TEST PROTOCOL..... 79

1. General Information

1.1 Applicant Information

Applicant : Lenbrook Industries Limited
633 Granite Court, Pickering Ontario, L1W 3K1, Canada

Name of contact : Taresh Vadgame

Tel : +1 905 831 0799

Fax : +1 905 831 6936

Manufacturing site : Hansong (Nanjing) Technology Ltd.
8th Kangping Road, Jiangning Economy and Technology
Development Zone, Nanjing, 211106, China.

1.2 Identification of the EUT

Equipment : Hybrid Digital Integrated Amplifier

Type/model : C 328

FCC ID : SVC-C328

IC : 152C-C328

Description of EUT : The EUT is an amplifier which support Bluetooth function. The EUT has only one model, we tested it and listed the result in this report.

Rating : 100-120V/220-240V~ 50/60Hz 80W

Port identification : AC Input *1
Optical Input *2
Coaxial In *2
Streaming (Right & Left) *1
TV (Right & Left) *1
Phono In (Right & Left) *1
SUBW Out *1
Speaker Outputs (Right & Left) *2
Service Port *1

Category of EUT : Class B

EUT type : Table top Floor standing

Sample received date : October 28, 2017

Date of test : October 28, 2017 to November 27, 2017

1.3 Technical specification

Operation Frequency Band: 2402 - 2480 MHz
 Protocol: BT 4.0 (BR+EDR)
 Modulation: GFSK, $\pi/4$ DQPSK, 8DPSK

Technology:

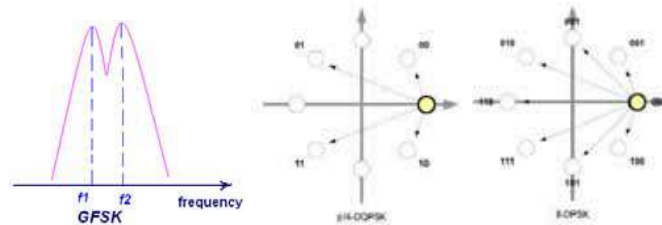

Antenna Designation: Internal PCB antenna, 2.0dBi Peak gain

Channel Description: There are 79 channels in all. The designed channel spacing is 1MHz.

Channel Identifier	Frequency (MHz)
low	2402
middle	2441
high	2480

Antenna Requirement: An intentional radiator shall be designed to ensure that no antenna other than that furnished by the responsible party shall be used with the device. The use of a permanently attached antenna or of an antenna that uses a unique coupling to the intentional radiator shall be considered sufficient to comply with the provisions of this section. The manufacturer may design the unit so that a broken antenna can be replaced by the user, but the use of a standard antenna jack or electrical connector is prohibited.

The EUT used a print internal PCB antenna, so fulfill these requirements.

1.4 Mode of operation during the test / Test peripherals used

While testing the transmitter mode of the EUT, the internal modulation is applied. All the functions of the host device except the BT module were set on stand-by mode.

The test setting software is offered by the manufactory. The pre-scan for the conducted power with all rates in each modulation and bands was used, and the worst case was found and used in all test cases.

Radiated test mode:

Mode 1: EUT transmitted signal with BT antenna;

Conducted test mode:

Mode 2: EUT transmitted signal from BT RF port connected to SPA directly;

The worst case modulation configuration:

Worst Modulation Used for Conformance Testing			
Bluetooth Mode	Data Rate	Packet Type	Worst Mode
GFSK	BR-1Mbps	DH1,DH3,DH5	BR-1Mbps DH5 EDR-2Mbps 2DH5 EDR-3Mbps 3DH5
$\pi/4$ DQPSK	EDR-2Mbps	2DH1,2DH3,2DH5	
8DPSK	EDR-3Mbps	3DH1,3DH3,3DH5	
Note: The BR-1Mbps DH5 mode was chosen for radiation emission bellow 1GHz and Conducted emission testing as representative in this report.			

The power setting parameter:

The worst case power setting parameter			
Test software Version	Blue Test 3		
Modulation Mode	2402MHz	2441MHz	2480MHz
BR-1Mbps	7	7	7
EDR-2Mbps	7	7	7
EDR-3Mbps	7	7	7

Test Peripherals:

Equipment	Brand Name	Model	Note
Notebook	HP	6470b	
Mobile Phone	Apple	IPhone 6	
Note: The accessories are used for configuration only and not used during test.			

2. Test Specification

2.1 Instrument list

Radiated Emission					
Used	Equipment	Manufacturer	Type	Internal no.	Due date
<input checked="" type="checkbox"/>	Test Receiver	R&S	ESIB 26	EC 3045	2018-10-18
<input checked="" type="checkbox"/>	Bilog Antenna	TESEQ	CBL 6112D	EC 4206	2018-05-30
<input checked="" type="checkbox"/>	Horn antenna	R&S	HF 906	EC 3049	2018-09-22
<input checked="" type="checkbox"/>	Horn antenna	ETS	3117	EC 4792-1	2018-08-23
<input checked="" type="checkbox"/>	Horn antenna	TOYO	HAP18-26W	EC 4792-3	2020-07-09
<input checked="" type="checkbox"/>	Pre-amplifier	R&S	Pre-amp 18	EC5881	2018-06-19
<input checked="" type="checkbox"/>	Semi-anechoic chamber	Albatross project	-	EC 3048	2018-09-08
RF test					
Used	Equipment	Manufacturer	Type	Internal no.	Due date
<input checked="" type="checkbox"/>	PXA Signal Analyzer	Keysight	N9030A	EC 5338	2018-09-10
<input checked="" type="checkbox"/>	Power sensor	Agilent	U2021XA	EC 5338-1	2018-03-03
<input checked="" type="checkbox"/>	Vector Signal Generator	Agilent	N5182B	EC 5175	2018-03-06
<input checked="" type="checkbox"/>	MXG Analog Signal Generator	Agilent	N5181A	EC 5338-2	2018-03-03
<input checked="" type="checkbox"/>	Mobile Test System	Litepoint	lqxel	EC 5176	2018-01-11
<input checked="" type="checkbox"/>	Test Receiver	R&S	ESCI 7	EC 4501	2018-02-23
Additional instrument					
Used	Equipment	Manufacturer	Type	Internal no.	Due date
<input checked="" type="checkbox"/>	Therom-Hygrograph	ZJ1-2A	S.M.I.F.	EC 3323	2018-06-14
<input checked="" type="checkbox"/>	Therom-Hygrograph	ZJ1-2A	S.M.I.F.	EC 3324	2018-04-09
<input checked="" type="checkbox"/>	Therom-Hygrograph	ZJ1-2A	S.M.I.F.	EC 3325	2018-03-23
<input checked="" type="checkbox"/>	Pressure meter	YM3	Shanghai Mengde	EC 3320	2018-06-28

2.2 Test Standard

47CFR Part 15 (2016)
ANSI C63.10 (2013)
DA 00-705
RSS-247 Issue 2 (February 2017)
RSS-Gen Issue 4 (November 2014)

2.3 Test Summary

This report applies to tested sample only. This report shall not be reproduced in part without written approval of Intertek Testing Service Shanghai Limited.

TEST ITEM	FCC REFERANCE	IC REFERANCE	RESULT
20 dB Bandwidth	15.247(a)(1)	RSS-247 Issue 2 Clause 5	Tested
Carrier Frequency Separation	15.247(a)(1)	RSS-247 Issue 2 Clause 5	Pass
Output power	15.247(b)(1)	RSS-247 Issue 2 Clause 5	Pass
Radiated Spurious Emissions	15.205 & 15.209	RSS-247 Issue 2 Clause 5	Pass
Conducted Spurious Emissions & Band Edge	15.247(d)	RSS-247 Issue 2 Clause 5	Pass
Power line conducted emission	15.207	RSS-Gen Issue 4 Clause 8.8	Pass
Number of Hopping Frequencies	15.247(a)(1)(iii)	RSS-247 Issue 2 Clause 5	Pass
Dwell time	15.247(a)(1)(iii)	RSS-247 Issue 2 Clause 5	Pass
Occupied bandwidth	-	RSS-Gen Issue 4 Clause 6.6	Tested
Spurious emission for receiver	15B	RSS-310 Issue 3 Clause 3.1	NA

Notes: 1: NA =Not Applicable

2: This report is for the exclusive use of Intertek's Client and is provided pursuant to the agreement between Intertek and its Client. Intertek's responsibility and liability are limited to the terms and conditions of the agreement. Intertek assumes no liability to any party, other than to the Client in accordance with the agreement, for any loss, expense or damage occasioned by the use of this report. Only the Client is authorized to permit copying or distribution of this report and then only in its entirety. Any use of the Intertek name or one of its marks for the sale or advertisement of the tested material, product or service must first be approved in writing by Intertek. The observations and test results in this report are relevant only to the sample tested. This report by itself does not imply that the material, product, or service is or has ever been under an Intertek certification program.

2.4 Frequency Hopping System Requirement

Test Requirement: Section 15.247 (a)(1), (g), (h) requirement:

The system shall hop to channel frequencies that are selected at the system hopping rate from a Pseudorandom ordered list of hopping frequencies. Each frequency must be used equally on the average by each transmitter. The system receivers shall have input bandwidths that match the hopping channel bandwidths of their corresponding transmitters and shall shift frequencies in synchronization with the transmitted signals.

Frequency hopping spread spectrum systems are not required to employ all available hopping channels during each transmission. However, the system, consisting of both the transmitter and the receiver, must be designed to comply with all of the regulations in this section should the transmitter be presented with a continuous data (or information) stream. In addition, a system employing short transmission bursts must comply with the definition of a frequency hopping system and must distribute its transmissions over the minimum number of hopping channels specified in this section.

The incorporation of intelligence within a frequency hopping spread spectrum system that permits the system to recognize other users within the spectrum band so that it individually and independently chooses and adapts its hop sets to avoid hopping on occupied channels is permitted. The coordination of frequency hopping systems in any other manner for the express purpose of avoiding the simultaneous occupancy of individual hopping frequencies by multiple transmitters is not permitted.

Compliance for section 15.247(a)(1)

According to Bluetooth Core Specification, the pseudorandom sequence may be generated in a nine stage shift register whose 5th and 9th stage outputs are added in a modulo-two addition stage. And the result is fed back to the input of the first stage. The sequence begins with the first ONE of 9 consecutive ONES;

i.e. the shift register is initialized with nine ones.

- Number of shift register stages: 9
- Length of pseudo-random sequence: $2^9 - 1 = 511$ bits
- Longest sequence of zeros: 8 (non-inverted signal)

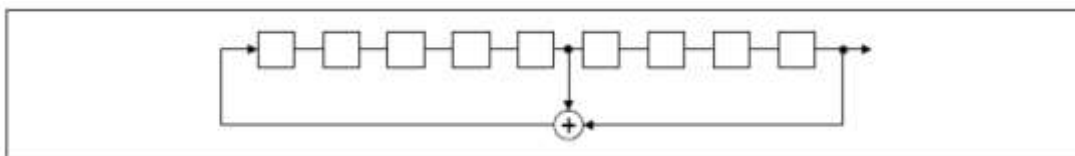

Linear Feedback Shift Register for Generation of the PRBS sequence

An example of Pseudorandom Frequency Hopping Sequence as follow:

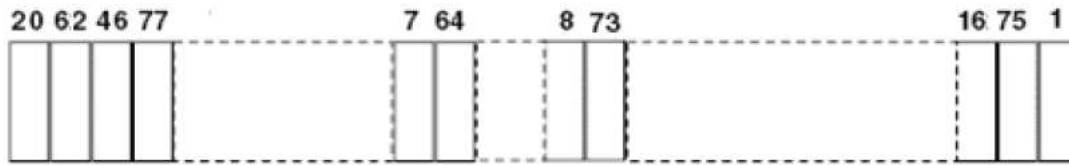

Each frequency used equally on the average by each transmitter.

According to Bluetooth Core Specification, Bluetooth receivers are designed to have input and IF bandwidths that match the hopping channel bandwidths of any Bluetooth transmitters and shift frequencies in synchronization with the transmitted signals.

Compliance for section 15.247(g)

According to Bluetooth Core Specification, the Bluetooth system transmits the packet with the pseudorandom hopping frequency with a continuous data and the short burst transmission from the Bluetooth system is also transmitted under the frequency hopping system with the pseudorandom hopping frequency system.

Compliance for section 15.247(h)

According to Bluetooth Core specification, the Bluetooth system incorporates with an adaptive system to detect other user within the spectrum band so that it individually and independently to avoid hopping on the occupied channels.

According to the Bluetooth Core specification, the Bluetooth system is designed not have the ability to coordinate with other FHSS System in an effort to avoid the simultaneous occupancy of individual hopping frequencies by multiple transmitter.

2.5 Measurement uncertainty

The measurement uncertainty represents an expanded uncertainty expressed at approximately the 95% confidence level using a coverage factor of k=2.

Test item	Measurement uncertainty
Maximum peak output power	± 0.74dB
Radiated Emissions in restricted frequency bands below 1GHz	± 4.90dB
Radiated Emissions in restricted frequency bands above 1GHz	± 5.02dB
Emission outside the frequency band	± 2.89dB
Power line conducted emission	± 3.19dB

3. 20 dB Bandwidth

Test result: Tested

3.1 Limit

- Frequency hopping systems shall have hopping channel carrier frequencies separated by a minimum of 25 kHz or the 20 dB bandwidth of the hopping channel, whichever is greater.
- Frequency hopping systems operating in the 2400–2483.5 MHz band may have hopping channel carrier frequencies that are separated by 25 kHz or two-thirds of the 20 dB bandwidth of the hopping channel, whichever is greater, provided the systems operate with an output power no greater than 125mW.

3.2 Test Configuration

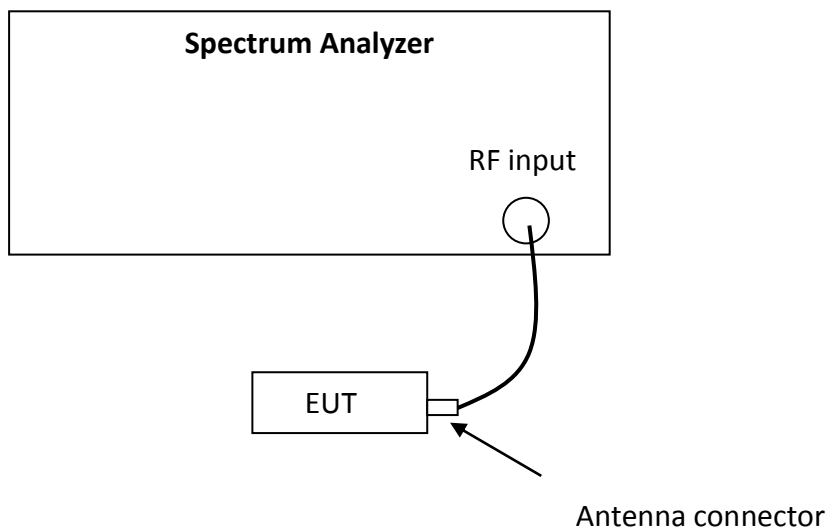

3.3 Test Procedure and test setup

The 20 bandwidth per FCC §15.247(a)(1) is measured using the Spectrum Analyzer with Span = 2 to 3 times the 20 dB bandwidth, RBW \geq 1% of the 20 dB bandwidth, VBW \geq RBW, Sweep = auto, Detector = peak, Trace = max hold.

The test was performed at 3 channels (lowest, middle and highest channel).

The EUT was tested according to DA 00-705 (Filing and Measurement Guidelines for Frequency Hopping Spread Spectrum Systems)

3.4 Test Protocol

Temperature : 25°C
 Relative Humidity : 55 %

Modulation	CH	Bandwidth (kHz)	Two-thirds of Bandwidth (kHz)
GFSK	L	947.8	631.87
	M	943.1	628.73
	H	944.8	629.87

Channel L



Channel M



Channel H



Modulation	CH	Bandwidth (kHz)	Two-thirds of Bandwidth (kHz)
$\pi/4$ DQPSK	L	1269	846.00
	M	1238	825.33
	H	1239	826.00

Channel L

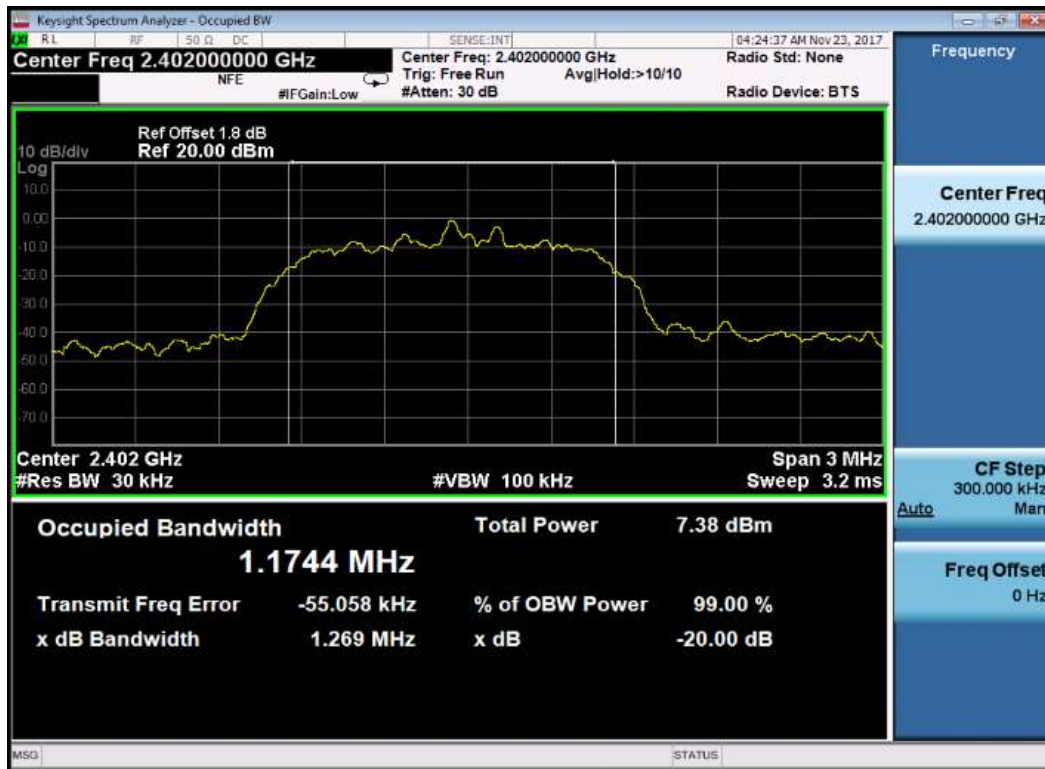

Channel M



Channel H

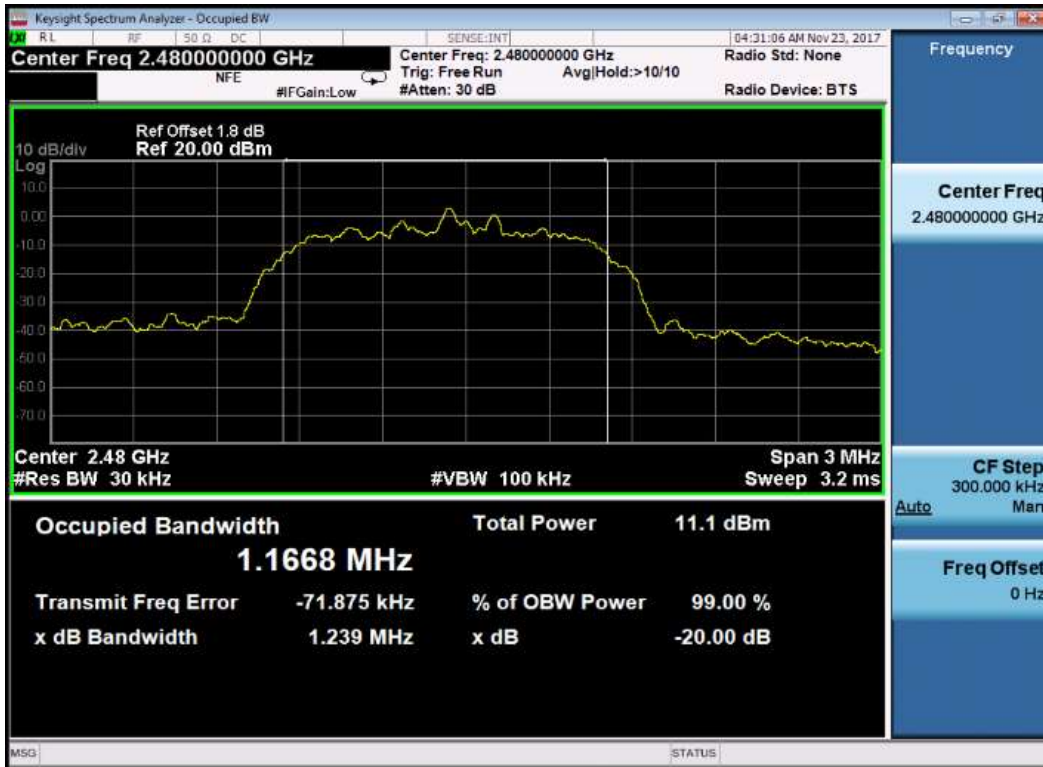

Modulation	CH	Bandwidth (kHz)	Two-thirds of Bandwidth (kHz)
8DPSK	L	1268	845.33
	M	1257	838.00
	H	1257	838.00

Channel L

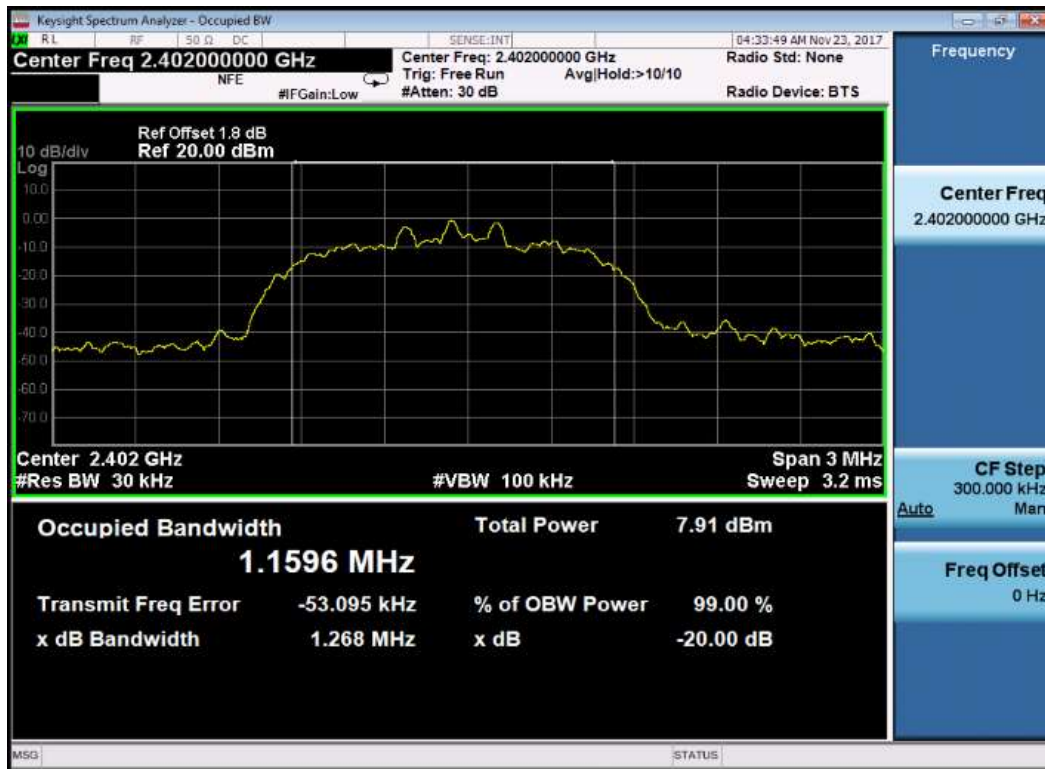

Channel M



Channel H

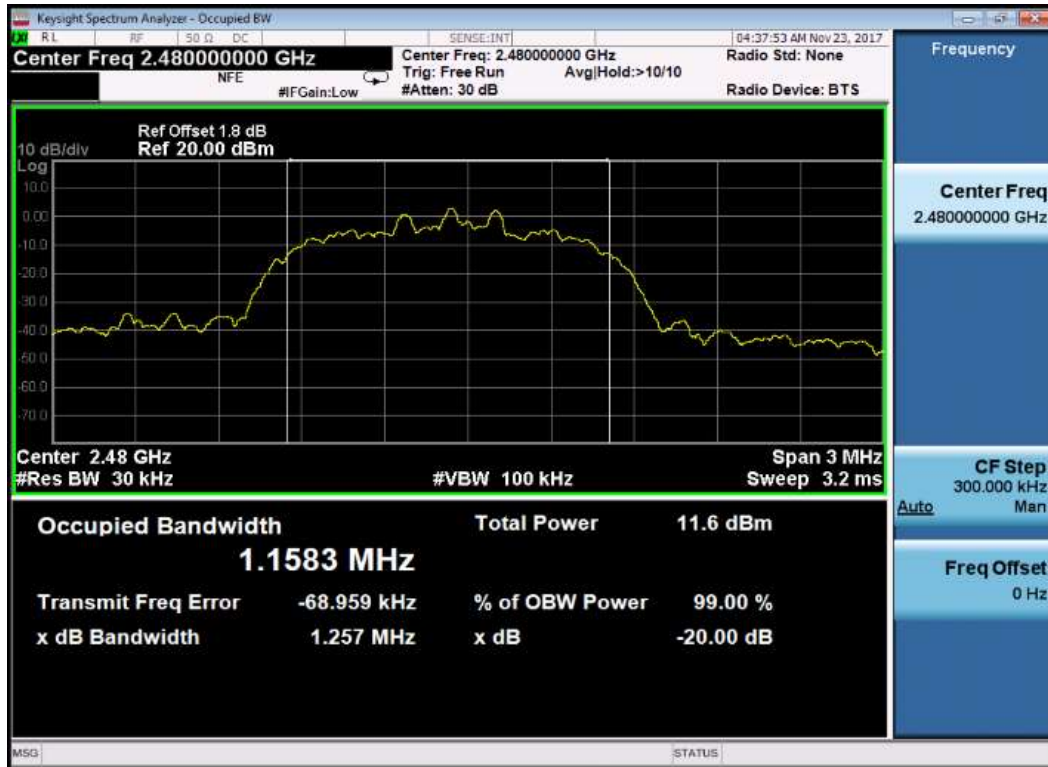

4. Carrier Frequency Separation

Test result: Pass

4.1 Limit

- Frequency hopping systems shall have hopping channel carrier frequencies separated by a minimum of 25kHz or the 20 dB bandwidth of the hopping channel, whichever is greater.
- Frequency hopping systems operating in the 2400–2483.5 MHz band may have hopping channel carrier frequencies that are separated by 25 kHz or two-thirds of the 20 dB bandwidth of the hopping channel, whichever is greater, provided the systems operate with an output power no greater than 125mW.

4.2 Test Configuration

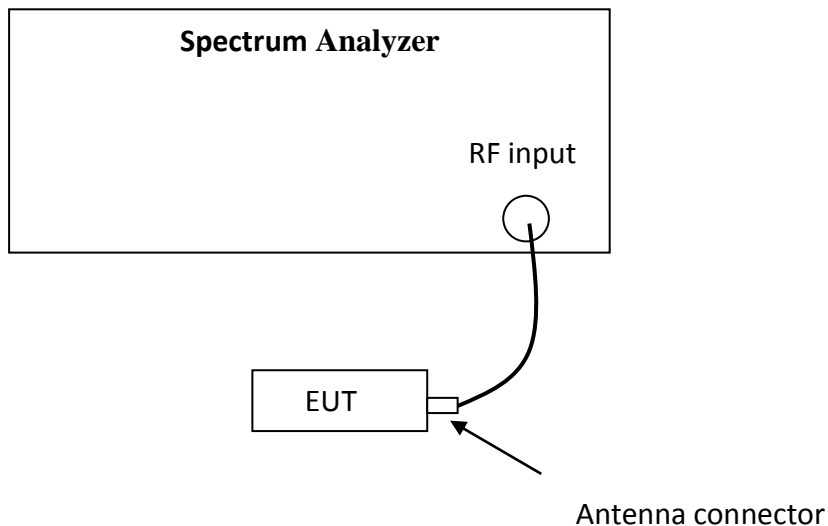

4.3 Test Procedure and test setup

The Carrier Frequency Separation per FCC §15.247(a)(1) is measured using the Spectrum Analyzer with Span can capture two adjacent channels, $RBW \geq 1\%$ of the span, $VBW \geq RBW$, Sweep = auto, Detector = peak, Trace = max hold.

The test was performed at 3 channels (lowest, middle and highest channel).

The EUT was tested according to DA 00-705 (Filing and Measurement Guidelines for Frequency Hopping Spread Spectrum Systems)

4.4 Test Protocol

Temperature : 25°C
Relative Humidity : 55 %

Mode	CH	Frequency Separation (kHz)	Limit \geq Two-thirds of Bandwidth
GFSK	L	1079	Pass
	M	973	Pass
	H	999	Pass

Channel L



Channel M



Channel H

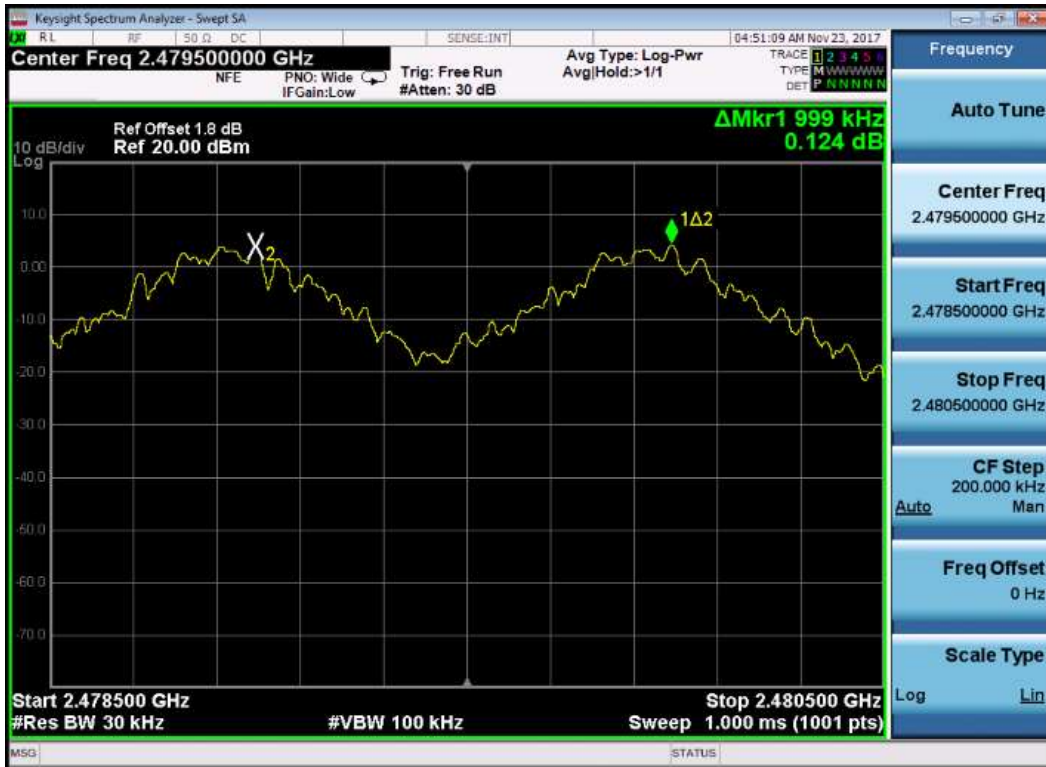

Mode	CH	Frequency Separation (kHz)	Limit \geq Two-thirds of Bandwidth
$\pi/4$ DQPSK	L	829	Pass
	M	849	Pass
	H	1171	Pass

Channel L



Channel M



Channel H

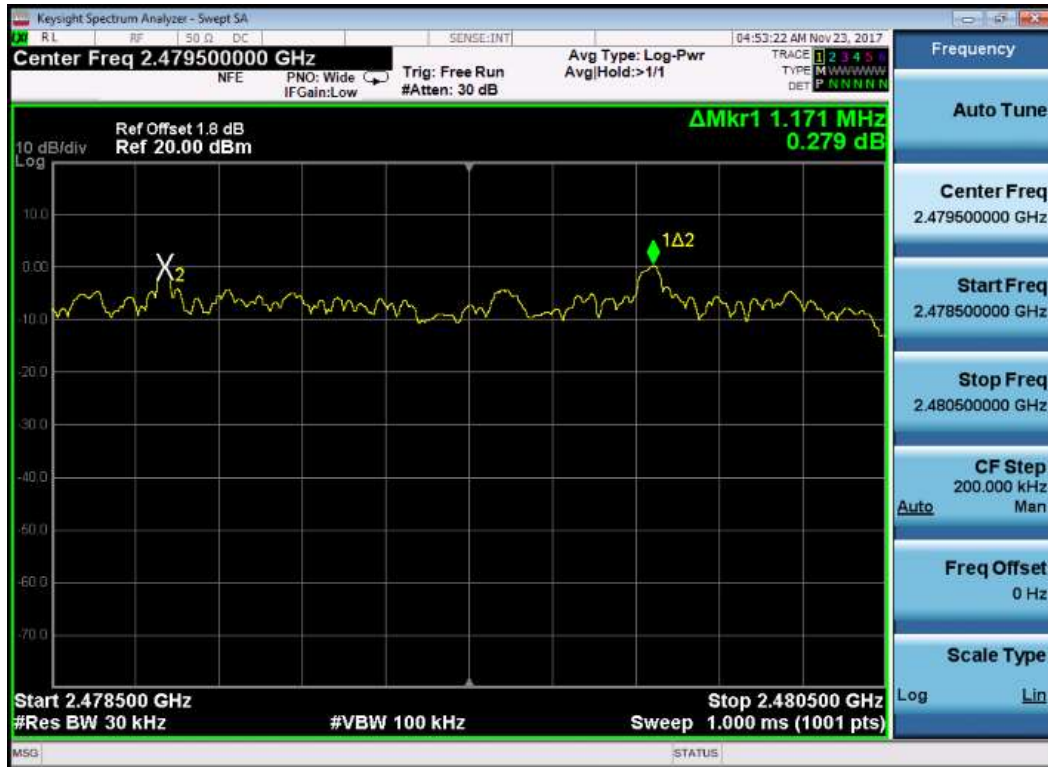

Mode	CH	Frequency Separation (kHz)	Limit (kHz)
8DPSK	L	979	≥ 820.0
	M	983	≥ 820.7
	H	1121	≥ 820.0

Channel L



Channel M



Channel H



5. Maximum peak output power

Test result: Pass

5.1 Test limit

For frequency hopping systems operating in the 2400-2483.5 MHz band employing at least 75 non-overlapping hopping channels, and all frequency hopping systems in the 5725-5850 MHz band: 1 watt

For all other frequency hopping systems in the 2400-2483.5 MHz band: 0.125 watts
If the transmitting antenna of directional gain greater than 6dBi is used, the power shall be reduced by the amount in dB that the directional gain of the antenna exceeds 6dBi.
For systems using digital modulation in the 902-928 MHz, 2400-2483.5 MHz, and 5725-5850 MHz bands: 1 Watt.

5.2 Test Configuration

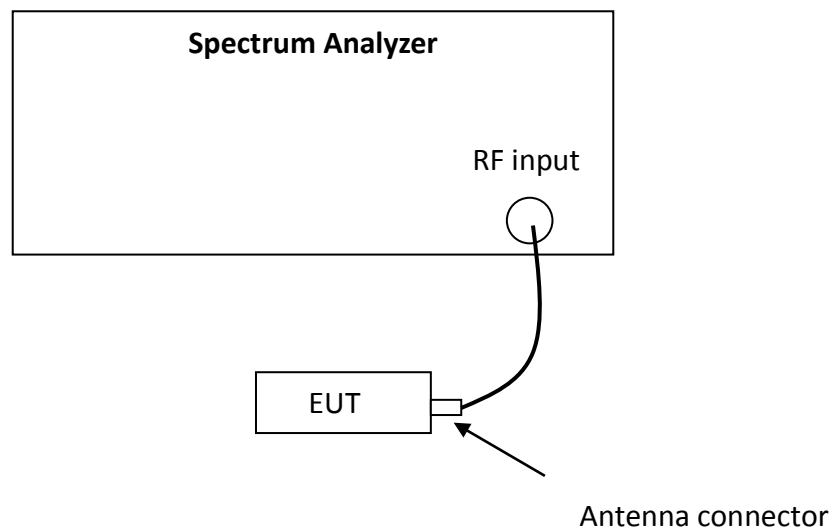

5.3 Test procedure and test setup

The power output per FCC §15.247(b) is measured using the Spectrum Analyzer with Span = 5 times the 20 dB bandwidth, RBW \geq the 20 dB bandwidth, VBW \geq RBW, Sweep = auto, Detector = peak, Trace = max hold.

The test was performed at 3 channels (lowest, middle and highest channel).

The EUT was tested according to DA 00-705 (Filing and Measurement Guidelines for Frequency Hopping Spread Spectrum Systems)

5.4 Test protocol

Temperature : 25 °C
 Relative Humidity : 55 %

Mode	CH	Cable loss (dB)	Corrected reading (dBm)	Limit (dBm)
GFSK (DH5)	L	1.80	4.21	≤21.00
	M	1.80	6.97	
	H	1.80	7.26	

Channel L



Channel M



Channel H



Mode	CH	Cable loss (dB)	Corrected reading (dBm)	Limit (dBm)
$\pi/4$ DQPSK (2DH5)	L	1.80	1.94	≤21.00
	M	1.80	5.32	
	H	1.80	5.56	

Channel L



Channel M



Channel H



Mode	CH	Cable loss (dB)	Corrected reading (dBm)	Limit (dBm)
8DPSK (3DH5)	L	1.80	2.29	≤21.00
	M	1.80	5.63	
	H	1.80	5.89	

Channel L



Channel M



Channel H



6. Radiated Spurious Emissions

Test result: Pass

6.1 Test limit

The radiated emissions which fall in the restricted bands, as defined in §15.205(a), must also comply with the radiated emission limits specified in §15.209(a) showed as below:

Frequency (MHz)	Field Strength (dBuV/m)	Measurement Distance (m)
30 - 88	40.0	3
88 - 216	43.5	3
216 - 960	46.0	3
Above 960	54.0	3

6.2 Test Configuration

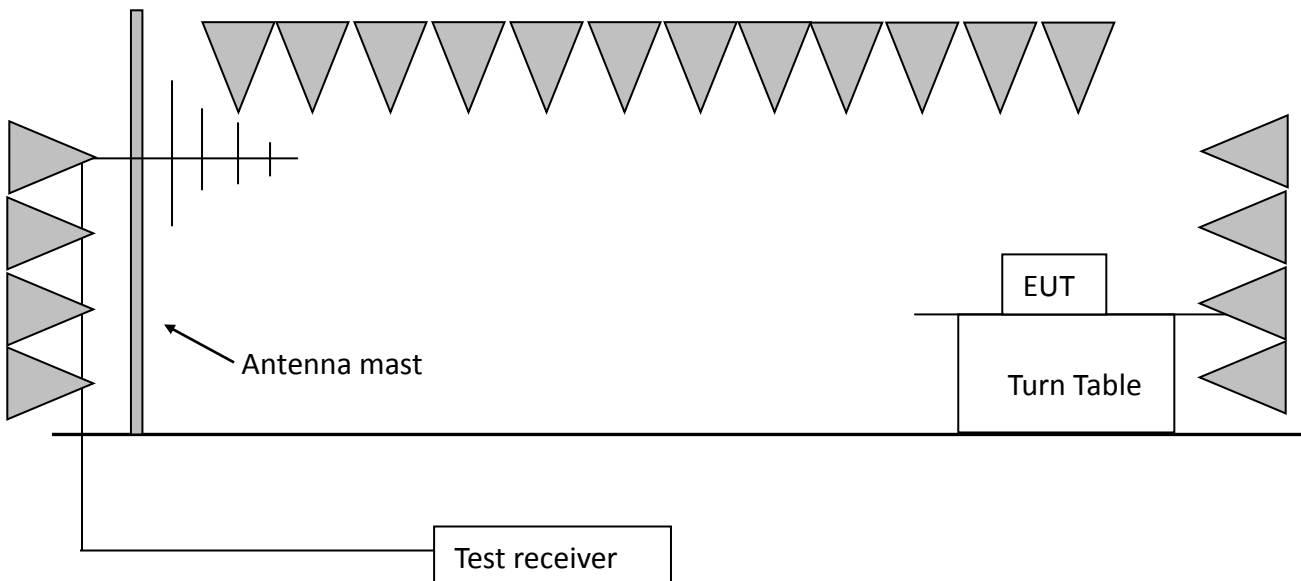

6.3 Test procedure and test setup

The measurement was applied in a semi-anechoic chamber. While testing for spurious emission higher than 1GHz, if applied, the pre-amplifier would be equipped just at the output terminal of the antenna.

Tabletop devices shall be placed on a nonconducting platform with nominal top surface dimensions 1 m by 1.5 m. For emissions testing at or below 1 GHz, the table height shall be 80 cm above the reference ground plane. For emission measurements above 1 GHz, the table height shall be 1.5 m.

The turn table rotated 360 degrees to determine the position of the maximum emission level. The EUT was set 3 meters away from the receiving antenna which was mounted on an antenna mast. The antenna moved up and down between from 1meter to 4 meters to find out the maximum emission level.

The EUT was tested according to DA 00-705 (Filing and Measurement Guidelines for Frequency Hopping Spread Spectrum Systems)

The radiated emission was measured using the Spectrum Analyzer with the resolutions bandwidth set as:

RBW = 100 kHz, VBW = 300 kHz (30MHz~1GHz)
RBW = 1MHz, VBW = 3MHz (>1GHz for PK);

- Remark:
1. For fundamental emission, no amplifier is employed.
 2. Correct Factor = Antenna Factor + Cable Loss (-Amplifier, is employed)
 3. Corrected Reading = Original Receiver Reading + Correct Factor
 4. Margin = limit – Corrected Reading
 5. If the PK reading is lower than AV limit, the AV test can be elided.
 6. The emission was conducted from 30MHz to 25GHz.

Example: Assuming Antenna Factor = 30.20dB/m, Cable Loss = 2.00dB,
Gain of Preamplifier = 32.00dB, Original Receiver Reading = 10dBuV.
Then Correct Factor = 30.20 + 2.00 – 32.00 = 0.20dB/m; Corrected Reading = 10dBuV
+ 0.20dB/m = 10.20dBuV/m
Assuming limit = 54dBuV/m, Corrected Reading = 10.20dBuV/m, then Margin = 54 -
10.20 = 43.80dBuV/m

6.4 Test protocol

Temperature : 25 °C
Relative Humidity : 55 %

The low frequency, which started from 9 kHz to 30MHz, was pre-scanned and the result which was 20dB lower than the limit line per 15.31(o) was not reported.

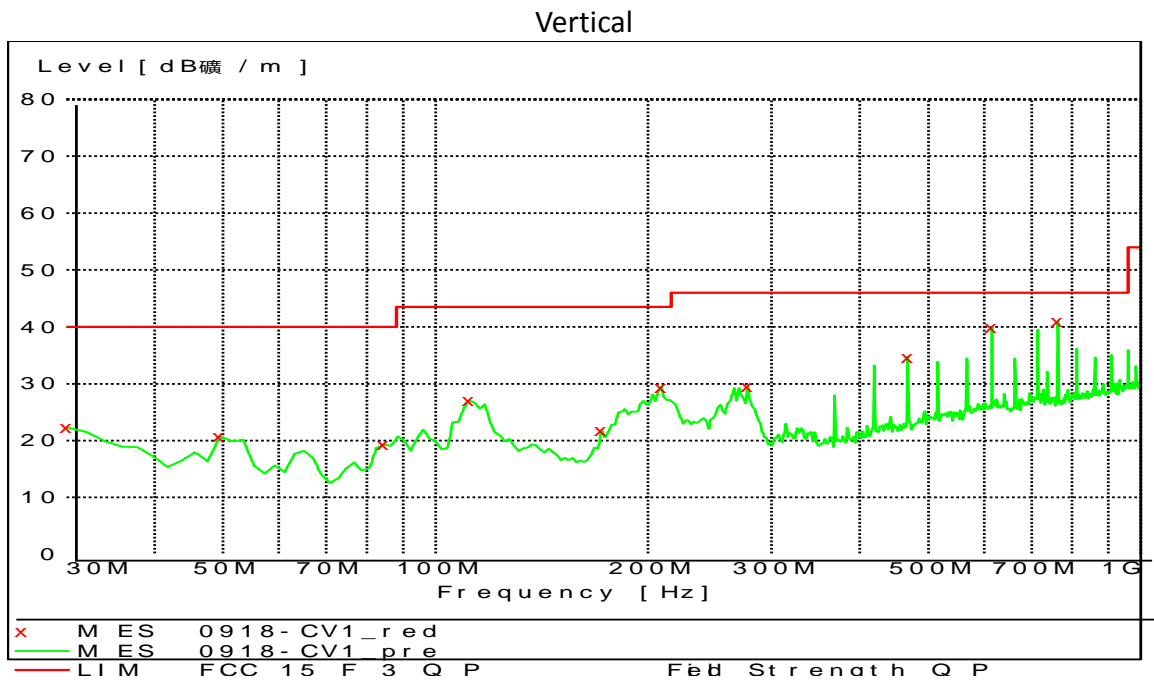
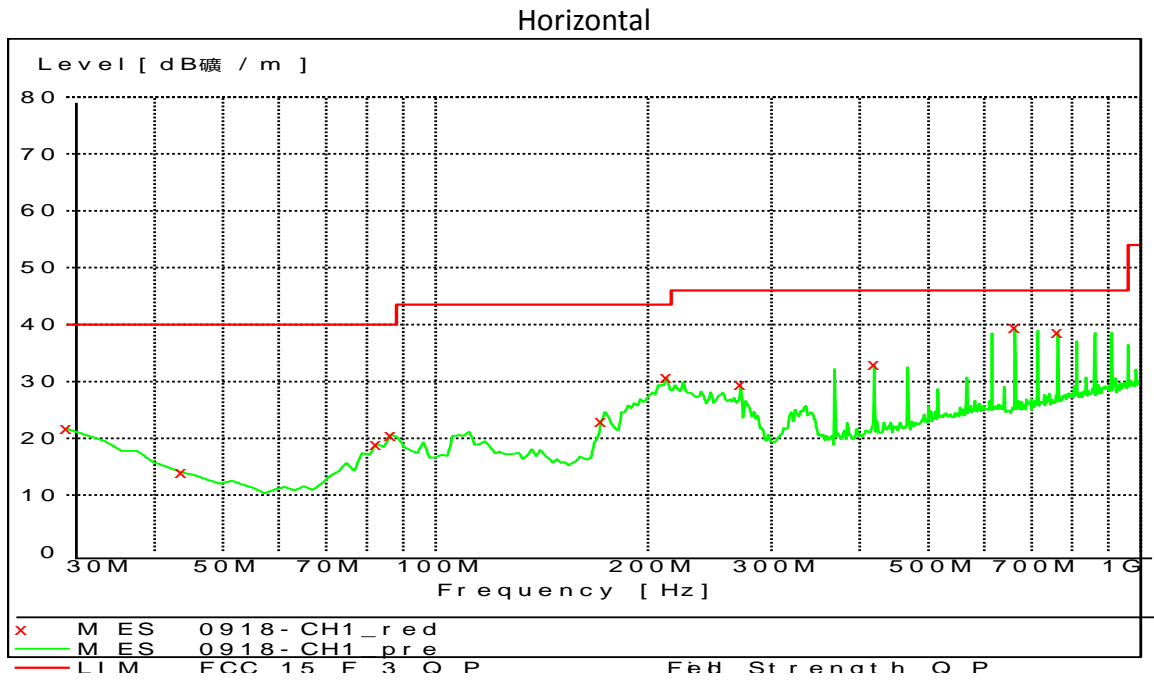

Test data 30MHz~1GHz:

Polarization	Frequency (MHz)	Measured level (dBμV/m)	Limits (dBμV/m)	Margin (dB)	Detector
H	30.00	21.7	40.0	18.3	PK
	43.61	14.0	40.0	26.0	PK
	82.48	19.0	40.0	21.0	PK
	86.37	20.6	40.0	19.4	PK
	171.90	23.0	43.5	20.5	PK
	212.73	30.7	43.5	12.8	PK
	271.04	29.5	46.0	16.5	PK
	418.78	32.9	46.0	13.1	PK
	663.71	39.4	46.0	6.6	PK
	762.85	38.6	46.0	7.4	PK
V	30.00	22.3	40.0	17.7	PK
	49.44	20.8	40.0	19.2	PK
	84.43	19.3	40.0	20.7	PK
	111.64	27.0	43.5	16.5	PK
	171.90	21.8	43.5	21.7	PK
	208.84	29.4	43.5	14.1	PK
	276.87	29.6	46.0	16.4	PK
	467.37	34.7	46.0	11.3	PK
	615.11	40.0	46.0	6.0	PK
	762.85	41.0	46.0	5.0	PK

Test Data (>1GHz):

GFSK (DH5) Modulation:

H	Antenna	Frequency (MHz)	Correct Factor (dB/m)	Corrected Reading (dBuV/m)	Limit (dBuV/m)	Margin (dB)	Detector
L	H	2402.00	30.70	93.60	Fundamental	/	PK
	H	2389.90	30.20	47.40	74.00	26.60	PK
	H	2389.90	30.20	38.30	54.00	15.70	AV
	H	4804.00	-1.50	44.20	74.00	29.80	PK
M	V	2441.00	30.70	96.80	Fundamental	/	PK
	V	4882.00	-1.10	44.30	74.00	29.70	PK
H	H	2480.00	30.70	98.60	Fundamental	/	PK
	V	2483.50	31.52	50.30	74.00	23.70	PK
	V	2483.50	31.52	42.60	54.00	11.40	AV
	V	4960.00	-0.80	44.60	74.00	29.40	PK

$\pi/4$ DQPSK (2DH5) Modulation:

CH	Antenna	Frequency (MHz)	Correct Factor (dB/m)	Corrected Reading (dBuV/m)	Limit (dBuV/m)	Margin (dB)	Detector
L	H	2402.00	30.70	92.30	Fundamental	/	PK
	H	2389.98	30.20	44.10	74.00	29.90	PK
	H	2389.98	30.20	38.50	54.00	15.50	AV
	H	4804.00	-1.50	41.80	74.00	32.20	PK
M	V	2441.00	30.70	95.60	Fundamental	/	PK
	V	4882.00	-1.10	43.20	74.00	30.80	PK
H	H	2480.00	30.70	95.30	Fundamental	/	PK
	V	2483.50	31.52	48.20	74.00	25.80	PK
	V	2483.50	31.52	43.30	54.00	10.70	AV
	V	4960.00	-0.80	42.50	74.00	31.50	PK

8DPSK (3DH5) Modulation:

CH	Antenna	Frequency (MHz)	Correct Factor (dB/m)	Corrected Reading (dBuV/m)	Limit (dBuV/m)	Margin (dB)	Detector
L	H	2402.00	30.70	92.30	Fundamental	/	PK
	H	2389.93	30.20	41.30	74.00	32.70	PK
	H	2389.93	30.20	36.10	54.00	17.90	AV
	H	4804.00	-1.50	44.50	74.00	29.50	PK

M	V	2441.00	30.70	94.30	Fundamental	/	PK
	V	4882.00	-1.10	44.20	74.00	29.80	PK
H	H	2480.00	30.70	93.40	Fundamental	/	PK
	V	2483.50	31.52	48.40	74.00	25.60	PK
	V	2483.50	31.52	42.30	54.00	11.70	AV
	V	4960.00	-0.80	43.60	74.00	30.40	AV

7. Conducted Spurious Emissions & Band Edge

Test result: Pass

7.1 Limit

In any 100 kHz bandwidth outside the frequency band in which the spread spectrum intentional radiator is operating, the radio frequency power that is produced by the intentional radiator shall be at least 20 dB below that in the 100 kHz bandwidth within the band that contains the highest level of the desired power.

7.2 Test Configuration

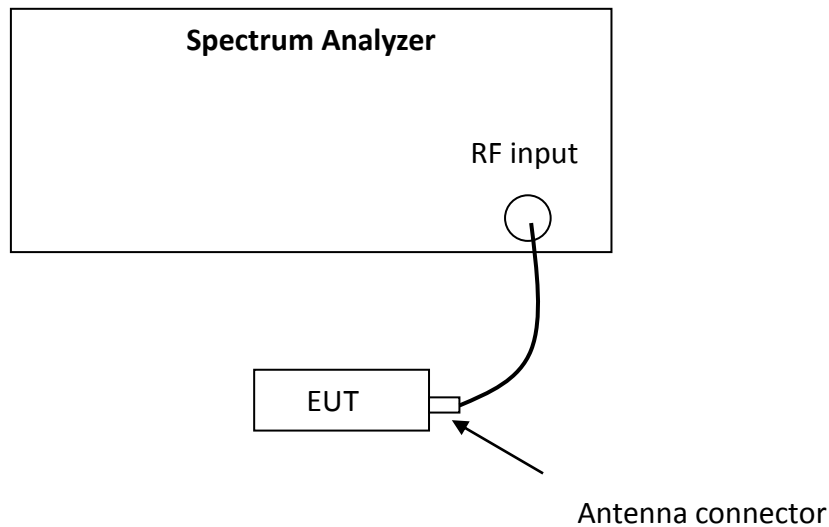

7.3 Test procedure and test setup

The Conducted Spurious Emissions per FCC §15.247(d) is measured using the Spectrum Analyzer with Span wide enough capturing all spurious from the lowest emission frequency of the EUT up to 10th harmonics, RBW = 100kHz, VBW \geq RBW, Sweep = auto, Detector = peak, Trace = max hold.

The test was performed at 3 channels (lowest, middle and highest channel).

The EUT was tested according to DA 00-705 (Filing and Measurement Guidelines for Frequency Hopping Spread Spectrum Systems)

7.4 Test protocol

Temperature : 25 °C
 Relative Humidity : 55 %

GFSK Channel- L



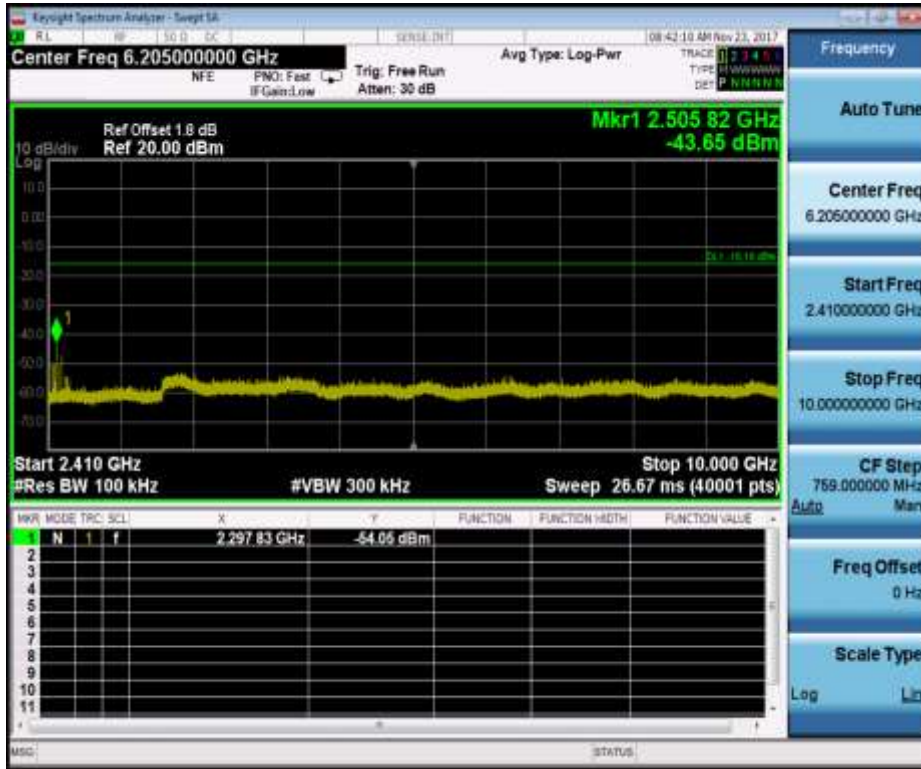

GFSK Channel- M

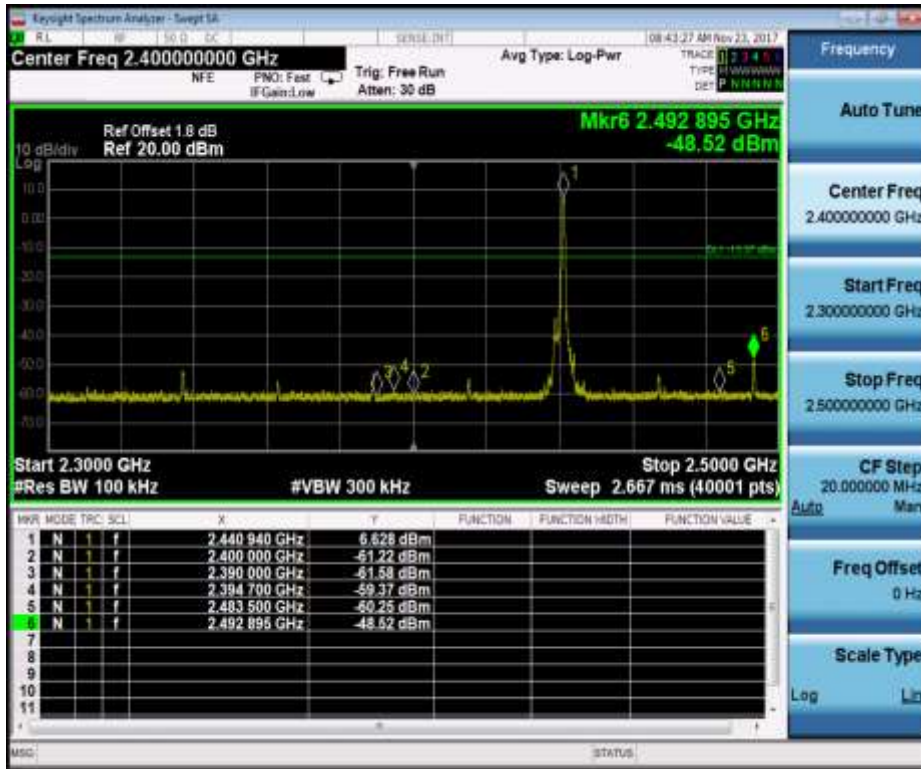

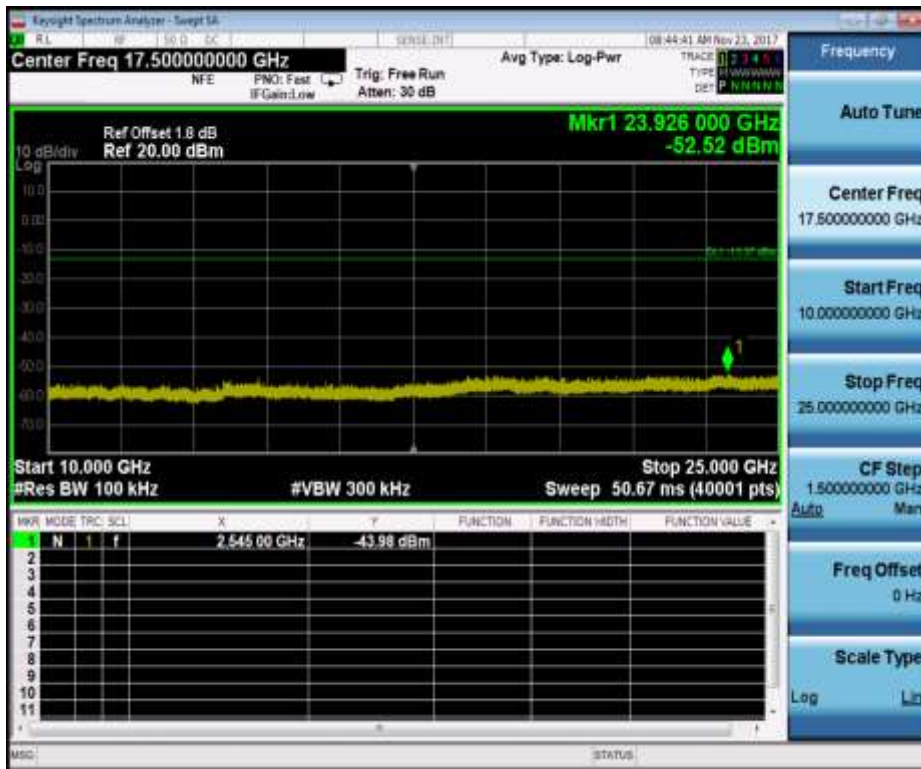
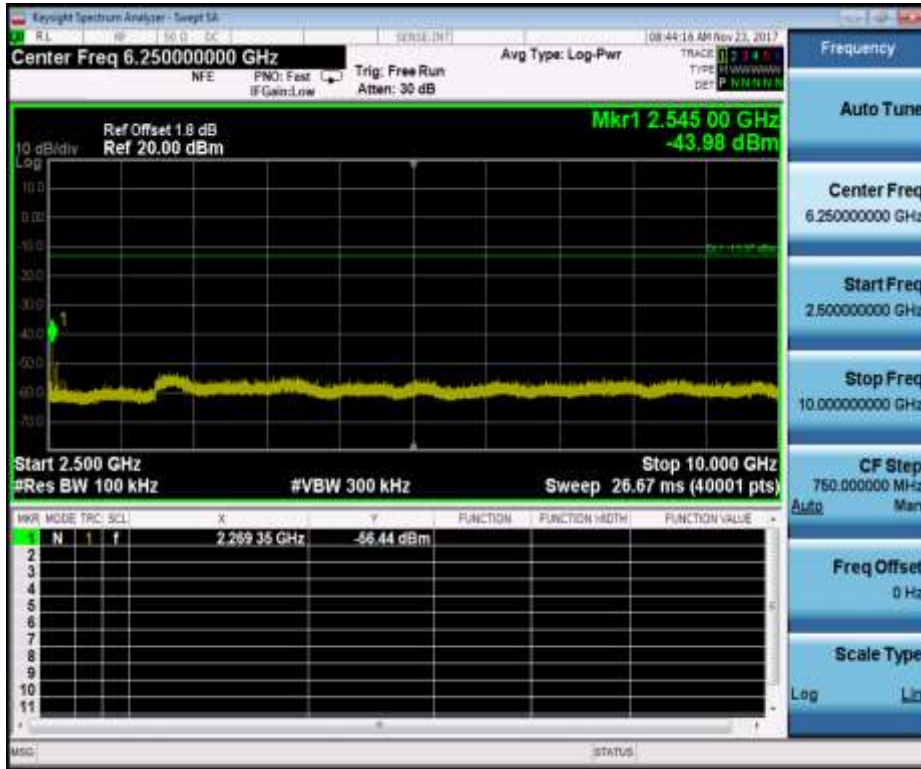

GFSK Channel- H

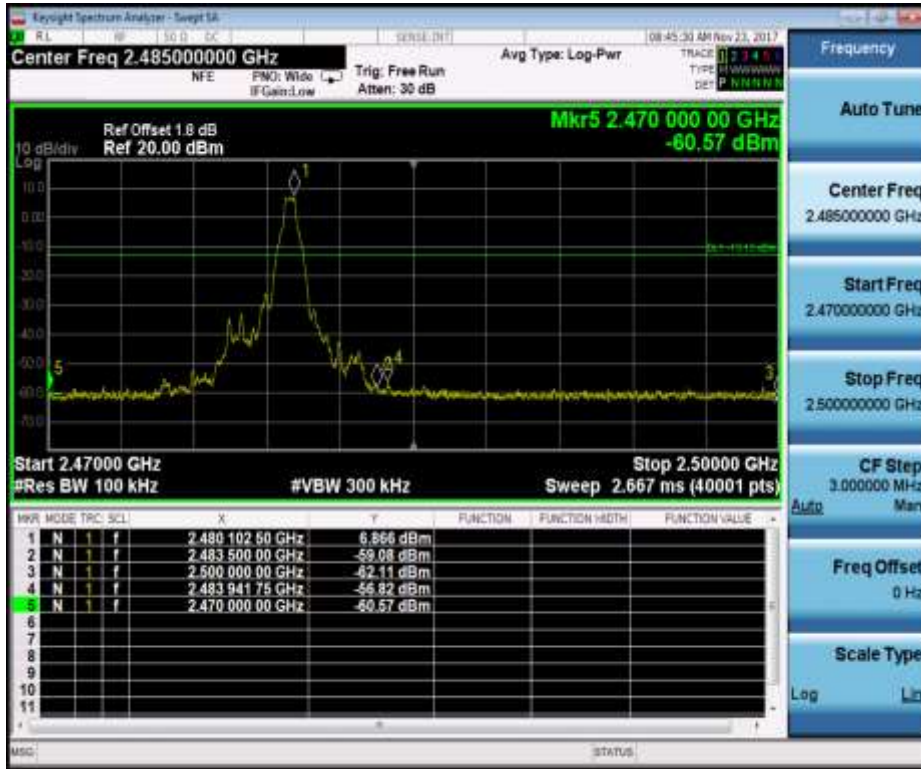

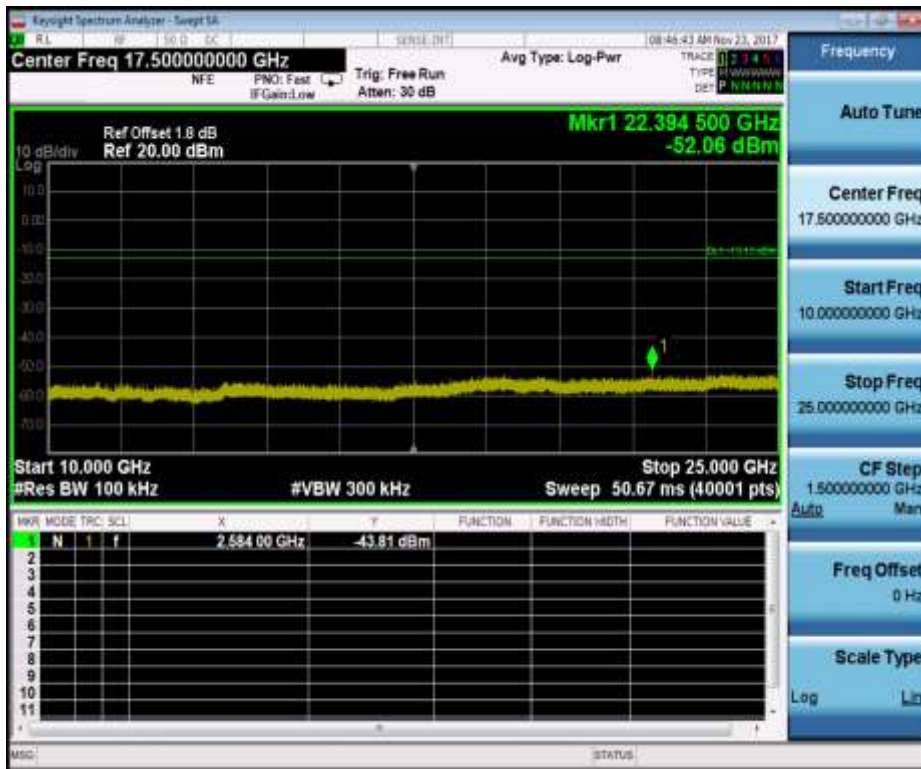
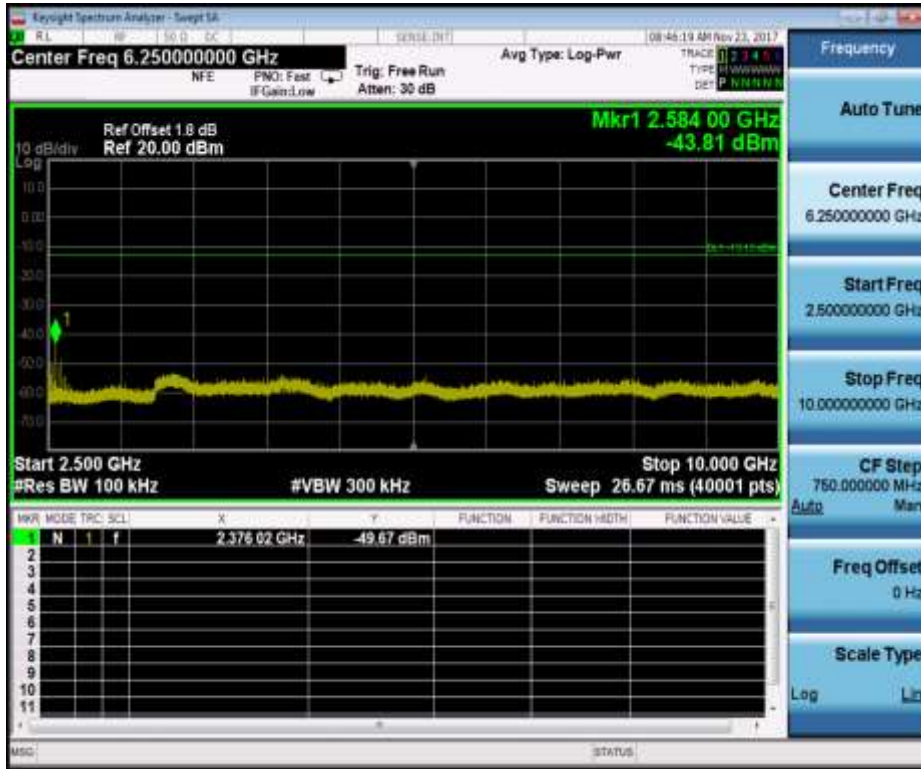

$\pi/4$ DQPSK Channel- L

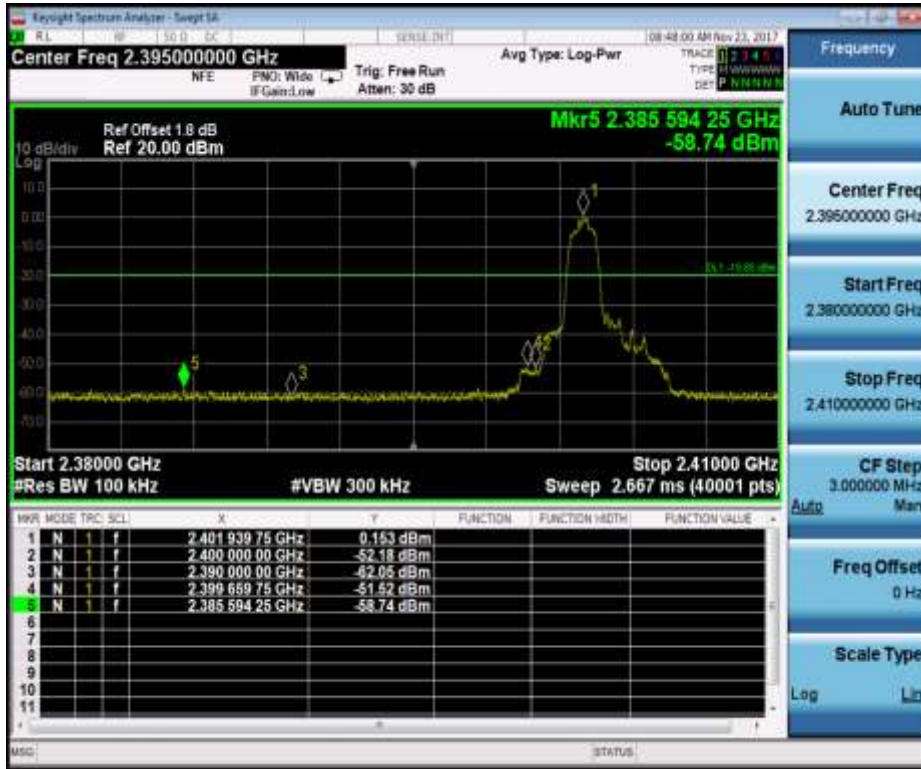

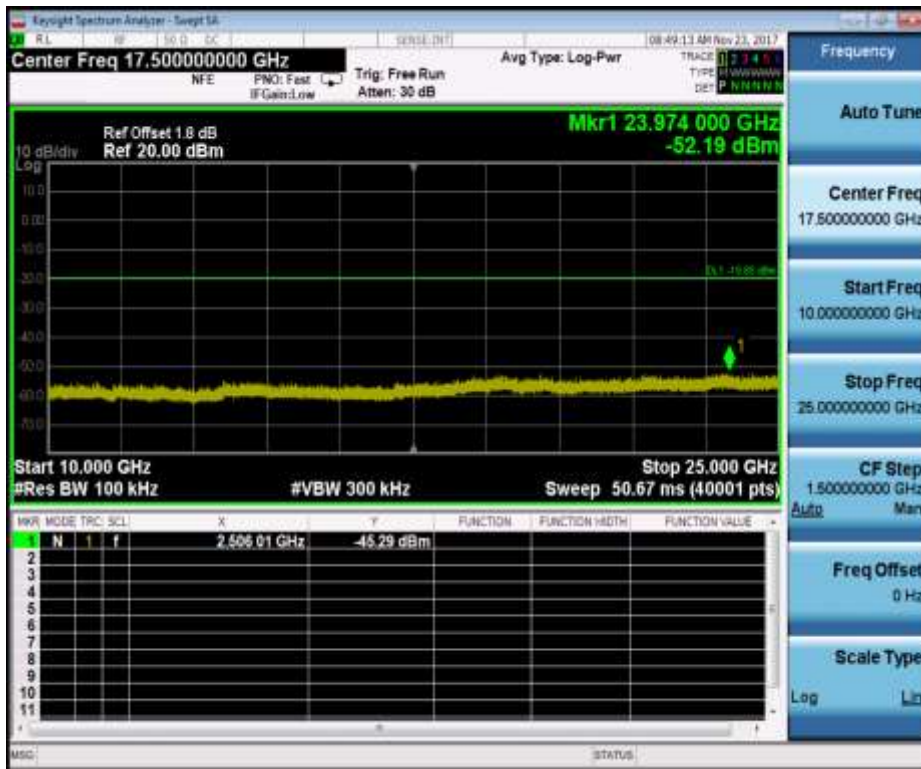
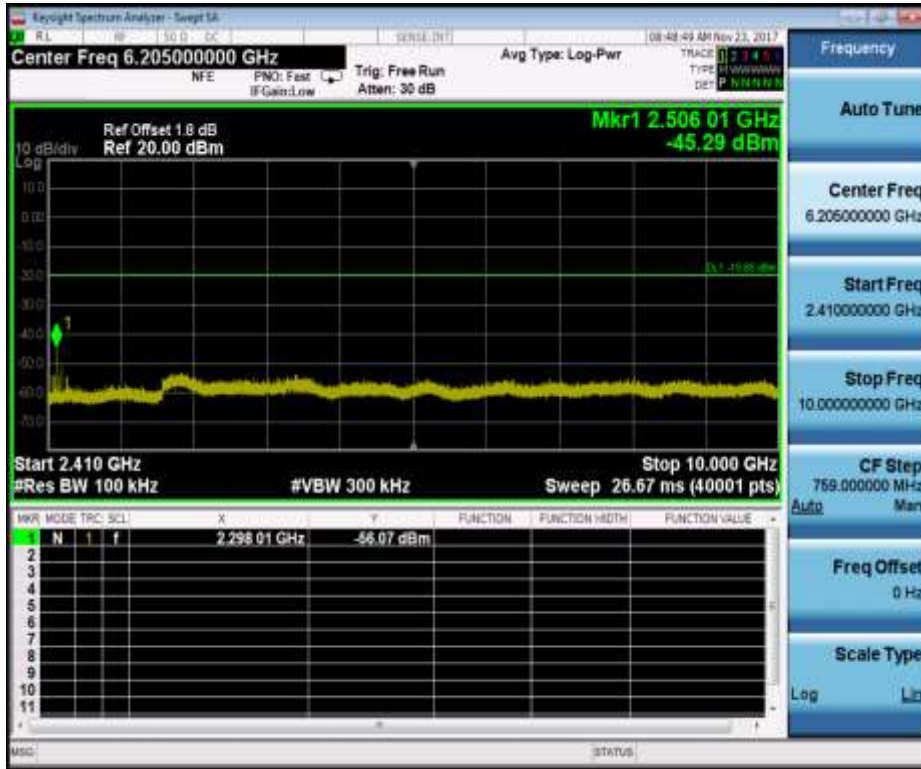

$\pi/4$ DQPSK Channel- M

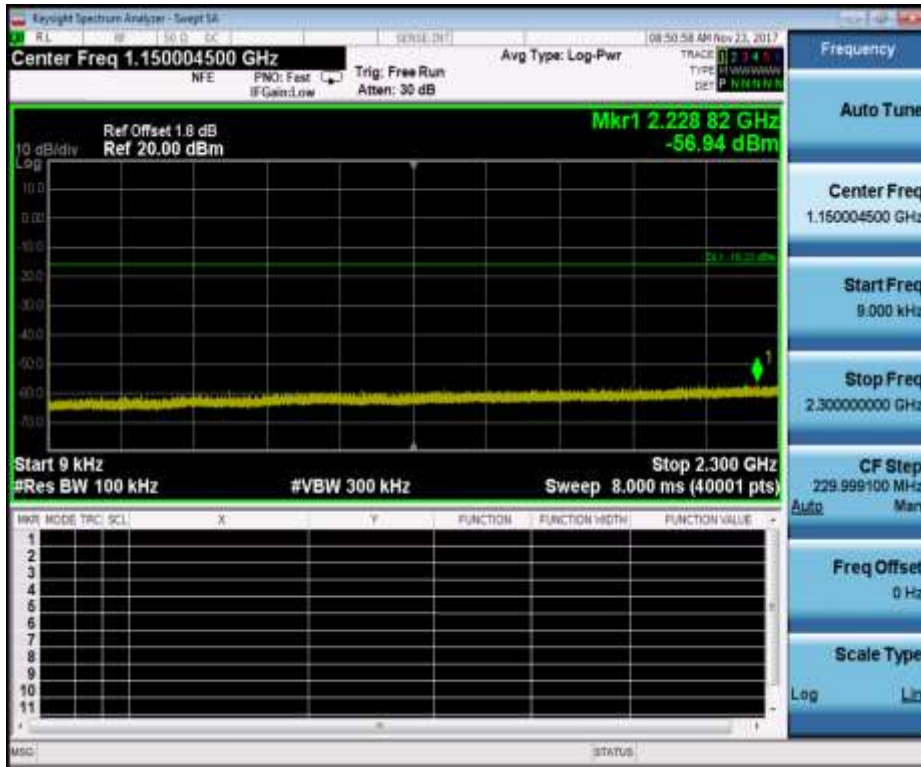
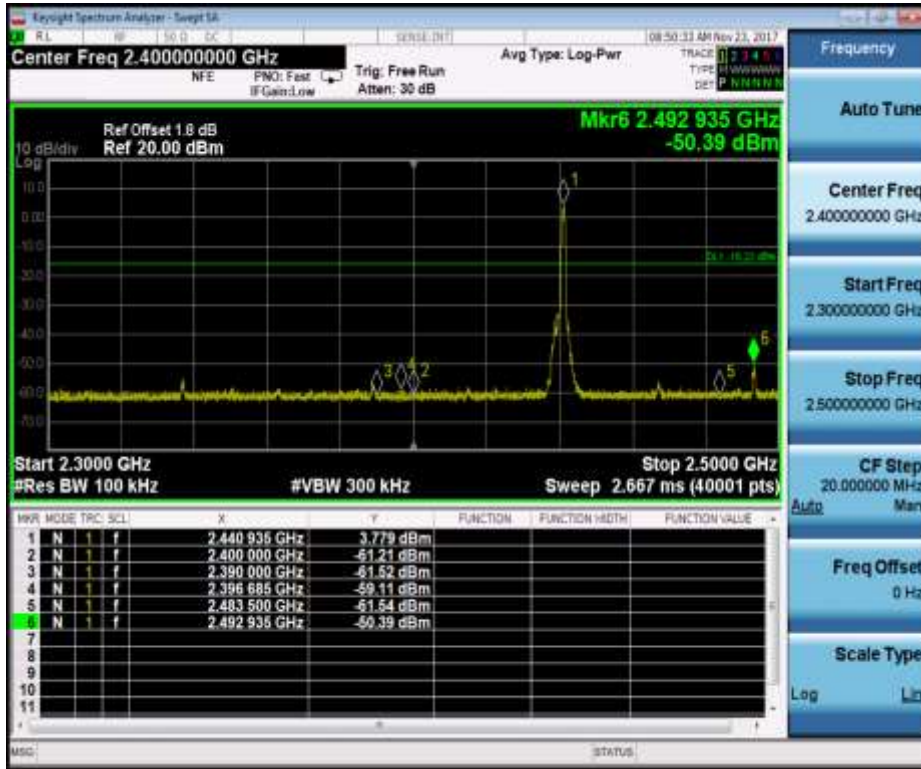

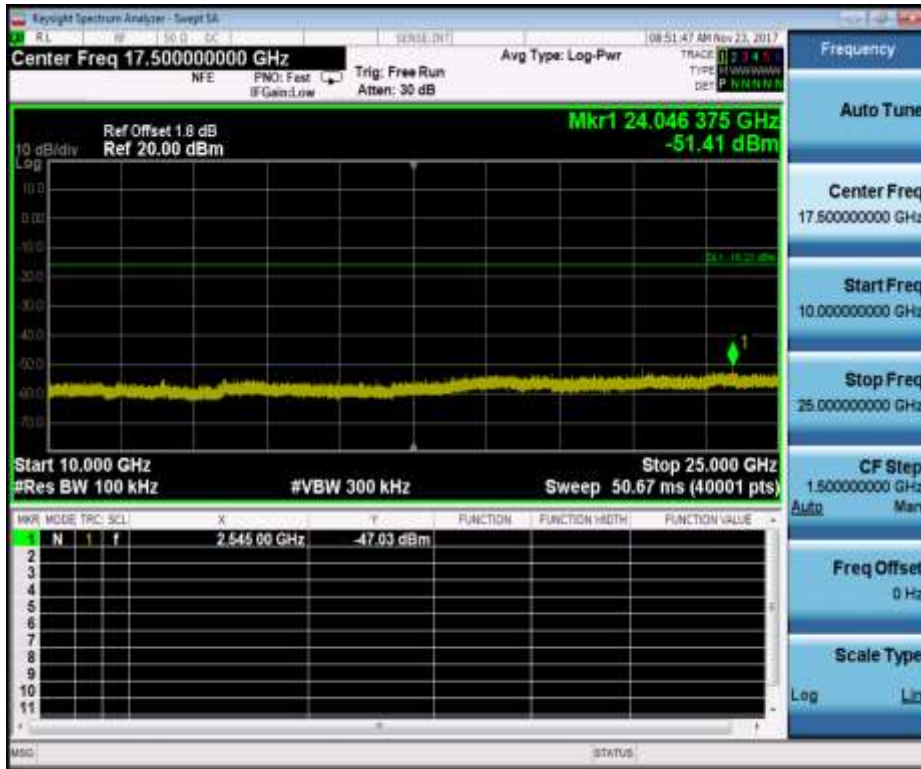
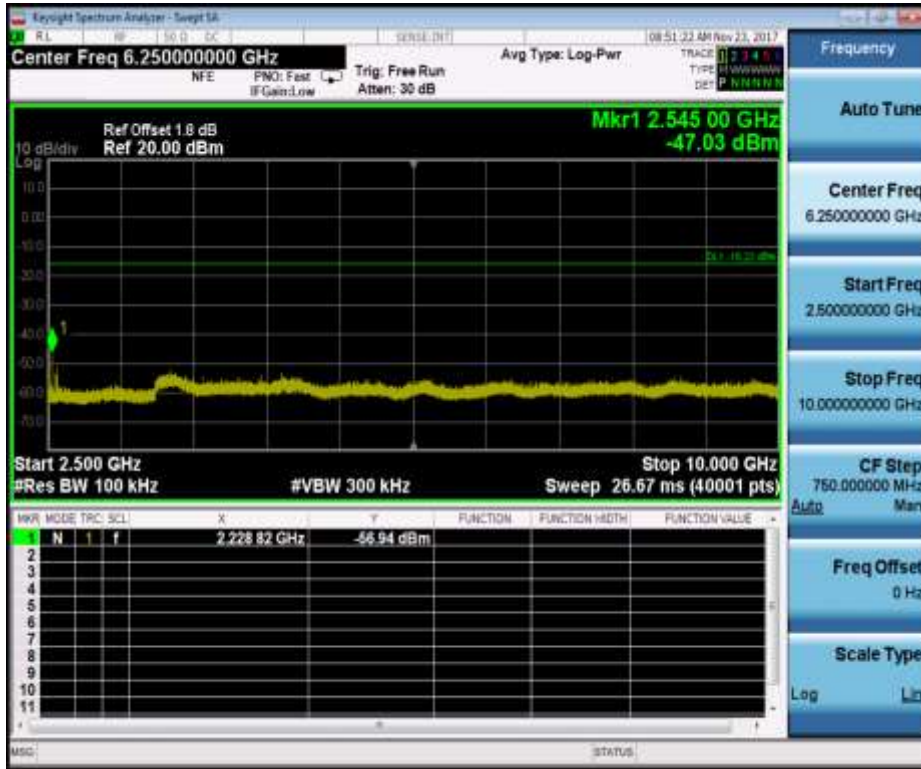

$\pi/4$ DQPSK Channel- H

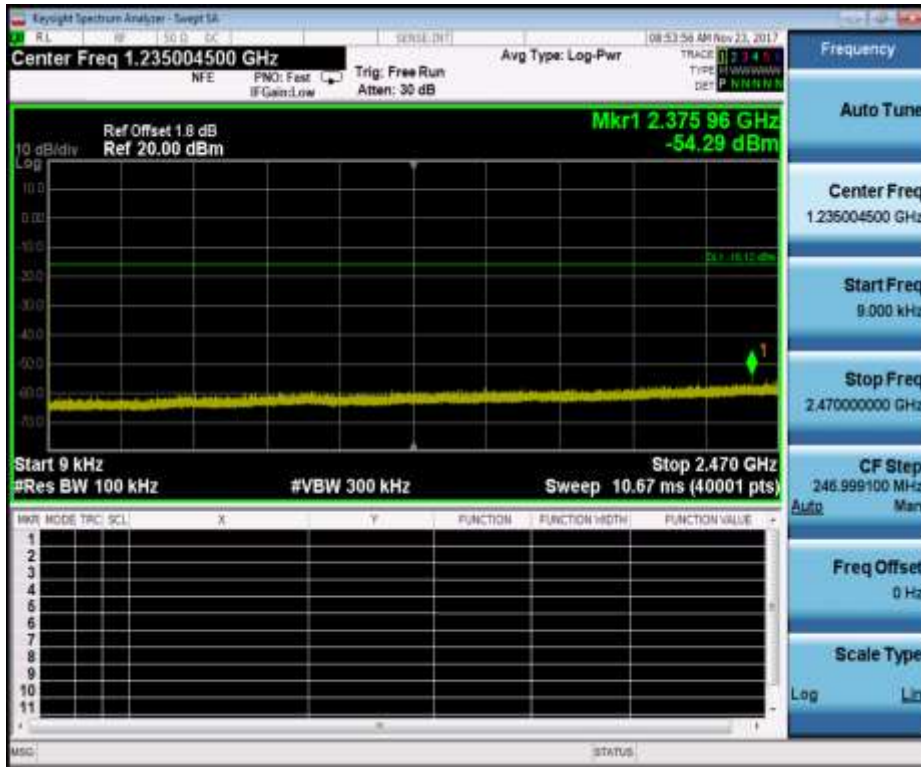
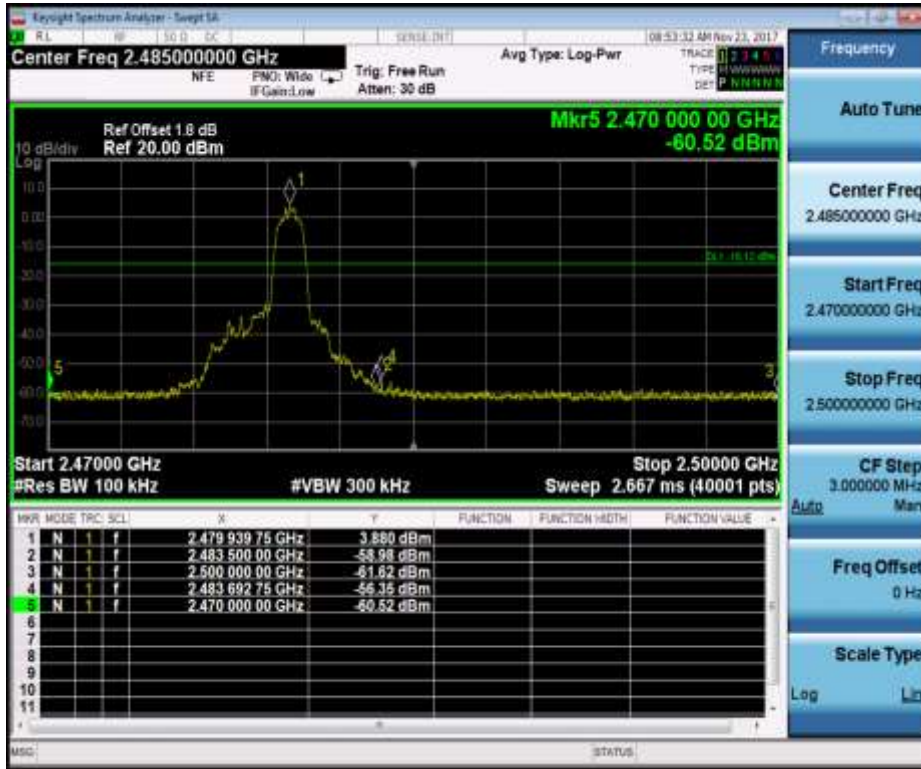

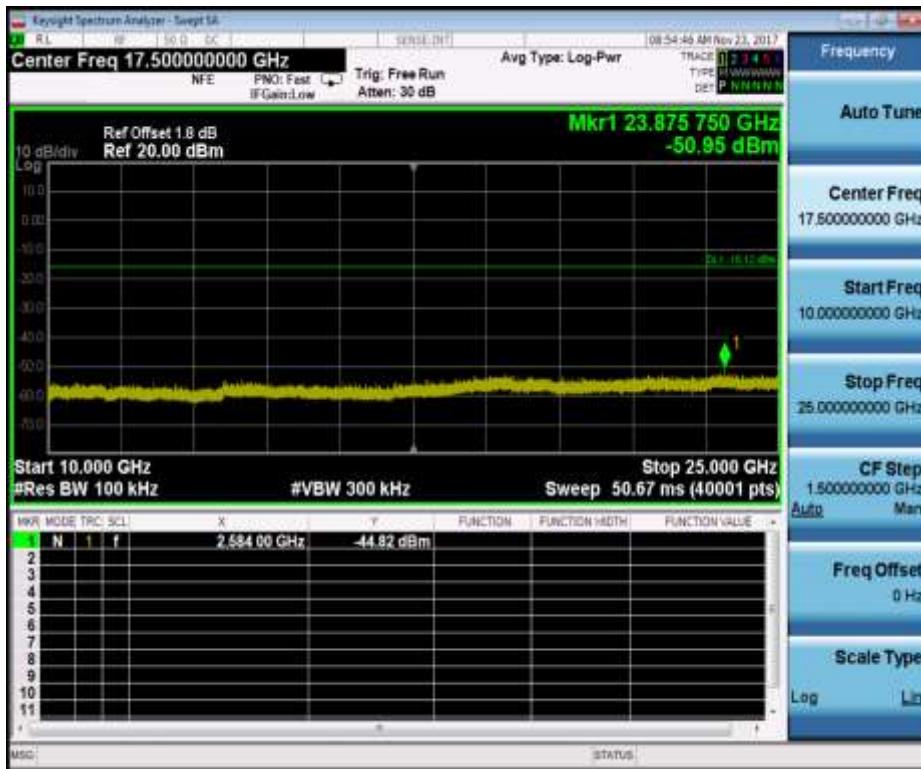
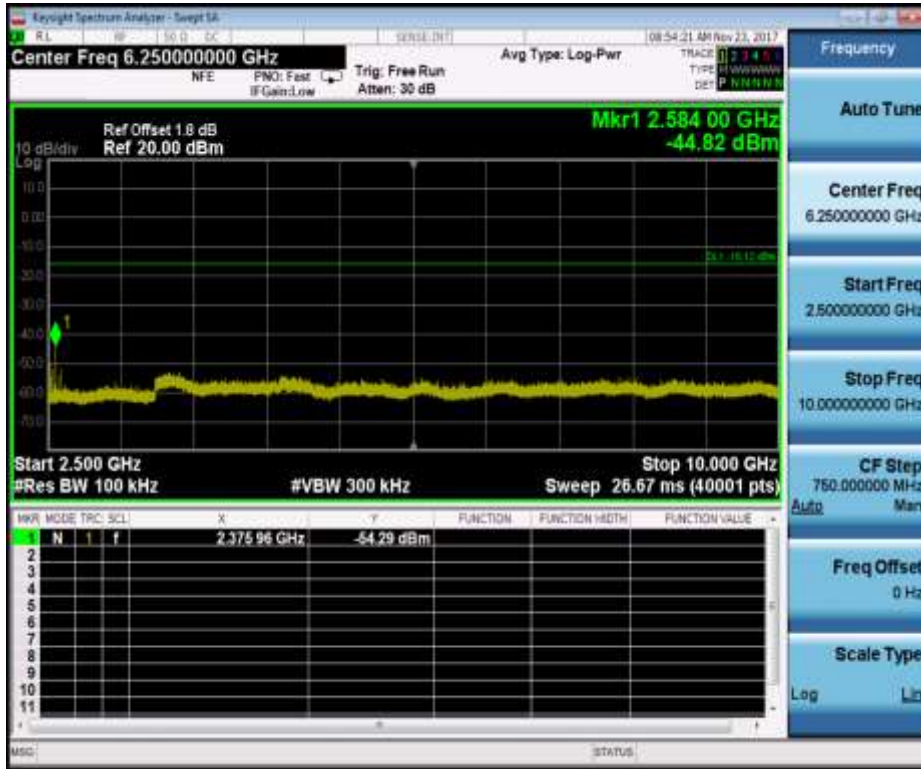

8DPSK Channel- L

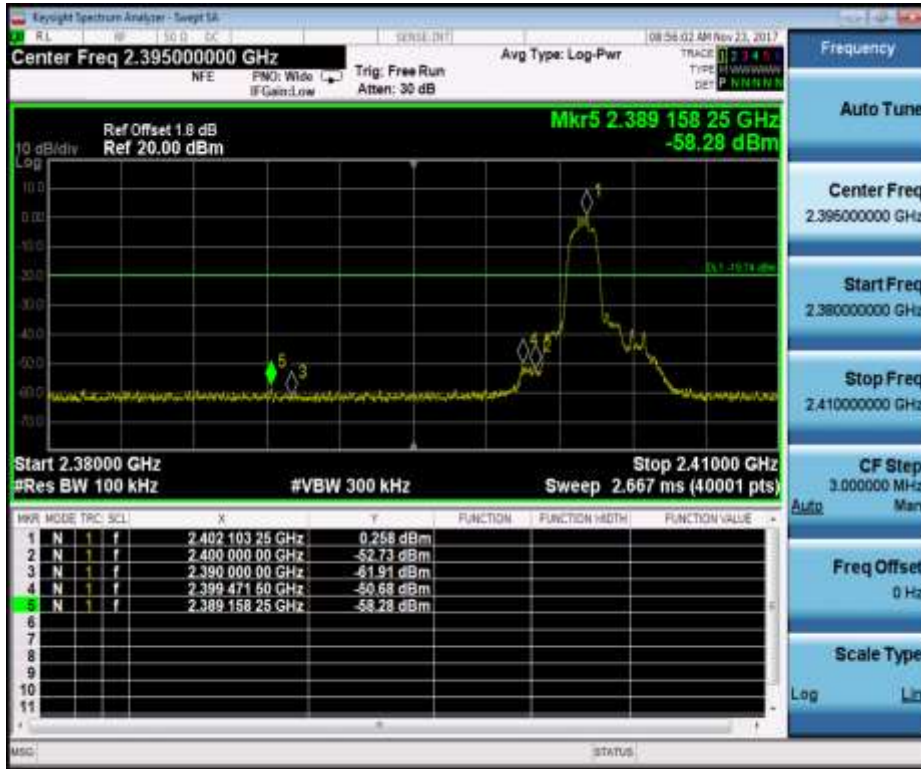

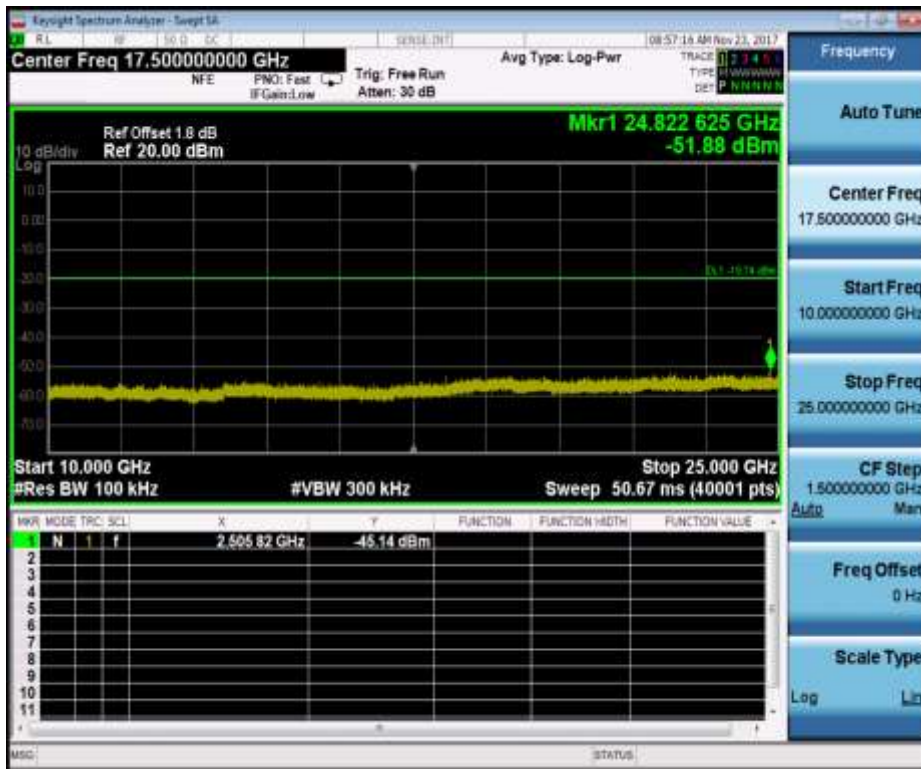
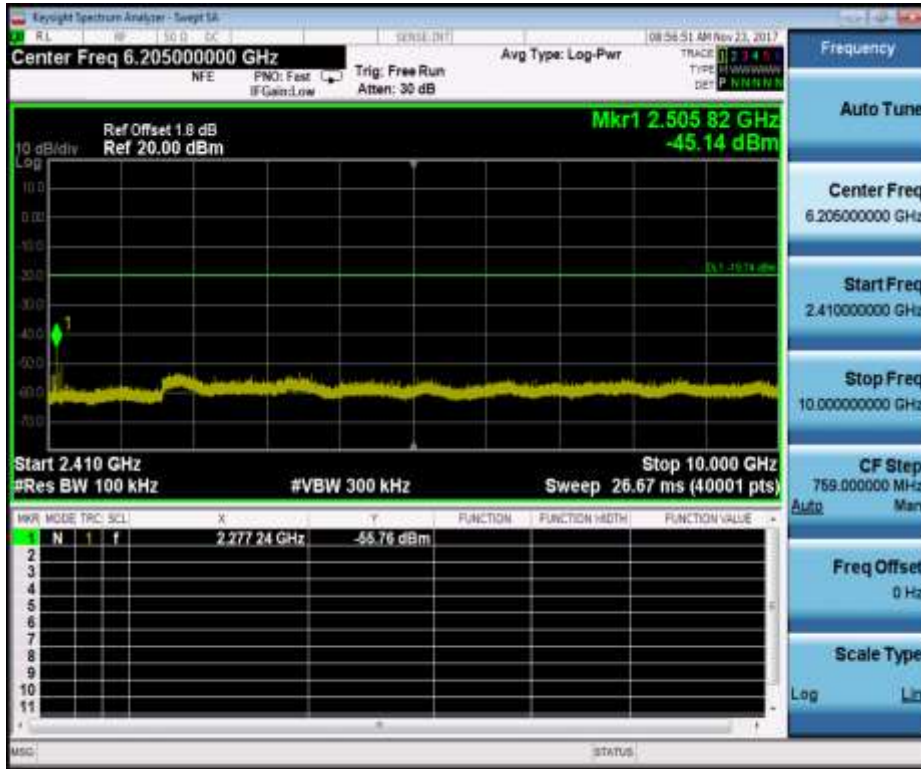

8DPSK Channel- M

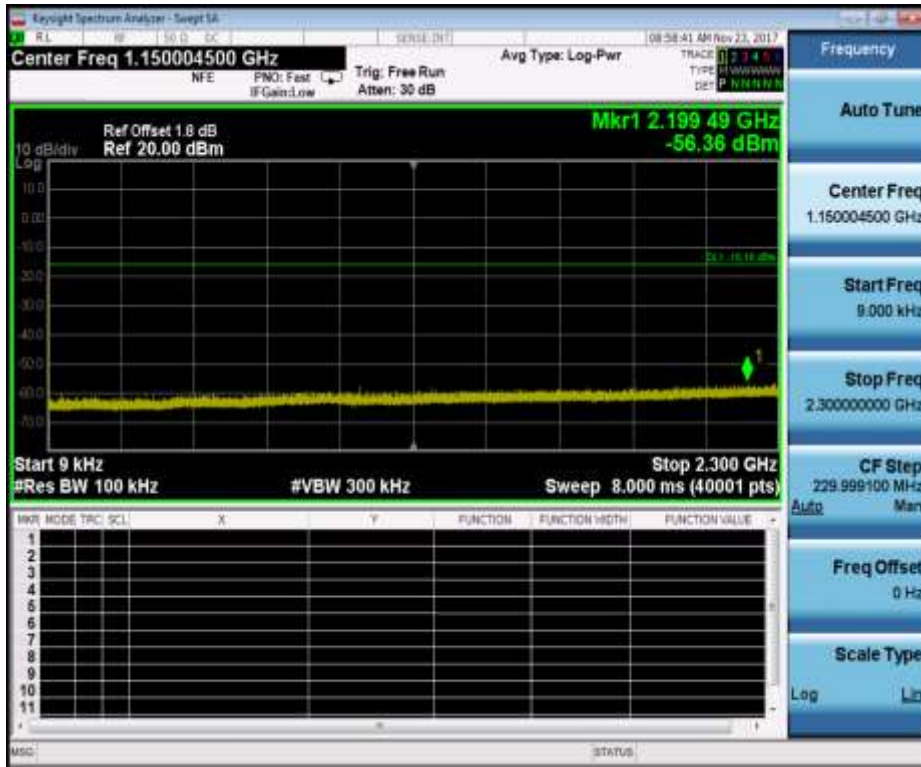
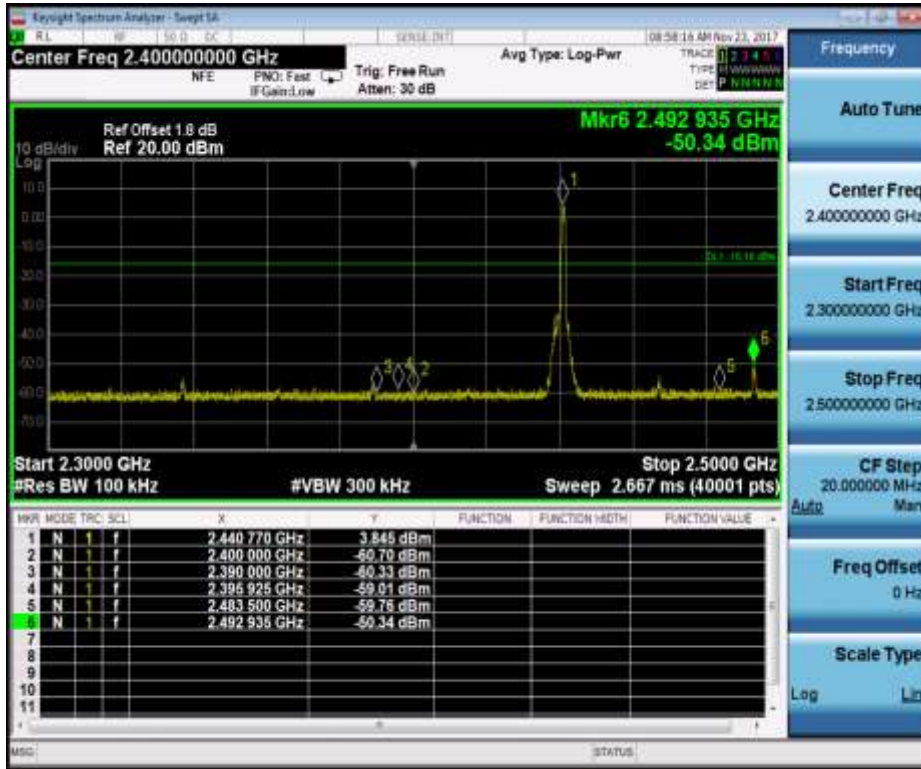

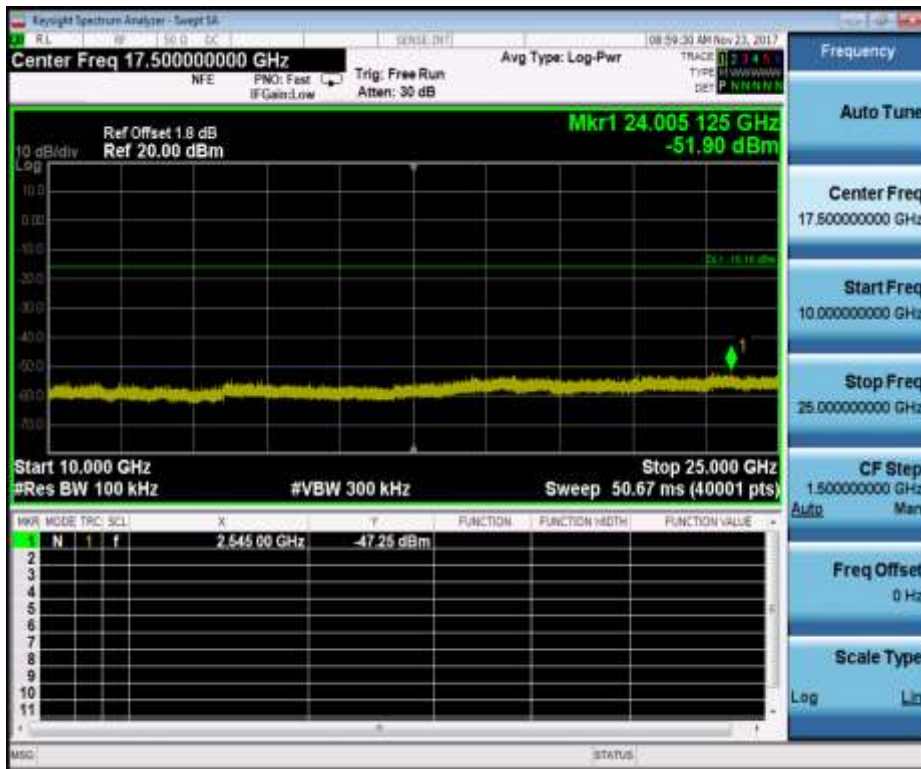
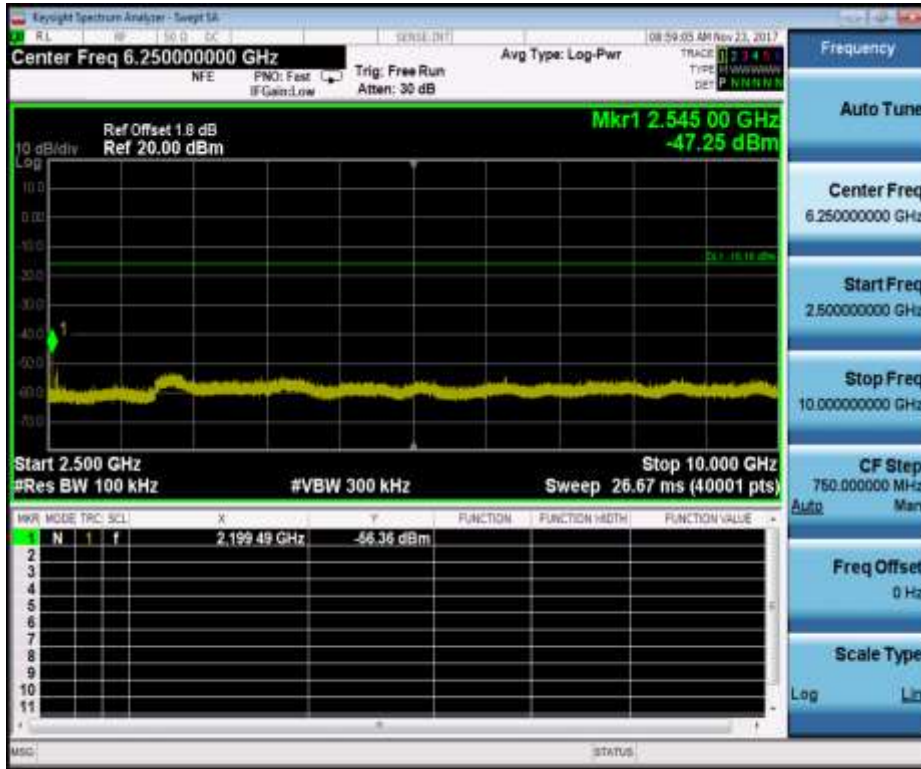

8DPSK Channel- H



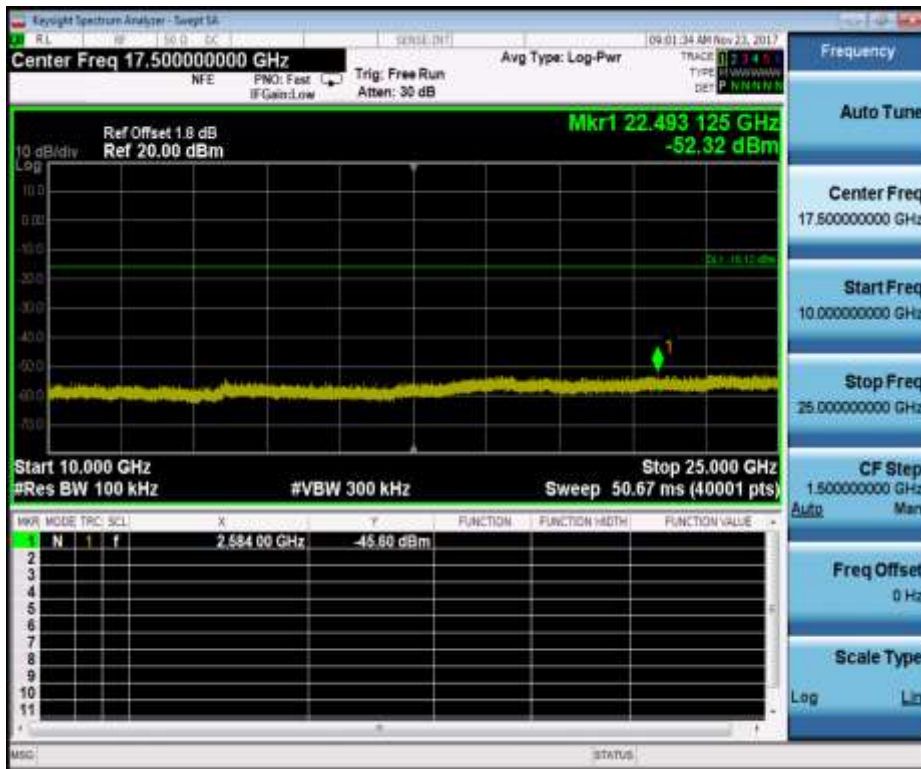
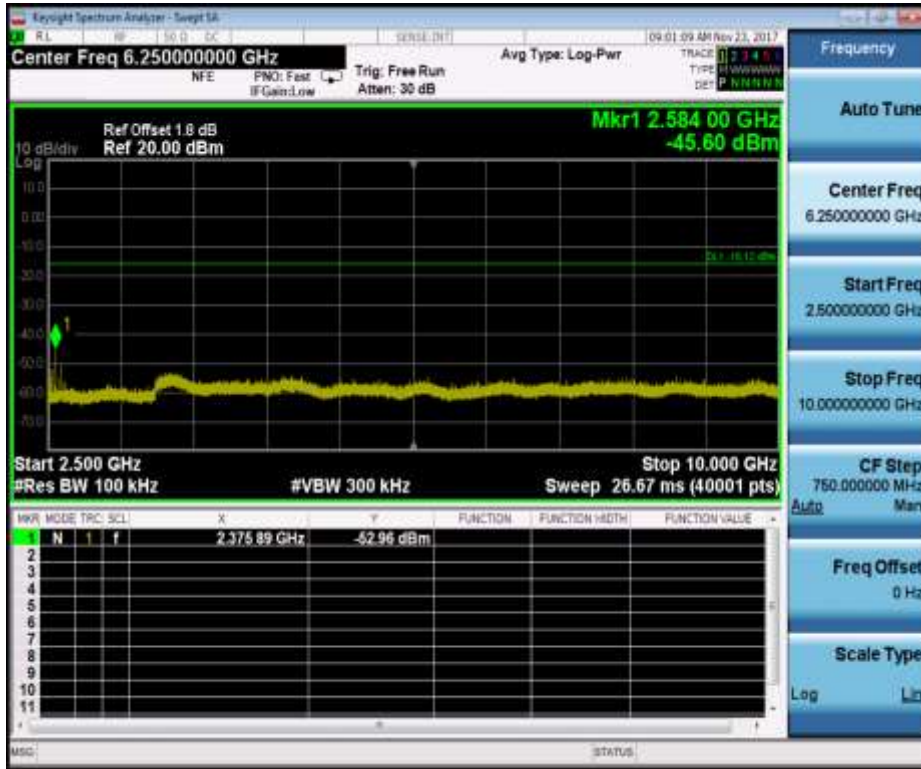

Hopping-GFSK

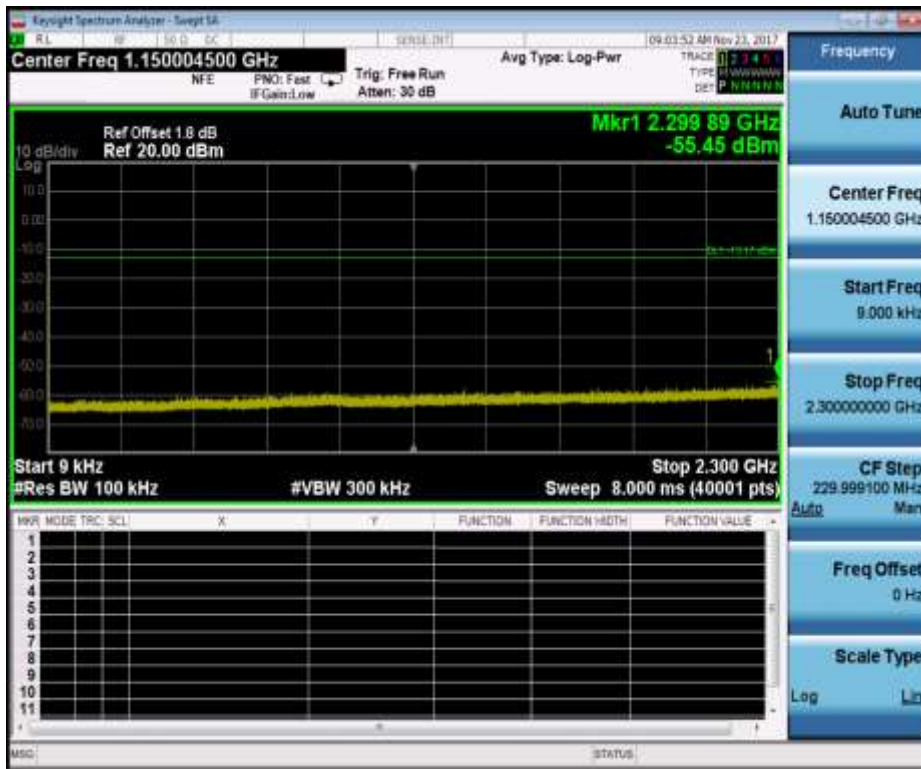
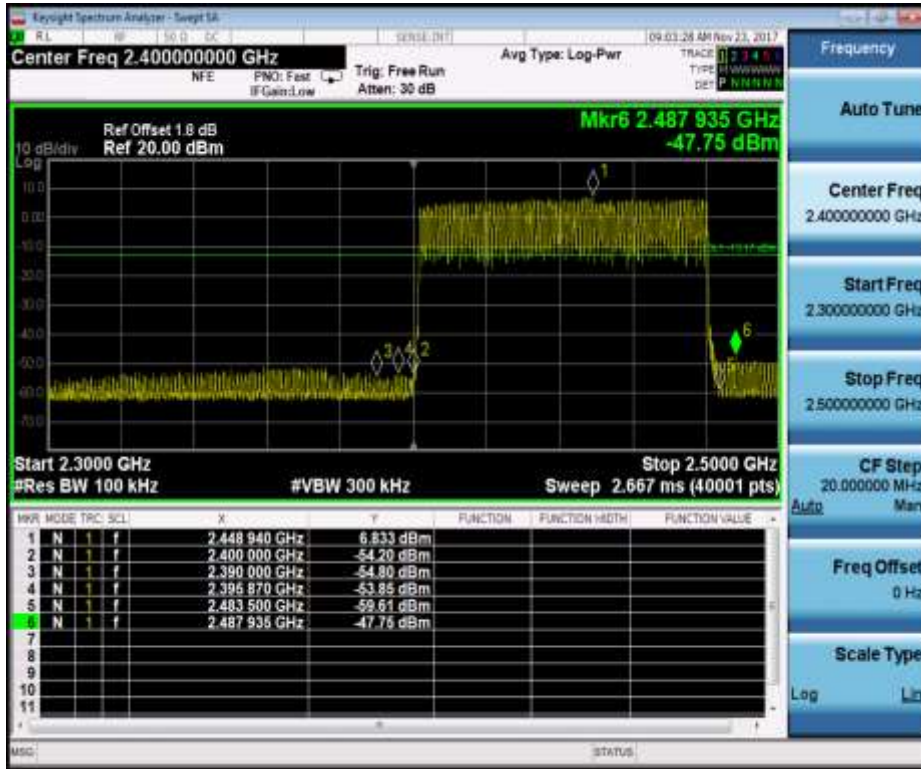

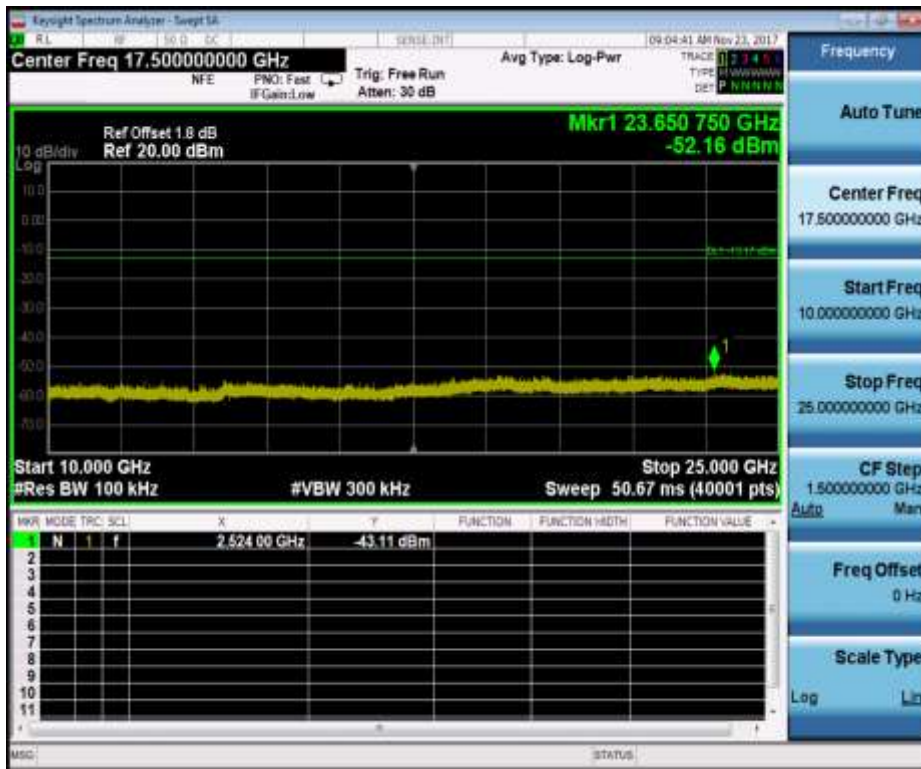
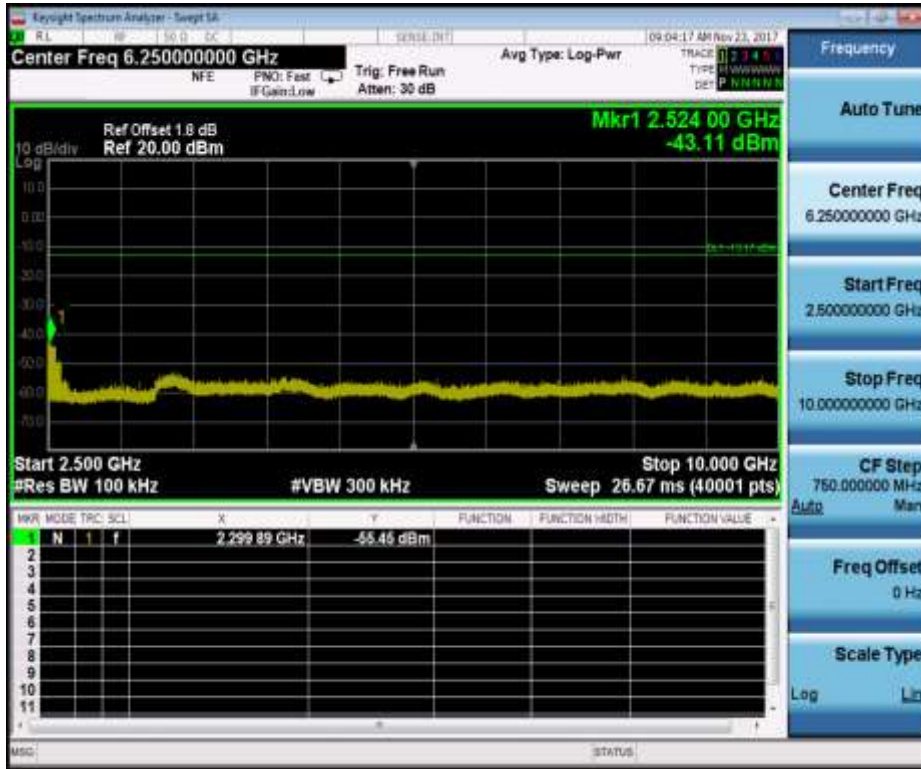

Hopping- $\pi/4$ DQPSK

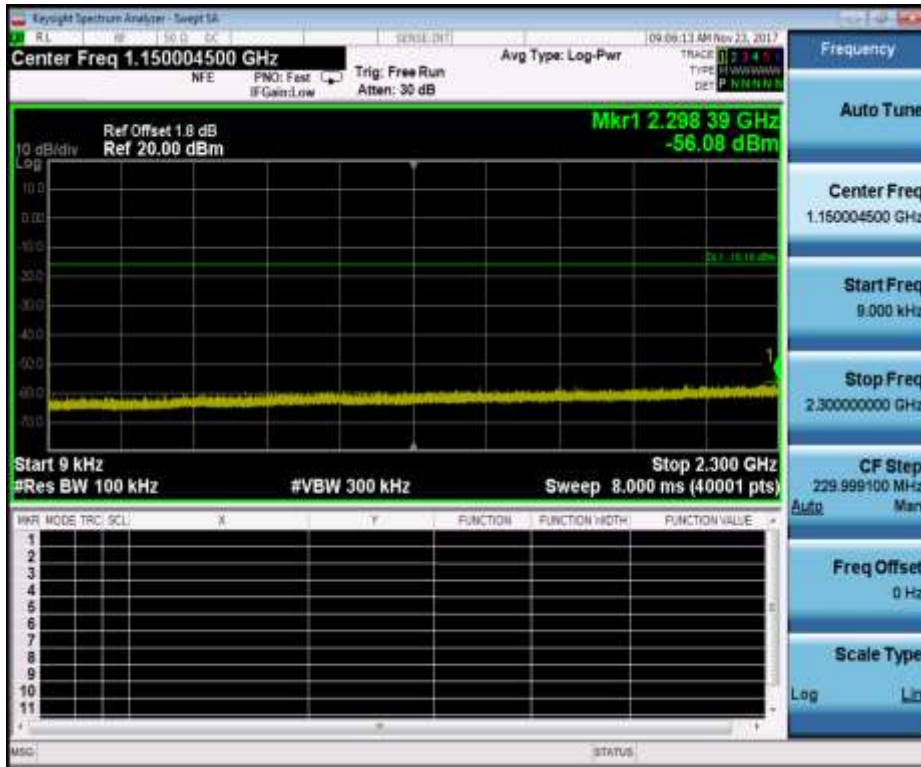
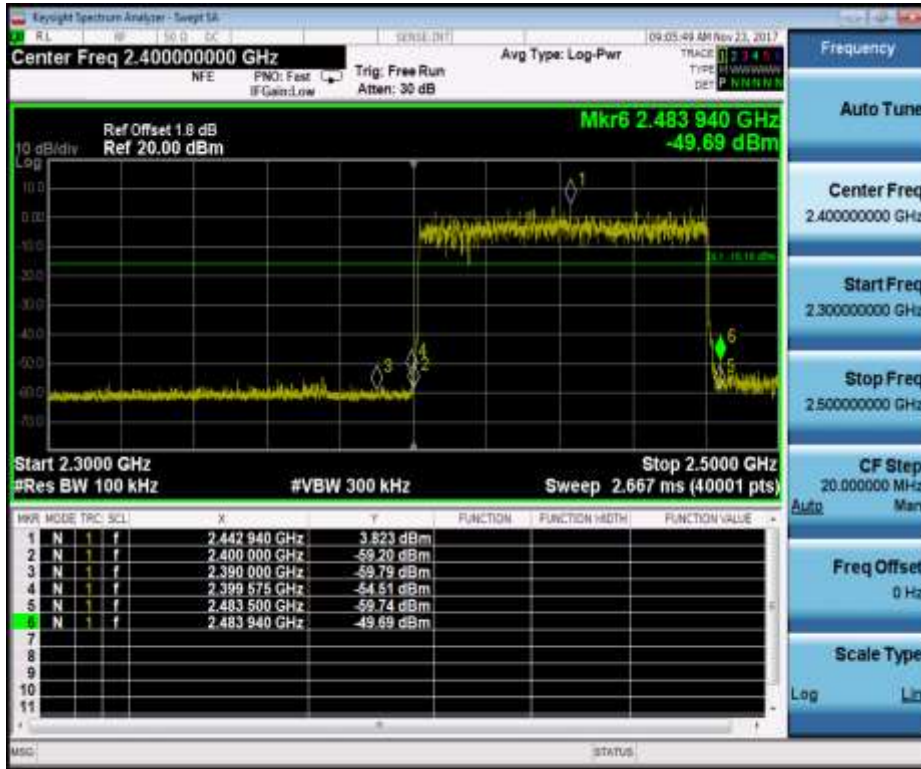

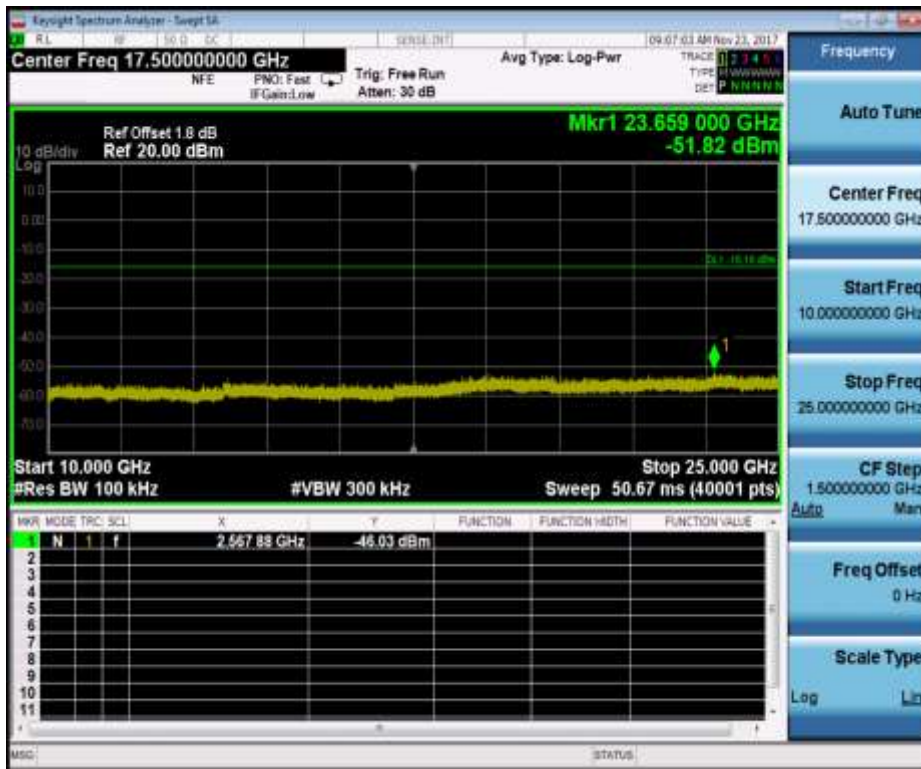
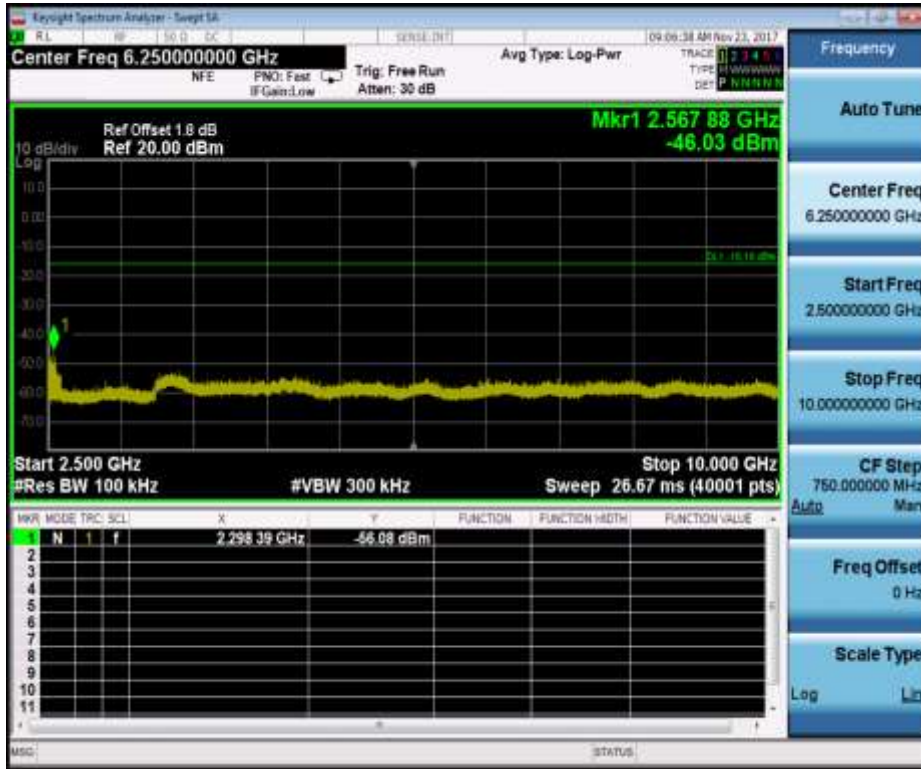

Hopping-8DPSK

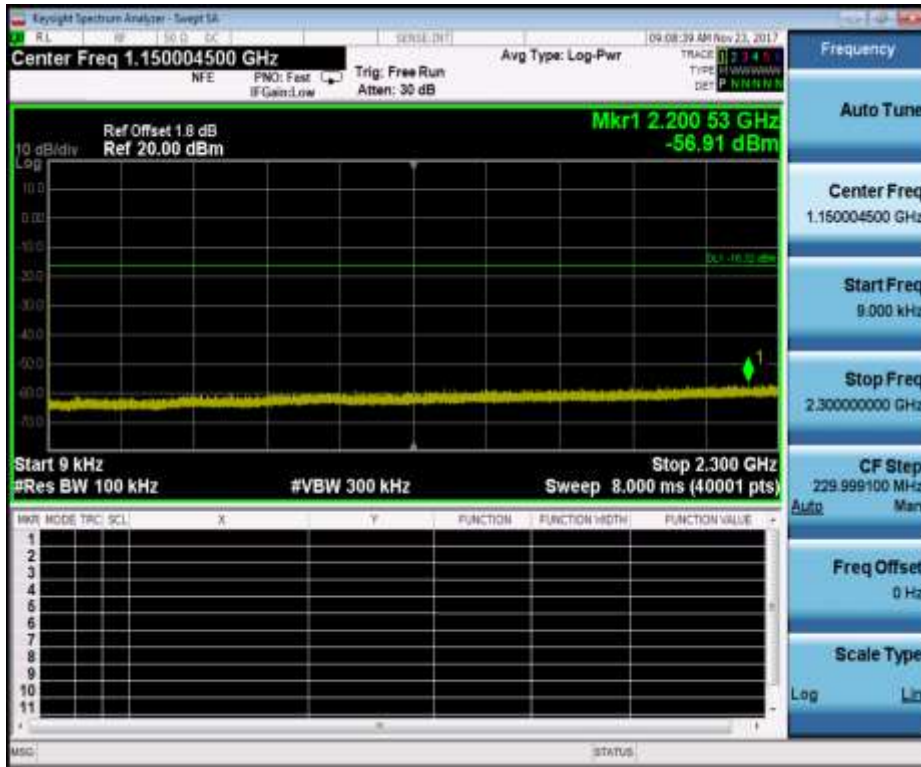
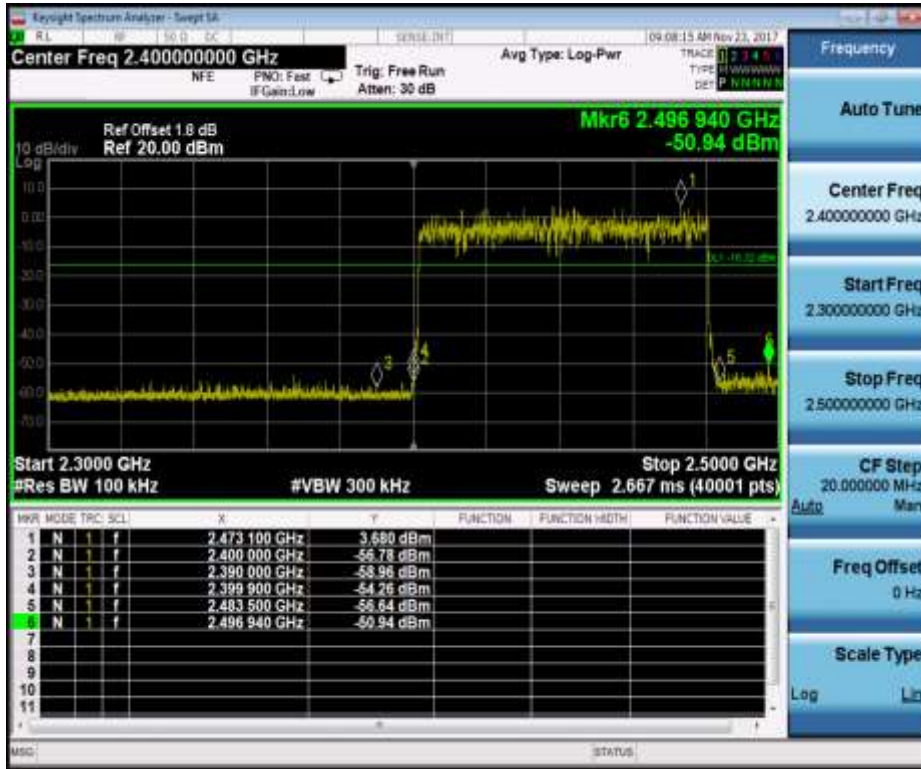

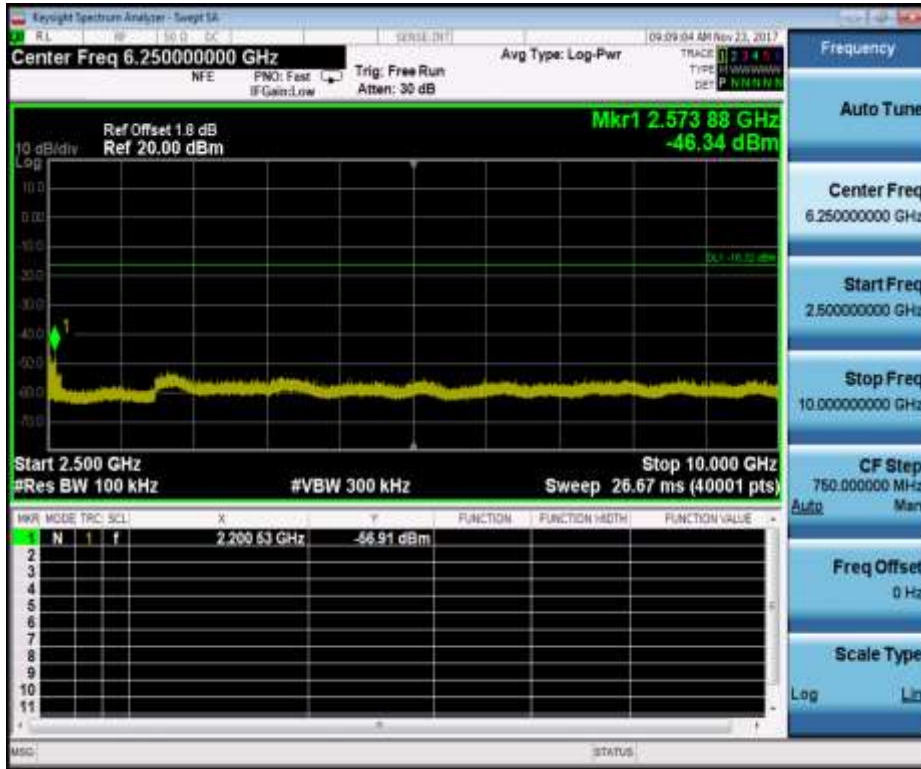

8. Power line conducted emission

Test result: Pass

8.1 Limit

Frequency of Emission (MHz)	Conducted Limit (dBuV)	
	QP	AV
0.15-0.5	66 to 56*	56 to 46 *
0.5-5	56	46
5-30	60	50

* Decreases with the logarithm of the frequency.

8.2 Test configuration

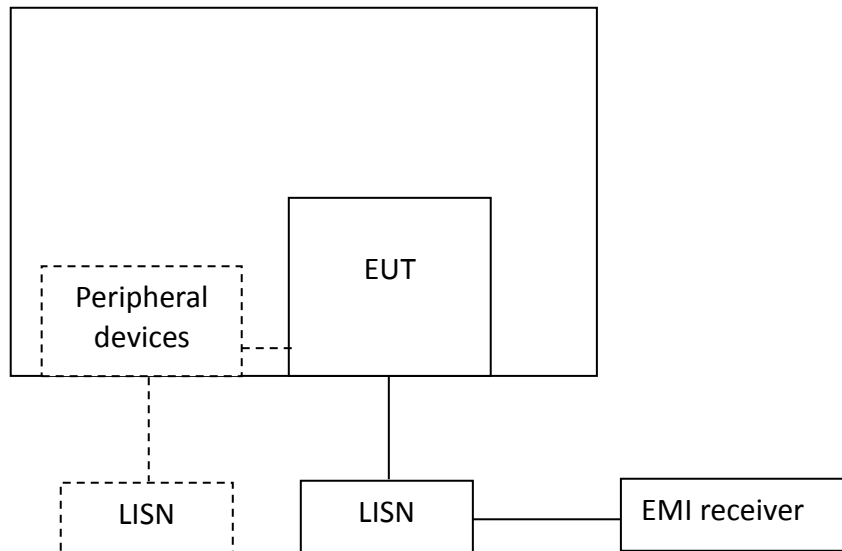

For table top equipment, wooden support is 0.8m height table

For floor standing equipment, wooden support is 0.12m height rack.

8.3 Test procedure and test set up

The EUT are connected to the main power through a line impedance stabilization network (LISN). This provides a $50\Omega/50\mu\text{H}$ coupling impedance for the measuring equipment. The peripheral devices are also connected to the main power through a LISN that provides a $50\Omega/50\mu\text{H}$ coupling impedance with 50Ω termination.

Both sides (Line and Neutral) of AC line are checked for maximum conducted interference. In order to find the maximum emission, the relative positions of equipment and all of the interface cables must be changed according to ANSI C63.4 on conducted measurement. The bandwidth of the test receiver is set at 9 kHz.

The EUT was tested according to DA 00-705 (Filing and Measurement Guidelines for Frequency Hopping Spread Spectrum Systems)

8.4 Test protocol

Temperature : 25 °C
 Relative Humidity : 55 %

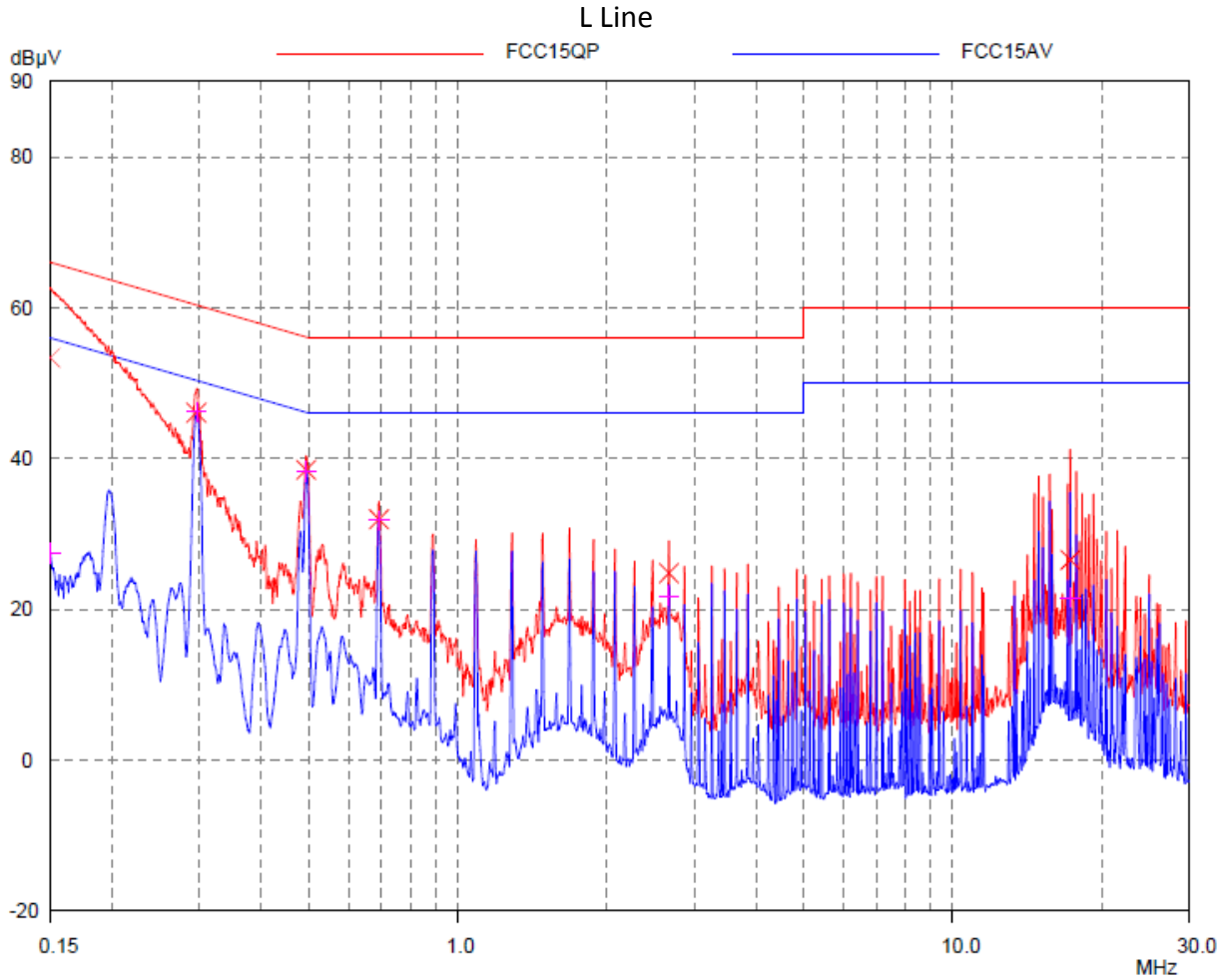

Test Data:

Frequency (MHz)	Quasi-peak			Average		
	level dB(µV)	Limit dB(µV)	Margin (dB)	level dB(µV)	limit dB(µV)	Margin (dB)
0.150	53.38	66.00	12.62	27.42	56.00	28.58
0.296	46.07	60.36	14.29	46.20	50.36	4.16
0.493	38.52	56.12	17.60	38.36	46.12	7.76
0.692	31.95	56.00	24.05	31.80	46.00	14.20
2.667	24.81	56.00	31.19	21.77	46.00	24.23
17.277	26.56	60.00	33.44	21.53	50.00	28.47

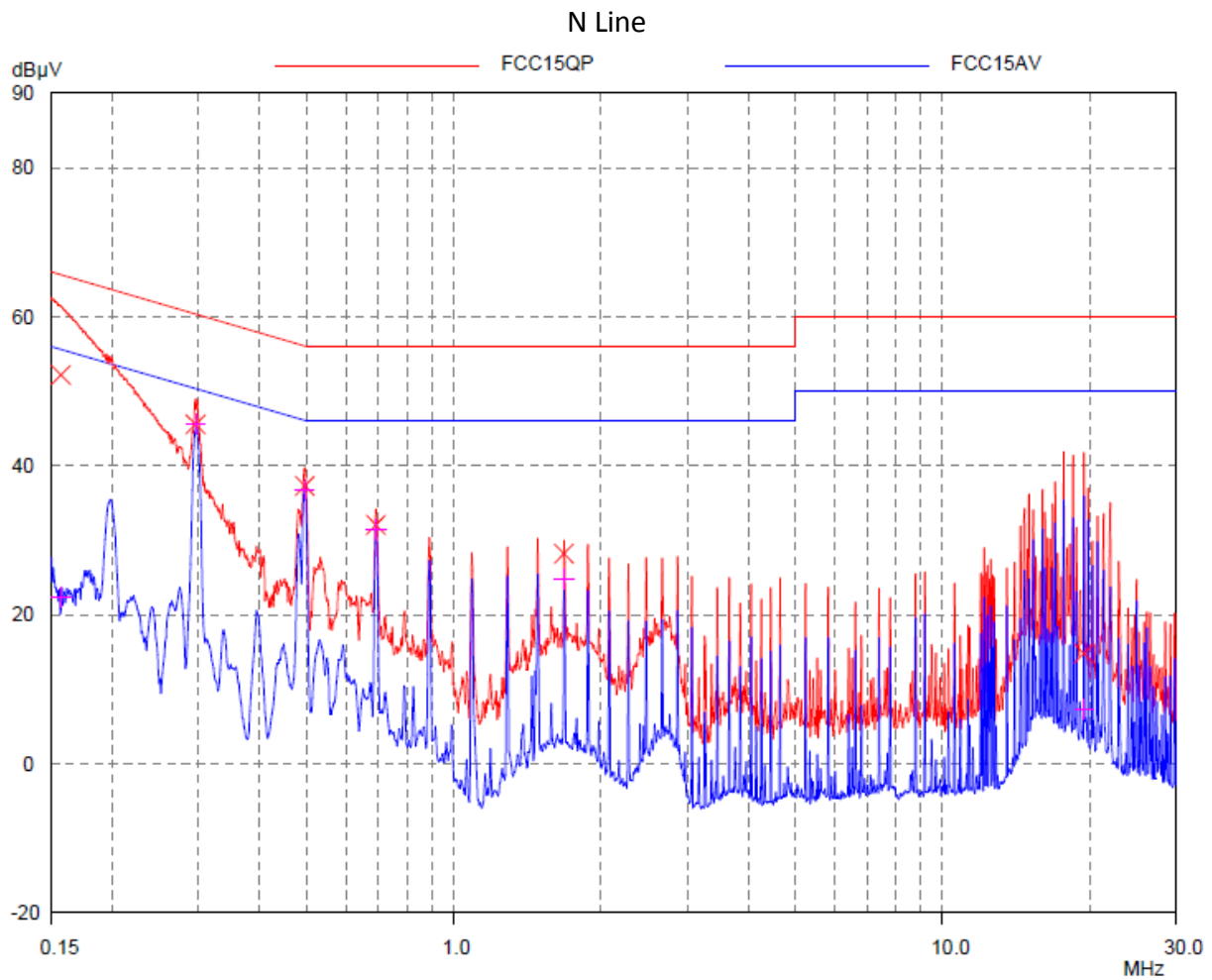

Test Data:

Frequency (MHz)	Quasi-peak			Average		
	level dB(µV)	Limit dB(µV)	Margin (dB)	level dB(µV)	limit dB(µV)	Margin (dB)
0.157	52.19	65.64	13.45	22.39	55.64	33.25
0.296	45.57	60.36	14.79	45.58	50.36	4.78
0.495	37.32	56.09	18.77	36.84	46.09	9.25
0.692	32.07	56.00	23.93	31.43	46.00	14.57
1.679	28.21	56.00	27.79	24.80	46.00	21.20
19.475	14.80	60.00	45.20	7.28	50.00	42.72

9. Number of Hopping Frequencies

Test result:Pass

9.1 Limit

Number of Hopping Frequencies in the 2400-2483.5 MHz band shall use at least 15 channels.

9.2 Test Configuration

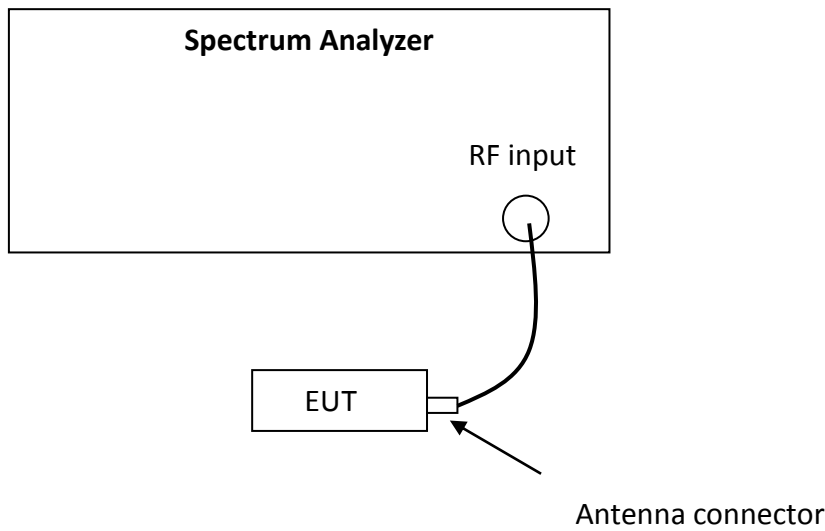

9.3 Test procedure and test setup

The channel number per FCC §15.247(a)(1)(iii) is measured using the Spectrum Analyzer with RBW=100kHz, VBW≥RBW, Sweep = auto, Detector = peak, Trace = max hold. The EUT was tested according to DA 00-705 (Filing and Measurement Guidelines for Frequency Hopping Spread Spectrum Systems).

9.4 Test protocol

Temperature : 25 °C
Relative Humidity : 55 %

Channel Number	Limit
79	≥15

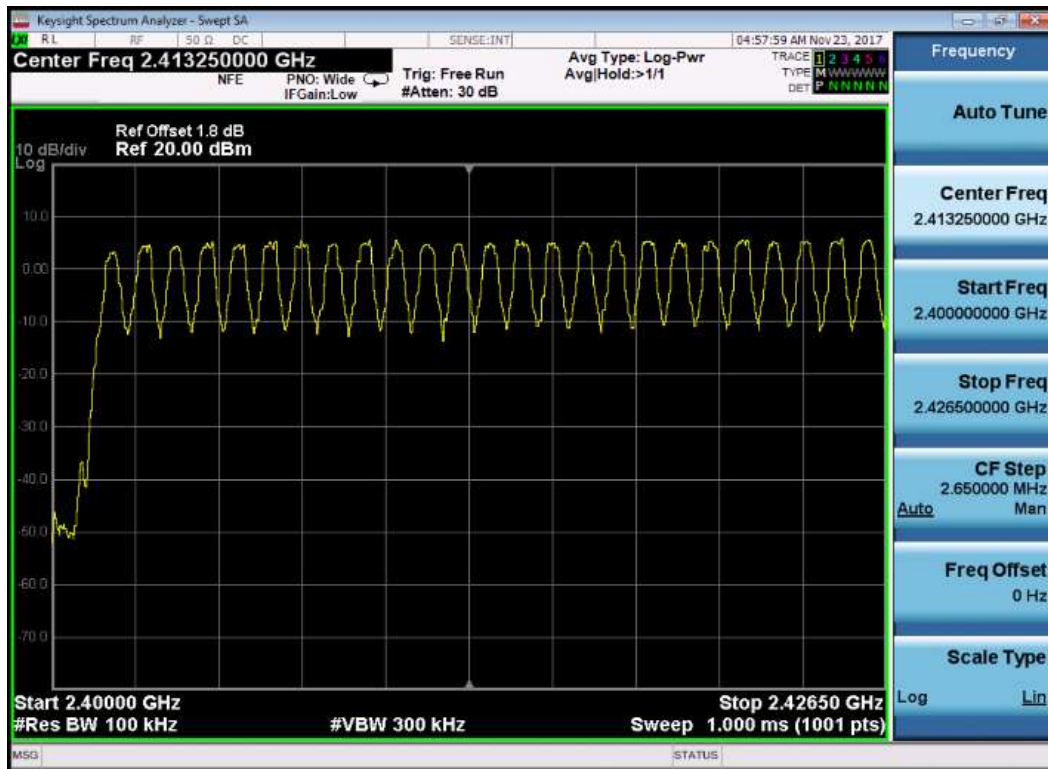
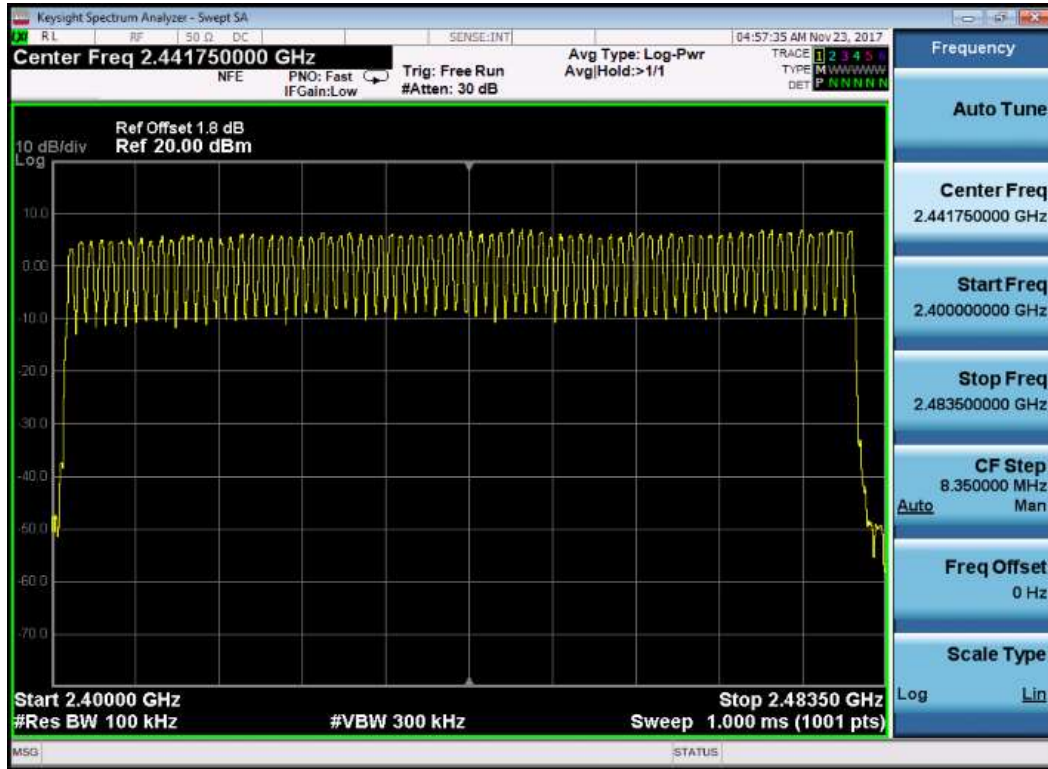

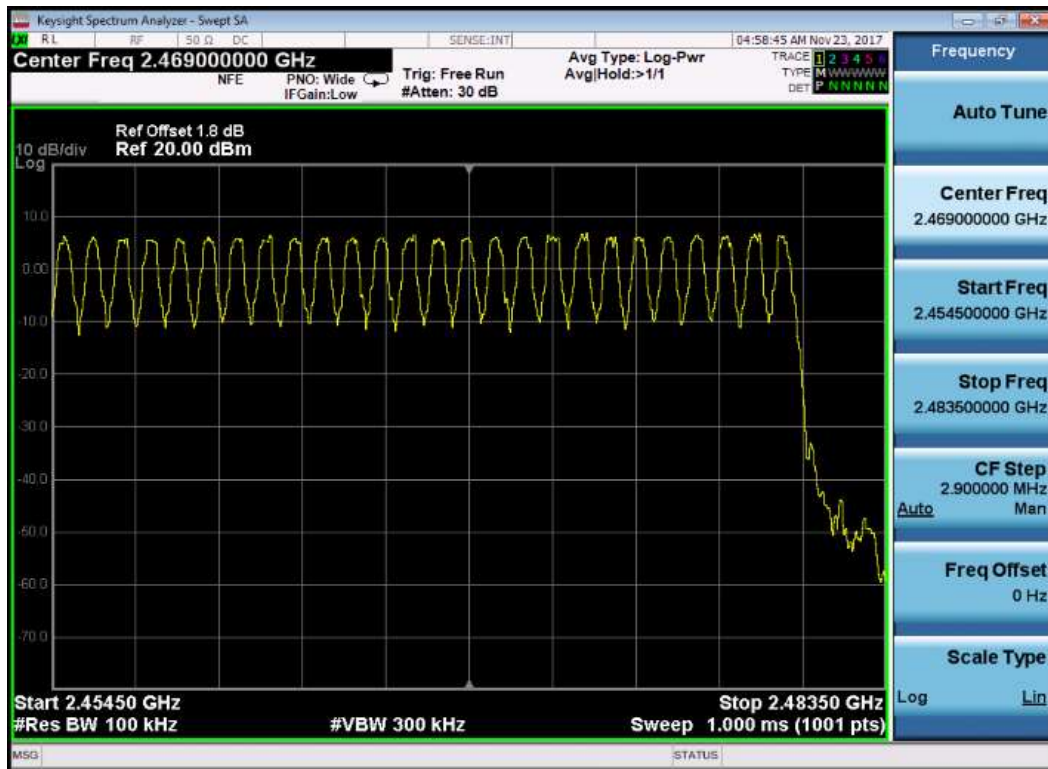
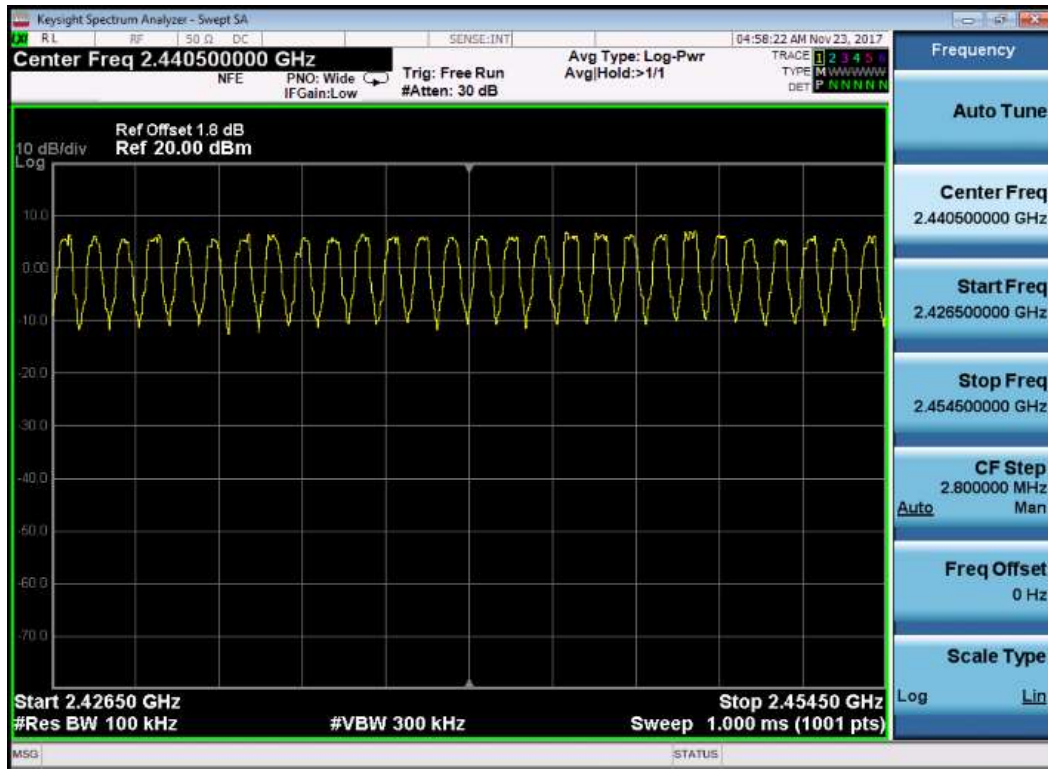

10. Dwell Time

Test result:Pass

10.1 Limit

The dwell time on any channel shall not be greater than 0.4 seconds within a period of 0.4 seconds multiplied by the number of hopping channels employed. Frequency hopping systems may avoid or suppress transmissions on a particular hopping frequency provided that a minimum of 15 channels are used.

10.2 Test Configuration

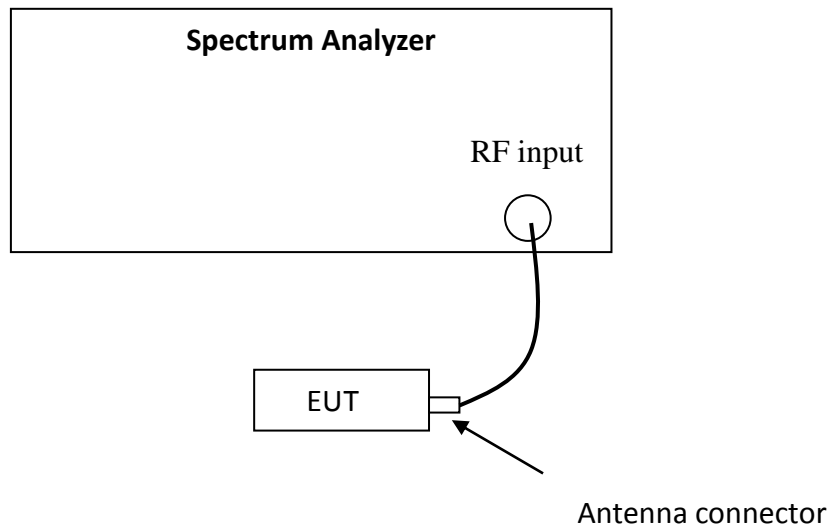

10.3 Test procedure and test setup

Dwell time per FCC §15.247(a)(1)(iii) is measured using the Spectrum Analyzer with Span = 0, RBW=1MHz, VBW≥RBW, Sweep can capture the entire dwell time, Detector = peak, Trace = max hold.

The EUT was tested according to DA 00-705 (Filing and Measurement Guidelines for Frequency Hopping Spread Spectrum Systems).

10.4 Test protocol

Temperature : 25 °C
Relative Humidity : 55 %

8DPSK Modulation:

Packet	Occupancy time for single hop (ms) O	CH	Real observed period (s) P	Hops among Observed period I	Dwell time (ms) T	Limit (s)
DH1	0.4096	L	3.16	32	131.07	≤0.4
		M	3.16	32	131.07	
		H	3.16	32	131.07	
DH3	1.668	L	3.16	16	266.88	
		M	3.16	16	266.88	
		H	3.16	16	266.88	
DH5	2.907	L	3.16	11	319.77	
		M	3.16	11	319.77	
		H	3.16	11	319.77	

Remark: 1. There are 79 channels in all. So the complete observed period $P = 0.4 * 79 = 31.6$ s.
2. Average time of occupancy $T = O * I * 31.6 / P$

DH1

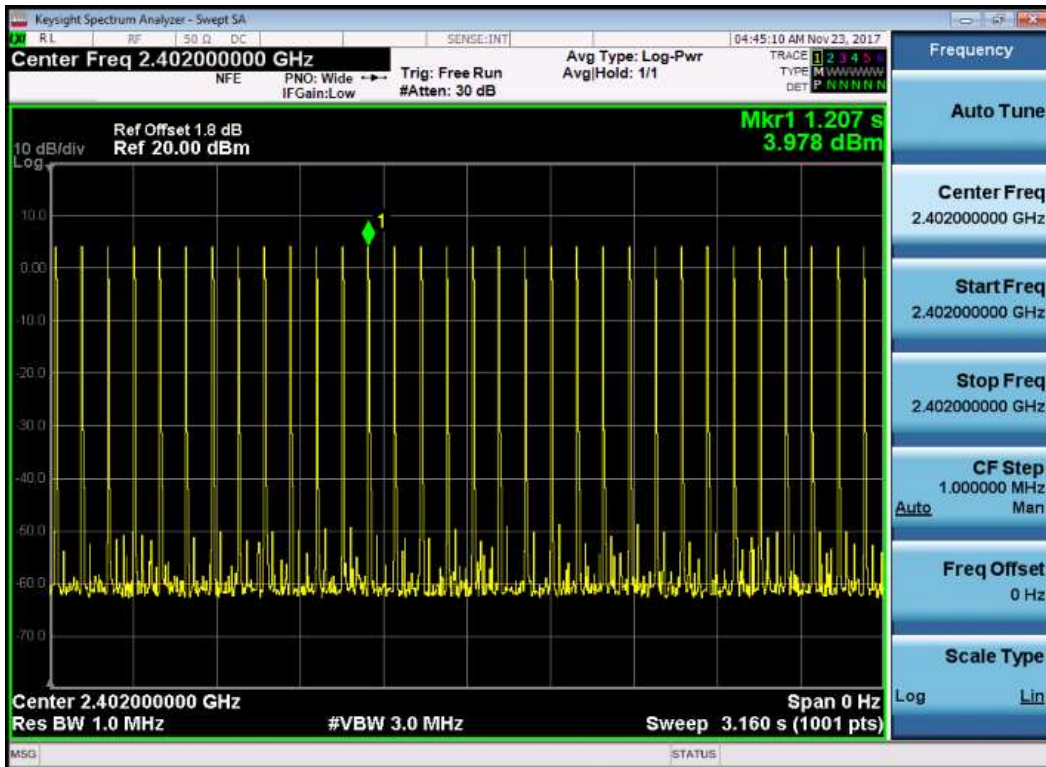
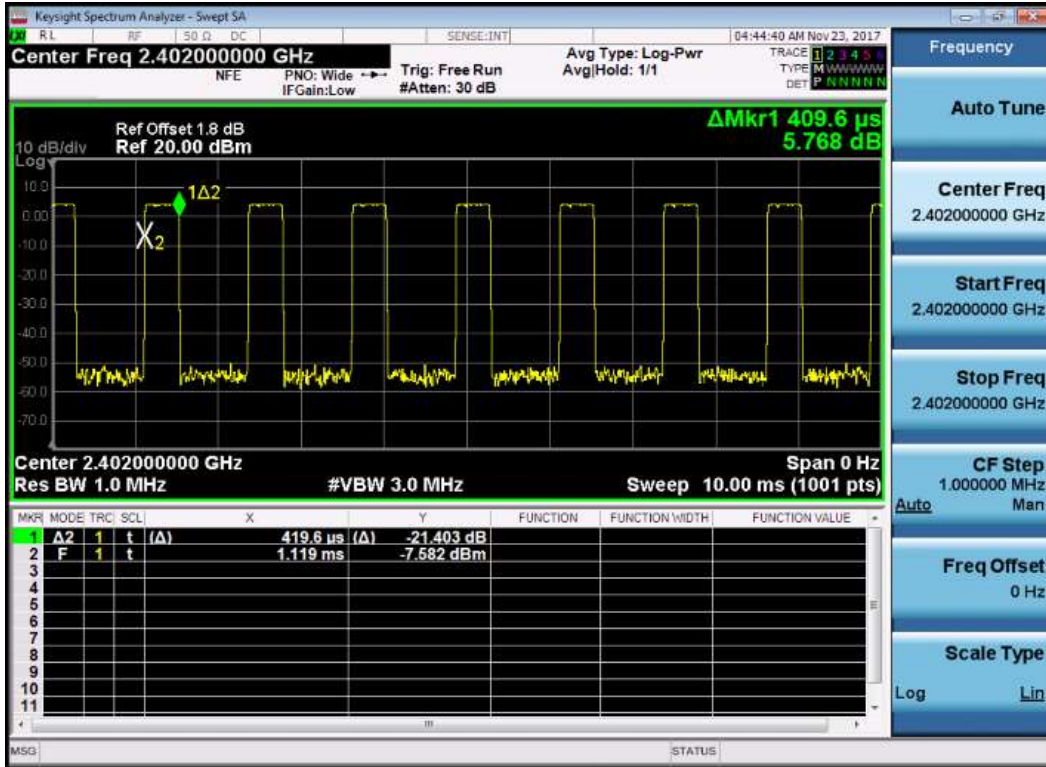

DH3

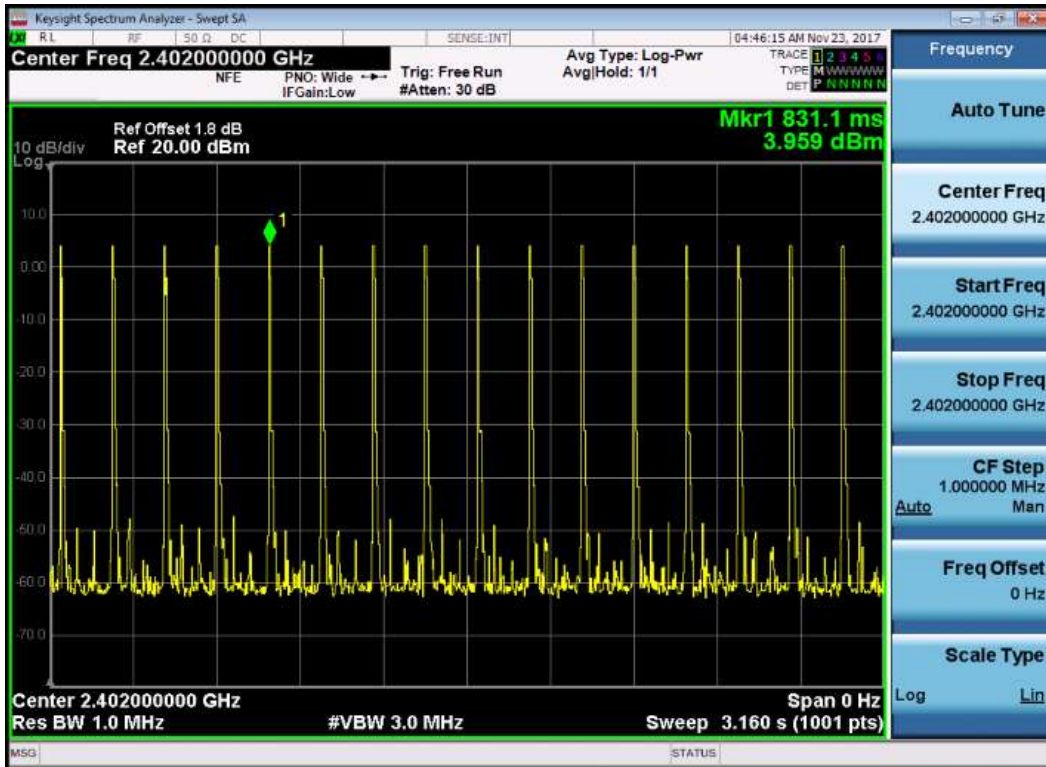
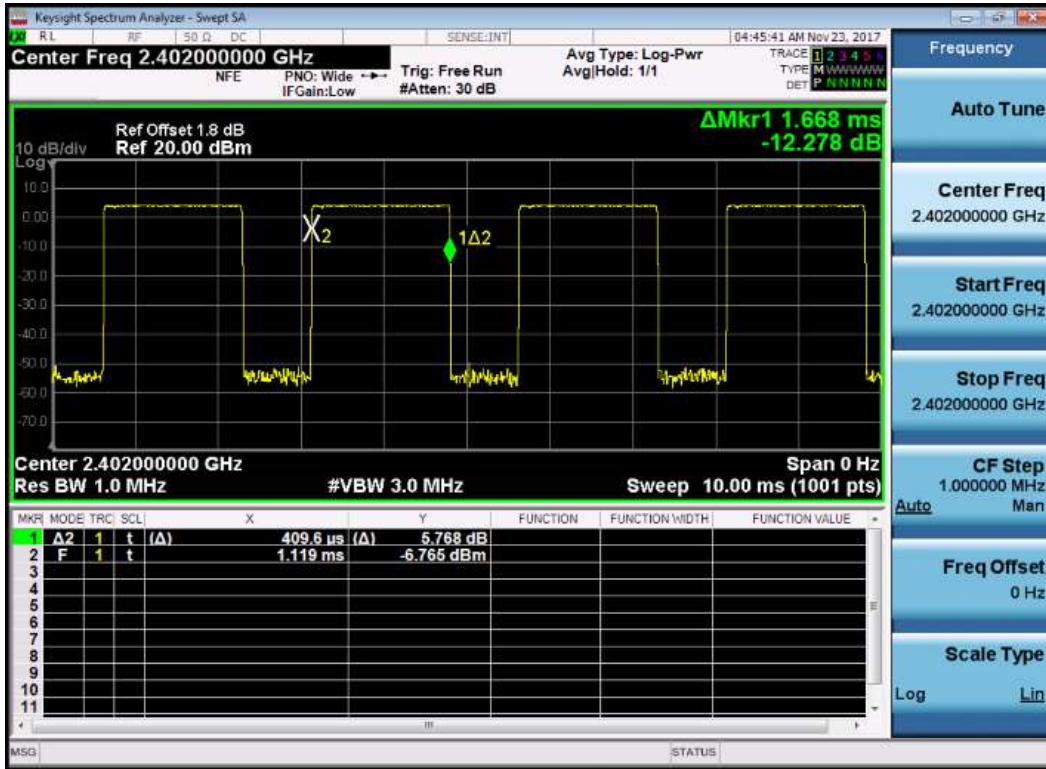

DH5

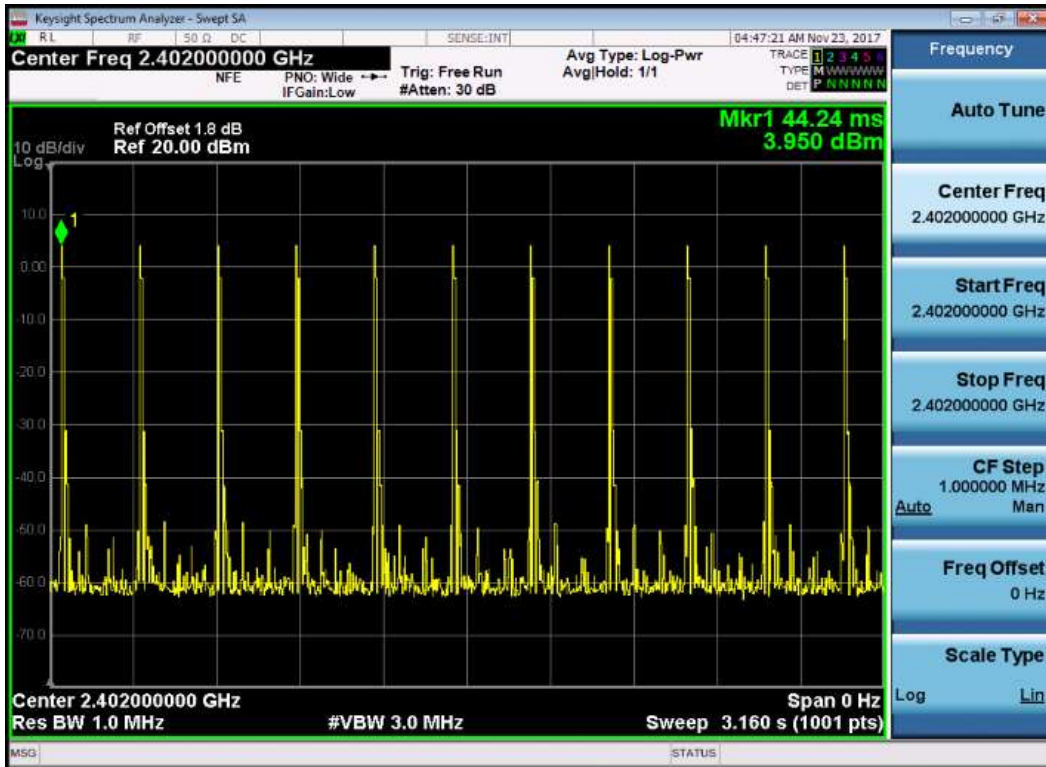
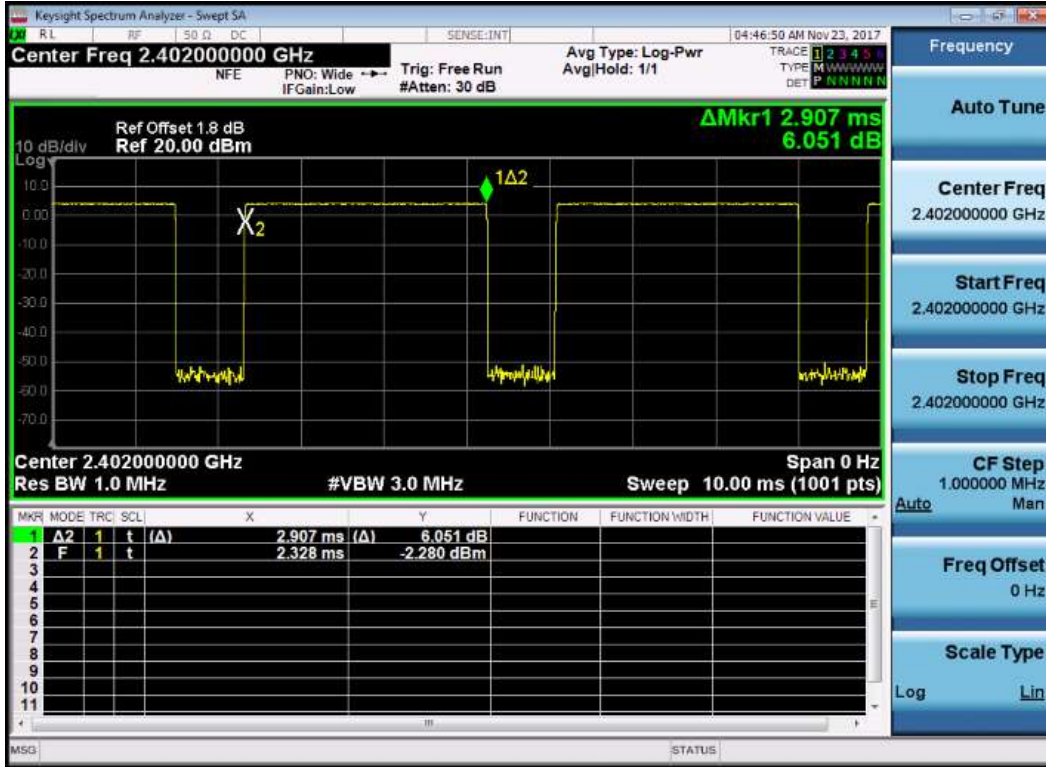

11. Occupied Bandwidth

Test result: Tested

11.1 Test limit

None

11.2 Test Configuration

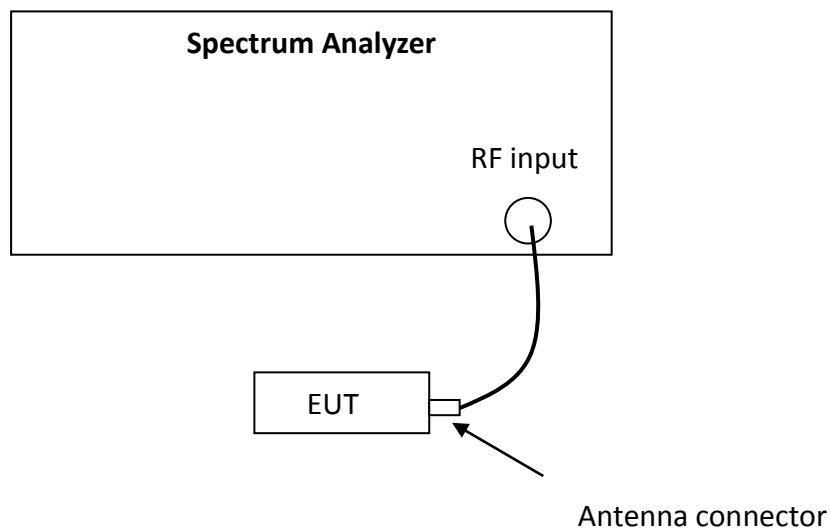

11.3 Test procedure and test setup

The occupied bandwidth per RSS-Gen Issue 4 Clause 6.6 was measured using the Spectrum Analyzer with the RBW close to 1% of the selected span, $VBW = 3 * RBW$
Detector = Sample, Sweep = Auto.

11.4 Test protocol

Temperature : 25 °C
Relative Humidity : 55 %

Modulation	Channel	99% Occupied Bandwidth (kHz)
GFSK	L	872.39
	M	859.66
	H	862.86

Modulation	Channel	99% Occupied Bandwidth (kHz)
$\pi/4$ DQPSK	L	1174.40
	M	1166.60
	H	1166.80

Modulation	Channel	99% Occupied Bandwidth (kHz)
8DPSK	L	1159.60
	M	1156.50
	H	1158.30

Note: The test plots please see Section 3 in this report.

12. Spurious emission for receiver

Test result:NA

12.1 Test limit

The spurious emission shall test through 3 times tuneable or local oscillator frequency whichever is the higher, without exceeding 40 GHz.

If a conducted measurement is made, no spurious output signals appearing at the antenna terminals shall exceed 2nW per any 4 kHz spurious frequency in the band 30-1000 MHz, or 5nW above 1 GHz.

If a radiated measurement is made, all spurious emissions shall comply with the limits of Table below:

Frequency (MHz)	Field Strength (dBuV/m)	Measurement Distance (m)
30 - 88	40.0	3
88 - 216	43.5	3
216 - 960	46.0	3
Above 960	54.0	3

12.2 Test Configuration

Please refer to clause 6.2

12.3 Test procedure and test setup

Please refer to clause 6.3.

