

RF MEASUREMENT REPORT

FCC ID: SVC-BLSN33A
Applicant: Lenbrook Industries Limited
Product: Wireless Music Streaming Amplifier
Model No.: POWERNODE
Brand Name: Bluesound
FCC Classification: Unlicensed National Information Infrastructure (NII)
FCC Rule Part(s): Part 15 Subpart E (Section 15.407)
Test Date: September 23, 2021 ~ January 05, 2022

Reviewed By:

Kevin Guo

Approved By:

Robin Wu



The test results relate only to the samples tested.

This equipment has been shown to be capable of compliance with the applicable technical standards as indicated in the measurement report and was tested in accordance with the measurement procedures specified in KDB 789033 D02v02r01. Test results reported herein relate only to the item(s) tested.

The test report shall not be reproduced except in full without the written approval of MRT Technology (Suzhou) Co., Ltd.

Revision History

Report No.	Version	Description	Issue Date	Note
2107RSU029-U4	Rev. 01	Initial Report	04-15-2022	Valid

CONTENTS

Description	Page
1. General Information	6
1.1. Applicant	6
1.2. Manufacturer	6
1.3. Testing Facility	6
1.4. Product Information.....	7
1.5. Radio Specification	7
1.6. Working Frequencies	8
1.7. Antennas Information.....	8
2. Test Configuration	9
2.1. Test Mode.....	9
2.2. Test System Connection Diagram.....	9
2.3. Test Software	10
2.4. Applied Standards.....	10
2.5. Test Environment Condition	10
3. Antenna Requirements	11
4. Measuring Instrument	12
5. Measurement Uncertainty.....	14
6. Test Result.....	15
6.1. Summary.....	15
6.2. 26dB & 99% Bandwidth	16
6.2.1. Test Limit	16
6.2.2. Test Procedure used	16
6.2.3. Test Setting	16
6.2.4. Test Setup	17
6.2.5. Test Result	17
6.3. 6dB Bandwidth.....	18
6.3.1. Test Limit	18
6.3.2. Test Procedure used	18
6.3.3. Test Setting	18
6.3.4. Test Setup	18
6.3.5. Test Result	18
6.4. Output Power	19
6.4.1. Test Limit	19
6.4.2. Test Procedure Used	19
6.4.3. Test Setting	19

6.4.4.	Test Setup	19
6.4.5.	Test Result	20
6.5.	Transmit Power Control	21
6.5.1.	Test Limit	21
6.5.2.	Test Procedure Used	21
6.5.3.	Test Setting	21
6.5.4.	Test Setup	21
6.5.5.	Test Result	21
6.6.	Power Spectral Density.....	22
6.6.1.	Test Limit	22
6.6.2.	Test Procedure Used	22
6.6.3.	Test Setting	22
6.6.4.	Test Setup	23
6.6.5.	Test Result	23
6.7.	Frequency Stability Measurement	24
6.7.1.	Test Limit	24
6.7.2.	Test Procedure Used	24
6.7.3.	Test Setup	25
6.7.4.	Test Result	25
6.8.	Radiated Spurious Emission.....	26
6.8.1.	Test Limit	26
6.8.2.	Test Procedure Used	26
6.8.3.	Test Setting	26
6.8.4.	Test Setup	28
6.8.5.	Test Result	28
6.9.	Radiated Restricted Band Edge	29
6.9.1.	Test Limit	29
6.9.2.	Test Procedure Used	30
6.9.3.	Test Setting	30
6.9.4.	Test Setup	31
6.9.5.	Test Result	31
6.10.	AC Conducted Emissions	32
6.10.1.	Test Limit.....	32
6.10.2.	Test Setup.....	32
6.10.3.	Test Result.....	32
Appendix A – Test Result.....		33
A.1	Duty Cycle Test Result.....	33
A.2	26dB & 99% Bandwidth Test Result	34
A.3	6dB Bandwidth Test Result	43

A.4	Output Power Test Result	46
A.5	Power Spectral Density Test Result.....	49
A.6	Frequency Stability Test Result.....	59
A.7	Radiated Spurious Emission Measurement Test Result.....	60
A.8	Radiated Restricted Band Edge Test Result.....	107
A.9	AC Conducted Emissions Test Result	175
Appendix B – Test Setup Photograph		177
Appendix C – EUT Photograph		178

1.4. Product Information

Product Name	Wireless Music Streaming Amplifier
Model No.	POWERNODE
Serial No.	H213N330B01032
Wi-Fi Specification	802.11a/b/g/n/ac
Bluetooth Specification	V4.2 single mode for BR/EDR
Antenna Information	Refer to section 1.7
Working Voltage	100-120/220-240V ~ 50/60Hz, 150W
Remark: The information of EUT was provided by the manufacturer, and the accuracy of the information shall be the responsibility of the manufacturer.	

1.5. Radio Specification

Frequency Range	For 802.11a/n-HT20/ac-VHT20: 5180~5240MHz, 5260~5320MHz, 5500~5720MHz, 5745~5825MHz For 802.11n-HT40/ac-VHT40: 5190~5230MHz, 5270~5310MHz, 5510~5710MHz, 5755~5795MHz For 802.11ac-VHT80: 5210MHz, 5290MHz, 5530MHz, 5610 MHz, 5690MHz, 5775MHz
Type of Modulation	802.11a/n/ac: OFDM
Data Rate	802.11a: 6/9/12/18/24/36/48/54Mbps 802.11n: up to 150Mbps 802.11ac: up to 433.3Mbps

Note: For other features of this EUT, test report will be issued separately.

1.6. Working Frequencies

802.11a/n-HT20/ac-VHT20

Channel	Frequency	Channel	Frequency	Channel	Frequency
36	5180 MHz	40	5200 MHz	44	5220 MHz
48	5240 MHz	52	5260 MHz	56	5280 MHz
60	5300 MHz	64	5320 MHz	100	5500 MHz
104	5520 MHz	108	5540 MHz	112	5560 MHz
116	5580 MHz	120	5600 MHz	124	5620 MHz
128	5640 MHz	132	5660 MHz	136	5680 MHz
140	5700 MHz	144	5720 MHz	149	5745 MHz
153	5765 MHz	157	5785 MHz	161	5805 MHz
165	5825 MHz	--	--	--	--

802.11n-HT40/ac-VHT40

Channel	Frequency	Channel	Frequency	Channel	Frequency
38	5190 MHz	46	5230 MHz	54	5270 MHz
62	5310 MHz	102	5510 MHz	110	5550 MHz
118	5590 MHz	126	5630 MHz	134	5670 MHz
142	5710 MHz	151	5755 MHz	159	5795 MHz

802.11ac-VHT80

Channel	Frequency	Channel	Frequency	Channel	Frequency
42	5210 MHz	58	5290 MHz	106	5530 MHz
122	5610 MHz	138	5690 MHz	155	5775 MHz

1.7. Antennas Information

Antenna Type	Frequency Band (MHz)	T _x Paths	Antenna Gain (dBi)
Bluetooth			
PCB Antenna	2402 ~ 2480	1	2.0
Wi-Fi			
PCB Antenna	2412 ~ 2462	1	-0.02
	5180 ~ 5240	1	2.53
	5260 ~ 5320	1	1.99
	5500 ~ 5720	1	1.49
	5745 ~ 5825	1	1.51

2. Test Configuration

2.1. Test Mode

Mode 1: Transmit by 802.11a (6Mbps)
Mode 2: Transmit by 802.11ac-VHT20 (MCS0)
Mode 3: Transmit by 802.11ac-VHT40 (MCS0)
Mode 4: Transmit by 802.11ac-VHT80 (MCS0)

Note: Due to the same modulation between 802.11n and 802.11ac, so 802.11n-HT20 and HT40 are covered by 802.11ac-VHT20 and VHT40 in this report, meanwhile, power level for 802.11n-HT20 and HT40 will not be greater than 802.11ac-VHT20 and VHT40.

2.2. Test System Connection Diagram

The device was tested per the guidance ANSI C63.10: 2013 was used to reference the appropriate EUT setup for radiated emissions testing and AC line conducted testing.

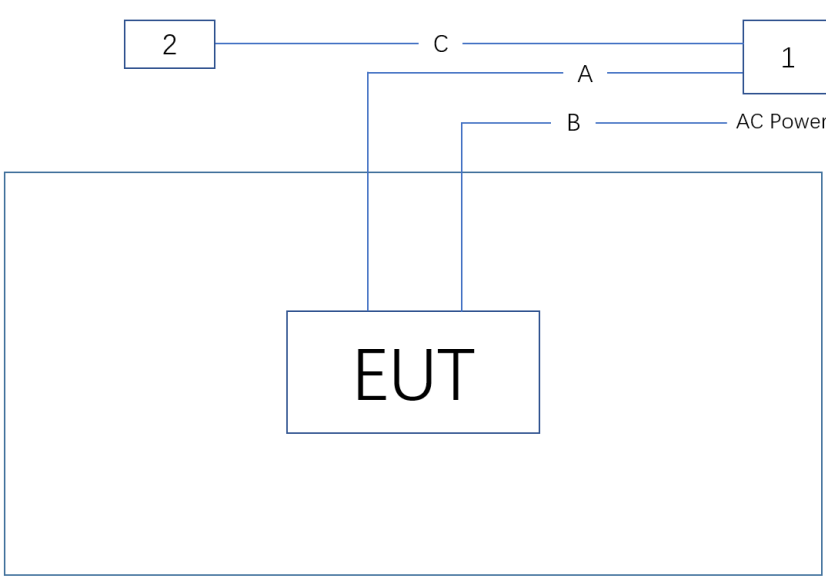
Connection Diagram			
			
Cable Type		Cable Spec.	Length
A	LAN Cable	Shielded	> 10.0m
B	Power Cable	Non-Shielded	< 3.0m
C	LAN Cable	Non-Shielded	< 2.0m
Product		Manufacturer	Model No.
1	Router	NETGEAR	R6220
2	Notebook	Lenovo	E431

2.3. Test Software

The test utility software used during testing was “SecureCRT”, and the version was 6.2.3 (build 313).

2.4. Applied Standards

According to the specifications of the manufacturer, the EUT must comply with the requirements of the following standards:

- FCC Part 15.407
- KDB 789033 D02v02r01
- ANSI C63.10-2013

2.5. Test Environment Condition

Ambient Temperature	15 ~ 35°C
Relative Humidity	20 ~ 75%RH

3. Antenna Requirements

Excerpt from §15.203 of the FCC Rules/Regulations:

“An intentional radiator antenna shall be designed to ensure that no antenna other than that furnished by the responsible party can be used with the device. The use of a permanently attached antenna or of an antenna that uses a unique coupling to the intentional radiator shall be considered sufficient to comply with the provisions of this section.”

- The antenna of the device is **permanently attached**.
- There are no provisions for connection to an external antenna.

Conclusion:

The unit complies with the requirement of §15.203.

4. Measuring Instrument

Instrument	Manufacturer	Model No.	Asset No.	Cali. Interval	Cali. Due Date	Test Site
EMI Test Receiver	R&S	ESR7	MRTSUE06001	1 year	2021/12/30	WZ-AC1
				1 year	2022/12/29	WZ-AC1
Horn Antenna	Schwarzbeck	BBHA 9120D	MRTSUE06023	1 year	2022/9/16	WZ-AC1
Preamplifier	Agilent	83017A	MRTSUE06076	1 year	2021/11/13	WZ-AC1
				1 year	2022/11/12	WZ-AC1
TRILOG Antenna	Schwarzbeck	VULB 9168	MRTSUE06172	1 year	2022/8/5	WZ-AC1
Anechoic Chamber	TDK3	WZ-AC1	MRTSUE06212	1 year	2022/4/29	WZ-AC1
Thermohygrometer	testo	608-H1	MRTSUE06403	1 year	2022/6/28	WZ-AC1
Signal Analyzer	Keysight	N9010B	MRTSUE06607	1 year	2021/12/30	WZ-AC1
				1 year	2022/12/29	WZ-AC1
Thermohygrometer	testo	Testo 608-H1	MRTSUE11039	1 year	2021/11/12	WZ-AC1
				1 year	2022/11/11	WZ-AC1
Loop Antenna	Schwarzbeck	FMZB 1519	MRTSUE06025	1 year	2021/10/29	WZ-AC1/WZ-AC2
				1 year	2022/10/28	WZ-AC1/WZ-AC2
Horn Antenna	ETS	3117	MRTSUE06257	1 year	2021/9/26	WZ-AC1/WZ-AC2
				1 year	2022/9/25	WZ-AC1/WZ-AC2
Horn Antenna	Schwarzbeck	BBHA 9170	MRTSUE06597	1 year	2021/12/15	WZ-AC1/WZ-AC2
				1 year	2022/12/14	WZ-AC1/WZ-AC2
TRILOG Antenna	Schwarzbeck	VULB 9162	MRTSUE06022	1 year	2022/5/24	WZ-AC2
EMI Test Receiver	Agilent	N9038A	MRTSUE06125	1 year	2022/6/24	WZ-AC2
Thermohygrometer	Mingle	ETH529	MRTSUE06170	1 year	2021/12/8	WZ-AC2
				1 year	2022/12/1	WZ-AC2
Horn Antenna	Schwarzbeck	BBHA 9120D	MRTSUE06171	1 year	2021/10/25	WZ-AC2
				1 year	2022/10/21	WZ-AC2
Preamplifier	Schwarzbeck	BBV 9718	MRTSUE06176	1 year	2021/11/14	WZ-AC2
				1 year	2022/11/12	WZ-AC2
Anechoic Chamber	RIKEN	WZ-AC2	MRTSUE06213	1 year	2022/4/29	WZ-AC2
Two-Line V-Network	R&S	ENV216	MRTSUE06002	1 year	2022/6/8	WZ-SR2
Shielding Room	MIX-BEP	WZ-SR2	MRTSUE06215	/	/	WZ-SR2
Thermohygrometer	testo	608-H1	MRTSUE06404	1 year	2022/6/28	WZ-SR2
FR1 Switching Unit	R&S	ESR3	MRTSUE06909	1 year	2021/11/2	WZ-SR2
				1 year	2022/11/1	WZ-SR2
Signal Analyzer	Agilent	N9020A	MRTSUE06106	1 year	2022/4/13	WZ-SR5
Thermohygrometer	testo	608-H1	MRTSUE06402	1 year	2022/6/28	WZ-SR5
Shielding Room	HUAMING	WZ-SR5	MRTSUE06442	/	/	WZ-SR5



Instrument	Manufacturer	Model No.	Asset No.	Cali. Interval	Cali. Due Date	Test Site
Signal Analyzer	Keysight	N9010B	MRTSUE06457	1 year	2022/6/24	WZ-SR5

Software	Version	Function
EMI Software	V3	EMI Test Software

5. Measurement Uncertainty

Where relevant, the following test uncertainty levels have been estimated for tests performed on the EUT as specified in CISPR 16-4-2. This uncertainty represents an expanded uncertainty expressed at approximately the 95% confidence level using a coverage factor of $k = 2$.

AC Conducted Emission Measurement
Measurement Uncertainty for a Level of Confidence of 95% ($U=2Uc(y)$): 9kHz~150kHz: 3.74dB 150kHz~30MHz: 3.44dB
Radiated Emission Measurement
Measurement Uncertainty for a Level of Confidence of 95% ($U=2Uc(y)$): Horizontal: 30MHz~300MHz: 5.04dB 300MHz~1GHz: 4.95dB 1GHz~40GHz: 6.40dB Vertical: 30MHz~300MHz: 5.24dB 300MHz~1GHz: 6.03dB 1GHz~40GHz: 6.40dB
Spurious Emissions, Conducted
Measuring Uncertainty for a Level of Confidence of 95% ($U=2Uc(y)$): 0.78dB
Output Power
Measuring Uncertainty for a Level of Confidence of 95% ($U=2Uc(y)$): 1.13dB
Power Spectrum Density
Measuring Uncertainty for a Level of Confidence of 95% ($U=2Uc(y)$): 1.15dB
Occupied Bandwidth
Measuring Uncertainty for a Level of Confidence of 95% ($U=2Uc(y)$): 0.28%

6. Test Result

6.1. Summary

FCC Section(s)	Test Description	Test Condition	Verdict
15.407(a)	26dB Bandwidth	Conducted	Pass
15.407(e)	6dB Bandwidth		Pass
15.407(a)(1)(iv), (2), (3)(i)	Maximum Conducted Output Power		Pass
15.407(h)(1)	Transmit Power Control		Pass
15.407(a)(1)(iv), (2), (3)(i), (12)	Peak Power Spectral Density		Pass
15.407(g)	Frequency Stability		Pass
15.407(b)(1), (2), (3), (4)(i)	Undesirable Emissions		Pass
15.205, 15.209 15.407(b)(9), (10), (11)	General Field Strength Limits (Restricted Bands and Radiated Emission Limits)	Radiated	Pass
15.207	AC Conducted Emissions 150kHz - 30MHz	Line Conducted	Pass

Remark:

The analyzer plots shown in this section were all taken with a correction table loaded into the analyzer. The correction table was used to account for the losses of the cables and attenuators used as part of the system to connect the EUT to the analyzer at all frequencies of interest.

6.2. 26dB & 99% Bandwidth

6.2.1. Test Limit

N/A

6.2.2. Test Procedure used

KDB 789033 D02v02r01- Section II) C.1 (26dB Bandwidth)

KDB 789033 D02v02r01- Section II) D (99% Bandwidth)

6.2.3. Test Setting

26dB Bandwidth

1. The analyzers' automatic bandwidth measurement capability was used to perform the 26dB bandwidth measurement. The "X" dB bandwidth parameter was set to $X = 26$. The automatic bandwidth measurement function also has the capability of simultaneously measuring the 99% occupied bandwidth. The bandwidth measurement was not influenced by any intermediated power nulls in the fundamental emission.
2. RBW = approximately 1% of the emission bandwidth.
3. $VBW \geq 3 \times RBW$.
4. Detector = Peak.
5. Trace mode = max hold.

99% Bandwidth

1. Set center frequency to the nominal EUT channel center frequency.
2. Set span = 1.5 times to 5.0 times the OBW.
3. Set RBW = 1% to 5% of the OBW
4. Set $VBW \geq 3 \times RBW$
5. Detector = Peak.
6. Use the 99% power bandwidth function of the instrument.

6.2.4. Test Setup

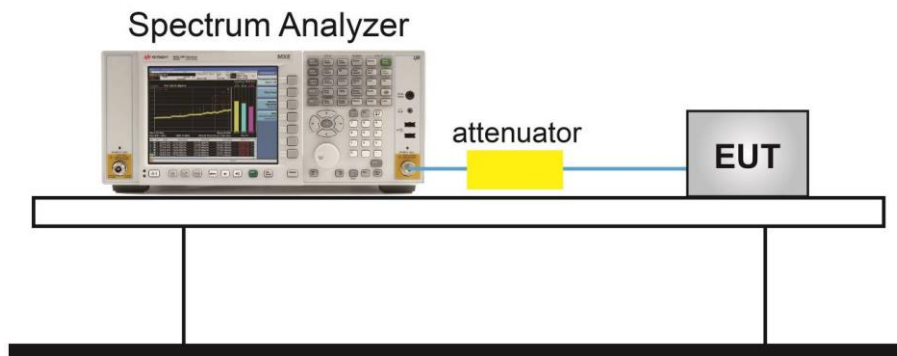

6.2.5. Test Result

Refer to Appendix A.2.

6.3. 6dB Bandwidth

6.3.1. Test Limit

The minimum 6dB bandwidth shall be at least 500 kHz.

6.3.2. Test Procedure used

KDB 789033 D02v02r01- Section II) C.2

6.3.3. Test Setting

1. Set center frequency to the nominal EUT channel center frequency.
2. RBW = 100 kHz.
3. VBW 3 × RBW.
4. Detector = Peak.
5. Trace mode = max hold.
6. Sweep = auto couple.
7. Allow the trace to stabilize.
8. Measure the maximum width of the emission that is constrained by the frequencies associated with the two outermost amplitude points (upper and lower frequencies) that are attenuated by 6 dB relative to the maximum level measured in the fundamental emission.

6.3.4. Test Setup

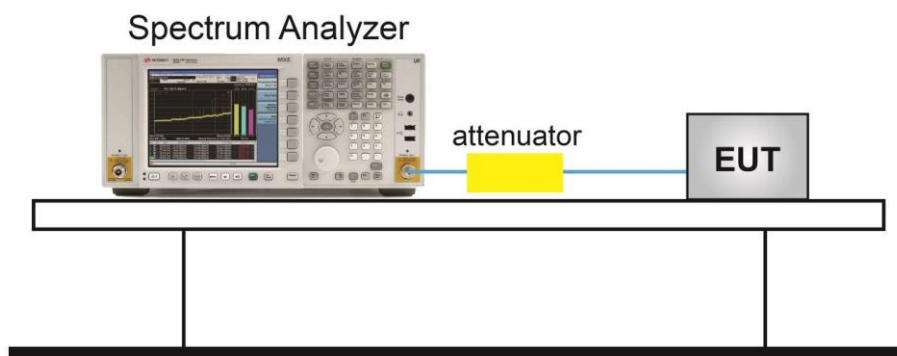

6.3.5. Test Result

Refer to Appendix A.3.

6.4. Output Power

6.4.1. Test Limit

For client devices in the 5.15-5.25 GHz band, the maximum conducted output power over the frequency band of operation shall not exceed 250 mW provided the maximum antenna gain does not exceed 6 dBi.

For the 5.25-5.35 GHz and 5.47-5.725 GHz bands, the maximum conducted output power over the frequency bands of operation shall not exceed the lesser of 250 mW or $11 \text{ dBm} + 10 \log B$, where B is the 26 dB emission bandwidth in megahertz.

For the band 5.725-5.85 GHz, the maximum conducted output power over the frequency band of operation shall not exceed 1 W (30dBm).

If transmitting antennas of directional gain greater than 6dBi are used, the maximum conducted output power shall be reduced by the amount in dB that the directional gain of the antenna exceeds 6dBi.

6.4.2. Test Procedure Used

KDB 789033D02v02r01- Section E)3)b) Method PM-G

6.4.3. Test Setting

Average Power Measurement

Average power measurements were performed only when the EUT was transmitting at its maximum power control level using a broadband power meter with a pulse sensor. The power meter implemented triggering and gating capabilities which were set up such that power measurements were recorded only during the ON time of the transmitter.

6.4.4. Test Setup

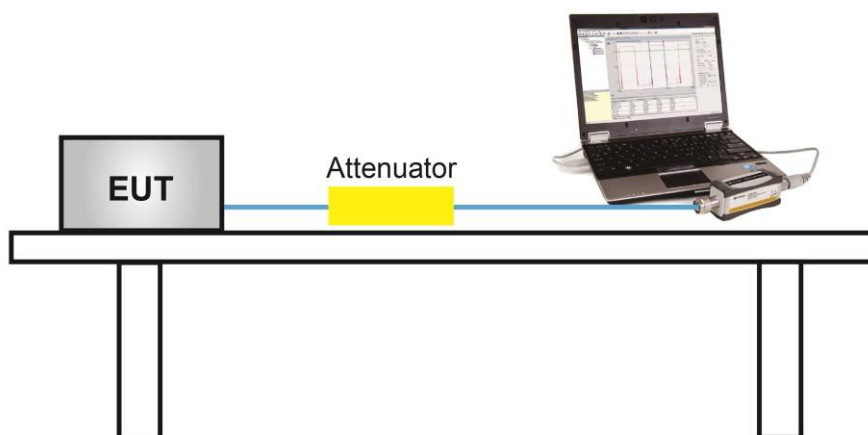

6.4.5. Test Result

Refer to Appendix A.4.

6.5. Transmit Power Control

6.5.1. Test Limit

The U-NII device is required to have the capability to operate at least 6 dB below the mean EIRP value of 30 dBm.

6.5.2. Test Procedure Used

KDB 789033 D02v01- Section E)3)b) Method PM-G

6.5.3. Test Setting

Average power measurements were performed only when the EUT was transmitting at its maximum power control level using a broadband power meter with a pulse sensor. The power meter implemented triggering and gating capabilities which were set up such that power measurements were recorded only during the ON time of the transmitter. The trace was averaged over 100 traces to obtain the final measured average power.

6.5.4. Test Setup

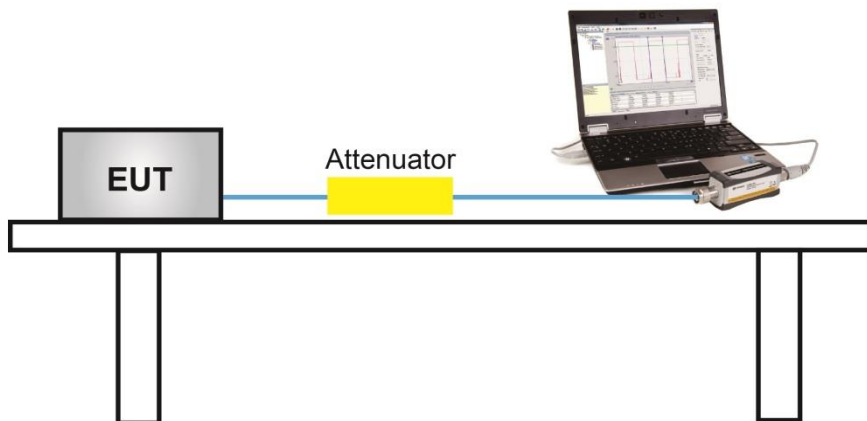

6.5.5. Test Result

A TPC mechanism is not required for systems with an e.i.r.p. of less than 500 mW.

6.6. Power Spectral Density

6.6.1. Test Limit

For client devices in the 5.15-5.25 GHz band, the maximum power spectral density shall not exceed 11 dBm in any 1 megahertz band.

For the 5.25-5.35 GHz and 5.47-5.725 GHz bands, the maximum power spectral density shall not exceed 11 dBm in any 1 megahertz band.

For the band 5.725-5.85 GHz, the maximum power spectral density shall not exceed 30 dBm in any 500-kHz band.

If transmitting antennas of directional gain greater than 6dBi are used, the peak power spectral density shall be reduced by the amount in dB that the directional gain of the antenna exceeds 6dBi.

6.6.2. Test Procedure Used

KDB 789033 D02v02r01-SectionF

6.6.3. Test Setting

1. Analyzer was set to the center frequency of the UNII channel under investigation
2. Span was set to encompass the entire 26dB EBW of the signal
3. RBW = 1MHz (510kHz, if measurement bandwidth of Maximum PSD is specified in 500 kHz), VBW = 3MHz
4. Number of sweep points $\geq 2 \times (\text{span} / \text{RBW})$
5. Detector = power averaging (Average)
6. Sweep time = auto
7. Trigger = free run
8. Use the peak search function on the instrument to find the peak of the spectrum and record its value.
9. Add $10 \cdot \log(1/x)$, where x is the duty cycle, to the measured power in order to compute the average power during the actual transmission times (because the measurement represents an average over both the on and off times of the transmission). For example, add $10 \cdot \log(1/0.25) = 6$ dB if the duty cycle is 25 percent.

6.6.4. Test Setup

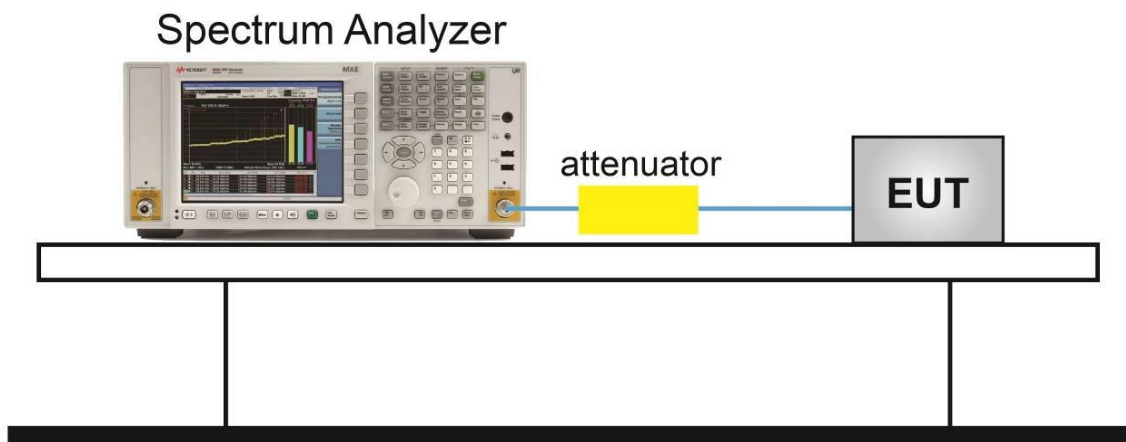

6.6.5. Test Result

Refer to Appendix A.5.

6.7. Frequency Stability Measurement

6.7.1. Test Limit

Manufactures of U-NII devices are responsible for ensuring frequency stability such that an emission is maintained within the band of operation under all conditions of normal operation as specified in the user's manual.

6.7.2. Test Procedure Used

Frequency Stability Under Temperature Variations:

The equipment under test was connected to an external AC or DC power supply and input rated voltage. RF output was connected to a frequency counter or spectrum analyzer via feed through attenuators. The EUT was placed inside the temperature chamber. Set the spectrum analyzer RBW low enough to obtain the desired frequency resolution and measure EUT 20°C operating frequency as reference frequency. Turn EUT off and set the chamber temperature to highest. After the temperature stabilized for approximately 30 minutes recorded the frequency. Repeat step measure with 10°C decreased per stage until the lowest temperature reached.

Frequency Stability Under Voltage Variations:

Set chamber temperature to 20°C. Use a variable AC power supply / DC power source to power the EUT and set the voltage to rated voltage. Set the spectrum analyzer RBW low enough to obtain the desired frequency resolution and recorded the frequency.

Reduce the input voltage to specify extreme voltage variation ($\pm 15\%$) and endpoint, record the maximum frequency change.

6.7.3. Test Setup

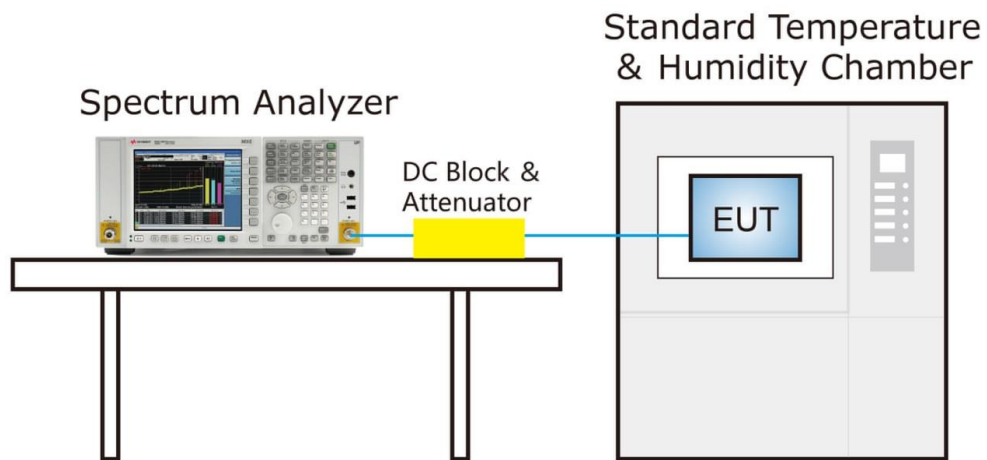

6.7.4. Test Result

Refer to Appendix A.5.

6.8. Radiated Spurious Emission

6.8.1. Test Limit

All out of band emissions appearing in a restricted band as specified in Section 15.205 of the Title 47 CFR must not exceed the limits shown in Table per Section 15.209.

FCC Part 15 Subpart C Paragraph 15.209		
Frequency [MHz]	Field Strength [uV/m]	Measured Distance [Meters]
0.009 - 0.490	2400/F (kHz)	300
0.490 - 1.705	24000/F (kHz)	30
1.705 - 30	30	30
30 - 88	100	3
88 - 216	150	3
216 - 960	200	3
Above 960	500	3

6.8.2. Test Procedure Used

KDB 789033 D02v02r01- Section II) G

6.8.3. Test Setting

Table 1 - RBW as a function of frequency

Frequency	RBW
9 ~ 150 kHz	200 ~ 300 Hz
0.15 ~ 30 MHz	9 ~ 10 kHz
30 ~ 1000 MHz	100 ~ 120 kHz
> 1000MHz	1MHz

Quasi-Peak Measurements below 1GHz

1. Analyzer center frequency was set to the frequency of the radiated spurious emission of interest
2. Span was set greater than 1MHz
3. RBW = as specified in Table 1
4. Detector = CISPR quasi-peak
5. Sweep time = auto couple
6. Trace was allowed to stabilize

Peak Measurements above 1GHz

1. Analyzer center frequency was set to the frequency of the radiated spurious emission of interest
2. RBW = 1MHz
3. VBW = 3MHz
4. Detector = peak
5. Sweep time = auto couple
6. Trace mode = max hold
7. Trace was allowed to stabilize

Average Measurements above 1GHz (Method VB)

1. Analyzer center frequency was set to the frequency of the radiated spurious emission of interest
2. RBW = 1MHz
3. VBW; If the EUT is configured to transmit with duty cycle $\geq 98\%$, set VBW = 10 Hz.
If the EUT duty cycle is $< 98\%$, set VBW $\geq 1/T$. T is the minimum transmission duration.
4. Detector = Peak
5. Sweep time = auto
6. Trace mode = max hold
7. Trace was allowed to stabilize

6.8.4. Test Setup

Below 1GHz Test Setup:

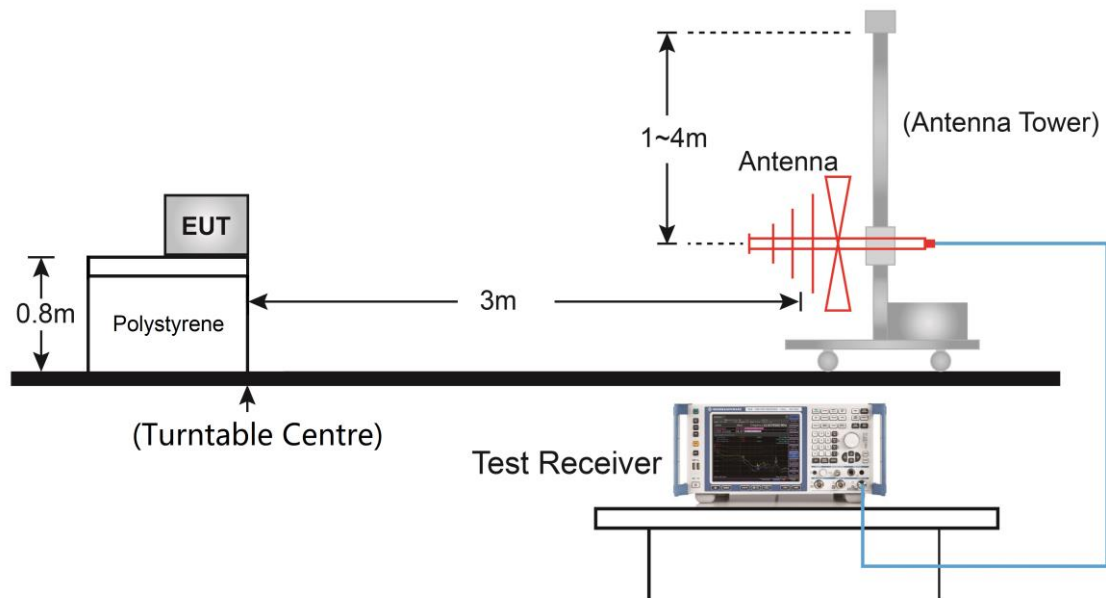

Above 1GHz Test Setup:

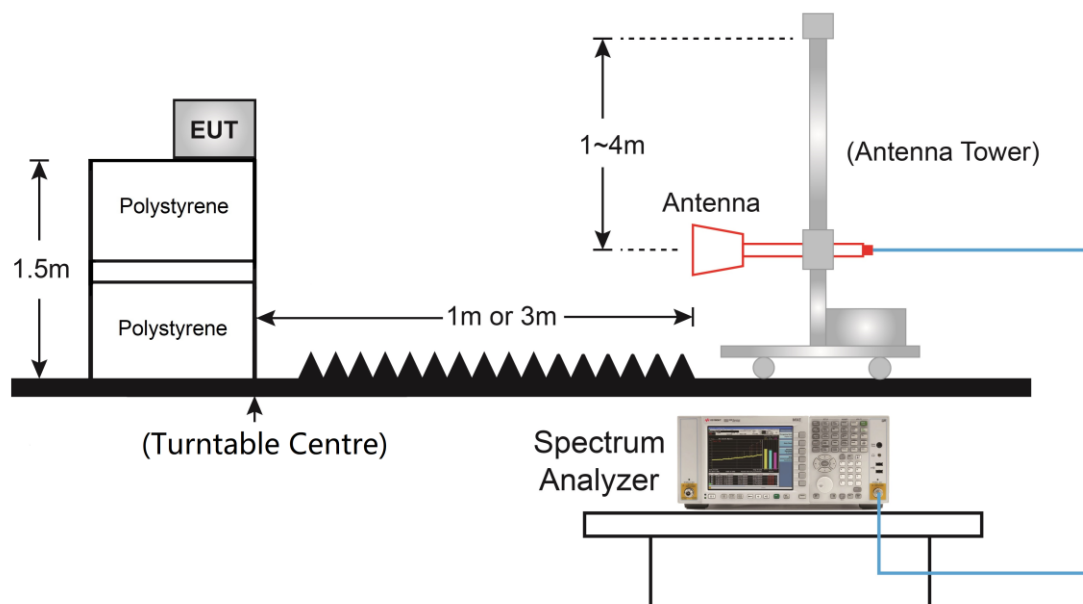

6.8.5. Test Result

Refer to Appendix A.6.

6.9. Radiated Restricted Band Edge

6.9.1. Test Limit

For 15.205 requirement:

Radiated emissions which fall in the restricted bands, as defined in Section 15.205(a) of FCC part 15, must also comply with the radiated emission limits specified in Section 15.209(a).

Frequency (MHz)	Frequency (MHz)	Frequency (MHz)	Frequency (GHz)
0.090 - 0.110	16.42 - 16.423	399.9 - 410	4.5 - 5.15
¹ 0.495 - 0.505	16.69475 - 16.69525	608 - 614	5.35 - 5.46
2.1735 - 2.1905	16.80425 - 16.80475	960 - 1240	7.25 - 7.75
4.125 - 4.128	25.5 - 25.67	1300 - 1427	8.025 - 8.5
4.17725 - 4.17775	37.5 - 38.25	1435 - 1626.5	9.0 - 9.2
4.20725 - 4.20775	73 - 74.6	1645.5 - 1646.5	9.3 - 9.5
6.215 - 6.218	74.8 - 75.2	1660 - 1710	10.6 - 12.7
6.26775 - 6.26825	108 - 121.94	1718.8 - 1722.2	13.25 - 13.4
6.31175 - 6.31225	123 - 138	2200 - 2300	14.47 - 14.5
8.291 - 8.294	149.9 - 150.05	2310 - 2390	15.35 - 16.2
8.362 - 8.366	156.52475 - 156.52525	2483.5 - 2500	17.7 - 21.4
8.37625 - 8.38675	156.7 - 156.9	2690 - 2900	22.01 - 23.12
8.41425 - 8.41475	162.0125 - 167.17	3260 - 3267	23.6 - 24.0
12.29 - 12.293	167.72 - 173.2	3332 - 3339	31.2 - 31.8
12.51975 - 12.52025	240 - 285	3345.8 - 3358	36.43 - 36.5
12.57675 - 12.57725	322 - 335.4	3600 - 4400	(²)
13.36 - 13.41	--	--	--

For 15.407(b) requirement:

For transmitters operating in the 5.15-5.25 GHz band: All emissions outside of the 5.15-5.35 GHz band shall not exceed an e.i.r.p. of -27 dBm/MHz.

For transmitters operating in the 5.25-5.35 GHz band: All emissions outside of the 5.15-5.35 GHz band shall not exceed an e.i.r.p. of -27 dBm/MHz.

For transmitters operating in the 5.47-5.725 GHz band: All emissions outside of the 5.47-5.725 GHz band shall not exceed an e.i.r.p. of -27 dBm/MHz.

For transmitters operating in the 5.725-5.85 GHz band: All emissions shall be limited to a level of -27 dBm/MHz at 75 MHz or more above or below the band edge increasing linearly to 10 dBm/MHz at 25 MHz above or below the band edge, and from 25 MHz above or below the band edge increasing linearly to a level

of 15.6 dBm/MHz at 5 MHz above or below the band edge, and from 5 MHz above or below the band edge increasing linearly to a level of 27 dBm/MHz at the band edge.

Refer to KDB 789033 D02v02r01 G)2)c), as specified in § 15.407(b), emissions above 1000 MHz that are outside of the restricted bands are subject to a maximum emission limit of -27 dBm/MHz (or -17 dBm/MHz as specified in § 15.407(b)(4)). However, an out-of-band emission that complies with both the peak and average limits of § 15.209 is not required to satisfy the -27 dBm/MHz or -17 dBm/MHz maximum emission limit.

All out of band emissions appearing in a restricted band as specified in Section 15.205 of the Title 47CFR must not exceed the limits shown in Table per Section 15.209.

FCC Part 15 Subpart C Paragraph 15.209		
Frequency [MHz]	Field Strength [uV/m]	Measured Distance [Meters]
0.009 - 0.490	2400/F (kHz)	300
0.490 - 1.705	24000/F (kHz)	30
1.705 - 30	30	30
30 - 88	100	3
88 - 216	150	3
216 - 960	200	3
Above 960	500	3

6.9.2. Test Procedure Used

KDB 789033 D02v02r01- Section II) G

6.9.3. Test Setting

Peak Measurements above 1GHz

1. Analyzer center frequency was set to the frequency of the radiated spurious emission of interest
2. RBW = 1MHz
3. VBW = 3MHz
4. Detector = Peak
5. Sweep time = Auto couple
6. Trace mode = Max hold
7. Trace was allowed to stabilize

Average Measurements above 1GHz (Method VB)

1. Analyzer center frequency was set to the frequency of the radiated spurious emission of interest
2. RBW = 1MHz
3. VBW; if the EUT is configured to transmit with duty cycle $\geq 98\%$, set VBW = 10Hz
4. If the EUT duty cycle is $< 98\%$, set VBW $\geq 1/T$. T is the minimum transmission duration
5. Detector = Peak
6. Sweep time = Auto
7. Trace mode = Max hold
8. Trace was allowed to stabilize

6.9.4. Test Setup

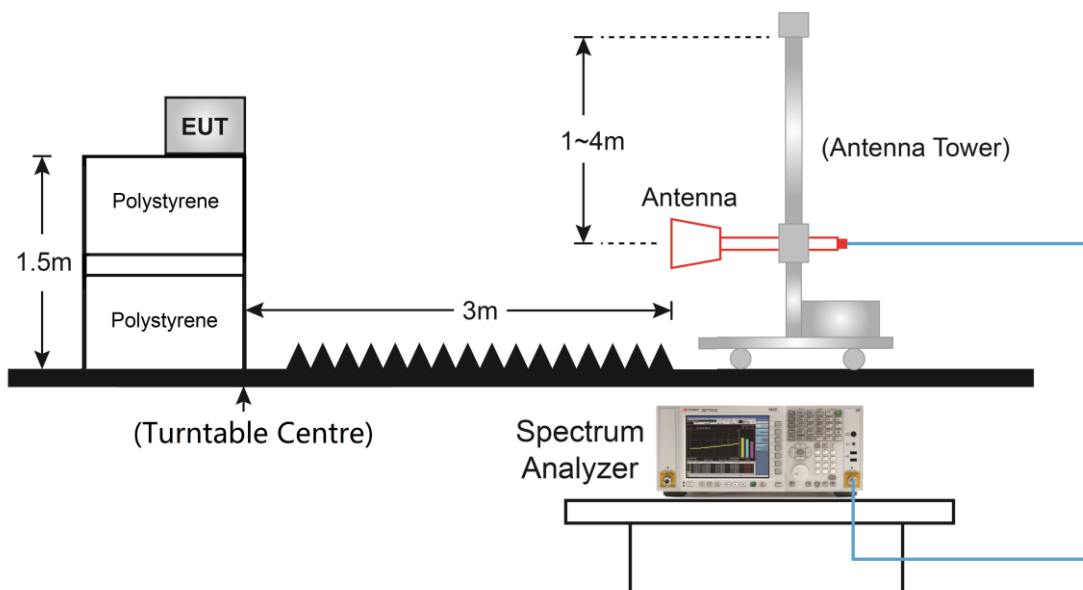

6.9.5. Test Result

Refer to Appendix A.7.

6.10. AC Conducted Emissions

6.10.1. Test Limit

FCC Part 15.207 Limits		
Frequency (MHz)	QP (dBuV)	AV (dBuV)
0.15 - 0.50	66 - 56	56 - 46
0.50 - 5.0	56	46
5.0 - 30	60	50

Note 1: The lower limit shall apply at the transition frequencies.

Note 2: The limit decreases linearly with the logarithm of the frequency in the range 0.15MHz to 0.5MHz.

6.10.2. Test Setup

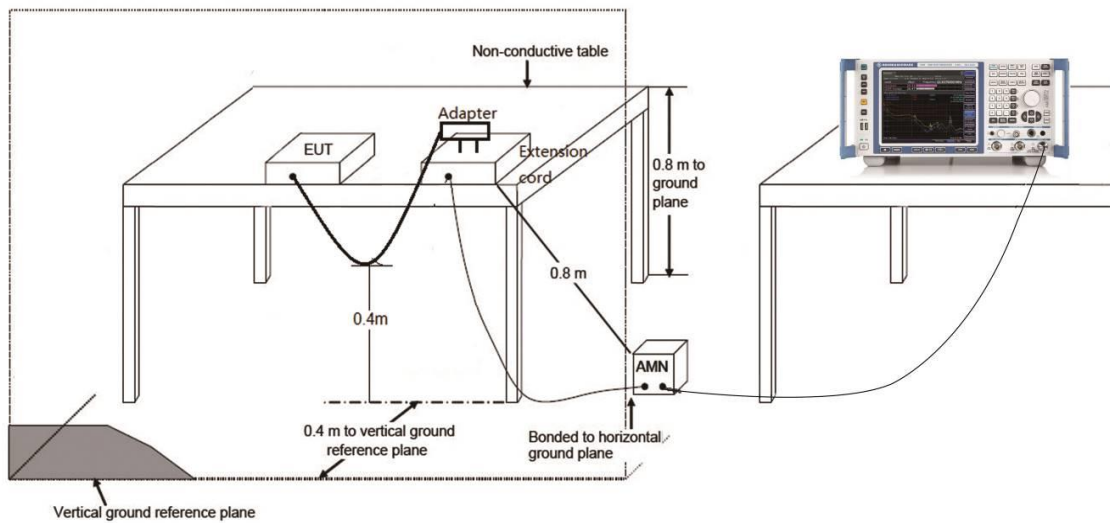

6.10.3. Test Result

Refer to Appendix A.8.

Appendix A – Test Result

A.1 Duty Cycle Test Result

Test Site	WZ-SR5	Test Engineer	Liz Yuan
Test Date	2021/09/23		

Test Mode	Duty Cycle	Test Mode	Duty Cycle
802.11a	95.07%	802.11ac-VHT40	87.41%
802.11ac-VHT20	94.76%	802.1ac-VHT80	81.23%

Duty Cycle (T = Transmission Duration)

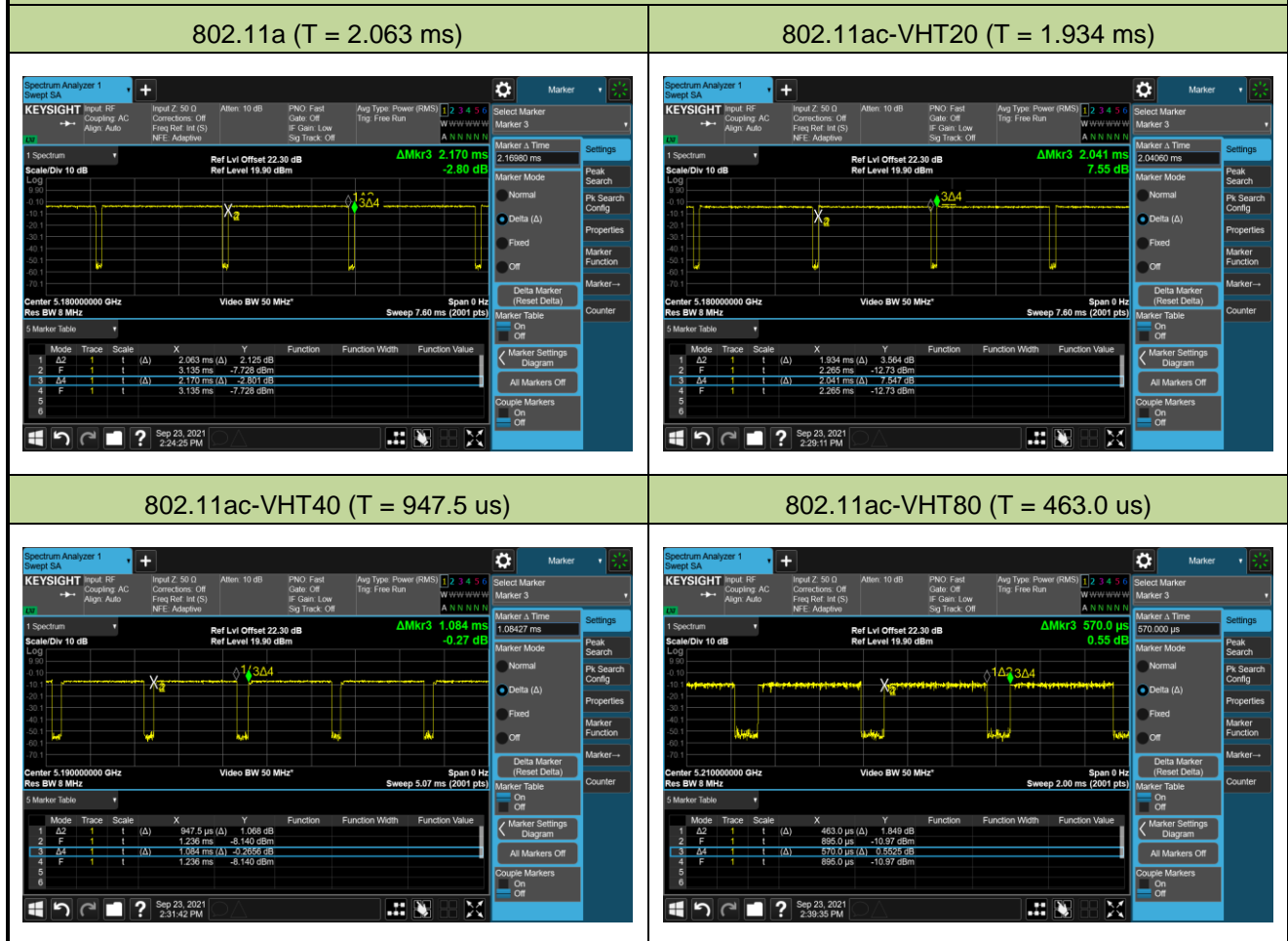

A.2 26dB & 99% Bandwidth Test Result

Test Site	WZ-SR5	Test Engineer	Liz Yuan
Test Date	2021/09/23		

Test Mode	Data Rate/ MCS	Channel No.	Frequency (MHz)	26dB Bandwidth (MHz)	99% Bandwidth (MHz)
802.11a	6Mbps	36	5180	32.90	17.32
802.11a	6Mbps	44	5220	33.82	17.46
802.11a	6Mbps	48	5240	33.70	17.23
802.11a	6Mbps	52	5260	32.89	17.65
802.11a	6Mbps	60	5300	34.03	19.20
802.11a	6Mbps	64	5320	33.79	19.07
802.11a	6Mbps	100	5500	33.13	17.69
802.11a	6Mbps	116	5580	32.72	17.11
802.11a	6Mbps	120	5600	33.60	18.49
802.11a	6Mbps	140	5700	33.88	17.90
802.11a	6Mbps	144	5720	34.20	18.42
802.11a	6Mbps	149	5745	34.20	19.01
802.11a	6Mbps	157	5785	33.24	17.29
802.11a	6Mbps	165	5825	34.50	17.48
802.11ac-VHT20	MCS0	36	5180	36.13	18.84
802.11ac-VHT20	MCS0	44	5220	36.47	19.22
802.11ac-VHT20	MCS0	48	5240	36.15	19.39
802.11ac-VHT20	MCS0	52	5260	36.37	19.11
802.11ac-VHT20	MCS0	60	5300	35.37	19.01
802.11ac-VHT20	MCS0	64	5320	35.32	19.08
802.11ac-VHT20	MCS0	100	5500	32.87	18.30
802.11ac-VHT20	MCS0	116	5580	36.17	19.01
802.11ac-VHT20	MCS0	120	5600	36.14	18.69
802.11ac-VHT20	MCS0	140	5700	32.93	18.12
802.11ac-VHT20	MCS0	144	5720	34.97	18.35
802.11ac-VHT20	MCS0	149	5745	36.37	18.94
802.11ac-VHT20	MCS0	157	5785	32.58	18.03
802.11ac-VHT20	MCS0	165	5825	31.75	18.14

Test Mode	Data Rate/ MCS	Channel No.	Frequency (MHz)	26dB Bandwidth (MHz)	99% Bandwidth (MHz)
802.11ac-VHT40	MCS0	38	5190	73.03	36.99
802.11ac-VHT40	MCS0	46	5230	74.25	37.38
802.11ac-VHT40	MCS0	54	5270	73.05	37.08
802.11ac-VHT40	MCS0	62	5310	76.18	37.91
802.11ac-VHT40	MCS0	102	5510	73.08	37.11
802.11ac-VHT40	MCS0	110	5550	75.57	38.22
802.11ac-VHT40	MCS0	118	5590	75.22	37.60
802.11ac-VHT40	MCS0	134	5670	74.51	36.94
802.11ac-VHT40	MCS0	142	5710	74.18	37.27
802.11ac-VHT40	MCS0	151	5755	76.02	38.20
802.11ac-VHT40	MCS0	159	5795	53.79	36.16
802.11ac-VHT80	MCS0	42	5210	114.1	75.48
802.11ac-VHT80	MCS0	58	5290	134.3	76.76
802.11ac-VHT80	MCS0	106	5530	152.1	77.44
802.11ac-VHT80	MCS0	122	5610	151.6	77.24
802.11ac-VHT80	MCS0	138	5690	152.3	78.76
802.11ac-VHT80	MCS0	155	5775	107.8	75.70

802.11a 26dB & 99% Bandwidth

Channel 36 (5180MHz)

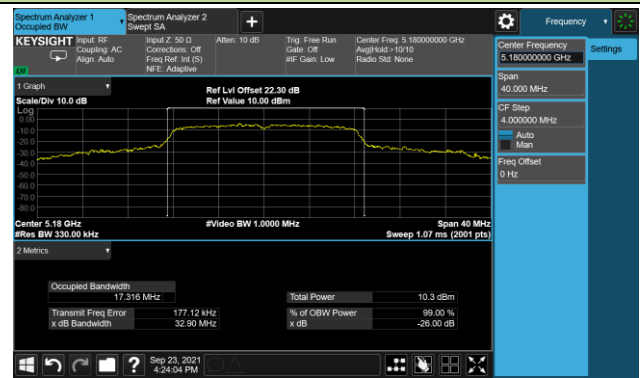

Channel 44 (5220MHz)

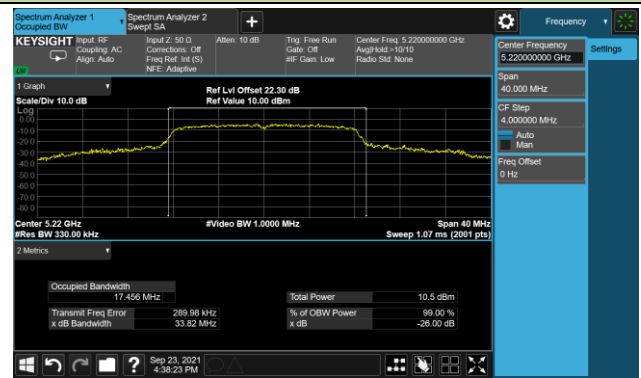

Channel 48 (5240MHz)

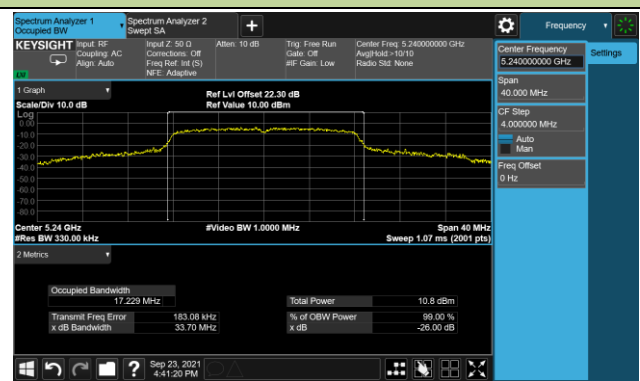

Channel 52 (5260MHz)

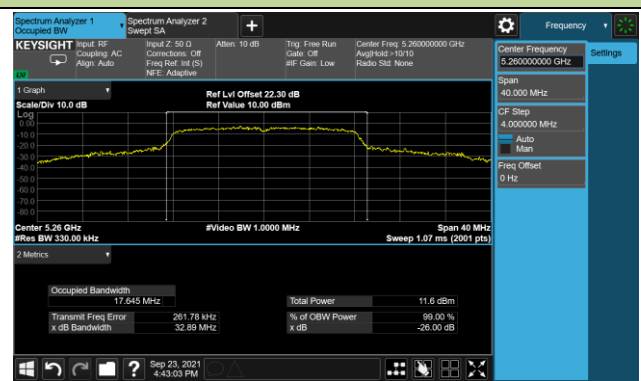

Channel 60 (5300MHz)

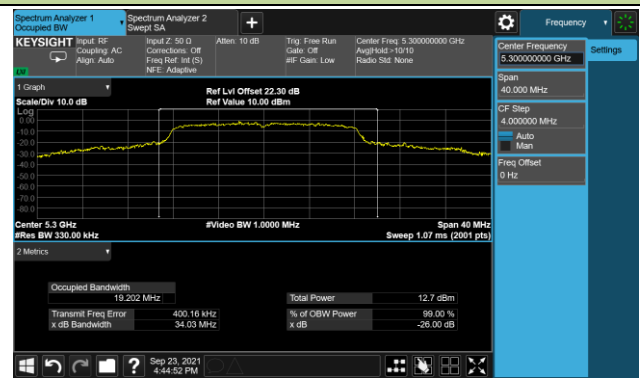

Channel 64 (5320MHz)

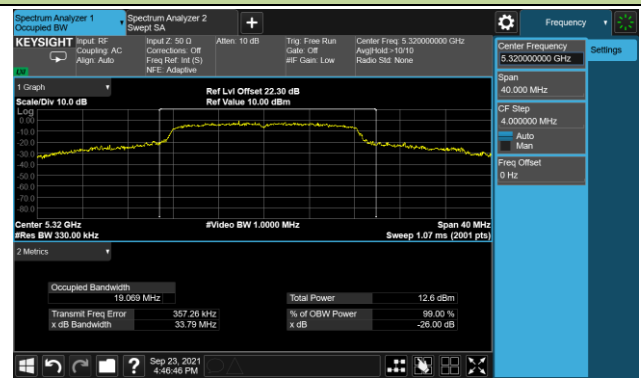

Channel 100 (5500MHz)

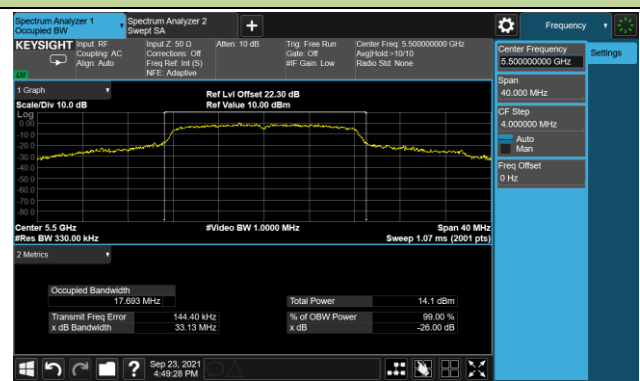

Channel 116 (5580MHz)

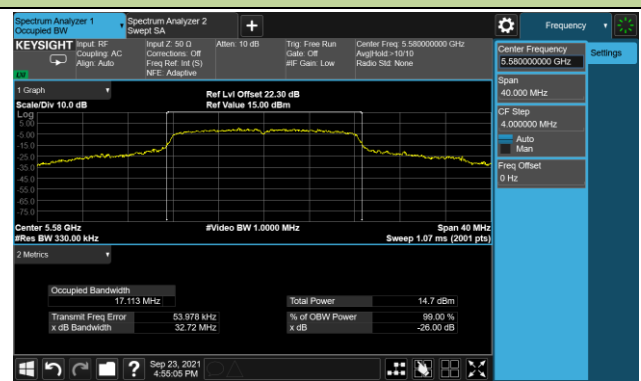

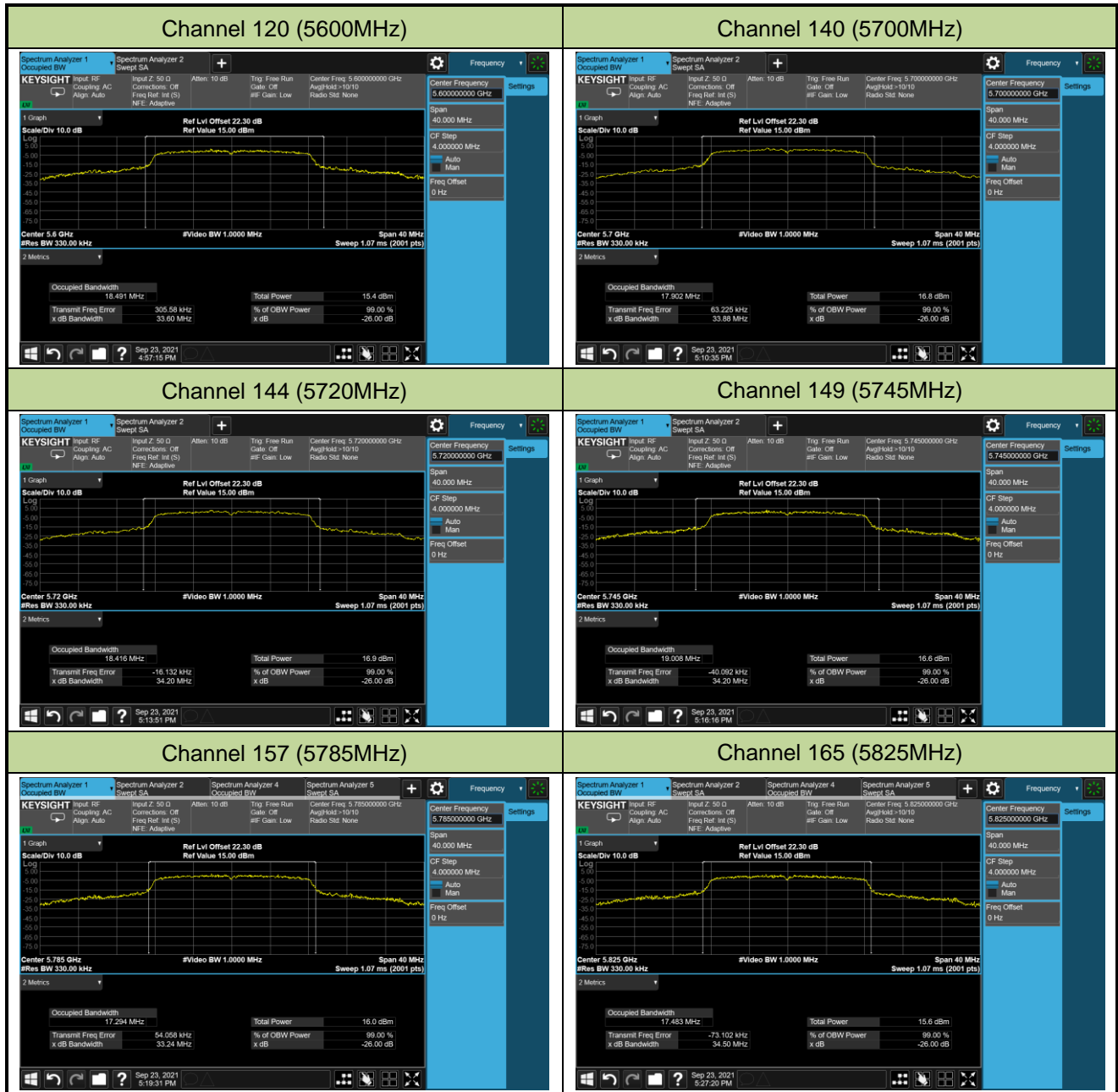

802.11ac-VHT20 26dB & 99% Bandwidth

Channel 36 (5180MHz)

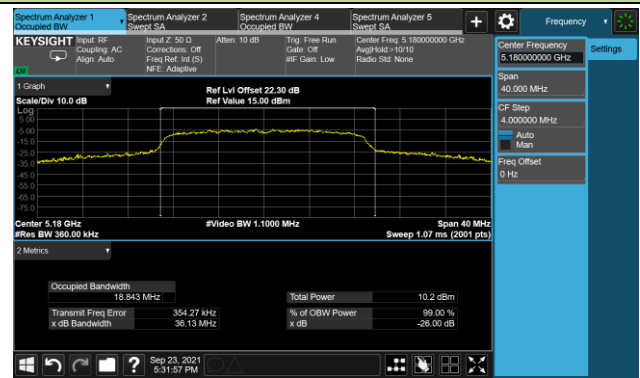

Channel 44 (5220MHz)

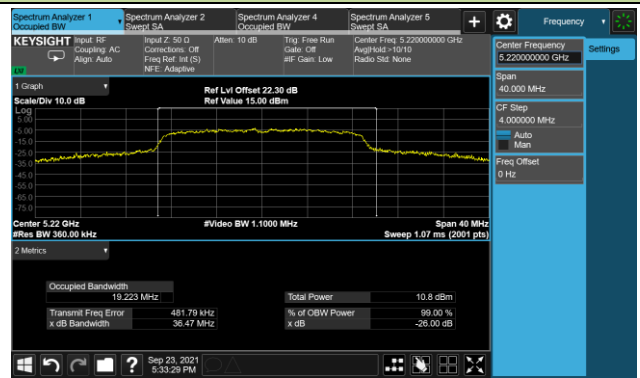

Channel 48 (5240MHz)

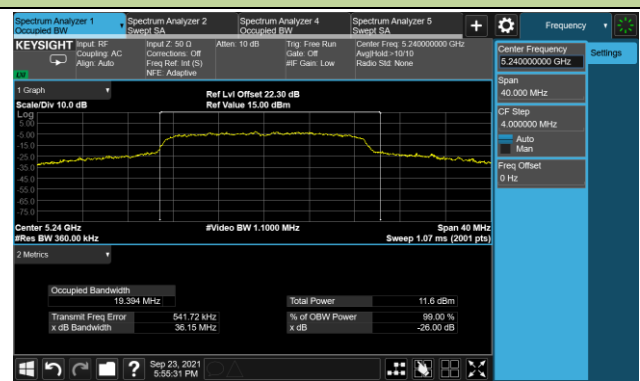

Channel 52 (5260MHz)

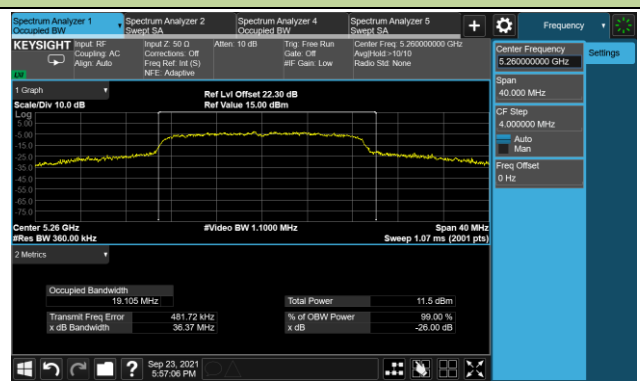

Channel 60 (5300MHz)

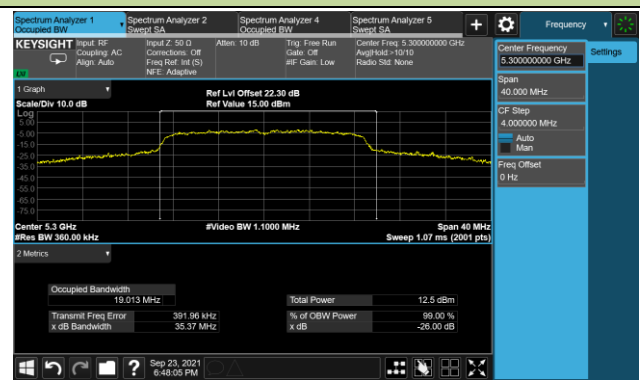

Channel 64 (5320MHz)

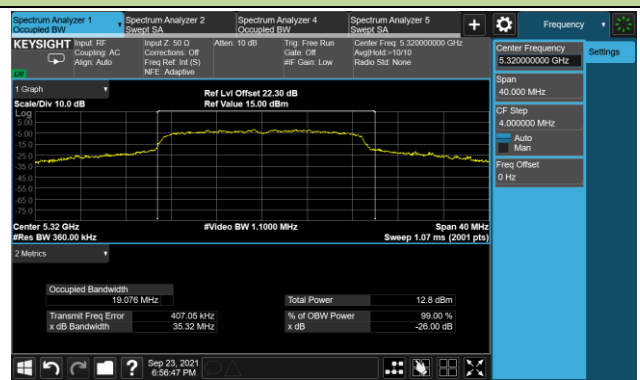

Channel 100 (5500MHz)



Channel 116 (5580MHz)

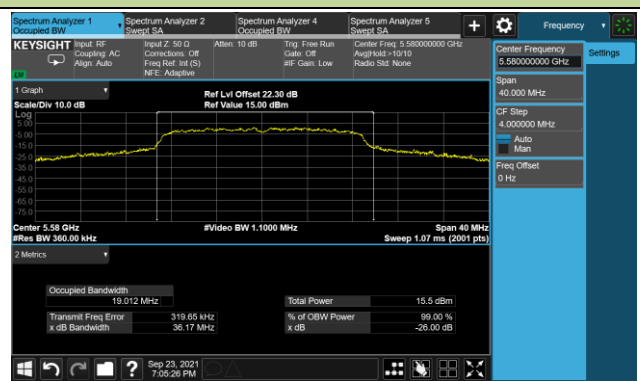

Channel 120 (5600MHz)

Channel 140 (5700MHz)

Channel 144 (5720MHz)

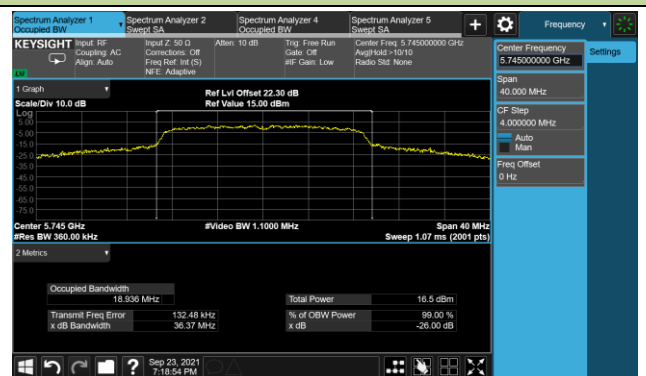
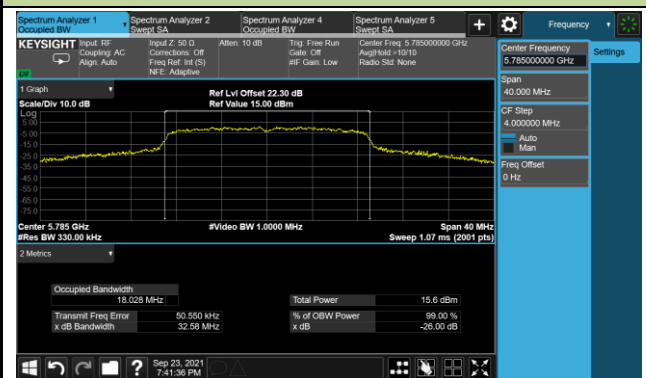
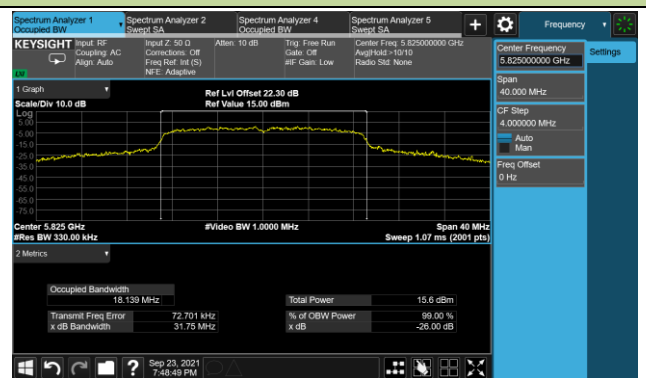
Channel 149 (5745MHz)

Channel 157 (5785MHz)

Channel 165 (5825MHz)

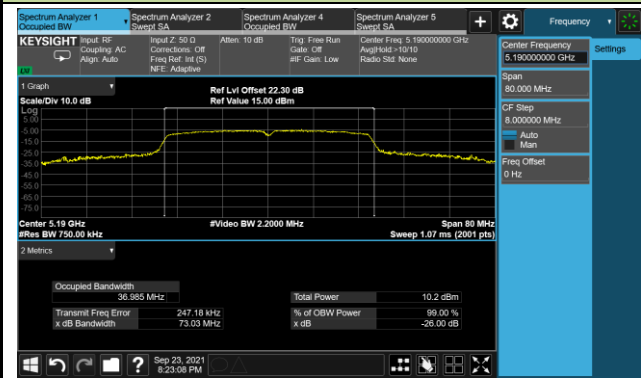
802.11ac-VHT40 26dB & 99% Bandwidth

Channel 38 (5190MHz)

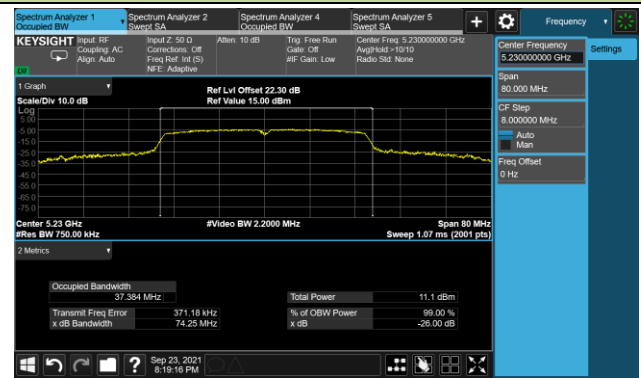

Channel 46 (5230MHz)



Channel 54 (5270MHz)

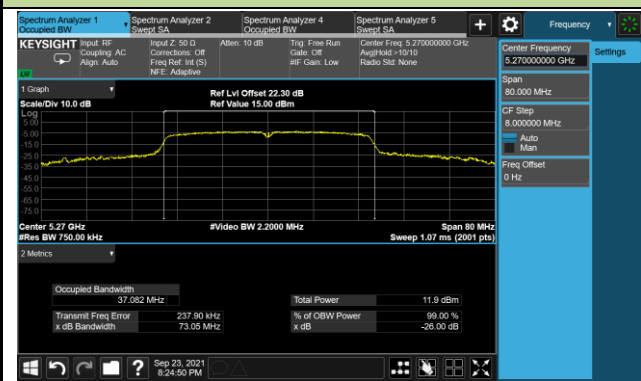

Channel 62 (5310MHz)

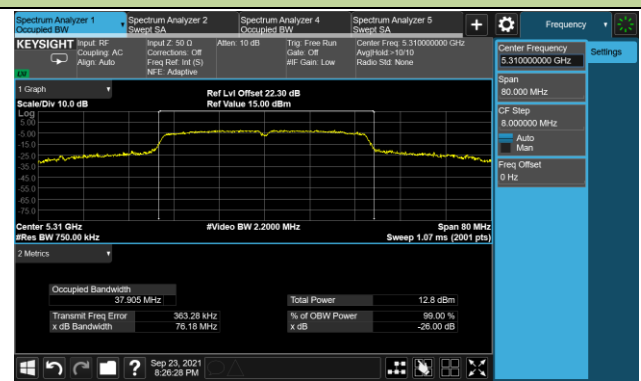

Channel 102 (5510MHz)



Channel 110 (5550MHz)

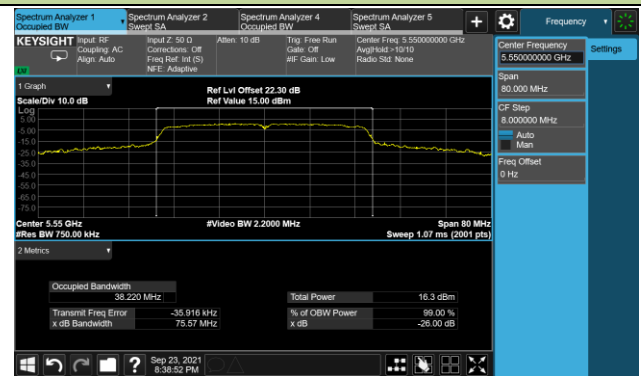

Channel 118 (5590MHz)



Channel 134 (5670MHz)

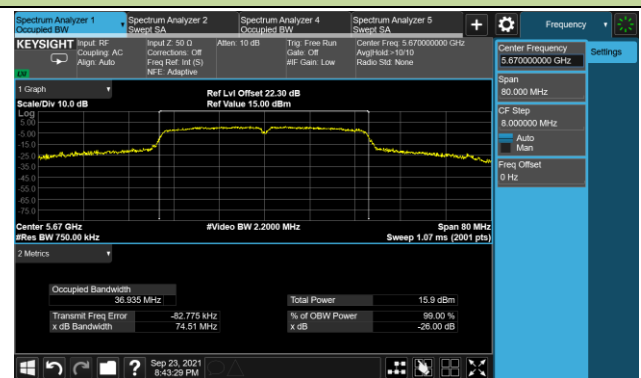

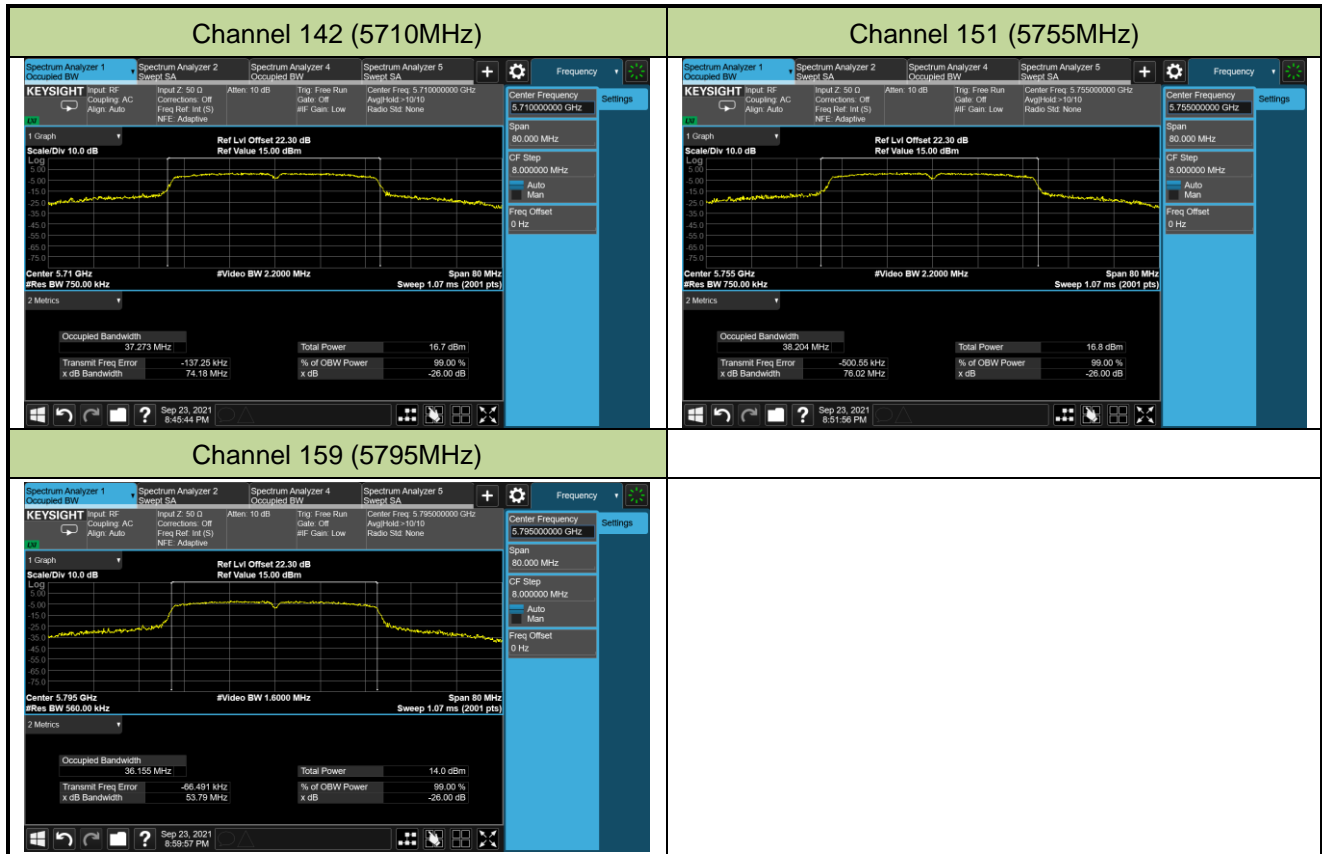

802.11ac-VHT80 26dB & 99% Bandwidth

Channel 42 (5210MHz)

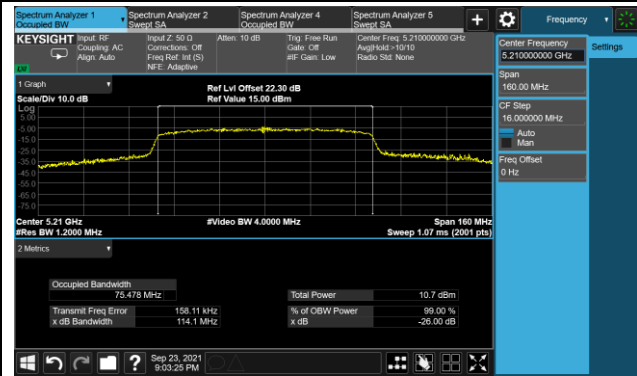

Channel 58 (5290MHz)

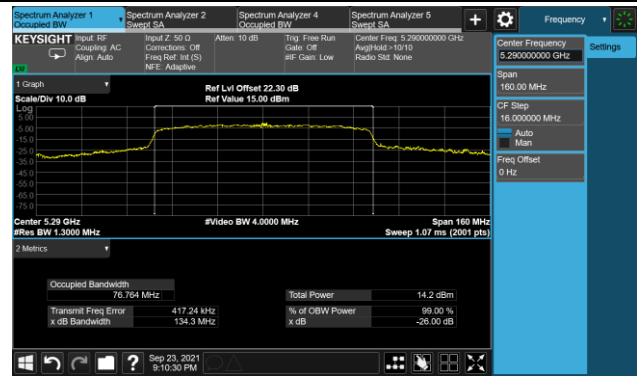

Channel 106 (5530MHz)

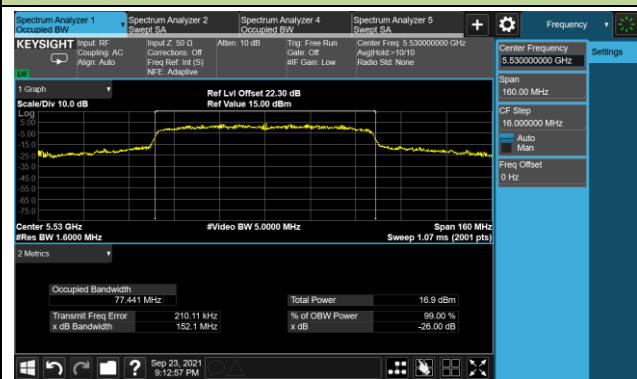

Channel 122 (5610MHz)

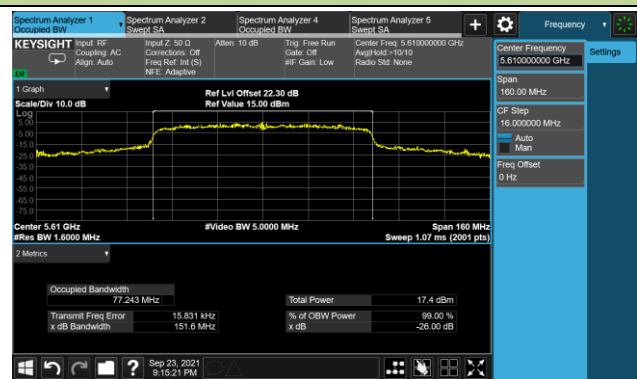

Channel 138 (5690MHz)

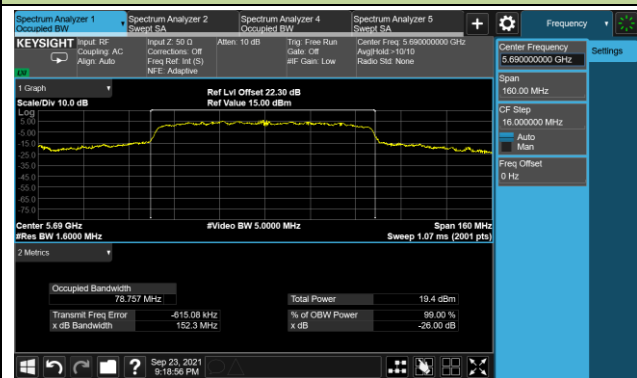

Channel 155 (5775MHz)

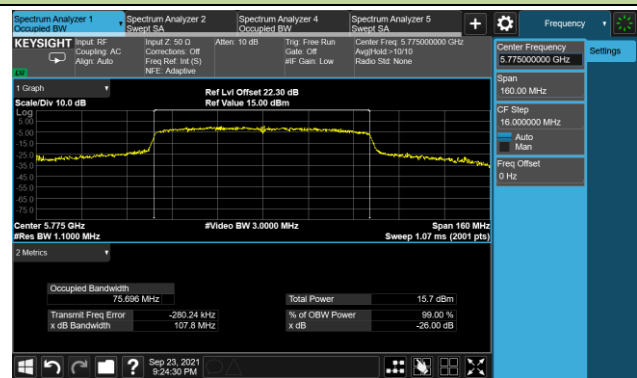

A.3 6dB Bandwidth Test Result

Test Site	WZ-SR5	Test Engineer	Liz Yuan
Test Date	2021/09/23		

Test Mode	Data Rate/ MCS	Channel No.	Frequency (MHz)	6dB Bandwidth (MHz)	Limit (MHz)	Result
802.11a	6Mbps	149	5745	15.10	≥ 0.5	Pass
802.11a	6Mbps	157	5785	15.16	≥ 0.5	Pass
802.11a	6Mbps	165	5825	15.15	≥ 0.5	Pass
802.11ac-VHT20	MCS0	149	5745	15.41	≥ 0.5	Pass
802.11ac-VHT20	MCS0	157	5785	14.23	≥ 0.5	Pass
802.11ac-VHT20	MCS0	165	5825	15.06	≥ 0.5	Pass
802.11ac-VHT40	MCS0	151	5755	33.88	≥ 0.5	Pass
802.11ac-VHT40	MCS0	159	5795	35.11	≥ 0.5	Pass
802.11ac-VHT80	MCS0	155	5775	73.76	≥ 0.5	Pass

802.11a 6dB Bandwidth

Channel 149 (5745MHz)

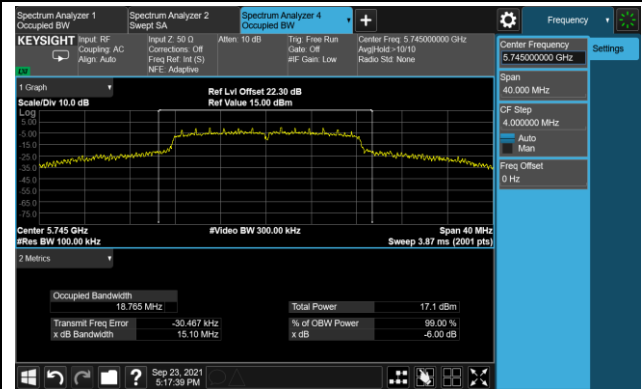

Channel 157 (5785MHz)

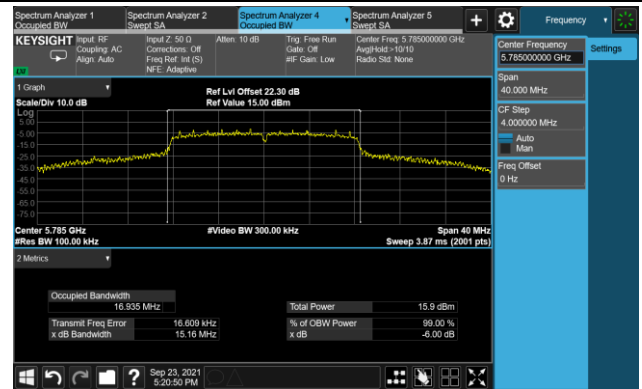

Channel 165 (5825MHz)

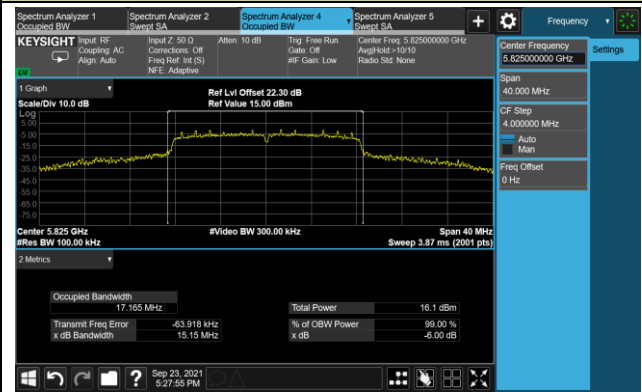

802.11ac-VHT20 6dB Bandwidth

Channel 149 (5745MHz)

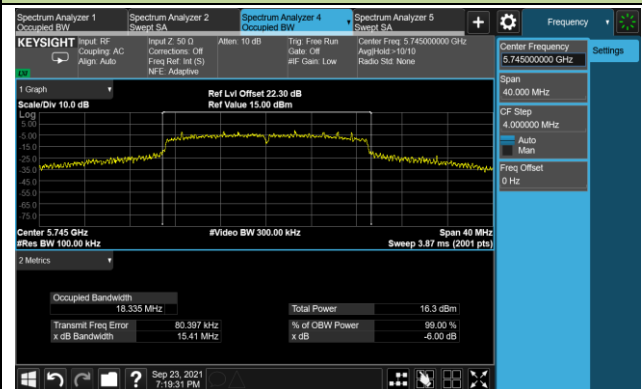

Channel 157 (5785MHz)

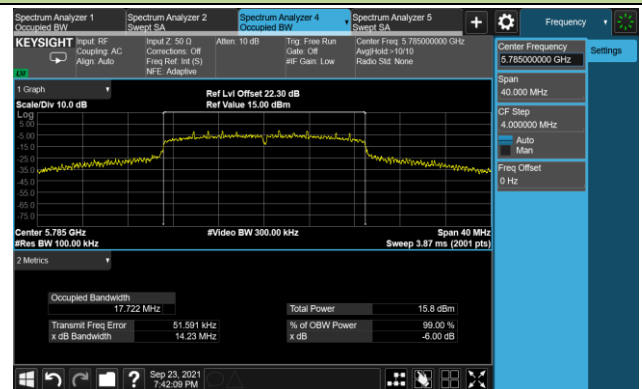

Channel 165 (5825MHz)

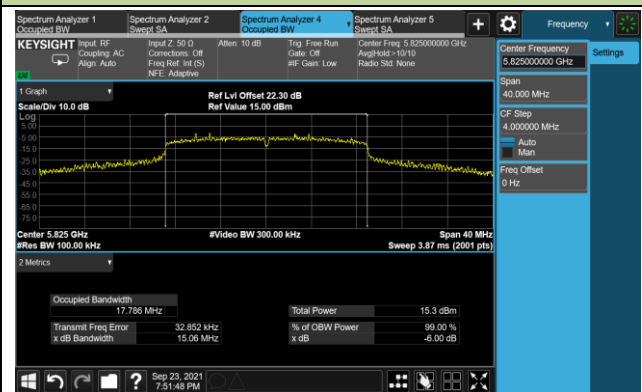

802.11ac-VHT40 6dB Bandwidth

Channel 151 (5755MHz)

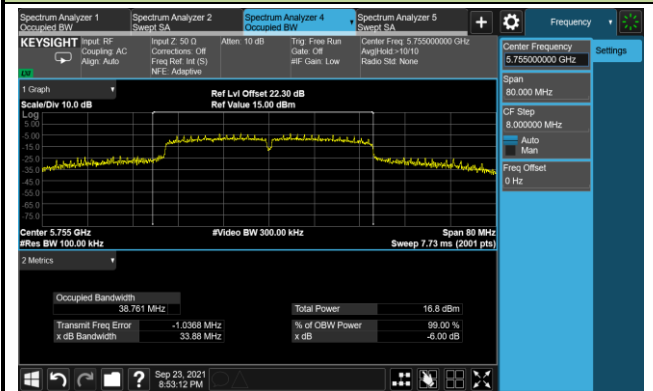

Channel 159 (5795MHz)

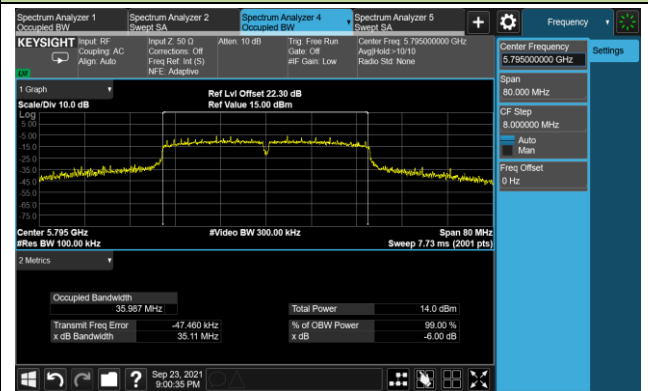

802.11ac-VHT80 6dB Bandwidth

Channel 155 (5775MHz)

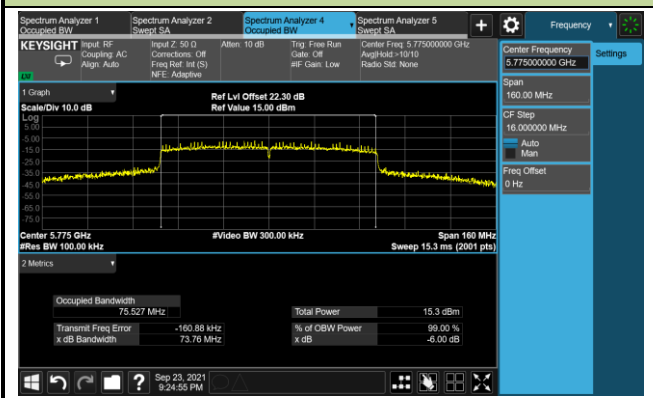

A.4 Output Power Test Result

Output power test was verified over all data rates of each mode shown as below table, and then choose the maximum output power (gray marker) for final test of each channel.

Test Mode	Bandwidth	Channel No.	Frequency (MHz)	Data Rate/ MCS	Average Power (dBm)
802.11a	20	36	5180	6Mbps	17.83
				24Mbps	17.67
				54Mbps	17.55
802.11ac	20	36	5180	MCS0	17.48
				MCS4	17.33
				MCS7	17.15
802.11ac	40	38	5190	MCS0	15.08
				MCS4	15.01
				MCS7	14.88
802.11ac	80	42	5210	MCS0	12.48
				MCS5	12.35
				MCS9	12.21

Test Site	WZ-SR5	Test Engineer	Liz Yuan
Test Date	2021/12/04		

Test Mode	Data Rate /MCS	Channel No.	Freq. (MHz)	Average Power (dBm)	Power Limit (dBm)
11a	6Mbps	36	5180	17.83	≤ 23.98
11a	6Mbps	44	5220	18.73	≤ 23.98
11a	6Mbps	48	5240	18.70	≤ 23.98
11a	6Mbps	52	5260	18.66	≤ 23.98
11a	6Mbps	60	5300	18.75	≤ 23.98
11a	6Mbps	64	5320	18.62	≤ 23.98
11a	6Mbps	100	5500	18.55	≤ 23.98
11a	6Mbps	116	5580	18.54	≤ 23.98
11a	6Mbps	120	5600	18.46	≤ 23.98
11a	6Mbps	140	5700	18.45	≤ 23.98
11a	6Mbps	144	5720	18.36	≤ 23.98
11a	6Mbps	149	5745	18.42	≤ 30.00
11a	6Mbps	157	5785	18.15	≤ 30.00
11a	6Mbps	165	5825	18.02	≤ 30.00
11ac-VHT20	MCS0	36	5180	17.79	≤ 23.98
11ac-VHT20	MCS0	44	5220	18.56	≤ 23.98
11ac-VHT20	MCS0	48	5240	18.47	≤ 23.98
11ac-VHT20	MCS0	52	5260	18.39	≤ 23.98
11ac-VHT20	MCS0	60	5300	18.46	≤ 23.98
11ac-VHT20	MCS0	64	5320	18.44	≤ 23.98
11ac-VHT20	MCS0	100	5500	18.41	≤ 23.98
11ac-VHT20	MCS0	116	5580	18.35	≤ 23.98
11ac-VHT20	MCS0	120	5600	18.28	≤ 23.98
11ac-VHT20	MCS0	140	5700	18.27	≤ 23.98
11ac-VHT20	MCS0	144	5720	18.21	≤ 23.98
11ac-VHT20	MCS0	149	5745	18.29	≤ 30.00
11ac-VHT20	MCS0	157	5785	17.88	≤ 30.00
11ac-VHT20	MCS0	165	5825	17.84	≤ 30.00

Test Mode	Data Rate/ MCS	Ch. No.	Freq. (MHz)	Average Power (dBm)	Power Limit (dBm)
11ac-VHT40	MCS0	38	5190	15.08	≤ 23.98
11ac-VHT40	MCS0	46	5230	18.76	≤ 23.98
11ac-VHT40	MCS0	54	5270	18.87	≤ 23.98
11ac-VHT40	MCS0	62	5310	16.64	≤ 23.98
11ac-VHT40	MCS0	102	5510	15.93	≤ 23.98
11ac-VHT40	MCS0	110	5550	18.77	≤ 23.98
11ac-VHT40	MCS0	118	5590	18.81	≤ 23.98
11ac-VHT40	MCS0	134	5670	18.96	≤ 23.98
11ac-VHT40	MCS0	142	5710	18.59	≤ 23.98
11ac-VHT40	MCS0	151	5755	18.64	≤ 30.00
11ac-VHT40	MCS0	159	5795	18.44	≤ 30.00
11ac-VHT80	MCS0	42	5210	12.48	≤ 23.98
11ac-VHT80	MCS0	58	5290	15.08	≤ 23.98
11ac-VHT80	MCS0	106	5530	15.25	≤ 23.98
11ac-VHT80	MCS0	122	5610	18.16	≤ 23.98
11ac-VHT80	MCS0	138	5690	17.94	≤ 23.98
11ac-VHT80	MCS0	155	5775	16.86	≤ 30.00

A.5 Power Spectral Density Test Result

Test Site	WZ-SR5	Test Engineer	Liz Yuan
Test Date	2021/12/01 ~ 2021/12/03		

Test Mode	Data Rate/ MCS	Ch. No.	Freq. (MHz)	PSD (dBm/MHz)	Duty Cycle (%)	Total PSD (dBm/MHz)	PSD Limit (dBm/ MHz)
For NII-1/-2a/-2c Bands							
11a	6Mbps	36	5180	6.95	95.07	7.17	≤ 11.00
11a	6Mbps	44	5220	7.54	95.07	7.76	≤ 11.00
11a	6Mbps	48	5240	7.64	95.07	7.86	≤ 11.00
11a	6Mbps	52	5260	7.62	95.07	7.84	≤ 11.00
11a	6Mbps	60	5300	7.39	95.07	7.61	≤ 11.00
11a	6Mbps	64	5320	7.41	95.07	7.63	≤ 11.00
11a	6Mbps	100	5500	7.57	95.07	7.79	≤ 11.00
11a	6Mbps	116	5580	7.49	95.07	7.71	≤ 11.00
11a	6Mbps	120	5600	7.57	95.07	7.79	≤ 11.00
11a	6Mbps	140	5700	7.30	95.07	7.52	≤ 11.00
11a	6Mbps	144	5720	7.42	95.07	7.64	≤ 11.00
11ac-VHT20	MCS0	36	5180	6.50	94.76	6.73	≤ 11.00
11ac-VHT20	MCS0	44	5220	7.09	94.76	7.32	≤ 11.00
11ac-VHT20	MCS0	48	5240	7.32	94.76	7.55	≤ 11.00
11ac-VHT20	MCS0	52	5260	6.55	94.76	6.78	≤ 11.00
11ac-VHT20	MCS0	60	5300	7.26	94.76	7.49	≤ 11.00
11ac-VHT20	MCS0	64	5320	6.84	94.76	7.07	≤ 11.00
11ac-VHT20	MCS0	100	5500	6.51	94.76	6.74	≤ 11.00
11ac-VHT20	MCS0	116	5580	7.09	94.76	7.33	≤ 11.00
11ac-VHT20	MCS0	120	5600	6.88	94.76	7.11	≤ 11.00
11ac-VHT20	MCS0	140	5700	6.96	94.76	7.20	≤ 11.00
11ac-VHT20	MCS0	144	5720	6.98	94.76	7.22	≤ 11.00
11ac-VHT40	MCS0	38	5190	0.07	87.41	0.65	≤ 11.00
11ac-VHT40	MCS0	46	5230	4.21	87.41	4.80	≤ 11.00
11ac-VHT40	MCS0	54	5270	4.34	87.41	4.92	≤ 11.00
11ac-VHT40	MCS0	62	5310	1.84	87.41	2.43	≤ 11.00
11ac-VHT40	MCS0	102	5510	1.09	87.41	1.67	≤ 11.00
11ac-VHT40	MCS0	110	5550	4.23	87.41	4.81	≤ 11.00
11ac-VHT40	MCS0	118	5590	4.37	87.41	4.95	≤ 11.00
11ac-VHT40	MCS0	134	5670	4.09	87.41	4.68	≤ 11.00

Test Mode	Data Rate/ MCS	Ch. No.	Freq. (MHz)	AVG PSD (dBm/MHz)	Duty Cycle (%)	Total PSD (dBm/MHz)	PSD Limit (dBm/ MHz)
For NII-1/-2a/-2c Bands:							
11ac-VHT40	MCS0	142	5710	4.39	87.41	4.97	≤ 11.00
11ac-VHT80	MCS0	42	5210	-5.54	81.23	-4.63	≤ 11.00
11ac-VHT80	MCS0	58	5290	-3.01	81.23	-2.11	≤ 11.00
11ac-VHT80	MCS0	106	5530	-3.19	81.23	-2.29	≤ 11.00
11ac-VHT80	MCS0	122	5610	0.30	81.23	1.20	≤ 11.00
11ac-VHT80	MCS0	138	5690	0.17	81.23	1.08	≤ 11.00

Note: When EUT duty cycle < 98%, the total PSD (dBm/MHz) = AVGPDS (dBm/MHz) +10*log (1/Duty cycle).

Test Mode	Data Rate/ MCS	Ch. No.	Freq. (MHz)	AVG PSD (dBm/510kHz)	Duty Cycle (%)	Total PSD (dBm/510kHz)	PSD Limit (dBm/500kHz)
For NII-3 Band							
11a	6Mbps	149	5745	4.55	95.07	4.77	≤ 30.00
11a	6Mbps	157	5785	4.34	95.07	4.56	≤ 30.00
11a	6Mbps	165	5825	3.86	95.07	4.07	≤ 30.00
11ac-VHT20	MCS0	149	5745	4.09	94.76	4.32	≤ 30.00
11ac-VHT20	MCS0	157	5785	3.76	94.76	3.99	≤ 30.00
11ac-VHT20	MCS0	165	5825	3.82	94.76	4.06	≤ 30.00
11ac-VHT40	MCS0	151	5755	1.36	87.41	1.95	≤ 30.00
11ac-VHT40	MCS0	159	5795	1.10	87.41	1.68	≤ 30.00
11ac-VHT80	MCS0	155	5775	-4.68	81.23	-3.78	≤ 30.00

Note: When EUT duty cycle < 98%, the total PSD (dBm/510kHz) = AVGPSSD (dBm/510kHz) +10*log (1/Duty cycle).

802.11a Power Spectral Density

Channel 36 (5180MHz)

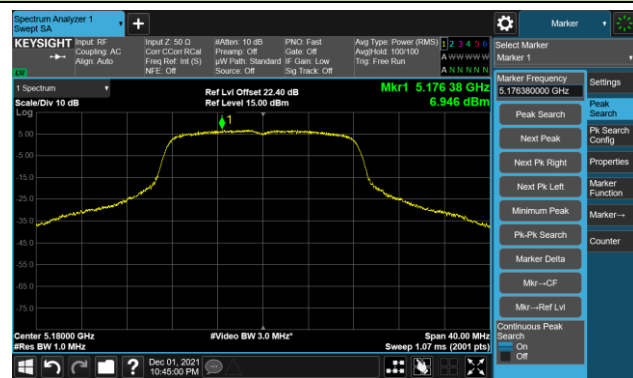

Channel 44 (5220MHz)

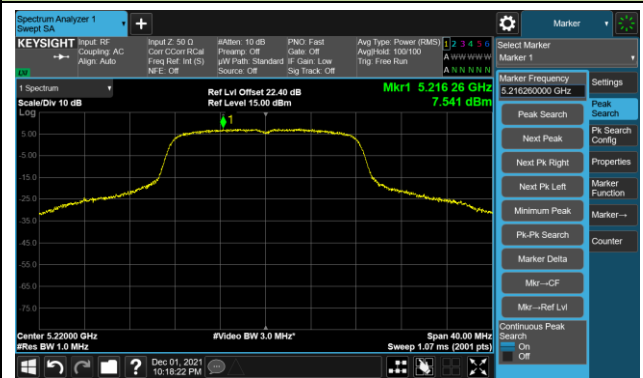

Channel 48 (5240MHz)

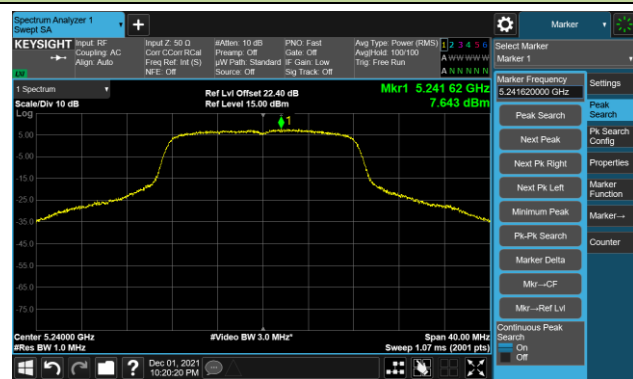

Channel 52 (5260MHz)

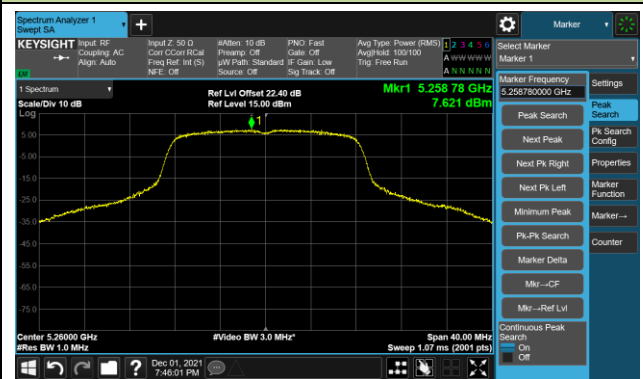

Channel 60 (5300MHz)

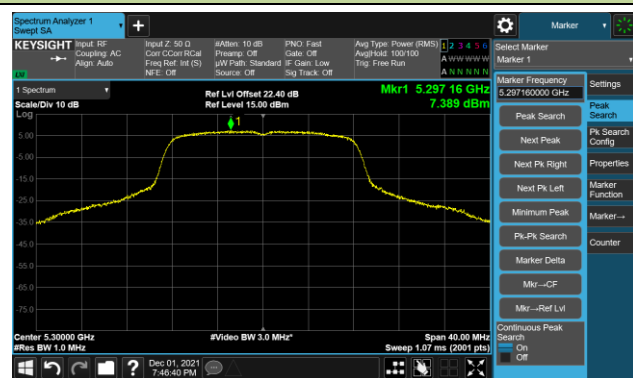

Channel 64 (5320MHz)

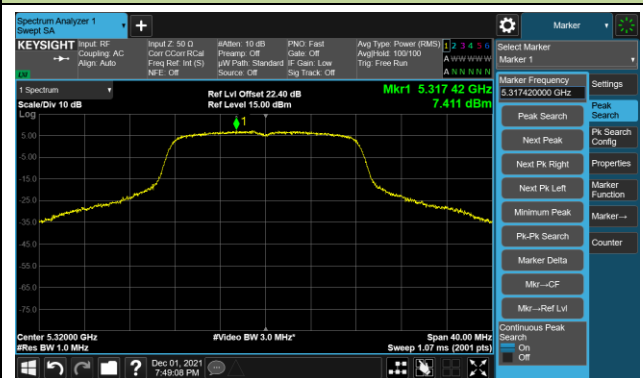

Channel 100 (5500MHz)

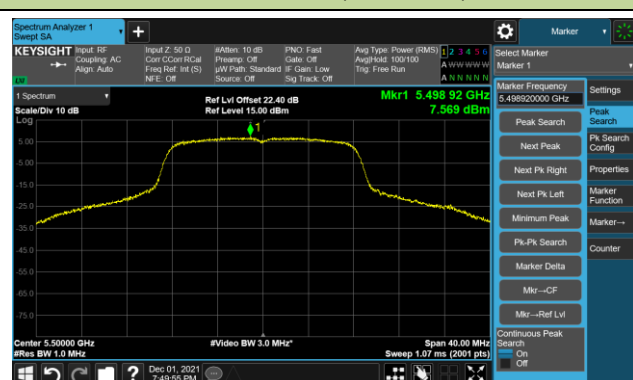

Channel 64 (5580MHz)



