



A D T

# FCC TEST REPORT (15.247)

**REPORT NO.:** RF121009E03B

**MODEL NO.:** WN6500RH

**FCC ID:** SUZ-WN6500RHN

**RECEIVED:** Oct. 09, 2012

**TESTED:** Oct. 20, 2012 ~ Jan. 05, 2013

**ISSUED:** Jan. 10, 2013

**APPLICANT:** Coretronic Corp.

**ADDRESS:** No. 11, Li Hsing Rd, Science-Based Industrial Park, Hsinchu, Taiwan.

**ISSUED BY:** Bureau Veritas Consumer Products Services (H.K.) Ltd., Taoyuan Branch

**LAB ADDRESS:** No. 47, 14th Ling, Chia Pau Vil., Lin Kou Dist., New Taipei City, Taiwan, R.O.C.

**TEST LOCATION:** No. 19, Hwa Ya 2nd Rd, Wen Hwa Tsuen, Kwei Shan Hsiang, Taoyuan Hsien 333, Taiwan, R.O.C.

This report should not be used by the client to claim product certification, approval, or endorsement by TAF or any government agencies.



This report is for your exclusive use. Any copying or replication of this report to or for any other person or entity, or use of our name or trademark, is permitted only with our prior written permission. This report sets forth our findings solely with respect to the test samples identified herein. The results set forth in this report are not indicative or representative of the quality or characteristics of the lot from which a test sample was taken or any similar or identical product unless specifically and expressly noted. Our report includes all of the tests requested by you and the results thereof based upon the information that you provided to us. You have 60 days from date of issuance of this report to notify us of any material error or omission caused by our negligence, provided, however, that such notice shall be in writing and shall specifically address the issue you wish to raise. A failure to raise such issue within the prescribed time shall constitute your unqualified acceptance of the completeness of this report, the tests conducted and the correctness of the report contents. Unless specific mention, the uncertainty of measurement has been explicitly taken into account to declare the compliance or non-compliance to the specification.



# TABLE OF CONTENTS

- RELEASE CONTROL RECORD ..... 5
- 1. CERTIFICATION ..... 6
- 2. SUMMARY OF TEST RESULTS ..... 7
- 2.1 MEASUREMENT UNCERTAINTY ..... 7
- 3. GENERAL INFORMATION ..... 8
- 3.1 GENERAL DESCRIPTION OF EUT ..... 8
- 3.2 DESCRIPTION OF TEST MODES ..... 10
- 3.2.1 TEST MODE APPLICABILITY AND TESTED CHANNEL DETAIL ..... 11
- 3.3 DESCRIPTION OF SUPPORT UNITS ..... 17
- 3.3.1 CONFIGURATION OF SYSTEM UNDER TEST ..... 17
- 3.4 GENERAL DESCRIPTION OF APPLIED STANDARDS ..... 18
- 4. TEST TYPES AND RESULTS (FOR 2.4GHz BAND) ..... 19
- 4.1 RADIATED EMISSION AND BANDEDGE MEASUREMENT ..... 19
- 4.1.1 LIMITS OF RADIATED EMISSION AND BANDEDGE MEASUREMENT ..... 19
- 4.1.2 TEST INSTRUMENTS ..... 20
- 4.1.3 TEST PROCEDURES ..... 21
- 4.1.4 DEVIATION FROM TEST STANDARD ..... 21
- 4.1.5 TEST SETUP ..... 22
- 4.1.6 EUT OPERATING CONDITIONS ..... 22
- 4.1.7 TEST RESULTS ..... 23
- 4.2 CONDUCTED EMISSION MEASUREMENT ..... 61
- 4.2.1 LIMITS OF CONDUCTED EMISSION MEASUREMENT ..... 61
- 4.2.2 TEST INSTRUMENTS ..... 61
- 4.2.3 TEST PROCEDURES ..... 62
- 4.2.4 DEVIATION FROM TEST STANDARD ..... 62
- 4.2.5 TEST SETUP ..... 63
- 4.2.6 EUT OPERATING CONDITIONS ..... 63
- 4.2.7 TEST RESULTS ..... 64
- 4.3 6dB BANDWIDTH MEASUREMENT ..... 68
- 4.3.1 LIMITS OF 6dB BANDWIDTH MEASUREMENT ..... 68
- 4.3.2 TEST SETUP ..... 68
- 4.3.3 TEST INSTRUMENTS ..... 68
- 4.3.4 TEST PROCEDURE ..... 68
- 4.3.5 DEVIATION FROM TEST STANDARD ..... 69
- 4.3.6 EUT OPERATING CONDITIONS ..... 69
- 4.3.7 TEST RESULTS ..... 70
- 4.4 CONDUCTED OUTPUT POWER ..... 73
- 4.4.1 LIMITS OF CONDUCTED OUTPUT POWER MEASUREMENT ..... 73
- 4.4.2 TEST SETUP ..... 73
- 4.4.3 TEST INSTRUMENTS ..... 73
- 4.4.4 TEST PROCEDURES ..... 74
- 4.4.5 DEVIATION FROM TEST STANDARD ..... 74
- 4.4.6 EUT OPERATING CONDITIONS ..... 74
- 4.4.7 TEST RESULTS ..... 75
- 4.5 POWER SPECTRAL DENSITY MEASUREMENT ..... 77
- 4.5.1 LIMITS OF POWER SPECTRAL DENSITY MEASUREMENT ..... 77



A D T

4.5.2	TEST SETUP .....	77
4.5.3	TEST INSTRUMENTS .....	77
4.5.4	TEST PROCEDURE .....	77
4.5.5	DEVIATION FROM TEST STANDARD .....	77
4.5.6	EUT OPERATING CONDITION.....	77
4.5.7	TEST RESULTS .....	78
4.6	CONDUCTED OUT OF BAND EMISSION MEASUREMENT .....	80
4.6.1	LIMITS OF CONDUCTED OUT OF BAND EMISSION MEASUREMENT .....	80
4.6.2	TEST SETUP .....	80
4.6.3	TEST INSTRUMENTS .....	80
4.6.4	TEST PROCEDURE .....	80
4.6.5	DEVIATION FROM TEST STANDARD .....	81
4.6.6	EUT OPERATING CONDITION.....	81
4.6.7	TEST RESULTS .....	81
4.6.8	TEST RESULTS .....	82
5.	TEST TYPES AND RESULTS (FOR 5.0GHz BAND).....	90
5.1	RADIATED EMISSION MEASUREMENT .....	90
5.1.1	LIMITS OF RADIATED EMISSION MEASUREMENT .....	90
5.1.2	TEST INSTRUMENTS .....	91
5.1.3	TEST PROCEDURES .....	92
5.1.4	DEVIATION FROM TEST STANDARD .....	92
5.1.5	TEST SETUP .....	92
5.1.6	EUT OPERATING CONDITIONS .....	92
5.1.7	TEST RESULTS .....	93
5.2	CONDUCTED EMISSION MEASUREMENT .....	121
5.2.1	LIMITS OF CONDUCTED EMISSION MEASUREMENT .....	121
5.2.2	TEST INSTRUMENTS .....	121
5.2.3	TEST PROCEDURES .....	121
5.2.4	DEVIATION FROM TEST STANDARD .....	121
5.2.5	TEST SETUP .....	121
5.2.6	EUT OPERATING CONDITIONS .....	121
5.2.7	TEST RESULTS .....	122
5.3	6dB BANDWIDTH MEASUREMENT.....	126
5.3.1	LIMITS OF 6dB BANDWIDTH MEASUREMENT .....	126
5.3.2	TEST SETUP .....	126
5.3.3	TEST INSTRUMENTS .....	126
5.3.4	TEST PROCEDURE .....	126
5.3.5	DEVIATION FROM TEST STANDARD .....	126
5.3.6	EUT OPERATING CONDITIONS .....	126
5.3.7	TEST RESULTS .....	127
5.4	CONDUCTED OUTPUT POWER .....	129
5.4.1	LIMITS OF CONDUCTED OUTPUT POWER MEASUREMENT.....	129
5.4.2	TEST SETUP .....	129
5.4.3	INSTRUMENTS .....	129
5.4.4	TEST PROCEDURES .....	129
5.4.5	DEVIATION FROM TEST STANDARD .....	129
5.4.6	EUT OPERATING CONDITIONS .....	129
5.4.7	TEST RESULTS .....	130
5.5	POWER SPECTRAL DENSITY MEASUREMENT.....	131



A D T

5.5.1	LIMITS OF POWER SPECTRAL DENSITY MEASUREMENT .....	131
5.5.2	TEST SETUP .....	131
5.5.3	TEST INSTRUMENTS .....	131
5.5.4	TEST PROCEDURE .....	131
5.5.5	DEVIATION FROM TEST STANDARD .....	131
5.5.6	EUT OPERATING CONDITION .....	131
5.5.7	TEST RESULTS .....	132
5.6	CONDUCTED OUT OF BAND EMISSION MEASUREMENT .....	134
5.6.1	LIMITS OF CONDUCTED OUT OF BAND EMISSION MEASUREMENT .....	134
5.6.2	TEST SETUP .....	134
5.6.3	TEST INSTRUMENTS .....	134
5.6.4	TEST PROCEDURE .....	134
5.6.5	DEVIATION FROM TEST STANDARD .....	134
5.6.6	EUT OPERATING CONDITION .....	134
5.6.7	TEST RESULTS .....	134
6.	PHOTOGRAPHS OF THE TEST CONFIGURATION .....	142
7.	INFORMATION ON THE TESTING LABORATORIES .....	143
8.	APPENDIX A - MODIFICATIONS RECORDERS FOR ENGINEERING CHANGES TO THE EUT BY THE LAB .....	144



A D T

## RELEASE CONTROL RECORD

ISSUE NO.	REASON FOR CHANGE	DATE ISSUED
RF121009E03B	Original release	Jan. 10, 2013



A D T

## 1. CERTIFICATION

**PRODUCT:** 802.11n, Dual Band, 2T2R Wireless LAN PCI Express Half Mini Module

**MODEL NO.:** WN6500RH

**BRAND:** Coretronic

**APPLICANT:** Coretronic Corp.

**TESTED:** Oct. 20, 2012 ~ Jan. 05, 2013

**TEST SAMPLE:** ENGINEERING SAMPLE

**STANDARDS:** **FCC Part 15, Subpart C (Section 15.247)**

ANSI C63.10-2009

The above equipment (model: WN6500RH) has been tested by **Bureau Veritas Consumer Products Services (H.K.) Ltd., Taoyuan Branch**, and found compliance with the requirement of the above standards. The test record, data evaluation & Equipment Under Test (EUT) configurations represented herein are true and accurate accounts of the measurements of the sample's EMC characteristics under the conditions specified in this report.

**PREPARED BY :** Ivy Lin , **DATE :** Jan. 10, 2013  
Ivy Lin / Specialist

**APPROVED BY :** Ken Liu , **DATE :** Jan. 10, 2013  
Ken Liu / Manager



## 2. SUMMARY OF TEST RESULTS

The EUT has been tested according to the following specifications:

APPLIED STANDARD: FCC PART 15, SUBPART C (SECTION 15.247)			
STANDARD SECTION	TEST TYPE	RESULT	REMARK
15.207	AC Power Conducted Emission	PASS	Meet the requirement of limit. Minimum passing margin is -7.47dB at 0.32614MHz.
15.247(d) 15.209	Radiated Emissions	PASS	Meet the requirement of limit. Minimum passing margin is -1.0dB at 2390.00MHz.
15.247(d)	Band Edge Measurement	PASS	Meet the requirement of limit.
15.247(a)(2)	6dB bandwidth	PASS	Meet the requirement of limit.
15.247(b)	Conducted power	PASS	Meet the requirement of limit.
15.247(e)	Power Spectral Density	PASS	Meet the requirement of limit.
15.203	Antenna Requirement	PASS	Antenna connector is I-PEX not a standard connector.

### 2.1 MEASUREMENT UNCERTAINTY

Where relevant, the following measurement uncertainty levels have been estimated for tests performed on the EUT as specified in CISPR 16-4-2:

MEASUREMENT	FREQUENCY	UNCERTAINTY
Conducted emissions	9kHz~30MHz	2.44 dB
Radiated emissions	30MHz ~ 200MHz	2.93 dB
	200MHz ~1000MHz	2.95 dB
	1GHz ~ 18GHz	2.26 dB
	18GHz ~ 40GHz	1.94 dB

This uncertainty represents an expanded uncertainty expressed at approximately the 95% confidence level using a coverage factor of  $k = 2$ .



### 3. GENERAL INFORMATION

#### 3.1 GENERAL DESCRIPTION OF EUT

<b>EUT</b>	802.11n, Dual Band, 2T2R Wireless LAN PCI Express Half Mini Module
<b>MODEL NO.</b>	WN6500RH
<b>POWER SUPPLY</b>	3.3Vdc (Host equipment)
<b>MODULATION TYPE</b>	CCK, DQPSK, DBPSK for DSSS 64QAM, 16QAM, QPSK, BPSK for OFDM
<b>MODULATION TECHNOLOGY</b>	DSSS, OFDM
<b>TRANSFER RATE</b>	802.11b: 11.0/ 5.5/ 2.0/ 1.0Mbps 802.11g: 54.0/ 48.0/ 36.0/ 24.0/ 18.0/ 12.0/ 9.0/ 6.0Mbps 802.11a: 54.0/ 48.0/ 36.0/ 24.0/ 18.0/ 12.0/ 9.0/ 6.0Mbps 802.11n: up to 300.0Mbps
<b>OPERATING FREQUENCY</b>	<b>2.4GHz:</b> 2412 ~ 2462MHz <b>5.0GHz:</b> 5745 ~ 5825MHz
<b>NUMBER OF CHANNEL</b>	<b>2.4GHz:</b> 11 for 802.11b, 802.11g, 802.11n (20MHz) 7 for 802.11n (40MHz) <b>5.0GHz:</b> 5 for 802.11a, 802.11n (20MHz) 2 for 802.11n (40MHz)
<b>OUTPUT POWER</b>	293.765mW for 2412 ~ 2462MHz 171.213mW for 5745 ~ 5825MHz
<b>ANTENNA TYPE</b>	Refer to Note 2
<b>ANTENNA CONNECTOR</b>	I-PEX
<b>DATA CABLE</b>	N/A
<b>I/O PORTS</b>	Refer to user's manual
<b>ACCESSORY DEVICES</b>	N/A



**NOTE:**

1. The EUT incorporates a MIMO function. Physically, the EUT provides two completed transmitters and two receivers.

MODULATION MODE	TX FUNCTION
802.11b	1TX
802.11g	1TX
802.11a	1TX
802.11n (20MHz) (MCS 0)	1TX
802.11n (20MHz) (MCS 8)	2TX
802.11n (40MHz) (MCS 0)	1TX
802.11n (40MHz) (MCS 8)	2TX

2. The following antennas are provided to the EUT.

Antenna type	Antenna gain (dBi)					
	2.4GHz	5150GHz	5.18 ~ 5.24GHz	5.26 ~ 5.32GHz	5.50 ~ 5.70GHz	5745 ~5825MHz
PIFA	1.9	2.21	2.59	3.94	3.73	4.21
Monopole	4.83	5.91	6.08	6.15	5.71	5.67

\* The monopole antenna with high antenna gain is for final test.

3. The above EUT information is declared by manufacturer and for more detailed features description, please refer to the manufacturer's specifications or user's manual.

### 3.2 DESCRIPTION OF TEST MODES

#### FOR 2.4GHz:

11 channels are provided for 802.11b, 802.11g and 802.11n (20MHz):

CHANNEL	FREQUENCY	CHANNEL	FREQUENCY
1	2412MHz	7	2442MHz
2	2417MHz	8	2447MHz
3	2422MHz	9	2452MHz
4	2427MHz	10	2457MHz
5	2432MHz	11	2462MHz
6	2437MHz		

7 channels are provided for 802.11n (40MHz):

CHANNEL	FREQUENCY	CHANNEL	FREQUENCY
3	2422MHz	7	2442MHz
4	2427MHz	8	2447MHz
5	2432MHz	9	2452MHz
6	2437MHz		

#### FOR 5.0GHz (5745 ~ 5825MHz):

5 channels are provided for 802.11a, 802.11n (20MHz):

CHANNEL	FREQUENCY	CHANNEL	FREQUENCY
149	5745MHz	161	5805MHz
153	5765MHz	165	5825MHz
157	5785MHz		

2 channels are provided for 802.11n (40MHz):

CHANNEL	FREQUENCY	CHANNEL	FREQUENCY
151	5755MHz	159	5795MHz



### 3.2.1 TEST MODE APPLICABILITY AND TESTED CHANNEL DETAIL

**FOR 2.4GHz:**

EUT CONFIGURE MODE	APPLICABLE TO				DESCRIPTION
	RE≥1G	RE<1G	PLC	APCM	
A 1	√	-	-	-	PIFA antenna: 1 TX
A 2	√	√	√	-	PIFA antenna: 2 TX
B 1	√	-	-	√	Monopole antenna: 1 TX
B 2	√	√	√	√	Monopole antenna: 2 TX

Where **RE≥1G**: Radiated Emission above 1GHz      **RE<1G**: Radiated Emission below 1GHz  
**PLC**: Power Line Conducted Emission      **APCM**: Antenna Port Conducted Measurement

**NOTE:**

1. For PIFA antenna, the antenna had been pre-tested on the positioned of each 3 axis. The worst case was found when positioned on **X-plane**.
2. For Monopole antenna, the antenna had been pre-tested on the positioned of each 3 axis. The worst case was found when positioned on **Z-plane**.
3. "-" means no effect.

**RADIATED EMISSION TEST (ABOVE 1GHz):**

- Pre-Scan has been conducted to determine the worst-case mode from all possible combinations between available modulations, data rates and antenna ports (if EUT with antenna diversity architecture).
- Following channel(s) was (were) selected for the final test as listed below.

EUT CONFIGURE MODE	MODE	AVAILABLE CHANNEL	TESTED CHANNEL	MODULATION TECHNOLOGY	MODULATION TYPE	DATA RATE (Mbps)	TX Function
A 1, B 1	802.11b	1 to 11	1, 6, 11	DSSS	DBPSK	1.0	1TX
A 1, B 1	802.11g	1 to 11	1, 6, 11	OFDM	BPSK	6.0	1TX
A 1, B 1	802.11n (20MHz)	1 to 11	1, 6, 11	OFDM	BPSK	6.5	1TX
A 2, B 2	802.11n (20MHz)	1 to 11	1, 6, 11	OFDM	BPSK	13.0	2TX
A 1, B1	802.11n (40MHz)	3 to 9	3, 6, 9	OFDM	BPSK	13.5	1TX
A 2, B 2	802.11n (40MHz)	3 to 9	3, 6, 9	OFDM	BPSK	27.0	2TX

**RADIATED EMISSION TEST (BELOW 1GHz):**

- Pre-Scan has been conducted to determine the worst-case mode from all possible combinations between available modulations, data rates and antenna ports (if EUT with antenna diversity architecture).
- Following channel(s) was (were) selected for the final test as listed below.

EUT CONFIGURE MODE	MODE	AVAILABLE CHANNEL	TESTED CHANNEL	MODULATION TECHNOLOGY	MODULATION TYPE	DATA RATE (Mbps)	TX Function
A 2, B 2	802.11n (20MHz)	1 to 11	1	OFDM	BPSK	13.0	2TX



A D T

**POWER LINE CONDUCTED EMISSION TEST:**

- Pre-Scan has been conducted to determine the worst-case mode from all possible combinations between available modulations, data rates and antenna ports (if EUT with antenna diversity architecture).
- Following channel(s) was (were) selected for the final test as listed below.

EUT CONFIGURE MODE	MODE	AVAILABLE CHANNEL	TESTED CHANNEL	MODULATION TECHNOLOGY	MODULATION TYPE	DATA RATE (Mbps)	TX Function
A 2, B 2	802.11n (20MHz)	1 to 11	1	OFDM	BPSK	13.0	2TX

**BANDEDGE MEASUREMENT:**

- Pre-Scan has been conducted to determine the worst-case mode from all possible combinations between available modulations, data rates and antenna ports (if EUT with antenna diversity architecture).
- Following channel(s) was (were) selected for the final test as listed below.

EUT CONFIGURE MODE	MODE	AVAILABLE CHANNEL	TESTED CHANNEL	MODULATION TECHNOLOGY	MODULATION TYPE	DATA RATE (Mbps)	TX Function
B 1	802.11b	1 to 11	1, 11	DSSS	DBPSK	1.0	1TX
B 1	802.11g	1 to 11	1, 11	OFDM	BPSK	6.0	1TX
B 1	802.11n (20MHz)	1 to 11	1, 11	OFDM	BPSK	6.5	1TX
B 2	802.11n (20MHz)	1 to 11	1, 11	OFDM	BPSK	13.0	2TX
B 1	802.11n (40MHz)	3 to 9	3, 9	OFDM	BPSK	13.5	1TX
B 2	802.11n (40MHz)	3 to 9	3, 9	OFDM	BPSK	27.0	2TX

**ANTENNA PORT CONDUCTED MEASUREMENT:**

- This item includes all test value of each mode, but only includes spectrum plot of worst value of each mode.
- Pre-Scan has been conducted to determine the worst-case mode from all possible combinations between available modulations, data rates and antenna ports (if EUT with antenna diversity architecture).
- Following channel(s) was (were) selected for the final test as listed below.

EUT CONFIGURE MODE	MODE	AVAILABLE CHANNEL	TESTED CHANNEL	MODULATION TECHNOLOGY	MODULATION TYPE	DATA RATE (Mbps)	TX Function
B 1	802.11b	1 to 11	1, 6, 11	DSSS	DBPSK	1.0	1TX
B 1	802.11g	1 to 11	1, 6, 11	OFDM	BPSK	6.0	1TX
B 1	802.11n (20MHz)	1 to 11	1, 6, 11	OFDM	BPSK	6.5	1TX
B 2	802.11n (20MHz)	1 to 11	1, 6, 11	OFDM	BPSK	13.0	2TX
B 1	802.11n (40MHz)	3 to 9	3, 6, 9	OFDM	BPSK	13.5	1TX
B 2	802.11n (40MHz)	3 to 9	3, 6, 9	OFDM	BPSK	27.0	2TX



A D T

**TEST CONDITION:**

APPLICABLE TO	TEST MODE	ENVIRONMENTAL CONDITIONS	INPUT POWER (SYSTEM)	TESTED BY
RE $\geq$ 1G	A 1, A 2	22deg. C, 74%RH, 25deg. C, 67%RH	120Vac, 60Hz	Antony Lee, Chris Lin
	B 1, B 2	25deg. C, 68%RH	120Vac, 60Hz	Antony Lee
RE $<$ 1G	A 2	25deg. C, 67%RH	120Vac, 60Hz	Cedric Wu
	B 2	24deg. C, 64%RH	120Vac, 60Hz	Match Tsui
PLC	A 2	25deg. C, 65%RH	120Vac, 60Hz	Chris Lin
	B 2	24deg. C, 64%RH	120Vac, 60Hz	Match Tsui
APCM	B 1, B 2	25deg. C, 60%RH	120Vac, 60Hz	Frank Liu



**FOR 5.0GHz (5745 ~ 5825MHz):**

EUT CONFIGURE MODE	APPLICABLE TO				DESCRIPTION
	RE≥1G	RE<1G	PLC	APCM	
A 1	√	-	-	-	PIFA antenna: 1 TX
A 2	√	√	√	-	PIFA antenna: 2 TX
B 1	√	-	-	√	Monopole antenna: 1 TX
B 2	√	√	√	√	Monopole antenna: 2 TX

Where **RE≥1G**: Radiated Emission above 1GHz      **RE<1G**: Radiated Emission below 1GHz  
**PLC**: Power Line Conducted Emission      **APCM**: Antenna Port Conducted Measurement

**NOTE:**

1. For PIFA antenna, the antenna had been pre-tested on the positioned of each 3 axis. The worst case was found when positioned on **Y-plane**.
2. For Monopole antenna, the antenna had been pre-tested on the positioned of each 3 axis. The worst case was found when positioned on **Z-plane**.
3. "-" means no effect.

**RADIATED EMISSION TEST (ABOVE 1GHz):**

- Pre-Scan has been conducted to determine the worst-case mode from all possible combinations between available modulations, data rates and antenna ports (if EUT with antenna diversity architecture).
- Following channel(s) was (were) selected for the final test as listed below.

EUT CONFIGURE MODE	MODE	AVAILABLE CHANNEL	TESTED CHANNEL	MODULATION TECHNOLOGY	MODULATION TYPE	DATA RATE (Mbps)	TX Function
A 1, B 1	802.11a	149 to 165	149, 157, 165	OFDM	BPSK	6.0	1TX
A 1, B 1	802.11n (20MHz)	149 to 165	149, 157, 165	OFDM	BPSK	6.5	1TX
A 2, B 2	802.11n (20MHz)	149 to 165	149, 157, 165	OFDM	BPSK	13.0	2TX
A 1, B 1	802.11n (40MHz)	151 to 159	151, 159	OFDM	BPSK	13.5	1TX
A 2, B 2	802.11n (40MHz)	151 to 159	151, 159	OFDM	BPSK	27.0	2TX

**RADIATED EMISSION TEST (BELOW 1GHz):**

- Pre-Scan has been conducted to determine the worst-case mode from all possible combinations between available modulations, data rates and antenna ports (if EUT with antenna diversity architecture).
- Following channel(s) was (were) selected for the final test as listed below.

EUT CONFIGURE MODE	MODE	AVAILABLE CHANNEL	TESTED CHANNEL	MODULATION TECHNOLOGY	MODULATION TYPE	DATA RATE (Mbps)	TX Function
A 2, B 2	802.11n (20MHz)	149 to 165	157	OFDM	BPSK	13.0	2TX



A D T

### **POWER LINE CONDUCTED EMISSION TEST:**

- Pre-Scan has been conducted to determine the worst-case mode from all possible combinations between available modulations, data rates and antenna ports (if EUT with antenna diversity architecture).
- Following channel(s) was (were) selected for the final test as listed below.

EUT CONFIGURE MODE	MODE	AVAILABLE CHANNEL	TESTED CHANNEL	MODULATION TECHNOLOGY	MODULATION TYPE	DATA RATE (Mbps)	TX Function
A 2, B 2	802.11n (20MHz)	149 to 165	157	OFDM	BPSK	13.0	2TX

### **BANDEDGE MEASUREMENT:**

- Pre-Scan has been conducted to determine the worst-case mode from all possible combinations between available modulations, data rates and antenna ports (if EUT with antenna diversity architecture).
- Following channel(s) was (were) selected for the final test as listed below.

EUT CONFIGURE MODE	MODE	AVAILABLE CHANNEL	TESTED CHANNEL	MODULATION TECHNOLOGY	MODULATION TYPE	DATA RATE (Mbps)	TX Function
B 1	802.11a	149 to 165	149, 165	OFDM	BPSK	6.0	1TX
B 1	802.11n (20MHz)	149 to 165	149, 165	OFDM	BPSK	6.5	1TX
B 2	802.11n (20MHz)	149 to 165	149, 165	OFDM	BPSK	13.0	2TX
B 1	802.11n (40MHz)	151 to 159	151, 159	OFDM	BPSK	13.5	1TX
B 2	802.11n (40MHz)	151 to 159	151, 159	OFDM	BPSK	27.0	2TX

### **ANTENNA PORT CONDUCTED MEASUREMENT:**

- This item includes all test value of each mode, but only includes spectrum plot of worst value of each mode.
- Pre-Scan has been conducted to determine the worst-case mode from all possible combinations between available modulations, data rates and antenna ports (if EUT with antenna diversity architecture).
- Following channel(s) was (were) selected for the final test as listed below.

EUT CONFIGURE MODE	MODE	AVAILABLE CHANNEL	TESTED CHANNEL	MODULATION TECHNOLOGY	MODULATION TYPE	DATA RATE (Mbps)	TX Function
B 1	802.11a	149 to 165	149, 157, 165	OFDM	BPSK	6.0	1TX
B 1	802.11n (20MHz)	149 to 165	149, 157, 165	OFDM	BPSK	6.5	1TX
B 2	802.11n (20MHz)	149 to 165	149, 157, 165	OFDM	BPSK	13.0	2TX
B 1	802.11n (40MHz)	151 to 159	151, 159	OFDM	BPSK	13.5	1TX
B 2	802.11n (40MHz)	151 to 159	151, 159	OFDM	BPSK	27.0	2TX



A D T

**TEST CONDITION:**

APPLICABLE TO	TEST MODE	ENVIRONMENTAL CONDITIONS	INPUT POWER (SYSTEM)	TESTED BY
RE $\geq$ 1G	A 1, A 2	22deg. C, 74%RH, 25deg. C, 67%RH	120Vac, 60Hz	Antony Lee, Chris Lin
	B 1, B 2	25deg. C, 68%RH	120Vac, 60Hz	Antony Lee
RE $<$ 1G	A 2	25deg. C, 67%RH	120Vac, 60Hz	Cedric Wu
	B 2	24deg. C, 64%RH	120Vac, 60Hz	Match Tsui
PLC	A 2	25deg. C, 65%RH	120Vac, 60Hz	Chris Lin
	B 2	24deg. C, 64%RH	120Vac, 60Hz	Match Tsui
APCM	B 1, B 2	25deg. C, 60%RH	120Vac, 60Hz	Frank Liu



### 3.3 DESCRIPTION OF SUPPORT UNITS

The EUT has been tested as an independent unit together with other necessary accessories or support units. The following support units or accessories were used to form a representative test configuration during the tests.

NO.	PRODUCT	BRAND	MODEL NO.	SERIAL NO.	FCC ID
1	NOTEBOOK	DELL	D820	21498926752	NA
2	CONVERTIBLE BOARD	NA	NA	NA	NA

NO.	SIGNAL CABLE DESCRIPTION OF THE ABOVE SUPPORT UNITS
1	NA
2	NA

**NOTE:** All power cords of the above support units are non shielded (1.8m).

#### 3.3.1 CONFIGURATION OF SYSTEM UNDER TEST

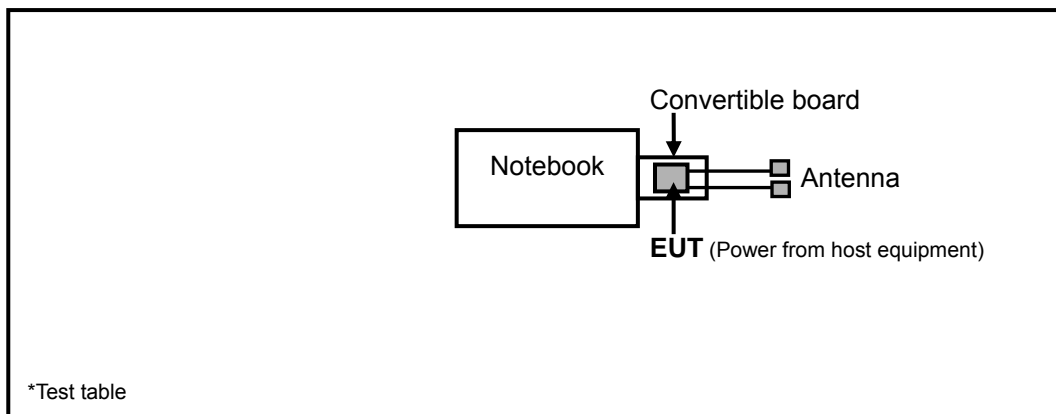



A D T

### **3.4 GENERAL DESCRIPTION OF APPLIED STANDARDS**

The EUT is a RF Product. According to the specifications of the manufacturer, it must comply with the requirements of the following standards:

**FCC Part 15, Subpart C (15.247)**

**558074 D01 DTS Meas Guidance v02**

**662911 D01 Multiple Transmitter Output v01 r02**

**ANSI C63.10-2009**

All test items have been performed and recorded as per the above standards.



## 4. TEST TYPES AND RESULTS (FOR 2.4GHz BAND)

### 4.1 RADIATED EMISSION AND BANDEDGE MEASUREMENT

#### 4.1.1 LIMITS OF RADIATED EMISSION AND BANDEDGE MEASUREMENT

Radiated emissions which fall in the restricted bands must comply with the radiated emission limits specified as below table. Other emissions shall be at least 20dB below the highest level of the desired power:

FREQUENCIES (MHz)	FIELD STRENGTH (microvolts/meter)	MEASUREMENT DISTANCE (meters)
0.009 ~ 0.490	2400/F(kHz)	300
0.490 ~ 1.705	24000/F(kHz)	30
1.705 ~ 30.0	30	30
30 ~ 88	100	3
88 ~ 216	150	3
216 ~ 960	200	3
Above 960	500	3

**NOTE:**

1. The lower limit shall apply at the transition frequencies.
2. Emission level (dBuV/m) = 20 log Emission level (uV/m).
3. For frequencies above 1000MHz, the field strength limits are based on average detector, however, the peak field strength of any emission shall not exceed the maximum permitted average limits, specified above by more than 20dB under any condition of modulation.



#### 4.1.2 TEST INSTRUMENTS

Test date: Oct. 20 ~ Dec. 11, 2012

DESCRIPTION & MANUFACTURER	MODEL NO.	SERIAL NO.	DATE OF CALIBRATION	DUE DATE OF CALIBRATION
Test Receiver ROHDE & SCHWARZ	ESCI	100744	Apr. 19, 2012	Apr. 18, 2013
Spectrum Analyzer ROHDE & SCHWARZ	FSP40	100269	Jan. 30, 2012	Jan. 29, 2013
BILOG Antenna SCHWARZBECK	VULB9168	9168-156	Apr. 03, 2012	Apr. 02, 2013
HORN Antenna SCHWARZBECK	BBHA 9120 D	9120D-563	Sep. 12, 2012	Sep. 11, 2013
HORN Antenna SCHWARZBECK	BBHA 9170	148	Jul. 11, 2012	Jul. 10, 2013
Preamplifier Agilent	8449B	3008A01975	Mar. 03, 2012	Mar. 02, 2013
Preamplifier Agilent	8447D	944A10663	May 11, 2012	May 10, 2013
RF signal cable HUBER+SUHNNER	SUCOFLEX 104	295013/4 283403/4	Aug. 28, 2012	Aug. 27, 2013
RF signal cable Worken	8D-FB	Cable-HYCH9-0 1	Aug. 11, 2012	Aug. 10, 2013
Software	ADT_Radiated_ V7.6.15.9.2	NA	NA	NA
Antenna Tower EMCO	2070/2080	512.835.4684	NA	NA
Turn Table EMCO	2087-2.03	NA	NA	NA
Antenna Tower & Turn Table Controller EMCO	2090	NA	NA	NA

- NOTE:**
1. The calibration interval of the above test instruments is 12 months and the calibrations are traceable to NML/ROC and NIST/USA.
  2. The test was performed in HwaYa Chamber 9.
  3. The horn antenna and HP preamplifier (model: 8449B) are used only for the measurement of emission frequency above 1GHz if tested.
  4. The FCC Site Registration No. is 460141.
  5. The IC Site Registration No. is IC 7450F-4.



#### 4.1.3 TEST PROCEDURES

- a. The EUT was placed on the top of a rotating table 0.8 meters above the ground at a 3 meters semi-anechoic chamber. The table was rotated 360 degrees to determine the position of the highest radiation.
- b. The EUT was set 3 meters away from the interference-receiving antenna, which was mounted on the top of a variable-height antenna tower.
- c. The antenna is a broadband antenna, and its height is varied from one meter to four meters above the ground to determine the maximum value of the field strength. Both horizontal and vertical polarizations of the antenna are set to make the measurement.
- d. For each suspected emission, the EUT was arranged to its worst case and then the antenna was tuned to heights from 1 meter to 4 meters and the rotatable table was turned from 0 degrees to 360 degrees to find the maximum reading.
- e. The test-receiver system was set to Peak Detect Function and Specified Bandwidth with Maximum Hold Mode.
- f. If the emission level of the EUT in peak mode was lower than the limit specified, then testing could be stopped and the peak values of the EUT would be reported. Otherwise the emissions would be re-tested one by one using peak, quasi-peak or average method as specified and then reported in a data sheet.

**NOTE:**

1. The resolution bandwidth and video bandwidth of test receiver/spectrum analyzer is 120kHz for Quasi-peak detection at frequency below 1GHz.
2. The resolution bandwidth of test receiver/spectrum analyzer is 100kHz and video bandwidth is 300kHz for Peak detection at frequency above 1GHz.
3. The resolution bandwidth of test receiver/spectrum analyzer is 1MHz and the video bandwidth is 1kHz for Average detection (AV) at frequency above 1GHz.
4. All modes of operation were investigated and the worst-case emissions are reported.

#### 4.1.4 DEVIATION FROM TEST STANDARD

No deviation.

#### 4.1.5 TEST SETUP

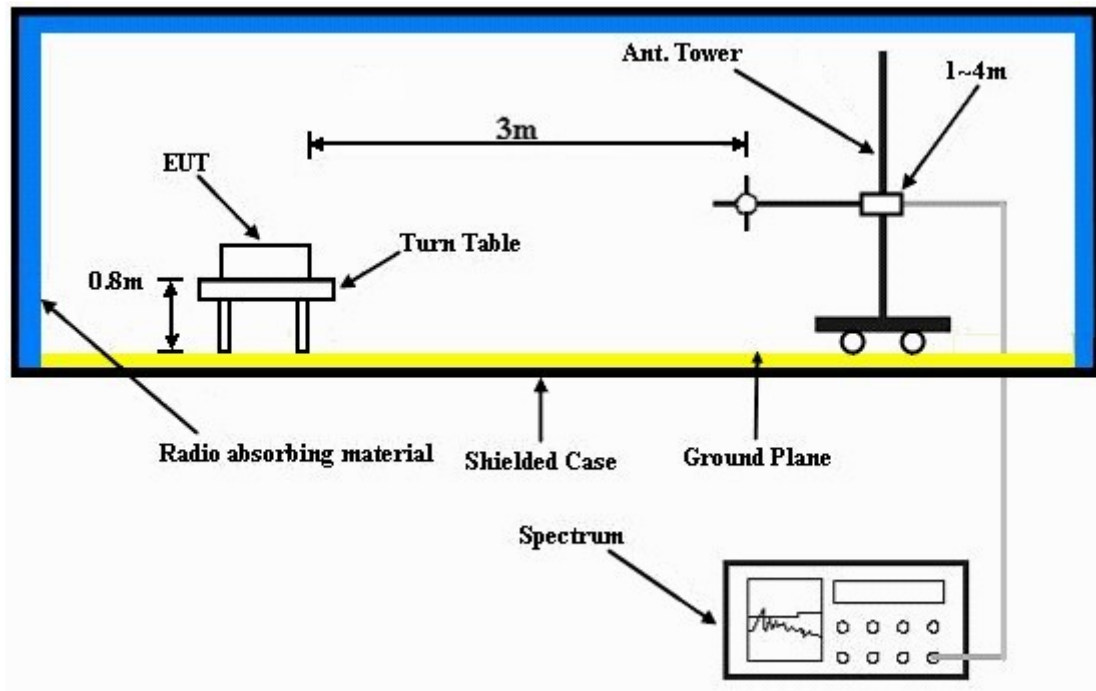

For the actual test configuration, please refer to the attached file (Test Setup Photo).

#### 4.1.6 EUT OPERATING CONDITIONS

- a. Plugged EUT into notebook system and placed on the testing table.
- b. The notebook system ran a test program (provided by manufacturer) to enable EUT under transmission condition continuously at specific channel frequency.



A D T

### 4.1.7 TEST RESULTS

#### PIFA Antenna\_1 TX

#### 802.11b

EUT TEST CONDITION		MEASUREMENT DETAIL	
CHANNEL	Channel 1	FREQUENCY RANGE	1 ~ 25GHz
INPUT POWER (SYSTEM)	120Vac, 60Hz	DETECTOR FUNCTION	Peak (PK) Average (AV)
ENVIRONMENTAL CONDITIONS	22deg. C, 74%RH	TESTED BY	Antony Lee
TEST MODE	A 1		

ANTENNA POLARITY & TEST DISTANCE: HORIZONTAL AT 3 M								
NO.	FREQ. (MHz)	EMISSION LEVEL (dBuV/m)	LIMIT (dBuV/m)	MARGIN (dB)	ANTENNA HEIGHT (m)	TABLE ANGLE (Degree)	RAW VALUE (dBuV)	CORRECTION FACTOR (dB/m)
1	2390.00	57.3 PK	74.0	-16.7	1.11 H	203	26.40	30.90
2	2390.00	46.1 AV	54.0	-7.9	1.11 H	203	15.20	30.90
3	*2412.00	106.3 PK			1.08 H	204	75.30	31.00
4	*2412.00	101.7 AV			1.08 H	204	70.70	31.00
5	4824.00	46.6 PK	74.0	-27.4	1.00 H	125	9.50	37.10
6	4824.00	34.7 AV	54.0	-19.3	1.00 H	125	-2.40	37.10

ANTENNA POLARITY & TEST DISTANCE: VERTICAL AT 3 M								
NO.	FREQ. (MHz)	EMISSION LEVEL (dBuV/m)	LIMIT (dBuV/m)	MARGIN (dB)	ANTENNA HEIGHT (m)	TABLE ANGLE (Degree)	RAW VALUE (dBuV)	CORRECTION FACTOR (dB/m)
1	2390.00	55.0 PK	74.0	-19.0	1.00 V	25	24.10	30.90
2	2390.00	44.5 AV	54.0	-9.5	1.00 V	25	13.60	30.90
3	*2412.00	100.3 PK			1.00 V	99	69.30	31.00
4	*2412.00	96.2 AV			1.00 V	99	65.20	31.00
5	4824.00	46.7 PK	74.0	-27.3	1.00 V	16	9.60	37.10
6	4824.00	34.8 AV	54.0	-19.2	1.00 V	16	-2.30	37.10

#### REMARKS:

1. Emission level (dBuV/m) = Raw Value (dBuV) + Correction Factor (dB/m).
2. Correction Factor (dB/m) = Antenna Factor (dB/m) + Cable Factor (dB).
3. The other emission levels were very low against the limit.
4. Margin value = Emission level – Limit value.
5. “ \* “: Fundamental frequency.



A D T

EUT TEST CONDITION		MEASUREMENT DETAIL	
CHANNEL	Channel 6	FREQUENCY RANGE	1 ~ 25GHz
INPUT POWER (SYSTEM)	120Vac, 60Hz	DETECTOR FUNCTION	Peak (PK) Average (AV)
ENVIRONMENTAL CONDITIONS	22deg. C, 74%RH	TESTED BY	Antony Lee
TEST MODE	A 1		

ANTENNA POLARITY & TEST DISTANCE: HORIZONTAL AT 3 M								
NO.	FREQ. (MHz)	EMISSION LEVEL (dBuV/m)	LIMIT (dBuV/m)	MARGIN (dB)	ANTENNA HEIGHT (m)	TABLE ANGLE (Degree)	RAW VALUE (dBuV)	CORRECTION FACTOR (dB/m)
1	*2437.00	106.3 PK			1.09 H	204	75.20	31.10
2	*2437.00	100.7 AV			1.09 H	204	69.60	31.10
3	#3249.00	46.5 PK	86.3	-39.8	1.02 H	280	13.40	33.10
4	#3249.00	39.9 AV	80.7	-40.8	1.02 H	280	6.80	33.10
5	4874.00	47.3 PK	74.0	-26.7	1.00 H	126	10.10	37.20
6	4874.00	35.8 AV	54.0	-18.2	1.00 H	126	-1.40	37.20

ANTENNA POLARITY & TEST DISTANCE: VERTICAL AT 3 M								
NO.	FREQ. (MHz)	EMISSION LEVEL (dBuV/m)	LIMIT (dBuV/m)	MARGIN (dB)	ANTENNA HEIGHT (m)	TABLE ANGLE (Degree)	RAW VALUE (dBuV)	CORRECTION FACTOR (dB/m)
1	*2437.00	100.5 PK			1.00 V	201	69.40	31.10
2	*2437.00	96.3 AV			1.00 V	201	65.20	31.10
3	#3249.00	44.9 PK	80.5	-35.6	1.00 V	23	11.80	33.10
4	#3249.00	31.7 AV	76.3	-44.6	1.00 V	23	-1.40	33.10
5	4874.00	46.3 PK	74.0	-27.7	1.00 V	236	9.10	37.20
6	4874.00	35.1 AV	54.0	-18.9	1.00 V	236	-2.10	37.20

**REMARKS:**

1. Emission level (dBuV/m) = Raw Value (dBuV) + Correction Factor (dB/m).
2. Correction Factor (dB/m) = Antenna Factor (dB/m) + Cable Factor (dB).
3. The other emission levels were very low against the limit.
4. Margin value = Emission level – Limit value.
5. " \* ": Fundamental frequency.
6. "#": The radiated frequency is out the restricted band.





A D T

EUT TEST CONDITION		MEASUREMENT DETAIL	
CHANNEL	Channel 11	FREQUENCY RANGE	1 ~ 25GHz
INPUT POWER (SYSTEM)	120Vac, 60Hz	DETECTOR FUNCTION	Peak (PK) Average (AV)
ENVIRONMENTAL CONDITIONS	22deg. C, 74%RH	TESTED BY	Antony Lee
TEST MODE	A 1		

ANTENNA POLARITY & TEST DISTANCE: HORIZONTAL AT 3 M								
NO.	FREQ. (MHz)	EMISSION LEVEL (dBuV/m)	LIMIT (dBuV/m)	MARGIN (dB)	ANTENNA HEIGHT (m)	TABLE ANGLE (Degree)	RAW VALUE (dBuV)	CORRECTION FACTOR (dB/m)
1	*2462.00	105.4 PK			1.05 H	163	74.20	31.20
2	*2462.00	100.9 AV			1.05 H	163	69.70	31.20
3	2483.50	56.3 PK	74.0	-17.7	1.05 H	163	25.00	31.30
4	2483.50	46.2 AV	54.0	-7.8	1.05 H	163	14.90	31.30
5	4924.00	47.0 PK	74.0	-27.0	1.00 H	125	9.70	37.30
6	4924.00	38.5 AV	54.0	-15.5	1.00 H	125	1.20	37.30

ANTENNA POLARITY & TEST DISTANCE: VERTICAL AT 3 M								
NO.	FREQ. (MHz)	EMISSION LEVEL (dBuV/m)	LIMIT (dBuV/m)	MARGIN (dB)	ANTENNA HEIGHT (m)	TABLE ANGLE (Degree)	RAW VALUE (dBuV)	CORRECTION FACTOR (dB/m)
1	*2462.00	98.4 PK			1.02 V	96	67.20	31.20
2	*2462.00	94.5 AV			1.02 V	96	63.30	31.20
3	2483.50	56.1 PK	74.0	-17.9	1.00 V	96	24.80	31.30
4	2483.50	46.2 AV	54.0	-7.8	1.00 V	96	14.90	31.30
5	4924.00	46.2 PK	74.0	-27.8	1.00 V	36	8.90	37.30
6	4924.00	34.0 AV	54.0	-20.0	1.00 V	36	-3.30	37.30

**REMARKS:**

1. Emission level (dBuV/m) = Raw Value (dBuV) + Correction Factor (dB/m).
2. Correction Factor (dB/m) = Antenna Factor (dB/m) + Cable Factor (dB).
3. The other emission levels were very low against the limit.
4. Margin value = Emission level – Limit value.
5. “ \* “: Fundamental frequency.



A D T

802.11g

EUT TEST CONDITION		MEASUREMENT DETAIL	
CHANNEL	Channel 1	FREQUENCY RANGE	1 ~ 25GHz
INPUT POWER (SYSTEM)	120Vac, 60Hz	DETECTOR FUNCTION	Peak (PK) Average (AV)
ENVIRONMENTAL CONDITIONS	22deg. C, 74%RH	TESTED BY	Antony Lee
TEST MODE	A 1		

ANTENNA POLARITY & TEST DISTANCE: HORIZONTAL AT 3 M								
NO.	FREQ. (MHz)	EMISSION LEVEL (dBuV/m)	LIMIT (dBuV/m)	MARGIN (dB)	ANTENNA HEIGHT (m)	TABLE ANGLE (Degree)	RAW VALUE (dBuV)	CORRECTION FACTOR (dB/m)
1	2390.00	68.6 PK	74.0	-5.4	1.13 H	202	37.70	30.90
2	2390.00	51.9 AV	54.0	-2.1	1.13 H	202	21.00	30.90
3	*2412.00	108.7 PK			1.13 H	202	77.70	31.00
4	*2412.00	97.2 AV			1.13 H	202	66.20	31.00
5	4824.00	46.7 PK	74.0	-27.3	1.00 H	66	9.60	37.10
6	4824.00	33.6 AV	54.0	-20.4	1.00 H	66	-3.50	37.10
ANTENNA POLARITY & TEST DISTANCE: VERTICAL AT 3 M								
NO.	FREQ. (MHz)	EMISSION LEVEL (dBuV/m)	LIMIT (dBuV/m)	MARGIN (dB)	ANTENNA HEIGHT (m)	TABLE ANGLE (Degree)	RAW VALUE (dBuV)	CORRECTION FACTOR (dB/m)
1	2390.00	62.1 PK	74.0	-11.9	1.00 V	100	31.20	30.90
2	2390.00	46.7 AV	54.0	-7.3	1.00 V	100	15.80	30.90
3	*2412.00	101.5 PK			1.00 V	100	70.50	31.00
4	*2412.00	91.5 AV			1.00 V	100	60.50	31.00
5	4824.00	46.5 PK	74.0	-27.5	1.00 V	163	9.40	37.10
6	4824.00	33.8 AV	54.0	-20.2	1.00 V	163	-3.30	37.10

REMARKS:

1. Emission level (dBuV/m) = Raw Value (dBuV) + Correction Factor (dB/m).
2. Correction Factor (dB/m) = Antenna Factor (dB/m) + Cable Factor (dB).
3. The other emission levels were very low against the limit.
4. Margin value = Emission level – Limit value.
5. “ \* ”: Fundamental frequency.



A D T

EUT TEST CONDITION		MEASUREMENT DETAIL	
CHANNEL	Channel 6	FREQUENCY RANGE	1 ~ 25GHz
INPUT POWER (SYSTEM)	120Vac, 60Hz	DETECTOR FUNCTION	Peak (PK) Average (AV)
ENVIRONMENTAL CONDITIONS	22deg. C, 74%RH	TESTED BY	Antony Lee
TEST MODE	A 1		

ANTENNA POLARITY & TEST DISTANCE: HORIZONTAL AT 3 M								
NO.	FREQ. (MHz)	EMISSION LEVEL (dBuV/m)	LIMIT (dBuV/m)	MARGIN (dB)	ANTENNA HEIGHT (m)	TABLE ANGLE (Degree)	RAW VALUE (dBuV)	CORRECTION FACTOR (dB/m)
1	*2437.00	106.5 PK			1.06 H	165	75.40	31.10
2	*2437.00	95.1 AV			1.06 H	165	64.00	31.10
3	#3249.00	49.3 PK	86.5	-37.2	1.02 H	315	16.20	33.10
4	#3249.00	40.2 AV	75.1	-34.9	1.02 H	315	7.10	33.10
5	4874.00	47.0 PK	74.0	-27.0	1.00 H	163	9.80	37.20
6	4874.00	34.2 AV	54.0	-19.8	1.00 H	163	-3.00	37.20

ANTENNA POLARITY & TEST DISTANCE: VERTICAL AT 3 M								
NO.	FREQ. (MHz)	EMISSION LEVEL (dBuV/m)	LIMIT (dBuV/m)	MARGIN (dB)	ANTENNA HEIGHT (m)	TABLE ANGLE (Degree)	RAW VALUE (dBuV)	CORRECTION FACTOR (dB/m)
1	*2437.00	102.8 PK			1.01 V	98	71.70	31.10
2	*2437.00	92.8 AV			1.01 V	98	61.70	31.10
3	#3249.00	45.0 PK	82.8	-37.8	1.00 V	66	11.90	33.10
4	#3249.00	32.9 AV	72.8	-39.9	1.00 V	66	-0.20	33.10
5	4874.00	47.0 PK	74.0	-27.0	1.00 V	36	9.80	37.20
6	4874.00	34.8 AV	54.0	-19.2	1.00 V	36	-2.40	37.20

**REMARKS:**

1. Emission level (dBuV/m) = Raw Value (dBuV) + Correction Factor (dB/m).
2. Correction Factor (dB/m) = Antenna Factor (dB/m) + Cable Factor (dB).
3. The other emission levels were very low against the limit.
4. Margin value = Emission level – Limit value.
5. " \* ": Fundamental frequency.
6. "#": The radiated frequency is out the restricted band.



A D T

EUT TEST CONDITION		MEASUREMENT DETAIL	
CHANNEL	Channel 11	FREQUENCY RANGE	1 ~ 25GHz
INPUT POWER (SYSTEM)	120Vac, 60Hz	DETECTOR FUNCTION	Peak (PK) Average (AV)
ENVIRONMENTAL CONDITIONS	22deg. C, 74%RH	TESTED BY	Antony Lee
TEST MODE	A 1		

ANTENNA POLARITY & TEST DISTANCE: HORIZONTAL AT 3 M								
NO.	FREQ. (MHz)	EMISSION LEVEL (dBuV/m)	LIMIT (dBuV/m)	MARGIN (dB)	ANTENNA HEIGHT (m)	TABLE ANGLE (Degree)	RAW VALUE (dBuV)	CORRECTION FACTOR (dB/m)
1	*2462.00	104.5 PK			1.02 H	160	73.30	31.20
2	*2462.00	94.2 AV			1.02 H	160	63.00	31.20
3	2483.50	70.6 PK	74.0	-3.4	1.02 H	160	39.30	31.30
4	2483.50	51.9 AV	54.0	-2.1	1.02 H	160	20.60	31.30
5	4924.00	45.4 PK	74.0	-28.6	1.00 H	163	8.10	37.30
6	4924.00	35.2 AV	54.0	-18.8	1.00 H	163	-2.10	37.30

ANTENNA POLARITY & TEST DISTANCE: VERTICAL AT 3 M								
NO.	FREQ. (MHz)	EMISSION LEVEL (dBuV/m)	LIMIT (dBuV/m)	MARGIN (dB)	ANTENNA HEIGHT (m)	TABLE ANGLE (Degree)	RAW VALUE (dBuV)	CORRECTION FACTOR (dB/m)
1	*2462.00	100.9 PK			1.00 V	95	69.70	31.20
2	*2462.00	91.2 AV			1.00 V	95	60.00	31.20
3	2483.50	70.0 PK	74.0	-4.0	1.00 V	95	38.70	31.30
4	2483.50	50.1 AV	54.0	-3.9	1.00 V	95	18.80	31.30
5	4924.00	45.5 PK	74.0	-28.5	1.00 V	269	8.20	37.30
6	4924.00	33.9 AV	54.0	-20.1	1.00 V	269	-3.40	37.30

**REMARKS:**

1. Emission level (dBuV/m) = Raw Value (dBuV) + Correction Factor (dB/m).
2. Correction Factor (dB/m) = Antenna Factor (dB/m) + Cable Factor (dB).
3. The other emission levels were very low against the limit.
4. Margin value = Emission level – Limit value.
5. “ \* “: Fundamental frequency.



A D T

802.11n (20MHz)

EUT TEST CONDITION		MEASUREMENT DETAIL	
CHANNEL	Channel 1	FREQUENCY RANGE	1 ~ 25GHz
INPUT POWER (SYSTEM)	120Vac, 60Hz	DETECTOR FUNCTION	Peak (PK) Average (AV)
ENVIRONMENTAL CONDITIONS	25deg. C, 67%RH	TESTED BY	Chris Lin
TEST MODE	A 1		

ANTENNA POLARITY & TEST DISTANCE: HORIZONTAL AT 3 M								
NO.	FREQ. (MHz)	EMISSION LEVEL (dBuV/m)	LIMIT (dBuV/m)	MARGIN (dB)	ANTENNA HEIGHT (m)	TABLE ANGLE (Degree)	RAW VALUE (dBuV)	CORRECTION FACTOR (dB/m)
1	2390.00	71.5 PK	74.0	-2.5	1.06 H	37	39.50	32.00
2	2390.00	51.7 AV	54.0	-2.3	1.06 H	37	19.70	32.00
3	*2412.00	103.4 PK			1.34 H	327	71.40	32.00
4	*2412.00	93.1 AV			1.34 H	327	61.10	32.00
5	4824.00	49.6 PK	74.0	-24.4	1.01 H	42	11.20	38.40
6	4824.00	34.5 AV	54.0	-19.5	1.01 H	42	-3.90	38.40
ANTENNA POLARITY & TEST DISTANCE: VERTICAL AT 3 M								
NO.	FREQ. (MHz)	EMISSION LEVEL (dBuV/m)	LIMIT (dBuV/m)	MARGIN (dB)	ANTENNA HEIGHT (m)	TABLE ANGLE (Degree)	RAW VALUE (dBuV)	CORRECTION FACTOR (dB/m)
1	2390.00	71.7 PK	74.0	-2.3	1.00 V	268	39.70	32.00
2	2390.00	51.4 AV	54.0	-2.6	1.00 V	268	19.40	32.00
3	*2412.00	101.6 PK			1.00 V	272	69.60	32.00
4	*2412.00	92.0 AV			1.00 V	272	60.00	32.00
5	4824.00	47.3 PK	74.0	-26.7	1.00 V	65	8.90	38.40
6	4824.00	33.3 AV	54.0	-20.7	1.00 V	65	-5.10	38.40

REMARKS:

1. Emission level (dBuV/m) = Raw Value (dBuV) + Correction Factor (dB/m).
2. Correction Factor (dB/m) = Antenna Factor (dB/m) + Cable Factor (dB).
3. The other emission levels were very low against the limit.
4. Margin value = Emission level – Limit value.
5. “ \* ”: Fundamental frequency.



A D T

EUT TEST CONDITION		MEASUREMENT DETAIL	
CHANNEL	Channel 6	FREQUENCY RANGE	1 ~ 25GHz
INPUT POWER (SYSTEM)	120Vac, 60Hz	DETECTOR FUNCTION	Peak (PK) Average (AV)
ENVIRONMENTAL CONDITIONS	25deg. C, 67%RH	TESTED BY	Chris Lin
TEST MODE	A 1		

ANTENNA POLARITY & TEST DISTANCE: HORIZONTAL AT 3 M								
NO.	FREQ. (MHz)	EMISSION LEVEL (dBuV/m)	LIMIT (dBuV/m)	MARGIN (dB)	ANTENNA HEIGHT (m)	TABLE ANGLE (Degree)	RAW VALUE (dBuV)	CORRECTION FACTOR (dB/m)
1	*2437.00	107.5 PK			1.07 H	341	75.40	32.10
2	*2437.00	97.1 AV			1.07 H	341	65.00	32.10
3	4874.00	46.6 PK	74.0	-27.4	1.00 H	69	8.20	38.40
4	4874.00	33.6 AV	54.0	-20.4	1.00 H	69	-4.80	38.40
5	7311.00	51.8 PK	74.0	-22.2	1.00 H	85	7.50	44.30
6	7311.00	38.7 AV	54.0	-15.3	1.00 H	85	-5.60	44.30

ANTENNA POLARITY & TEST DISTANCE: VERTICAL AT 3 M								
NO.	FREQ. (MHz)	EMISSION LEVEL (dBuV/m)	LIMIT (dBuV/m)	MARGIN (dB)	ANTENNA HEIGHT (m)	TABLE ANGLE (Degree)	RAW VALUE (dBuV)	CORRECTION FACTOR (dB/m)
1	*2437.00	102.8 PK			1.01 V	267	70.70	32.10
2	*2437.00	93.1 AV			1.01 V	267	61.00	32.10
3	4874.00	46.2 PK	74.0	-27.8	1.00 V	128	7.80	38.40
4	4874.00	32.9 AV	54.0	-21.1	1.00 V	128	-5.50	38.40
5	7311.00	51.8 PK	74.0	-22.2	1.00 V	74	7.50	44.30
6	7311.00	38.8 AV	54.0	-15.2	1.00 V	74	-5.50	44.30

**REMARKS:**

1. Emission level (dBuV/m) = Raw Value (dBuV) + Correction Factor (dB/m).
2. Correction Factor (dB/m) = Antenna Factor (dB/m) + Cable Factor (dB).
3. The other emission levels were very low against the limit.
4. Margin value = Emission level – Limit value.
5. “ \* ”: Fundamental frequency.



A D T

EUT TEST CONDITION		MEASUREMENT DETAIL	
CHANNEL	Channel 11	FREQUENCY RANGE	1 ~ 25GHz
INPUT POWER (SYSTEM)	120Vac, 60Hz	DETECTOR FUNCTION	Peak (PK) Average (AV)
ENVIRONMENTAL CONDITIONS	25deg. C, 67%RH	TESTED BY	Chris Lin
TEST MODE	A 1		

ANTENNA POLARITY & TEST DISTANCE: HORIZONTAL AT 3 M								
NO.	FREQ. (MHz)	EMISSION LEVEL (dBuV/m)	LIMIT (dBuV/m)	MARGIN (dB)	ANTENNA HEIGHT (m)	TABLE ANGLE (Degree)	RAW VALUE (dBuV)	CORRECTION FACTOR (dB/m)
1	*2462.00	106.3 PK			1.06 H	338	74.10	32.20
2	*2462.00	96.1 AV			1.06 H	338	63.90	32.20
3	2483.50	69.9 PK	74.0	-4.1	1.06 H	338	37.60	32.30
4	2483.50	52.0 AV	54.0	-2.0	1.06 H	338	19.70	32.30
5	4924.00	47.9 PK	74.0	-26.1	1.00 H	74	9.50	38.40
6	4924.00	35.6 AV	54.0	-18.4	1.00 H	74	-2.80	38.40

ANTENNA POLARITY & TEST DISTANCE: VERTICAL AT 3 M								
NO.	FREQ. (MHz)	EMISSION LEVEL (dBuV/m)	LIMIT (dBuV/m)	MARGIN (dB)	ANTENNA HEIGHT (m)	TABLE ANGLE (Degree)	RAW VALUE (dBuV)	CORRECTION FACTOR (dB/m)
1	*2462.00	101.8 PK			1.53 V	262	69.60	32.20
2	*2462.00	92.6 AV			1.53 V	262	60.40	32.20
3	2483.50	61.0 PK	74.0	-13.0	1.53 V	262	28.70	32.30
4	2483.50	47.9 AV	54.0	-6.1	1.53 V	262	15.60	32.30
5	4924.00	48.1 PK	74.0	-25.9	1.00 V	47	9.70	38.40
6	4924.00	36.7 AV	54.0	-17.3	1.00 V	47	-1.70	38.40

**REMARKS:**

1. Emission level (dBuV/m) = Raw Value (dBuV) + Correction Factor (dB/m).
2. Correction Factor (dB/m) = Antenna Factor (dB/m) + Cable Factor (dB).
3. The other emission levels were very low against the limit.
4. Margin value = Emission level – Limit value.
5. “ \* “: Fundamental frequency.



A D T

802.11n (40MHz)

EUT TEST CONDITION		MEASUREMENT DETAIL	
CHANNEL	Channel 3	FREQUENCY RANGE	1 ~ 25GHz
INPUT POWER (SYSTEM)	120Vac, 60Hz	DETECTOR FUNCTION	Peak (PK) Average (AV)
ENVIRONMENTAL CONDITIONS	22deg. C, 74%RH	TESTED BY	Antony Lee
TEST MODE	A 1		

ANTENNA POLARITY & TEST DISTANCE: HORIZONTAL AT 3 M								
NO.	FREQ. (MHz)	EMISSION LEVEL (dBuV/m)	LIMIT (dBuV/m)	MARGIN (dB)	ANTENNA HEIGHT (m)	TABLE ANGLE (Degree)	RAW VALUE (dBuV)	CORRECTION FACTOR (dB/m)
1	2390.00	61.1 PK	74.0	-12.9	1.11 H	231	30.20	30.90
2	2390.00	49.5 AV	54.0	-4.5	1.11 H	231	18.60	30.90
3	*2422.00	102.2 PK			1.11 H	231	71.10	31.10
4	*2422.00	91.0 AV			1.11 H	231	59.90	31.10
5	4844.00	47.8 PK	74.0	-26.2	1.00 H	325	10.70	37.10
6	4844.00	34.7 AV	54.0	-19.3	1.00 H	325	-2.40	37.10
ANTENNA POLARITY & TEST DISTANCE: VERTICAL AT 3 M								
NO.	FREQ. (MHz)	EMISSION LEVEL (dBuV/m)	LIMIT (dBuV/m)	MARGIN (dB)	ANTENNA HEIGHT (m)	TABLE ANGLE (Degree)	RAW VALUE (dBuV)	CORRECTION FACTOR (dB/m)
1	2390.00	58.3 PK	74.0	-15.7	1.00 V	98	27.40	30.90
2	2390.00	48.2 AV	54.0	-5.8	1.00 V	98	17.30	30.90
3	*2422.00	98.2 PK			1.02 V	98	67.10	31.10
4	*2422.00	87.0 AV			1.02 V	98	55.90	31.10
5	4844.00	47.9 PK	74.0	-26.1	1.00 V	69	10.80	37.10
6	4844.00	33.9 AV	54.0	-20.1	1.00 V	69	-3.20	37.10

REMARKS:

1. Emission level (dBuV/m) = Raw Value (dBuV) + Correction Factor (dB/m).
2. Correction Factor (dB/m) = Antenna Factor (dB/m) + Cable Factor (dB).
3. The other emission levels were very low against the limit.
4. Margin value = Emission level – Limit value.
5. “ \* “: Fundamental frequency.





A D T

EUT TEST CONDITION		MEASUREMENT DETAIL	
CHANNEL	Channel 6	FREQUENCY RANGE	1 ~ 25GHz
INPUT POWER (SYSTEM)	120Vac, 60Hz	DETECTOR FUNCTION	Peak (PK) Average (AV)
ENVIRONMENTAL CONDITIONS	22deg. C, 74%RH	TESTED BY	Antony Lee
TEST MODE	A 1		

ANTENNA POLARITY & TEST DISTANCE: HORIZONTAL AT 3 M								
NO.	FREQ. (MHz)	EMISSION LEVEL (dBuV/m)	LIMIT (dBuV/m)	MARGIN (dB)	ANTENNA HEIGHT (m)	TABLE ANGLE (Degree)	RAW VALUE (dBuV)	CORRECTION FACTOR (dB/m)
1	*2437.00	101.3 PK			1.38 H	220	70.20	31.10
2	*2437.00	89.6 AV			1.38 H	220	58.50	31.10
3	#3249.00	46.8 PK	81.3	-34.5	1.00 H	65	13.70	33.10
4	#3249.00	39.4 AV	69.6	-30.2	1.00 H	65	6.30	33.10
5	4874.00	48.2 PK	74.0	-25.8	1.00 H	331	11.00	37.20
6	4874.00	35.3 AV	54.0	-18.7	1.00 H	331	-1.90	37.20
ANTENNA POLARITY & TEST DISTANCE: VERTICAL AT 3 M								
NO.	FREQ. (MHz)	EMISSION LEVEL (dBuV/m)	LIMIT (dBuV/m)	MARGIN (dB)	ANTENNA HEIGHT (m)	TABLE ANGLE (Degree)	RAW VALUE (dBuV)	CORRECTION FACTOR (dB/m)
1	*2437.00	98.1 PK			1.02 V	100	67.00	31.10
2	*2437.00	87.2 AV			1.02 V	100	56.10	31.10
3	#3249.00	47.3 PK	78.1	-30.8	1.01 V	268	14.20	33.10
4	#3249.00	40.5 AV	67.2	-26.7	1.01 V	268	7.40	33.10
5	4874.00	50.2 PK	74.0	-23.8	1.00 V	169	13.00	37.20
6	4874.00	37.4 AV	54.0	-16.6	1.00 V	169	0.20	37.20

**REMARKS:**

1. Emission level (dBuV/m) = Raw Value (dBuV) + Correction Factor (dB/m).
2. Correction Factor (dB/m) = Antenna Factor (dB/m) + Cable Factor (dB).
3. The other emission levels were very low against the limit.
4. Margin value = Emission level – Limit value.
5. " \* ": Fundamental frequency.
6. "#": The radiated frequency is out the restricted band.



A D T

EUT TEST CONDITION		MEASUREMENT DETAIL	
CHANNEL	Channel 9	FREQUENCY RANGE	1 ~ 25GHz
INPUT POWER (SYSTEM)	120Vac, 60Hz	DETECTOR FUNCTION	Peak (PK) Average (AV)
ENVIRONMENTAL CONDITIONS	22deg. C, 74%RH	TESTED BY	Antony Lee
TEST MODE	A 1		

ANTENNA POLARITY & TEST DISTANCE: HORIZONTAL AT 3 M								
NO.	FREQ. (MHz)	EMISSION LEVEL (dBuV/m)	LIMIT (dBuV/m)	MARGIN (dB)	ANTENNA HEIGHT (m)	TABLE ANGLE (Degree)	RAW VALUE (dBuV)	CORRECTION FACTOR (dB/m)
1	*2452.00	101.9 PK			1.96 H	193	70.70	31.20
2	*2452.00	90.7 AV			1.96 H	193	59.50	31.20
3	2483.50	61.8 PK	74.0	-12.2	1.96 H	193	30.50	31.30
4	2483.50	50.8 AV	54.0	-3.2	1.96 H	193	19.50	31.30
5	4904.00	48.3 PK	74.0	-25.7	1.00 H	22	11.10	37.20
6	4904.00	35.4 AV	54.0	-18.6	1.00 H	22	-1.80	37.20

ANTENNA POLARITY & TEST DISTANCE: VERTICAL AT 3 M								
NO.	FREQ. (MHz)	EMISSION LEVEL (dBuV/m)	LIMIT (dBuV/m)	MARGIN (dB)	ANTENNA HEIGHT (m)	TABLE ANGLE (Degree)	RAW VALUE (dBuV)	CORRECTION FACTOR (dB/m)
1	*2452.00	97.8 PK			1.02 V	102	66.60	31.20
2	*2452.00	87.0 AV			1.02 V	102	55.80	31.20
3	2483.50	60.9 PK	74.0	-13.1	1.00 V	102	29.60	31.30
4	2483.50	48.8 AV	54.0	-5.2	1.00 V	102	17.50	31.30
5	4904.00	49.5 PK	74.0	-24.5	1.00 V	236	12.30	37.20
6	4904.00	36.4 AV	54.0	-17.6	1.00 V	236	-0.80	37.20

**REMARKS:**

1. Emission level (dBuV/m) = Raw Value (dBuV) + Correction Factor (dB/m).
2. Correction Factor (dB/m) = Antenna Factor (dB/m) + Cable Factor (dB).
3. The other emission levels were very low against the limit.
4. Margin value = Emission level – Limit value.
5. “ \* “: Fundamental frequency.



A D T

## PIFA Antenna\_2 TX

## 802.11n (20MHz)

EUT TEST CONDITION		MEASUREMENT DETAIL	
CHANNEL	Channel 1	FREQUENCY RANGE	1 ~ 25GHz
INPUT POWER (SYSTEM)	120Vac, 60Hz	DETECTOR FUNCTION	Peak (PK) Average (AV)
ENVIRONMENTAL CONDITIONS	22deg. C, 74%RH	TESTED BY	Antony Lee
TEST MODE	A 2		

ANTENNA POLARITY & TEST DISTANCE: HORIZONTAL AT 3 M								
NO.	FREQ. (MHz)	EMISSION LEVEL (dBuV/m)	LIMIT (dBuV/m)	MARGIN (dB)	ANTENNA HEIGHT (m)	TABLE ANGLE (Degree)	RAW VALUE (dBuV)	CORRECTION FACTOR (dB/m)
1	2390.00	59.1 PK	74.0	-14.9	1.10 H	203	28.20	30.90
2	2390.00	47.7 AV	54.0	-6.3	1.10 H	203	16.80	30.90
3	*2412.00	106.7 PK			1.12 H	203	75.70	31.00
4	*2412.00	96.2 AV			1.12 H	203	65.20	31.00
5	4824.00	47.6 PK	74.0	-26.4	1.00 H	33	10.50	37.10
6	4824.00	34.6 AV	54.0	-19.4	1.00 H	33	-2.50	37.10
ANTENNA POLARITY & TEST DISTANCE: VERTICAL AT 3 M								
NO.	FREQ. (MHz)	EMISSION LEVEL (dBuV/m)	LIMIT (dBuV/m)	MARGIN (dB)	ANTENNA HEIGHT (m)	TABLE ANGLE (Degree)	RAW VALUE (dBuV)	CORRECTION FACTOR (dB/m)
1	2390.00	56.6 PK	74.0	-17.4	1.00 V	100	25.70	30.90
2	2390.00	46.2 AV	54.0	-7.8	1.00 V	100	15.30	30.90
3	*2412.00	100.4 PK			1.00 V	100	69.40	31.00
4	*2412.00	88.9 AV			1.00 V	100	57.90	31.00
5	4824.00	46.8 PK	74.0	-27.2	1.00 V	33	9.70	37.10
6	4824.00	34.7 AV	54.0	-19.3	1.00 V	33	-2.40	37.10

## REMARKS:

1. Emission level (dBuV/m) = Raw Value (dBuV) + Correction Factor (dB/m).
2. Correction Factor (dB/m) = Antenna Factor (dB/m) + Cable Factor (dB).
3. The other emission levels were very low against the limit.
4. Margin value = Emission level – Limit value.
5. “ \* “: Fundamental frequency.



A D T

EUT TEST CONDITION		MEASUREMENT DETAIL	
CHANNEL	Channel 6	FREQUENCY RANGE	1 ~ 25GHz
INPUT POWER (SYSTEM)	120Vac, 60Hz	DETECTOR FUNCTION	Peak (PK) Average (AV)
ENVIRONMENTAL CONDITIONS	22deg. C, 74%RH	TESTED BY	Antony Lee
TEST MODE	A 2		

ANTENNA POLARITY & TEST DISTANCE: HORIZONTAL AT 3 M								
NO.	FREQ. (MHz)	EMISSION LEVEL (dBuV/m)	LIMIT (dBuV/m)	MARGIN (dB)	ANTENNA HEIGHT (m)	TABLE ANGLE (Degree)	RAW VALUE (dBuV)	CORRECTION FACTOR (dB/m)
1	*2437.00	105.1 PK			1.02 H	203	74.00	31.10
2	*2437.00	94.6 AV			1.02 H	203	63.50	31.10
3	#3249.00	50.3 PK	85.1	-34.8	1.01 H	321	17.20	33.10
4	#3249.00	41.2 AV	74.6	-33.4	1.01 H	321	8.10	33.10
5	4874.00	47.3 PK	74.0	-26.7	1.00 H	204	10.10	37.20
6	4874.00	34.5 AV	54.0	-19.5	1.00 H	204	-2.70	37.20
ANTENNA POLARITY & TEST DISTANCE: VERTICAL AT 3 M								
NO.	FREQ. (MHz)	EMISSION LEVEL (dBuV/m)	LIMIT (dBuV/m)	MARGIN (dB)	ANTENNA HEIGHT (m)	TABLE ANGLE (Degree)	RAW VALUE (dBuV)	CORRECTION FACTOR (dB/m)
1	*2437.00	101.1 PK			1.00 V	99	70.00	31.10
2	*2437.00	89.9 AV			1.00 V	99	58.80	31.10
3	#3249.00	45.2 PK	81.1	-35.9	1.00 V	69	12.10	33.10
4	#3249.00	33.6 AV	69.9	-36.3	1.00 V	69	0.50	33.10
5	4874.00	47.2 PK	74.0	-26.8	1.00 V	66	10.00	37.20
6	4874.00	35.2 AV	54.0	-18.8	1.00 V	66	-2.00	37.20

**REMARKS:**

1. Emission level (dBuV/m) = Raw Value (dBuV) + Correction Factor (dB/m).
2. Correction Factor (dB/m) = Antenna Factor (dB/m) + Cable Factor (dB).
3. The other emission levels were very low against the limit.
4. Margin value = Emission level – Limit value.
5. “ \* “: Fundamental frequency.
6. “#”:The radiated frequency is out the restricted band.



A D T

EUT TEST CONDITION		MEASUREMENT DETAIL	
CHANNEL	Channel 11	FREQUENCY RANGE	1 ~ 25GHz
INPUT POWER (SYSTEM)	120Vac, 60Hz	DETECTOR FUNCTION	Peak (PK) Average (AV)
ENVIRONMENTAL CONDITIONS	22deg. C, 74%RH	TESTED BY	Antony Lee
TEST MODE	A 2		

ANTENNA POLARITY & TEST DISTANCE: HORIZONTAL AT 3 M								
NO.	FREQ. (MHz)	EMISSION LEVEL (dBuV/m)	LIMIT (dBuV/m)	MARGIN (dB)	ANTENNA HEIGHT (m)	TABLE ANGLE (Degree)	RAW VALUE (dBuV)	CORRECTION FACTOR (dB/m)
1	*2462.00	105.0 PK			1.31 H	249	73.80	31.20
2	*2462.00	94.3 AV			1.31 H	249	63.10	31.20
3	2483.50	63.7 PK	74.0	-10.3	1.31 H	249	32.40	31.30
4	2483.50	48.6 AV	54.0	-5.4	1.31 H	249	17.30	31.30
5	4924.00	46.3 PK	74.0	-27.7	1.00 H	188	9.00	37.30
6	4924.00	36.4 AV	54.0	-17.6	1.00 H	188	-0.90	37.30

ANTENNA POLARITY & TEST DISTANCE: VERTICAL AT 3 M								
NO.	FREQ. (MHz)	EMISSION LEVEL (dBuV/m)	LIMIT (dBuV/m)	MARGIN (dB)	ANTENNA HEIGHT (m)	TABLE ANGLE (Degree)	RAW VALUE (dBuV)	CORRECTION FACTOR (dB/m)
1	*2462.00	101.7 PK			1.00 V	96	70.50	31.20
2	*2462.00	90.4 AV			1.00 V	96	59.20	31.20
3	2483.50	62.8 PK	74.0	-11.2	1.00 V	96	31.50	31.30
4	2483.50	47.0 AV	54.0	-7.0	1.00 V	96	15.70	31.30
5	4924.00	45.9 PK	74.0	-28.1	1.00 V	274	8.60	37.30
6	4924.00	34.2 AV	54.0	-19.8	1.00 V	274	-3.10	37.30

**REMARKS:**

1. Emission level (dBuV/m) = Raw Value (dBuV) + Correction Factor (dB/m).
2. Correction Factor (dB/m) = Antenna Factor (dB/m) + Cable Factor (dB).
3. The other emission levels were very low against the limit.
4. Margin value = Emission level – Limit value.
5. “ \* “: Fundamental frequency.



A D T

802.11n (40MHz)

EUT TEST CONDITION		MEASUREMENT DETAIL	
CHANNEL	Channel 3	FREQUENCY RANGE	1 ~ 25GHz
INPUT POWER (SYSTEM)	120Vac, 60Hz	DETECTOR FUNCTION	Peak (PK) Average (AV)
ENVIRONMENTAL CONDITIONS	25deg. C, 67%RH	TESTED BY	Chris Lin
TEST MODE	A 2		

ANTENNA POLARITY & TEST DISTANCE: HORIZONTAL AT 3 M								
NO.	FREQ. (MHz)	EMISSION LEVEL (dBuV/m)	LIMIT (dBuV/m)	MARGIN (dB)	ANTENNA HEIGHT (m)	TABLE ANGLE (Degree)	RAW VALUE (dBuV)	CORRECTION FACTOR (dB/m)
1	2390.00	70.0 PK	74.0	-4.0	1.07 H	349	38.00	32.00
2	2390.00	51.7 AV	54.0	-2.3	1.07 H	349	19.70	32.00
3	*2422.00	100.2 PK			1.07 H	349	68.10	32.10
4	*2422.00	90.4 AV			1.07 H	349	58.30	32.10
5	4844.00	46.0 PK	74.0	-28.0	1.00 H	174	7.60	38.40
6	4844.00	33.2 AV	54.0	-20.8	1.00 H	174	-5.20	38.40
ANTENNA POLARITY & TEST DISTANCE: VERTICAL AT 3 M								
NO.	FREQ. (MHz)	EMISSION LEVEL (dBuV/m)	LIMIT (dBuV/m)	MARGIN (dB)	ANTENNA HEIGHT (m)	TABLE ANGLE (Degree)	RAW VALUE (dBuV)	CORRECTION FACTOR (dB/m)
1	2390.00	64.9 PK	74.0	-9.1	1.00 V	98	32.90	32.00
2	2390.00	48.2 AV	54.0	-5.8	1.00 V	98	16.20	32.00
3	*2422.00	96.7 PK			1.00 V	98	64.60	32.10
4	*2422.00	87.1 AV			1.00 V	98	55.00	32.10
5	4844.00	46.0 PK	74.0	-28.0	1.07 V	52	7.60	38.40
6	4844.00	33.0 AV	54.0	-21.0	1.07 V	52	-5.40	38.40

REMARKS:

1. Emission level (dBuV/m) = Raw Value (dBuV) + Correction Factor (dB/m).
2. Correction Factor (dB/m) = Antenna Factor (dB/m) + Cable Factor (dB).
3. The other emission levels were very low against the limit.
4. Margin value = Emission level – Limit value.
5. “ \* “: Fundamental frequency.



A D T

EUT TEST CONDITION		MEASUREMENT DETAIL	
CHANNEL	Channel 6	FREQUENCY RANGE	1 ~ 25GHz
INPUT POWER (SYSTEM)	120Vac, 60Hz	DETECTOR FUNCTION	Peak (PK) Average (AV)
ENVIRONMENTAL CONDITIONS	25deg. C, 67%RH	TESTED BY	Chris Lin
TEST MODE	A 2		

ANTENNA POLARITY & TEST DISTANCE: HORIZONTAL AT 3 M								
NO.	FREQ. (MHz)	EMISSION LEVEL (dBuV/m)	LIMIT (dBuV/m)	MARGIN (dB)	ANTENNA HEIGHT (m)	TABLE ANGLE (Degree)	RAW VALUE (dBuV)	CORRECTION FACTOR (dB/m)
1	*2437.00	103.5 PK			1.07 H	340	71.40	32.10
2	*2437.00	93.3 AV			1.07 H	340	61.20	32.10
3	4874.00	45.2 PK	74.0	-28.8	1.00 H	96	6.80	38.40
4	4874.00	32.3 AV	54.0	-21.7	1.00 H	96	-6.10	38.40
5	7311.00	51.2 PK	74.0	-22.8	1.00 H	41	6.90	44.30
6	7311.00	38.5 AV	54.0	-15.5	1.00 H	41	-5.80	44.30
ANTENNA POLARITY & TEST DISTANCE: VERTICAL AT 3 M								
NO.	FREQ. (MHz)	EMISSION LEVEL (dBuV/m)	LIMIT (dBuV/m)	MARGIN (dB)	ANTENNA HEIGHT (m)	TABLE ANGLE (Degree)	RAW VALUE (dBuV)	CORRECTION FACTOR (dB/m)
1	*2437.00	98.8 PK			1.03 V	267	66.70	32.10
2	*2437.00	88.6 AV			1.03 V	267	56.50	32.10
3	4874.00	45.5 PK	74.0	-28.5	1.00 V	127	7.10	38.40
4	4874.00	32.7 AV	54.0	-21.3	1.00 V	127	-5.70	38.40
5	7311.00	51.7 PK	74.0	-22.3	1.00 V	85	7.40	44.30
6	7311.00	38.7 AV	54.0	-15.3	1.00 V	85	-5.60	44.30

**REMARKS:**

1. Emission level (dBuV/m) = Raw Value (dBuV) + Correction Factor (dB/m).
2. Correction Factor (dB/m) = Antenna Factor (dB/m) + Cable Factor (dB).
3. The other emission levels were very low against the limit.
4. Margin value = Emission level – Limit value.
5. “ \* “: Fundamental frequency.



A D T

EUT TEST CONDITION		MEASUREMENT DETAIL	
CHANNEL	Channel 9	FREQUENCY RANGE	1 ~ 25GHz
INPUT POWER (SYSTEM)	120Vac, 60Hz	DETECTOR FUNCTION	Peak (PK) Average (AV)
ENVIRONMENTAL CONDITIONS	25deg. C, 67%RH	TESTED BY	Chris Lin
TEST MODE	A 2		

ANTENNA POLARITY & TEST DISTANCE: HORIZONTAL AT 3 M								
NO.	FREQ. (MHz)	EMISSION LEVEL (dBuV/m)	LIMIT (dBuV/m)	MARGIN (dB)	ANTENNA HEIGHT (m)	TABLE ANGLE (Degree)	RAW VALUE (dBuV)	CORRECTION FACTOR (dB/m)
1	*2452.00	99.4 PK			1.02 H	338	67.20	32.20
2	*2452.00	89.6 AV			1.02 H	338	57.40	32.20
3	2483.50	69.3 PK	74.0	-4.7	1.02 H	338	37.00	32.30
4	2483.50	52.0 AV	54.0	-2.0	1.02 H	338	19.70	32.30
5	4904.00	45.8 PK	74.0	-28.2	1.10 H	85	7.30	38.50
6	4904.00	33.7 AV	54.0	-20.3	1.10 H	85	-4.80	38.50
ANTENNA POLARITY & TEST DISTANCE: VERTICAL AT 3 M								
NO.	FREQ. (MHz)	EMISSION LEVEL (dBuV/m)	LIMIT (dBuV/m)	MARGIN (dB)	ANTENNA HEIGHT (m)	TABLE ANGLE (Degree)	RAW VALUE (dBuV)	CORRECTION FACTOR (dB/m)
1	*2452.00	95.6 PK			1.07 V	91	63.40	32.20
2	*2452.00	86.6 AV			1.07 V	91	54.40	32.20
3	2483.50	62.0 PK	74.0	-12.0	1.07 V	91	29.70	32.30
4	2483.50	48.8 AV	54.0	-5.2	1.07 V	91	16.50	32.30
5	4904.00	47.8 PK	74.0	-26.2	1.15 V	96	9.30	38.50
6	4904.00	32.8 AV	54.0	-21.2	1.15 V	96	-5.70	38.50

**REMARKS:**

1. Emission level (dBuV/m) = Raw Value (dBuV) + Correction Factor (dB/m).
2. Correction Factor (dB/m) = Antenna Factor (dB/m) + Cable Factor (dB).
3. The other emission levels were very low against the limit.
4. Margin value = Emission level – Limit value.
5. “ \* “: Fundamental frequency.





A D T

Monopole Antenna\_1TX

802.11b

EUT TEST CONDITION		MEASUREMENT DETAIL	
CHANNEL	Channel 1	FREQUENCY RANGE	1 ~ 25GHz
INPUT POWER (SYSTEM)	120Vac, 60Hz	DETECTOR FUNCTION	Peak (PK) Average (AV)
ENVIRONMENTAL CONDITIONS	25deg. C, 68%RH	TESTED BY	Antony Lee
TEST MODE	B 1		

ANTENNA POLARITY & TEST DISTANCE: HORIZONTAL AT 3 M								
NO.	FREQ. (MHz)	EMISSION LEVEL (dBuV/m)	LIMIT (dBuV/m)	MARGIN (dB)	ANTENNA HEIGHT (m)	TABLE ANGLE (Degree)	RAW VALUE (dBuV)	CORRECTION FACTOR (dB/m)
1	2390.00	55.8 PK	74.0	-18.2	1.31 H	314	24.90	30.90
2	2390.00	45.1 AV	54.0	-8.9	1.31 H	314	14.20	30.90
3	*2412.00	105.2 PK			1.31 H	313	74.20	31.00
4	*2412.00	100.5 AV			1.31 H	313	69.50	31.00
5	4824.00	45.6 PK	74.0	-28.4	1.00 H	38	8.50	37.10
6	4824.00	34.1 AV	54.0	-19.9	1.00 H	38	-3.00	37.10

ANTENNA POLARITY & TEST DISTANCE: VERTICAL AT 3 M								
NO.	FREQ. (MHz)	EMISSION LEVEL (dBuV/m)	LIMIT (dBuV/m)	MARGIN (dB)	ANTENNA HEIGHT (m)	TABLE ANGLE (Degree)	RAW VALUE (dBuV)	CORRECTION FACTOR (dB/m)
1	2390.00	53.7 PK	74.0	-20.3	1.08 V	275	22.80	30.90
2	2390.00	44.7 AV	54.0	-9.3	1.08 V	275	13.80	30.90
3	*2412.00	102.6 PK			1.08 V	275	71.60	31.00
4	*2412.00	98.1 AV			1.08 V	275	67.10	31.00
5	4824.00	45.2 PK	74.0	-28.8	1.00 V	302	8.10	37.10
6	4824.00	33.5 AV	54.0	-20.5	1.00 V	302	-3.60	37.10

REMARKS:

1. Emission level (dBuV/m) = Raw Value (dBuV) + Correction Factor (dB/m).
2. Correction Factor (dB/m) = Antenna Factor (dB/m) + Cable Factor (dB).
3. The other emission levels were very low against the limit.
4. Margin value = Emission level – Limit value.
5. “ \* “: Fundamental frequency.



A D T

EUT TEST CONDITION		MEASUREMENT DETAIL	
CHANNEL	Channel 6	FREQUENCY RANGE	1 ~ 25GHz
INPUT POWER (SYSTEM)	120Vac, 60Hz	DETECTOR FUNCTION	Peak (PK) Average (AV)
ENVIRONMENTAL CONDITIONS	25deg. C, 68%RH	TESTED BY	Antony Lee
TEST MODE	B 1		

ANTENNA POLARITY & TEST DISTANCE: HORIZONTAL AT 3 M								
NO.	FREQ. (MHz)	EMISSION LEVEL (dBuV/m)	LIMIT (dBuV/m)	MARGIN (dB)	ANTENNA HEIGHT (m)	TABLE ANGLE (Degree)	RAW VALUE (dBuV)	CORRECTION FACTOR (dB/m)
1	*2437.00	103.0 PK			1.28 H	316	71.90	31.10
2	*2437.00	98.5 AV			1.28 H	316	67.40	31.10
3	#3249.00	48.3 PK	83.0	-34.7	1.00 H	47	15.20	33.10
4	#3249.00	44.5 AV	78.5	-34.0	1.00 H	47	11.40	33.10
5	4874.00	46.2 PK	74.0	-27.8	1.00 H	52	9.00	37.20
6	4874.00	35.4 AV	54.0	-18.6	1.00 H	52	-1.80	37.20
ANTENNA POLARITY & TEST DISTANCE: VERTICAL AT 3 M								
NO.	FREQ. (MHz)	EMISSION LEVEL (dBuV/m)	LIMIT (dBuV/m)	MARGIN (dB)	ANTENNA HEIGHT (m)	TABLE ANGLE (Degree)	RAW VALUE (dBuV)	CORRECTION FACTOR (dB/m)
1	*2437.00	100.3 PK			1.34 V	276	69.20	31.10
2	*2437.00	96.2 AV			1.34 V	276	65.10	31.10
3	#3249.00	49.9 PK	80.3	-30.4	1.00 V	174	16.80	33.10
4	#3249.00	46.5 AV	76.2	-29.7	1.00 V	174	13.40	33.10
5	4874.00	45.3 PK	74.0	-28.7	1.00 V	311	8.10	37.20
6	4874.00	33.8 AV	54.0	-20.2	1.00 V	311	-3.40	37.20

**REMARKS:**

1. Emission level (dBuV/m) = Raw Value (dBuV) + Correction Factor (dB/m).
2. Correction Factor (dB/m) = Antenna Factor (dB/m) + Cable Factor (dB).
3. The other emission levels were very low against the limit.
4. Margin value = Emission level – Limit value.
5. “ \* “: Fundamental frequency.
6. “#”:The radiated frequency is out the restricted band.



A D T

EUT TEST CONDITION		MEASUREMENT DETAIL	
CHANNEL	Channel 11	FREQUENCY RANGE	1 ~ 25GHz
INPUT POWER (SYSTEM)	120Vac, 60Hz	DETECTOR FUNCTION	Peak (PK) Average (AV)
ENVIRONMENTAL CONDITIONS	25deg. C, 68%RH	TESTED BY	Antony Lee
TEST MODE	B 1		

ANTENNA POLARITY & TEST DISTANCE: HORIZONTAL AT 3 M								
NO.	FREQ. (MHz)	EMISSION LEVEL (dBuV/m)	LIMIT (dBuV/m)	MARGIN (dB)	ANTENNA HEIGHT (m)	TABLE ANGLE (Degree)	RAW VALUE (dBuV)	CORRECTION FACTOR (dB/m)
1	*2462.00	103.4 PK			1.00 H	317	72.20	31.20
2	*2462.00	98.8 AV			1.00 H	317	67.60	31.20
3	2483.50	55.5 PK	74.0	-18.5	1.26 H	317	24.20	31.30
4	2483.50	44.7 AV	54.0	-9.3	1.26 H	317	13.40	31.30
5	4924.00	46.3 PK	74.0	-27.7	1.00 H	35	9.00	37.30
6	4924.00	35.2 AV	54.0	-18.8	1.00 H	35	-2.10	37.30
ANTENNA POLARITY & TEST DISTANCE: VERTICAL AT 3 M								
NO.	FREQ. (MHz)	EMISSION LEVEL (dBuV/m)	LIMIT (dBuV/m)	MARGIN (dB)	ANTENNA HEIGHT (m)	TABLE ANGLE (Degree)	RAW VALUE (dBuV)	CORRECTION FACTOR (dB/m)
1	*2462.00	99.7 PK			1.63 V	273	68.50	31.20
2	*2462.00	95.0 AV			1.63 V	273	63.80	31.20
3	2483.50	55.1 PK	74.0	-18.9	1.63 V	273	23.80	31.30
4	2483.50	45.1 AV	54.0	-8.9	1.63 V	273	13.80	31.30
5	4924.00	45.6 PK	74.0	-28.4	1.00 V	321	8.30	37.30
6	4924.00	34.3 AV	54.0	-19.7	1.00 V	321	-3.00	37.30

**REMARKS:**

1. Emission level (dBuV/m) = Raw Value (dBuV) + Correction Factor (dB/m).
2. Correction Factor (dB/m) = Antenna Factor (dB/m) + Cable Factor (dB).
3. The other emission levels were very low against the limit.
4. Margin value = Emission level – Limit value.
5. “ \* “: Fundamental frequency.



A D T

## 802.11g

EUT TEST CONDITION		MEASUREMENT DETAIL	
CHANNEL	Channel 1	FREQUENCY RANGE	1 ~ 25GHz
INPUT POWER (SYSTEM)	120Vac, 60Hz	DETECTOR FUNCTION	Peak (PK) Average (AV)
ENVIRONMENTAL CONDITIONS	25deg. C, 68%RH	TESTED BY	Antony Lee
TEST MODE	B 1		

ANTENNA POLARITY & TEST DISTANCE: HORIZONTAL AT 3 M								
NO.	FREQ. (MHz)	EMISSION LEVEL (dBuV/m)	LIMIT (dBuV/m)	MARGIN (dB)	ANTENNA HEIGHT (m)	TABLE ANGLE (Degree)	RAW VALUE (dBuV)	CORRECTION FACTOR (dB/m)
1	2390.00	67.7 PK	74.0	-6.3	1.09 H	52	36.80	30.90
2	2390.00	49.5 AV	54.0	-4.5	1.09 H	52	18.60	30.90
3	*2412.00	104.7 PK			1.09 H	52	73.70	31.00
4	*2412.00	94.5 AV			1.09 H	52	63.50	31.00
5	4824.00	45.6 PK	74.0	-28.4	1.00 H	251	8.50	37.10
6	4824.00	32.1 AV	54.0	-21.9	1.00 H	251	-5.00	37.10

ANTENNA POLARITY & TEST DISTANCE: VERTICAL AT 3 M								
NO.	FREQ. (MHz)	EMISSION LEVEL (dBuV/m)	LIMIT (dBuV/m)	MARGIN (dB)	ANTENNA HEIGHT (m)	TABLE ANGLE (Degree)	RAW VALUE (dBuV)	CORRECTION FACTOR (dB/m)
1	2390.00	63.6 PK	74.0	-10.4	1.05 V	275	32.70	30.90
2	2390.00	47.4 AV	54.0	-6.6	1.05 V	275	16.50	30.90
3	*2412.00	102.7 PK			1.05 V	275	71.70	31.00
4	*2412.00	92.8 AV			1.05 V	275	61.80	31.00
5	4824.00	45.2 PK	74.0	-28.8	1.00 V	20	8.10	37.10
6	4824.00	32.1 AV	54.0	-21.9	1.00 V	20	-5.00	37.10

## REMARKS:

1. Emission level (dBuV/m) = Raw Value (dBuV) + Correction Factor (dB/m).
2. Correction Factor (dB/m) = Antenna Factor (dB/m) + Cable Factor (dB).
3. The other emission levels were very low against the limit.
4. Margin value = Emission level – Limit value.
5. “ \* “: Fundamental frequency.



A D T

EUT TEST CONDITION		MEASUREMENT DETAIL	
CHANNEL	Channel 6	FREQUENCY RANGE	1 ~ 25GHz
INPUT POWER (SYSTEM)	120Vac, 60Hz	DETECTOR FUNCTION	Peak (PK) Average (AV)
ENVIRONMENTAL CONDITIONS	25deg. C, 68%RH	TESTED BY	Antony Lee
TEST MODE	B 1		

ANTENNA POLARITY & TEST DISTANCE: HORIZONTAL AT 3 M								
NO.	FREQ. (MHz)	EMISSION LEVEL (dBuV/m)	LIMIT (dBuV/m)	MARGIN (dB)	ANTENNA HEIGHT (m)	TABLE ANGLE (Degree)	RAW VALUE (dBuV)	CORRECTION FACTOR (dB/m)
1	*2437.00	103.0 PK			1.26 H	316	71.90	31.10
2	*2437.00	92.9 AV			1.26 H	316	61.80	31.10
3	#3249.00	48.6 PK	83.0	-34.4	1.00 H	51	15.50	33.10
4	#3249.00	44.7 AV	72.9	-28.2	1.00 H	51	11.60	33.10
5	4874.00	46.5 PK	74.0	-27.5	1.00 H	54	9.30	37.20
6	4874.00	35.7 AV	54.0	-18.3	1.00 H	54	-1.50	37.20
ANTENNA POLARITY & TEST DISTANCE: VERTICAL AT 3 M								
NO.	FREQ. (MHz)	EMISSION LEVEL (dBuV/m)	LIMIT (dBuV/m)	MARGIN (dB)	ANTENNA HEIGHT (m)	TABLE ANGLE (Degree)	RAW VALUE (dBuV)	CORRECTION FACTOR (dB/m)
1	*2437.00	101.2 PK			1.03 V	279	70.10	31.10
2	*2437.00	91.2 AV			1.03 V	279	60.10	31.10
3	#3249.00	50.6 PK	81.2	-30.6	1.00 V	187	17.50	33.10
4	#3249.00	46.8 AV	71.2	-24.4	1.00 V	187	13.70	33.10
5	4874.00	45.8 PK	74.0	-28.2	1.00 V	316	8.60	37.20
6	4874.00	34.2 AV	54.0	-19.8	1.00 V	316	-3.00	37.20

**REMARKS:**

1. Emission level (dBuV/m) = Raw Value (dBuV) + Correction Factor (dB/m).
2. Correction Factor (dB/m) = Antenna Factor (dB/m) + Cable Factor (dB).
3. The other emission levels were very low against the limit.
4. Margin value = Emission level – Limit value.
5. “ \* “: Fundamental frequency.
6. “#”:The radiated frequency is out the restricted band.



A D T

EUT TEST CONDITION		MEASUREMENT DETAIL	
CHANNEL	Channel 11	FREQUENCY RANGE	1 ~ 25GHz
INPUT POWER (SYSTEM)	120Vac, 60Hz	DETECTOR FUNCTION	Peak (PK) Average (AV)
ENVIRONMENTAL CONDITIONS	25deg. C, 68%RH	TESTED BY	Antony Lee
TEST MODE	B 1		

ANTENNA POLARITY & TEST DISTANCE: HORIZONTAL AT 3 M								
NO.	FREQ. (MHz)	EMISSION LEVEL (dBuV/m)	LIMIT (dBuV/m)	MARGIN (dB)	ANTENNA HEIGHT (m)	TABLE ANGLE (Degree)	RAW VALUE (dBuV)	CORRECTION FACTOR (dB/m)
1	*2462.00	103.5 PK			1.27 H	315	72.30	31.20
2	*2462.00	93.3 AV			1.27 H	315	62.10	31.20
3	2483.50	60.5 PK	74.0	-13.5	1.27 H	315	29.20	31.30
4	2483.50	46.7 AV	54.0	-7.3	1.27 H	315	15.40	31.30
5	4924.00	46.8 PK	74.0	-27.2	1.00 H	33	9.50	37.30
6	4924.00	35.6 AV	54.0	-18.4	1.00 H	33	-1.70	37.30
ANTENNA POLARITY & TEST DISTANCE: VERTICAL AT 3 M								
NO.	FREQ. (MHz)	EMISSION LEVEL (dBuV/m)	LIMIT (dBuV/m)	MARGIN (dB)	ANTENNA HEIGHT (m)	TABLE ANGLE (Degree)	RAW VALUE (dBuV)	CORRECTION FACTOR (dB/m)
1	*2462.00	100.6 PK			1.34 V	274	69.40	31.20
2	*2462.00	90.6 AV			1.34 V	274	59.40	31.20
3	2483.50	61.0 PK	74.0	-13.0	1.34 V	274	29.70	31.30
4	2483.50	46.7 AV	54.0	-7.3	1.34 V	274	15.40	31.30
5	4924.00	46.8 PK	74.0	-27.2	1.00 V	330	9.50	37.30
6	4924.00	35.6 AV	54.0	-18.4	1.00 V	330	-1.70	37.30

**REMARKS:**

1. Emission level (dBuV/m) = Raw Value (dBuV) + Correction Factor (dB/m).
2. Correction Factor (dB/m) = Antenna Factor (dB/m) + Cable Factor (dB).
3. The other emission levels were very low against the limit.
4. Margin value = Emission level – Limit value.
5. “ \* “: Fundamental frequency.



A D T

802.11n (20MHz)

EUT TEST CONDITION		MEASUREMENT DETAIL	
CHANNEL	Channel 1	FREQUENCY RANGE	1 ~ 25GHz
INPUT POWER (SYSTEM)	120Vac, 60Hz	DETECTOR FUNCTION	Peak (PK) Average (AV)
ENVIRONMENTAL CONDITIONS	25deg. C, 68%RH	TESTED BY	Antony Lee
TEST MODE	B 1		

ANTENNA POLARITY & TEST DISTANCE: HORIZONTAL AT 3 M								
NO.	FREQ. (MHz)	EMISSION LEVEL (dBuV/m)	LIMIT (dBuV/m)	MARGIN (dB)	ANTENNA HEIGHT (m)	TABLE ANGLE (Degree)	RAW VALUE (dBuV)	CORRECTION FACTOR (dB/m)
1	2390.00	69.5 PK	74.0	-4.5	1.33 H	56	38.60	30.90
2	2390.00	52.2 AV	54.0	-1.8	1.33 H	56	21.30	30.90
3	*2412.00	104.4 PK			1.33 H	56	73.40	31.00
4	*2412.00	94.3 AV			1.33 H	56	63.30	31.00
5	4824.00	45.5 PK	74.0	-28.5	1.00 H	326	8.40	37.10
6	4824.00	32.3 AV	54.0	-21.7	1.00 H	326	-4.80	37.10

ANTENNA POLARITY & TEST DISTANCE: VERTICAL AT 3 M								
NO.	FREQ. (MHz)	EMISSION LEVEL (dBuV/m)	LIMIT (dBuV/m)	MARGIN (dB)	ANTENNA HEIGHT (m)	TABLE ANGLE (Degree)	RAW VALUE (dBuV)	CORRECTION FACTOR (dB/m)
1	2390.00	68.1 PK	74.0	-5.9	1.07 V	276	37.20	30.90
2	2390.00	48.8 AV	54.0	-5.2	1.07 V	276	17.90	30.90
3	*2412.00	102.2 PK			1.07 V	276	71.20	31.00
4	*2412.00	92.1 AV			1.07 V	276	61.10	31.00
5	4824.00	45.8 PK	74.0	-28.2	1.02 V	158	8.70	37.10
6	4824.00	32.3 AV	54.0	-21.7	1.02 V	158	-4.80	37.10

REMARKS:

1. Emission level (dBuV/m) = Raw Value (dBuV) + Correction Factor (dB/m).
2. Correction Factor (dB/m) = Antenna Factor (dB/m) + Cable Factor (dB).
3. The other emission levels were very low against the limit.
4. Margin value = Emission level – Limit value.
5. “ \* “: Fundamental frequency.



A D T

EUT TEST CONDITION		MEASUREMENT DETAIL	
CHANNEL	Channel 6	FREQUENCY RANGE	1 ~ 25GHz
INPUT POWER (SYSTEM)	120Vac, 60Hz	DETECTOR FUNCTION	Peak (PK) Average (AV)
ENVIRONMENTAL CONDITIONS	25deg. C, 68%RH	TESTED BY	Antony Lee
TEST MODE	B 1		

ANTENNA POLARITY & TEST DISTANCE: HORIZONTAL AT 3 M								
NO.	FREQ. (MHz)	EMISSION LEVEL (dBuV/m)	LIMIT (dBuV/m)	MARGIN (dB)	ANTENNA HEIGHT (m)	TABLE ANGLE (Degree)	RAW VALUE (dBuV)	CORRECTION FACTOR (dB/m)
1	*2437.00	104.8 PK			1.31 H	310	73.70	31.10
2	*2437.00	93.8 AV			1.31 H	310	62.70	31.10
3	#3249.00	48.4 PK	84.8	-36.4	1.13 H	304	15.30	33.10
4	#3249.00	42.8 AV	73.8	-31.0	1.13 H	304	9.70	33.10
5	4874.00	45.6 PK	74.0	-28.4	1.00 H	331	8.40	37.20
6	4874.00	32.7 AV	54.0	-21.3	1.00 H	331	-4.50	37.20
ANTENNA POLARITY & TEST DISTANCE: VERTICAL AT 3 M								
NO.	FREQ. (MHz)	EMISSION LEVEL (dBuV/m)	LIMIT (dBuV/m)	MARGIN (dB)	ANTENNA HEIGHT (m)	TABLE ANGLE (Degree)	RAW VALUE (dBuV)	CORRECTION FACTOR (dB/m)
1	*2437.00	103.1 PK			1.07 V	300	72.00	31.10
2	*2437.00	92.7 AV			1.07 V	300	61.60	31.10
3	#3249.00	47.6 PK	83.1	-35.5	1.02 V	268	14.50	33.10
4	#3249.00	42.0 AV	72.7	-30.7	1.02 V	268	8.90	33.10
5	4874.00	45.7 PK	74.0	-28.3	1.00 V	123	8.50	37.20
6	4874.00	32.3 AV	54.0	-21.7	1.00 V	123	-4.90	37.20

**REMARKS:**

1. Emission level (dBuV/m) = Raw Value (dBuV) + Correction Factor (dB/m).
2. Correction Factor (dB/m) = Antenna Factor (dB/m) + Cable Factor (dB).
3. The other emission levels were very low against the limit.
4. Margin value = Emission level – Limit value.
5. “ \* “: Fundamental frequency.
6. “#”:The radiated frequency is out the restricted band.





A D T

EUT TEST CONDITION		MEASUREMENT DETAIL	
CHANNEL	Channel 11	FREQUENCY RANGE	1 ~ 25GHz
INPUT POWER (SYSTEM)	120Vac, 60Hz	DETECTOR FUNCTION	Peak (PK) Average (AV)
ENVIRONMENTAL CONDITIONS	25deg. C, 68%RH	TESTED BY	Antony Lee
TEST MODE	B 1		

ANTENNA POLARITY & TEST DISTANCE: HORIZONTAL AT 3 M								
NO.	FREQ. (MHz)	EMISSION LEVEL (dBuV/m)	LIMIT (dBuV/m)	MARGIN (dB)	ANTENNA HEIGHT (m)	TABLE ANGLE (Degree)	RAW VALUE (dBuV)	CORRECTION FACTOR (dB/m)
1	*2462.00	104.8 PK			1.00 H	315	73.60	31.20
2	*2462.00	93.9 AV			1.00 H	315	62.70	31.20
3	2483.50	66.7 PK	74.0	-7.3	1.00 H	315	35.40	31.30
4	2483.50	51.9 AV	54.0	-2.1	1.00 H	315	20.60	31.30
5	4924.00	46.3 PK	74.0	-27.7	1.00 H	324	9.00	37.30
6	4924.00	33.5 AV	54.0	-20.5	1.00 H	324	-3.80	37.30
ANTENNA POLARITY & TEST DISTANCE: VERTICAL AT 3 M								
NO.	FREQ. (MHz)	EMISSION LEVEL (dBuV/m)	LIMIT (dBuV/m)	MARGIN (dB)	ANTENNA HEIGHT (m)	TABLE ANGLE (Degree)	RAW VALUE (dBuV)	CORRECTION FACTOR (dB/m)
1	*2462.00	101.4 PK			1.04 V	297	70.20	31.20
2	*2462.00	91.0 AV			1.04 V	297	59.80	31.20
3	2483.50	65.8 PK	74.0	-8.2	1.04 V	297	34.50	31.30
4	2483.50	48.2 AV	54.0	-5.8	1.04 V	297	16.90	31.30
5	4924.00	46.2 PK	74.0	-27.8	1.01 V	162	8.90	37.30
6	4924.00	33.4 AV	54.0	-20.6	1.01 V	162	-3.90	37.30

**REMARKS:**

1. Emission level (dBuV/m) = Raw Value (dBuV) + Correction Factor (dB/m).
2. Correction Factor (dB/m) = Antenna Factor (dB/m) + Cable Factor (dB).
3. The other emission levels were very low against the limit.
4. Margin value = Emission level – Limit value.
5. “ \* “: Fundamental frequency.



A D T

802.11n (40MHz)

EUT TEST CONDITION		MEASUREMENT DETAIL	
CHANNEL	Channel 3	FREQUENCY RANGE	1 ~ 25GHz
INPUT POWER (SYSTEM)	120Vac, 60Hz	DETECTOR FUNCTION	Peak (PK) Average (AV)
ENVIRONMENTAL CONDITIONS	25deg. C, 68%RH	TESTED BY	Antony Lee
TEST MODE	B 1		

ANTENNA POLARITY & TEST DISTANCE: HORIZONTAL AT 3 M								
NO.	FREQ. (MHz)	EMISSION LEVEL (dBuV/m)	LIMIT (dBuV/m)	MARGIN (dB)	ANTENNA HEIGHT (m)	TABLE ANGLE (Degree)	RAW VALUE (dBuV)	CORRECTION FACTOR (dB/m)
1	2390.00	69.1 PK	74.0	-4.9	1.36 H	57	38.20	30.90
2	2390.00	53.0 AV	54.0	-1.0	1.36 H	57	22.10	30.90
3	*2422.00	97.7 PK			1.36 H	56	66.60	31.10
4	*2422.00	87.7 AV			1.36 H	56	56.60	31.10
5	4844.00	45.1 PK	74.0	-28.9	1.00 H	149	8.00	37.10
6	4844.00	31.9 AV	54.0	-22.1	1.00 H	149	-5.20	37.10
ANTENNA POLARITY & TEST DISTANCE: VERTICAL AT 3 M								
NO.	FREQ. (MHz)	EMISSION LEVEL (dBuV/m)	LIMIT (dBuV/m)	MARGIN (dB)	ANTENNA HEIGHT (m)	TABLE ANGLE (Degree)	RAW VALUE (dBuV)	CORRECTION FACTOR (dB/m)
1	2390.00	69.1 PK	74.0	-4.9	1.07 V	299	38.20	30.90
2	2390.00	51.8 AV	54.0	-2.2	1.07 V	299	20.90	30.90
3	*2422.00	97.8 PK			1.07 V	299	66.70	31.10
4	*2422.00	87.8 AV			1.07 V	299	56.70	31.10
5	4844.00	45.1 PK	74.0	-28.9	1.00 V	159	8.00	37.10
6	4844.00	32.1 AV	54.0	-21.9	1.00 V	159	-5.00	37.10

REMARKS:

1. Emission level (dBuV/m) = Raw Value (dBuV) + Correction Factor (dB/m).
2. Correction Factor (dB/m) = Antenna Factor (dB/m) + Cable Factor (dB).
3. The other emission levels were very low against the limit.
4. Margin value = Emission level – Limit value.
5. “ \* “: Fundamental frequency.



A D T

EUT TEST CONDITION		MEASUREMENT DETAIL	
CHANNEL	Channel 6	FREQUENCY RANGE	1 ~ 25GHz
INPUT POWER (SYSTEM)	120Vac, 60Hz	DETECTOR FUNCTION	Peak (PK) Average (AV)
ENVIRONMENTAL CONDITIONS	25deg. C, 68%RH	TESTED BY	Antony Lee
TEST MODE	B 1		

ANTENNA POLARITY & TEST DISTANCE: HORIZONTAL AT 3 M								
NO.	FREQ. (MHz)	EMISSION LEVEL (dBuV/m)	LIMIT (dBuV/m)	MARGIN (dB)	ANTENNA HEIGHT (m)	TABLE ANGLE (Degree)	RAW VALUE (dBuV)	CORRECTION FACTOR (dB/m)
1	*2437.00	98.4 PK			1.08 H	328	67.30	31.10
2	*2437.00	89.1 AV			1.08 H	328	58.00	31.10
3	#3249.00	48.6 PK	78.4	-29.8	1.00 H	236	15.50	33.10
4	#3249.00	44.7 AV	69.1	-24.4	1.00 H	236	11.60	33.10
5	4874.00	45.6 PK	74.0	-28.4	1.00 H	152	8.40	37.20
6	4874.00	32.4 AV	54.0	-21.6	1.00 H	152	-4.80	37.20
ANTENNA POLARITY & TEST DISTANCE: VERTICAL AT 3 M								
NO.	FREQ. (MHz)	EMISSION LEVEL (dBuV/m)	LIMIT (dBuV/m)	MARGIN (dB)	ANTENNA HEIGHT (m)	TABLE ANGLE (Degree)	RAW VALUE (dBuV)	CORRECTION FACTOR (dB/m)
1	*2437.00	96.9 PK			1.06 V	297	65.80	31.10
2	*2437.00	87.3 AV			1.06 V	297	56.20	31.10
3	#3249.00	50.3 PK	76.9	-26.6	1.00 V	181	17.20	33.10
4	#3249.00	47.2 AV	67.3	-20.1	1.00 V	181	14.10	33.10
5	4874.00	45.3 PK	74.0	-28.7	1.00 V	57	8.10	37.20
6	4874.00	33.6 AV	54.0	-20.4	1.00 V	57	-3.60	37.20

**REMARKS:**

1. Emission level (dBuV/m) = Raw Value (dBuV) + Correction Factor (dB/m).
2. Correction Factor (dB/m) = Antenna Factor (dB/m) + Cable Factor (dB).
3. The other emission levels were very low against the limit.
4. Margin value = Emission level – Limit value.
5. “ \* “: Fundamental frequency.
6. “#”:The radiated frequency is out the restricted band.



A D T

EUT TEST CONDITION		MEASUREMENT DETAIL	
CHANNEL	Channel 9	FREQUENCY RANGE	1 ~ 25GHz
INPUT POWER (SYSTEM)	120Vac, 60Hz	DETECTOR FUNCTION	Peak (PK) Average (AV)
ENVIRONMENTAL CONDITIONS	25deg. C, 68%RH	TESTED BY	Antony Lee
TEST MODE	B 1		

ANTENNA POLARITY & TEST DISTANCE: HORIZONTAL AT 3 M								
NO.	FREQ. (MHz)	EMISSION LEVEL (dBuV/m)	LIMIT (dBuV/m)	MARGIN (dB)	ANTENNA HEIGHT (m)	TABLE ANGLE (Degree)	RAW VALUE (dBuV)	CORRECTION FACTOR (dB/m)
1	*2452.00	97.8 PK			1.02 H	298	66.60	31.20
2	*2452.00	87.4 AV			1.02 H	298	56.20	31.20
3	2483.50	66.0 PK	74.0	-8.0	1.02 H	298	34.70	31.30
4	2483.50	51.9 AV	54.0	-2.1	1.02 H	298	20.60	31.30
5	4904.00	45.6 PK	74.0	-28.4	1.00 H	168	8.40	37.20
6	4904.00	32.7 AV	54.0	-21.3	1.00 H	168	-4.50	37.20
ANTENNA POLARITY & TEST DISTANCE: VERTICAL AT 3 M								
NO.	FREQ. (MHz)	EMISSION LEVEL (dBuV/m)	LIMIT (dBuV/m)	MARGIN (dB)	ANTENNA HEIGHT (m)	TABLE ANGLE (Degree)	RAW VALUE (dBuV)	CORRECTION FACTOR (dB/m)
1	*2452.00	96.0 PK			1.24 V	319	64.80	31.20
2	*2452.00	86.0 AV			1.24 V	319	54.80	31.20
3	2483.50	64.6 PK	74.0	-9.4	1.24 V	318	33.30	31.30
4	2483.50	49.1 AV	54.0	-4.9	1.24 V	318	17.80	31.30
5	4904.00	45.6 PK	74.0	-28.4	1.00 V	162	8.40	37.20
6	4904.00	32.7 AV	54.0	-21.3	1.00 V	162	-4.50	37.20

**REMARKS:**

1. Emission level (dBuV/m) = Raw Value (dBuV) + Correction Factor (dB/m).
2. Correction Factor (dB/m) = Antenna Factor (dB/m) + Cable Factor (dB).
3. The other emission levels were very low against the limit.
4. Margin value = Emission level – Limit value.
5. “ \* “: Fundamental frequency.



A D T

## Monopole Antenna\_2 TX

## 802.11n (20MHz)

EUT TEST CONDITION		MEASUREMENT DETAIL	
CHANNEL	Channel 1	FREQUENCY RANGE	1 ~ 25GHz
INPUT POWER (SYSTEM)	120Vac, 60Hz	DETECTOR FUNCTION	Peak (PK) Average (AV)
ENVIRONMENTAL CONDITIONS	25deg. C, 68%RH	TESTED BY	Antony Lee
TEST MODE	B 2		

ANTENNA POLARITY & TEST DISTANCE: HORIZONTAL AT 3 M								
NO.	FREQ. (MHz)	EMISSION LEVEL (dBuV/m)	LIMIT (dBuV/m)	MARGIN (dB)	ANTENNA HEIGHT (m)	TABLE ANGLE (Degree)	RAW VALUE (dBuV)	CORRECTION FACTOR (dB/m)
1	2390.00	61.1 PK	74.0	-12.9	1.34 H	54	30.20	30.90
2	2390.00	46.9 AV	54.0	-7.1	1.34 H	54	16.00	30.90
3	*2412.00	101.4 PK			1.34 H	54	70.40	31.00
4	*2412.00	90.4 AV			1.34 H	54	59.40	31.00
5	4824.00	45.3 PK	74.0	-28.7	1.00 H	257	8.20	37.10
6	4824.00	33.7 AV	54.0	-20.3	1.00 H	257	-3.40	37.10
ANTENNA POLARITY & TEST DISTANCE: VERTICAL AT 3 M								
NO.	FREQ. (MHz)	EMISSION LEVEL (dBuV/m)	LIMIT (dBuV/m)	MARGIN (dB)	ANTENNA HEIGHT (m)	TABLE ANGLE (Degree)	RAW VALUE (dBuV)	CORRECTION FACTOR (dB/m)
1	2390.00	61.5 PK	74.0	-12.5	1.08 V	271	30.60	30.90
2	2390.00	47.3 AV	54.0	-6.7	1.08 V	271	16.40	30.90
3	*2412.00	101.8 PK			1.08 V	271	70.80	31.00
4	*2412.00	91.2 AV			1.08 V	271	60.20	31.00
5	4824.00	45.7 PK	74.0	-28.3	1.00 V	126	8.60	37.10
6	4824.00	34.2 AV	54.0	-19.8	1.00 V	126	-2.90	37.10

## REMARKS:

1. Emission level (dBuV/m) = Raw Value (dBuV) + Correction Factor (dB/m).
2. Correction Factor (dB/m) = Antenna Factor (dB/m) + Cable Factor (dB).
3. The other emission levels were very low against the limit.
4. Margin value = Emission level – Limit value.
5. “ \* “: Fundamental frequency.



A D T

EUT TEST CONDITION		MEASUREMENT DETAIL	
CHANNEL	Channel 6	FREQUENCY RANGE	1 ~ 25GHz
INPUT POWER (SYSTEM)	120Vac, 60Hz	DETECTOR FUNCTION	Peak (PK) Average (AV)
ENVIRONMENTAL CONDITIONS	25deg. C, 68%RH	TESTED BY	Antony Lee
TEST MODE	B 2		

ANTENNA POLARITY & TEST DISTANCE: HORIZONTAL AT 3 M								
NO.	FREQ. (MHz)	EMISSION LEVEL (dBuV/m)	LIMIT (dBuV/m)	MARGIN (dB)	ANTENNA HEIGHT (m)	TABLE ANGLE (Degree)	RAW VALUE (dBuV)	CORRECTION FACTOR (dB/m)
1	*2437.00	101.0 PK			1.08 H	329	69.90	31.10
2	*2437.00	89.6 AV			1.08 H	329	58.50	31.10
3	#3249.00	48.5 PK	81.0	-32.5	1.03 H	144	15.40	33.10
4	#3249.00	43.9 AV	69.6	-25.7	1.03 H	144	10.80	33.10
5	4874.00	46.9 PK	74.0	-27.1	1.00 H	234	9.70	37.20
6	4874.00	33.0 AV	54.0	-21.0	1.00 H	234	-4.20	37.20

ANTENNA POLARITY & TEST DISTANCE: VERTICAL AT 3 M								
NO.	FREQ. (MHz)	EMISSION LEVEL (dBuV/m)	LIMIT (dBuV/m)	MARGIN (dB)	ANTENNA HEIGHT (m)	TABLE ANGLE (Degree)	RAW VALUE (dBuV)	CORRECTION FACTOR (dB/m)
1	*2437.00	102.2 PK			1.06 V	301	71.10	31.10
2	*2437.00	91.1 AV			1.06 V	301	60.00	31.10
3	#3249.00	48.5 PK	82.2	-33.7	1.00 V	51	15.40	33.10
4	#3249.00	44.7 AV	71.1	-26.4	1.00 V	51	11.60	33.10
5	4874.00	45.4 PK	74.0	-28.6	1.00 V	25	8.20	37.20
6	4874.00	32.7 AV	54.0	-21.3	1.00 V	25	-4.50	37.20

**REMARKS:**

1. Emission level (dBuV/m) = Raw Value (dBuV) + Correction Factor (dB/m).
2. Correction Factor (dB/m) = Antenna Factor (dB/m) + Cable Factor (dB).
3. The other emission levels were very low against the limit.
4. Margin value = Emission level – Limit value.
5. “ \* “: Fundamental frequency.
6. “#”:The radiated frequency is out the restricted band.



A D T

EUT TEST CONDITION		MEASUREMENT DETAIL	
CHANNEL	Channel 11	FREQUENCY RANGE	1 ~ 25GHz
INPUT POWER (SYSTEM)	120Vac, 60Hz	DETECTOR FUNCTION	Peak (PK) Average (AV)
ENVIRONMENTAL CONDITIONS	25deg. C, 68%RH	TESTED BY	Antony Lee
TEST MODE	B 2		

ANTENNA POLARITY & TEST DISTANCE: HORIZONTAL AT 3 M								
NO.	FREQ. (MHz)	EMISSION LEVEL (dBuV/m)	LIMIT (dBuV/m)	MARGIN (dB)	ANTENNA HEIGHT (m)	TABLE ANGLE (Degree)	RAW VALUE (dBuV)	CORRECTION FACTOR (dB/m)
1	*2462.00	101.8 PK			1.28 H	314	70.60	31.20
2	*2462.00	89.6 AV			1.28 H	314	58.40	31.20
3	2483.50	59.0 PK	74.0	-15.0	1.28 H	314	27.70	31.30
4	2483.50	46.6 AV	54.0	-7.4	1.28 H	314	15.30	31.30
5	4924.00	45.6 PK	74.0	-28.4	1.00 H	133	8.30	37.30
6	4924.00	34.8 AV	54.0	-19.2	1.00 H	133	-2.50	37.30

ANTENNA POLARITY & TEST DISTANCE: VERTICAL AT 3 M								
NO.	FREQ. (MHz)	EMISSION LEVEL (dBuV/m)	LIMIT (dBuV/m)	MARGIN (dB)	ANTENNA HEIGHT (m)	TABLE ANGLE (Degree)	RAW VALUE (dBuV)	CORRECTION FACTOR (dB/m)
1	*2462.00	101.2 PK			1.65 V	273	70.00	31.20
2	*2462.00	90.2 AV			1.65 V	273	59.00	31.20
3	2483.50	59.5 PK	74.0	-14.5	1.65 V	273	28.20	31.30
4	2483.50	46.6 AV	54.0	-7.4	1.65 V	273	15.30	31.30
5	4924.00	46.2 PK	74.0	-27.8	1.00 V	263	8.90	37.30
6	4924.00	35.4 AV	54.0	-18.6	1.00 V	263	-1.90	37.30

**REMARKS:**

1. Emission level (dBuV/m) = Raw Value (dBuV) + Correction Factor (dB/m).
2. Correction Factor (dB/m) = Antenna Factor (dB/m) + Cable Factor (dB).
3. The other emission levels were very low against the limit.
4. Margin value = Emission level – Limit value.
5. “ \* “: Fundamental frequency.



A D T

802.11n (40MHz)

EUT TEST CONDITION		MEASUREMENT DETAIL	
CHANNEL	Channel 3	FREQUENCY RANGE	1 ~ 25GHz
INPUT POWER (SYSTEM)	120Vac, 60Hz	DETECTOR FUNCTION	Peak (PK) Average (AV)
ENVIRONMENTAL CONDITIONS	25deg. C, 68%RH	TESTED BY	Antony Lee
TEST MODE	B 2		

ANTENNA POLARITY & TEST DISTANCE: HORIZONTAL AT 3 M								
NO.	FREQ. (MHz)	EMISSION LEVEL (dBuV/m)	LIMIT (dBuV/m)	MARGIN (dB)	ANTENNA HEIGHT (m)	TABLE ANGLE (Degree)	RAW VALUE (dBuV)	CORRECTION FACTOR (dB/m)
1	2390.00	65.6 PK	74.0	-8.4	1.35 H	56	34.70	30.90
2	2390.00	52.7 AV	54.0	-1.3	1.35 H	56	21.80	30.90
3	*2422.00	97.9 PK			1.35 H	56	66.80	31.10
4	*2422.00	86.7 AV			1.35 H	56	55.60	31.10
5	4844.00	45.3 PK	74.0	-28.7	1.00 H	248	8.20	37.10
6	4844.00	32.5 AV	54.0	-21.5	1.00 H	248	-4.60	37.10

ANTENNA POLARITY & TEST DISTANCE: VERTICAL AT 3 M								
NO.	FREQ. (MHz)	EMISSION LEVEL (dBuV/m)	LIMIT (dBuV/m)	MARGIN (dB)	ANTENNA HEIGHT (m)	TABLE ANGLE (Degree)	RAW VALUE (dBuV)	CORRECTION FACTOR (dB/m)
1	2390.00	64.3 PK	74.0	-9.7	1.07 V	274	33.40	30.90
2	2390.00	51.5 AV	54.0	-2.5	1.07 V	274	20.60	30.90
3	*2422.00	97.9 PK			1.07 V	275	66.80	31.10
4	*2422.00	86.9 AV			1.07 V	275	55.80	31.10
5	4844.00	44.3 PK	74.0	-29.7	1.00 V	123	7.20	37.10
6	4844.00	33.1 AV	54.0	-20.9	1.00 V	123	-4.00	37.10

REMARKS:

1. Emission level (dBuV/m) = Raw Value (dBuV) + Correction Factor (dB/m).
2. Correction Factor (dB/m) = Antenna Factor (dB/m) + Cable Factor (dB).
3. The other emission levels were very low against the limit.
4. Margin value = Emission level – Limit value.
5. “ \* “: Fundamental frequency.





A D T

EUT TEST CONDITION		MEASUREMENT DETAIL	
CHANNEL	Channel 6	FREQUENCY RANGE	1 ~ 25GHz
INPUT POWER (SYSTEM)	120Vac, 60Hz	DETECTOR FUNCTION	Peak (PK) Average (AV)
ENVIRONMENTAL CONDITIONS	25deg. C, 68%RH	TESTED BY	Antony Lee
TEST MODE	B 2		

ANTENNA POLARITY & TEST DISTANCE: HORIZONTAL AT 3 M								
NO.	FREQ. (MHz)	EMISSION LEVEL (dBuV/m)	LIMIT (dBuV/m)	MARGIN (dB)	ANTENNA HEIGHT (m)	TABLE ANGLE (Degree)	RAW VALUE (dBuV)	CORRECTION FACTOR (dB/m)
1	*2437.00	98.4 PK			1.07 H	327	67.30	31.10
2	*2437.00	87.4 AV			1.07 H	327	56.30	31.10
3	#3249.00	49.2 PK	78.4	-29.2	1.00 H	51	16.10	33.10
4	#3249.00	45.1 AV	67.4	-22.3	1.00 H	51	12.00	33.10
5	4874.00	46.2 PK	74.0	-27.8	1.00 H	158	9.00	37.20
6	4874.00	35.1 AV	54.0	-18.9	1.00 H	158	-2.10	37.20
ANTENNA POLARITY & TEST DISTANCE: VERTICAL AT 3 M								
NO.	FREQ. (MHz)	EMISSION LEVEL (dBuV/m)	LIMIT (dBuV/m)	MARGIN (dB)	ANTENNA HEIGHT (m)	TABLE ANGLE (Degree)	RAW VALUE (dBuV)	CORRECTION FACTOR (dB/m)
1	*2437.00	97.2 PK			1.36 V	273	66.10	31.10
2	*2437.00	86.5 AV			1.36 V	273	55.40	31.10
3	#3249.00	50.3 PK	77.2	-26.9	1.00 V	181	17.20	33.10
4	#3249.00	47.2 AV	66.5	-19.3	1.00 V	181	14.10	33.10
5	4874.00	45.6 PK	74.0	-28.4	1.00 V	321	8.40	37.20
6	4874.00	33.9 AV	54.0	-20.1	1.00 V	321	-3.30	37.20

**REMARKS:**

1. Emission level (dBuV/m) = Raw Value (dBuV) + Correction Factor (dB/m).
2. Correction Factor (dB/m) = Antenna Factor (dB/m) + Cable Factor (dB).
3. The other emission levels were very low against the limit.
4. Margin value = Emission level – Limit value.
5. “ \* “: Fundamental frequency.
6. “#”:The radiated frequency is out the restricted band.



A D T

EUT TEST CONDITION		MEASUREMENT DETAIL	
CHANNEL	Channel 9	FREQUENCY RANGE	1 ~ 25GHz
INPUT POWER (SYSTEM)	120Vac, 60Hz	DETECTOR FUNCTION	Peak (PK) Average (AV)
ENVIRONMENTAL CONDITIONS	25deg. C, 68%RH	TESTED BY	Antony Lee
TEST MODE	B 2		

ANTENNA POLARITY & TEST DISTANCE: HORIZONTAL AT 3 M								
NO.	FREQ. (MHz)	EMISSION LEVEL (dBuV/m)	LIMIT (dBuV/m)	MARGIN (dB)	ANTENNA HEIGHT (m)	TABLE ANGLE (Degree)	RAW VALUE (dBuV)	CORRECTION FACTOR (dB/m)
1	*2452.00	97.8 PK			1.34 H	312	65.40	32.40
2	*2452.00	87.4 AV			1.34 H	312	55.00	32.40
3	2483.50	62.8 PK	74.0	-11.2	1.34 H	312	30.30	32.50
4	2483.50	48.7 AV	54.0	-5.3	1.34 H	312	16.20	32.50
5	4904.00	45.8 PK	74.0	-28.2	1.00 H	251	8.00	37.80
6	4904.00	32.6 AV	54.0	-21.4	1.00 H	251	-5.20	37.80
ANTENNA POLARITY & TEST DISTANCE: VERTICAL AT 3 M								
NO.	FREQ. (MHz)	EMISSION LEVEL (dBuV/m)	LIMIT (dBuV/m)	MARGIN (dB)	ANTENNA HEIGHT (m)	TABLE ANGLE (Degree)	RAW VALUE (dBuV)	CORRECTION FACTOR (dB/m)
1	*2452.00	98.3 PK			1.05 V	300	65.90	32.40
2	*2452.00	88.1 AV			1.05 V	300	55.70	32.40
3	2483.50	63.3 PK	74.0	-10.7	1.05 V	300	30.80	32.50
4	2483.50	49.9 AV	54.0	-4.1	1.05 V	300	17.40	32.50
5	4904.00	46.2 PK	74.0	-27.8	1.00 V	251	8.40	37.80
6	4904.00	33.4 AV	54.0	-20.6	1.00 V	251	-4.40	37.80

**REMARKS:**

1. Emission level (dBuV/m) = Raw Value (dBuV) + Correction Factor (dB/m).
2. Correction Factor (dB/m) = Antenna Factor (dB/m) + Cable Factor (dB).
3. The other emission levels were very low against the limit.
4. Margin value = Emission level – Limit value.
5. “ \* “: Fundamental frequency.



A D T

**BELOW 1GHz WORST-CASE DATA : 802.11n (20MHz)**

**PIFA Antenna\_2TX**

EUT TEST CONDITION		MEASUREMENT DETAIL	
CHANNEL	Channel 1	FREQUENCY RANGE	Below 1000MHz
INPUT POWER (SYSTEM)	120Vac, 60Hz	DETECTOR FUNCTION	Quasi-Peak
ENVIRONMENTAL CONDITIONS	25deg. C, 67%RH	TESTED BY	Cedric Wu
TEST MODE	A 2		

ANTENNA POLARITY & TEST DISTANCE: HORIZONTAL AT 3 M								
NO.	FREQ. (MHz)	EMISSION LEVEL (dBuV/m)	LIMIT (dBuV/m)	MARGIN (dB)	ANTENNA HEIGHT (m)	TABLE ANGLE (Degree)	RAW VALUE (dBuV)	CORRECTION FACTOR (dB/m)
1	187.07	38.2 QP	43.5	-5.3	1.74 H	273	26.30	11.90
2	198.71	38.7 QP	43.5	-4.8	1.74 H	92	27.80	10.90
3	359.77	32.0 QP	46.0	-14.0	1.00 H	335	15.80	16.20
4	749.79	36.3 QP	46.0	-9.7	1.00 H	50	12.90	23.40
5	798.30	39.4 QP	46.0	-6.6	1.00 H	34	14.80	24.60
6	947.71	37.1 QP	46.0	-8.9	1.50 H	265	10.90	26.20

ANTENNA POLARITY & TEST DISTANCE: VERTICAL AT 3 M								
NO.	FREQ. (MHz)	EMISSION LEVEL (dBuV/m)	LIMIT (dBuV/m)	MARGIN (dB)	ANTENNA HEIGHT (m)	TABLE ANGLE (Degree)	RAW VALUE (dBuV)	CORRECTION FACTOR (dB/m)
1	119.16	28.5 QP	43.5	-15.0	1.00 V	199	16.80	11.70
2	185.13	30.5 QP	43.5	-13.0	1.24 V	24	18.40	12.10
3	472.31	31.3 QP	46.0	-14.7	1.00 V	190	12.50	18.80
4	800.24	38.2 QP	46.0	-7.8	1.49 V	130	13.60	24.60
5	852.63	37.1 QP	46.0	-8.9	1.24 V	123	11.90	25.20
6	949.65	40.3 QP	46.0	-5.7	1.75 V	293	14.10	26.20

**REMARKS:**

1. Emission level (dBuV/m) = Raw Value (dBuV) + Correction Factor (dB/m).
2. Correction Factor (dB/m) = Antenna Factor (dB/m) + Cable Factor (dB).
3. The other emission levels were very low against the limit.
4. Margin value = Emission level – Limit value.



A D T

Monopole Antenna\_2 TX

EUT TEST CONDITION		MEASUREMENT DETAIL	
CHANNEL	Channel 1	FREQUENCY RANGE	Below 1000MHz
INPUT POWER (SYSTEM)	120Vac, 60Hz	DETECTOR FUNCTION	Quasi-Peak
ENVIRONMENTAL CONDITIONS	24deg. C, 64%RH	TESTED BY	Match Tsui
TEST MODE	B 2		

ANTENNA POLARITY & TEST DISTANCE: HORIZONTAL AT 3 M								
NO.	FREQ. (MHz)	EMISSION LEVEL (dBuV/m)	LIMIT (dBuV/m)	MARGIN (dB)	ANTENNA HEIGHT (m)	TABLE ANGLE (Degree)	RAW VALUE (dBuV)	CORRECTION FACTOR (dB/m)
1	74.62	33.1 QP	40.0	-6.9	2.00 H	325	21.90	11.20
2	119.24	29.6 QP	43.5	-13.9	1.50 H	16	18.00	11.60
3	260.86	36.8 QP	46.0	-9.2	1.00 H	301	23.40	13.40
4	297.72	35.1 QP	46.0	-10.9	1.00 H	308	20.30	14.80
5	336.52	35.1 QP	46.0	-10.9	1.00 H	200	19.20	15.90
6	524.70	36.8 QP	46.0	-9.2	1.50 H	127	16.10	20.70
ANTENNA POLARITY & TEST DISTANCE: VERTICAL AT 3 M								
NO.	FREQ. (MHz)	EMISSION LEVEL (dBuV/m)	LIMIT (dBuV/m)	MARGIN (dB)	ANTENNA HEIGHT (m)	TABLE ANGLE (Degree)	RAW VALUE (dBuV)	CORRECTION FACTOR (dB/m)
1	74.62	35.1 QP	40.0	-4.9	1.00 V	124	23.90	11.20
2	262.80	36.6 QP	46.0	-9.4	2.00 V	184	23.10	13.50
3	299.66	37.6 QP	46.0	-8.4	1.50 V	157	22.70	14.90
4	336.52	36.6 QP	46.0	-9.4	1.00 V	16	20.70	15.90
5	524.70	38.2 QP	46.0	-7.8	1.00 V	16	17.50	20.70
6	784.66	31.8 QP	46.0	-14.2	2.00 V	211	6.90	24.90

REMARKS:

1. Emission level (dBuV/m) = Raw Value (dBuV) + Correction Factor (dB/m).
2. Correction Factor (dB/m) = Antenna Factor (dB/m) + Cable Factor (dB).
3. The other emission levels were very low against the limit.
4. Margin value = Emission level – Limit value.



A D T

## 4.2 CONDUCTED EMISSION MEASUREMENT

### 4.2.1 LIMITS OF CONDUCTED EMISSION MEASUREMENT

FREQUENCY OF EMISSION (MHz)	CONDUCTED LIMIT (dB $\mu$ V)	
	Quasi-peak	Average
0.15 ~ 0.5	66 to 56	56 to 46
0.5 ~ 5	56	46
5 ~ 30	60	50

- NOTE:** 1. The lower limit shall apply at the transition frequencies.
2. The limit decreases in line with the logarithm of the frequency in the range of 0.15 to 0.50MHz.
3. All emanations from a class A/B digital device or system, including any network of conductors and apparatus connected thereto, shall not exceed the level of field strengths specified above.

### 4.2.2 TEST INSTRUMENTS

Test date: Oct. 26, 2012

DESCRIPTION & MANUFACTURER	MODEL NO.	SERIAL NO.	DATE OF CALIBRATION	DUE DATE OF CALIBRATION
Test Receiver ROHDE & SCHWARZ	ESCS30	100291	Nov. 23, 2011	Nov. 22, 2012
RF signal cable Woken	5D-FB	Cable-HYC01-01	Dec. 29, 2011	Dec. 28, 2012
LISN ROHDE & SCHWARZ (Peripheral)	ESH3-Z5	100312	Jul. 02, 2012	Jul. 01, 2013
LISN ROHDE & SCHWARZ (EUT)	ESH3-Z5	835239/001	Feb. 07, 2012	Feb. 06, 2013
Software ADT	BV ADT_Cond_ V7.3.7.3	NA	NA	NA

- NOTE:** 1. The calibration interval of the above test instruments is 12 months and the calibrations are traceable to NML/ROC and NIST/USA.
2. The test was performed in HwaYa Shielded Room 1.
3. The VCCI Site Registration No. is C-2040.



A D T

Test date: Dec. 11, 2012

DESCRIPTION & MANUFACTURER	MODEL NO.	SERIAL NO.	DATE OF CALIBRATION	DUE DATE OF CALIBRATION
Test Receiver ROHDE & SCHWARZ	ESCS30	100288	Nov. 09, 2012	Nov. 08, 2013
RF signal cable Woken	5D-FB	Cable-HYCO2-01	Dec. 29, 2011	Dec. 28, 2012
LISN ROHDE & SCHWARZ (EUT)	ESH2-Z5	100100	Dec. 30, 2011	Dec. 29, 2012
LISN ROHDE & SCHWARZ (Peripheral)	ESH3-Z5	100311	Jul. 06, 2012	Jul. 05, 2013
Software ADT	BV ADT_Cond_ V7.3.7.3	NA	NA	NA

- NOTE:** 1. The calibration interval of the above test instruments is 12 months and the calibrations are traceable to NML/ROC and NIST/USA.
2. The test was performed in HwaYa Shielded Room 2.
3. The VCCI Site Registration No. is C-2047.

#### 4.2.3 TEST PROCEDURES

- a. The EUT was placed 0.4 meters from the conducting wall of the shielded room with EUT being connected to the power mains through a line impedance stabilization network (LISN). Other support units were connected to the power mains through another LISN. The two LISNs provide 50 ohm/ 50uH of coupling impedance for the measuring instrument.
- b. Both lines of the power mains connected to the EUT were checked for maximum conducted interference.
- c. The frequency range from 150kHz to 30MHz was searched. Emission levels under (Limit - 20dB) was not recorded.

**NOTE:** All modes of operation were investigated and the worst-case emissions are reported.

#### 4.2.4 DEVIATION FROM TEST STANDARD

No deviation.

#### 4.2.5 TEST SETUP

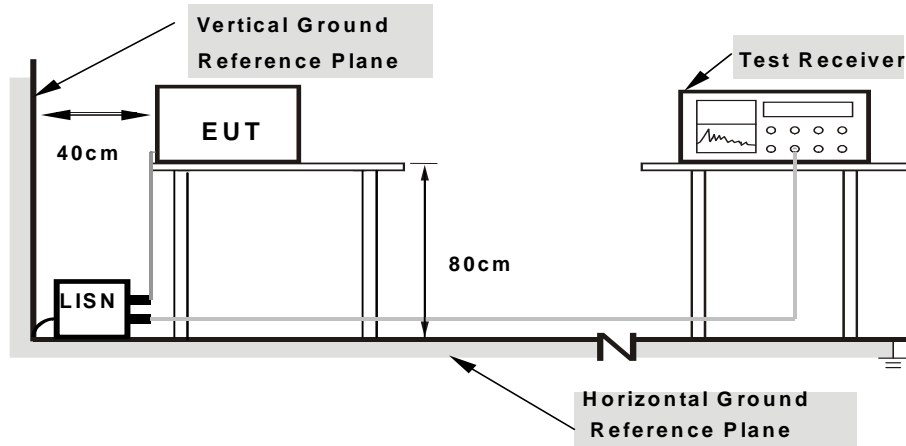

- Note:**
1. Support units were connected to second LISN.
  2. Both of LISNs (AMN) are 80 cm from EUT and at least 80 from other units and other metal planes

For the actual test configuration, please refer to the attached file (Test Setup Photo).

#### 4.2.6 EUT OPERATING CONDITIONS

Same as 4.1.6.

### 4.2.7 TEST RESULTS

CONDUCTED WORST-CASE DATA : 802.11n (20MHz)

PIFA Antenna\_2TX

PHASE	Line 1	6dB BANDWIDTH	9kHz
TEST MODE	A 2		

No	Freq. [MHz]	Corr.	Reading Value		Emission Level		Limit		Margin	
		Factor	[dB (uV)]		[dB (uV)]		[dB (uV)]		(dB)	
		(dB)	Q.P.	AV.	Q.P.	AV.	Q.P.	AV.	Q.P.	AV.
1	0.17744	0.12	37.04	29.33	37.16	29.45	64.60	54.60	-27.44	-25.15
2	0.27480	0.13	41.48	34.57	41.61	34.70	60.97	50.97	-19.36	-16.27
3	0.32595	0.13	45.77	40.97	45.90	41.10	59.55	49.55	-13.65	-8.45
4	0.85380	0.18	29.16	18.93	29.34	19.11	56.00	46.00	-26.66	-26.89
5	2.81271	0.27	15.68	10.77	15.95	11.04	56.00	46.00	-40.05	-34.96
6	22.81627	1.30	18.65	10.17	19.95	11.47	60.00	50.00	-40.05	-38.53

**REMARKS:**

1. Q.P. and AV. are abbreviations of quasi-peak and average individually.
2. The emission levels of other frequencies were very low against the limit.
3. Margin value = Emission level - Limit value
4. Correction factor = Insertion loss + Cable loss
5. Emission Level = Correction Factor + Reading Value.

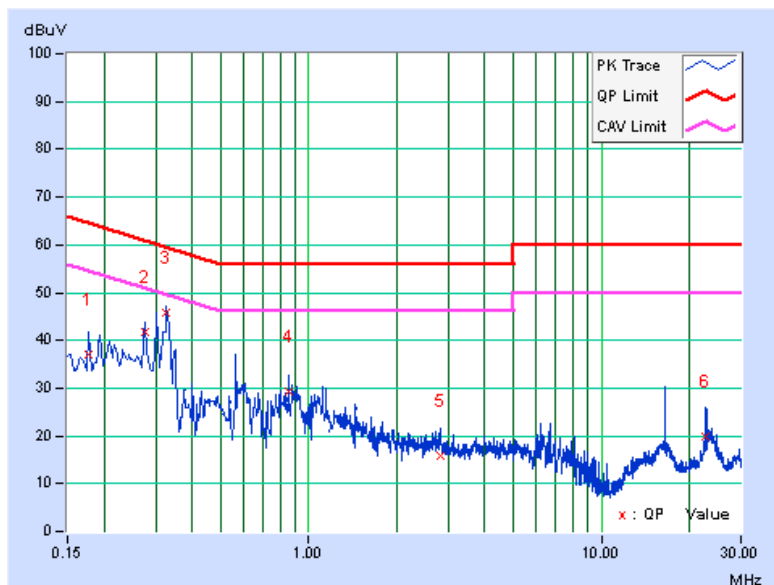





A D T

PHASE	Line 2	6dB BANDWIDTH	9kHz
TEST MODE	A 2		

No	Freq. [MHz]	Corr. Factor (dB)	Reading Value		Emission Level		Limit		Margin	
			[dB (uV)]		[dB (uV)]		[dB (uV)]		(dB)	
			Q.P.	AV.	Q.P.	AV.	Q.P.	AV.	Q.P.	AV.
1	0.19255	0.14	38.71	31.48	38.85	31.62	63.93	53.93	-25.08	-22.31
2	0.32528	0.15	45.43	40.58	45.58	40.73	59.57	49.57	-13.99	-8.84
3	0.57166	0.17	31.56	18.01	31.73	18.18	56.00	46.00	-24.27	-27.82
4	0.85775	0.20	27.96	17.66	28.16	17.86	56.00	46.00	-27.84	-28.14
5	6.08929	0.43	14.09	7.78	14.52	8.21	60.00	50.00	-45.48	-41.79
6	17.94350	0.89	8.93	4.26	9.82	5.15	60.00	50.00	-50.18	-44.85

**REMARKS:**

1. Q.P. and AV. are abbreviations of quasi-peak and average individually.
2. The emission levels of other frequencies were very low against the limit.
3. Margin value = Emission level - Limit value
4. Correction factor = Insertion loss + Cable loss
5. Emission Level = Correction Factor + Reading Value.

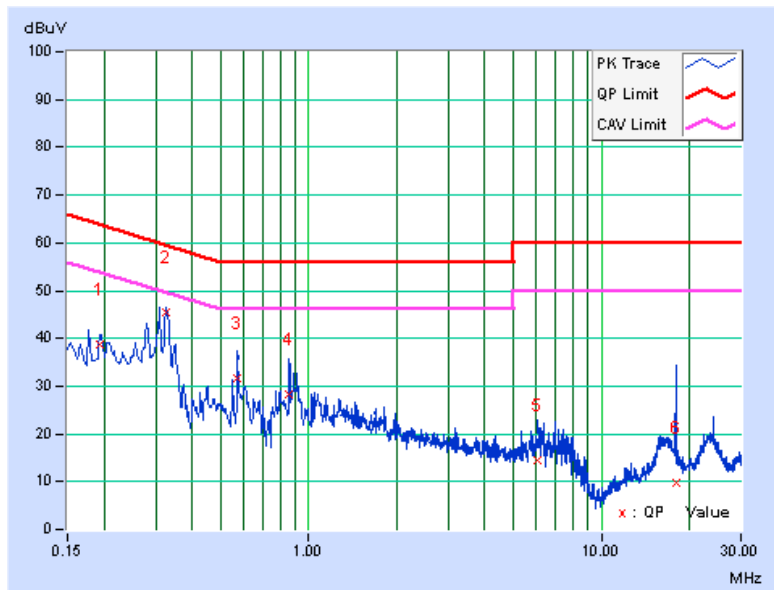

### Monopole Antenna\_2TX

<b>PHASE</b>	Line 1	<b>6dB BANDWIDTH</b>	9kHz
<b>TEST MODE</b>	B 2		

No	Freq. [MHz]	Corr. Factor (dB)	Reading Value		Emission Level		Limit		Margin	
			[dB (uV)]		[dB (uV)]		[dB (uV)]		(dB)	
			Q.P.	AV.	Q.P.	AV.	Q.P.	AV.	Q.P.	AV.
1	0.20859	0.15	46.34	31.88	46.49	32.03	63.26	53.26	-16.77	-21.23
2	0.30535	0.16	25.89	12.02	26.05	12.18	60.10	50.10	-34.05	-37.92
3	0.41172	0.17	24.95	13.68	25.12	13.85	57.61	47.61	-32.49	-33.76
4	1.80078	0.25	33.57	19.85	33.82	20.10	56.00	46.00	-22.18	-25.90
5	3.73828	0.33	27.23	14.25	27.56	14.58	56.00	46.00	-28.44	-31.42
6	10.33984	0.44	33.03	27.44	33.47	27.88	60.00	50.00	-26.53	-22.12

#### REMARKS:

1. Q.P. and AV. are abbreviations of quasi-peak and average individually.
2. The emission levels of other frequencies were very low against the limit.
3. Margin value = Emission level - Limit value
4. Correction factor = Insertion loss + Cable loss
5. Emission Level = Correction Factor + Reading Value.

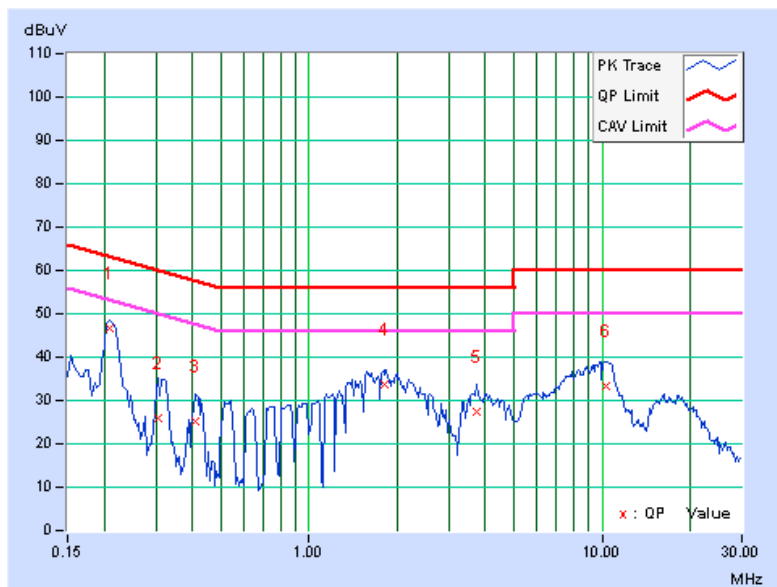



A D T

PHASE	Line 2	6dB BANDWIDTH	9kHz
TEST MODE	B 2		

No	Freq. [MHz]	Corr. Factor (dB)	Reading Value		Emission Level		Limit		Margin	
			[dB (uV)]		[dB (uV)]		[dB (uV)]		(dB)	
			Q.P.	AV.	Q.P.	AV.	Q.P.	AV.	Q.P.	AV.
1	0.20978	0.14	45.98	32.08	46.12	32.22	63.21	53.21	-17.09	-20.99
2	0.31797	0.15	31.73	22.68	31.88	22.83	59.76	49.76	-27.88	-26.93
3	0.41651	0.16	27.49	14.87	27.65	15.03	57.52	47.52	-29.87	-32.49
4	1.83984	0.25	34.37	19.57	34.62	19.82	56.00	46.00	-21.38	-26.18
5	3.73828	0.34	28.73	16.99	29.07	17.33	56.00	46.00	-26.93	-28.67
6	10.24219	0.49	33.23	27.54	33.72	28.03	60.00	50.00	-26.28	-21.97

**REMARKS:**

1. Q.P. and AV. are abbreviations of quasi-peak and average individually.
2. The emission levels of other frequencies were very low against the limit.
3. Margin value = Emission level - Limit value
4. Correction factor = Insertion loss + Cable loss
5. Emission Level = Correction Factor + Reading Value.

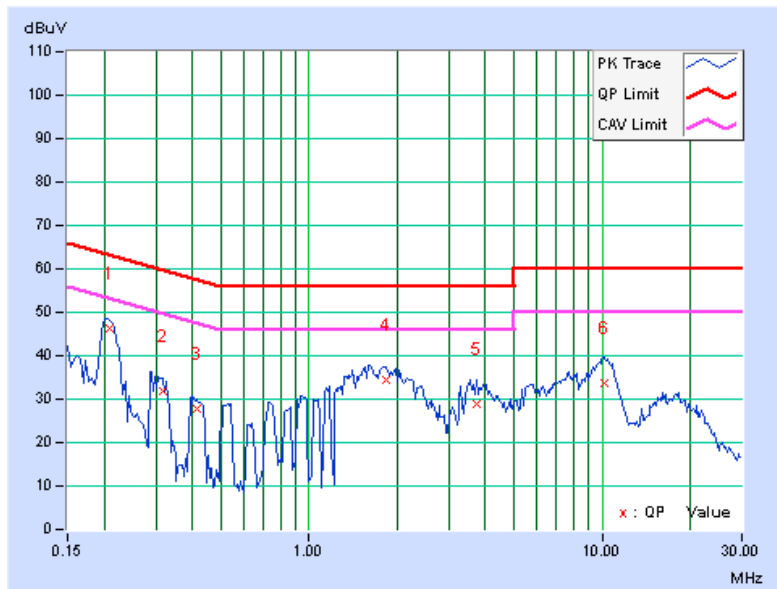



### 4.3 6dB BANDWIDTH MEASUREMENT

#### 4.3.1 LIMITS OF 6dB BANDWIDTH MEASUREMENT

The minimum of 6dB Bandwidth Measurement is 0.5 MHz.

#### 4.3.2 TEST SETUP

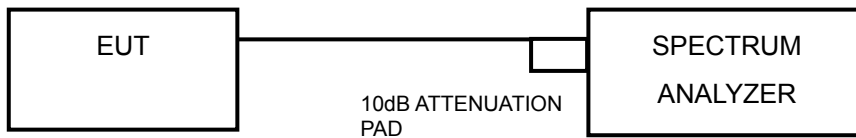

#### 4.3.3 TEST INSTRUMENTS

**Test Date: Jan. 05, 2013**

DESCRIPTION & MANUFACTURER	MODEL NO.	SERIAL NO.	DATE OF CALIBRATION	DUE DATE OF CALIBRATION
SPECTRUM ANALYZER R&S	FSP40	100040	Jul. 16, 2012	Jul. 15, 2013

**NOTE:** The calibration interval of the above test instruments is 12 months and the calibrations are traceable to NML/ROC and NIST/USA.

#### 4.3.4 TEST PROCEDURE

- a. Set resolution bandwidth (RBW) = approximately 1% of the emission bandwidth
- b. Set the video bandwidth (VBW)  $\geq 3 \times$  RBW, Detector = Peak.
- c. Trace mode = max hold.
- d. Sweep = auto couple.
- e. Measure the maximum width of the emission that is constrained by the frequencies associated with the two amplitude points (upper and lower) that are attenuated by 6 dB relative to the maximum level measured in the fundamental emission.



A D T

#### 4.3.5 DEVIATION FROM TEST STANDARD

No deviation.

#### 4.3.6 EUT OPERATING CONDITIONS

The software provided by client to enable the EUT under transmission condition continuously at lowest, middle and highest channel frequencies individually.



### 4.3.7 TEST RESULTS

#### 802.11b

CHANNEL	FREQUENCY (MHz)	6dB BANDWIDTH (MHz)	MINIMUM LIMIT (MHz)	PASS / FAIL
1	2412	10.23	0.5	PASS
6	2437	10.22	0.5	PASS
11	2462	10.23	0.5	PASS

#### 802.11g

CHANNEL	FREQUENCY (MHz)	6dB BANDWIDTH (MHz)	MINIMUM LIMIT (MHz)	PASS / FAIL
1	2412	16.16	0.5	PASS
6	2437	15.94	0.5	PASS
11	2462	16.04	0.5	PASS



A D T

802.11n (20MHz)

1TX

CHANNEL	FREQUENCY (MHz)	6dB BANDWIDTH (MHz)	MINIMUM LIMIT (MHz)	PASS / FAIL
1	2412	15.89	0.5	PASS
6	2437	15.86	0.5	PASS
11	2462	16.93	0.5	PASS

2TX

CHANNEL	FREQUENCY (MHz)	6dB BANDWIDTH (MHz)		MINIMUM LIMIT (MHz)	PASS / FAIL
		CHAIN 0	CHAIN 1		
1	2412	16.60	16.35	0.5	PASS
6	2437	16.39	16.67	0.5	PASS
11	2462	16.40	16.65	0.5	PASS



A D T

### 802.11n (40MHz)

#### 1TX

CHANNEL	FREQUENCY (MHz)	6dB BANDWIDTH (MHz)	MINIMUM LIMIT (MHz)	PASS / FAIL
3	2422	35.34	0.5	PASS
6	2437	35.34	0.5	PASS
9	2452	35.33	0.5	PASS

#### 2TX

CHANNEL	FREQUENCY (MHz)	6dB BANDWIDTH (MHz)		MINIMUM LIMIT (MHz)	PASS / FAIL
		CHAIN 0	CHAIN 1		
3	2422	35.34	36.08	0.5	PASS
6	2437	35.35	36.50	0.5	PASS
9	2452	35.37	36.47	0.5	PASS





### 4.4 CONDUCTED OUTPUT POWER

#### 4.4.1 LIMITS OF CONDUCTED OUTPUT POWER MEASUREMENT

For systems using digital modulation in the 2400–2483.5 MHz bands: 1 Watt (30dBm)  
Per KDB 662911 D01 Multiple Transmitter Output v01r02 Method of conducted output power measurement on IEEE 802.11 devices,

Array Gain = 0 dB (i.e., no array gain) for  $N_{ANT} \leq 4$ ;

Array Gain = 0 dB (i.e., no array gain) for channel widths  $\geq 40$  MHz for any  $N_{ANT}$ ;

Array Gain =  $5 \log(N_{ANT}/N_{SS})$  dB or 3 dB, whichever is less for 20-MHz channel widths with  $N_{ANT} \geq 5$ .

For power measurements on all other devices: Array Gain =  $10 \log(N_{ANT} / N_{SS})$  dB.

#### 4.4.2 TEST SETUP

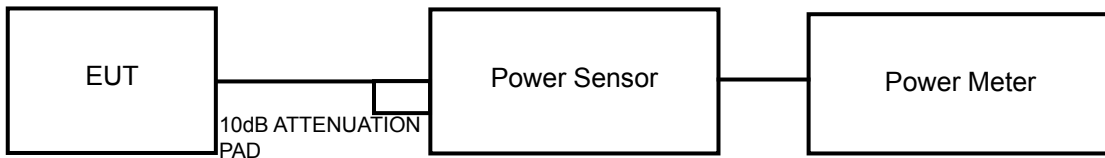

#### 4.4.3 TEST INSTRUMENTS

**Test Date: Jan. 05, 2013**

DESCRIPTION & MANUFACTURER	MODEL NO.	SERIAL NO.	DATE OF CALIBRATION	DUE DATE OF CALIBRATION
High Speed Peak Power Meter	ML2495A	0842014	Apr. 28, 2012	Apr. 27, 2013
Power Sensor	MA2411B	0738404	Apr. 28, 2012	Apr. 27, 2013

- NOTE:**
1. The calibration interval of the above test instruments is 12 months and the calibrations are traceable to NML/ROC and NIST/USA.
  2. Measurement Bandwidth of ML2495A is 65MHz greater than 26dB bandwidth of emission.



A D T

#### 4.4.4 TEST PROCEDURES

A peak power sensor was used on the output port of the EUT. A power meter was used to read the response of the peak power sensor. Record the peak power level.

#### 4.4.5 DEVIATION FROM TEST STANDARD

No deviation.

#### 4.4.6 EUT OPERATING CONDITIONS

Same as Item 4.3.6.



A D T

#### 4.4.7 TEST RESULTS

##### 802.11b

CHANNEL	FREQUENCY (MHz)	PEAK POWER (mW)	PEAK POWER (dBm)	LIMIT (dBm)	PASS/FAIL
1	2412	81.658	19.12	30	PASS
6	2437	83.753	19.23	30	PASS
11	2462	83.176	19.20	30	PASS

##### 802.11g

CHANNEL	FREQUENCY (MHz)	PEAK POWER (mW)	PEAK POWER (dBm)	LIMIT (dBm)	PASS/FAIL
1	2412	<b>293.765</b>	24.68	30	PASS
6	2437	281.838	24.50	30	PASS
11	2462	264.241	24.22	30	PASS



A D T

### 802.11n (20MHz)

#### 1TX

CHANNEL	FREQUENCY (MHz)	PEAK POWER (mW)	PEAK POWER (dBm)	LIMIT (dBm)	PASS/FAIL
1	2412	<b>293.765</b>	24.68	30	PASS
6	2437	281.838	24.50	30	PASS
11	2462	264.241	24.22	30	PASS

#### 2TX

CHAN.	FREQUENCY (MHz)	PEAK POWER (dBm)		TOTAL POWER (mW)	TOTAL POWER (dBm)	LIMIT (dBm)	PASS / FAIL
		CHAIN 0	CHAIN 1				
1	2412	20.56	20.47	225.192	23.53	30	PASS
6	2437	20.54	20.56	227.003	23.56	30	PASS
11	2462	20.68	20.54	230.190	23.62	30	PASS

### 802.11n (40MHz)

#### 1TX

CHANNEL	FREQUENCY (MHz)	PEAK POWER (mW)	PEAK POWER (dBm)	LIMIT (dBm)	PASS/FAIL
3	2422	141.906	21.52	30	PASS
6	2437	139.959	21.46	30	PASS
9	2452	147.231	21.68	30	PASS

#### 2TX

CHAN.	FREQUENCY (MHz)	PEAK POWER (dBm)		TOTAL POWER (mW)	TOTAL POWER (dBm)	LIMIT (dBm)	PASS / FAIL
		CHAIN 0	CHAIN 1				
3	2422	20.51	20.18	216.692	23.36	30	PASS
6	2437	20.57	20.55	227.526	23.57	30	PASS
9	2452	20.62	20.61	230.425	23.63	30	PASS



## 4.5 POWER SPECTRAL DENSITY MEASUREMENT

### 4.5.1 LIMITS OF POWER SPECTRAL DENSITY MEASUREMENT

The Maximum of Power Spectral Density Measurement is 8dBm.

### 4.5.2 TEST SETUP

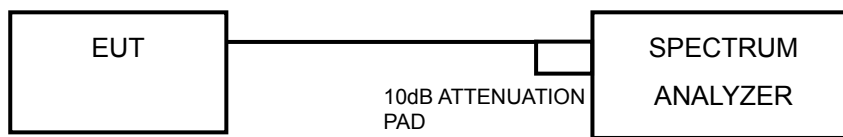

### 4.5.3 TEST INSTRUMENTS

**Test Date: Jan. 05, 2013**

DESCRIPTION & MANUFACTURER	MODEL NO.	SERIAL NO.	DATE OF CALIBRATION	DUE DATE OF CALIBRATION
SPECTRUM ANALYZER R&S	FSP40	100040	Jul. 16, 2012	Jul. 15, 2013

**NOTE:** The calibration interval of the above test instruments is 12 months and the calibrations are traceable to NML/ROC and NIST/USA.

### 4.5.4 TEST PROCEDURE

- Set the RBW = 3 kHz, VBW = 10 kHz, Detector = peak.
- Sweep time = auto couple, Trace mode = max hold, allow trace to fully stabilize.
- Use the peak marker function to determine the maximum power level in any 100 kHz band segment within the fundamental EBW.

### 4.5.5 DEVIATION FROM TEST STANDARD

No deviation.

### 4.5.6 EUT OPERATING CONDITION

Same as Item 4.3.6



A D T

## 4.5.7 TEST RESULTS

### 802.11b

Channel	FREQ. (MHz)	PSD (dBm/3kHz)	Limit (dBm/3kHz)	PASS /FAIL
1	2412	-9.46	8	PASS
6	2437	-10.02	8	PASS
11	2462	-10.22	8	PASS

### 802.11g

Channel	FREQ. (MHz)	PSD (dBm/3kHz)	Limit (dBm/3kHz)	PASS /FAIL
1	2412	-9.98	8	PASS
6	2437	-10.03	8	PASS
11	2462	-10.45	8	PASS



A D T

### 802.11n (20MHz)

#### 1TX

Channel	FREQ. (MHz)	PSD (dBm/3kHz)	Limit (dBm/3kHz)	PASS /FAIL
1	2412	-10.09	8	PASS
6	2437	-9.69	8	PASS
11	2462	-10.11	8	PASS

#### 2TX

Tx chain	Channel	FREQ. (MHz)	PSD (dBm/3kHz)	10 log (N=2) dB	Total PSD (dBm/3kHz)	Limit (dBm/3kHz)	PASS /FAIL
0	1	2412	-9.57	3.01	-6.56	8	PASS
	6	2437	-11.18	3.01	-8.17	8	PASS
	11	2462	-8.67	3.01	-5.66	8	PASS
1	1	2412	-8.49	3.01	-5.48	8	PASS
	6	2437	-9.07	3.01	-6.06	8	PASS
	11	2462	-8.17	3.01	-5.16	8	PASS

### 802.11n (40MHz)

#### 1TX

Channel	FREQ. (MHz)	PSD (dBm/3kHz)	Limit (dBm/3kHz)	PASS /FAIL
3	2422	-11.01	8	PASS
6	2437	-9.93	8	PASS
9	2452	-9.68	8	PASS

#### 2TX

Tx chain	Channel	FREQ. (MHz)	PSD (dBm/3kHz)	10 log (N=2) dB	Total PSD (dBm/3kHz)	Limit (dBm/3kHz)	PASS /FAIL
0	3	2422	-8.61	3.01	-5.60	8	PASS
	6	2437	-10.15	3.01	-7.14	8	PASS
	9	2452	-7.63	3.01	-4.62	8	PASS
1	3	2422	-4.95	3.01	-1.94	8	PASS
	6	2437	-7.89	3.01	-4.88	8	PASS
	9	2452	-7.91	3.01	-4.90	8	PASS



A D T

## 4.6 CONDUCTED OUT OF BAND EMISSION MEASUREMENT

### 4.6.1 LIMITS OF CONDUCTED OUT OF BAND EMISSION MEASUREMENT

Below  $-20\text{dB}$  of the highest emission level of operating band (in 100kHz Resolution Bandwidth).

### 4.6.2 TEST SETUP

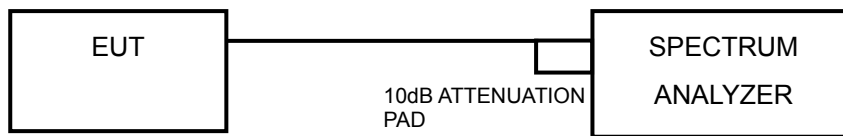

### 4.6.3 TEST INSTRUMENTS

**Test Date: Jan. 05, 2013**

DESCRIPTION & MANUFACTURER	MODEL NO.	SERIAL NO.	DATE OF CALIBRATION	DUE DATE OF CALIBRATION
SPECTRUM ANALYZER R&S	FSP40	100040	Jul. 16, 2012	Jul. 15, 2013

**NOTE:** The calibration interval of the above test instruments is 12 months and the calibrations are traceable to NML/ROC and NIST/USA.

### 4.6.4 TEST PROCEDURE

#### MEASUREMENT PROCEDURE REF

1. Set the RBW = 100 kHz.
2. Set the VBW  $\geq$  300 kHz.
3. Detector = peak.
4. Sweep time = auto couple.
5. Trace mode = max hold.
6. Allow trace to fully stabilize.
7. Use the peak marker function to determine the maximum power level in any 100 kHz band segment within the fundamental EBW.





A D T

## MEASUREMENT PROCEDURE OOB

1. Set RBW = 100 kHz.
2. Set VBW  $\geq$  300 kHz.
3. Set span to encompass the spectrum to be examined.
4. Detector = peak.
5. Trace Mode = max hold.
6. Sweep = auto couple.

### 4.6.5 DEVIATION FROM TEST STANDARD

No deviation.

### 4.6.6 EUT OPERATING CONDITION

Same as Item 4.3.6

### 4.6.7 TEST RESULTS

#### For 1TX

The spectrum plots are attached on the following pages. D1 line indicates the highest level, and D2 line indicates the 20dB offset below D1. It shows compliance with the requirement.

#### For 2TX

The conducted emission test is performed on each TX port of operating mode without summing or adding  $10\log(N)$  since the limit is relative emission limit. Only worst data of each operating mode is presented.

## 4.6.8 TEST RESULTS

### 802.11b

#### CH 1

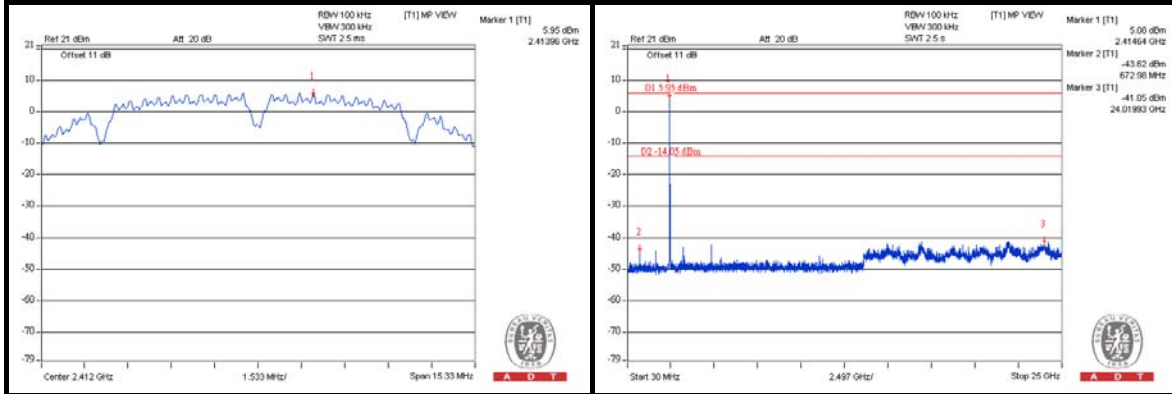

#### CH 6

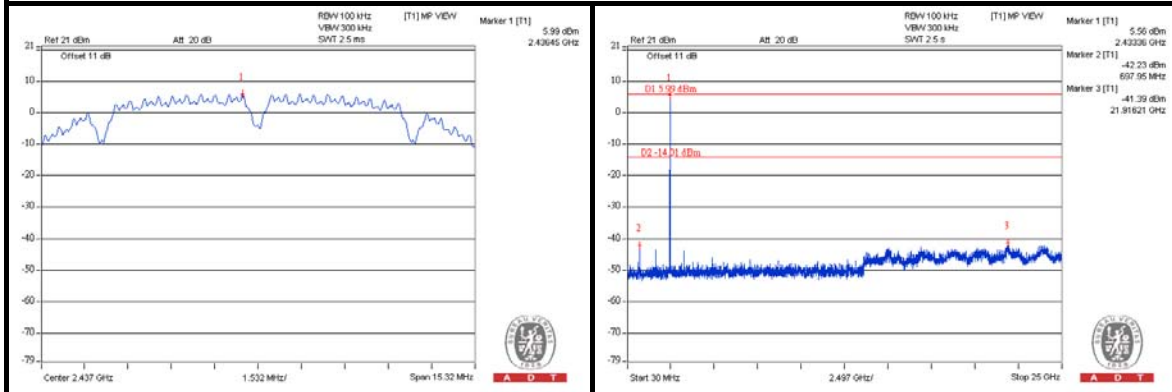

#### CH 11

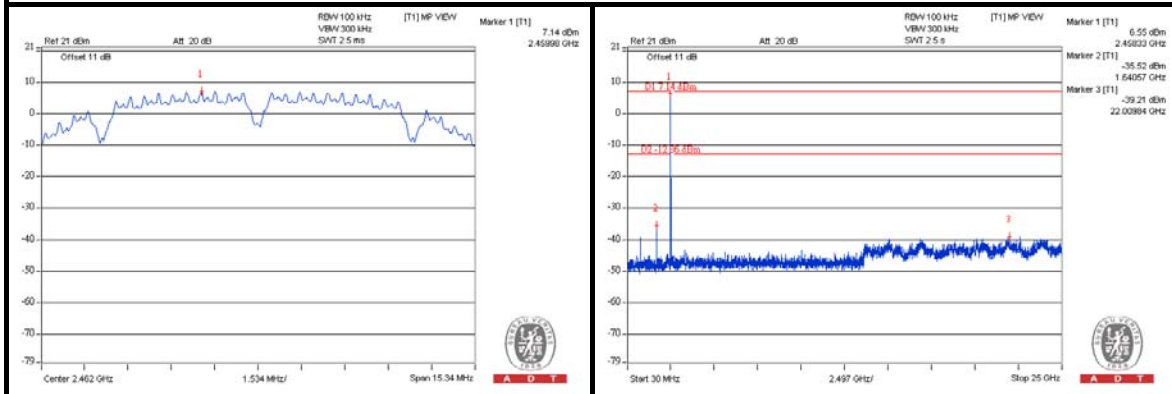



A D T

### 802.11g

#### CH 1

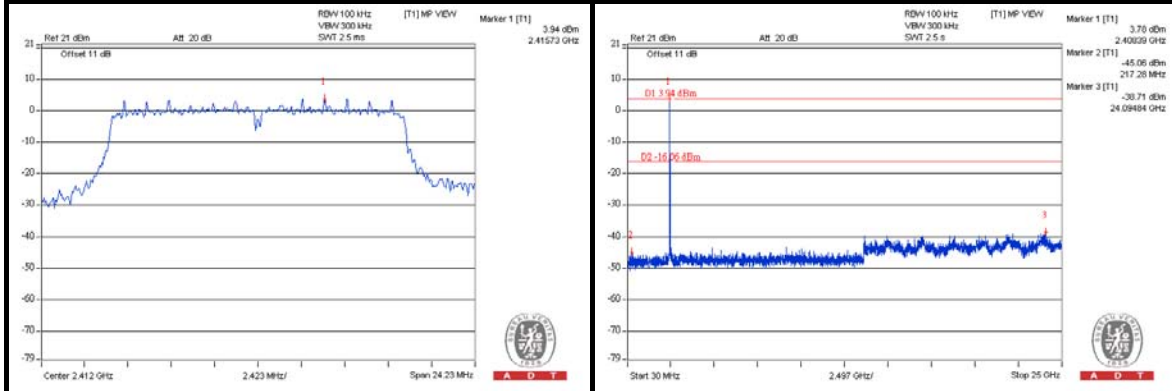

#### CH 6

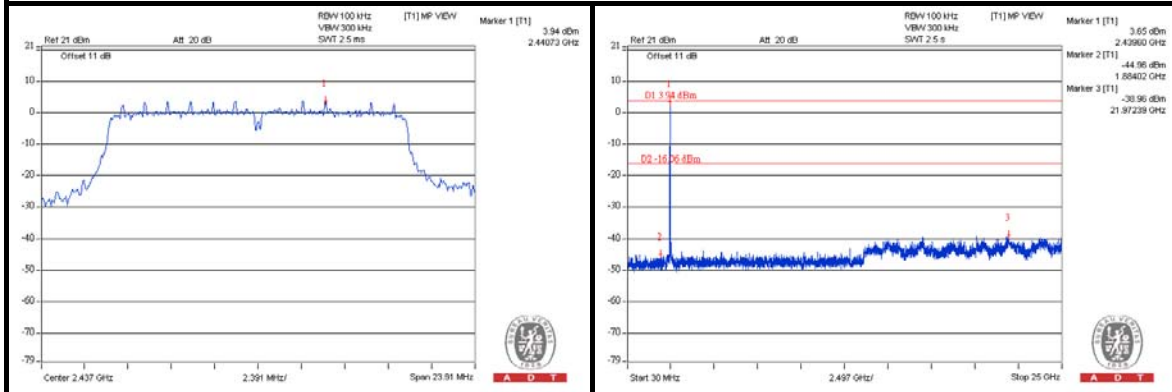

#### CH 11

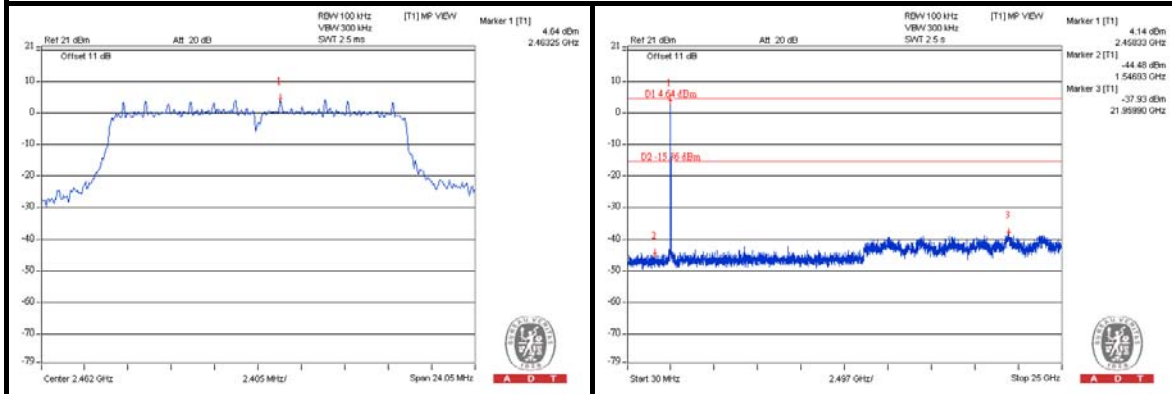



A D T

### 802.11n (20MHz)\_1TX

#### CH 1

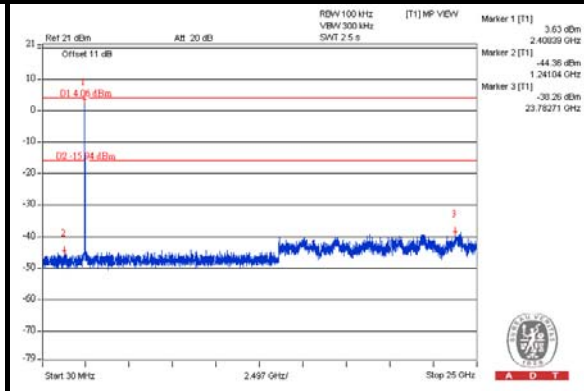
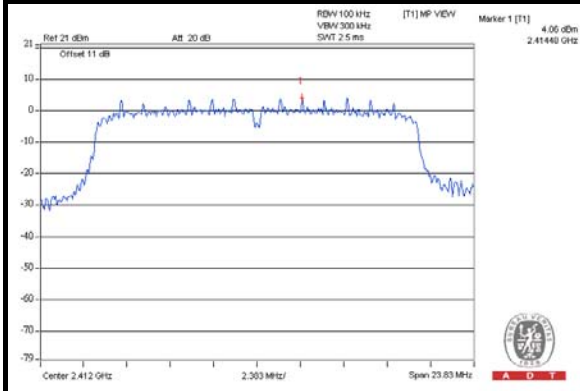

#### CH 6

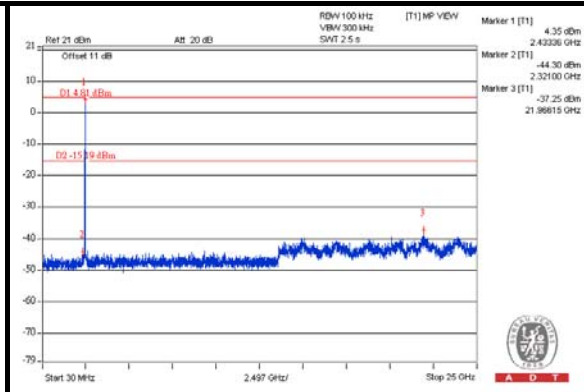
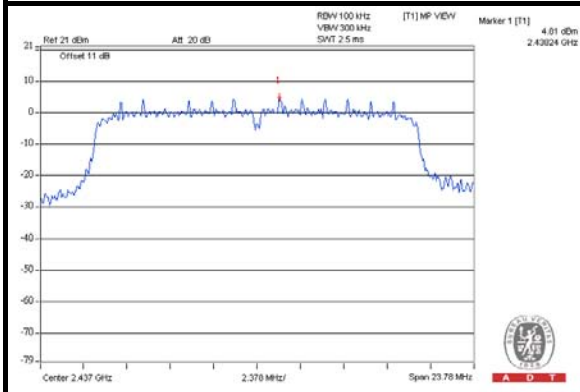

#### CH 11

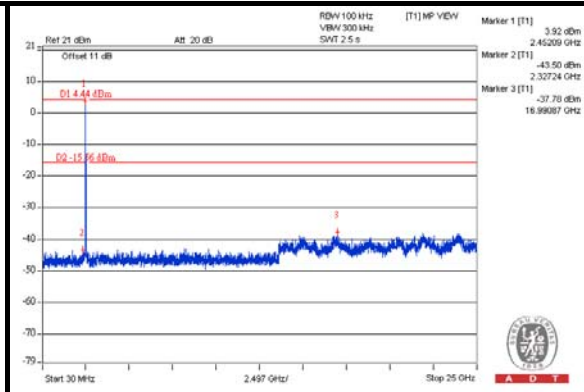
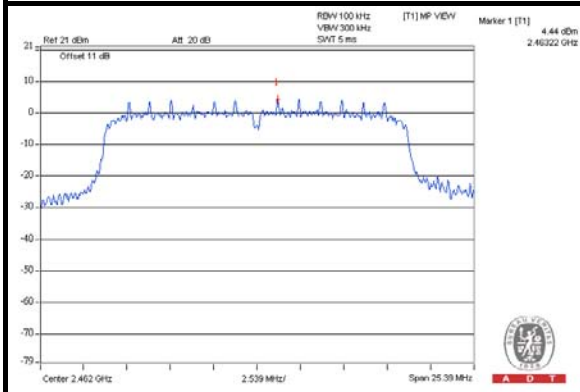



A D T

# 802.11n (20MHz)\_2TX CHAIN 0

## CH 1

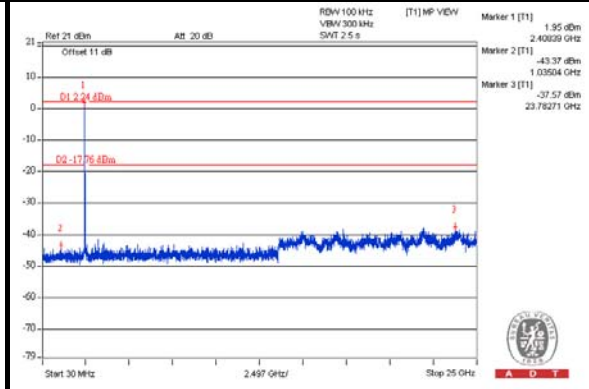
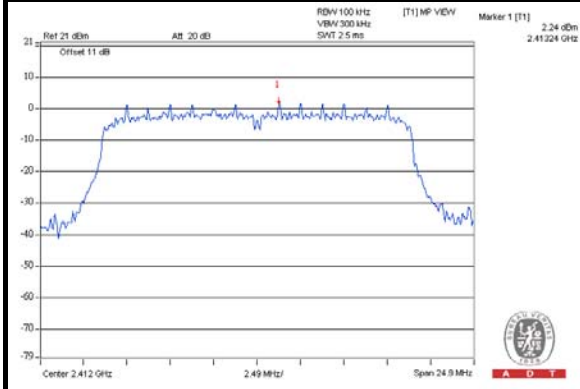

## CH 6

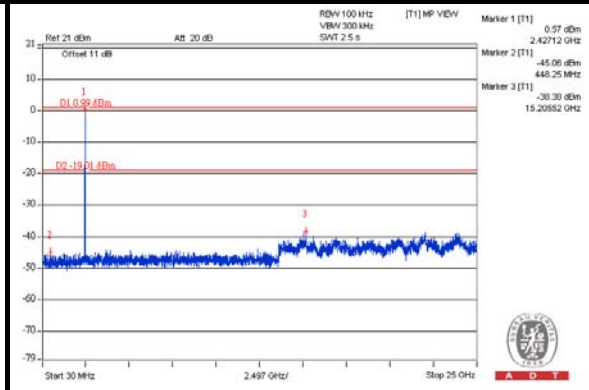
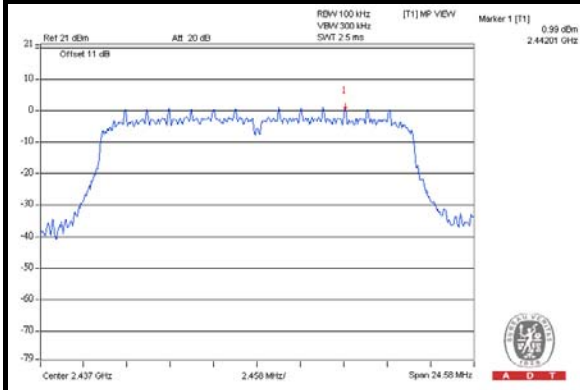

## CH 11

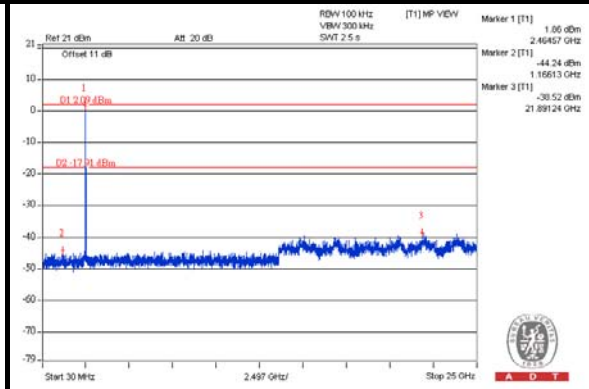
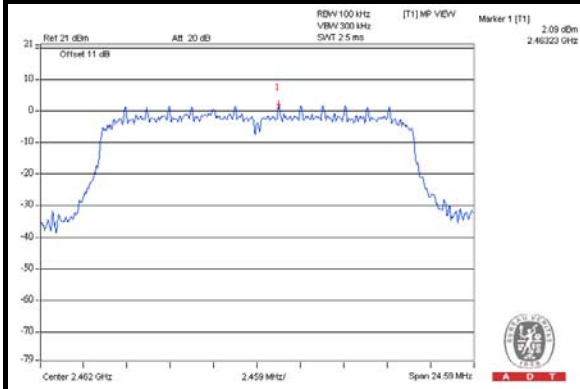

CHAIN 1

CH 1

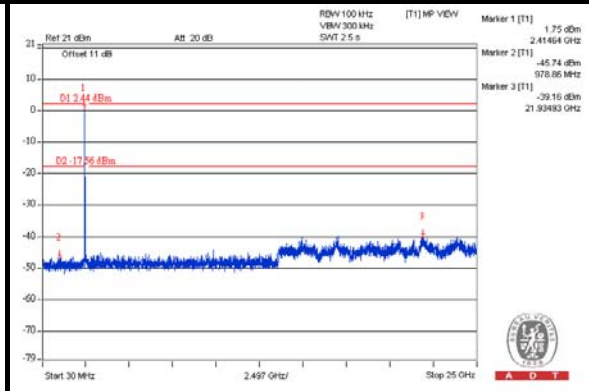
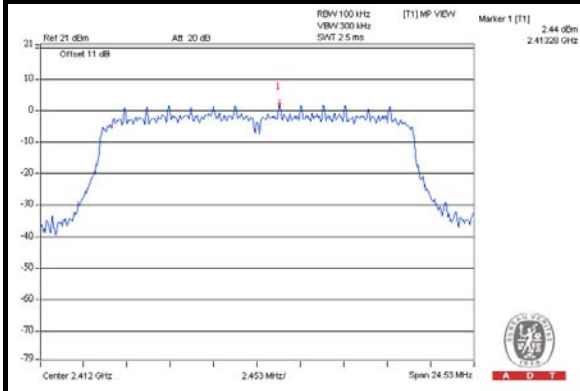

CH 6

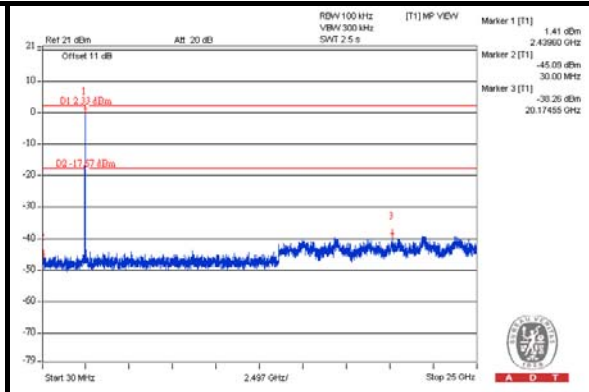
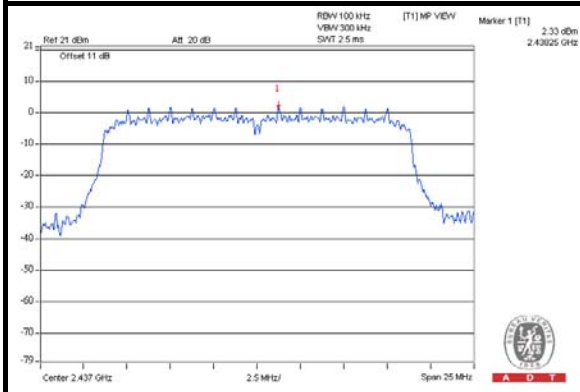

CH 11

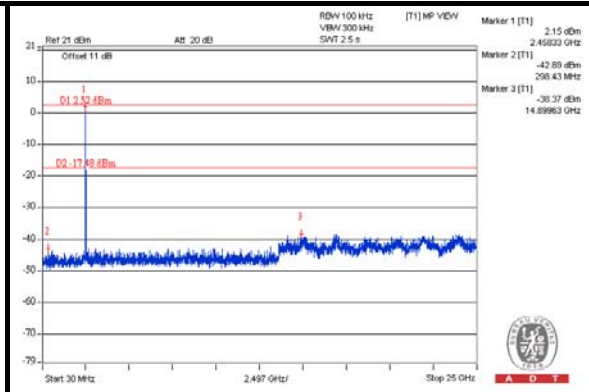
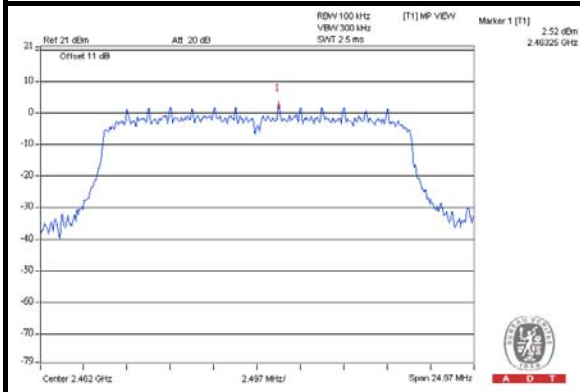



A D T

### 802.11n (40MHz)\_1TX

#### CH 3

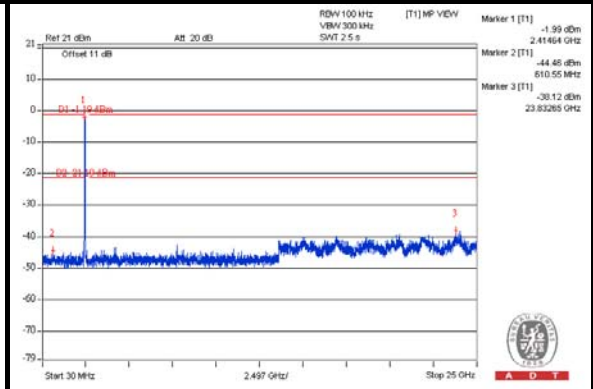
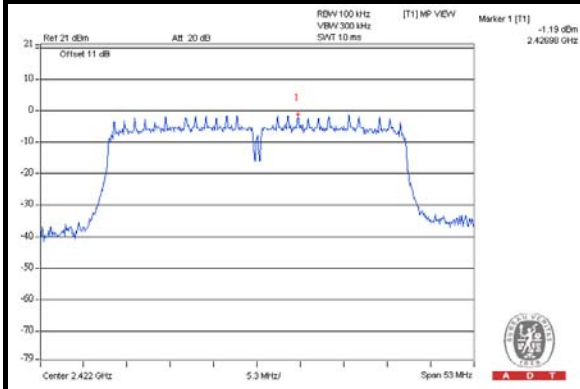

#### CH 6

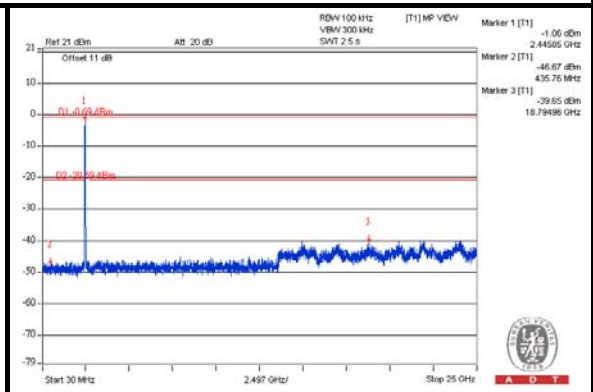
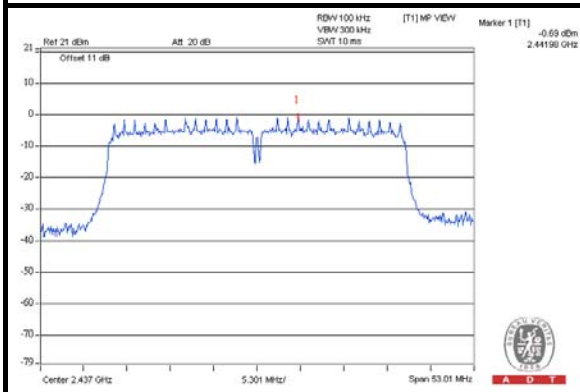

#### CH 9

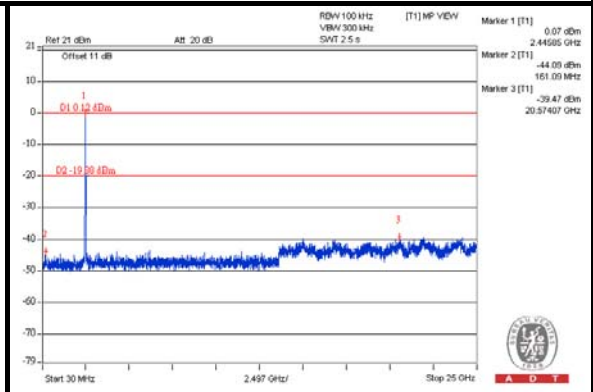
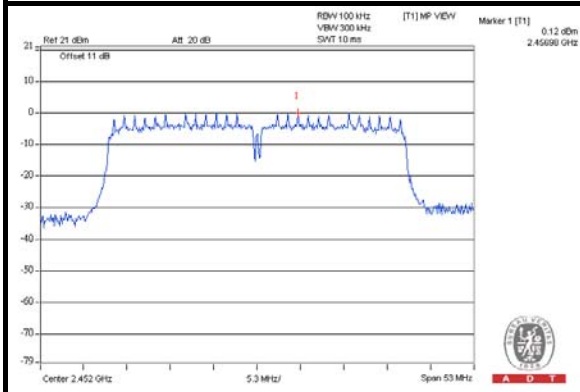



A D T

# 802.11n (40MHz)\_2TX CHAIN 0

## CH 3

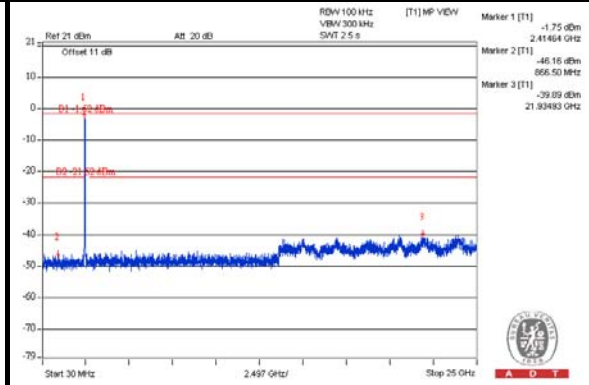
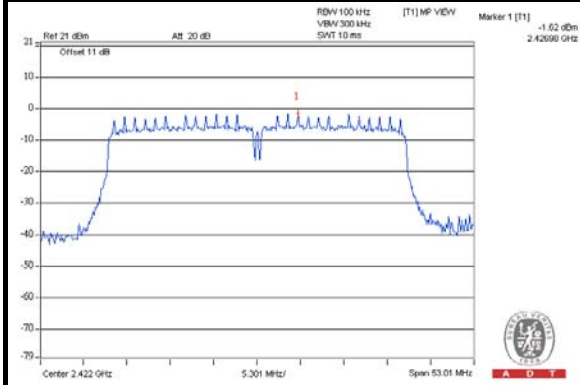

## CH 6

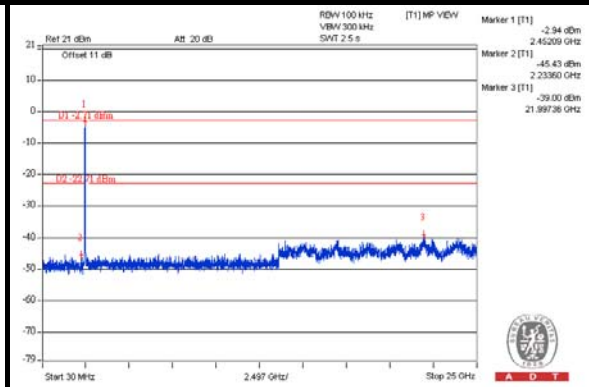
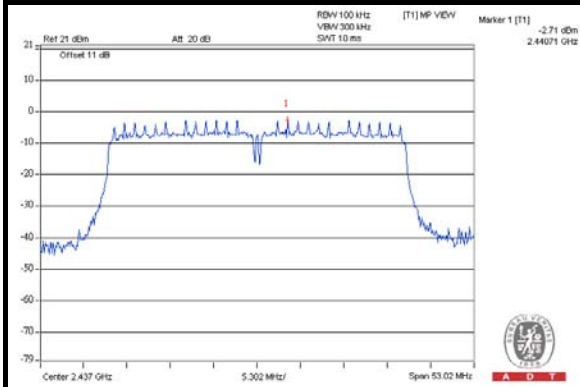

## CH 9

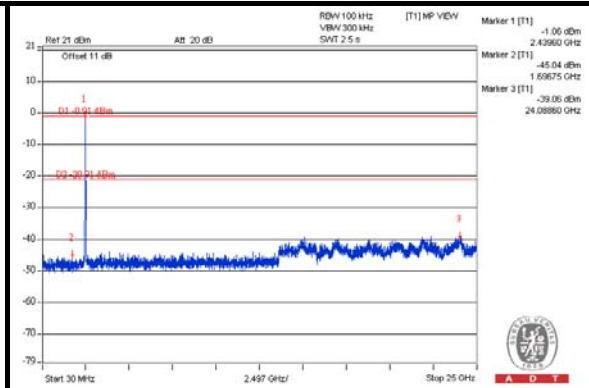
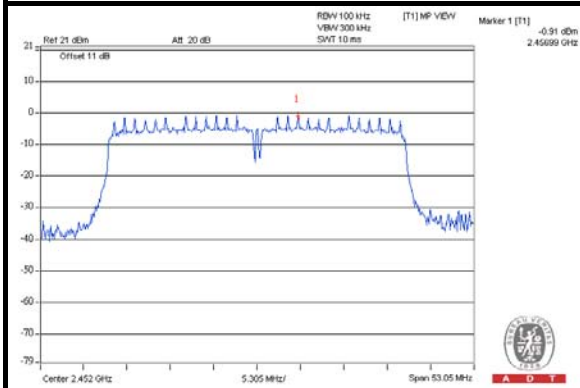



CHAIN 1

CH 3

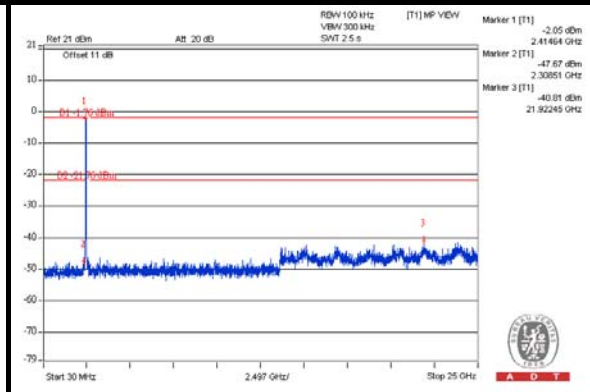
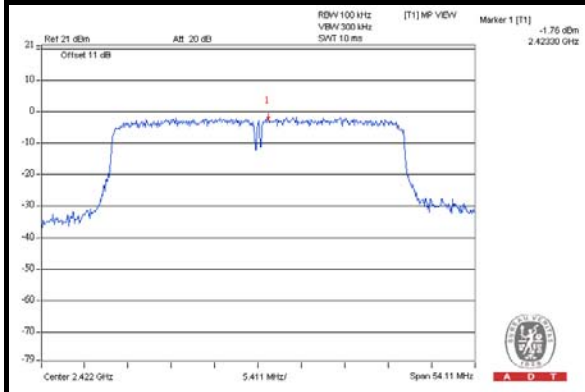

CH 6

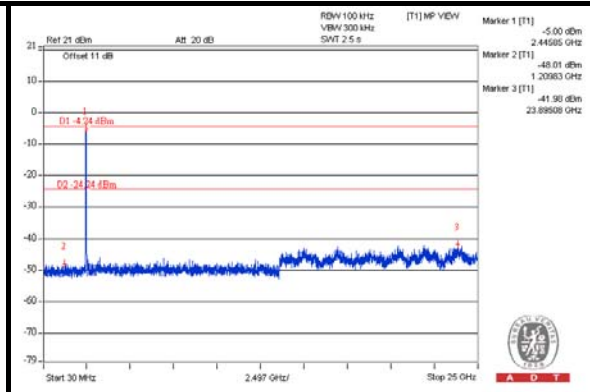
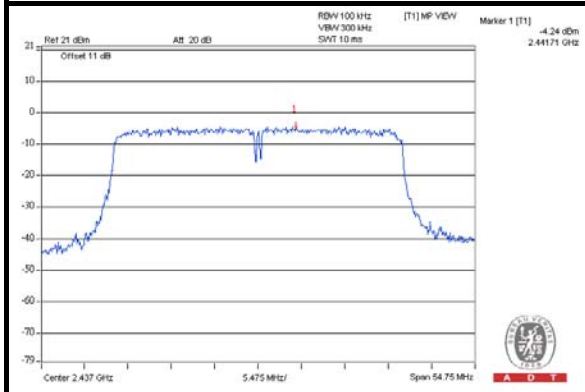

CH 9

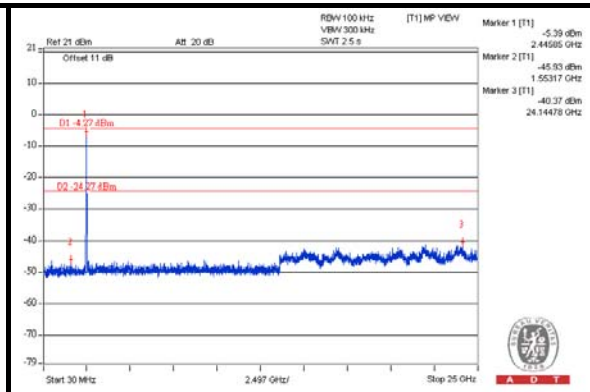
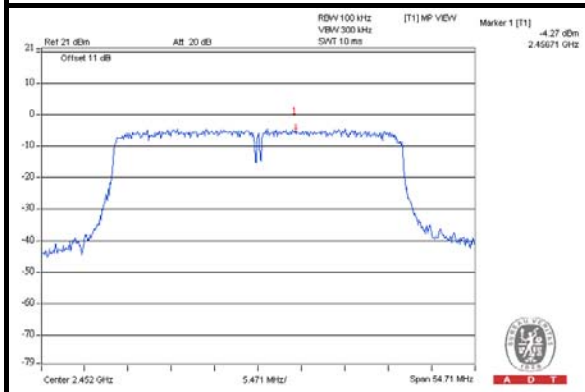



## 5. TEST TYPES AND RESULTS (FOR 5.0GHz BAND)

### 5.1 RADIATED EMISSION MEASUREMENT

#### 5.1.1 LIMITS OF RADIATED EMISSION MEASUREMENT

Radiated emissions which fall in the restricted bands must comply with the radiated emission limits specified as below table. Other emissions shall be at least 20dB below the highest level of the desired power:

FREQUENCIES (MHz)	FIELD STRENGTH (microvolts/meter)	MEASUREMENT DISTANCE (meters)
0.009 ~ 0.490	2400/F(kHz)	300
0.490 ~ 1.705	24000/F(kHz)	30
1.705 ~ 30.0	30	30
30 ~ 88	100	3
88 ~ 216	150	3
216 ~ 960	200	3
Above 960	500	3

**NOTE:**

1. The lower limit shall apply at the transition frequencies.
2. Emission level (dBuV/m) = 20 log Emission level (uV/m).
3. For frequencies above 1000MHz, the field strength limits are based on average detector, however, the peak field strength of any emission shall not exceed the maximum permitted average limits, specified above by more than 20dB under any condition of modulation.



### 5.1.2 TEST INSTRUMENTS

Test date: Oct. 20 ~ Dec. 11, 2012

DESCRIPTION & MANUFACTURER	MODEL NO.	SERIAL NO.	DATE OF CALIBRATION	DUE DATE OF CALIBRATION
Test Receiver ROHDE & SCHWARZ	ESCI	100744	Apr. 19, 2012	Apr. 18, 2013
Spectrum Analyzer ROHDE & SCHWARZ	FSP40	100269	Jan. 30, 2012	Jan. 29, 2013
BILOG Antenna SCHWARZBECK	VULB9168	9168-156	Apr. 03, 2012	Apr. 02, 2013
HORN Antenna SCHWARZBECK	BBHA 9120 D	9120D-563	Sep. 12, 2012	Sep. 11, 2013
HORN Antenna SCHWARZBECK	BBHA 9170	148	Jul. 11, 2012	Jul. 10, 2013
Preamplifier Agilent	8449B	3008A01975	Mar. 03, 2012	Mar. 02, 2013
Preamplifier Agilent	8447D	944A10663	May 11, 2012	May 10, 2013
RF signal cable HUBER+SUHNNER	SUCOFLEX 104	295013/4 283403/4	Aug. 28, 2012	Aug. 27, 2013
RF signal cable Worken	8D-FB	Cable-HYCH9-01	Aug. 11, 2012	Aug. 10, 2013
Software	ADT_Radiated_ V7.6.15.9.2	NA	NA	NA
Antenna Tower EMCO	2070/2080	512.835.4684	NA	NA
Turn Table EMCO	2087-2.03	NA	NA	NA
Antenna Tower & Turn Table Controller EMCO	2090	NA	NA	NA
26GHz ~ 40GHz Amplifier	EMC 184045	980116	Jan. 02, 2012	Jan. 01, 2013

- NOTE:**
1. The calibration interval of the above test instruments is 12 months and the calibrations are traceable to NML/ROC and NIST/USA.
  2. The test was performed in HwaYa Chamber 9.
  3. The horn antenna and HP preamplifier (model: 8449B) are used only for the measurement of emission frequency above 1GHz if tested.
  4. The FCC Site Registration No. is 460141.
  5. The IC Site Registration No. is IC 7450F-4.



A D T

### 5.1.3 TEST PROCEDURES

Same as item 4.1.3.

### 5.1.4 DEVIATION FROM TEST STANDARD

No deviation.

### 5.1.5 TEST SETUP

Same as item 4.1.5.

### 5.1.6 EUT OPERATING CONDITIONS

Same as 4.1.6.



A D T

### 5.1.7 TEST RESULTS

#### PIFA Antenna\_1 TX

#### 802.11a

EUT TEST CONDITION		MEASUREMENT DETAIL	
CHANNEL	Channel 149	FREQUENCY RANGE	1 ~ 40GHz
INPUT POWER (SYSTEM)	120Vac, 60Hz	DETECTOR FUNCTION	Peak (PK) Average (AV)
ENVIRONMENTAL CONDITIONS	22deg. C, 74%RH	TESTED BY	Antony Lee
TEST MODE	A 1		

ANTENNA POLARITY & TEST DISTANCE: HORIZONTAL AT 3 M								
NO.	FREQ. (MHz)	EMISSION LEVEL (dBuV/m)	LIMIT (dBuV/m)	MARGIN (dB)	ANTENNA HEIGHT (m)	TABLE ANGLE (Degree)	RAW VALUE (dBuV)	CORRECTION FACTOR (dB/m)
1	#5725.00	63.4 PK	78.7	-15.3	1.02 H	177	24.70	38.70
2	#5725.00	46.7 AV	68.7	-22.0	1.02 H	177	8.00	38.70
3	*5745.00	98.7 PK			1.02 H	179	59.90	38.80
4	*5745.00	88.7 AV			1.02 H	179	49.90	38.80
5	11490.00	57.4 PK	74.0	-16.6	1.00 H	360	8.00	49.40
6	11490.00	44.8 AV	54.0	-9.2	1.00 H	360	-4.60	49.40

ANTENNA POLARITY & TEST DISTANCE: VERTICAL AT 3 M								
NO.	FREQ. (MHz)	EMISSION LEVEL (dBuV/m)	LIMIT (dBuV/m)	MARGIN (dB)	ANTENNA HEIGHT (m)	TABLE ANGLE (Degree)	RAW VALUE (dBuV)	CORRECTION FACTOR (dB/m)
1	#5725.00	72.0 PK	86.7	-14.7	1.00 V	2	33.30	38.70
2	#5725.00	54.2 AV	76.3	-22.1	1.00 V	2	15.50	38.70
3	*5745.00	106.7 PK			1.00 V	2	67.90	38.80
4	*5745.00	96.3 AV			1.00 V	2	57.50	38.80
5	11490.00	57.1 PK	74.0	-16.9	1.00 V	36	7.70	49.40
6	11490.00	44.7 AV	54.0	-9.3	1.00 V	36	-4.70	49.40

#### REMARKS:

1. Emission level (dBuV/m) = Raw Value (dBuV) + Correction Factor (dB/m).
2. Correction Factor (dB/m) = Antenna Factor (dB/m) + Cable Factor (dB).
3. The other emission levels were very low against the limit.
4. Margin value = Emission level – Limit value.
5. “ \* “: Fundamental frequency.
6. The limit value is defined as per 15.247.
7. “#“:The radiated frequency is out the restricted band.



A D T

EUT TEST CONDITION		MEASUREMENT DETAIL	
CHANNEL	Channel 157	FREQUENCY RANGE	1 ~ 40GHz
INPUT POWER (SYSTEM)	120Vac, 60Hz	DETECTOR FUNCTION	Peak (PK) Average (AV)
ENVIRONMENTAL CONDITIONS	25deg. C, 67%RH	TESTED BY	Antony Lee
TEST MODE	A 1		

ANTENNA POLARITY & TEST DISTANCE: HORIZONTAL AT 3 M								
NO.	FREQ. (MHz)	EMISSION LEVEL (dBuV/m)	LIMIT (dBuV/m)	MARGIN (dB)	ANTENNA HEIGHT (m)	TABLE ANGLE (Degree)	RAW VALUE (dBuV)	CORRECTION FACTOR (dB/m)
1	*5785.00	99.8 PK			1.00 H	169	60.90	38.90
2	*5785.00	89.6 AV			1.00 H	169	50.70	38.90
3	7713.00	55.3 PK	74.0	-18.7	1.20 H	33	11.00	44.30
4	7713.00	41.6 AV	54.0	-12.4	1.20 H	33	-2.70	44.30
5	11570.00	60.2 PK	74.0	-13.8	1.00 H	36	11.00	49.20
6	11570.00	46.6 AV	54.0	-7.4	1.00 H	36	-2.60	49.20
ANTENNA POLARITY & TEST DISTANCE: VERTICAL AT 3 M								
NO.	FREQ. (MHz)	EMISSION LEVEL (dBuV/m)	LIMIT (dBuV/m)	MARGIN (dB)	ANTENNA HEIGHT (m)	TABLE ANGLE (Degree)	RAW VALUE (dBuV)	CORRECTION FACTOR (dB/m)
1	*5785.00	108.0 PK			1.00 V	319	69.10	38.90
2	*5785.00	98.0 AV			1.00 V	319	59.10	38.90
3	7713.00	54.2 PK	74.0	-19.8	1.23 V	64	9.90	44.30
4	7713.00	40.0 AV	54.0	-14.0	1.23 V	64	-4.30	44.30
5	11570.00	59.9 PK	74.0	-14.1	1.24 V	302	10.70	49.20
6	11570.00	46.9 AV	54.0	-7.1	1.24 V	302	-2.30	49.20

**REMARKS:**

1. Emission level (dBuV/m) = Raw Value (dBuV) + Correction Factor (dB/m).
2. Correction Factor (dB/m) = Antenna Factor (dB/m) + Cable Factor (dB).
3. The other emission levels were very low against the limit.
4. Margin value = Emission level – Limit value.
5. " \* ": Fundamental frequency.
6. " # ": The radiated frequency is out of the restricted band.



A D T

EUT TEST CONDITION		MEASUREMENT DETAIL	
CHANNEL	Channel 165	FREQUENCY RANGE	1 ~ 40GHz
INPUT POWER (SYSTEM)	120Vac, 60Hz	DETECTOR FUNCTION	Peak (PK) Average (AV)
ENVIRONMENTAL CONDITIONS	22deg. C, 74%RH	TESTED BY	Antony Lee
TEST MODE	A 1		

ANTENNA POLARITY & TEST DISTANCE: HORIZONTAL AT 3 M								
NO.	FREQ. (MHz)	EMISSION LEVEL (dBuV/m)	LIMIT (dBuV/m)	MARGIN (dB)	ANTENNA HEIGHT (m)	TABLE ANGLE (Degree)	RAW VALUE (dBuV)	CORRECTION FACTOR (dB/m)
1	*5825.00	98.3 PK			1.00 H	16	59.40	38.90
2	*5825.00	87.5 AV			1.00 H	16	48.60	38.90
3	#5850.00	52.3 PK	78.3	-26.0	1.00 H	18	13.30	39.00
4	#5850.00	41.2 AV	67.5	-26.3	1.00 H	18	2.20	39.00
5	11650.00	58.3 PK	74.0	-15.7	1.04 H	36	9.20	49.10
6	11650.00	45.2 AV	54.0	-8.8	1.04 H	36	-3.90	49.10

ANTENNA POLARITY & TEST DISTANCE: VERTICAL AT 3 M								
NO.	FREQ. (MHz)	EMISSION LEVEL (dBuV/m)	LIMIT (dBuV/m)	MARGIN (dB)	ANTENNA HEIGHT (m)	TABLE ANGLE (Degree)	RAW VALUE (dBuV)	CORRECTION FACTOR (dB/m)
1	*5825.00	105.8 PK			1.70 V	295	66.90	38.90
2	*5825.00	95.8 AV			1.70 V	295	56.90	38.90
3	#5850.00	55.6 PK	85.8	-30.2	1.70 V	295	16.60	39.00
4	#5850.00	42.5 AV	75.8	-33.3	1.70 V	295	3.50	39.00
5	11650.00	57.3 PK	74.0	-16.7	1.00 V	102	8.20	49.10
6	11650.00	44.9 AV	54.0	-9.1	1.00 V	102	-4.20	49.10

**REMARKS:**

1. Emission level (dBuV/m) = Raw Value (dBuV) + Correction Factor (dB/m).
2. Correction Factor (dB/m) = Antenna Factor (dB/m) + Cable Factor (dB).
3. The other emission levels were very low against the limit.
4. Margin value = Emission level – Limit value.
5. “ \* “: Fundamental frequency.
6. The limit value is defined as per 15.247.
7. "#":The radiated frequency is out the restricted band.



A D T

802.11n (20MHz)

EUT TEST CONDITION		MEASUREMENT DETAIL	
CHANNEL	Channel 149	FREQUENCY RANGE	1 ~ 40GHz
INPUT POWER (SYSTEM)	120Vac, 60Hz	DETECTOR FUNCTION	Peak (PK) Average (AV)
ENVIRONMENTAL CONDITIONS	25deg. C, 67%RH	TESTED BY	Chris Lin
TEST MODE	A 1		

ANTENNA POLARITY & TEST DISTANCE: HORIZONTAL AT 3 M								
NO.	FREQ. (MHz)	EMISSION LEVEL (dBuV/m)	LIMIT (dBuV/m)	MARGIN (dB)	ANTENNA HEIGHT (m)	TABLE ANGLE (Degree)	RAW VALUE (dBuV)	CORRECTION FACTOR (dB/m)
1	#5725.00	55.6 PK	75.6	-20.0	1.00 H	360	16.10	39.50
2	#5725.00	46.5 AV	66.5	-20.0	1.00 H	360	7.00	39.50
3	*5745.00	95.6 PK			1.00 H	360	56.00	39.60
4	*5745.00	86.5 AV			1.00 H	360	46.90	39.60
5	11490.00	60.5 PK	74.0	-13.5	1.10 H	52	8.80	51.70
6	11490.00	47.4 AV	54.0	-6.6	1.10 H	52	-4.30	51.70
ANTENNA POLARITY & TEST DISTANCE: VERTICAL AT 3 M								
NO.	FREQ. (MHz)	EMISSION LEVEL (dBuV/m)	LIMIT (dBuV/m)	MARGIN (dB)	ANTENNA HEIGHT (m)	TABLE ANGLE (Degree)	RAW VALUE (dBuV)	CORRECTION FACTOR (dB/m)
1	#5725.00	59.5 PK	79.5	-20.0	1.11 V	141	20.00	39.50
2	#5725.00	50.4 AV	70.4	-20.0	1.11 V	141	10.90	39.50
3	*5745.00	99.5 PK			1.11 V	141	59.90	39.60
4	*5745.00	90.4 AV			1.11 V	141	50.80	39.60
5	11490.00	59.5 PK	74.0	-14.5	1.10 V	63	7.80	51.70
6	11490.00	46.4 AV	54.0	-7.6	1.10 V	63	-5.30	51.70

REMARKS:

1. Emission level (dBuV/m) = Raw Value (dBuV) + Correction Factor (dB/m).
2. Correction Factor (dB/m) = Antenna Factor (dB/m) + Cable Factor (dB).
3. The other emission levels were very low against the limit.
4. Margin value = Emission level – Limit value.
5. “ \* “: Fundamental frequency.
6. The limit value is defined as per 15.247.
7. "#":The radiated frequency is out the restricted band.





A D T

EUT TEST CONDITION		MEASUREMENT DETAIL	
CHANNEL	Channel 157	FREQUENCY RANGE	1 ~ 40GHz
INPUT POWER (SYSTEM)	120Vac, 60Hz	DETECTOR FUNCTION	Peak (PK) Average (AV)
ENVIRONMENTAL CONDITIONS	25deg. C, 67%RH	TESTED BY	Chris Lin
TEST MODE	A 1		

ANTENNA POLARITY & TEST DISTANCE: HORIZONTAL AT 3 M								
NO.	FREQ. (MHz)	EMISSION LEVEL (dBuV/m)	LIMIT (dBuV/m)	MARGIN (dB)	ANTENNA HEIGHT (m)	TABLE ANGLE (Degree)	RAW VALUE (dBuV)	CORRECTION FACTOR (dB/m)
1	*5785.00	95.9 PK			1.00 H	347	56.20	39.70
2	*5785.00	85.9 AV			1.00 H	347	46.20	39.70
3	11570.00	58.6 PK	74.0	-15.4	1.12 H	65	7.00	51.60
4	11570.00	45.4 AV	54.0	-8.6	1.12 H	65	-6.20	51.60
5	#17355.00	63.1 PK	75.9	-12.8	1.17 H	85	7.70	55.40
6	#17355.00	50.6 AV	65.9	-15.3	1.17 H	85	-4.80	55.40

ANTENNA POLARITY & TEST DISTANCE: VERTICAL AT 3 M								
NO.	FREQ. (MHz)	EMISSION LEVEL (dBuV/m)	LIMIT (dBuV/m)	MARGIN (dB)	ANTENNA HEIGHT (m)	TABLE ANGLE (Degree)	RAW VALUE (dBuV)	CORRECTION FACTOR (dB/m)
1	*5785.00	99.7 PK			1.00 V	144	60.00	39.70
2	*5785.00	89.3 AV			1.00 V	144	49.60	39.70
3	11570.00	58.1 PK	74.0	-15.9	1.15 V	136	6.50	51.60
4	11570.00	45.1 AV	54.0	-8.9	1.15 V	136	-6.50	51.60
5	#17355.00	63.9 PK	79.7	-15.8	1.10 V	52	8.50	55.40
6	#17355.00	50.5 AV	69.3	-18.8	1.10 V	52	-4.90	55.40

**REMARKS:**

1. Emission level (dBuV/m) = Raw Value (dBuV) + Correction Factor (dB/m).
2. Correction Factor (dB/m) = Antenna Factor (dB/m) + Cable Factor (dB).
3. The other emission levels were very low against the limit.
4. Margin value = Emission level – Limit value.
5. “ \* “: Fundamental frequency.
6. The limit value is defined as per 15.247.
7. "#":The radiated frequency is out the restricted band.



A D T

EUT TEST CONDITION		MEASUREMENT DETAIL	
CHANNEL	Channel 165	FREQUENCY RANGE	1 ~ 40GHz
INPUT POWER (SYSTEM)	120Vac, 60Hz	DETECTOR FUNCTION	Peak (PK) Average (AV)
ENVIRONMENTAL CONDITIONS	25deg. C, 67%RH	TESTED BY	Chris Lin
TEST MODE	A 1		

ANTENNA POLARITY & TEST DISTANCE: HORIZONTAL AT 3 M								
NO.	FREQ. (MHz)	EMISSION LEVEL (dBuV/m)	LIMIT (dBuV/m)	MARGIN (dB)	ANTENNA HEIGHT (m)	TABLE ANGLE (Degree)	RAW VALUE (dBuV)	CORRECTION FACTOR (dB/m)
1	*5825.00	95.2 PK			1.00 H	345	55.50	39.70
2	*5825.00	85.3 AV			1.00 H	345	45.60	39.70
3	#5850.00	55.2 PK	75.2	-20.0	1.00 H	345	15.40	39.80
4	#5850.00	45.3 AV	65.3	-20.0	1.00 H	345	5.50	39.80
5	11650.00	59.1 PK	74.0	-14.9	1.02 H	89	7.50	51.60
6	11650.00	46.6 AV	54.0	-7.4	1.02 H	89	-5.00	51.60

ANTENNA POLARITY & TEST DISTANCE: VERTICAL AT 3 M								
NO.	FREQ. (MHz)	EMISSION LEVEL (dBuV/m)	LIMIT (dBuV/m)	MARGIN (dB)	ANTENNA HEIGHT (m)	TABLE ANGLE (Degree)	RAW VALUE (dBuV)	CORRECTION FACTOR (dB/m)
1	*5825.00	97.6 PK			1.00 V	141	57.90	39.70
2	*5825.00	87.8 AV			1.00 V	141	48.10	39.70
3	#5850.00	57.6 PK	77.6	-20.0	1.00 V	141	17.80	39.80
4	#5850.00	47.8 AV	67.8	-20.0	1.00 V	141	8.00	39.80
5	11650.00	60.2 PK	74.0	-13.8	1.10 V	66	8.60	51.60
6	11650.00	46.0 AV	54.0	-8.0	1.10 V	66	-5.60	51.60

**REMARKS:**

1. Emission level (dBuV/m) = Raw Value (dBuV) + Correction Factor (dB/m).
2. Correction Factor (dB/m) = Antenna Factor (dB/m) + Cable Factor (dB).
3. The other emission levels were very low against the limit.
4. Margin value = Emission level – Limit value.
5. “ \* “: Fundamental frequency.
6. The limit value is defined as per 15.247.
7. "#":The radiated frequency is out the restricted band.



A D T

802.11n (40MHz)

EUT TEST CONDITION		MEASUREMENT DETAIL	
CHANNEL	Channel 151	FREQUENCY RANGE	1 ~ 40GHz
INPUT POWER (SYSTEM)	120Vac, 60Hz	DETECTOR FUNCTION	Peak (PK) Average (AV)
ENVIRONMENTAL CONDITIONS	25deg. C, 67%RH	TESTED BY	Chris Lin
TEST MODE	A 1		

ANTENNA POLARITY & TEST DISTANCE: HORIZONTAL AT 3 M								
NO.	FREQ. (MHz)	EMISSION LEVEL (dBuV/m)	LIMIT (dBuV/m)	MARGIN (dB)	ANTENNA HEIGHT (m)	TABLE ANGLE (Degree)	RAW VALUE (dBuV)	CORRECTION FACTOR (dB/m)
1	#5725.00	57.9 PK	77.9	-20.0	1.00 H	360	18.40	39.50
2	#5725.00	47.8 AV	67.8	-20.0	1.00 H	360	8.30	39.50
3	*5755.00	97.9 PK			1.00 H	360	58.30	39.60
4	*5755.00	87.8 AV			1.00 H	360	48.20	39.60
5	11510.00	60.7 PK	74.0	-13.3	1.03 H	24	9.00	51.70
6	11510.00	46.0 AV	54.0	-8.0	1.03 H	24	-5.70	51.70
ANTENNA POLARITY & TEST DISTANCE: VERTICAL AT 3 M								
NO.	FREQ. (MHz)	EMISSION LEVEL (dBuV/m)	LIMIT (dBuV/m)	MARGIN (dB)	ANTENNA HEIGHT (m)	TABLE ANGLE (Degree)	RAW VALUE (dBuV)	CORRECTION FACTOR (dB/m)
1	#5725.00	60.2 PK	80.2	-20.0	1.00 V	142	20.70	39.50
2	#5725.00	49.9 AV	69.9	-20.0	1.00 V	142	10.40	39.50
3	*5755.00	100.2 PK			1.00 V	142	60.60	39.60
4	*5755.00	89.9 AV			1.00 V	142	50.30	39.60
5	11510.00	60.8 PK	74.0	-13.2	1.10 V	52	9.10	51.70
6	11510.00	46.4 AV	54.0	-7.6	1.10 V	52	-5.30	51.70

REMARKS:

1. Emission level (dBuV/m) = Raw Value (dBuV) + Correction Factor (dB/m).
2. Correction Factor (dB/m) = Antenna Factor (dB/m) + Cable Factor (dB).
3. The other emission levels were very low against the limit.
4. Margin value = Emission level – Limit value.
5. “ \* “: Fundamental frequency.
6. The limit value is defined as per 15.247.
7. "#":The radiated frequency is out the restricted band.



A D T

EUT TEST CONDITION		MEASUREMENT DETAIL	
CHANNEL	Channel 159	FREQUENCY RANGE	1 ~ 40GHz
INPUT POWER (SYSTEM)	120Vac, 60Hz	DETECTOR FUNCTION	Peak (PK) Average (AV)
ENVIRONMENTAL CONDITIONS	25deg. C, 67%RH	TESTED BY	Chris Lin
TEST MODE	A 1		

ANTENNA POLARITY & TEST DISTANCE: HORIZONTAL AT 3 M								
NO.	FREQ. (MHz)	EMISSION LEVEL (dBuV/m)	LIMIT (dBuV/m)	MARGIN (dB)	ANTENNA HEIGHT (m)	TABLE ANGLE (Degree)	RAW VALUE (dBuV)	CORRECTION FACTOR (dB/m)
1	*5795.00	96.0 PK			1.00 H	354	56.30	39.70
2	*5795.00	86.0 AV			1.00 H	354	46.30	39.70
3	#5850.00	56.0 PK	76.0	-20.0	1.00 H	354	16.20	39.80
4	#5850.00	46.0 AV	66.0	-20.0	1.00 H	354	6.20	39.80
5	11590.00	60.1 PK	74.0	-13.9	1.12 H	62	8.60	51.50
6	11590.00	45.9 AV	54.0	-8.1	1.12 H	62	-5.60	51.50

ANTENNA POLARITY & TEST DISTANCE: VERTICAL AT 3 M								
NO.	FREQ. (MHz)	EMISSION LEVEL (dBuV/m)	LIMIT (dBuV/m)	MARGIN (dB)	ANTENNA HEIGHT (m)	TABLE ANGLE (Degree)	RAW VALUE (dBuV)	CORRECTION FACTOR (dB/m)
1	*5795.00	97.9 PK			1.34 V	142	58.20	39.70
2	*5795.00	88.6 AV			1.34 V	142	48.90	39.70
3	#5850.00	57.9 PK	77.9	-20.0	1.34 V	142	18.10	39.80
4	#5850.00	48.6 AV	68.6	-20.0	1.34 V	142	8.80	39.80
5	11590.00	59.7 PK	74.0	-14.3	1.10 V	63	8.20	51.50
6	11590.00	46.9 AV	54.0	-7.1	1.10 V	63	-4.60	51.50

**REMARKS:**

1. Emission level (dBuV/m) = Raw Value (dBuV) + Correction Factor (dB/m).
2. Correction Factor (dB/m) = Antenna Factor (dB/m) + Cable Factor (dB).
3. The other emission levels were very low against the limit.
4. Margin value = Emission level – Limit value.
5. “ \* “: Fundamental frequency.
6. The limit value is defined as per 15.247.
7. "#":The radiated frequency is out the restricted band.



A D T

## PIFA Antenna\_2 TX

## 802.11n (20MHz)

EUT TEST CONDITION		MEASUREMENT DETAIL	
CHANNEL	Channel 149	FREQUENCY RANGE	1 ~ 40GHz
INPUT POWER (SYSTEM)	120Vac, 60Hz	DETECTOR FUNCTION	Peak (PK) Average (AV)
ENVIRONMENTAL CONDITIONS	22deg. C, 74%RH	TESTED BY	Antony Lee
TEST MODE	A 2		

ANTENNA POLARITY & TEST DISTANCE: HORIZONTAL AT 3 M								
NO.	FREQ. (MHz)	EMISSION LEVEL (dBuV/m)	LIMIT (dBuV/m)	MARGIN (dB)	ANTENNA HEIGHT (m)	TABLE ANGLE (Degree)	RAW VALUE (dBuV)	CORRECTION FACTOR (dB/m)
1	#5725.00	59.6 PK	79.2	-19.6	1.02 H	179	20.90	38.70
2	#5725.00	45.0 AV	67.7	-22.7	1.02 H	179	6.30	38.70
3	*5745.00	99.2 PK			1.02 H	179	60.40	38.80
4	*5745.00	87.7 AV			1.02 H	179	48.90	38.80
5	11490.00	59.5 PK	74.0	-14.5	1.24 H	127	10.10	49.40
6	11490.00	47.3 AV	54.0	-6.7	1.24 H	127	-2.10	49.40
ANTENNA POLARITY & TEST DISTANCE: VERTICAL AT 3 M								
NO.	FREQ. (MHz)	EMISSION LEVEL (dBuV/m)	LIMIT (dBuV/m)	MARGIN (dB)	ANTENNA HEIGHT (m)	TABLE ANGLE (Degree)	RAW VALUE (dBuV)	CORRECTION FACTOR (dB/m)
1	#5725.00	69.2 PK	87.3	-18.1	1.00 V	353	30.50	38.70
2	#5725.00	55.1 AV	76.1	-21.0	1.00 V	353	16.40	38.70
3	*5745.00	107.3 PK			1.01 V	353	68.50	38.80
4	*5745.00	96.1 AV			1.01 V	353	57.30	38.80
5	11490.00	59.8 PK	74.0	-14.2	1.00 V	64	10.40	49.40
6	11490.00	46.9 AV	54.0	-7.1	1.00 V	64	-2.50	49.40

## REMARKS:

1. Emission level (dBuV/m) = Raw Value (dBuV) + Correction Factor (dB/m).
2. Correction Factor (dB/m) = Antenna Factor (dB/m) + Cable Factor (dB).
3. The other emission levels were very low against the limit.
4. Margin value = Emission level – Limit value.
5. “ \* “: Fundamental frequency.
6. The limit value is defined as per 15.247.
7. "#":The radiated frequency is out the restricted band.



A D T

EUT TEST CONDITION		MEASUREMENT DETAIL	
CHANNEL	Channel 157	FREQUENCY RANGE	1 ~ 40GHz
INPUT POWER (SYSTEM)	120Vac, 60Hz	DETECTOR FUNCTION	Peak (PK) Average (AV)
ENVIRONMENTAL CONDITIONS	22deg. C, 74%RH	TESTED BY	Antony Lee
TEST MODE	A 2		

ANTENNA POLARITY & TEST DISTANCE: HORIZONTAL AT 3 M								
NO.	FREQ. (MHz)	EMISSION LEVEL (dBuV/m)	LIMIT (dBuV/m)	MARGIN (dB)	ANTENNA HEIGHT (m)	TABLE ANGLE (Degree)	RAW VALUE (dBuV)	CORRECTION FACTOR (dB/m)
1	*5785.00	101.6 PK			1.02 H	200	62.70	38.90
2	*5785.00	90.3 AV			1.02 H	200	51.40	38.90
3	7713.00	56.4 PK	74.0	-17.6	1.21 H	69	12.10	44.30
4	7713.00	42.3 AV	54.0	-11.7	1.21 H	69	-2.00	44.30
5	11570.00	61.2 PK	74.0	-12.8	1.00 H	33	12.00	49.20
6	11570.00	47.3 AV	54.0	-6.7	1.00 H	33	-1.90	49.20
ANTENNA POLARITY & TEST DISTANCE: VERTICAL AT 3 M								
NO.	FREQ. (MHz)	EMISSION LEVEL (dBuV/m)	LIMIT (dBuV/m)	MARGIN (dB)	ANTENNA HEIGHT (m)	TABLE ANGLE (Degree)	RAW VALUE (dBuV)	CORRECTION FACTOR (dB/m)
1	*5785.00	107.0 PK			1.00 V	351	68.10	38.90
2	*5785.00	95.7 AV			1.00 V	351	56.80	38.90
3	7713.00	54.6 PK	74.0	-19.4	1.02 V	98	10.30	44.30
4	7713.00	41.2 AV	54.0	-12.8	1.02 V	98	-3.10	44.30
5	11570.00	60.2 PK	74.0	-13.8	1.00 V	66	11.00	49.20
6	11570.00	47.3 AV	54.0	-6.7	1.00 V	66	-1.90	49.20

**REMARKS:**

1. Emission level (dBuV/m) = Raw Value (dBuV) + Correction Factor (dB/m).
2. Correction Factor (dB/m) = Antenna Factor (dB/m) + Cable Factor (dB).
3. The other emission levels were very low against the limit.
4. Margin value = Emission level – Limit value.
5. “ \* “: Fundamental frequency.
6. The limit value is defined as per 15.247.



A D T

EUT TEST CONDITION		MEASUREMENT DETAIL	
CHANNEL	Channel 165	FREQUENCY RANGE	1 ~ 40GHz
INPUT POWER (SYSTEM)	120Vac, 60Hz	DETECTOR FUNCTION	Peak (PK) Average (AV)
ENVIRONMENTAL CONDITIONS	22deg. C, 74%RH	TESTED BY	Antony Lee
TEST MODE	A 2		

ANTENNA POLARITY & TEST DISTANCE: HORIZONTAL AT 3 M								
NO.	FREQ. (MHz)	EMISSION LEVEL (dBuV/m)	LIMIT (dBuV/m)	MARGIN (dB)	ANTENNA HEIGHT (m)	TABLE ANGLE (Degree)	RAW VALUE (dBuV)	CORRECTION FACTOR (dB/m)
1	*5825.00	100.3 PK			1.00 H	24	61.40	38.90
2	*5825.00	89.6 AV			1.00 H	24	50.70	38.90
3	#5850.00	69.9 PK	80.3	-10.4	1.00 H	33	30.90	39.00
4	#5850.00	57.2 AV	69.6	-12.4	1.00 H	33	18.20	39.00
5	11650.00	58.6 PK	74.0	-15.4	1.02 H	33	9.50	49.10
6	11650.00	46.7 AV	54.0	-7.3	1.02 H	33	-2.40	49.10

ANTENNA POLARITY & TEST DISTANCE: VERTICAL AT 3 M								
NO.	FREQ. (MHz)	EMISSION LEVEL (dBuV/m)	LIMIT (dBuV/m)	MARGIN (dB)	ANTENNA HEIGHT (m)	TABLE ANGLE (Degree)	RAW VALUE (dBuV)	CORRECTION FACTOR (dB/m)
1	*5825.00	107.7 PK			1.26 V	320	68.80	38.90
2	*5825.00	96.8 AV			1.26 V	320	57.90	38.90
3	#5850.00	57.6 PK	87.7	-30.1	1.26 V	320	18.60	39.00
4	#5850.00	44.3 AV	76.8	-32.5	1.26 V	320	5.30	39.00
5	11650.00	58.2 PK	74.0	-15.8	1.00 V	104	9.10	49.10
6	11650.00	45.2 AV	54.0	-8.8	1.00 V	104	-3.90	49.10

**REMARKS:**

1. Emission level (dBuV/m) = Raw Value (dBuV) + Correction Factor (dB/m).
2. Correction Factor (dB/m) = Antenna Factor (dB/m) + Cable Factor (dB).
3. The other emission levels were very low against the limit.
4. Margin value = Emission level – Limit value.
5. “ \* “: Fundamental frequency.
6. The limit value is defined as per 15.247.
7. “#”:The radiated frequency is out the restricted band.



A D T

## 802.11n (40MHz)

EUT TEST CONDITION		MEASUREMENT DETAIL	
CHANNEL	Channel 151	FREQUENCY RANGE	1 ~ 40GHz
INPUT POWER (SYSTEM)	120Vac, 60Hz	DETECTOR FUNCTION	Peak (PK) Average (AV)
ENVIRONMENTAL CONDITIONS	22deg. C, 74%RH	TESTED BY	Antony Lee
TEST MODE	A 2		

ANTENNA POLARITY & TEST DISTANCE: HORIZONTAL AT 3 M								
NO.	FREQ. (MHz)	EMISSION LEVEL (dBuV/m)	LIMIT (dBuV/m)	MARGIN (dB)	ANTENNA HEIGHT (m)	TABLE ANGLE (Degree)	RAW VALUE (dBuV)	CORRECTION FACTOR (dB/m)
1	#5725.00	60.7 PK	75.9	-15.2	1.21 H	323	22.00	38.70
2	#5725.00	48.1 AV	64.3	-16.2	1.21 H	323	9.40	38.70
3	*5755.00	95.9 PK			1.21 H	323	57.10	38.80
4	*5755.00	84.3 AV			1.21 H	323	45.50	38.80
5	11510.00	58.3 PK	74.0	-15.7	1.00 H	328	8.90	49.40
6	11510.00	45.2 AV	54.0	-8.8	1.00 H	328	-4.20	49.40
ANTENNA POLARITY & TEST DISTANCE: VERTICAL AT 3 M								
NO.	FREQ. (MHz)	EMISSION LEVEL (dBuV/m)	LIMIT (dBuV/m)	MARGIN (dB)	ANTENNA HEIGHT (m)	TABLE ANGLE (Degree)	RAW VALUE (dBuV)	CORRECTION FACTOR (dB/m)
1	#5725.00	69.1 PK	82.6	-13.5	1.00 V	352	30.40	38.70
2	#5725.00	56.1 AV	72.0	-15.9	1.00 V	352	17.40	38.70
3	*5755.00	102.6 PK			1.00 V	352	63.80	38.80
4	*5755.00	92.0 AV			1.00 V	352	53.20	38.80
5	11510.00	58.4 PK	74.0	-15.6	1.00 V	263	9.00	49.40
6	11510.00	45.7 AV	54.0	-8.3	1.00 V	263	-3.70	49.40

## REMARKS:

1. Emission level (dBuV/m) = Raw Value (dBuV) + Correction Factor (dB/m).
2. Correction Factor (dB/m) = Antenna Factor (dB/m) + Cable Factor (dB).
3. The other emission levels were very low against the limit.
4. Margin value = Emission level – Limit value.
5. “ \* “: Fundamental frequency.
6. The limit value is defined as per 15.247.
7. "#":The radiated frequency is out the restricted band.





A D T

EUT TEST CONDITION		MEASUREMENT DETAIL	
CHANNEL	Channel 159	FREQUENCY RANGE	1 ~ 40GHz
INPUT POWER (SYSTEM)	120Vac, 60Hz	DETECTOR FUNCTION	Peak (PK) Average (AV)
ENVIRONMENTAL CONDITIONS	22deg. C, 74%RH	TESTED BY	Antony Lee
TEST MODE	A 2		

ANTENNA POLARITY & TEST DISTANCE: HORIZONTAL AT 3 M								
NO.	FREQ. (MHz)	EMISSION LEVEL (dBuV/m)	LIMIT (dBuV/m)	MARGIN (dB)	ANTENNA HEIGHT (m)	TABLE ANGLE (Degree)	RAW VALUE (dBuV)	CORRECTION FACTOR (dB/m)
1	*5795.00	96.2 PK			1.00 H	135	57.30	38.90
2	*5795.00	85.3 AV			1.00 H	135	46.40	38.90
3	#5850.00	60.3 PK	76.2	-15.9	1.00 H	135	21.30	39.00
4	#5850.00	47.3 AV	65.3	-18.0	1.00 H	135	8.30	39.00
5	11590.00	59.3 PK	74.0	-14.7	1.00 H	360	10.20	49.10
6	11590.00	46.2 AV	54.0	-7.8	1.00 H	360	-2.90	49.10
ANTENNA POLARITY & TEST DISTANCE: VERTICAL AT 3 M								
NO.	FREQ. (MHz)	EMISSION LEVEL (dBuV/m)	LIMIT (dBuV/m)	MARGIN (dB)	ANTENNA HEIGHT (m)	TABLE ANGLE (Degree)	RAW VALUE (dBuV)	CORRECTION FACTOR (dB/m)
1	*5795.00	101.1 PK			1.00 V	228	62.20	38.90
2	*5795.00	91.8 AV			1.00 V	228	52.90	38.90
3	#5850.00	50.1 PK	81.1	-31.0	1.00 V	228	11.10	39.00
4	#5850.00	38.1 AV	71.8	-33.7	1.00 V	228	-0.90	39.00
5	11590.00	58.3 PK	74.0	-15.7	1.00 V	39	9.20	49.10
6	11590.00	45.6 AV	54.0	-8.4	1.00 V	39	-3.50	49.10

**REMARKS:**

1. Emission level (dBuV/m) = Raw Value (dBuV) + Correction Factor (dB/m).
2. Correction Factor (dB/m) = Antenna Factor (dB/m) + Cable Factor (dB).
3. The other emission levels were very low against the limit.
4. Margin value = Emission level – Limit value.
5. “ \* “: Fundamental frequency.
6. The limit value is defined as per 15.247.
7. “#”:The radiated frequency is out the restricted band.



A D T

Monopole Antenna\_1TX

802.11a

EUT TEST CONDITION		MEASUREMENT DETAIL	
CHANNEL	Channel 149	FREQUENCY RANGE	1 ~ 40GHz
INPUT POWER (SYSTEM)	120Vac, 60Hz	DETECTOR FUNCTION	Peak (PK) Average (AV)
ENVIRONMENTAL CONDITIONS	25deg. C, 68%RH	TESTED BY	Antony Lee
TEST MODE	B 1		

ANTENNA POLARITY & TEST DISTANCE: HORIZONTAL AT 3 M								
NO.	FREQ. (MHz)	EMISSION LEVEL (dBuV/m)	LIMIT (dBuV/m)	MARGIN (dB)	ANTENNA HEIGHT (m)	TABLE ANGLE (Degree)	RAW VALUE (dBuV)	CORRECTION FACTOR (dB/m)
1	#5725.00	62.5 PK	77.6	-15.1	1.27 H	328	23.80	38.70
2	#5725.00	46.2 AV	67.3	-21.1	1.27 H	328	7.50	38.70
3	*5745.00	97.6 PK			1.27 H	328	58.80	38.80
4	*5745.00	87.3 AV			1.27 H	328	48.50	38.80
5	11490.00	56.8 PK	74.0	-17.2	1.00 H	23	7.40	49.40
6	11490.00	43.9 AV	54.0	-10.1	1.00 H	23	-5.50	49.40

ANTENNA POLARITY & TEST DISTANCE: VERTICAL AT 3 M								
NO.	FREQ. (MHz)	EMISSION LEVEL (dBuV/m)	LIMIT (dBuV/m)	MARGIN (dB)	ANTENNA HEIGHT (m)	TABLE ANGLE (Degree)	RAW VALUE (dBuV)	CORRECTION FACTOR (dB/m)
1	#3000.00	50.6 PK	85.5	-34.9	1.02 V	270	17.80	32.80
2	#3000.00	47.0 AV	75.0	-28.0	1.02 V	270	14.20	32.80
3	#5725.00	70.4 PK	85.5	-15.1	1.00 V	24	31.70	38.70
4	#5725.00	52.4 AV	75.0	-22.6	1.00 V	24	13.70	38.70
5	*5745.00	105.5 PK			1.02 V	14	66.70	38.80
6	*5745.00	95.0 AV			1.02 V	14	56.20	38.80
7	11490.00	57.7 PK	74.0	-16.3	1.00 V	158	8.30	49.40
8	11490.00	44.0 AV	54.0	-10.0	1.00 V	158	-5.40	49.40

REMARKS:

1. Emission level (dBuV/m) = Raw Value (dBuV) + Correction Factor (dB/m).
2. Correction Factor (dB/m) = Antenna Factor (dB/m) + Cable Factor (dB).
3. The other emission levels were very low against the limit.
4. Margin value = Emission level – Limit value.
5. “ \* “: Fundamental frequency.
6. The limit value is defined as per 15.247.
7. "#":The radiated frequency is out the restricted band.



A D T

EUT TEST CONDITION		MEASUREMENT DETAIL	
CHANNEL	Channel 157	FREQUENCY RANGE	1 ~ 40GHz
INPUT POWER (SYSTEM)	120Vac, 60Hz	DETECTOR FUNCTION	Peak (PK) Average (AV)
ENVIRONMENTAL CONDITIONS	25deg. C, 68%RH	TESTED BY	Antony Lee
TEST MODE	B 1		

ANTENNA POLARITY & TEST DISTANCE: HORIZONTAL AT 3 M								
NO.	FREQ. (MHz)	EMISSION LEVEL (dBuV/m)	LIMIT (dBuV/m)	MARGIN (dB)	ANTENNA HEIGHT (m)	TABLE ANGLE (Degree)	RAW VALUE (dBuV)	CORRECTION FACTOR (dB/m)
1	*5785.00	98.3 PK			1.00 H	302	59.40	38.90
2	*5785.00	87.4 AV			1.00 H	302	48.50	38.90
3	7713.00	54.2 PK	74.0	-19.8	1.00 H	214	9.90	44.30
4	7713.00	41.6 AV	54.0	-12.4	1.00 H	214	-2.70	44.30
5	11570.00	57.1 PK	74.0	-16.9	1.00 H	30	7.90	49.20
6	11570.00	44.8 AV	54.0	-9.2	1.00 H	30	-4.40	49.20
ANTENNA POLARITY & TEST DISTANCE: VERTICAL AT 3 M								
NO.	FREQ. (MHz)	EMISSION LEVEL (dBuV/m)	LIMIT (dBuV/m)	MARGIN (dB)	ANTENNA HEIGHT (m)	TABLE ANGLE (Degree)	RAW VALUE (dBuV)	CORRECTION FACTOR (dB/m)
1	*5785.00	105.1 PK			1.06 V	3	66.20	38.90
2	*5785.00	94.7 AV			1.06 V	3	55.80	38.90
3	7713.00	54.6 PK	74.0	-19.4	1.00 V	158	10.30	44.30
4	7713.00	41.3 AV	54.0	-12.7	1.00 V	158	-3.00	44.30
5	11570.00	57.3 PK	74.0	-16.7	1.00 V	163	8.10	49.20
6	11570.00	44.6 AV	54.0	-9.4	1.00 V	163	-4.60	49.20

**REMARKS:**

1. Emission level (dBuV/m) = Raw Value (dBuV) + Correction Factor (dB/m).
2. Correction Factor (dB/m) = Antenna Factor (dB/m) + Cable Factor (dB).
3. The other emission levels were very low against the limit.
4. Margin value = Emission level – Limit value.
5. “ \* “: Fundamental frequency.
6. The limit value is defined as per 15.247.



A D T

EUT TEST CONDITION		MEASUREMENT DETAIL	
CHANNEL	Channel 165	FREQUENCY RANGE	1 ~ 40GHz
INPUT POWER (SYSTEM)	120Vac, 60Hz	DETECTOR FUNCTION	Peak (PK) Average (AV)
ENVIRONMENTAL CONDITIONS	25deg. C, 68%RH	TESTED BY	Antony Lee
TEST MODE	B 1		

ANTENNA POLARITY & TEST DISTANCE: HORIZONTAL AT 3 M								
NO.	FREQ. (MHz)	EMISSION LEVEL (dBuV/m)	LIMIT (dBuV/m)	MARGIN (dB)	ANTENNA HEIGHT (m)	TABLE ANGLE (Degree)	RAW VALUE (dBuV)	CORRECTION FACTOR (dB/m)
1	*5825.00	97.8 PK			1.23 H	345	58.90	38.90
2	*5825.00	87.6 AV			1.23 H	345	48.70	38.90
3	#5850.00	49.8 PK	77.8	-28.0	1.23 H	345	10.80	39.00
4	#5850.00	37.2 AV	67.6	-30.4	1.23 H	345	-1.80	39.00
5	11650.00	59.5 PK	74.0	-14.5	1.00 H	247	10.40	49.10
6	11650.00	45.7 AV	54.0	-8.3	1.00 H	247	-3.40	49.10
ANTENNA POLARITY & TEST DISTANCE: VERTICAL AT 3 M								
NO.	FREQ. (MHz)	EMISSION LEVEL (dBuV/m)	LIMIT (dBuV/m)	MARGIN (dB)	ANTENNA HEIGHT (m)	TABLE ANGLE (Degree)	RAW VALUE (dBuV)	CORRECTION FACTOR (dB/m)
1	*5825.00	104.9 PK			1.00 V	47	66.00	38.90
2	*5825.00	93.5 AV			1.00 V	47	54.60	38.90
3	#5850.00	53.4 PK	84.9	-31.5	1.00 V	47	14.40	39.00
4	#5850.00	39.9 AV	73.5	-33.6	1.00 V	47	0.90	39.00
5	11650.00	58.3 PK	74.0	-15.7	1.00 V	188	9.20	49.10
6	11650.00	45.2 AV	54.0	-8.8	1.00 V	188	-3.90	49.10

**REMARKS:**

1. Emission level (dBuV/m) = Raw Value (dBuV) + Correction Factor (dB/m).
2. Correction Factor (dB/m) = Antenna Factor (dB/m) + Cable Factor (dB).
3. The other emission levels were very low against the limit.
4. Margin value = Emission level – Limit value.
5. “ \* “: Fundamental frequency.
6. The limit value is defined as per 15.247.
7. "#":The radiated frequency is out the restricted band.



A D T

802.11n (20MHz)

EUT TEST CONDITION		MEASUREMENT DETAIL	
CHANNEL	Channel 149	FREQUENCY RANGE	1 ~ 40GHz
INPUT POWER (SYSTEM)	120Vac, 60Hz	DETECTOR FUNCTION	Peak (PK) Average (AV)
ENVIRONMENTAL CONDITIONS	25deg. C, 68%RH	TESTED BY	Antony Lee
TEST MODE	B 1		

ANTENNA POLARITY & TEST DISTANCE: HORIZONTAL AT 3 M								
NO.	FREQ. (MHz)	EMISSION LEVEL (dBuV/m)	LIMIT (dBuV/m)	MARGIN (dB)	ANTENNA HEIGHT (m)	TABLE ANGLE (Degree)	RAW VALUE (dBuV)	CORRECTION FACTOR (dB/m)
1	#5725.00	65.4 PK	76.0	-10.6	1.60 H	327	26.70	38.70
2	#5725.00	46.6 AV	65.5	-18.9	1.60 H	327	7.90	38.70
3	*5745.00	96.0 PK			1.60 H	327	57.20	38.80
4	*5745.00	85.5 AV			1.60 H	327	46.70	38.80
5	11490.00	57.3 PK	74.0	-16.7	1.00 H	20	7.90	49.40
6	11490.00	44.5 AV	54.0	-9.5	1.00 H	20	-4.90	49.40

ANTENNA POLARITY & TEST DISTANCE: VERTICAL AT 3 M								
NO.	FREQ. (MHz)	EMISSION LEVEL (dBuV/m)	LIMIT (dBuV/m)	MARGIN (dB)	ANTENNA HEIGHT (m)	TABLE ANGLE (Degree)	RAW VALUE (dBuV)	CORRECTION FACTOR (dB/m)
1	#5725.00	72.2 PK	85.7	-13.5	1.08 V	2	33.50	38.70
2	#5725.00	54.5 AV	74.6	-20.1	1.08 V	2	15.80	38.70
3	*5745.00	105.7 PK			1.08 V	2	66.90	38.80
4	*5745.00	94.6 AV			1.08 V	2	55.80	38.80
5	11490.00	58.3 PK	74.0	-15.7	1.20 V	206	8.90	49.40
6	11490.00	45.6 AV	54.0	-8.4	1.20 V	206	-3.80	49.40

REMARKS:

1. Emission level (dBuV/m) = Raw Value (dBuV) + Correction Factor (dB/m).
2. Correction Factor (dB/m) = Antenna Factor (dB/m) + Cable Factor (dB).
3. The other emission levels were very low against the limit.
4. Margin value = Emission level – Limit value.
5. “ \* “: Fundamental frequency.
6. The limit value is defined as per 15.247.
7. "#":The radiated frequency is out the restricted band.



A D T

EUT TEST CONDITION		MEASUREMENT DETAIL	
CHANNEL	Channel 157	FREQUENCY RANGE	1 ~ 40GHz
INPUT POWER (SYSTEM)	120Vac, 60Hz	DETECTOR FUNCTION	Peak (PK) Average (AV)
ENVIRONMENTAL CONDITIONS	25deg. C, 68%RH	TESTED BY	Antony Lee
TEST MODE	B 1		

ANTENNA POLARITY & TEST DISTANCE: HORIZONTAL AT 3 M								
NO.	FREQ. (MHz)	EMISSION LEVEL (dBuV/m)	LIMIT (dBuV/m)	MARGIN (dB)	ANTENNA HEIGHT (m)	TABLE ANGLE (Degree)	RAW VALUE (dBuV)	CORRECTION FACTOR (dB/m)
1	*5785.00	98.6 PK			1.44 H	306	59.70	38.90
2	*5785.00	88.2 AV			1.44 H	306	49.30	38.90
3	7713.00	56.3 PK	74.0	-17.7	1.00 H	236	12.00	44.30
4	7713.00	42.5 AV	54.0	-11.5	1.00 H	236	-1.80	44.30
5	11570.00	58.2 PK	74.0	-15.8	1.02 H	45	9.00	49.20
6	11570.00	45.6 AV	54.0	-8.4	1.02 H	45	-3.60	49.20

ANTENNA POLARITY & TEST DISTANCE: VERTICAL AT 3 M								
NO.	FREQ. (MHz)	EMISSION LEVEL (dBuV/m)	LIMIT (dBuV/m)	MARGIN (dB)	ANTENNA HEIGHT (m)	TABLE ANGLE (Degree)	RAW VALUE (dBuV)	CORRECTION FACTOR (dB/m)
1	*5785.00	104.1 PK			1.00 V	339	65.20	38.90
2	*5785.00	93.0 AV			1.00 V	339	54.10	38.90
3	7713.00	57.2 PK	74.0	-16.8	1.00 V	166	12.90	44.30
4	7713.00	43.8 AV	54.0	-10.2	1.00 V	166	-0.50	44.30
5	11570.00	58.3 PK	74.0	-15.7	1.00 V	165	9.10	49.20
6	11570.00	45.2 AV	54.0	-8.8	1.00 V	165	-4.00	49.20

**REMARKS:**

1. Emission level (dBuV/m) = Raw Value (dBuV) + Correction Factor (dB/m).
2. Correction Factor (dB/m) = Antenna Factor (dB/m) + Cable Factor (dB).
3. The other emission levels were very low against the limit.
4. Margin value = Emission level – Limit value.
5. “ \* “: Fundamental frequency.
6. The limit value is defined as per 15.247.



A D T

EUT TEST CONDITION		MEASUREMENT DETAIL	
CHANNEL	Channel 165	FREQUENCY RANGE	1 ~ 40GHz
INPUT POWER (SYSTEM)	120Vac, 60Hz	DETECTOR FUNCTION	Peak (PK) Average (AV)
ENVIRONMENTAL CONDITIONS	25deg. C, 68%RH	TESTED BY	Antony Lee
TEST MODE	B 1		

ANTENNA POLARITY & TEST DISTANCE: HORIZONTAL AT 3 M								
NO.	FREQ. (MHz)	EMISSION LEVEL (dBuV/m)	LIMIT (dBuV/m)	MARGIN (dB)	ANTENNA HEIGHT (m)	TABLE ANGLE (Degree)	RAW VALUE (dBuV)	CORRECTION FACTOR (dB/m)
1	*5825.00	97.8 PK			1.25 H	345	58.90	38.90
2	*5825.00	87.5 AV			1.25 H	345	48.60	38.90
3	#5850.00	53.0 PK	77.8	-24.8	1.25 H	345	14.00	39.00
4	#5850.00	38.1 AV	67.5	-29.4	1.25 H	345	-0.90	39.00
5	11650.00	59.4 PK	74.0	-14.6	1.25 H	325	10.30	49.10
6	11650.00	46.7 AV	54.0	-7.3	1.25 H	325	-2.40	49.10
ANTENNA POLARITY & TEST DISTANCE: VERTICAL AT 3 M								
NO.	FREQ. (MHz)	EMISSION LEVEL (dBuV/m)	LIMIT (dBuV/m)	MARGIN (dB)	ANTENNA HEIGHT (m)	TABLE ANGLE (Degree)	RAW VALUE (dBuV)	CORRECTION FACTOR (dB/m)
1	*5825.00	104.5 PK			1.00 V	47	65.60	38.90
2	*5825.00	93.4 AV			1.00 V	47	54.50	38.90
3	#5850.00	57.8 PK	84.5	-26.7	1.00 V	47	18.80	39.00
4	#5850.00	41.5 AV	73.4	-31.9	1.00 V	47	2.50	39.00
5	11650.00	59.5 PK	74.0	-14.5	1.15 V	214	10.40	49.10
6	11650.00	46.7 AV	54.0	-7.3	1.15 V	214	-2.40	49.10

**REMARKS:**

1. Emission level (dBuV/m) = Raw Value (dBuV) + Correction Factor (dB/m).
2. Correction Factor (dB/m) = Antenna Factor (dB/m) + Cable Factor (dB).
3. The other emission levels were very low against the limit.
4. Margin value = Emission level – Limit value.
5. “ \* “: Fundamental frequency.
6. The limit value is defined as per 15.247.
7. “#”:The radiated frequency is out the restricted band.



A D T

802.11n (40MHz)

EUT TEST CONDITION		MEASUREMENT DETAIL	
CHANNEL	Channel 151	FREQUENCY RANGE	1 ~ 40GHz
INPUT POWER (SYSTEM)	120Vac, 60Hz	DETECTOR FUNCTION	Peak (PK) Average (AV)
ENVIRONMENTAL CONDITIONS	25deg. C, 68%RH	TESTED BY	Antony Lee
TEST MODE	B 1		

ANTENNA POLARITY & TEST DISTANCE: HORIZONTAL AT 3 M								
NO.	FREQ. (MHz)	EMISSION LEVEL (dBuV/m)	LIMIT (dBuV/m)	MARGIN (dB)	ANTENNA HEIGHT (m)	TABLE ANGLE (Degree)	RAW VALUE (dBuV)	CORRECTION FACTOR (dB/m)
1	#5725.00	51.3 PK	77.1	-25.8	1.00 H	356	12.60	38.70
2	#5725.00	37.1 AV	66.9	-29.8	1.00 H	356	-1.60	38.70
3	*5755.00	97.1 PK			1.00 H	356	58.30	38.80
4	*5755.00	86.9 AV			1.00 H	356	48.10	38.80
5	11510.00	57.5 PK	74.0	-16.5	1.00 H	26	8.10	49.40
6	11510.00	44.8 AV	54.0	-9.2	1.00 H	26	-4.60	49.40

ANTENNA POLARITY & TEST DISTANCE: VERTICAL AT 3 M								
NO.	FREQ. (MHz)	EMISSION LEVEL (dBuV/m)	LIMIT (dBuV/m)	MARGIN (dB)	ANTENNA HEIGHT (m)	TABLE ANGLE (Degree)	RAW VALUE (dBuV)	CORRECTION FACTOR (dB/m)
1	#5725.00	61.1 PK	85.5	-24.4	1.08 V	3	22.40	38.70
2	#5725.00	44.1 AV	74.7	-30.6	1.08 V	3	5.40	38.70
3	*5755.00	105.5 PK			1.08 V	1	66.70	38.80
4	*5755.00	94.7 AV			1.08 V	1	55.90	38.80
5	11510.00	59.6 PK	74.0	-14.4	1.00 V	144	10.20	49.40
6	11510.00	46.3 AV	54.0	-7.7	1.00 V	144	-3.10	49.40

REMARKS:

1. Emission level (dBuV/m) = Raw Value (dBuV) + Correction Factor (dB/m).
2. Correction Factor (dB/m) = Antenna Factor (dB/m) + Cable Factor (dB).
3. The other emission levels were very low against the limit.
4. Margin value = Emission level – Limit value.
5. “ \* “: Fundamental frequency.
6. The limit value is defined as per 15.247.
7. "#":The radiated frequency is out the restricted band.





A D T

EUT TEST CONDITION		MEASUREMENT DETAIL	
CHANNEL	Channel 159	FREQUENCY RANGE	1 ~ 40GHz
INPUT POWER (SYSTEM)	120Vac, 60Hz	DETECTOR FUNCTION	Peak (PK) Average (AV)
ENVIRONMENTAL CONDITIONS	25deg. C, 68%RH	TESTED BY	Antony Lee
TEST MODE	B 1		

ANTENNA POLARITY & TEST DISTANCE: HORIZONTAL AT 3 M								
NO.	FREQ. (MHz)	EMISSION LEVEL (dBuV/m)	LIMIT (dBuV/m)	MARGIN (dB)	ANTENNA HEIGHT (m)	TABLE ANGLE (Degree)	RAW VALUE (dBuV)	CORRECTION FACTOR (dB/m)
1	*5795.00	97.3 PK			1.01 H	324	58.40	38.90
2	*5795.00	87.3 AV			1.01 H	324	48.40	38.90
3	#5850.00	48.5 PK	77.3	-28.8	1.01 H	324	9.50	39.00
4	#5850.00	38.7 AV	67.3	-28.6	1.01 H	324	-0.30	39.00
5	11590.00	57.0 PK	74.0	-17.0	1.48 H	96	7.90	49.10
6	11590.00	44.2 AV	54.0	-9.8	1.48 H	96	-4.90	49.10

ANTENNA POLARITY & TEST DISTANCE: VERTICAL AT 3 M								
NO.	FREQ. (MHz)	EMISSION LEVEL (dBuV/m)	LIMIT (dBuV/m)	MARGIN (dB)	ANTENNA HEIGHT (m)	TABLE ANGLE (Degree)	RAW VALUE (dBuV)	CORRECTION FACTOR (dB/m)
1	*5795.00	102.8 PK			1.00 V	45	63.90	38.90
2	*5795.00	92.6 AV			1.00 V	45	53.70	38.90
3	#5850.00	49.8 PK	82.8	-33.0	1.00 V	45	10.80	39.00
4	#5850.00	41.3 AV	72.6	-31.3	1.00 V	45	2.30	39.00
5	11590.00	60.5 PK	74.0	-13.5	1.00 V	214	11.40	49.10
6	11590.00	48.7 AV	54.0	-5.3	1.00 V	214	-0.40	49.10

**REMARKS:**

1. Emission level (dBuV/m) = Raw Value (dBuV) + Correction Factor (dB/m).
2. Correction Factor (dB/m) = Antenna Factor (dB/m) + Cable Factor (dB).
3. The other emission levels were very low against the limit.
4. Margin value = Emission level – Limit value.
5. “ \* “: Fundamental frequency.
6. The limit value is defined as per 15.247.
7. “#”:The radiated frequency is out the restricted band.



A D T

### Monopole Antenna\_2TX

### 802.11n (20MHz)

EUT TEST CONDITION		MEASUREMENT DETAIL	
CHANNEL	Channel 149	FREQUENCY RANGE	1 ~ 40GHz
INPUT POWER (SYSTEM)	120Vac, 60Hz	DETECTOR FUNCTION	Peak (PK) Average (AV)
ENVIRONMENTAL CONDITIONS	25deg. C, 68%RH	TESTED BY	Antony Lee
TEST MODE	B 2		

ANTENNA POLARITY & TEST DISTANCE: HORIZONTAL AT 3 M								
NO.	FREQ. (MHz)	EMISSION LEVEL (dBuV/m)	LIMIT (dBuV/m)	MARGIN (dB)	ANTENNA HEIGHT (m)	TABLE ANGLE (Degree)	RAW VALUE (dBuV)	CORRECTION FACTOR (dB/m)
1	#5725.00	58.3 PK	75.1	-16.8	1.00 H	211	19.60	38.70
2	#5725.00	43.9 AV	64.9	-21.0	1.00 H	211	5.20	38.70
3	*5745.00	95.1 PK			1.00 H	211	56.30	38.80
4	*5745.00	84.9 AV			1.00 H	211	46.10	38.80
5	11490.00	57.3 PK	74.0	-16.7	1.00 H	258	7.90	49.40
6	11490.00	44.8 AV	54.0	-9.2	1.00 H	258	-4.60	49.40
ANTENNA POLARITY & TEST DISTANCE: VERTICAL AT 3 M								
NO.	FREQ. (MHz)	EMISSION LEVEL (dBuV/m)	LIMIT (dBuV/m)	MARGIN (dB)	ANTENNA HEIGHT (m)	TABLE ANGLE (Degree)	RAW VALUE (dBuV)	CORRECTION FACTOR (dB/m)
1	#5725.00	67.1 PK	84.9	-17.8	1.00 V	21	28.40	38.70
2	#5725.00	52.7 AV	73.1	-20.4	1.00 V	21	14.00	38.70
3	*5745.00	104.9 PK			1.00 V	21	66.10	38.80
4	*5745.00	93.1 AV			1.00 V	21	54.30	38.80
5	11490.00	59.6 PK	74.0	-14.4	1.00 V	166	10.20	49.40
6	11490.00	47.3 AV	54.0	-6.7	1.00 V	166	-2.10	49.40

#### REMARKS:

1. Emission level (dBuV/m) = Raw Value (dBuV) + Correction Factor (dB/m).
2. Correction Factor (dB/m) = Antenna Factor (dB/m) + Cable Factor (dB).
3. The other emission levels were very low against the limit.
4. Margin value = Emission level – Limit value.
5. " \* ": Fundamental frequency.
6. The limit value is defined as per 15.247.
7. "#":The radiated frequency is out the restricted band.



A D T

EUT TEST CONDITION		MEASUREMENT DETAIL	
CHANNEL	Channel 157	FREQUENCY RANGE	1 ~ 40GHz
INPUT POWER (SYSTEM)	120Vac, 60Hz	DETECTOR FUNCTION	Peak (PK) Average (AV)
ENVIRONMENTAL CONDITIONS	25deg. C, 68%RH	TESTED BY	Antony Lee
TEST MODE	B 2		

ANTENNA POLARITY & TEST DISTANCE: HORIZONTAL AT 3 M								
NO.	FREQ. (MHz)	EMISSION LEVEL (dBuV/m)	LIMIT (dBuV/m)	MARGIN (dB)	ANTENNA HEIGHT (m)	TABLE ANGLE (Degree)	RAW VALUE (dBuV)	CORRECTION FACTOR (dB/m)
1	*5785.00	96.9 PK			1.00 H	344	58.00	38.90
2	*5785.00	85.9 AV			1.00 H	344	47.00	38.90
3	7713.00	57.6 PK	74.0	-16.4	1.00 H	188	13.30	44.30
4	7713.00	43.8 AV	54.0	-10.2	1.00 H	188	-0.50	44.30
5	11570.00	62.3 PK	74.0	-11.7	1.00 H	254	13.10	49.20
6	11570.00	47.8 AV	54.0	-6.2	1.00 H	254	-1.40	49.20
ANTENNA POLARITY & TEST DISTANCE: VERTICAL AT 3 M								
NO.	FREQ. (MHz)	EMISSION LEVEL (dBuV/m)	LIMIT (dBuV/m)	MARGIN (dB)	ANTENNA HEIGHT (m)	TABLE ANGLE (Degree)	RAW VALUE (dBuV)	CORRECTION FACTOR (dB/m)
1	*5785.00	104.3 PK			1.29 V	15	65.40	38.90
2	*5785.00	93.1 AV			1.29 V	15	54.20	38.90
3	7713.00	56.8 PK	74.0	-17.2	1.00 V	151	12.50	44.30
4	7713.00	43.9 AV	54.0	-10.1	1.00 V	151	-0.40	44.30
5	11570.00	59.6 PK	74.0	-14.4	1.00 V	128	10.40	49.20
6	11570.00	46.9 AV	54.0	-7.1	1.00 V	128	-2.30	49.20

**REMARKS:**

1. Emission level (dBuV/m) = Raw Value (dBuV) + Correction Factor (dB/m).
2. Correction Factor (dB/m) = Antenna Factor (dB/m) + Cable Factor (dB).
3. The other emission levels were very low against the limit.
4. Margin value = Emission level – Limit value.
5. “ \* “: Fundamental frequency.
6. The limit value is defined as per 15.247.



A D T

EUT TEST CONDITION		MEASUREMENT DETAIL	
CHANNEL	Channel 165	FREQUENCY RANGE	1 ~ 40GHz
INPUT POWER (SYSTEM)	120Vac, 60Hz	DETECTOR FUNCTION	Peak (PK) Average (AV)
ENVIRONMENTAL CONDITIONS	25deg. C, 68%RH	TESTED BY	Antony Lee
TEST MODE	B 2		

ANTENNA POLARITY & TEST DISTANCE: HORIZONTAL AT 3 M								
NO.	FREQ. (MHz)	EMISSION LEVEL (dBuV/m)	LIMIT (dBuV/m)	MARGIN (dB)	ANTENNA HEIGHT (m)	TABLE ANGLE (Degree)	RAW VALUE (dBuV)	CORRECTION FACTOR (dB/m)
1	*5825.00	97.3 PK			1.25 H	343	58.40	38.90
2	*5825.00	86.3 AV			1.25 H	343	47.40	38.90
3	#5850.00	50.2 PK	77.3	-27.1	1.25 H	343	11.20	39.00
4	#5850.00	37.0 AV	66.3	-29.3	1.25 H	343	-2.00	39.00
5	11650.00	60.4 PK	74.0	-13.6	1.00 H	255	11.30	49.10
6	11650.00	46.3 AV	54.0	-7.7	1.00 H	255	-2.80	49.10
ANTENNA POLARITY & TEST DISTANCE: VERTICAL AT 3 M								
NO.	FREQ. (MHz)	EMISSION LEVEL (dBuV/m)	LIMIT (dBuV/m)	MARGIN (dB)	ANTENNA HEIGHT (m)	TABLE ANGLE (Degree)	RAW VALUE (dBuV)	CORRECTION FACTOR (dB/m)
1	*5825.00	104.1 PK			1.00 V	47	65.20	38.90
2	*5825.00	92.7 AV			1.00 V	47	53.80	38.90
3	#5850.00	54.7 PK	84.1	-29.4	1.00 V	47	15.70	39.00
4	#5850.00	40.6 AV	72.7	-32.1	1.00 V	47	1.60	39.00
5	11650.00	60.2 PK	74.0	-13.8	1.00 V	214	11.10	49.10
6	11650.00	47.6 AV	54.0	-6.4	1.00 V	214	-1.50	49.10

**REMARKS:**

1. Emission level (dBuV/m) = Raw Value (dBuV) + Correction Factor (dB/m).
2. Correction Factor (dB/m) = Antenna Factor (dB/m) + Cable Factor (dB).
3. The other emission levels were very low against the limit.
4. Margin value = Emission level – Limit value.
5. “ \* “: Fundamental frequency.
6. The limit value is defined as per 15.247.
7. “#”:The radiated frequency is out the restricted band.



A D T

802.11n (40MHz)

EUT TEST CONDITION		MEASUREMENT DETAIL	
CHANNEL	Channel 151	FREQUENCY RANGE	1 ~ 40GHz
INPUT POWER (SYSTEM)	120Vac, 60Hz	DETECTOR FUNCTION	Peak (PK) Average (AV)
ENVIRONMENTAL CONDITIONS	25deg. C, 68%RH	TESTED BY	Antony Lee
TEST MODE	B 2		

ANTENNA POLARITY & TEST DISTANCE: HORIZONTAL AT 3 M								
NO.	FREQ. (MHz)	EMISSION LEVEL (dBuV/m)	LIMIT (dBuV/m)	MARGIN (dB)	ANTENNA HEIGHT (m)	TABLE ANGLE (Degree)	RAW VALUE (dBuV)	CORRECTION FACTOR (dB/m)
1	#5725.00	46.3 PK	74.2	-27.9	1.58 H	342	7.60	38.70
2	#5725.00	35.2 AV	62.8	-27.6	1.58 H	342	-3.50	38.70
3	*5755.00	94.2 PK			1.58 H	342	55.40	38.80
4	*5755.00	82.8 AV			1.58 H	342	44.00	38.80
5	11510.00	59.6 PK	74.0	-14.4	1.00 H	34	10.20	49.40
6	11510.00	47.3 AV	54.0	-6.7	1.00 H	34	-2.10	49.40
ANTENNA POLARITY & TEST DISTANCE: VERTICAL AT 3 M								
NO.	FREQ. (MHz)	EMISSION LEVEL (dBuV/m)	LIMIT (dBuV/m)	MARGIN (dB)	ANTENNA HEIGHT (m)	TABLE ANGLE (Degree)	RAW VALUE (dBuV)	CORRECTION FACTOR (dB/m)
1	#5725.00	52.2 PK	83.4	-31.2	1.07 V	20	13.50	38.70
2	#5725.00	38.1 AV	72.0	-33.9	1.07 V	20	-0.60	38.70
3	*5755.00	103.4 PK			1.21 V	5	64.60	38.80
4	*5755.00	92.0 AV			1.21 V	5	53.20	38.80
5	11510.00	60.2 PK	74.0	-13.8	1.00 V	139	10.80	49.40
6	11510.00	47.4 AV	54.0	-6.6	1.00 V	139	-2.00	49.40

REMARKS:

1. Emission level (dBuV/m) = Raw Value (dBuV) + Correction Factor (dB/m).
2. Correction Factor (dB/m) = Antenna Factor (dB/m) + Cable Factor (dB).
3. The other emission levels were very low against the limit.
4. Margin value = Emission level – Limit value.
5. “ \* “: Fundamental frequency.
6. The limit value is defined as per 15.247.
7. "#":The radiated frequency is out the restricted band.



A D T

EUT TEST CONDITION		MEASUREMENT DETAIL	
CHANNEL	Channel 159	FREQUENCY RANGE	1 ~ 40GHz
INPUT POWER (SYSTEM)	120Vac, 60Hz	DETECTOR FUNCTION	Peak (PK) Average (AV)
ENVIRONMENTAL CONDITIONS	25deg. C, 68%RH	TESTED BY	Antony Lee
TEST MODE	B 2		

ANTENNA POLARITY & TEST DISTANCE: HORIZONTAL AT 3 M								
NO.	FREQ. (MHz)	EMISSION LEVEL (dBuV/m)	LIMIT (dBuV/m)	MARGIN (dB)	ANTENNA HEIGHT (m)	TABLE ANGLE (Degree)	RAW VALUE (dBuV)	CORRECTION FACTOR (dB/m)
1	*5795.00	97.8 PK			1.57 H	307	58.90	38.90
2	*5795.00	86.9 AV			1.57 H	307	48.00	38.90
3	#5850.00	49.7 PK	77.8	-28.1	1.57 H	307	10.70	39.00
4	#5850.00	37.5 AV	66.9	-29.4	1.57 H	307	-1.50	39.00
5	11590.00	60.3 PK	74.0	-13.7	1.00 H	256	11.20	49.10
6	11590.00	45.8 AV	54.0	-8.2	1.00 H	256	-3.30	49.10
ANTENNA POLARITY & TEST DISTANCE: VERTICAL AT 3 M								
NO.	FREQ. (MHz)	EMISSION LEVEL (dBuV/m)	LIMIT (dBuV/m)	MARGIN (dB)	ANTENNA HEIGHT (m)	TABLE ANGLE (Degree)	RAW VALUE (dBuV)	CORRECTION FACTOR (dB/m)
1	*5795.00	103.3 PK			1.08 V	29	64.40	38.90
2	*5795.00	92.3 AV			1.08 V	29	53.40	38.90
3	#5850.00	52.4 PK	83.3	-30.9	1.08 V	29	13.40	39.00
4	#5850.00	40.8 AV	72.3	-31.5	1.08 V	29	1.80	39.00
5	11590.00	62.4 PK	74.0	-11.6	1.00 V	214	13.30	49.10
6	11590.00	48.6 AV	54.0	-5.4	1.00 V	214	-0.50	49.10

**REMARKS:**

1. Emission level (dBuV/m) = Raw Value (dBuV) + Correction Factor (dB/m).
2. Correction Factor (dB/m) = Antenna Factor (dB/m) + Cable Factor (dB).
3. The other emission levels were very low against the limit.
4. Margin value = Emission level – Limit value.
5. “ \* “: Fundamental frequency.
6. The limit value is defined as per 15.247.
7. “#“: The radiated frequency is out the restricted band.



A D T

**BELOW 1GHz WORST-CASE DATA : 802.11n (20MHz)**

**PIFA Antenna\_2TX**

EUT TEST CONDITION		MEASUREMENT DETAIL	
CHANNEL	Channel 149	FREQUENCY RANGE	Below 1000MHz
INPUT POWER (SYSTEM)	120Vac, 60Hz	DETECTOR FUNCTION	Quasi-Peak
ENVIRONMENTAL CONDITIONS	25deg. C, 67%RH	TESTED BY	Cedric Wu
TEST MODE	A 2		

ANTENNA POLARITY & TEST DISTANCE: HORIZONTAL AT 3 M								
NO.	FREQ. (MHz)	EMISSION LEVEL (dBuV/m)	LIMIT (dBuV/m)	MARGIN (dB)	ANTENNA HEIGHT (m)	TABLE ANGLE (Degree)	RAW VALUE (dBuV)	CORRECTION FACTOR (dB/m)
1	185.13	39.4 QP	43.5	-4.1	1.25 H	278	27.30	12.10
2	198.71	38.9 QP	43.5	-4.6	1.75 H	99	28.00	10.90
3	359.77	32.2 QP	46.0	-13.8	1.00 H	346	16.00	16.20
4	480.07	32.7 QP	46.0	-13.3	1.75 H	235	13.70	19.00
5	792.48	36.7 QP	46.0	-9.3	1.00 H	145	12.30	24.40
6	947.71	38.7 QP	46.0	-7.3	1.00 H	61	12.50	26.20
ANTENNA POLARITY & TEST DISTANCE: VERTICAL AT 3 M								
NO.	FREQ. (MHz)	EMISSION LEVEL (dBuV/m)	LIMIT (dBuV/m)	MARGIN (dB)	ANTENNA HEIGHT (m)	TABLE ANGLE (Degree)	RAW VALUE (dBuV)	CORRECTION FACTOR (dB/m)
1	181.25	33.4 QP	43.5	-10.1	1.49 V	6	21.00	12.40
2	443.21	33.0 QP	46.0	-13.0	1.99 V	205	14.90	18.10
3	499.48	34.0 QP	46.0	-12.0	1.49 V	6	14.50	19.50
4	751.73	38.9 QP	46.0	-7.1	1.25 V	212	15.50	23.40
5	837.11	37.7 QP	46.0	-8.3	1.49 V	6	12.60	25.10
6	947.71	39.5 QP	46.0	-6.5	1.00 V	285	13.30	26.20

**REMARKS:**

1. Emission level (dBuV/m) = Raw Value (dBuV) + Correction Factor (dB/m).
2. Correction Factor (dB/m) = Antenna Factor (dB/m) + Cable Factor (dB).
3. The other emission levels were very low against the limit.
4. Margin value = Emission level – Limit value.



A D T

Monopole Antenna\_2TX

EUT TEST CONDITION		MEASUREMENT DETAIL	
CHANNEL	Channel 149	FREQUENCY RANGE	Below 1000MHz
INPUT POWER (SYSTEM)	120Vac, 60Hz	DETECTOR FUNCTION	Quasi-Peak
ENVIRONMENTAL CONDITIONS	24deg. C, 64%RH	TESTED BY	Match Tsui
TEST MODE	B 2		

ANTENNA POLARITY & TEST DISTANCE: HORIZONTAL AT 3 M								
NO.	FREQ. (MHz)	EMISSION LEVEL (dBuV/m)	LIMIT (dBuV/m)	MARGIN (dB)	ANTENNA HEIGHT (m)	TABLE ANGLE (Degree)	RAW VALUE (dBuV)	CORRECTION FACTOR (dB/m)
1	74.62	31.1 QP	40.0	-8.9	1.50 H	12	19.90	11.20
2	231.76	34.0 QP	46.0	-12.0	1.00 H	110	21.70	12.30
3	260.86	34.6 QP	46.0	-11.4	1.00 H	127	21.20	13.40
4	373.38	32.7 QP	46.0	-13.3	1.00 H	113	15.90	16.80
5	522.76	35.0 QP	46.0	-11.0	1.50 H	119	14.30	20.70
6	823.46	31.3 QP	46.0	-14.7	1.50 H	127	5.70	25.60
ANTENNA POLARITY & TEST DISTANCE: VERTICAL AT 3 M								
NO.	FREQ. (MHz)	EMISSION LEVEL (dBuV/m)	LIMIT (dBuV/m)	MARGIN (dB)	ANTENNA HEIGHT (m)	TABLE ANGLE (Degree)	RAW VALUE (dBuV)	CORRECTION FACTOR (dB/m)
1	74.62	32.8 QP	40.0	-7.2	1.50 V	359	21.60	11.20
2	260.86	34.2 QP	46.0	-11.8	2.00 V	202	20.80	13.40
3	297.72	35.7 QP	46.0	-10.3	1.50 V	154	20.90	14.80
4	336.52	37.5 QP	46.0	-8.5	1.50 V	189	21.60	15.90
5	524.70	38.0 QP	46.0	-8.0	1.00 V	36	17.30	20.70
6	598.42	34.1 QP	46.0	-11.9	1.50 V	152	11.70	22.40

REMARKS:

1. Emission level (dBuV/m) = Raw Value (dBuV) + Correction Factor (dB/m).
2. Correction Factor (dB/m) = Antenna Factor (dB/m) + Cable Factor (dB).
3. The other emission levels were very low against the limit.
4. Margin value = Emission level – Limit value.





A D T

## 5.2 CONDUCTED EMISSION MEASUREMENT

### 5.2.1 LIMITS OF CONDUCTED EMISSION MEASUREMENT

FREQUENCY OF EMISSION (MHz)	CONDUCTED LIMIT (dB $\mu$ V)	
	Quasi-peak	Average
0.15 ~ 0.5	66 to 56	56 to 46
0.5 ~ 5	56	46
5 ~ 30	60	50

- NOTE:** 1. The lower limit shall apply at the transition frequencies.  
2. The limit decreases in line with the logarithm of the frequency in the range of 0.15 to 0.50MHz.  
3. All emanations from a class A/B digital device or system, including any network of conductors and apparatus connected thereto, shall not exceed the level of field strengths specified above.

### 5.2.2 TEST INSTRUMENTS

Same as item 4.2.2.

### 5.2.3 TEST PROCEDURES

Same as item 4.2.3.

### 5.2.4 DEVIATION FROM TEST STANDARD

No deviation.

### 5.2.5 TEST SETUP

Same as item 4.2.5.

### 5.2.6 EUT OPERATING CONDITIONS

Same as 4.1.6

### 5.2.7 TEST RESULTS

CONDUCTED WORST-CASE DATA : 802.11n (20MHz)

PIFA Antenna\_2TX

PHASE	Line 1	6dB BANDWIDTH	9kHz
TEST MODE	A 2		

No	Freq. [MHz]	Corr.	Reading Value		Emission Level		Limit		Margin	
		Factor	[dB (uV)]		[dB (uV)]		[dB (uV)]		(dB)	
		(dB)	Q.P.	AV.	Q.P.	AV.	Q.P.	AV.	Q.P.	AV.
1	0.17346	0.21	37.33	28.19	37.54	28.40	64.79	54.79	-27.25	-26.39
2	0.32357	0.23	44.91	39.03	45.14	39.26	59.61	49.61	-14.47	-10.35
3	0.86162	0.29	30.52	17.03	30.81	17.32	56.00	46.00	-25.19	-28.68
4	1.71791	0.33	18.01	9.52	18.34	9.85	56.00	46.00	-37.66	-36.15
5	2.89482	0.38	16.10	9.87	16.48	10.25	56.00	46.00	-39.52	-35.75
6	7.34831	0.48	12.02	5.64	12.50	6.12	60.00	50.00	-47.50	-43.88

**REMARKS:**

1. Q.P. and AV. are abbreviations of quasi-peak and average individually.
2. The emission levels of other frequencies were very low against the limit.
3. Margin value = Emission level - Limit value
4. Correction factor = Insertion loss + Cable loss
5. Emission Level = Correction Factor + Reading Value.

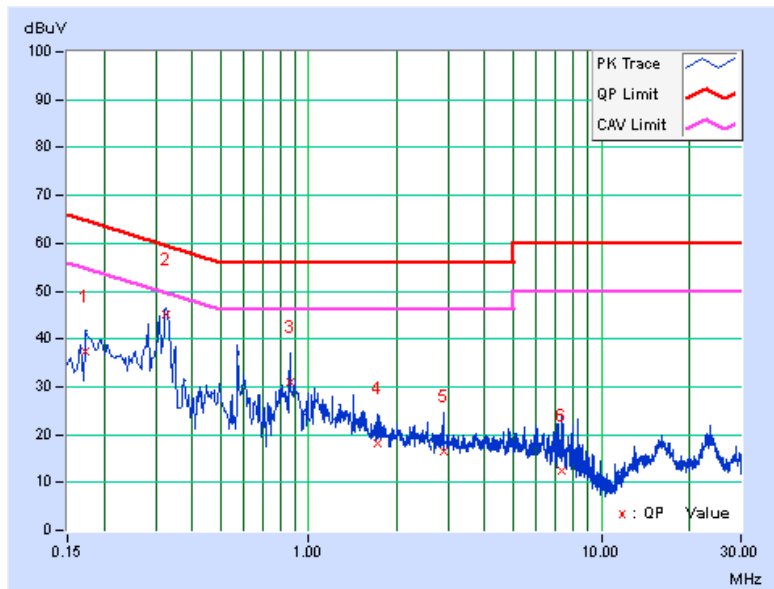



A D T

PHASE	Line 2	6dB BANDWIDTH	9kHz
TEST MODE	A 2		

No	Freq. [MHz]	Corr. Factor (dB)	Reading Value		Emission Level		Limit		Margin	
			[dB (uV)]		[dB (uV)]		[dB (uV)]		(dB)	
			Q.P.	AV.	Q.P.	AV.	Q.P.	AV.	Q.P.	AV.
1	0.19459	0.20	36.78	30.39	36.98	30.59	63.84	53.84	-26.86	-23.25
2	0.29858	0.21	42.78	33.04	42.99	33.25	60.28	50.28	-17.29	-17.03
<b>3</b>	<b>0.32614</b>	<b>0.21</b>	<b>45.58</b>	<b>41.87</b>	<b>45.79</b>	<b>42.08</b>	<b>59.55</b>	<b>49.55</b>	<b>-13.76</b>	<b>-7.47</b>
4	0.84989	0.26	28.94	19.46	29.20	19.72	56.00	46.00	-26.80	-26.28
5	6.28870	0.50	15.51	9.33	16.01	9.83	60.00	50.00	-43.99	-40.17
6	16.99037	0.80	12.40	8.94	13.20	9.74	60.00	50.00	-46.80	-40.26

**REMARKS:**

1. Q.P. and AV. are abbreviations of quasi-peak and average individually.
2. The emission levels of other frequencies were very low against the limit.
3. Margin value = Emission level - Limit value
4. Correction factor = Insertion loss + Cable loss
5. Emission Level = Correction Factor + Reading Value.

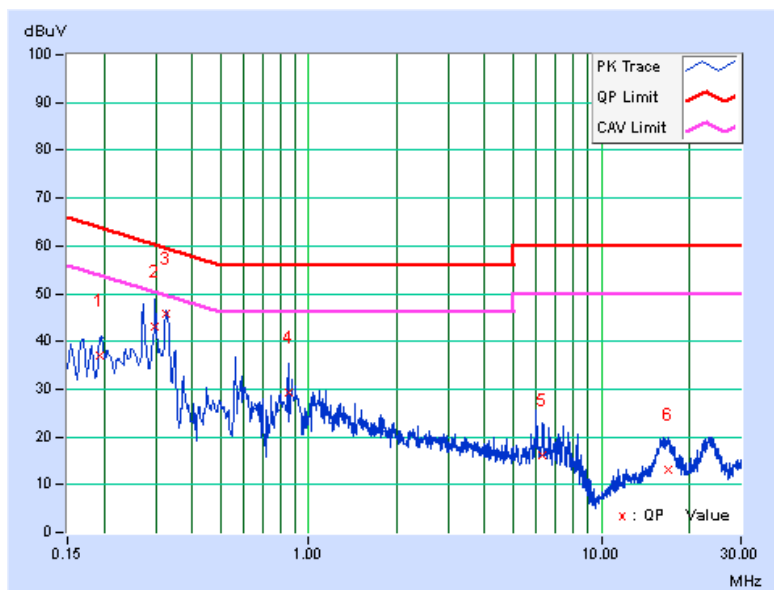

**Monopole Antenna\_2TX**

<b>PHASE</b>	Line 1	<b>6dB BANDWIDTH</b>	9kHz
<b>TEST MODE</b>	B 2		

No	Freq. [MHz]	Corr. Factor (dB)	Reading Value		Emission Level		Limit		Margin	
			[dB (uV)]		[dB (uV)]		[dB (uV)]		(dB)	
			Q.P.	AV.	Q.P.	AV.	Q.P.	AV.	Q.P.	AV.
1	0.20851	0.15	43.53	29.28	43.68	29.43	63.26	53.26	-19.58	-23.83
2	0.31797	0.16	30.37	22.48	30.53	22.64	59.76	49.76	-29.23	-27.12
3	0.42189	0.17	25.79	15.09	25.96	15.26	57.41	47.41	-31.45	-32.15
4	1.76953	0.24	35.40	20.95	35.64	21.19	56.00	46.00	-20.36	-24.81
5	3.67188	0.33	27.21	14.55	27.54	14.88	56.00	46.00	-28.46	-31.12
6	10.34766	0.44	32.16	26.44	32.60	26.88	60.00	50.00	-27.40	-23.12

**REMARKS:**

1. Q.P. and AV. are abbreviations of quasi-peak and average individually.
2. The emission levels of other frequencies were very low against the limit.
3. Margin value = Emission level - Limit value
4. Correction factor = Insertion loss + Cable loss
5. Emission Level = Correction Factor + Reading Value.

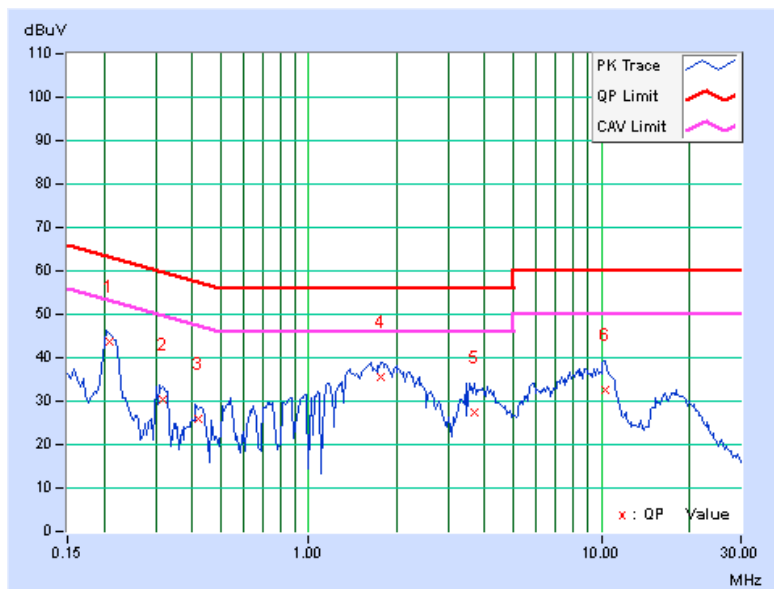



A D T

PHASE	Line 2	6dB BANDWIDTH	9kHz
TEST MODE	B 2		

No	Freq. [MHz]	Corr. Factor (dB)	Reading Value		Emission Level		Limit		Margin	
			[dB (uV)]		[dB (uV)]		[dB (uV)]		(dB)	
			Q.P.	AV.	Q.P.	AV.	Q.P.	AV.	Q.P.	AV.
1	0.20212	0.14	40.70	23.25	40.84	23.39	63.52	53.52	-22.68	-30.13
2	0.30625	0.15	31.06	19.76	31.21	19.91	60.07	50.07	-28.86	-30.16
3	0.41670	0.16	25.87	14.99	26.03	15.15	57.51	47.51	-31.48	-32.36
4	1.62891	0.23	34.22	19.66	34.45	19.89	56.00	46.00	-21.55	-26.11
5	3.74609	0.34	28.85	17.33	29.19	17.67	56.00	46.00	-26.81	-28.33
6	9.87891	0.48	33.46	27.50	33.94	27.98	60.00	50.00	-26.06	-22.02

**REMARKS:**

1. Q.P. and AV. are abbreviations of quasi-peak and average individually.
2. The emission levels of other frequencies were very low against the limit.
3. Margin value = Emission level - Limit value
4. Correction factor = Insertion loss + Cable loss
5. Emission Level = Correction Factor + Reading Value.

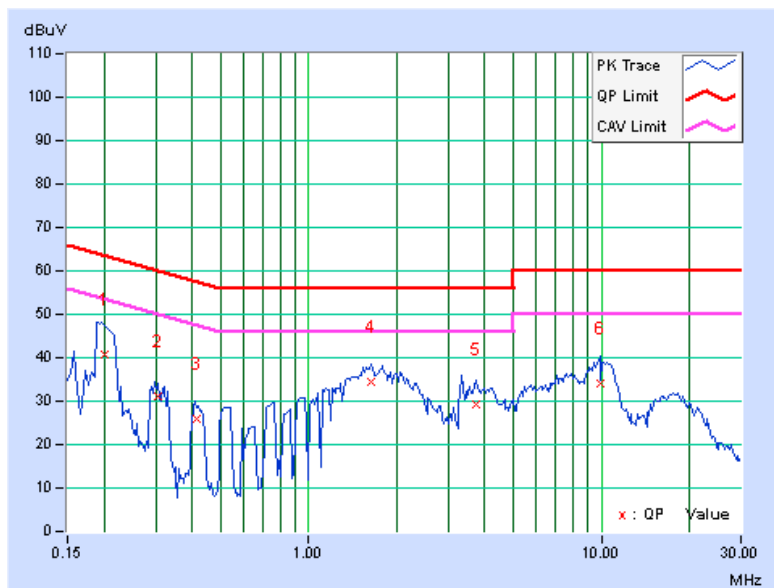



A D T

### **5.3 6dB BANDWIDTH MEASUREMENT**

#### **5.3.1 LIMITS OF 6dB BANDWIDTH MEASUREMENT**

The minimum of 6dB Bandwidth Measurement is 0.5MHz.

#### **5.3.2 TEST SETUP**

Same as item 4.3.2.

#### **5.3.3 TEST INSTRUMENTS**

Refer to section 4.3.3 to get information of above instrument.

#### **5.3.4 TEST PROCEDURE**

Same as item 4.3.4.

#### **5.3.5 DEVIATION FROM TEST STANDARD**

No deviation.

#### **5.3.6 EUT OPERATING CONDITIONS**

Same as item 4.3.6.



### 5.3.7 TEST RESULTS

#### 802.11a

CHANNEL	FREQUENCY (MHz)	6dB BANDWIDTH (MHz)	MINIMUM LIMIT (MHz)	PASS / FAIL
149	5745	16.31	0.5	PASS
157	5785	16.10	0.5	PASS
165	5825	16.11	0.5	PASS

#### 802.11n (20MHz)

##### 1TX

CHANNEL	FREQUENCY (MHz)	6dB BANDWIDTH (MHz)	MINIMUM LIMIT (MHz)	PASS / FAIL
149	5745	16.20	0.5	PASS
157	5785	16.12	0.5	PASS
165	5825	16.10	0.5	PASS

##### 2TX

CHANNEL	FREQUENCY (MHz)	6dB BANDWIDTH (MHz)		MINIMUM LIMIT (MHz)	PASS / FAIL
		CHAIN 0	CHAIN 1		
149	5745	16.38	16.38	0.5	PASS
157	5785	16.38	16.37	0.5	PASS
165	5825	16.59	16.37	0.5	PASS



A D T

802.11n (40MHz)

1TX

CHANNEL	FREQUENCY (MHz)	6dB BANDWIDTH (MHz)	MINIMUM LIMIT (MHz)	PASS / FAIL
151	5755	35.25	0.5	PASS
159	5795	35.59	0.5	PASS

2TX

CHANNEL	FREQUENCY (MHz)	6dB BANDWIDTH (MHz)		MINIMUM LIMIT (MHz)	PASS / FAIL
		CHAIN 0	CHAIN 1		
151	5755	35.44	35.48	0.5	PASS
159	5795	35.48	35.45	0.5	PASS





A D T

## 5.4 CONDUCTED OUTPUT POWER

### 5.4.1 LIMITS OF CONDUCTED OUTPUT POWER MEASUREMENT

For systems using digital modulation in the 5725 –5850 MHz bands: 1 Watt (30dBm)

Per KDB 662911 D01 Multiple Transmitter Output v01r02 Method of conducted output power measurement on IEEE 802.11 devices,

Array Gain = 0 dB (i.e., no array gain) for  $N_{ANT} \leq 4$ ;

Array Gain = 0 dB (i.e., no array gain) for channel widths  $\geq 40$  MHz for any  $N_{ANT}$ ;

Array Gain =  $5 \log(N_{ANT}/N_{SS})$  dB or 3 dB, whichever is less for 20-MHz channel widths with  $N_{ANT} \geq 5$ .

For power measurements on all other devices: Array Gain =  $10 \log(N_{ANT}/N_{SS})$  dB.

### 5.4.2 TEST SETUP

Same as Item 4.4.2.

### 5.4.3 INSTRUMENTS

Refer to section 4.4.3 to get information of above instrument.

### 5.4.4 TEST PROCEDURES

Same as Item 4.4.4.

### 5.4.5 DEVIATION FROM TEST STANDARD

No deviation.

### 5.4.6 EUT OPERATING CONDITIONS

Same as Item 4.3.6.



A D T

## 5.4.7 TEST RESULTS

### 802.11a

CHANNEL	FREQUENCY (MHz)	PEAK POWER (mW)	PEAK POWER (dBm)	LIMIT (dBm)	PASS/FAIL
149	5745	141.906	21.52	30	PASS
157	5785	135.831	21.33	30	PASS
165	5825	138.038	21.40	30	PASS

### 802.11n (20MHz)

#### 1TX

CHANNEL	FREQUENCY (MHz)	PEAK POWER (mW)	PEAK POWER (dBm)	LIMIT (dBm)	PASS/FAIL
149	5745	136.458	21.35	30	PASS
157	5785	135.831	21.33	30	PASS
165	5825	141.254	21.50	30	PASS

#### 2TX

CHAN.	FREQUENCY (MHz)	PEAK POWER (dBm)		TOTAL POWER (mW)	TOTAL POWER (dBm)	LIMIT (dBm)	PASS / FAIL
		CHAIN 0	CHAIN 1				
149	5745	19.26	19.31	169.643	22.30	30	PASS
157	5785	19.30	19.35	<b>171.213</b>	22.34	30	PASS
165	5825	19.12	19.42	169.156	22.28	30	PASS

### 802.11n (40MHz)

#### 1TX

CHANNEL	FREQUENCY (MHz)	PEAK POWER (mW)	PEAK POWER (dBm)	LIMIT (dBm)	PASS/FAIL
151	5755	143.219	21.56	30	PASS
159	5795	148.936	21.73	30	PASS

#### 2TX

CHAN.	FREQUENCY (MHz)	PEAK POWER (dBm)		TOTAL POWER (mW)	TOTAL POWER (dBm)	LIMIT (dBm)	PASS / FAIL
		CHAIN 0	CHAIN 1				
151	5755	17.96	18.05	126.343	21.02	30	PASS
159	5795	18.36	18.00	131.645	21.19	30	PASS



A D T

## **5.5 POWER SPECTRAL DENSITY MEASUREMENT**

### **5.5.1 LIMITS OF POWER SPECTRAL DENSITY MEASUREMENT**

The Maximum of Power Spectral Density Measurement is 8dBm.

### **5.5.2 TEST SETUP**

Same as item 4.5.2.

### **5.5.3 TEST INSTRUMENTS**

Refer to section 4.5.3 to get information of above instrument.

### **5.5.4 TEST PROCEDURE.**

Same as item 4.5.4.

### **5.5.5 DEVIATION FROM TEST STANDARD**

No deviation.

### **5.5.6 EUT OPERATING CONDITION**

Same as item 4.3.6.



A D T

## 5.5.7 TEST RESULTS

### 802.11a

Channel	FREQ. (MHz)	PSD (dBm/3kHz)	Limit (dBm/3kHz)	PASS /FAIL
149	5745	-13.83	8	PASS
157	5785	-12.40	8	PASS
165	5825	-13.42	8	PASS

### 802.11n (20MHz)

#### 1TX

Channel	FREQ. (MHz)	PSD (dBm/3kHz)	Limit (dBm/3kHz)	PASS /FAIL
149	5745	-13.38	8	PASS
157	5785	-13.32	8	PASS
165	5825	-13.08	8	PASS

#### 2TX

TX chain	Channel	FREQ. (MHz)	PSD (dBm/3kHz)	10 log (N=2) dB	Total PSD (dBm/3kHz)	Limit (dBm/3kHz)	PASS /FAIL
0	149	5745	-14.65	3.01	-11.64	8	PASS
	157	5785	-14.18	3.01	-11.17	8	PASS
	165	5825	-15.44	3.01	-12.43	8	PASS
1	149	5745	-15.12	3.01	-12.11	8	PASS
	157	5785	-14.30	3.01	-11.29	8	PASS
	165	5825	-13.77	3.01	-10.76	8	PASS



A D T

### 802.11n (40MHz)

#### 1TX

Channel	FREQ. (MHz)	PSD (dBm/3kHz)	Limit (dBm/3kHz)	PASS /FAIL
151	5755	-12.83	8	PASS
159	5795	-14.52	8	PASS

#### 2TX

TX chain	Channel	FREQ. (MHz)	PSD (dBm/3kHz)	10 log (N=2) dB	Total PSD (dBm/3kHz)	Limit (dBm/3kHz)	PASS /FAIL
0	151	5755	-16.05	3.01	-13.04	8	PASS
	159	5795	-15.45	3.01	-12.44	8	PASS
1	151	5755	-16.02	3.01	-13.01	8	PASS
	159	5795	-15.22	3.01	-12.21	8	PASS



A D T

## 5.6 CONDUCTED OUT OF BAND EMISSION MEASUREMENT

### 5.6.1 LIMITS OF CONDUCTED OUT OF BAND EMISSION MEASUREMENT

Below  $-20\text{dB}$  of the highest emission level of operating band (in 100kHz Resolution Bandwidth).

### 5.6.2 TEST SETUP

Same as Item 4.6.2

### 5.6.3 TEST INSTRUMENTS

Refer to section 4.6.3 to get information of above instrument.

### 5.6.4 TEST PROCEDURE

Same as Item 4.6.4

### 5.6.5 DEVIATION FROM TEST STANDARD

No deviation.

### 5.6.6 EUT OPERATING CONDITION

Same as Item 4.3.6

### 5.6.7 TEST RESULTS

#### **For 1TX**

The spectrum plots are attached on the following pages. D1 line indicates the highest level, and D2 line indicates the 20dB offset below D1. It shows compliance with the requirement.

#### **For 2TX**

The conducted emission test is performed on each TX port of operating mode without summing or adding  $10\log(N)$  since the limit is relative emission limit. Only worst data of each operating mode is presented.

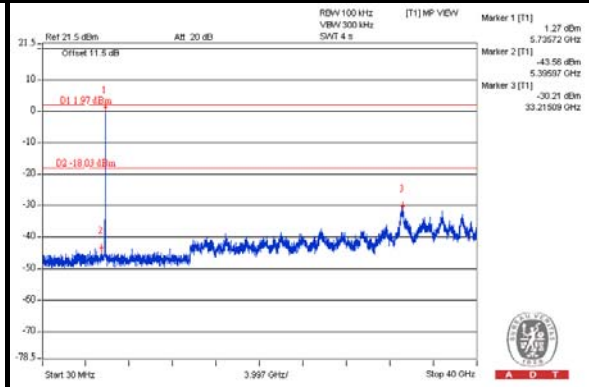
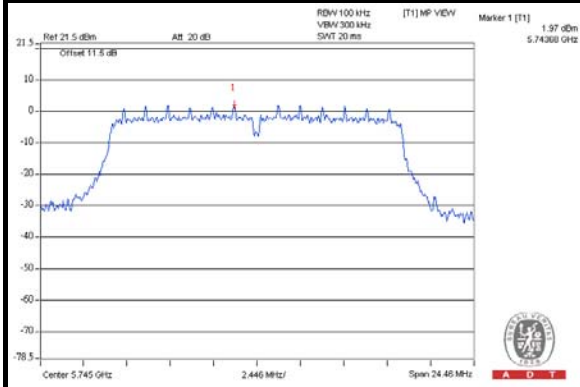
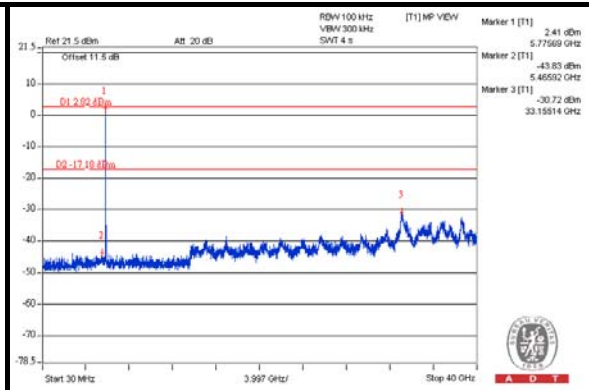
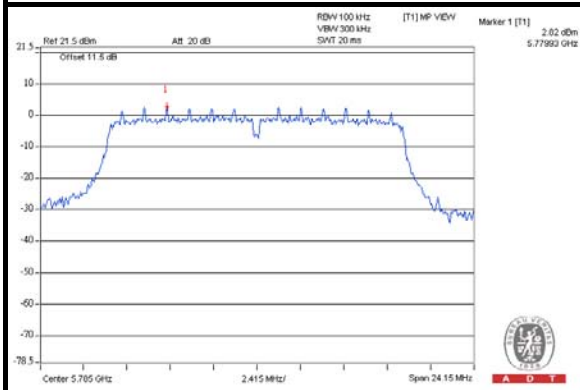
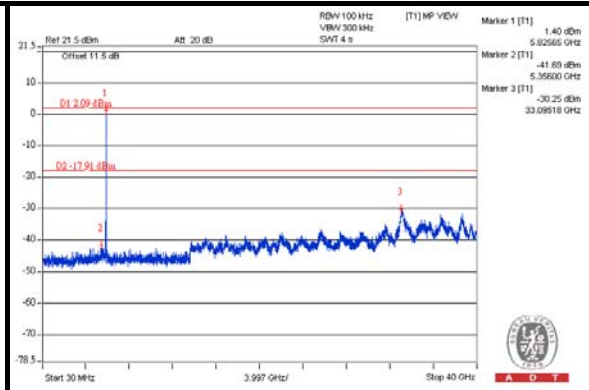
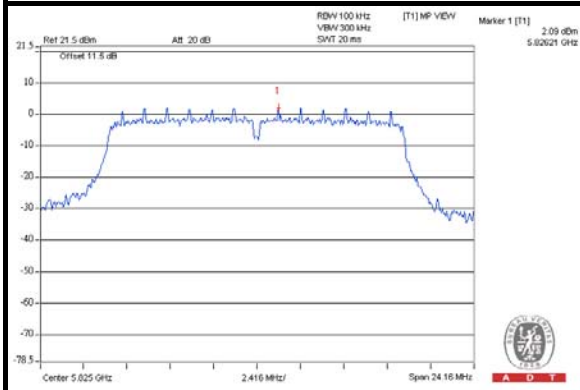
**802.11a****CH 149****CH 157****CH 165**



A D T

### 802.11n (20MHz)\_1TX

#### CH 149

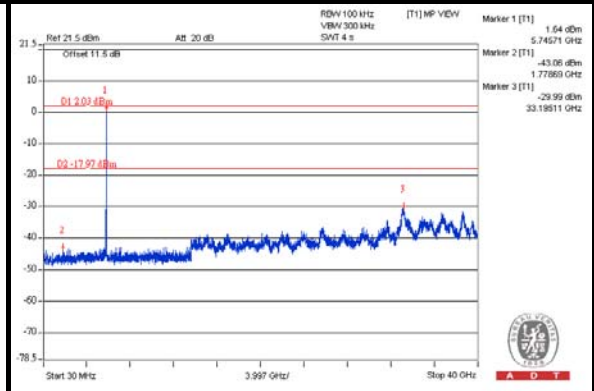
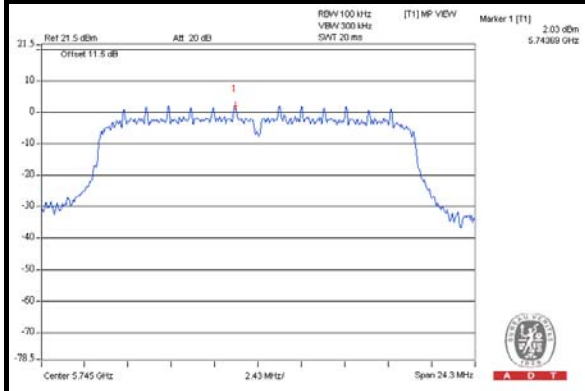

#### CH 157

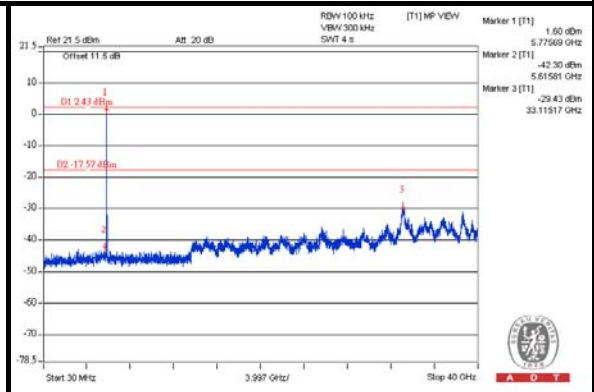
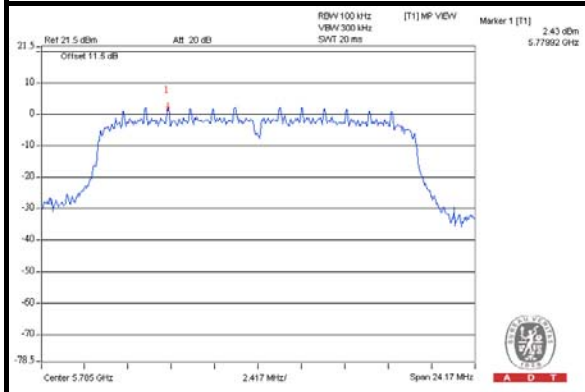

#### CH 165

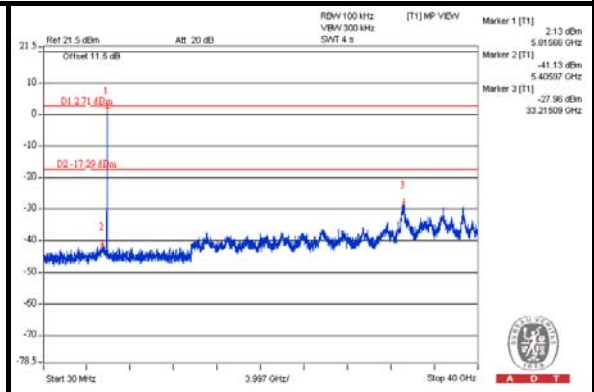
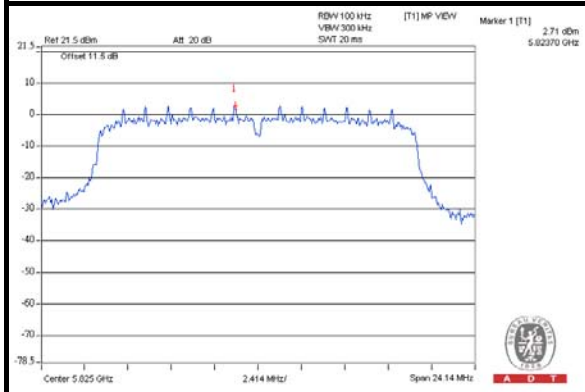



802.11n (20MHz)\_2TX  
CHAIN 0

CH 149

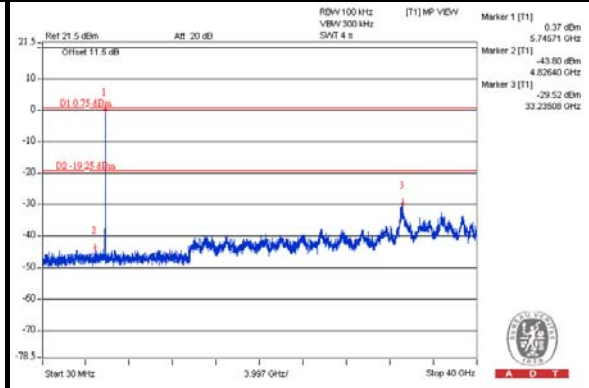
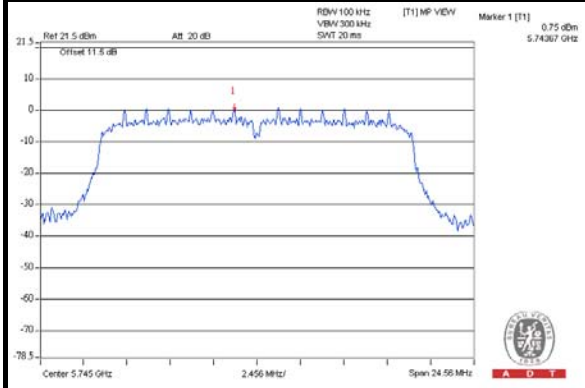

CH 157

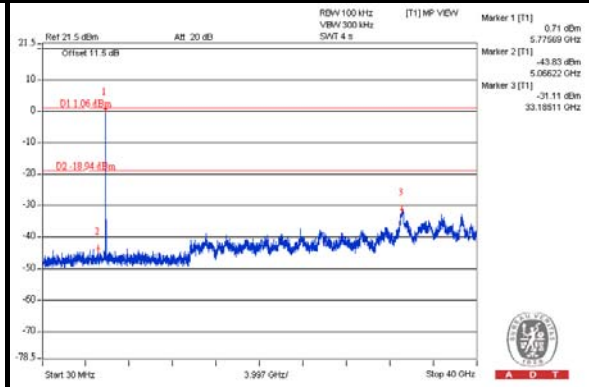
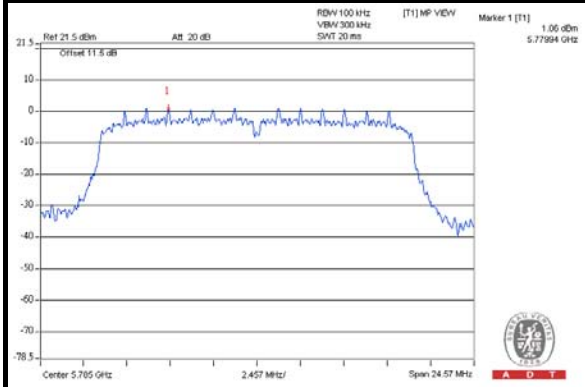

CH 165

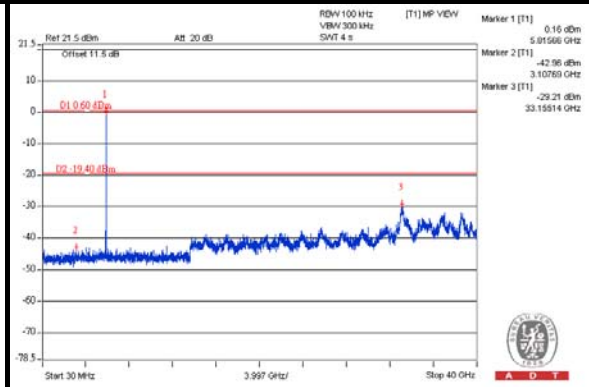
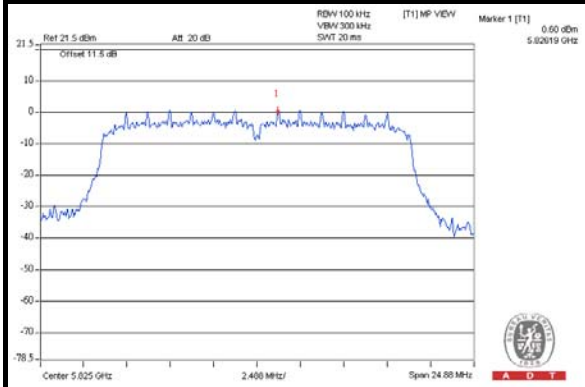



A D T

# CHAIN 1

## CH 149

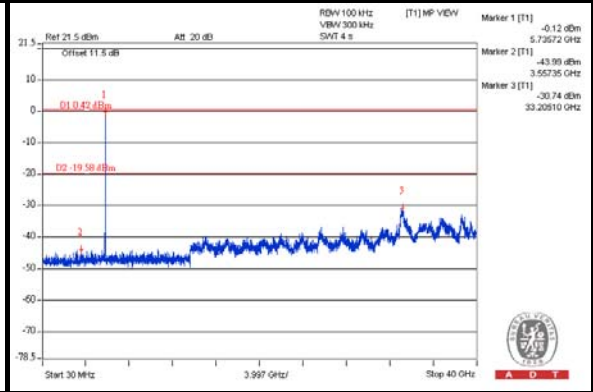
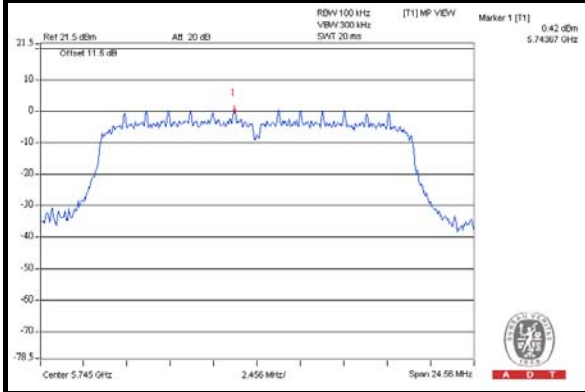

## CH 157

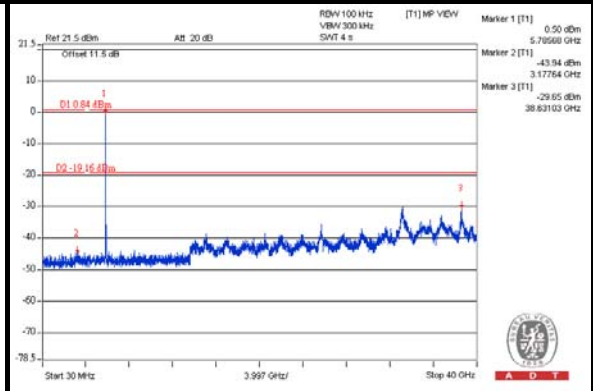
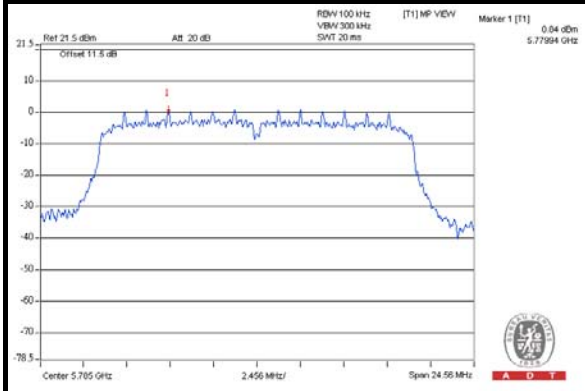

## CH 165

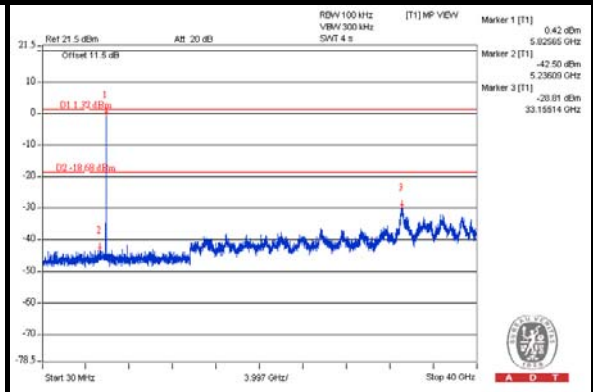
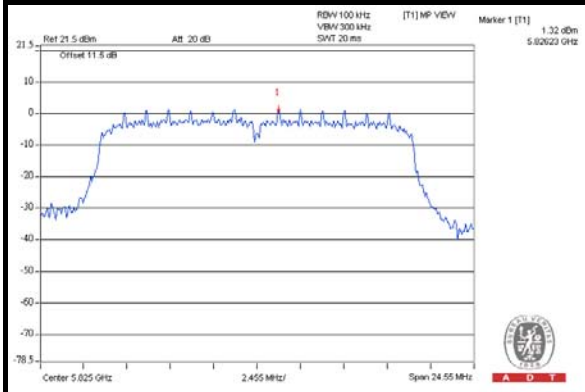

802.11n (40MHz)\_1 TX

CH 151

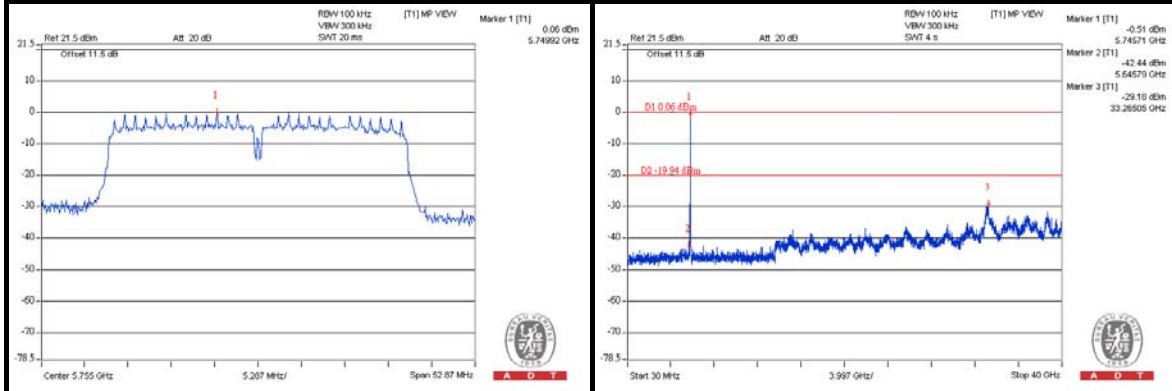

CH 159

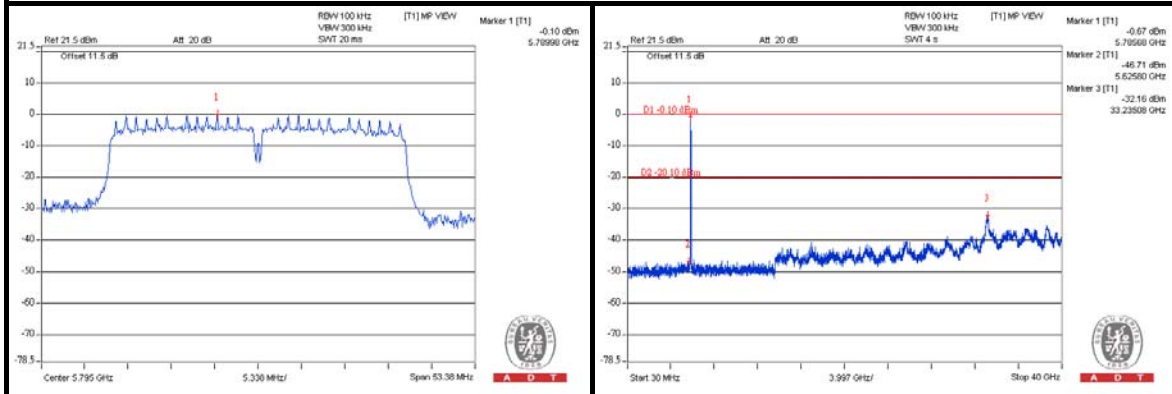



A D T

# 802.11n (40MHz)\_2 TX CHAIN 0

## CH 151

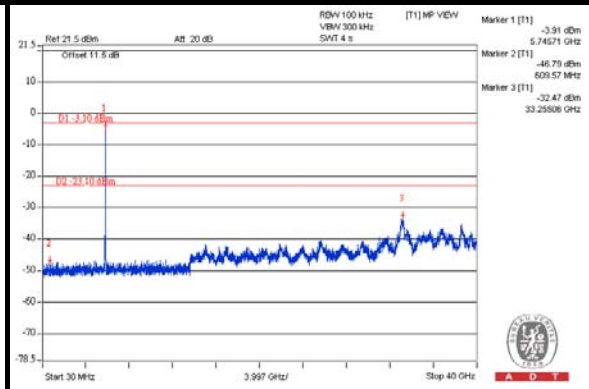
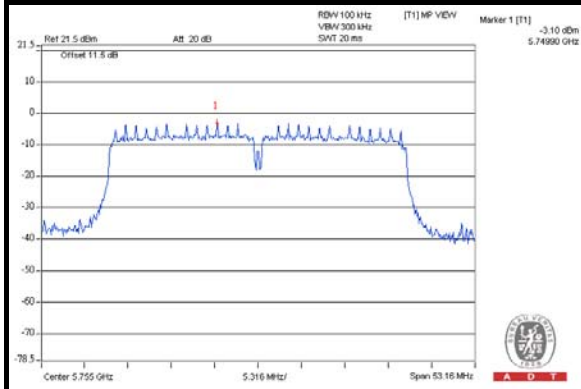

## CH 159

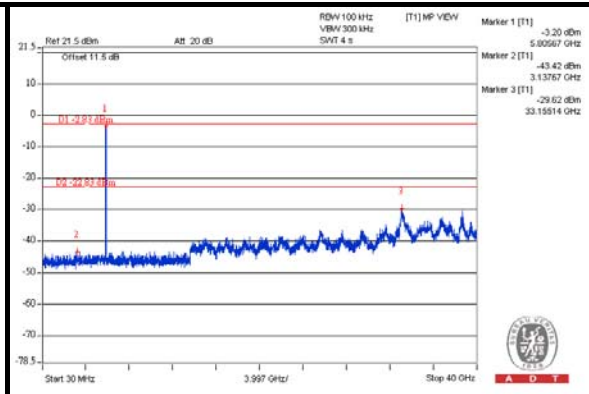
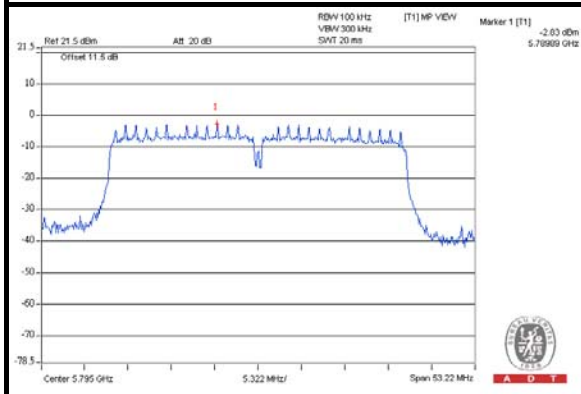

CHAIN 1

CH 151

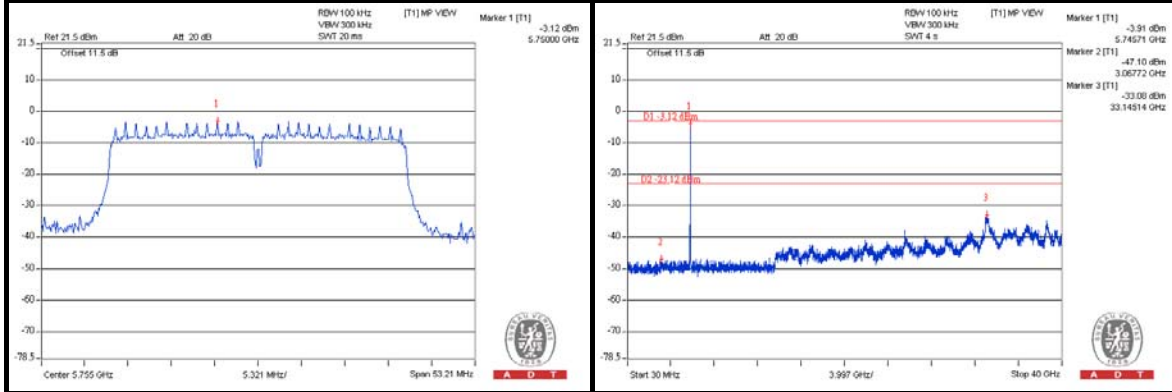

CH 159

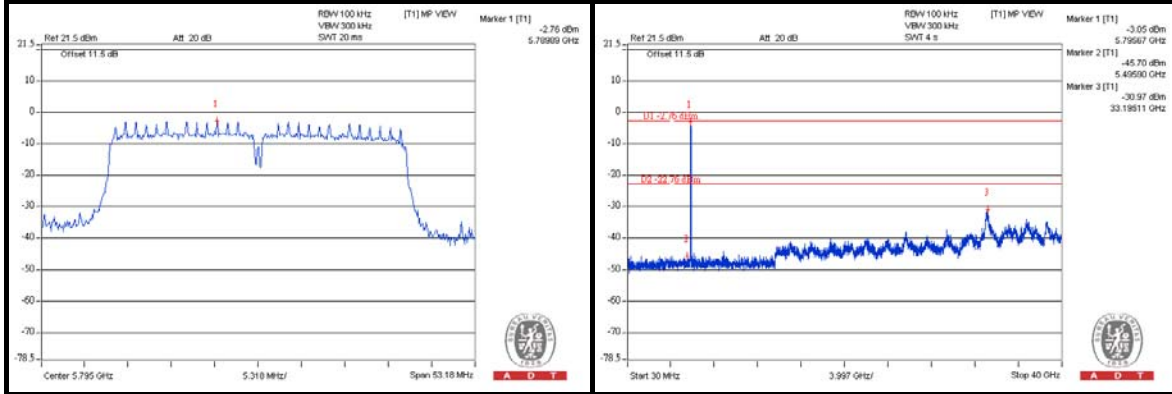



A D T

## 6. PHOTOGRAPHS OF THE TEST CONFIGURATION

Please refer to the attached file (Test Setup Photo).



A D T

## 7. INFORMATION ON THE TESTING LABORATORIES

We, Bureau Veritas Consumer Products Services (H.K.) Ltd., Taoyuan Branch, were founded in 1988 to provide our best service in EMC, Radio, Telecom and Safety consultation. Our laboratories are accredited and approved according to ISO/IEC 17025.

If you have any comments, please feel free to contact us at the following:

**Linko EMC/RF Lab**

Tel: 886-2-26052180

Fax: 886-2-26051924

**Hsin Chu EMC/RF Lab**

Tel: 886-3-5935343

Fax: 886-3-5935342

**Hwa Ya EMC/RF/Safety/Telecom Lab**

Tel: 886-3-3183232

Fax: 886-3-3270892

**Email:** [service.adt@tw.bureauveritas.com](mailto:service.adt@tw.bureauveritas.com)

**Web Site:** [www.bureauveritas-adt.com](http://www.bureauveritas-adt.com)

The address and road map of all our labs can be found in our web site also.



A D T

## **8. APPENDIX A - MODIFICATIONS RECORDERS FOR ENGINEERING CHANGES TO THE EUT BY THE LAB**

No modifications were made to the EUT by the lab during the test.

**---END---**