



# FCC TEST REPORT (15.407)

**REPORT NO.:** RF121009E03-1  
**MODEL NO.:** WN6500RH  
**FCC ID:** SUZ-WN6500RH  
**RECEIVED:** Oct. 09, 2012  
**TESTED:** Oct. 22 ~ Oct. 27, 2012  
**ISSUED:** Nov. 13, 2012

**APPLICANT:** Coretronic Corp.

**ADDRESS:** No. 11, Li Hsing Rd, Science-Based Industrial Park, Hsinchu, Taiwan.

**ISSUED BY:** Bureau Veritas Consumer Products Services (H.K.) Ltd., Taoyuan Branch

**LAB ADDRESS:** No. 47, 14th Ling, Chia Pau Vil., Lin Kou Dist., New Taipei City, Taiwan, R.O.C.

**TEST LOCATION:** No. 19, Hwa Ya 2nd Rd, Wen Hwa Tsuen, Kwei Shan Hsiang, Taoyuan Hsien 333, Taiwan, R.O.C.

This report should not be used by the client to claim product certification, approval, or endorsement by TAF or any government agencies.



This report is for your exclusive use. Any copying or replication of this report to or for any other person or entity, or use of our name or trademark, is permitted only with our prior written permission. This report sets forth our findings solely with respect to the test samples identified herein. The results set forth in this report are not indicative or representative of the quality or characteristics of the lot from which a test sample was taken or any similar or identical product unless specifically and expressly noted. Our report includes all of the tests requested by you and the results thereof based upon the information that you provided to us. You have 60 days from date of issuance of this report to notify us of any material error or omission caused by our negligence, provided, however, that such notice shall be in writing and shall specifically address the issue you wish to raise. A failure to raise such issue within the prescribed time shall constitute your unqualified acceptance of the completeness of this report, the tests conducted and the correctness of the report contents. Unless specific mention, the uncertainty of measurement has been explicitly taken into account to declare the compliance or non-compliance to the specification.



# TABLE OF CONTENTS

|   |    |
|---|----|
| RELEASE CONTROL RECORD .....  | 4  |
| 1. CERTIFICATION.....   | 5  |
| 2. SUMMARY OF TEST RESULTS .....                                    | 6  |
| 2.1 MEASUREMENT UNCERTAINTY .....                                   | 6  |
| 3. GENERAL INFORMATION.....   | 7  |
| 3.1 GENERAL DESCRIPTION OF EUT .....                                | 7  |
| 3.2 DESCRIPTION OF TEST MODES.....                                  | 8  |
| 3.2.1 TEST MODE APPLICABILITY AND TESTED CHANNEL DETAIL.....        | 9  |
| 3.3 DUTY CYCLE OF TEST SIGNAL.....                                  | 11 |
| 3.4 DESCRIPTION OF SUPPORT UNITS .....                              | 12 |
| 3.4.1 CONFIGURATION OF SYSTEM UNDER TEST .....                      | 12 |
| 3.5 GENERAL DESCRIPTION OF APPLIED STANDARDS .....                  | 13 |
| 4. TEST TYPES AND RESULTS .....                                     | 14 |
| 4.1 RADIATED EMISSION AND BANDEDGE MEASUREMENT .....                | 14 |
| 4.1.1 LIMITS OF RADIATED EMISSION AND BANDEDGE MEASUREMENT.....     | 14 |
| 4.1.2 LIMITS OF UNWANTED EMISSION OUT OF THE RESTRICTED BANDS ..... | 14 |
| 4.1.3 TEST INSTRUMENTS.....   | 15 |
| 4.1.4 TEST PROCEDURES .....   | 16 |
| 4.1.5 DEVIATION FROM TEST STANDARD .....                            | 16 |
| 4.1.6 TEST SETUP.....   | 17 |
| 4.1.7 EUT OPERATING CONDITION .....                                 | 17 |
| 4.1.8 TEST RESULTS .....  | 18 |
| 4.2 CONDUCTED EMISSION MEASUREMENT .....                            | 61 |
| 4.2.1 LIMITS OF CONDUCTED EMISSION MEASUREMENT .....                | 61 |
| 4.2.2 TEST INSTRUMENTS.....   | 61 |
| 4.2.3 TEST PROCEDURES .....   | 62 |
| 4.2.4 DEVIATION FROM TEST STANDARD .....                            | 62 |
| 4.2.5 TEST SETUP.....   | 62 |
| 4.2.6 EUT OPERATING CONDITIONS .....                                | 62 |
| 4.2.7 TEST RESULTS .....  | 63 |
| 4.3 PEAK TRANSMIT POWER MEASUREMENT .....                           | 67 |
| 4.3.1 LIMITS OF PEAK TRANSMIT POWER MEASUREMENT .....               | 67 |
| 4.3.2 TEST SETUP.....   | 67 |
| 4.3.3 TEST INSTRUMENTS.....   | 67 |
| 4.3.4 TEST PROCEDURE.....   | 68 |
| 4.3.5 DEVIATION FROM TEST STANDARD .....                            | 68 |
| 4.3.6 EUT OPERATING CONDITIONS .....                                | 68 |
| 4.3.7 TEST RESULTS .....  | 69 |
| 4.4 PEAK POWER SPECTRAL DENSITY MEASUREMENT .....                   | 75 |
| 4.4.1 LIMITS OF PEAK POWER SPECTRAL DENSITY MEASUREMENT .....       | 75 |
| 4.4.2 TEST SETUP.....   | 75 |
| 4.4.3 TEST INSTRUMENTS.....   | 75 |
| 4.4.4 TEST PROCEDURES .....   | 75 |
| 4.4.5 DEVIATION FROM TEST STANDARD .....                            | 75 |
| 4.4.6 EUT OPERATING CONDITIONS .....                                | 75 |
| 4.4.7 TEST RESULTS .....  | 76 |
| 4.5 PEAK POWER EXCURSION MEASUREMENT .....                          | 79 |



A D T

|       |   |    |
|-------|---|----|
| 4.5.1 | LIMITS OF PEAK POWER EXCURSION MEASUREMENT .....  | 79 |
| 4.5.2 | TEST SETUP .....  | 79 |
| 4.5.3 | TEST INSTRUMENTS.....   | 79 |
| 4.5.4 | TEST PROCEDURE.....   | 79 |
| 4.5.5 | DEVIATION FROM TEST STANDARD .....  | 79 |
| 4.5.6 | EUT OPERATING CONDITIONS .....  | 79 |
| 4.5.7 | TEST RESULTS .....  | 80 |
| 4.6   | FREQUENCY STABILITY .....   | 85 |
| 4.6.1 | LIMITS OF FREQUENCY STABILITY MEASUREMENT.....  | 85 |
| 4.6.2 | TEST SETUP.....   | 85 |
| 4.6.3 | TEST INSTRUMENTS.....   | 85 |
| 4.6.4 | TEST PROCEDURE.....   | 86 |
| 4.6.5 | DEVIATION FROM TEST STANDARD .....  | 86 |
| 4.6.6 | EUT OPERATING CONDITION .....   | 86 |
| 4.6.7 | TEST RESULTS .....  | 87 |
| 5.    | PHOTOGRAPHS OF THE TEST CONFIGURATION .....   | 88 |
| 6.    | INFORMATION ON THE TESTING LABORATORIES.....  | 89 |
| 7.    | APPENDIX A - MODIFICATIONS RECORDERS FOR ENGINEERING CHANGES TO THE<br>EUT BY THE LAB ..... | 90 |



A D T

## RELEASE CONTROL RECORD

| ISSUE NO.     | REASON FOR CHANGE | DATE ISSUED   |
|---------------|-------------------|---------------|
| RF121009E03-1 | Original release  | Nov. 13, 2012 |



## 1. CERTIFICATION

**PRODUCT:** 802.11n, Dual Band, 2T2R Wireless LAN PCI Express Half  
Mini Module

**MODEL:** WN6500RH

**BRAND:** Coretronic

**APPLICANT:** Coretronic Corp.

**TESTED:** Oct. 22 ~ Oct. 27, 2012

**TEST SAMPLE:** ENGINEERING SAMPLE

**STANDARDS:** FCC Part 15, Subpart E (Section 15.407)

ANSI C63.10-2009

The above equipment (model: WN6500RH) has been tested by **Bureau Veritas Consumer Products Services (H.K.) Ltd., Taoyuan Branch**, and found compliance with the requirement of the above standards. The test record, data evaluation & Equipment Under Test (EUT) configurations represented herein are true and accurate accounts of the measurements of the sample's EMC characteristics under the conditions specified in this report.

PREPARED BY : *Iyy Lin* , DATE : Nov. 13, 2012  
Iyy Lin / Specialist

APPROVED BY : *Ken Liu* , DATE : Nov. 13, 2012  
Ken Liu / Manager

## 2. SUMMARY OF TEST RESULTS

The EUT has been tested according to the following specifications:

| APPLIED STANDARD: FCC PART 15, SUBPART E (SECTION 15.407) |                             |        |  |
|---|-----------------------------|--------|--|
| STANDARD SECTION  | TEST TYPE                   | RESULT | REMARK   |
| 15.407(b)(6)  | AC Power Conducted Emission | PASS   | Meet the requirement of limit.<br>Minimum passing margin is -7.59dB at 0.32595MHz. |
| 15.407(b/1/2/3)<br>(b)(6)                                 | Spurious Emissions          | PASS   | Meet the requirement of limit.<br>Minimum passing margin is -1.0dB at 5350.00MHz.  |
| 15.407(a/1/2)   | Max Average Transmit Power  | PASS   | Meet the requirement of limit.   |
| 15.407(a)(6)  | Peak Power Excursion        | PASS   | Meet the requirement of limit.   |
| 15.407(a/1/2)   | Peak Power Spectral Density | PASS   | Meet the requirement of limit.   |
| 15.407(g)   | Frequency Stability         | PASS   | Meet the requirement of limit.   |
| 15.203  | Antenna Requirement         | PASS   | Antenna connector is I-PEX<br>not a standard connector.                            |

### 2.1 MEASUREMENT UNCERTAINTY

Where relevant, the following measurement uncertainty levels have been estimated for tests performed on the EUT as specified in CISPR 16-4-2:

| MEASUREMENT         | FREQUENCY       | UNCERTAINTY |
|---------------------|-----------------|-------------|
| Conducted emissions | 9kHz~30MHz      | 2.44 dB     |
| Radiated emissions  | 30MHz ~ 200MHz  | 2.93 dB     |
|                     | 200MHz ~1000MHz | 2.95 dB     |
|                     | 1GHz ~ 18GHz    | 2.26 dB     |
|                     | 18GHz ~ 40GHz   | 1.94 dB     |

This uncertainty represents an expanded uncertainty expressed at approximately the 95% confidence level using a coverage factor of  $k = 2$ .

### 3. GENERAL INFORMATION

#### 3.1 GENERAL DESCRIPTION OF EUT

|                              |  |
|------------------------------|--|
| <b>EUT</b>                   | 802.11n, Dual Band, 2T2R Wireless LAN PCI Express Half Mini Module   |
| <b>MODEL NO.</b>             | WN6500RH   |
| <b>POWER SUPPLY</b>          | 3.3Vdc (Host equipment)  |
| <b>MODULATION TYPE</b>       | 64QAM, 16QAM, QPSK, BPSK   |
| <b>MODULATION TECHNOLOGY</b> | OFDM   |
| <b>TRANSFER RATE</b>         | 802.11a: 54.0/ 48.0/ 36.0/ 24.0/ 18.0/ 12.0/ 9.0/ 6.0Mbps<br>802.11n: up to 300.0Mbps  |
| <b>OPERATING FREQUENCY</b>   | 5180 ~ 5240MHz, 5260 ~ 5320MHz & 5500 ~ 5700MHz  |
| <b>NUMBER OF CHANNEL</b>     | 5180 ~ 5240MHz: 4 for 802.11a, 802.11n (20MHz)<br>2 for 802.11n (40MHz)<br>5260 ~ 5320MHz: 4 for 802.11a, 802.11n (20MHz)<br>2 for 802.11n (40MHz)<br>5500 ~ 5700MHz: 11 for 802.11a, 802.11n (20MHz)<br>5 for 802.11n (40MHz) |
| <b>OUTPUT POWER</b>          | 23.88mW for 5180 ~ 5240MHz<br>38.03mW for 5260 ~ 5320MHz<br>37.41mW for 5500 ~ 5700MHz   |
| <b>ANTENNA TYPE</b>          | Refer to Note  |
| <b>ANTENNA CONNECTOR</b>     | I-PEX  |
| <b>DATA CABLE</b>            | N/A  |
| <b>I/O PORTS</b>             | Refer to user's manual   |
| <b>ACCESSORY DEVICES</b>     | N/A  |

**NOTE:**

- The EUT incorporates a MIMO function. Physically, the EUT provides two completed transmitters and two receivers.

| MODULATION MODE | TX FUNCTION |
|-----------------|-------------|
| 802.11b         | 1TX         |
| 802.11g         | 1TX         |
| 802.11a         | 1TX         |
| 802.11n (20MHz) | 1TX/ 2TX    |
| 802.11n (40MHz) | 1TX/ 2TX    |

- The following antenna gains are provided to the EUT.

| Antenna type | Antenna gain (dBi) |         |                |                |                |                  |
|--------------|--------------------|---------|----------------|----------------|----------------|------------------|
|              | 2.4GHz             | 5.15GHz | 5.18 ~ 5.24GHz | 5.26 ~ 5.32GHz | 5.50 ~ 5.70GHz | 5.745 ~ 5.825MHz |
| PIFA         | 1.9                | 2.21    | 2.59           | 3.94           | 3.73           | 4.21             |

- The above EUT information is declared by manufacturer and for more detailed features description, please refer to the manufacturer's specifications or user's manual.

### 3.2 DESCRIPTION OF TEST MODES

#### FOR 5180 ~ 5240MHz

4 channels are provided for 802.11a, 802.11n (20MHz):

| CHANNEL | FREQUENCY | CHANNEL | FREQUENCY |
|---------|-----------|---------|-----------|
| 36      | 5180 MHz  | 44      | 5220 MHz  |
| 40      | 5200 MHz  | 48      | 5240 MHz  |

2 channels are provided for 802.11n (40MHz):

| CHANNEL | FREQUENCY | CHANNEL | FREQUENCY |
|---------|-----------|---------|-----------|
| 38      | 5190 MHz  | 46      | 5230 MHz  |

#### FOR 5260 ~ 5320MHz

4 channels are provided for 802.11a, 802.11n (20MHz):

| CHANNEL | FREQUENCY | CHANNEL | FREQUENCY |
|---------|-----------|---------|-----------|
| 52      | 5260 MHz  | 60      | 5300 MHz  |
| 56      | 5280 MHz  | 64      | 5320 MHz  |

2 channels are provided for 802.11n (40MHz):

| CHANNEL | FREQUENCY | CHANNEL | FREQUENCY |
|---------|-----------|---------|-----------|
| 54      | 5270 MHz  | 62      | 5310 MHz  |

#### FOR 5500 ~ 5700MHz

11 channels are provided for 802.11a, 802.11n (20MHz):

| CHANNEL | FREQUENCY | CHANNEL | FREQUENCY |
|---------|-----------|---------|-----------|
| 100     | 5500 MHz  | 124     | 5620 MHz  |
| 104     | 5520 MHz  | 128     | 5640 MHz  |
| 108     | 5540 MHz  | 132     | 5660 MHz  |
| 112     | 5560 MHz  | 136     | 5680 MHz  |
| 116     | 5580 MHz  | 140     | 5700 MHz  |
| 120     | 5600 MHz  |         |           |

5 channels are provided for 802.11n (40MHz):

| CHANNEL | FREQUENCY | CHANNEL | FREQUENCY |
|---------|-----------|---------|-----------|
| 102     | 5510MHz   | 126     | 5630MHz   |
| 110     | 5550MHz   | 134     | 5670MHz   |
| 118     | 5590MHz   |         |           |



### 3.2.1 TEST MODE APPLICABILITY AND TESTED CHANNEL DETAIL

| EUT CONFIGURE MODE | APPLICABLE TO |       |     |      | DESCRIPTION |
|--------------------|---------------|-------|-----|------|-------------|
|                    | RE $\geq$ 1G  | RE<1G | PLC | APCM |             |
| A                  | √             | -     | -   | √    | 1 TX        |
| B                  | √             | √     | √   | √    | 2 TX        |

Where **RE $\geq$ 1G**: Radiated Emission above 1GHz      **RE<1G**: Radiated Emission below 1GHz  
**PLC**: Power Line Conducted Emission      **APCM**: Antenna Port Conducted Measurement

**NOTE:**

1. The antenna had been pre-tested on the positioned of each 3 axis. The worst case was found when positioned on **Y-plane**.
2. "-" means no effect.

**RADIATED EMISSION TEST (ABOVE 1GHz):**

- Pre-Scan has been conducted to determine the worst-case mode from all possible combinations between available modulations, data rates and antenna ports (if EUT with antenna diversity architecture).
- Following channel(s) was (were) selected for the final test as listed below.

| EUT CONFIGURE MODE | MODE            | FREQ. BAND (MHz) | AVAILABLE CHANNEL | TESTED CHANNEL | MODULATION TECHNOLOGY | MODULATION TYPE | DATA RATE (Mbps) |
|--------------------|-----------------|------------------|-------------------|----------------|-----------------------|-----------------|------------------|
| A                  | 802.11a         | 5180-5240        | 36 to 48          | 36, 40, 48     | OFDM                  | BPSK            | 6.0              |
| A                  | 802.11n (20MHz) |                  | 36 to 48          | 36, 40, 48     | OFDM                  | BPSK            | 7.2              |
| A                  | 802.11n (40MHz) |                  | 38 to 46          | 38, 46         | OFDM                  | BPSK            | 15.0             |
| A                  | 802.11a         | 5260-5320        | 52 to 64          | 52, 60, 64     | OFDM                  | BPSK            | 6.0              |
| A, B               | 802.11n (20MHz) |                  | 52 to 64          | 52, 60, 64     | OFDM                  | BPSK            | 7.2              |
| A, B               | 802.11n (40MHz) |                  | 54 to 62          | 54, 62         | OFDM                  | BPSK            | 15.0             |
| A                  | 802.11a         | 5500-5700        | 100 to 140        | 100, 116, 140  | OFDM                  | BPSK            | 6.0              |
| A, B               | 802.11n (20MHz) |                  | 100 to 140        | 100, 116, 140  | OFDM                  | BPSK            | 7.2              |
| A, B               | 802.11n (40MHz) |                  | 102 to 134        | 102, 110, 134  | OFDM                  | BPSK            | 15.0             |

**RADIATED EMISSION TEST (BELOW 1GHz):**

- Pre-Scan has been conducted to determine the worst-case mode from all possible combinations between available modulations, data rates and antenna ports (if EUT with antenna diversity architecture).
- Following channel(s) was (were) selected for the final test as listed below.

| EUT CONFIGURE MODE | MODE            | FREQ. BAND (MHz) | AVAILABLE CHANNEL | TESTED CHANNEL | MODULATION TECHNOLOGY | MODULATION TYPE | DATA RATE (Mbps) |
|--------------------|-----------------|------------------|-------------------|----------------|-----------------------|-----------------|------------------|
| B                  | 802.11n (20MHz) | 5180-5320        | 36 to 64          | 64             | OFDM                  | BPSK            | 7.2              |
| B                  | 802.11n (20MHz) | 5500-5700        | 100 to 140        | 140            | OFDM                  | BPSK            | 7.2              |

**POWER LINE CONDUCTED EMISSION TEST:**

- Pre-Scan has been conducted to determine the worst-case mode from all possible combinations between available modulations, data rates and antenna ports (if EUT with antenna diversity architecture).
- Following channel(s) was (were) selected for the final test as listed below.

| EUT CONFIGURE MODE | MODE            | FREQ. BAND (MHz) | AVAILABLE CHANNEL | TESTED CHANNEL | MODULATION TECHNOLOGY | MODULATION TYPE | DATA RATE (Mbps) |
|--------------------|-----------------|------------------|-------------------|----------------|-----------------------|-----------------|------------------|
| B                  | 802.11n (20MHz) | 5180-5320        | 36 to 64          | 64             | OFDM                  | BPSK            | 7.2              |
| B                  | 802.11n (20MHz) | 5500-5700        | 100 to 140        | 140            | OFDM                  | BPSK            | 7.2              |

**ANTENNA PORT CONDUCTED MEASUREMENT:**

- This item includes all test value of each mode, but only includes spectrum plot of worst value of each mode.
- Pre-Scan has been conducted to determine the worst-case mode from all possible combinations between available modulations, data rates and antenna ports (if EUT with antenna diversity architecture).
- Following channel(s) was (were) selected for the final test as listed below.

| EUT CONFIGURE MODE | MODE            | FREQ. BAND (MHz) | AVAILABLE CHANNEL | TESTED CHANNEL | MODULATION TECHNOLOGY | MODULATION TYPE | DATA RATE (Mbps) |
|--------------------|-----------------|------------------|-------------------|----------------|-----------------------|-----------------|------------------|
| A                  | 802.11a         | 5180-5240        | 36 to 48          | 36, 40, 48     | OFDM                  | BPSK            | 6.0              |
| A                  | 802.11n (20MHz) |                  | 36 to 48          | 36, 40, 48     | OFDM                  | BPSK            | 7.2              |
| A                  | 802.11n (40MHz) |                  | 38 to 46          | 38, 46         | OFDM                  | BPSK            | 15.0             |
| A                  | 802.11a         | 5260-5320        | 52 to 64          | 52, 60, 64     | OFDM                  | BPSK            | 6.0              |
| A, B               | 802.11n (20MHz) |                  | 52 to 64          | 52, 60, 64     | OFDM                  | BPSK            | 7.2              |
| A, B               | 802.11n (40MHz) |                  | 54 to 62          | 54, 62         | OFDM                  | BPSK            | 15.0             |
| A                  | 802.11a         | 5500-5700        | 100 to 140        | 100, 116, 140  | OFDM                  | BPSK            | 6.0              |
| A, B               | 802.11n (20MHz) |                  | 100 to 140        | 100, 116, 140  | OFDM                  | BPSK            | 7.2              |
| A, B               | 802.11n (40MHz) |                  | 102 to 134        | 102, 110, 134  | OFDM                  | BPSK            | 15.0             |

**TEST CONDITION:**

| APPLICABLE TO | ENVIRONMENTAL CONDITIONS | INPUT POWER (SYSTEM) | TESTED BY               |
|---------------|--------------------------|----------------------|-------------------------|
| RE≥1G         | 25deg. C, 67%RH          | 120Vac, 60Hz         | Cedric Wu,<br>Chris Lin |
| RE<1G         | 25deg. C, 67%RH          | 120Vac, 60Hz         | Cedric Wu               |
| PLC           | 25deg. C, 65%RH          | 120Vac, 60Hz         | Chris Lin               |
| APCM          | 25deg. C, 67%RH          | 120Vac, 60Hz         | Chris Lin               |

### 3.3 DUTY CYCLE OF TEST SIGNAL

If duty cycle is < 98%, duty factor shall be considered.

For 1 TX

**802.11a:** Duty cycle = 1.420/1.660 = 0.855, Duty factor =  $10 * \log(1/0.855) = 0.68$

**802.11n (20MHz):** Duty cycle = 1.310/1.560 = 0.840, Duty factor =  $10 * \log(1/0.840) = 0.76$

**802.11n (40MHz):** Duty cycle = 650/866 = 0.751, Duty factor =  $10 * \log(1/0.751) = 1.24$



For 2 TX

**802.11n (20MHz):** Duty cycle = 670/910 = 0.736, Duty factor =  $10 * \log(1/0.736) = 1.33$

**802.11n (40MHz):** Duty cycle = 330/546 = 0.604, Duty factor =  $10 * \log(1/0.604) = 2.19$

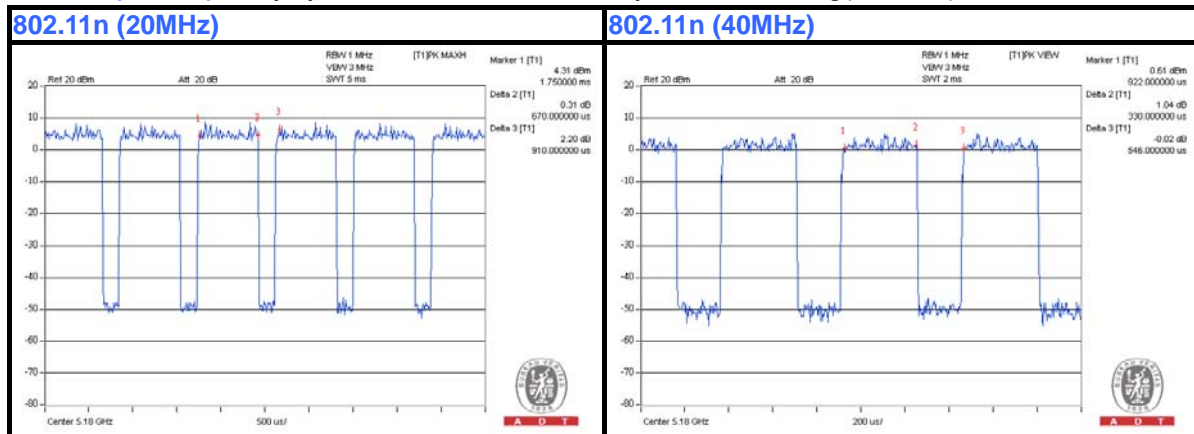

### 3.4 DESCRIPTION OF SUPPORT UNITS

The EUT has been tested as an independent unit together with other necessary accessories or support units. The following support units or accessories were used to form a representative test configuration during the tests.

| NO. | PRODUCT           | BRAND | MODEL NO. | SERIAL NO. | FCC ID |
|-----|-------------------|-------|-----------|------------|--------|
| 1   | NOTEBOOK          | DELL  | E5420     | BPQ8MQ1    | NA     |
| 2   | CONVERTIBLE BOARD | NA    | NA        | NA         | NA     |

| NO. | SIGNAL CABLE DESCRIPTION OF THE ABOVE SUPPORT UNITS |
|-----|---|
| 1   | NA  |
| 2   | NA  |

**NOTE:** All power cords of the above support units are non shielded (1.8m).

#### 3.4.1 CONFIGURATION OF SYSTEM UNDER TEST

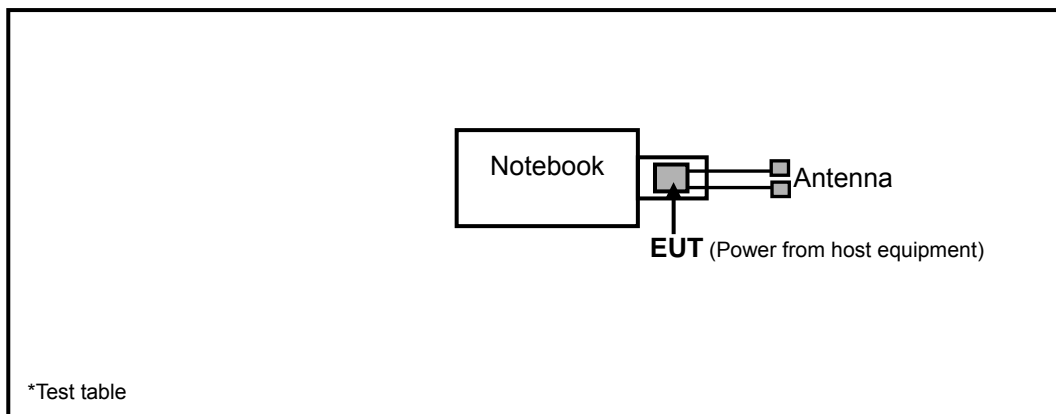

### **3.5 GENERAL DESCRIPTION OF APPLIED STANDARDS**

The EUT is a RF Product. According to the specifications of the manufacturer, it must comply with the requirements of the following standards:

**FCC Part 15, Subpart E (15.407)**

**789033 D01 General UNII Test Procedures v01r02**

**662911 D01 Multiple Transmitter Output v01 r02**

**ANSI C63.10-2009**

All test items have been performed and recorded as per the above standards.

## 4. TEST TYPES AND RESULTS

### 4.1 RADIATED EMISSION AND BANDEDGE MEASUREMENT

#### 4.1.1 LIMITS OF RADIATED EMISSION AND BANDEDGE MEASUREMENT

Radiated emissions which fall in the restricted bands must comply with the radiated emission limits specified as below table:

| FREQUENCIES (MHz) | FIELD STRENGTH (microvolts/meter) | MEASUREMENT DISTANCE (meters) |
|-------------------|-----------------------------------|-------------------------------|
| 0.009 ~ 0.490     | 2400/F(kHz)                       | 300                           |
| 0.490 ~ 1.705     | 24000/F(kHz)                      | 30                            |
| 1.705 ~ 30.0      | 30                                | 30                            |
| 30 ~ 88           | 100                               | 3                             |
| 88 ~ 216          | 150                               | 3                             |
| 216 ~ 960         | 200                               | 3                             |
| Above 960         | 500                               | 3                             |

**NOTE:**

1. The lower limit shall apply at the transition frequencies.
2. Emission level (dBuV/m) = 20 log Emission level (uV/m).
3. For frequencies above 1000MHz, the field strength limits are based on average detector, however, the peak field strength of any emission shall not exceed the maximum permitted average limits, specified above by more than 20dB under any condition of modulation.

#### 4.1.2 LIMITS OF UNWANTED EMISSION OUT OF THE RESTRICTED BANDS

| APPLICABLE TO | LIMIT                         |  |
|---------------|-------------------------------|--|
| √             | FIELD STRENGTH AT 3m (dBμV/m) |  |
|               | PK                            | AV                                       |
|               | 74                            | 54                                       |
|               | EIRP LIMIT (dBm)              | EQUIVALENT FIELD STRENGTH AT 3m (dBμV/m) |
|               | PK                            | PK                                       |
|               | -27                           | 68.3                                     |

**NOTE:** The following formula is used to convert the equipment isotropic radiated power (eirp) to field strength:

$$E = \frac{1000000\sqrt{30P}}{3} \mu\text{V/m, where P is the eirp (Watts).}$$



#### 4.1.3 TEST INSTRUMENTS

| DESCRIPTION & MANUFACTURER                       | MODEL NO.                    | SERIAL NO.           | DATE OF CALIBRATION | DUE DATE OF CALIBRATION |
|--|------------------------------|----------------------|---------------------|-------------------------|
| Test Receiver<br>ROHDE & SCHWARZ                 | ESCI                         | 100744               | Apr. 19, 2012       | Apr. 18, 2013           |
| Spectrum Analyzer<br>ROHDE & SCHWARZ             | FSP40                        | 100269               | Jan. 30, 2012       | Jan. 29, 2013           |
| BILOG Antenna<br>SCHWARZBECK                     | VULB9168                     | 9168-156             | Apr. 03, 2012       | Apr. 02, 2013           |
| HORN Antenna<br>SCHWARZBECK                      | BBHA 9120 D                  | 9120D-563            | Sep. 12, 2012       | Sep. 11, 2013           |
| HORN Antenna<br>SCHWARZBECK                      | BBHA 9170                    | 148                  | Jul. 11, 2012       | Jul. 10, 2013           |
| Preamplifier<br>Agilent                          | 8449B                        | 3008A01975           | Mar. 03, 2012       | Mar. 02, 2013           |
| Preamplifier<br>Agilent                          | 8447D                        | 944A10663            | May 11, 2012        | May 10, 2013            |
| RF signal cable<br>HUBER+SUHNNER                 | SUCOFLEX 104                 | 295013/4<br>283403/4 | Aug. 28, 2012       | Aug. 27, 2013           |
| RF signal cable<br>Worken                        | 8D-FB                        | Cable-HYCH9-01       | Aug. 11, 2012       | Aug. 10, 2013           |
| Software   | ADT_Radiated_<br>V7.6.15.9.2 | NA                   | NA                  | NA                      |
| Antenna Tower<br>EMCO                            | 2070/2080                    | 512.835.4684         | NA                  | NA                      |
| Turn Table<br>EMCO                               | 2087-2.03                    | NA                   | NA                  | NA                      |
| Antenna Tower & Turn<br>Table Controller<br>EMCO | 2090                         | NA                   | NA                  | NA                      |
| 26GHz ~ 40GHz<br>Amplifier                       | EM26400                      | 815221               | Oct. 29, 2011       | Oct. 28, 2012           |

- NOTE:**
1. The calibration interval of the above test instruments is 12 months and the calibrations are traceable to NML/ROC and NIST/USA.
  2. The test was performed in HwaYa Chamber 9.
  3. The horn antenna and HP preamplifier (model: 8449B) are used only for the measurement of emission frequency above 1GHz if tested.
  4. The FCC Site Registration No. is 460141.
  5. The IC Site Registration No. is IC 7450F-4.

#### 4.1.4 TEST PROCEDURES

- a. The EUT was placed on the top of a rotating table 0.8 meters above the ground at a 3 meter semi-anechoic chamber. The table was rotated 360 degrees to determine the position of the highest radiation.
- b. The EUT was set 3 meters away from the interference-receiving antenna, which was mounted on the top of a variable-height antenna tower.
- c. The antenna is a broadband antenna, and its height is varied from one meter to four meters above the ground to determine the maximum value of the field strength. Both horizontal and vertical polarizations of the antenna are set to make the measurement.
- d. For each suspected emission, the EUT was arranged to its worst case and then the antenna was tuned to heights from 1 meter to 4 meters and the rotatable table was turned from 0 degrees to 360 degrees to find the maximum reading.
- e. The test-receiver system was set to Peak Detect Function and Specified Bandwidth with Maximum Hold Mode.
- f. If the emission level of the EUT in peak mode was 10dB lower than the limit specified, then testing could be stopped and the peak values of the EUT would be reported. Otherwise the emissions that did not have 10dB margin would be re-tested one by one using peak, quasi-peak or average method as specified and then reported in a data sheet.

**NOTE:**

1. The resolution bandwidth and video bandwidth of test receiver/spectrum analyzer is 120kHz for Peak detection (PK) and Quasi-peak detection (QP) at frequency below 1GHz.
2. The resolution bandwidth of test receiver/spectrum analyzer is 1MHz and video bandwidth is 3MHz for Peak detection at frequency above 1GHz.
3. The resolution bandwidth of test receiver/spectrum analyzer is 1MHz and the video bandwidth is 1kHz for Average detection (AV) at frequency above 1GHz.
4. All modes of operation were investigated and the worst-case emissions are reported.

#### 4.1.5 DEVIATION FROM TEST STANDARD

No deviation.



#### 4.1.6 TEST SETUP

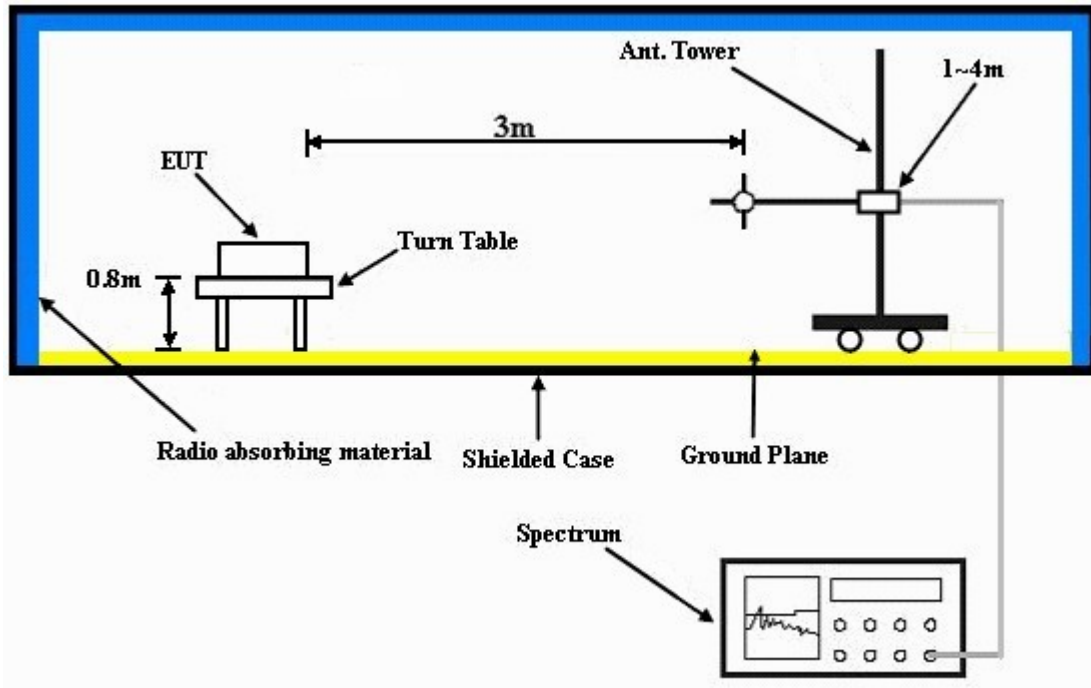

For the actual test configuration, please refer to the attached file (Test Setup Photo).

#### 4.1.7 EUT OPERATING CONDITION

- Plugged EUT into notebook system and placed on the testing table.
- The notebook system ran a test program (provided by manufacturer) to enable EUT under transmission condition continuously at specific channel frequency.

## 4.1.8 TEST RESULTS

1 TX

802.11a

| EUT TEST CONDITION       |                 | MEASUREMENT DETAIL |                           |
|--------------------------|-----------------|--------------------|---------------------------|
| CHANNEL                  | Channel 36      | FREQUENCY RANGE    | 1 ~ 40GHz                 |
| INPUT POWER (SYSTEM)     | 120Vac, 60Hz    | DETECTOR FUNCTION  | Peak (PK)<br>Average (AV) |
| ENVIRONMENTAL CONDITIONS | 25deg. C, 67%RH | TESTED BY          | Cedric Wu                 |
| TEST MODE                | A               |                    |                           |

| ANTENNA POLARITY & TEST DISTANCE: HORIZONTAL AT 3 M |             |                         |                |             |                    |                      |                  |                          |
|---|-------------|-------------------------|----------------|-------------|--------------------|----------------------|------------------|--------------------------|
| NO.   | FREQ. (MHz) | EMISSION LEVEL (dBuV/m) | LIMIT (dBuV/m) | MARGIN (dB) | ANTENNA HEIGHT (m) | TABLE ANGLE (Degree) | RAW VALUE (dBuV) | CORRECTION FACTOR (dB/m) |
| 1   | 5150.00     | 60.0 PK                 | 74.0           | -14.0       | 1.09 H             | 173                  | 21.40            | 38.60                    |
| 2   | 5150.00     | 47.1 AV                 | 54.0           | -6.9        | 1.09 H             | 173                  | 8.50             | 38.60                    |
| 3   | *5180.00    | 101.8 PK                |                |             | 1.10 H             | 164                  | 63.20            | 38.60                    |
| 4   | *5180.00    | 92.4 AV                 |                |             | 1.10 H             | 164                  | 53.80            | 38.60                    |
| 5   | #10360.00   | 58.6 PK                 | 74.0           | -15.4       | 1.00 H             | 160                  | 9.10             | 49.50                    |
| 6   | #10360.00   | 45.4 AV                 | 54.0           | -8.6        | 1.00 H             | 160                  | -4.10            | 49.50                    |
| ANTENNA POLARITY & TEST DISTANCE: VERTICAL AT 3 M   |             |                         |                |             |                    |                      |                  |                          |
| NO.   | FREQ. (MHz) | EMISSION LEVEL (dBuV/m) | LIMIT (dBuV/m) | MARGIN (dB) | ANTENNA HEIGHT (m) | TABLE ANGLE (Degree) | RAW VALUE (dBuV) | CORRECTION FACTOR (dB/m) |
| 1   | 5150.00     | 65.4 PK                 | 74.0           | -8.6        | 1.00 V             | 308                  | 26.80            | 38.60                    |
| 2   | 5150.00     | 51.8 AV                 | 54.0           | -2.2        | 1.00 V             | 308                  | 13.20            | 38.60                    |
| 3   | *5180.00    | 108.7 PK                |                |             | 1.00 V             | 309                  | 70.10            | 38.60                    |
| 4   | *5180.00    | 98.9 AV                 |                |             | 1.00 V             | 309                  | 60.30            | 38.60                    |
| 5   | #10360.00   | 62.6 PK                 | 74.0           | -11.4       | 1.66 V             | 275                  | 13.10            | 49.50                    |
| 6   | #10360.00   | 48.7 AV                 | 54.0           | -5.3        | 1.66 V             | 275                  | -0.80            | 49.50                    |

### REMARKS:

1. Emission level (dBuV/m) = Raw Value (dBuV) + Correction Factor (dB/m).
2. Correction Factor (dB/m) = Antenna Factor (dB/m) + Cable Factor (dB).
3. The other emission levels were very low against the limit.
4. Margin value = Emission level – Limit value.
5. " \* ": Fundamental frequency.
6. " # ": The radiated frequency is out of the restricted band.



A D T

| EUT TEST CONDITION       |                 | MEASUREMENT DETAIL |                           |
|--------------------------|-----------------|--------------------|---------------------------|
| CHANNEL                  | Channel 40      | FREQUENCY RANGE    | 1 ~ 40GHz                 |
| INPUT POWER (SYSTEM)     | 120Vac, 60Hz    | DETECTOR FUNCTION  | Peak (PK)<br>Average (AV) |
| ENVIRONMENTAL CONDITIONS | 25deg. C, 67%RH | TESTED BY          | Cedric Wu                 |
| TEST MODE                | A               |                    |                           |

| ANTENNA POLARITY & TEST DISTANCE: HORIZONTAL AT 3 M |             |                         |                |             |                    |                      |                  |                          |
|---|-------------|-------------------------|----------------|-------------|--------------------|----------------------|------------------|--------------------------|
| NO.   | FREQ. (MHz) | EMISSION LEVEL (dBuV/m) | LIMIT (dBuV/m) | MARGIN (dB) | ANTENNA HEIGHT (m) | TABLE ANGLE (Degree) | RAW VALUE (dBuV) | CORRECTION FACTOR (dB/m) |
| 1   | *5200.00    | 102.9 PK                |                |             | 1.00 H             | 185                  | 64.30            | 38.60                    |
| 2   | *5200.00    | 93.2 AV                 |                |             | 1.00 H             | 185                  | 54.60            | 38.60                    |
| 3   | #10400.00   | 58.4 PK                 | 74.0           | -15.6       | 1.00 H             | 157                  | 8.90             | 49.50                    |
| 4   | #10400.00   | 45.2 AV                 | 54.0           | -8.8        | 1.00 H             | 157                  | -4.30            | 49.50                    |
| 5   | 15600.00    | 62.1 PK                 | 74.0           | -11.9       | 1.00 H             | 100                  | 11.40            | 50.70                    |
| 6   | 15600.00    | 49.6 AV                 | 54.0           | -4.4        | 1.00 H             | 100                  | -1.10            | 50.70                    |
| ANTENNA POLARITY & TEST DISTANCE: VERTICAL AT 3 M   |             |                         |                |             |                    |                      |                  |                          |
| NO.   | FREQ. (MHz) | EMISSION LEVEL (dBuV/m) | LIMIT (dBuV/m) | MARGIN (dB) | ANTENNA HEIGHT (m) | TABLE ANGLE (Degree) | RAW VALUE (dBuV) | CORRECTION FACTOR (dB/m) |
| 1   | *5200.00    | 108.2 PK                |                |             | 1.00 V             | 310                  | 69.60            | 38.60                    |
| 2   | *5200.00    | 98.3 AV                 |                |             | 1.00 V             | 310                  | 59.70            | 38.60                    |
| 3   | #10400.00   | 61.3 PK                 | 74.0           | -12.7       | 1.64 V             | 275                  | 11.80            | 49.50                    |
| 4   | #10400.00   | 47.7 AV                 | 54.0           | -6.3        | 1.64 V             | 275                  | -1.80            | 49.50                    |
| 5   | 15600.00    | 64.7 PK                 | 74.0           | -9.3        | 1.12 V             | 309                  | 14.00            | 50.70                    |
| 6   | 15600.00    | 50.9 AV                 | 54.0           | -3.1        | 1.12 V             | 309                  | 0.20             | 50.70                    |

**REMARKS:**

1. Emission level (dBuV/m) = Raw Value (dBuV) + Correction Factor (dB/m).
2. Correction Factor (dB/m) = Antenna Factor (dB/m) + Cable Factor (dB).
3. The other emission levels were very low against the limit.
4. Margin value = Emission level – Limit value.
5. " \* ": Fundamental frequency.
6. " # ": The radiated frequency is out of the restricted band.



A D T

| EUT TEST CONDITION       |                 | MEASUREMENT DETAIL |                           |
|--------------------------|-----------------|--------------------|---------------------------|
| CHANNEL                  | Channel 48      | FREQUENCY RANGE    | 1 ~ 40GHz                 |
| INPUT POWER (SYSTEM)     | 120Vac, 60Hz    | DETECTOR FUNCTION  | Peak (PK)<br>Average (AV) |
| ENVIRONMENTAL CONDITIONS | 25deg. C, 67%RH | TESTED BY          | Cedric Wu                 |
| TEST MODE                | A               |                    |                           |

| ANTENNA POLARITY & TEST DISTANCE: HORIZONTAL AT 3 M |             |                         |                |             |                    |                      |                  |                          |
|---|-------------|-------------------------|----------------|-------------|--------------------|----------------------|------------------|--------------------------|
| NO.   | FREQ. (MHz) | EMISSION LEVEL (dBuV/m) | LIMIT (dBuV/m) | MARGIN (dB) | ANTENNA HEIGHT (m) | TABLE ANGLE (Degree) | RAW VALUE (dBuV) | CORRECTION FACTOR (dB/m) |
| 1   | *5240.00    | 103.8 PK                |                |             | 1.09 H             | 184                  | 65.10            | 38.70                    |
| 2   | *5240.00    | 93.7 AV                 |                |             | 1.09 H             | 184                  | 55.00            | 38.70                    |
| 3   | 5350.00     | 56.9 PK                 | 74.0           | -17.1       | 1.05 H             | 180                  | 18.10            | 38.80                    |
| 4   | 5350.00     | 44.6 AV                 | 54.0           | -9.4        | 1.05 H             | 180                  | 5.80             | 38.80                    |
| 5   | #10480.00   | 58.5 PK                 | 74.0           | -15.5       | 1.00 H             | 155                  | 8.80             | 49.70                    |
| 6   | #10480.00   | 45.3 AV                 | 54.0           | -8.7        | 1.00 H             | 155                  | -4.40            | 49.70                    |
| ANTENNA POLARITY & TEST DISTANCE: VERTICAL AT 3 M   |             |                         |                |             |                    |                      |                  |                          |
| NO.   | FREQ. (MHz) | EMISSION LEVEL (dBuV/m) | LIMIT (dBuV/m) | MARGIN (dB) | ANTENNA HEIGHT (m) | TABLE ANGLE (Degree) | RAW VALUE (dBuV) | CORRECTION FACTOR (dB/m) |
| 1   | *5240.00    | 109.8 PK                |                |             | 1.10 V             | 308                  | 71.10            | 38.70                    |
| 2   | *5240.00    | 99.6 AV                 |                |             | 1.10 V             | 308                  | 60.90            | 38.70                    |
| 3   | 5350.00     | 57.4 PK                 | 74.0           | -16.6       | 1.10 V             | 305                  | 18.60            | 38.80                    |
| 4   | 5350.00     | 44.6 AV                 | 54.0           | -9.4        | 1.10 V             | 305                  | 5.80             | 38.80                    |
| 5   | #10480.00   | 60.6 PK                 | 74.0           | -13.4       | 1.56 V             | 271                  | 10.90            | 49.70                    |
| 6   | #10480.00   | 47.0 AV                 | 54.0           | -7.0        | 1.56 V             | 271                  | -2.70            | 49.70                    |

**REMARKS:**

1. Emission level (dBuV/m) = Raw Value (dBuV) + Correction Factor (dB/m).
2. Correction Factor (dB/m) = Antenna Factor (dB/m) + Cable Factor (dB).
3. The other emission levels were very low against the limit.
4. Margin value = Emission level – Limit value.
5. " \* ": Fundamental frequency.
6. " # ": The radiated frequency is out of the restricted band.



A D T

| EUT TEST CONDITION       |                 | MEASUREMENT DETAIL |                           |
|--------------------------|-----------------|--------------------|---------------------------|
| CHANNEL                  | Channel 52      | FREQUENCY RANGE    | 1 ~ 40GHz                 |
| INPUT POWER (SYSTEM)     | 120Vac, 60Hz    | DETECTOR FUNCTION  | Peak (PK)<br>Average (AV) |
| ENVIRONMENTAL CONDITIONS | 25deg. C, 67%RH | TESTED BY          | Cedric Wu                 |
| TEST MODE                | A               |                    |                           |

| ANTENNA POLARITY & TEST DISTANCE: HORIZONTAL AT 3 M |             |                         |                |             |                    |                      |                  |                          |
|---|-------------|-------------------------|----------------|-------------|--------------------|----------------------|------------------|--------------------------|
| NO.   | FREQ. (MHz) | EMISSION LEVEL (dBuV/m) | LIMIT (dBuV/m) | MARGIN (dB) | ANTENNA HEIGHT (m) | TABLE ANGLE (Degree) | RAW VALUE (dBuV) | CORRECTION FACTOR (dB/m) |
| 1   | 5150.00     | 55.7 PK                 | 74.0           | -18.3       | 1.08 H             | 163                  | 17.10            | 38.60                    |
| 2   | 5150.00     | 44.3 AV                 | 54.0           | -9.7        | 1.08 H             | 163                  | 5.70             | 38.60                    |
| 3   | *5260.00    | 104.4 PK                |                |             | 1.08 H             | 163                  | 65.70            | 38.70                    |
| 4   | *5260.00    | 94.2 AV                 |                |             | 1.08 H             | 163                  | 55.50            | 38.70                    |
| 5   | #10520.00   | 57.8 PK                 | 74.0           | -16.2       | 1.00 H             | 157                  | 8.00             | 49.80                    |
| 6   | #10520.00   | 45.0 AV                 | 54.0           | -9.0        | 1.00 H             | 157                  | -4.80            | 49.80                    |
| ANTENNA POLARITY & TEST DISTANCE: VERTICAL AT 3 M   |             |                         |                |             |                    |                      |                  |                          |
| NO.   | FREQ. (MHz) | EMISSION LEVEL (dBuV/m) | LIMIT (dBuV/m) | MARGIN (dB) | ANTENNA HEIGHT (m) | TABLE ANGLE (Degree) | RAW VALUE (dBuV) | CORRECTION FACTOR (dB/m) |
| 1   | 5150.00     | 57.0 PK                 | 74.0           | -17.0       | 1.30 V             | 305                  | 18.40            | 38.60                    |
| 2   | 5150.00     | 44.4 AV                 | 54.0           | -9.6        | 1.30 V             | 305                  | 5.80             | 38.60                    |
| 3   | *5260.00    | 110.0 PK                |                |             | 1.35 V             | 309                  | 71.30            | 38.70                    |
| 4   | *5260.00    | 99.8 AV                 |                |             | 1.35 V             | 309                  | 61.10            | 38.70                    |
| 5   | #10520.00   | 58.9 PK                 | 74.0           | -15.1       | 1.62 V             | 270                  | 9.10             | 49.80                    |
| 6   | #10520.00   | 46.7 AV                 | 54.0           | -7.3        | 1.62 V             | 270                  | -3.10            | 49.80                    |

**REMARKS:**

1. Emission level (dBuV/m) = Raw Value (dBuV) + Correction Factor (dB/m).
2. Correction Factor (dB/m) = Antenna Factor (dB/m) + Cable Factor (dB).
3. The other emission levels were very low against the limit.
4. Margin value = Emission level – Limit value.
5. " \* ": Fundamental frequency.
6. " # ": The radiated frequency is out of the restricted band.



A D T

| EUT TEST CONDITION       |                 | MEASUREMENT DETAIL |                           |
|--------------------------|-----------------|--------------------|---------------------------|
| CHANNEL                  | Channel 60      | FREQUENCY RANGE    | 1 ~ 40GHz                 |
| INPUT POWER (SYSTEM)     | 120Vac, 60Hz    | DETECTOR FUNCTION  | Peak (PK)<br>Average (AV) |
| ENVIRONMENTAL CONDITIONS | 25deg. C, 67%RH | TESTED BY          | Cedric Wu                 |
| TEST MODE                | A               |                    |                           |

| ANTENNA POLARITY & TEST DISTANCE: HORIZONTAL AT 3 M |             |                         |                |             |                    |                      |                  |                          |
|---|-------------|-------------------------|----------------|-------------|--------------------|----------------------|------------------|--------------------------|
| NO.   | FREQ. (MHz) | EMISSION LEVEL (dBuV/m) | LIMIT (dBuV/m) | MARGIN (dB) | ANTENNA HEIGHT (m) | TABLE ANGLE (Degree) | RAW VALUE (dBuV) | CORRECTION FACTOR (dB/m) |
| 1   | *5300.00    | 104.2 PK                |                |             | 1.18 H             | 181                  | 65.40            | 38.80                    |
| 2   | *5300.00    | 94.4 AV                 |                |             | 1.18 H             | 181                  | 55.60            | 38.80                    |
| 3   | 10600.00    | 57.6 PK                 | 74.0           | -16.4       | 1.00 H             | 160                  | 7.60             | 50.00                    |
| 4   | 10600.00    | 44.8 AV                 | 54.0           | -9.2        | 1.00 H             | 160                  | -5.20            | 50.00                    |
| 5   | 15900.00    | 60.4 PK                 | 74.0           | -13.6       | 1.00 H             | 109                  | 10.30            | 50.10                    |
| 6   | 15900.00    | 48.0 AV                 | 54.0           | -6.0        | 1.00 H             | 109                  | -2.10            | 50.10                    |
| ANTENNA POLARITY & TEST DISTANCE: VERTICAL AT 3 M   |             |                         |                |             |                    |                      |                  |                          |
| NO.   | FREQ. (MHz) | EMISSION LEVEL (dBuV/m) | LIMIT (dBuV/m) | MARGIN (dB) | ANTENNA HEIGHT (m) | TABLE ANGLE (Degree) | RAW VALUE (dBuV) | CORRECTION FACTOR (dB/m) |
| 1   | *5300.00    | 109.4 PK                |                |             | 1.50 V             | 322                  | 70.60            | 38.80                    |
| 2   | *5300.00    | 99.4 AV                 |                |             | 1.50 V             | 322                  | 60.60            | 38.80                    |
| 3   | 10600.00    | 58.6 PK                 | 74.0           | -15.4       | 1.59 V             | 268                  | 8.60             | 50.00                    |
| 4   | 10600.00    | 45.9 AV                 | 54.0           | -8.1        | 1.59 V             | 268                  | -4.10            | 50.00                    |
| 5   | 15900.00    | 62.3 PK                 | 74.0           | -11.7       | 1.17 V             | 310                  | 12.20            | 50.10                    |
| 6   | 15900.00    | 49.4 AV                 | 54.0           | -4.6        | 1.17 V             | 310                  | -0.70            | 50.10                    |

**REMARKS:**

1. Emission level (dBuV/m) = Raw Value (dBuV) + Correction Factor (dB/m).
2. Correction Factor (dB/m) = Antenna Factor (dB/m) + Cable Factor (dB).
3. The other emission levels were very low against the limit.
4. Margin value = Emission level – Limit value.
5. " \* " : Fundamental frequency.



A D T

| EUT TEST CONDITION       |                 | MEASUREMENT DETAIL |                           |
|--------------------------|-----------------|--------------------|---------------------------|
| CHANNEL                  | Channel 64      | FREQUENCY RANGE    | 1 ~ 40GHz                 |
| INPUT POWER (SYSTEM)     | 120Vac, 60Hz    | DETECTOR FUNCTION  | Peak (PK)<br>Average (AV) |
| ENVIRONMENTAL CONDITIONS | 25deg. C, 67%RH | TESTED BY          | Cedric Wu                 |
| TEST MODE                | A               |                    |                           |

| ANTENNA POLARITY & TEST DISTANCE: HORIZONTAL AT 3 M |             |                         |                |             |                    |                      |                  |                          |
|---|-------------|-------------------------|----------------|-------------|--------------------|----------------------|------------------|--------------------------|
| NO.   | FREQ. (MHz) | EMISSION LEVEL (dBuV/m) | LIMIT (dBuV/m) | MARGIN (dB) | ANTENNA HEIGHT (m) | TABLE ANGLE (Degree) | RAW VALUE (dBuV) | CORRECTION FACTOR (dB/m) |
| 1   | *5320.00    | 103.9 PK                |                |             | 1.06 H             | 161                  | 65.10            | 38.80                    |
| 2   | *5320.00    | 93.8 AV                 |                |             | 1.06 H             | 161                  | 55.00            | 38.80                    |
| 3   | 5350.00     | 62.0 PK                 | 74.0           | -12.0       | 1.07 H             | 166                  | 23.20            | 38.80                    |
| 4   | 5350.00     | 46.2 AV                 | 54.0           | -7.8        | 1.07 H             | 166                  | 7.40             | 38.80                    |
| 5   | 10640.00    | 57.5 PK                 | 74.0           | -16.5       | 1.00 H             | 150                  | 7.30             | 50.20                    |
| 6   | 10640.00    | 44.9 AV                 | 54.0           | -9.1        | 1.00 H             | 150                  | -5.30            | 50.20                    |
| ANTENNA POLARITY & TEST DISTANCE: VERTICAL AT 3 M   |             |                         |                |             |                    |                      |                  |                          |
| NO.   | FREQ. (MHz) | EMISSION LEVEL (dBuV/m) | LIMIT (dBuV/m) | MARGIN (dB) | ANTENNA HEIGHT (m) | TABLE ANGLE (Degree) | RAW VALUE (dBuV) | CORRECTION FACTOR (dB/m) |
| 1   | *5320.00    | 110.1 PK                |                |             | 1.34 V             | 308                  | 71.30            | 38.80                    |
| 2   | *5320.00    | 100.3 AV                |                |             | 1.34 V             | 308                  | 61.50            | 38.80                    |
| 3   | 5350.00     | 66.2 PK                 | 74.0           | -7.8        | 1.08 V             | 308                  | 27.40            | 38.80                    |
| 4   | 5350.00     | 49.7 AV                 | 54.0           | -4.3        | 1.08 V             | 308                  | 10.90            | 38.80                    |
| 5   | 10640.00    | 58.3 PK                 | 74.0           | -15.7       | 1.55 V             | 268                  | 8.10             | 50.20                    |
| 6   | 10640.00    | 45.1 AV                 | 54.0           | -8.9        | 1.55 V             | 268                  | -5.10            | 50.20                    |

**REMARKS:**

1. Emission level (dBuV/m) = Raw Value (dBuV) + Correction Factor (dB/m).
2. Correction Factor (dB/m) = Antenna Factor (dB/m) + Cable Factor (dB).
3. The other emission levels were very low against the limit.
4. Margin value = Emission level – Limit value.
5. " \* " : Fundamental frequency.



A D T

| EUT TEST CONDITION       |                 | MEASUREMENT DETAIL |                           |
|--------------------------|-----------------|--------------------|---------------------------|
| CHANNEL                  | Channel 100     | FREQUENCY RANGE    | 1 ~ 40GHz                 |
| INPUT POWER (SYSTEM)     | 120Vac, 60Hz    | DETECTOR FUNCTION  | Peak (PK)<br>Average (AV) |
| ENVIRONMENTAL CONDITIONS | 25deg. C, 67%RH | TESTED BY          | Cedric Wu                 |
| TEST MODE                | A               |                    |                           |

| ANTENNA POLARITY & TEST DISTANCE: HORIZONTAL AT 3 M |             |                         |                |             |                    |                      |                  |                          |
|---|-------------|-------------------------|----------------|-------------|--------------------|----------------------|------------------|--------------------------|
| NO.   | FREQ. (MHz) | EMISSION LEVEL (dBuV/m) | LIMIT (dBuV/m) | MARGIN (dB) | ANTENNA HEIGHT (m) | TABLE ANGLE (Degree) | RAW VALUE (dBuV) | CORRECTION FACTOR (dB/m) |
| 1   | 5460.00     | 57.1 PK                 | 74.0           | -16.9       | 1.13 H             | 170                  | 18.10            | 39.00                    |
| 2   | 5460.00     | 45.3 AV                 | 54.0           | -8.7        | 1.13 H             | 170                  | 6.30             | 39.00                    |
| 3   | #5470.00    | 57.6 PK                 | 74.0           | -16.4       | 1.10 H             | 170                  | 18.60            | 39.00                    |
| 4   | #5470.00    | 44.3 AV                 | 54.0           | -9.7        | 1.10 H             | 170                  | 5.30             | 39.00                    |
| 5   | *5500.00    | 98.4 PK                 |                |             | 1.14 H             | 172                  | 59.30            | 39.10                    |
| 6   | *5500.00    | 88.6 AV                 |                |             | 1.14 H             | 172                  | 49.50            | 39.10                    |
| 7   | 11000.00    | 59.4 PK                 | 74.0           | -14.6       | 1.00 H             | 163                  | 7.80             | 51.60                    |
| 8   | 11000.00    | 46.1 AV                 | 54.0           | -7.9        | 1.00 H             | 163                  | -5.50            | 51.60                    |

| ANTENNA POLARITY & TEST DISTANCE: VERTICAL AT 3 M |             |                         |                |             |                    |                      |                  |                          |
|---|-------------|-------------------------|----------------|-------------|--------------------|----------------------|------------------|--------------------------|
| NO.   | FREQ. (MHz) | EMISSION LEVEL (dBuV/m) | LIMIT (dBuV/m) | MARGIN (dB) | ANTENNA HEIGHT (m) | TABLE ANGLE (Degree) | RAW VALUE (dBuV) | CORRECTION FACTOR (dB/m) |
| 1   | 5460.00     | 59.7 PK                 | 74.0           | -14.3       | 1.32 V             | 292                  | 20.70            | 39.00                    |
| 2   | 5460.00     | 48.7 AV                 | 54.0           | -5.3        | 1.32 V             | 292                  | 9.70             | 39.00                    |
| 3   | #5470.00    | 60.1 PK                 | 74.0           | -13.9       | 1.30 V             | 293                  | 21.10            | 39.00                    |
| 4   | #5470.00    | 45.9 AV                 | 54.0           | -8.1        | 1.30 V             | 293                  | 6.90             | 39.00                    |
| 5   | *5500.00    | 107.3 PK                |                |             | 1.30 V             | 293                  | 68.20            | 39.10                    |
| 6   | *5500.00    | 97.5 AV                 |                |             | 1.30 V             | 293                  | 58.40            | 39.10                    |
| 7   | 11000.00    | 58.2 PK                 | 74.0           | -15.8       | 1.00 V             | 270                  | 6.60             | 51.60                    |
| 8   | 11000.00    | 46.0 AV                 | 54.0           | -8.0        | 1.00 V             | 270                  | -5.60            | 51.60                    |

**REMARKS:**

1. Emission level (dBuV/m) = Raw Value (dBuV) + Correction Factor (dB/m).
2. Correction Factor (dB/m) = Antenna Factor (dB/m) + Cable Factor (dB).
3. The other emission levels were very low against the limit.
4. Margin value = Emission level – Limit value.
5. " \* " : Fundamental frequency.
6. " # " : The radiated frequency is out of the restricted band.





A D T

| EUT TEST CONDITION       |                 | MEASUREMENT DETAIL |                           |
|--------------------------|-----------------|--------------------|---------------------------|
| CHANNEL                  | Channel 116     | FREQUENCY RANGE    | 1 ~ 40GHz                 |
| INPUT POWER (SYSTEM)     | 120Vac, 60Hz    | DETECTOR FUNCTION  | Peak (PK)<br>Average (AV) |
| ENVIRONMENTAL CONDITIONS | 25deg. C, 67%RH | TESTED BY          | Cedric Wu                 |
| TEST MODE                | A               |                    |                           |

| ANTENNA POLARITY & TEST DISTANCE: HORIZONTAL AT 3 M |             |                         |                |             |                    |                      |                  |                          |
|---|-------------|-------------------------|----------------|-------------|--------------------|----------------------|------------------|--------------------------|
| NO.   | FREQ. (MHz) | EMISSION LEVEL (dBuV/m) | LIMIT (dBuV/m) | MARGIN (dB) | ANTENNA HEIGHT (m) | TABLE ANGLE (Degree) | RAW VALUE (dBuV) | CORRECTION FACTOR (dB/m) |
| 1   | *5580.00    | 103.9 PK                |                |             | 1.00 H             | 166                  | 64.70            | 39.20                    |
| 2   | *5580.00    | 93.8 AV                 |                |             | 1.00 H             | 166                  | 54.60            | 39.20                    |
| 3   | 11160.00    | 58.6 PK                 | 74.0           | -15.4       | 1.00 H             | 143                  | 7.30             | 51.30                    |
| 4   | 11160.00    | 46.2 AV                 | 54.0           | -7.8        | 1.00 H             | 143                  | -5.10            | 51.30                    |
| 5   | #16740.00   | 63.8 PK                 | 74.0           | -10.2       | 1.00 H             | 102                  | 10.80            | 53.00                    |
| 6   | #16740.00   | 51.1 AV                 | 54.0           | -2.9        | 1.00 H             | 102                  | -1.90            | 53.00                    |
| ANTENNA POLARITY & TEST DISTANCE: VERTICAL AT 3 M   |             |                         |                |             |                    |                      |                  |                          |
| NO.   | FREQ. (MHz) | EMISSION LEVEL (dBuV/m) | LIMIT (dBuV/m) | MARGIN (dB) | ANTENNA HEIGHT (m) | TABLE ANGLE (Degree) | RAW VALUE (dBuV) | CORRECTION FACTOR (dB/m) |
| 1   | *5580.00    | 111.8 PK                |                |             | 1.28 V             | 291                  | 72.60            | 39.20                    |
| 2   | *5580.00    | 102.0 AV                |                |             | 1.28 V             | 291                  | 62.80            | 39.20                    |
| 3   | 11160.00    | 61.3 PK                 | 74.0           | -12.7       | 1.56 V             | 259                  | 10.00            | 51.30                    |
| 4   | 11160.00    | 48.1 AV                 | 54.0           | -5.9        | 1.56 V             | 259                  | -3.20            | 51.30                    |
| 5   | #16740.00   | 64.9 PK                 | 74.0           | -9.1        | 1.00 V             | 308                  | 11.90            | 53.00                    |
| 6   | #16740.00   | 51.5 AV                 | 54.0           | -2.5        | 1.00 V             | 308                  | -1.50            | 53.00                    |

**REMARKS:**

1. Emission level (dBuV/m) = Raw Value (dBuV) + Correction Factor (dB/m).
2. Correction Factor (dB/m) = Antenna Factor (dB/m) + Cable Factor (dB).
3. The other emission levels were very low against the limit.
4. Margin value = Emission level – Limit value.
5. " \* ": Fundamental frequency.
6. " # ": The radiated frequency is out of the restricted band.



A D T

| EUT TEST CONDITION       |                 | MEASUREMENT DETAIL |                           |
|--------------------------|-----------------|--------------------|---------------------------|
| CHANNEL                  | Channel 140     | FREQUENCY RANGE    | 1 ~ 40GHz                 |
| INPUT POWER (SYSTEM)     | 120Vac, 60Hz    | DETECTOR FUNCTION  | Peak (PK)<br>Average (AV) |
| ENVIRONMENTAL CONDITIONS | 25deg. C, 67%RH | TESTED BY          | Cedric Wu                 |
| TEST MODE                | A               |                    |                           |

| ANTENNA POLARITY & TEST DISTANCE: HORIZONTAL AT 3 M |             |                         |                |             |                    |                      |                  |                          |
|---|-------------|-------------------------|----------------|-------------|--------------------|----------------------|------------------|--------------------------|
| NO.   | FREQ. (MHz) | EMISSION LEVEL (dBuV/m) | LIMIT (dBuV/m) | MARGIN (dB) | ANTENNA HEIGHT (m) | TABLE ANGLE (Degree) | RAW VALUE (dBuV) | CORRECTION FACTOR (dB/m) |
| 1   | *5700.00    | 101.9 PK                |                |             | 1.00 H             | 171                  | 62.40            | 39.50                    |
| 2   | *5700.00    | 92.4 AV                 |                |             | 1.00 H             | 171                  | 52.90            | 39.50                    |
| 3   | #5725.00    | 55.7 PK                 | 74.0           | -18.3       | 1.00 H             | 179                  | 16.20            | 39.50                    |
| 4   | #5725.00    | 44.9 AV                 | 54.0           | -9.1        | 1.00 H             | 179                  | 5.40             | 39.50                    |
| 5   | 11400.00    | 58.8 PK                 | 74.0           | -15.2       | 1.00 H             | 150                  | 7.20             | 51.60                    |
| 6   | 11400.00    | 46.6 AV                 | 54.0           | -7.4        | 1.00 H             | 150                  | -5.00            | 51.60                    |

| ANTENNA POLARITY & TEST DISTANCE: VERTICAL AT 3 M |             |                         |                |             |                    |                      |                  |                          |
|---|-------------|-------------------------|----------------|-------------|--------------------|----------------------|------------------|--------------------------|
| NO.   | FREQ. (MHz) | EMISSION LEVEL (dBuV/m) | LIMIT (dBuV/m) | MARGIN (dB) | ANTENNA HEIGHT (m) | TABLE ANGLE (Degree) | RAW VALUE (dBuV) | CORRECTION FACTOR (dB/m) |
| 1   | *5700.00    | 109.7 PK                |                |             | 1.24 V             | 293                  | 70.20            | 39.50                    |
| 2   | *5700.00    | 100.2 AV                |                |             | 1.24 V             | 293                  | 60.70            | 39.50                    |
| 3   | #5725.00    | 63.4 PK                 | 74.0           | -10.6       | 1.25 V             | 280                  | 23.90            | 39.50                    |
| 4   | #5725.00    | 49.8 AV                 | 54.0           | -4.2        | 1.25 V             | 280                  | 10.30            | 39.50                    |
| 5   | 11400.00    | 60.1 PK                 | 74.0           | -13.9       | 1.65 V             | 260                  | 8.50             | 51.60                    |
| 6   | 11400.00    | 47.5 AV                 | 54.0           | -6.5        | 1.65 V             | 260                  | -4.10            | 51.60                    |

**REMARKS:**

1. Emission level (dBuV/m) = Raw Value (dBuV) + Correction Factor (dB/m).
2. Correction Factor (dB/m) = Antenna Factor (dB/m) + Cable Factor (dB).
3. The other emission levels were very low against the limit.
4. Margin value = Emission level – Limit value.
5. " \* ": Fundamental frequency.
6. " # ": The radiated frequency is out of the restricted band.

**802.11n (20MHz)**

| EUT TEST CONDITION       |                 | MEASUREMENT DETAIL |                           |
|--------------------------|-----------------|--------------------|---------------------------|
| CHANNEL                  | Channel 36      | FREQUENCY RANGE    | 1 ~ 40GHz                 |
| INPUT POWER (SYSTEM)     | 120Vac, 60Hz    | DETECTOR FUNCTION  | Peak (PK)<br>Average (AV) |
| ENVIRONMENTAL CONDITIONS | 25deg. C, 67%RH | TESTED BY          | Cedric Wu                 |
| TEST MODE                | A               |                    |                           |

| ANTENNA POLARITY & TEST DISTANCE: HORIZONTAL AT 3 M |             |                         |                |             |                    |                      |                  |                          |
|---|-------------|-------------------------|----------------|-------------|--------------------|----------------------|------------------|--------------------------|
| NO.   | FREQ. (MHz) | EMISSION LEVEL (dBuV/m) | LIMIT (dBuV/m) | MARGIN (dB) | ANTENNA HEIGHT (m) | TABLE ANGLE (Degree) | RAW VALUE (dBuV) | CORRECTION FACTOR (dB/m) |
| 1   | 5150.00     | 55.3 PK                 | 74.0           | -18.7       | 1.21 H             | 346                  | 16.70            | 38.60                    |
| 2   | 5150.00     | 42.4 AV                 | 54.0           | -11.6       | 1.21 H             | 346                  | 3.80             | 38.60                    |
| 3   | *5180.00    | 96.7 PK                 |                |             | 1.21 H             | 346                  | 58.10            | 38.60                    |
| 4   | *5180.00    | 86.3 AV                 |                |             | 1.21 H             | 346                  | 47.70            | 38.60                    |
| 5   | #10360.00   | 57.0 PK                 | 74.0           | -17.0       | 1.10 H             | 42                   | 7.50             | 49.50                    |
| 6   | #10360.00   | 43.9 AV                 | 54.0           | -10.1       | 1.10 H             | 42                   | -5.60            | 49.50                    |
| ANTENNA POLARITY & TEST DISTANCE: VERTICAL AT 3 M   |             |                         |                |             |                    |                      |                  |                          |
| NO.   | FREQ. (MHz) | EMISSION LEVEL (dBuV/m) | LIMIT (dBuV/m) | MARGIN (dB) | ANTENNA HEIGHT (m) | TABLE ANGLE (Degree) | RAW VALUE (dBuV) | CORRECTION FACTOR (dB/m) |
| 1   | 5150.00     | 54.7 PK                 | 74.0           | -19.3       | 1.23 V             | 45                   | 16.10            | 38.60                    |
| 2   | 5150.00     | 42.3 AV                 | 54.0           | -11.7       | 1.23 V             | 45                   | 3.70             | 38.60                    |
| 3   | *5180.00    | 100.1 PK                |                |             | 1.23 V             | 45                   | 61.50            | 38.60                    |
| 4   | *5180.00    | 91.0 AV                 |                |             | 1.23 V             | 45                   | 52.40            | 38.60                    |
| 5   | #10360.00   | 57.1 PK                 | 74.0           | -16.9       | 1.23 V             | 45                   | 7.60             | 49.50                    |
| 6   | #10360.00   | 44.7 AV                 | 54.0           | -9.3        | 1.23 V             | 45                   | -4.80            | 49.50                    |

**REMARKS:**

1. Emission level (dBuV/m) = Raw Value (dBuV) + Correction Factor (dB/m).
2. Correction Factor (dB/m) = Antenna Factor (dB/m) + Cable Factor (dB).
3. The other emission levels were very low against the limit.
4. Margin value = Emission level – Limit value.
5. " \* ": Fundamental frequency.
6. " # ": The radiated frequency is out of the restricted band.



A D T

| EUT TEST CONDITION       |                 | MEASUREMENT DETAIL |                           |
|--------------------------|-----------------|--------------------|---------------------------|
| CHANNEL                  | Channel 40      | FREQUENCY RANGE    | 1 ~ 40GHz                 |
| INPUT POWER (SYSTEM)     | 120Vac, 60Hz    | DETECTOR FUNCTION  | Peak (PK)<br>Average (AV) |
| ENVIRONMENTAL CONDITIONS | 25deg. C, 67%RH | TESTED BY          | Cedric Wu                 |
| TEST MODE                | A               |                    |                           |

| ANTENNA POLARITY & TEST DISTANCE: HORIZONTAL AT 3 M |             |                         |                |             |                    |                      |                  |                          |
|---|-------------|-------------------------|----------------|-------------|--------------------|----------------------|------------------|--------------------------|
| NO.   | FREQ. (MHz) | EMISSION LEVEL (dBuV/m) | LIMIT (dBuV/m) | MARGIN (dB) | ANTENNA HEIGHT (m) | TABLE ANGLE (Degree) | RAW VALUE (dBuV) | CORRECTION FACTOR (dB/m) |
| 1   | *5200.00    | 97.3 PK                 |                |             | 1.00 H             | 360                  | 58.70            | 38.60                    |
| 2   | *5200.00    | 87.2 AV                 |                |             | 1.00 H             | 360                  | 48.60            | 38.60                    |
| 3   | #10400.00   | 56.1 PK                 | 74.0           | -17.9       | 1.10 H             | 62                   | 6.60             | 49.50                    |
| 4   | #10400.00   | 43.3 AV                 | 54.0           | -10.7       | 1.10 H             | 62                   | -6.20            | 49.50                    |
| 5   | 15600.00    | 57.6 PK                 | 74.0           | -16.4       | 1.12 H             | 36                   | 6.90             | 50.70                    |
| 6   | 15600.00    | 44.9 AV                 | 54.0           | -9.1        | 1.12 H             | 36                   | -5.80            | 50.70                    |
| ANTENNA POLARITY & TEST DISTANCE: VERTICAL AT 3 M   |             |                         |                |             |                    |                      |                  |                          |
| NO.   | FREQ. (MHz) | EMISSION LEVEL (dBuV/m) | LIMIT (dBuV/m) | MARGIN (dB) | ANTENNA HEIGHT (m) | TABLE ANGLE (Degree) | RAW VALUE (dBuV) | CORRECTION FACTOR (dB/m) |
| 1   | *5200.00    | 100.8 PK                |                |             | 1.00 V             | 133                  | 62.20            | 38.60                    |
| 2   | *5200.00    | 91.5 AV                 |                |             | 1.00 V             | 133                  | 52.90            | 38.60                    |
| 3   | #10400.00   | 56.1 PK                 | 74.0           | -17.9       | 1.00 V             | 62                   | 6.60             | 49.50                    |
| 4   | #10400.00   | 44.3 AV                 | 54.0           | -9.7        | 1.00 V             | 62                   | -5.20            | 49.50                    |
| 5   | 15600.00    | 57.8 PK                 | 74.0           | -16.2       | 1.15 V             | 72                   | 7.10             | 50.70                    |
| 6   | 15600.00    | 45.3 AV                 | 54.0           | -8.7        | 1.15 V             | 72                   | -5.40            | 50.70                    |

**REMARKS:**

1. Emission level (dBuV/m) = Raw Value (dBuV) + Correction Factor (dB/m).
2. Correction Factor (dB/m) = Antenna Factor (dB/m) + Cable Factor (dB).
3. The other emission levels were very low against the limit.
4. Margin value = Emission level – Limit value.
5. " \* ": Fundamental frequency.
6. " # ": The radiated frequency is out of the restricted band.



A D T

| EUT TEST CONDITION       |                 | MEASUREMENT DETAIL |                           |
|--------------------------|-----------------|--------------------|---------------------------|
| CHANNEL                  | Channel 48      | FREQUENCY RANGE    | 1 ~ 40GHz                 |
| INPUT POWER (SYSTEM)     | 120Vac, 60Hz    | DETECTOR FUNCTION  | Peak (PK)<br>Average (AV) |
| ENVIRONMENTAL CONDITIONS | 25deg. C, 67%RH | TESTED BY          | Cedric Wu                 |
| TEST MODE                | A               |                    |                           |

| ANTENNA POLARITY & TEST DISTANCE: HORIZONTAL AT 3 M |             |                         |                |             |                    |                      |                  |                          |
|---|-------------|-------------------------|----------------|-------------|--------------------|----------------------|------------------|--------------------------|
| NO.   | FREQ. (MHz) | EMISSION LEVEL (dBuV/m) | LIMIT (dBuV/m) | MARGIN (dB) | ANTENNA HEIGHT (m) | TABLE ANGLE (Degree) | RAW VALUE (dBuV) | CORRECTION FACTOR (dB/m) |
| 1   | *5240.00    | 97.6 PK                 |                |             | 1.19 H             | 343                  | 58.90            | 38.70                    |
| 2   | *5240.00    | 88.0 AV                 |                |             | 1.19 H             | 343                  | 49.30            | 38.70                    |
| 3   | 5350.00     | 55.7 PK                 | 74.0           | -18.3       | 1.19 H             | 343                  | 16.90            | 38.80                    |
| 4   | 5350.00     | 42.6 AV                 | 54.0           | -11.4       | 1.19 H             | 343                  | 3.80             | 38.80                    |
| 5   | #10480.00   | 57.3 PK                 | 74.0           | -16.7       | 1.10 H             | 63                   | 7.60             | 49.70                    |
| 6   | #10480.00   | 44.3 AV                 | 54.0           | -9.7        | 1.10 H             | 63                   | -5.40            | 49.70                    |
| ANTENNA POLARITY & TEST DISTANCE: VERTICAL AT 3 M   |             |                         |                |             |                    |                      |                  |                          |
| NO.   | FREQ. (MHz) | EMISSION LEVEL (dBuV/m) | LIMIT (dBuV/m) | MARGIN (dB) | ANTENNA HEIGHT (m) | TABLE ANGLE (Degree) | RAW VALUE (dBuV) | CORRECTION FACTOR (dB/m) |
| 1   | *5240.00    | 101.7 PK                |                |             | 1.00 V             | 134                  | 63.00            | 38.70                    |
| 2   | *5240.00    | 91.4 AV                 |                |             | 1.00 V             | 134                  | 52.70            | 38.70                    |
| 3   | 5350.00     | 56.8 PK                 | 74.0           | -17.2       | 1.00 V             | 134                  | 18.00            | 38.80                    |
| 4   | 5350.00     | 43.2 AV                 | 54.0           | -10.8       | 1.00 V             | 134                  | 4.40             | 38.80                    |
| 5   | #10480.00   | 56.6 PK                 | 74.0           | -17.4       | 1.00 V             | 134                  | 6.90             | 49.70                    |
| 6   | #10480.00   | 43.9 AV                 | 54.0           | -10.1       | 1.00 V             | 134                  | -5.80            | 49.70                    |

**REMARKS:**

1. Emission level (dBuV/m) = Raw Value (dBuV) + Correction Factor (dB/m).
2. Correction Factor (dB/m) = Antenna Factor (dB/m) + Cable Factor (dB).
3. The other emission levels were very low against the limit.
4. Margin value = Emission level – Limit value.
5. " \* ": Fundamental frequency.
6. " # ": The radiated frequency is out of the restricted band.



A D T

| EUT TEST CONDITION       |                 | MEASUREMENT DETAIL |                           |
|--------------------------|-----------------|--------------------|---------------------------|
| CHANNEL                  | Channel 52      | FREQUENCY RANGE    | 1 ~ 40GHz                 |
| INPUT POWER (SYSTEM)     | 120Vac, 60Hz    | DETECTOR FUNCTION  | Peak (PK)<br>Average (AV) |
| ENVIRONMENTAL CONDITIONS | 25deg. C, 67%RH | TESTED BY          | Cedric Wu                 |
| TEST MODE                | A               |                    |                           |

| ANTENNA POLARITY & TEST DISTANCE: HORIZONTAL AT 3 M |             |                         |                |             |                    |                      |                  |                          |
|---|-------------|-------------------------|----------------|-------------|--------------------|----------------------|------------------|--------------------------|
| NO.   | FREQ. (MHz) | EMISSION LEVEL (dBuV/m) | LIMIT (dBuV/m) | MARGIN (dB) | ANTENNA HEIGHT (m) | TABLE ANGLE (Degree) | RAW VALUE (dBuV) | CORRECTION FACTOR (dB/m) |
| 1   | 5150.00     | 58.1 PK                 | 74.0           | -15.9       | 1.00 H             | 36                   | 19.50            | 38.60                    |
| 2   | 5150.00     | 42.9 AV                 | 54.0           | -11.1       | 1.00 H             | 36                   | 4.30             | 38.60                    |
| 3   | *5260.00    | 97.4 PK                 |                |             | 1.00 H             | 36                   | 58.70            | 38.70                    |
| 4   | *5260.00    | 87.2 AV                 |                |             | 1.00 H             | 36                   | 48.50            | 38.70                    |
| 5   | #10520.00   | 58.3 PK                 | 74.0           | -15.7       | 1.12 H             | 245                  | 8.50             | 49.80                    |
| 6   | #10520.00   | 44.0 AV                 | 54.0           | -10.0       | 1.12 H             | 245                  | -5.80            | 49.80                    |
| ANTENNA POLARITY & TEST DISTANCE: VERTICAL AT 3 M   |             |                         |                |             |                    |                      |                  |                          |
| NO.   | FREQ. (MHz) | EMISSION LEVEL (dBuV/m) | LIMIT (dBuV/m) | MARGIN (dB) | ANTENNA HEIGHT (m) | TABLE ANGLE (Degree) | RAW VALUE (dBuV) | CORRECTION FACTOR (dB/m) |
| 1   | 5150.00     | 57.6 PK                 | 74.0           | -16.4       | 1.00 V             | 139                  | 19.00            | 38.60                    |
| 2   | 5150.00     | 43.7 AV                 | 54.0           | -10.3       | 1.00 V             | 139                  | 5.10             | 38.60                    |
| 3   | *5260.00    | 99.9 PK                 |                |             | 1.00 V             | 139                  | 61.20            | 38.70                    |
| 4   | *5260.00    | 89.8 AV                 |                |             | 1.00 V             | 139                  | 51.10            | 38.70                    |
| 5   | #10520.00   | 57.7 PK                 | 74.0           | -16.3       | 1.14 V             | 63                   | 7.90             | 49.80                    |
| 6   | #10520.00   | 43.9 AV                 | 54.0           | -10.1       | 1.14 V             | 63                   | -5.90            | 49.80                    |

**REMARKS:**

1. Emission level (dBuV/m) = Raw Value (dBuV) + Correction Factor (dB/m).
2. Correction Factor (dB/m) = Antenna Factor (dB/m) + Cable Factor (dB).
3. The other emission levels were very low against the limit.
4. Margin value = Emission level – Limit value.
5. " \* ": Fundamental frequency.
6. " # ": The radiated frequency is out of the restricted band.



A D T

| EUT TEST CONDITION       |                 | MEASUREMENT DETAIL |                           |
|--------------------------|-----------------|--------------------|---------------------------|
| CHANNEL                  | Channel 60      | FREQUENCY RANGE    | 1 ~ 40GHz                 |
| INPUT POWER (SYSTEM)     | 120Vac, 60Hz    | DETECTOR FUNCTION  | Peak (PK)<br>Average (AV) |
| ENVIRONMENTAL CONDITIONS | 25deg. C, 67%RH | TESTED BY          | Cedric Wu                 |
| TEST MODE                | A               |                    |                           |

| ANTENNA POLARITY & TEST DISTANCE: HORIZONTAL AT 3 M |             |                         |                |             |                    |                      |                  |                          |
|---|-------------|-------------------------|----------------|-------------|--------------------|----------------------|------------------|--------------------------|
| NO.   | FREQ. (MHz) | EMISSION LEVEL (dBuV/m) | LIMIT (dBuV/m) | MARGIN (dB) | ANTENNA HEIGHT (m) | TABLE ANGLE (Degree) | RAW VALUE (dBuV) | CORRECTION FACTOR (dB/m) |
| 1   | *5300.00    | 99.8 PK                 |                |             | 1.03 H             | 317                  | 61.00            | 38.80                    |
| 2   | *5300.00    | 90.0 AV                 |                |             | 1.03 H             | 317                  | 51.20            | 38.80                    |
| 3   | 10600.00    | 57.6 PK                 | 74.0           | -16.4       | 1.09 H             | 64                   | 7.60             | 50.00                    |
| 4   | 10600.00    | 43.8 AV                 | 54.0           | -10.2       | 1.09 H             | 64                   | -6.20            | 50.00                    |
| 5   | 15900.00    | 57.2 PK                 | 74.0           | -16.8       | 1.04 H             | 23                   | 7.10             | 50.10                    |
| 6   | 15900.00    | 45.4 AV                 | 54.0           | -8.6        | 1.04 H             | 23                   | -4.70            | 50.10                    |
| ANTENNA POLARITY & TEST DISTANCE: VERTICAL AT 3 M   |             |                         |                |             |                    |                      |                  |                          |
| NO.   | FREQ. (MHz) | EMISSION LEVEL (dBuV/m) | LIMIT (dBuV/m) | MARGIN (dB) | ANTENNA HEIGHT (m) | TABLE ANGLE (Degree) | RAW VALUE (dBuV) | CORRECTION FACTOR (dB/m) |
| 1   | *5300.00    | 99.8 PK                 |                |             | 1.35 V             | 139                  | 61.00            | 38.80                    |
| 2   | *5300.00    | 90.7 AV                 |                |             | 1.35 V             | 139                  | 51.90            | 38.80                    |
| 3   | 10600.00    | 57.3 PK                 | 74.0           | -16.7       | 1.14 V             | 63                   | 7.30             | 50.00                    |
| 4   | 10600.00    | 44.1 AV                 | 54.0           | -9.9        | 1.14 V             | 63                   | -5.90            | 50.00                    |
| 5   | 15900.00    | 57.6 PK                 | 74.0           | -16.4       | 1.10 V             | 139                  | 7.50             | 50.10                    |
| 6   | 15900.00    | 45.1 AV                 | 54.0           | -8.9        | 1.10 V             | 139                  | -5.00            | 50.10                    |

**REMARKS:**

1. Emission level (dBuV/m) = Raw Value (dBuV) + Correction Factor (dB/m).
2. Correction Factor (dB/m) = Antenna Factor (dB/m) + Cable Factor (dB).
3. The other emission levels were very low against the limit.
4. Margin value = Emission level – Limit value.
5. " \* ": Fundamental frequency.



A D T

| EUT TEST CONDITION       |                 | MEASUREMENT DETAIL |                           |
|--------------------------|-----------------|--------------------|---------------------------|
| CHANNEL                  | Channel 64      | FREQUENCY RANGE    | 1 ~ 40GHz                 |
| INPUT POWER (SYSTEM)     | 120Vac, 60Hz    | DETECTOR FUNCTION  | Peak (PK)<br>Average (AV) |
| ENVIRONMENTAL CONDITIONS | 25deg. C, 67%RH | TESTED BY          | Cedric Wu                 |
| TEST MODE                | A               |                    |                           |

| ANTENNA POLARITY & TEST DISTANCE: HORIZONTAL AT 3 M |             |                         |                |             |                    |                      |                  |                          |
|---|-------------|-------------------------|----------------|-------------|--------------------|----------------------|------------------|--------------------------|
| NO.   | FREQ. (MHz) | EMISSION LEVEL (dBuV/m) | LIMIT (dBuV/m) | MARGIN (dB) | ANTENNA HEIGHT (m) | TABLE ANGLE (Degree) | RAW VALUE (dBuV) | CORRECTION FACTOR (dB/m) |
| 1   | *5320.00    | 99.5 PK                 |                |             | 1.03 H             | 317                  | 60.70            | 38.80                    |
| 2   | *5320.00    | 89.2 AV                 |                |             | 1.03 H             | 317                  | 50.40            | 38.80                    |
| 3   | 5350.00     | 57.5 PK                 | 74.0           | -16.5       | 1.03 H             | 317                  | 18.70            | 38.80                    |
| 4   | 5350.00     | 42.4 AV                 | 54.0           | -11.6       | 1.03 H             | 317                  | 3.60             | 38.80                    |
| 5   | 10640.00    | 58.3 PK                 | 74.0           | -15.7       | 1.14 H             | 96                   | 8.10             | 50.20                    |
| 6   | 10640.00    | 44.4 AV                 | 54.0           | -9.6        | 1.14 H             | 96                   | -5.80            | 50.20                    |

| ANTENNA POLARITY & TEST DISTANCE: VERTICAL AT 3 M |             |                         |                |             |                    |                      |                  |                          |
|---|-------------|-------------------------|----------------|-------------|--------------------|----------------------|------------------|--------------------------|
| NO.   | FREQ. (MHz) | EMISSION LEVEL (dBuV/m) | LIMIT (dBuV/m) | MARGIN (dB) | ANTENNA HEIGHT (m) | TABLE ANGLE (Degree) | RAW VALUE (dBuV) | CORRECTION FACTOR (dB/m) |
| 1   | *5320.00    | 100.6 PK                |                |             | 1.08 V             | 136                  | 61.80            | 38.80                    |
| 2   | *5320.00    | 90.7 AV                 |                |             | 1.08 V             | 136                  | 51.90            | 38.80                    |
| 3   | 5350.00     | 57.5 PK                 | 74.0           | -16.5       | 1.08 V             | 136                  | 18.70            | 38.80                    |
| 4   | 5350.00     | 43.1 AV                 | 54.0           | -10.9       | 1.08 V             | 136                  | 4.30             | 38.80                    |
| 5   | 10640.00    | 57.1 PK                 | 74.0           | -16.9       | 1.07 V             | 66                   | 6.90             | 50.20                    |
| 6   | 10640.00    | 44.0 AV                 | 54.0           | -10.0       | 1.07 V             | 66                   | -6.20            | 50.20                    |

**REMARKS:**

1. Emission level (dBuV/m) = Raw Value (dBuV) + Correction Factor (dB/m).
2. Correction Factor (dB/m) = Antenna Factor (dB/m) + Cable Factor (dB).
3. The other emission levels were very low against the limit.
4. Margin value = Emission level – Limit value.
5. " \* " : Fundamental frequency.





A D T

| EUT TEST CONDITION       |                 | MEASUREMENT DETAIL |                           |
|--------------------------|-----------------|--------------------|---------------------------|
| CHANNEL                  | Channel 100     | FREQUENCY RANGE    | 1 ~ 40GHz                 |
| INPUT POWER (SYSTEM)     | 120Vac, 60Hz    | DETECTOR FUNCTION  | Peak (PK)<br>Average (AV) |
| ENVIRONMENTAL CONDITIONS | 25deg. C, 67%RH | TESTED BY          | Cedric Wu                 |
| TEST MODE                | A               |                    |                           |

| ANTENNA POLARITY & TEST DISTANCE: HORIZONTAL AT 3 M |             |                         |                |             |                    |                      |                  |                          |
|---|-------------|-------------------------|----------------|-------------|--------------------|----------------------|------------------|--------------------------|
| NO.   | FREQ. (MHz) | EMISSION LEVEL (dBuV/m) | LIMIT (dBuV/m) | MARGIN (dB) | ANTENNA HEIGHT (m) | TABLE ANGLE (Degree) | RAW VALUE (dBuV) | CORRECTION FACTOR (dB/m) |
| 1   | 5460.00     | 57.1 PK                 | 74.0           | -16.9       | 1.00 H             | 311                  | 18.10            | 39.00                    |
| 2   | 5460.00     | 42.9 AV                 | 54.0           | -11.1       | 1.00 H             | 311                  | 3.90             | 39.00                    |
| 3   | #5470.00    | 56.2 PK                 | 74.0           | -17.8       | 1.00 H             | 311                  | 17.20            | 39.00                    |
| 4   | #5470.00    | 42.9 AV                 | 54.0           | -11.1       | 1.00 H             | 311                  | 3.90             | 39.00                    |
| 5   | *5500.00    | 96.0 PK                 |                |             | 1.00 H             | 311                  | 56.90            | 39.10                    |
| 6   | *5500.00    | 86.3 AV                 |                |             | 1.00 H             | 311                  | 47.20            | 39.10                    |
| 7   | 11000.00    | 59.4 PK                 | 74.0           | -14.6       | 1.17 H             | 52                   | 7.80             | 51.60                    |
| 8   | 11000.00    | 46.1 AV                 | 54.0           | -7.9        | 1.17 H             | 52                   | -5.50            | 51.60                    |
| ANTENNA POLARITY & TEST DISTANCE: VERTICAL AT 3 M   |             |                         |                |             |                    |                      |                  |                          |
| NO.   | FREQ. (MHz) | EMISSION LEVEL (dBuV/m) | LIMIT (dBuV/m) | MARGIN (dB) | ANTENNA HEIGHT (m) | TABLE ANGLE (Degree) | RAW VALUE (dBuV) | CORRECTION FACTOR (dB/m) |
| 1   | 5460.00     | 55.9 PK                 | 74.0           | -18.1       | 1.00 V             | 182                  | 16.90            | 39.00                    |
| 2   | 5460.00     | 43.6 AV                 | 54.0           | -10.4       | 1.00 V             | 182                  | 4.60             | 39.00                    |
| 3   | #5470.00    | 54.0 PK                 | 74.0           | -20.0       | 1.00 V             | 182                  | 15.00            | 39.00                    |
| 4   | #5470.00    | 43.3 AV                 | 54.0           | -10.7       | 1.00 V             | 182                  | 4.30             | 39.00                    |
| 5   | *5500.00    | 101.2 PK                |                |             | 1.00 V             | 182                  | 62.10            | 39.10                    |
| 6   | *5500.00    | 90.8 AV                 |                |             | 1.00 V             | 182                  | 51.70            | 39.10                    |
| 7   | 11000.00    | 59.4 PK                 | 74.0           | -14.6       | 1.04 V             | 62                   | 7.80             | 51.60                    |
| 8   | 11000.00    | 46.4 AV                 | 54.0           | -7.6        | 1.04 V             | 62                   | -5.20            | 51.60                    |

**REMARKS:**

1. Emission level (dBuV/m) = Raw Value (dBuV) + Correction Factor (dB/m).
2. Correction Factor (dB/m) = Antenna Factor (dB/m) + Cable Factor (dB).
3. The other emission levels were very low against the limit.
4. Margin value = Emission level – Limit value.
5. " \* ": Fundamental frequency.
6. " # ": The radiated frequency is out of the restricted band.



A D T

| EUT TEST CONDITION       |                 | MEASUREMENT DETAIL |                           |
|--------------------------|-----------------|--------------------|---------------------------|
| CHANNEL                  | Channel 116     | FREQUENCY RANGE    | 1 ~ 40GHz                 |
| INPUT POWER (SYSTEM)     | 120Vac, 60Hz    | DETECTOR FUNCTION  | Peak (PK)<br>Average (AV) |
| ENVIRONMENTAL CONDITIONS | 25deg. C, 67%RH | TESTED BY          | Cedric Wu                 |
| TEST MODE                | A               |                    |                           |

| ANTENNA POLARITY & TEST DISTANCE: HORIZONTAL AT 3 M |             |                         |                |             |                    |                      |                  |                          |
|---|-------------|-------------------------|----------------|-------------|--------------------|----------------------|------------------|--------------------------|
| NO.   | FREQ. (MHz) | EMISSION LEVEL (dBuV/m) | LIMIT (dBuV/m) | MARGIN (dB) | ANTENNA HEIGHT (m) | TABLE ANGLE (Degree) | RAW VALUE (dBuV) | CORRECTION FACTOR (dB/m) |
| 1   | *5580.00    | 98.0 PK                 |                |             | 1.00 H             | 317                  | 58.80            | 39.20                    |
| 2   | *5580.00    | 88.3 AV                 |                |             | 1.00 H             | 317                  | 49.10            | 39.20                    |
| 3   | 11160.00    | 57.7 PK                 | 74.0           | -16.3       | 1.12 H             | 85                   | 6.40             | 51.30                    |
| 4   | 11160.00    | 45.0 AV                 | 54.0           | -9.0        | 1.12 H             | 85                   | -6.30            | 51.30                    |
| 5   | #16740.00   | 61.0 PK                 | 74.0           | -13.0       | 1.14 H             | 52                   | 8.00             | 53.00                    |
| 6   | #16740.00   | 47.2 AV                 | 54.0           | -6.8        | 1.14 H             | 52                   | -5.80            | 53.00                    |
| ANTENNA POLARITY & TEST DISTANCE: VERTICAL AT 3 M   |             |                         |                |             |                    |                      |                  |                          |
| NO.   | FREQ. (MHz) | EMISSION LEVEL (dBuV/m) | LIMIT (dBuV/m) | MARGIN (dB) | ANTENNA HEIGHT (m) | TABLE ANGLE (Degree) | RAW VALUE (dBuV) | CORRECTION FACTOR (dB/m) |
| 1   | *5580.00    | 98.8 PK                 |                |             | 1.46 V             | 177                  | 59.60            | 39.20                    |
| 2   | *5580.00    | 88.4 AV                 |                |             | 1.46 V             | 177                  | 49.20            | 39.20                    |
| 3   | 11160.00    | 59.0 PK                 | 74.0           | -15.0       | 1.00 V             | 85                   | 7.70             | 51.30                    |
| 4   | 11160.00    | 45.3 AV                 | 54.0           | -8.7        | 1.00 V             | 85                   | -6.00            | 51.30                    |
| 5   | #16740.00   | 60.5 PK                 | 74.0           | -13.5       | 1.00 V             | 47                   | 7.50             | 53.00                    |
| 6   | #16740.00   | 46.8 AV                 | 54.0           | -7.2        | 1.00 V             | 47                   | -6.20            | 53.00                    |

**REMARKS:**

1. Emission level (dBuV/m) = Raw Value (dBuV) + Correction Factor (dB/m).
2. Correction Factor (dB/m) = Antenna Factor (dB/m) + Cable Factor (dB).
3. The other emission levels were very low against the limit.
4. Margin value = Emission level – Limit value.
5. " \* ": Fundamental frequency.
6. " # ": The radiated frequency is out of the restricted band.



A D T

| EUT TEST CONDITION       |                 | MEASUREMENT DETAIL |                           |
|--------------------------|-----------------|--------------------|---------------------------|
| CHANNEL                  | Channel 140     | FREQUENCY RANGE    | 1 ~ 40GHz                 |
| INPUT POWER (SYSTEM)     | 120Vac, 60Hz    | DETECTOR FUNCTION  | Peak (PK)<br>Average (AV) |
| ENVIRONMENTAL CONDITIONS | 25deg. C, 67%RH | TESTED BY          | Cedric Wu                 |
| TEST MODE                | A               |                    |                           |

| ANTENNA POLARITY & TEST DISTANCE: HORIZONTAL AT 3 M |             |                         |                |             |                    |                      |                  |                          |
|---|-------------|-------------------------|----------------|-------------|--------------------|----------------------|------------------|--------------------------|
| NO.   | FREQ. (MHz) | EMISSION LEVEL (dBuV/m) | LIMIT (dBuV/m) | MARGIN (dB) | ANTENNA HEIGHT (m) | TABLE ANGLE (Degree) | RAW VALUE (dBuV) | CORRECTION FACTOR (dB/m) |
| 1   | *5700.00    | 97.5 PK                 |                |             | 1.00 H             | 315                  | 58.00            | 39.50                    |
| 2   | *5700.00    | 87.4 AV                 |                |             | 1.00 H             | 315                  | 47.90            | 39.50                    |
| 3   | #5725.00    | 57.4 PK                 | 74.0           | -16.6       | 1.00 H             | 315                  | 17.90            | 39.50                    |
| 4   | #5725.00    | 45.3 AV                 | 54.0           | -8.7        | 1.00 H             | 315                  | 5.80             | 39.50                    |
| 5   | 11400.00    | 59.9 PK                 | 74.0           | -14.1       | 1.08 H             | 41                   | 8.30             | 51.60                    |
| 6   | 11400.00    | 46.8 AV                 | 54.0           | -7.2        | 1.08 H             | 41                   | -4.80            | 51.60                    |
| ANTENNA POLARITY & TEST DISTANCE: VERTICAL AT 3 M   |             |                         |                |             |                    |                      |                  |                          |
| NO.   | FREQ. (MHz) | EMISSION LEVEL (dBuV/m) | LIMIT (dBuV/m) | MARGIN (dB) | ANTENNA HEIGHT (m) | TABLE ANGLE (Degree) | RAW VALUE (dBuV) | CORRECTION FACTOR (dB/m) |
| 1   | *5700.00    | 99.2 PK                 |                |             | 1.00 V             | 139                  | 59.70            | 39.50                    |
| 2   | *5700.00    | 89.3 AV                 |                |             | 1.00 V             | 139                  | 49.80            | 39.50                    |
| 3   | #5725.00    | 59.1 PK                 | 74.0           | -14.9       | 1.00 V             | 139                  | 19.60            | 39.50                    |
| 4   | #5725.00    | 44.7 AV                 | 54.0           | -9.3        | 1.00 V             | 139                  | 5.20             | 39.50                    |
| 5   | 11400.00    | 59.2 PK                 | 74.0           | -14.8       | 1.12 V             | 95                   | 7.60             | 51.60                    |
| 6   | 11400.00    | 46.8 AV                 | 54.0           | -7.2        | 1.12 V             | 95                   | -4.80            | 51.60                    |

**REMARKS:**

1. Emission level (dBuV/m) = Raw Value (dBuV) + Correction Factor (dB/m).
2. Correction Factor (dB/m) = Antenna Factor (dB/m) + Cable Factor (dB).
3. The other emission levels were very low against the limit.
4. Margin value = Emission level – Limit value.
5. " \* ": Fundamental frequency.
6. " # ": The radiated frequency is out of the restricted band.

802.11n (40MHz)

| EUT TEST CONDITION       |                 | MEASUREMENT DETAIL |                           |
|--------------------------|-----------------|--------------------|---------------------------|
| CHANNEL                  | Channel 38      | FREQUENCY RANGE    | 1 ~ 40GHz                 |
| INPUT POWER (SYSTEM)     | 120Vac, 60Hz    | DETECTOR FUNCTION  | Peak (PK)<br>Average (AV) |
| ENVIRONMENTAL CONDITIONS | 25deg. C, 67%RH | TESTED BY          | Cedric Wu                 |
| TEST MODE                | A               |                    |                           |

| ANTENNA POLARITY & TEST DISTANCE: HORIZONTAL AT 3 M |             |                         |                |             |                    |                      |                  |                          |
|---|-------------|-------------------------|----------------|-------------|--------------------|----------------------|------------------|--------------------------|
| NO.   | FREQ. (MHz) | EMISSION LEVEL (dBuV/m) | LIMIT (dBuV/m) | MARGIN (dB) | ANTENNA HEIGHT (m) | TABLE ANGLE (Degree) | RAW VALUE (dBuV) | CORRECTION FACTOR (dB/m) |
| 1   | 5150.00     | 56.9 PK                 | 74.0           | -17.1       | 1.00 H             | 37                   | 18.30            | 38.60                    |
| 2   | 5150.00     | 42.9 AV                 | 54.0           | -11.1       | 1.00 H             | 37                   | 4.30             | 38.60                    |
| 3   | *5190.00    | 93.3 PK                 |                |             | 1.00 H             | 37                   | 54.70            | 38.60                    |
| 4   | *5190.00    | 84.1 AV                 |                |             | 1.00 H             | 37                   | 45.50            | 38.60                    |
| 5   | #10380.00   | 57.9 PK                 | 74.0           | -16.1       | 1.14 H             | 52                   | 8.40             | 49.50                    |
| 6   | #10380.00   | 43.5 AV                 | 54.0           | -10.5       | 1.14 H             | 52                   | -6.00            | 49.50                    |
| ANTENNA POLARITY & TEST DISTANCE: VERTICAL AT 3 M   |             |                         |                |             |                    |                      |                  |                          |
| NO.   | FREQ. (MHz) | EMISSION LEVEL (dBuV/m) | LIMIT (dBuV/m) | MARGIN (dB) | ANTENNA HEIGHT (m) | TABLE ANGLE (Degree) | RAW VALUE (dBuV) | CORRECTION FACTOR (dB/m) |
| 1   | 5150.00     | 57.4 PK                 | 74.0           | -16.6       | 1.10 V             | 129                  | 18.80            | 38.60                    |
| 2   | 5150.00     | 43.6 AV                 | 54.0           | -10.4       | 1.10 V             | 129                  | 5.00             | 38.60                    |
| 3   | *5190.00    | 96.6 PK                 |                |             | 1.10 V             | 129                  | 58.00            | 38.60                    |
| 4   | *5190.00    | 87.2 AV                 |                |             | 1.10 V             | 129                  | 48.60            | 38.60                    |
| 5   | #10380.00   | 57.5 PK                 | 74.0           | -16.5       | 1.00 V             | 42                   | 8.00             | 49.50                    |
| 6   | #10380.00   | 44.5 AV                 | 54.0           | -9.5        | 1.00 V             | 42                   | -5.00            | 49.50                    |

**REMARKS:**

1. Emission level (dBuV/m) = Raw Value (dBuV) + Correction Factor (dB/m).
2. Correction Factor (dB/m) = Antenna Factor (dB/m) + Cable Factor (dB).
3. The other emission levels were very low against the limit.
4. Margin value = Emission level – Limit value.
5. " \* ": Fundamental frequency.
6. " # ": The radiated frequency is out of the restricted band.



A D T

| EUT TEST CONDITION       |                 | MEASUREMENT DETAIL |                           |
|--------------------------|-----------------|--------------------|---------------------------|
| CHANNEL                  | Channel 46      | FREQUENCY RANGE    | 1 ~ 40GHz                 |
| INPUT POWER (SYSTEM)     | 120Vac, 60Hz    | DETECTOR FUNCTION  | Peak (PK)<br>Average (AV) |
| ENVIRONMENTAL CONDITIONS | 25deg. C, 67%RH | TESTED BY          | Cedric Wu                 |
| TEST MODE                | A               |                    |                           |

| ANTENNA POLARITY & TEST DISTANCE: HORIZONTAL AT 3 M |             |                         |                |             |                    |                      |                  |                          |
|---|-------------|-------------------------|----------------|-------------|--------------------|----------------------|------------------|--------------------------|
| NO.   | FREQ. (MHz) | EMISSION LEVEL (dBuV/m) | LIMIT (dBuV/m) | MARGIN (dB) | ANTENNA HEIGHT (m) | TABLE ANGLE (Degree) | RAW VALUE (dBuV) | CORRECTION FACTOR (dB/m) |
| 1   | *5230.00    | 95.2 PK                 |                |             | 1.30 H             | 347                  | 56.60            | 38.60                    |
| 2   | *5230.00    | 85.1 AV                 |                |             | 1.30 H             | 347                  | 46.50            | 38.60                    |
| 3   | 5350.00     | 55.9 PK                 | 74.0           | -18.1       | 1.30 H             | 347                  | 17.10            | 38.80                    |
| 4   | 5350.00     | 42.4 AV                 | 54.0           | -11.6       | 1.30 H             | 347                  | 3.60             | 38.80                    |
| 5   | #10460.00   | 57.4 PK                 | 74.0           | -16.6       | 1.08 H             | 42                   | 7.80             | 49.60                    |
| 6   | #10460.00   | 43.6 AV                 | 54.0           | -10.4       | 1.08 H             | 42                   | -6.00            | 49.60                    |
| ANTENNA POLARITY & TEST DISTANCE: VERTICAL AT 3 M   |             |                         |                |             |                    |                      |                  |                          |
| NO.   | FREQ. (MHz) | EMISSION LEVEL (dBuV/m) | LIMIT (dBuV/m) | MARGIN (dB) | ANTENNA HEIGHT (m) | TABLE ANGLE (Degree) | RAW VALUE (dBuV) | CORRECTION FACTOR (dB/m) |
| 1   | *5230.00    | 96.7 PK                 |                |             | 1.11 V             | 133                  | 58.10            | 38.60                    |
| 2   | *5230.00    | 87.5 AV                 |                |             | 1.11 V             | 133                  | 48.90            | 38.60                    |
| 3   | 5350.00     | 57.5 PK                 | 74.0           | -16.5       | 1.11 V             | 133                  | 18.70            | 38.80                    |
| 4   | 5350.00     | 44.0 AV                 | 54.0           | -10.0       | 1.11 V             | 133                  | 5.20             | 38.80                    |
| 5   | #10460.00   | 59.1 PK                 | 74.0           | -14.9       | 1.17 V             | 238                  | 9.50             | 49.60                    |
| 6   | #10460.00   | 44.6 AV                 | 54.0           | -9.4        | 1.17 V             | 238                  | -5.00            | 49.60                    |

**REMARKS:**

1. Emission level (dBuV/m) = Raw Value (dBuV) + Correction Factor (dB/m).
2. Correction Factor (dB/m) = Antenna Factor (dB/m) + Cable Factor (dB).
3. The other emission levels were very low against the limit.
4. Margin value = Emission level – Limit value.
5. " \* ": Fundamental frequency.
6. " # ": The radiated frequency is out of the restricted band.



A D T

| EUT TEST CONDITION       |                 | MEASUREMENT DETAIL |                           |
|--------------------------|-----------------|--------------------|---------------------------|
| CHANNEL                  | Channel 54      | FREQUENCY RANGE    | 1 ~ 40GHz                 |
| INPUT POWER (SYSTEM)     | 120Vac, 60Hz    | DETECTOR FUNCTION  | Peak (PK)<br>Average (AV) |
| ENVIRONMENTAL CONDITIONS | 25deg. C, 67%RH | TESTED BY          | Cedric Wu                 |
| TEST MODE                | A               |                    |                           |

| ANTENNA POLARITY & TEST DISTANCE: HORIZONTAL AT 3 M |             |                         |                |             |                    |                      |                  |                          |
|---|-------------|-------------------------|----------------|-------------|--------------------|----------------------|------------------|--------------------------|
| NO.   | FREQ. (MHz) | EMISSION LEVEL (dBuV/m) | LIMIT (dBuV/m) | MARGIN (dB) | ANTENNA HEIGHT (m) | TABLE ANGLE (Degree) | RAW VALUE (dBuV) | CORRECTION FACTOR (dB/m) |
| 1   | 5150.00     | 57.9 PK                 | 74.0           | -16.1       | 1.40 H             | 313                  | 19.30            | 38.60                    |
| 2   | 5150.00     | 42.3 AV                 | 54.0           | -11.7       | 1.40 H             | 313                  | 3.70             | 38.60                    |
| 3   | *5270.00    | 95.5 PK                 |                |             | 1.40 H             | 313                  | 56.80            | 38.70                    |
| 4   | *5270.00    | 85.5 AV                 |                |             | 1.40 H             | 313                  | 46.80            | 38.70                    |
| 5   | #10540.00   | 59.1 PK                 | 74.0           | -14.9       | 1.17 H             | 85                   | 9.30             | 49.80                    |
| 6   | #10540.00   | 43.8 AV                 | 54.0           | -10.2       | 1.17 H             | 85                   | -6.00            | 49.80                    |
| ANTENNA POLARITY & TEST DISTANCE: VERTICAL AT 3 M   |             |                         |                |             |                    |                      |                  |                          |
| NO.   | FREQ. (MHz) | EMISSION LEVEL (dBuV/m) | LIMIT (dBuV/m) | MARGIN (dB) | ANTENNA HEIGHT (m) | TABLE ANGLE (Degree) | RAW VALUE (dBuV) | CORRECTION FACTOR (dB/m) |
| 1   | 5150.00     | 56.7 PK                 | 74.0           | -17.3       | 1.00 V             | 139                  | 18.10            | 38.60                    |
| 2   | 5150.00     | 42.7 AV                 | 54.0           | -11.3       | 1.00 V             | 139                  | 4.10             | 38.60                    |
| 3   | *5270.00    | 97.1 PK                 |                |             | 1.00 V             | 139                  | 58.40            | 38.70                    |
| 4   | *5270.00    | 87.8 AV                 |                |             | 1.00 V             | 139                  | 49.10            | 38.70                    |
| 5   | #10540.00   | 58.3 PK                 | 74.0           | -15.7       | 1.10 V             | 88                   | 8.50             | 49.80                    |
| 6   | #10540.00   | 45.0 AV                 | 54.0           | -9.0        | 1.10 V             | 88                   | -4.80            | 49.80                    |

**REMARKS:**

1. Emission level (dBuV/m) = Raw Value (dBuV) + Correction Factor (dB/m).
2. Correction Factor (dB/m) = Antenna Factor (dB/m) + Cable Factor (dB).
3. The other emission levels were very low against the limit.
4. Margin value = Emission level – Limit value.
5. " \* ": Fundamental frequency.
6. " # ": The radiated frequency is out of the restricted band.



A D T

| EUT TEST CONDITION       |                 | MEASUREMENT DETAIL |                           |
|--------------------------|-----------------|--------------------|---------------------------|
| CHANNEL                  | Channel 62      | FREQUENCY RANGE    | 1 ~ 40GHz                 |
| INPUT POWER (SYSTEM)     | 120Vac, 60Hz    | DETECTOR FUNCTION  | Peak (PK)<br>Average (AV) |
| ENVIRONMENTAL CONDITIONS | 25deg. C, 67%RH | TESTED BY          | Cedric Wu                 |
| TEST MODE                | A               |                    |                           |

| ANTENNA POLARITY & TEST DISTANCE: HORIZONTAL AT 3 M |             |                         |                |             |                    |                      |                  |                          |
|---|-------------|-------------------------|----------------|-------------|--------------------|----------------------|------------------|--------------------------|
| NO.   | FREQ. (MHz) | EMISSION LEVEL (dBuV/m) | LIMIT (dBuV/m) | MARGIN (dB) | ANTENNA HEIGHT (m) | TABLE ANGLE (Degree) | RAW VALUE (dBuV) | CORRECTION FACTOR (dB/m) |
| 1   | *5310.00    | 96.1 PK                 |                |             | 1.03 H             | 318                  | 57.30            | 38.80                    |
| 2   | *5310.00    | 86.5 AV                 |                |             | 1.03 H             | 318                  | 47.70            | 38.80                    |
| 3   | 5350.00     | 58.8 PK                 | 74.0           | -15.2       | 4.00 H             | 315                  | 20.00            | 38.80                    |
| 4   | 5350.00     | 45.0 AV                 | 54.0           | -9.0        | 4.00 H             | 315                  | 6.20             | 38.80                    |
| 5   | 10620.00    | 58.0 PK                 | 74.0           | -16.0       | 1.14 H             | 55                   | 7.90             | 50.10                    |
| 6   | 10620.00    | 43.8 AV                 | 54.0           | -10.2       | 1.14 H             | 55                   | -6.30            | 50.10                    |
| ANTENNA POLARITY & TEST DISTANCE: VERTICAL AT 3 M   |             |                         |                |             |                    |                      |                  |                          |
| NO.   | FREQ. (MHz) | EMISSION LEVEL (dBuV/m) | LIMIT (dBuV/m) | MARGIN (dB) | ANTENNA HEIGHT (m) | TABLE ANGLE (Degree) | RAW VALUE (dBuV) | CORRECTION FACTOR (dB/m) |
| 1   | *5310.00    | 97.8 PK                 |                |             | 1.23 V             | 135                  | 59.00            | 38.80                    |
| 2   | *5310.00    | 88.1 AV                 |                |             | 1.23 V             | 135                  | 49.30            | 38.80                    |
| 3   | 5350.00     | 59.1 PK                 | 74.0           | -14.9       | 1.23 V             | 135                  | 20.30            | 38.80                    |
| 4   | 5350.00     | 47.2 AV                 | 54.0           | -6.8        | 1.23 V             | 135                  | 8.40             | 38.80                    |
| 5   | 10620.00    | 57.9 PK                 | 74.0           | -16.1       | 1.15 V             | 96                   | 7.80             | 50.10                    |
| 6   | 10620.00    | 45.2 AV                 | 54.0           | -8.8        | 1.15 V             | 96                   | -4.90            | 50.10                    |

**REMARKS:**

1. Emission level (dBuV/m) = Raw Value (dBuV) + Correction Factor (dB/m).
2. Correction Factor (dB/m) = Antenna Factor (dB/m) + Cable Factor (dB).
3. The other emission levels were very low against the limit.
4. Margin value = Emission level – Limit value.
5. " \* " : Fundamental frequency.



A D T

| EUT TEST CONDITION       |                 | MEASUREMENT DETAIL |                           |
|--------------------------|-----------------|--------------------|---------------------------|
| CHANNEL                  | Channel 102     | FREQUENCY RANGE    | 1 ~ 40GHz                 |
| INPUT POWER (SYSTEM)     | 120Vac, 60Hz    | DETECTOR FUNCTION  | Peak (PK)<br>Average (AV) |
| ENVIRONMENTAL CONDITIONS | 25deg. C, 67%RH | TESTED BY          | Cedric Wu                 |
| TEST MODE                | A               |                    |                           |

| ANTENNA POLARITY & TEST DISTANCE: HORIZONTAL AT 3 M |             |                         |                |             |                    |                      |                  |                          |
|---|-------------|-------------------------|----------------|-------------|--------------------|----------------------|------------------|--------------------------|
| NO.   | FREQ. (MHz) | EMISSION LEVEL (dBuV/m) | LIMIT (dBuV/m) | MARGIN (dB) | ANTENNA HEIGHT (m) | TABLE ANGLE (Degree) | RAW VALUE (dBuV) | CORRECTION FACTOR (dB/m) |
| 1   | 5460.00     | 54.9 PK                 | 74.0           | -19.1       | 1.00 H             | 311                  | 15.90            | 39.00                    |
| 2   | 5460.00     | 43.4 AV                 | 54.0           | -10.6       | 1.00 H             | 311                  | 4.40             | 39.00                    |
| 3   | #5470.00    | 59.3 PK                 | 74.0           | -14.7       | 1.00 H             | 311                  | 20.30            | 39.00                    |
| 4   | #5470.00    | 46.9 AV                 | 54.0           | -7.1        | 1.00 H             | 311                  | 7.90             | 39.00                    |
| 5   | *5510.00    | 93.5 PK                 |                |             | 1.02 H             | 316                  | 54.40            | 39.10                    |
| 6   | *5510.00    | 84.4 AV                 |                |             | 1.02 H             | 316                  | 45.30            | 39.10                    |
| 7   | 11020.00    | 60.2 PK                 | 74.0           | -13.8       | 1.10 H             | 96                   | 8.70             | 51.50                    |
| 8   | 11020.00    | 46.0 AV                 | 54.0           | -8.0        | 1.10 H             | 96                   | -5.50            | 51.50                    |
| ANTENNA POLARITY & TEST DISTANCE: VERTICAL AT 3 M   |             |                         |                |             |                    |                      |                  |                          |
| NO.   | FREQ. (MHz) | EMISSION LEVEL (dBuV/m) | LIMIT (dBuV/m) | MARGIN (dB) | ANTENNA HEIGHT (m) | TABLE ANGLE (Degree) | RAW VALUE (dBuV) | CORRECTION FACTOR (dB/m) |
| 1   | 5460.00     | 54.7 PK                 | 74.0           | -19.3       | 1.00 V             | 183                  | 15.70            | 39.00                    |
| 2   | 5460.00     | 43.0 AV                 | 54.0           | -11.0       | 1.00 V             | 183                  | 4.00             | 39.00                    |
| 3   | #5470.00    | 57.0 PK                 | 74.0           | -17.0       | 1.00 V             | 183                  | 18.00            | 39.00                    |
| 4   | #5470.00    | 46.7 AV                 | 54.0           | -7.3        | 1.00 V             | 183                  | 7.70             | 39.00                    |
| 5   | *5510.00    | 97.9 PK                 |                |             | 1.00 V             | 183                  | 58.80            | 39.10                    |
| 6   | *5510.00    | 88.1 AV                 |                |             | 1.00 V             | 183                  | 49.00            | 39.10                    |
| 7   | 11020.00    | 60.5 PK                 | 74.0           | -13.5       | 1.00 V             | 51                   | 9.00             | 51.50                    |
| 8   | 11020.00    | 46.1 AV                 | 54.0           | -7.9        | 1.00 V             | 51                   | -5.40            | 51.50                    |

**REMARKS:**

1. Emission level (dBuV/m) = Raw Value (dBuV) + Correction Factor (dB/m).
2. Correction Factor (dB/m) = Antenna Factor (dB/m) + Cable Factor (dB).
3. The other emission levels were very low against the limit.
4. Margin value = Emission level – Limit value.
5. " \* ": Fundamental frequency.
6. " # ": The radiated frequency is out of the restricted band.





A D T

| EUT TEST CONDITION       |                 | MEASUREMENT DETAIL |                           |
|--------------------------|-----------------|--------------------|---------------------------|
| CHANNEL                  | Channel 110     | FREQUENCY RANGE    | 1 ~ 40GHz                 |
| INPUT POWER (SYSTEM)     | 120Vac, 60Hz    | DETECTOR FUNCTION  | Peak (PK)<br>Average (AV) |
| ENVIRONMENTAL CONDITIONS | 25deg. C, 67%RH | TESTED BY          | Cedric Wu                 |
| TEST MODE                | A               |                    |                           |

| ANTENNA POLARITY & TEST DISTANCE: HORIZONTAL AT 3 M |             |                         |                |             |                    |                      |                  |                          |
|---|-------------|-------------------------|----------------|-------------|--------------------|----------------------|------------------|--------------------------|
| NO.   | FREQ. (MHz) | EMISSION LEVEL (dBuV/m) | LIMIT (dBuV/m) | MARGIN (dB) | ANTENNA HEIGHT (m) | TABLE ANGLE (Degree) | RAW VALUE (dBuV) | CORRECTION FACTOR (dB/m) |
| 1   | *5550.00    | 96.8 PK                 |                |             | 1.00 H             | 309                  | 57.70            | 39.10                    |
| 2   | *5550.00    | 86.8 AV                 |                |             | 1.00 H             | 309                  | 47.70            | 39.10                    |
| 3   | 11100.00    | 59.2 PK                 | 74.0           | -14.8       | 1.05 H             | 45                   | 7.90             | 51.30                    |
| 4   | 11100.00    | 44.5 AV                 | 54.0           | -9.5        | 1.05 H             | 45                   | -6.80            | 51.30                    |
| 5   | #16650.00   | 59.3 PK                 | 74.0           | -14.7       | 1.10 H             | 47                   | 6.70             | 52.60                    |
| 6   | #16650.00   | 47.0 AV                 | 54.0           | -7.0        | 1.10 H             | 47                   | -5.60            | 52.60                    |
| ANTENNA POLARITY & TEST DISTANCE: VERTICAL AT 3 M   |             |                         |                |             |                    |                      |                  |                          |
| NO.   | FREQ. (MHz) | EMISSION LEVEL (dBuV/m) | LIMIT (dBuV/m) | MARGIN (dB) | ANTENNA HEIGHT (m) | TABLE ANGLE (Degree) | RAW VALUE (dBuV) | CORRECTION FACTOR (dB/m) |
| 1   | *5550.00    | 102.1 PK                |                |             | 1.55 V             | 94                   | 63.00            | 39.10                    |
| 2   | *5550.00    | 92.0 AV                 |                |             | 1.55 V             | 94                   | 52.90            | 39.10                    |
| 3   | 11110.00    | 57.6 PK                 | 74.0           | -16.4       | 1.00 V             | 52                   | 6.30             | 51.30                    |
| 4   | 11110.00    | 44.7 AV                 | 54.0           | -9.3        | 1.00 V             | 52                   | -6.60            | 51.30                    |
| 5   | #16650.00   | 60.3 PK                 | 74.0           | -13.7       | 1.12 V             | 55                   | 7.70             | 52.60                    |
| 6   | #16650.00   | 47.0 AV                 | 54.0           | -7.0        | 1.12 V             | 55                   | -5.60            | 52.60                    |

**REMARKS:**

1. Emission level (dBuV/m) = Raw Value (dBuV) + Correction Factor (dB/m).
2. Correction Factor (dB/m) = Antenna Factor (dB/m) + Cable Factor (dB).
3. The other emission levels were very low against the limit.
4. Margin value = Emission level – Limit value.
5. " \* ": Fundamental frequency.
6. " # ": The radiated frequency is out of the restricted band.



A D T

| EUT TEST CONDITION       |                 | MEASUREMENT DETAIL |                           |
|--------------------------|-----------------|--------------------|---------------------------|
| CHANNEL                  | Channel 134     | FREQUENCY RANGE    | 1 ~ 40GHz                 |
| INPUT POWER (SYSTEM)     | 120Vac, 60Hz    | DETECTOR FUNCTION  | Peak (PK)<br>Average (AV) |
| ENVIRONMENTAL CONDITIONS | 25deg. C, 67%RH | TESTED BY          | Cedric Wu                 |
| TEST MODE                | A               |                    |                           |

| ANTENNA POLARITY & TEST DISTANCE: HORIZONTAL AT 3 M |             |                         |                |             |                    |                      |                  |                          |
|---|-------------|-------------------------|----------------|-------------|--------------------|----------------------|------------------|--------------------------|
| NO.   | FREQ. (MHz) | EMISSION LEVEL (dBuV/m) | LIMIT (dBuV/m) | MARGIN (dB) | ANTENNA HEIGHT (m) | TABLE ANGLE (Degree) | RAW VALUE (dBuV) | CORRECTION FACTOR (dB/m) |
| 1   | *5670.00    | 95.1 PK                 |                |             | 1.00 H             | 316                  | 55.70            | 39.40                    |
| 2   | *5670.00    | 85.0 AV                 |                |             | 1.00 H             | 316                  | 45.60            | 39.40                    |
| 3   | #5725.00    | 56.3 PK                 | 74.0           | -17.7       | 1.00 H             | 316                  | 16.80            | 39.50                    |
| 4   | #5725.00    | 44.6 AV                 | 54.0           | -9.4        | 1.00 H             | 316                  | 5.10             | 39.50                    |
| 5   | 11340.00    | 60.4 PK                 | 74.0           | -13.6       | 1.15 H             | 74                   | 8.70             | 51.70                    |
| 6   | 11340.00    | 46.4 AV                 | 54.0           | -7.6        | 1.15 H             | 74                   | -5.30            | 51.70                    |
| ANTENNA POLARITY & TEST DISTANCE: VERTICAL AT 3 M   |             |                         |                |             |                    |                      |                  |                          |
| NO.   | FREQ. (MHz) | EMISSION LEVEL (dBuV/m) | LIMIT (dBuV/m) | MARGIN (dB) | ANTENNA HEIGHT (m) | TABLE ANGLE (Degree) | RAW VALUE (dBuV) | CORRECTION FACTOR (dB/m) |
| 1   | *5670.00    | 97.6 PK                 |                |             | 1.00 V             | 102                  | 58.20            | 39.40                    |
| 2   | *5670.00    | 88.4 AV                 |                |             | 1.00 V             | 102                  | 49.00            | 39.40                    |
| 3   | #5725.00    | 59.4 PK                 | 74.0           | -14.6       | 1.00 V             | 102                  | 19.90            | 39.50                    |
| 4   | #5725.00    | 46.4 AV                 | 54.0           | -7.6        | 1.00 V             | 102                  | 6.90             | 39.50                    |
| 5   | 11340.00    | 60.8 PK                 | 74.0           | -13.2       | 1.10 V             | 25                   | 9.10             | 51.70                    |
| 6   | 11340.00    | 47.3 AV                 | 54.0           | -6.7        | 1.10 V             | 25                   | -4.40            | 51.70                    |

**REMARKS:**

1. Emission level (dBuV/m) = Raw Value (dBuV) + Correction Factor (dB/m).
2. Correction Factor (dB/m) = Antenna Factor (dB/m) + Cable Factor (dB).
3. The other emission levels were very low against the limit.
4. Margin value = Emission level – Limit value.
5. " \* ": Fundamental frequency.
6. " # ": The radiated frequency is out of the restricted band.

2 TX

802.11n (20MHz)

| EUT TEST CONDITION       |                 | MEASUREMENT DETAIL |                           |
|--------------------------|-----------------|--------------------|---------------------------|
| CHANNEL                  | Channel 36      | FREQUENCY RANGE    | 1 ~ 40GHz                 |
| INPUT POWER (SYSTEM)     | 120Vac, 60Hz    | DETECTOR FUNCTION  | Peak (PK)<br>Average (AV) |
| ENVIRONMENTAL CONDITIONS | 25deg. C, 67%RH | TESTED BY          | Cedric Wu                 |
| TEST MODE                | B               |                    |                           |

| ANTENNA POLARITY & TEST DISTANCE: HORIZONTAL AT 3 M |             |                         |                |             |                    |                      |                  |                          |
|---|-------------|-------------------------|----------------|-------------|--------------------|----------------------|------------------|--------------------------|
| NO.   | FREQ. (MHz) | EMISSION LEVEL (dBuV/m) | LIMIT (dBuV/m) | MARGIN (dB) | ANTENNA HEIGHT (m) | TABLE ANGLE (Degree) | RAW VALUE (dBuV) | CORRECTION FACTOR (dB/m) |
| 1   | 5150.00     | 59.4 PK                 | 74.0           | -14.6       | 1.30 H             | 165                  | 20.80            | 38.60                    |
| 2   | 5150.00     | 45.5 AV                 | 54.0           | -8.5        | 1.30 H             | 165                  | 6.90             | 38.60                    |
| 3   | *5180.00    | 102.4 PK                |                |             | 1.35 H             | 166                  | 63.80            | 38.60                    |
| 4   | *5180.00    | 91.4 AV                 |                |             | 1.35 H             | 166                  | 52.80            | 38.60                    |
| 5   | #10360.00   | 57.5 PK                 | 74.0           | -16.5       | 1.00 H             | 150                  | 8.00             | 49.50                    |
| 6   | #10360.00   | 45.0 AV                 | 54.0           | -9.0        | 1.00 H             | 150                  | -4.50            | 49.50                    |

| ANTENNA POLARITY & TEST DISTANCE: VERTICAL AT 3 M |             |                         |                |             |                    |                      |                  |                          |
|---|-------------|-------------------------|----------------|-------------|--------------------|----------------------|------------------|--------------------------|
| NO.   | FREQ. (MHz) | EMISSION LEVEL (dBuV/m) | LIMIT (dBuV/m) | MARGIN (dB) | ANTENNA HEIGHT (m) | TABLE ANGLE (Degree) | RAW VALUE (dBuV) | CORRECTION FACTOR (dB/m) |
| 1   | 5150.00     | 63.0 PK                 | 74.0           | -11.0       | 1.00 V             | 309                  | 24.40            | 38.60                    |
| 2   | 5150.00     | 49.3 AV                 | 54.0           | -4.7        | 1.00 V             | 309                  | 10.70            | 38.60                    |
| 3   | *5180.00    | 108.5 PK                |                |             | 1.00 V             | 310                  | 69.90            | 38.60                    |
| 4   | *5180.00    | 97.3 AV                 |                |             | 1.00 V             | 310                  | 58.70            | 38.60                    |
| 5   | #10360.00   | 59.6 PK                 | 74.0           | -14.4       | 1.59 V             | 275                  | 10.10            | 49.50                    |
| 6   | #10360.00   | 47.1 AV                 | 54.0           | -6.9        | 1.59 V             | 275                  | -2.40            | 49.50                    |

REMARKS:

1. Emission level (dBuV/m) = Raw Value (dBuV) + Correction Factor (dB/m).
2. Correction Factor (dB/m) = Antenna Factor (dB/m) + Cable Factor (dB).
3. The other emission levels were very low against the limit.
4. Margin value = Emission level – Limit value.
5. " \* ": Fundamental frequency.
6. " # ": The radiated frequency is out of the restricted band.



A D T

| EUT TEST CONDITION       |                 | MEBSUREMENT DETBIL |                           |
|--------------------------|-----------------|--------------------|---------------------------|
| CHBNNEL                  | Channel 40      | FREQUENCY RBNGE    | 1 ~ 40GHz                 |
| INPUT POWER (SYSTEM)     | 120Vac, 60Hz    | DETECTOR FUNCTION  | Peak (PK)<br>Average (AV) |
| ENVIRONMENTBL CONDITIONS | 25deg. C, 67%RH | TESTED BY          | Cedric Wu                 |
| TEST MODE                | B               |                    |                           |

| ANTENNA POLARITY & TEST DISTANCE: HORIZONTAL AT 3 M |             |                         |                |             |                    |                      |                  |                          |
|---|-------------|-------------------------|----------------|-------------|--------------------|----------------------|------------------|--------------------------|
| NO.   | FREQ. (MHz) | EMISSION LEVEL (dBuV/m) | LIMIT (dBuV/m) | MARGIN (dB) | ANTENNA HEIGHT (m) | TABLE ANGLE (Degree) | RAW VALUE (dBuV) | CORRECTION FACTOR (dB/m) |
| 1   | *5200.00    | 103.8 PK                |                |             | 1.00 H             | 180                  | 65.20            | 38.60                    |
| 2   | *5200.00    | 92.1 AV                 |                |             | 1.00 H             | 180                  | 53.50            | 38.60                    |
| 3   | #10400.00   | 58.5 PK                 | 74.0           | -15.5       | 1.00 H             | 170                  | 9.00             | 49.50                    |
| 4   | #10400.00   | 45.9 AV                 | 54.0           | -8.1        | 1.00 H             | 170                  | -3.60            | 49.50                    |
| 5   | 15600.00    | 62.0 PK                 | 74.0           | -12.0       | 1.00 H             | 110                  | 11.30            | 50.70                    |
| 6   | 15600.00    | 49.2 AV                 | 54.0           | -4.8        | 1.00 H             | 110                  | -1.50            | 50.70                    |
| ANTENNA POLARITY & TEST DISTANCE: VERTICAL AT 3 M   |             |                         |                |             |                    |                      |                  |                          |
| NO.   | FREQ. (MHz) | EMISSION LEVEL (dBuV/m) | LIMIT (dBuV/m) | MARGIN (dB) | ANTENNA HEIGHT (m) | TABLE ANGLE (Degree) | RAW VALUE (dBuV) | CORRECTION FACTOR (dB/m) |
| 1   | *5200.00    | 109.7 PK                |                |             | 1.00 V             | 310                  | 71.10            | 38.60                    |
| 2   | *5200.00    | 98.1 AV                 |                |             | 1.00 V             | 310                  | 59.50            | 38.60                    |
| 3   | #10400.00   | 61.5 PK                 | 74.0           | -12.5       | 1.67 V             | 274                  | 12.00            | 49.50                    |
| 4   | #10400.00   | 48.2 AV                 | 54.0           | -5.8        | 1.67 V             | 274                  | -1.30            | 49.50                    |
| 5   | 15600.00    | 62.7 PK                 | 74.0           | -11.3       | 1.14 V             | 305                  | 12.00            | 50.70                    |
| 6   | 15600.00    | 49.7 AV                 | 54.0           | -4.3        | 1.14 V             | 305                  | -1.00            | 50.70                    |

**REMARKS:**

1. Emission level (dBuV/m) = Raw Value (dBuV) + Correction Factor (dB/m).
2. Correction Factor (dB/m) = Antenna Factor (dB/m) + Cable Factor (dB).
3. The other emission levels were very low against the limit.
4. Margin value = Emission level – Limit value.
5. " \* ": Fundamental frequency.
6. " # ": The radiated frequency is out of the restricted band.



A D T

| EUT TEST CONDITION       |                 | MEBSUREMENT DETBIL |                           |
|--------------------------|-----------------|--------------------|---------------------------|
| CHBNNEL                  | Channel 48      | FREQUENCY RBNGE    | 1 ~ 40GHz                 |
| INPUT POWER (SYSTEM)     | 120Vac, 60Hz    | DETECTOR FUNCTION  | Peak (PK)<br>Average (AV) |
| ENVIRONMENTBL CONDITIONS | 25deg. C, 67%RH | TESTED BY          | Cedric Wu                 |
| TEST MODE                | B               |                    |                           |

| ANTENNA POLARITY & TEST DISTANCE: HORIZONTAL AT 3 M |             |                         |                |             |                    |                      |                  |                          |
|---|-------------|-------------------------|----------------|-------------|--------------------|----------------------|------------------|--------------------------|
| NO.   | FREQ. (MHz) | EMISSION LEVEL (dBuV/m) | LIMIT (dBuV/m) | MARGIN (dB) | ANTENNA HEIGHT (m) | TABLE ANGLE (Degree) | RAW VALUE (dBuV) | CORRECTION FACTOR (dB/m) |
| 1   | *5240.00    | 104.8 PK                |                |             | 1.32 H             | 182                  | 66.10            | 38.70                    |
| 2   | *5240.00    | 93.1 AV                 |                |             | 1.32 H             | 182                  | 54.40            | 38.70                    |
| 3   | 5350.00     | 56.7 PK                 | 74.0           | -17.3       | 1.35 H             | 180                  | 17.90            | 38.80                    |
| 4   | 5350.00     | 34.3 AV                 | 54.0           | -19.7       | 1.35 H             | 180                  | -4.50            | 38.80                    |
| 5   | #10480.00   | 58.5 PK                 | 74.0           | -15.5       | 1.00 H             | 160                  | 8.80             | 49.70                    |
| 6   | #10480.00   | 45.7 AV                 | 54.0           | -8.3        | 1.00 H             | 160                  | -4.00            | 49.70                    |
| ANTENNA POLARITY & TEST DISTANCE: VERTICAL AT 3 M   |             |                         |                |             |                    |                      |                  |                          |
| NO.   | FREQ. (MHz) | EMISSION LEVEL (dBuV/m) | LIMIT (dBuV/m) | MARGIN (dB) | ANTENNA HEIGHT (m) | TABLE ANGLE (Degree) | RAW VALUE (dBuV) | CORRECTION FACTOR (dB/m) |
| 1   | *5240.00    | 110.6 PK                |                |             | 1.00 V             | 313                  | 71.90            | 38.70                    |
| 2   | *5240.00    | 98.6 AV                 |                |             | 1.00 V             | 313                  | 59.90            | 38.70                    |
| 3   | 5350.00     | 56.8 PK                 | 74.0           | -17.2       | 1.00 V             | 310                  | 18.00            | 38.80                    |
| 4   | 5350.00     | 45.3 AV                 | 54.0           | -8.7        | 1.00 V             | 310                  | 6.50             | 38.80                    |
| 5   | #10480.00   | 61.9 PK                 | 74.0           | -12.1       | 1.64 V             | 251                  | 12.20            | 49.70                    |
| 6   | #10480.00   | 48.2 AV                 | 54.0           | -5.8        | 1.64 V             | 251                  | -1.50            | 49.70                    |

**REMARKS:**

1. Emission level (dBuV/m) = Raw Value (dBuV) + Correction Factor (dB/m).
2. Correction Factor (dB/m) = Antenna Factor (dB/m) + Cable Factor (dB).
3. The other emission levels were very low against the limit.
4. Margin value = Emission level – Limit value.
5. " \* ": Fundamental frequency.
6. " # ": The radiated frequency is out of the restricted band.



A D T

| EUT TEST CONDITION       |                 | MEBSUREMENT DETBIL |                           |
|--------------------------|-----------------|--------------------|---------------------------|
| CHBNNEL                  | Channel 52      | FREQUENCY RBNGE    | 1 ~ 40GHz                 |
| INPUT POWER (SYSTEM)     | 120Vac, 60Hz    | DETECTOR FUNCTION  | Peak (PK)<br>Average (AV) |
| ENVIRONMENTBL CONDITIONS | 25deg. C, 67%RH | TESTED BY          | Cedric Wu                 |
| TEST MODE                | B               |                    |                           |

| ANTENNA POLARITY & TEST DISTANCE: HORIZONTAL AT 3 M |             |                         |                |             |                    |                      |                  |                          |
|---|-------------|-------------------------|----------------|-------------|--------------------|----------------------|------------------|--------------------------|
| NO.   | FREQ. (MHz) | EMISSION LEVEL (dBuV/m) | LIMIT (dBuV/m) | MARGIN (dB) | ANTENNA HEIGHT (m) | TABLE ANGLE (Degree) | RAW VALUE (dBuV) | CORRECTION FACTOR (dB/m) |
| 1   | 5150.00     | 56.8 PK                 | 74.0           | -17.2       | 1.00 H             | 181                  | 18.20            | 38.60                    |
| 2   | 5150.00     | 44.9 AV                 | 54.0           | -9.1        | 1.00 H             | 181                  | 6.30             | 38.60                    |
| 3   | *5260.00    | 104.0 PK                |                |             | 1.00 H             | 185                  | 65.30            | 38.70                    |
| 4   | *5260.00    | 92.4 AV                 |                |             | 1.00 H             | 185                  | 53.70            | 38.70                    |
| 5   | #10520.00   | 57.6 PK                 | 74.0           | -16.4       | 1.00 H             | 154                  | 7.80             | 49.80                    |
| 6   | #10520.00   | 44.8 AV                 | 54.0           | -9.2        | 1.00 H             | 154                  | -5.00            | 49.80                    |
| ANTENNA POLARITY & TEST DISTANCE: VERTICAL AT 3 M   |             |                         |                |             |                    |                      |                  |                          |
| NO.   | FREQ. (MHz) | EMISSION LEVEL (dBuV/m) | LIMIT (dBuV/m) | MARGIN (dB) | ANTENNA HEIGHT (m) | TABLE ANGLE (Degree) | RAW VALUE (dBuV) | CORRECTION FACTOR (dB/m) |
| 1   | 5150.00     | 56.3 PK                 | 74.0           | -17.7       | 1.34 V             | 310                  | 17.70            | 38.60                    |
| 2   | 5150.00     | 45.0 AV                 | 54.0           | -9.0        | 1.34 V             | 310                  | 6.40             | 38.60                    |
| 3   | *5260.00    | 109.4 PK                |                |             | 1.34 V             | 307                  | 70.70            | 38.70                    |
| 4   | *5260.00    | 98.5 AV                 |                |             | 1.34 V             | 307                  | 59.80            | 38.70                    |
| 5   | #10520.00   | 60.2 PK                 | 74.0           | -13.8       | 1.64 V             | 255                  | 10.40            | 49.80                    |
| 6   | #10520.00   | 47.1 AV                 | 54.0           | -6.9        | 1.64 V             | 255                  | -2.70            | 49.80                    |

**REMARKS:**

1. Emission level (dBuV/m) = Raw Value (dBuV) + Correction Factor (dB/m).
2. Correction Factor (dB/m) = Antenna Factor (dB/m) + Cable Factor (dB).
3. The other emission levels were very low against the limit.
4. Margin value = Emission level – Limit value.
5. " \* ": Fundamental frequency.
6. " # ": The radiated frequency is out of the restricted band.



A D T

| EUT TEST CONDITION       |                 | MEBSUREMENT DETBIL |                           |
|--------------------------|-----------------|--------------------|---------------------------|
| CHBNNEL                  | Channel 60      | FREQUENCY RBNGE    | 1 ~ 40GHz                 |
| INPUT POWER (SYSTEM)     | 120Vac, 60Hz    | DETECTOR FUNCTION  | Peak (PK)<br>Average (AV) |
| ENVIRONMENTBL CONDITIONS | 25deg. C, 67%RH | TESTED BY          | Cedric Wu                 |
| TEST MODE                | B               |                    |                           |

| ANTENNA POLARITY & TEST DISTANCE: HORIZONTAL AT 3 M |             |                         |                |             |                    |                      |                  |                          |
|---|-------------|-------------------------|----------------|-------------|--------------------|----------------------|------------------|--------------------------|
| NO.   | FREQ. (MHz) | EMISSION LEVEL (dBuV/m) | LIMIT (dBuV/m) | MARGIN (dB) | ANTENNA HEIGHT (m) | TABLE ANGLE (Degree) | RAW VALUE (dBuV) | CORRECTION FACTOR (dB/m) |
| 1   | *5300.00    | 105.8 PK                |                |             | 1.09 H             | 185                  | 67.00            | 38.80                    |
| 2   | *5300.00    | 94.4 AV                 |                |             | 1.09 H             | 185                  | 55.60            | 38.80                    |
| 3   | 10600.00    | 57.5 PK                 | 74.0           | -16.5       | 1.00 H             | 169                  | 7.50             | 50.00                    |
| 4   | 10600.00    | 45.1 AV                 | 54.0           | -8.9        | 1.00 H             | 169                  | -4.90            | 50.00                    |
| 5   | 15900.00    | 60.9 PK                 | 74.0           | -13.1       | 1.00 H             | 105                  | 10.80            | 50.10                    |
| 6   | 15900.00    | 48.1 AV                 | 54.0           | -5.9        | 1.00 H             | 105                  | -2.00            | 50.10                    |
| ANTENNA POLARITY & TEST DISTANCE: VERTICAL AT 3 M   |             |                         |                |             |                    |                      |                  |                          |
| NO.   | FREQ. (MHz) | EMISSION LEVEL (dBuV/m) | LIMIT (dBuV/m) | MARGIN (dB) | ANTENNA HEIGHT (m) | TABLE ANGLE (Degree) | RAW VALUE (dBuV) | CORRECTION FACTOR (dB/m) |
| 1   | *5300.00    | 114.3 PK                |                |             | 1.52 V             | 324                  | 75.50            | 38.80                    |
| 2   | *5300.00    | 99.5 AV                 |                |             | 1.52 V             | 324                  | 60.70            | 38.80                    |
| 3   | 10600.00    | 58.6 PK                 | 74.0           | -15.4       | 1.52 V             | 258                  | 8.60             | 50.00                    |
| 4   | 10600.00    | 46.0 AV                 | 54.0           | -8.0        | 1.52 V             | 258                  | -4.00            | 50.00                    |
| 5   | 15900.00    | 60.8 PK                 | 74.0           | -13.2       | 1.13 V             | 315                  | 10.70            | 50.10                    |
| 6   | 15900.00    | 48.3 AV                 | 54.0           | -5.7        | 1.13 V             | 315                  | -1.80            | 50.10                    |

**REMARKS:**

1. Emission level (dBuV/m) = Raw Value (dBuV) + Correction Factor (dB/m).
2. Correction Factor (dB/m) = Antenna Factor (dB/m) + Cable Factor (dB).
3. The other emission levels were very low against the limit.
4. Margin value = Emission level – Limit value.
5. " \* " : Fundamental frequency.



A D T

| EUT TEST CONDITION       |                 | MEBSUREMENT DETBIL |                           |
|--------------------------|-----------------|--------------------|---------------------------|
| CHBNNEL                  | Channel 64      | FREQUENCY RBNGE    | 1 ~ 40GHz                 |
| INPUT POWER (SYSTEM)     | 120Vac, 60Hz    | DETECTOR FUNCTION  | Peak (PK)<br>Average (AV) |
| ENVIRONMENTBL CONDITIONS | 25deg. C, 67%RH | TESTED BY          | Cedric Wu                 |
| TEST MODE                | B               |                    |                           |

| ANTENNA POLARITY & TEST DISTANCE: HORIZONTAL AT 3 M |             |                         |                |             |                    |                      |                  |                          |
|---|-------------|-------------------------|----------------|-------------|--------------------|----------------------|------------------|--------------------------|
| NO.   | FREQ. (MHz) | EMISSION LEVEL (dBuV/m) | LIMIT (dBuV/m) | MARGIN (dB) | ANTENNA HEIGHT (m) | TABLE ANGLE (Degree) | RAW VALUE (dBuV) | CORRECTION FACTOR (dB/m) |
| 1   | *5320.00    | 103.7 PK                |                |             | 1.06 H             | 168                  | 64.90            | 38.80                    |
| 2   | *5320.00    | 92.3 AV                 |                |             | 1.06 H             | 168                  | 53.50            | 38.80                    |
| 3   | 5350.00     | 58.8 PK                 | 74.0           | -15.2       | 1.05 H             | 165                  | 20.00            | 38.80                    |
| 4   | 5350.00     | 45.9 AV                 | 54.0           | -8.1        | 1.05 H             | 165                  | 7.10             | 38.80                    |
| 5   | 10640.00    | 57.8 PK                 | 74.0           | -16.2       | 1.00 H             | 145                  | 7.60             | 50.20                    |
| 6   | 10640.00    | 45.0 AV                 | 54.0           | -9.0        | 1.00 H             | 145                  | -5.20            | 50.20                    |
| ANTENNA POLARITY & TEST DISTANCE: VERTICAL AT 3 M   |             |                         |                |             |                    |                      |                  |                          |
| NO.   | FREQ. (MHz) | EMISSION LEVEL (dBuV/m) | LIMIT (dBuV/m) | MARGIN (dB) | ANTENNA HEIGHT (m) | TABLE ANGLE (Degree) | RAW VALUE (dBuV) | CORRECTION FACTOR (dB/m) |
| 1   | *5320.00    | 111.9 PK                |                |             | 1.37 V             | 320                  | 73.10            | 38.80                    |
| 2   | *5320.00    | 100.1 AV                |                |             | 1.37 V             | 320                  | 61.30            | 38.80                    |
| 3   | 5350.00     | 61.5 PK                 | 74.0           | -12.5       | 1.35 V             | 234                  | 22.70            | 38.80                    |
| 4   | 5350.00     | 48.6 AV                 | 54.0           | -5.4        | 1.35 V             | 234                  | 9.80             | 38.80                    |
| 5   | 10640.00    | 58.4 PK                 | 74.0           | -15.6       | 1.60 V             | 251                  | 8.20             | 50.20                    |
| 6   | 10640.00    | 46.0 AV                 | 54.0           | -8.0        | 1.60 V             | 251                  | -4.20            | 50.20                    |

**REMARKS:**

1. Emission level (dBuV/m) = Raw Value (dBuV) + Correction Factor (dB/m).
2. Correction Factor (dB/m) = Antenna Factor (dB/m) + Cable Factor (dB).
3. The other emission levels were very low against the limit.
4. Margin value = Emission level – Limit value.
5. " \* " : Fundamental frequency.





A D T

| EUT TEST CONDITION       |                 | MEBSUREMENT DETBIL |                           |
|--------------------------|-----------------|--------------------|---------------------------|
| CHBNNEL                  | Channel 100     | FREQUENCY RBNGE    | 1 ~ 40GHz                 |
| INPUT POWER (SYSTEM)     | 120Vac, 60Hz    | DETECTOR FUNCTION  | Peak (PK)<br>Average (AV) |
| ENVIRONMENTBL CONDITIONS | 25deg. C, 67%RH | TESTED BY          | Cedric Wu                 |
| TEST MODE                | B               |                    |                           |

| ANTENNA POLARITY & TEST DISTANCE: HORIZONTAL AT 3 M |             |                         |                |             |                    |                      |                  |                          |
|---|-------------|-------------------------|----------------|-------------|--------------------|----------------------|------------------|--------------------------|
| NO.   | FREQ. (MHz) | EMISSION LEVEL (dBuV/m) | LIMIT (dBuV/m) | MARGIN (dB) | ANTENNA HEIGHT (m) | TABLE ANGLE (Degree) | RAW VALUE (dBuV) | CORRECTION FACTOR (dB/m) |
| 1   | 5460.00     | 57.2 PK                 | 74.0           | -16.8       | 1.10 H             | 162                  | 18.20            | 39.00                    |
| 2   | 5460.00     | 45.0 AV                 | 54.0           | -9.0        | 1.10 H             | 162                  | 6.00             | 39.00                    |
| 3   | #5470.00    | 61.5 PK                 | 74.0           | -12.5       | 1.14 H             | 161                  | 22.50            | 39.00                    |
| 4   | #5470.00    | 46.2 AV                 | 54.0           | -7.8        | 1.14 H             | 161                  | 7.20             | 39.00                    |
| 5   | *5500.00    | 103.4 PK                |                |             | 1.15 H             | 168                  | 64.30            | 39.10                    |
| 6   | *5500.00    | 90.8 AV                 |                |             | 1.15 H             | 168                  | 51.70            | 39.10                    |
| 7   | 11000.00    | 59.4 PK                 | 74.0           | -14.6       | 1.00 H             | 171                  | 7.80             | 51.60                    |
| 8   | 11000.00    | 46.9 AV                 | 54.0           | -7.1        | 1.00 H             | 171                  | -4.70            | 51.60                    |
| ANTENNA POLARITY & TEST DISTANCE: VERTICAL AT 3 M   |             |                         |                |             |                    |                      |                  |                          |
| NO.   | FREQ. (MHz) | EMISSION LEVEL (dBuV/m) | LIMIT (dBuV/m) | MARGIN (dB) | ANTENNA HEIGHT (m) | TABLE ANGLE (Degree) | RAW VALUE (dBuV) | CORRECTION FACTOR (dB/m) |
| 1   | 5460.00     | 61.1 PK                 | 74.0           | -12.9       | 1.32 V             | 289                  | 22.10            | 39.00                    |
| 2   | 5460.00     | 49.1 AV                 | 54.0           | -4.9        | 1.32 V             | 289                  | 10.10            | 39.00                    |
| 3   | #5470.00    | 67.8 PK                 | 74.0           | -6.2        | 1.32 V             | 287                  | 28.80            | 39.00                    |
| 4   | #5470.00    | 51.1 AV                 | 54.0           | -2.9        | 1.32 V             | 287                  | 12.10            | 39.00                    |
| 5   | *5500.00    | 111.9 PK                |                |             | 1.31 V             | 289                  | 72.80            | 39.10                    |
| 6   | *5500.00    | 99.8 AV                 |                |             | 1.31 V             | 289                  | 60.70            | 39.10                    |
| 7   | 11000.00    | 59.1 PK                 | 74.0           | -14.9       | 1.00 V             | 252                  | 7.50             | 51.60                    |
| 8   | 11000.00    | 46.4 AV                 | 54.0           | -7.6        | 1.00 V             | 252                  | -5.20            | 51.60                    |

**REMARKS:**

1. Emission level (dBuV/m) = Raw Value (dBuV) + Correction Factor (dB/m).
2. Correction Factor (dB/m) = Antenna Factor (dB/m) + Cable Factor (dB).
3. The other emission levels were very low against the limit.
4. Margin value = Emission level – Limit value.
5. " \* ": Fundamental frequency.
6. " # ": The radiated frequency is out of the restricted band.



A D T

| EUT TEST CONDITION       |                 | MEBSUREMENT DETBIL |                           |
|--------------------------|-----------------|--------------------|---------------------------|
| CHBNNEL                  | Channel 116     | FREQUENCY RBNGE    | 1 ~ 40GHz                 |
| INPUT POWER (SYSTEM)     | 120Vac, 60Hz    | DETECTOR FUNCTION  | Peak (PK)<br>Average (AV) |
| ENVIRONMENTBL CONDITIONS | 25deg. C, 67%RH | TESTED BY          | Cedric Wu                 |
| TEST MODE                | B               |                    |                           |

| ANTENNA POLARITY & TEST DISTANCE: HORIZONTAL AT 3 M |             |                         |                |             |                    |                      |                  |                          |
|---|-------------|-------------------------|----------------|-------------|--------------------|----------------------|------------------|--------------------------|
| NO.   | FREQ. (MHz) | EMISSION LEVEL (dBuV/m) | LIMIT (dBuV/m) | MARGIN (dB) | ANTENNA HEIGHT (m) | TABLE ANGLE (Degree) | RAW VALUE (dBuV) | CORRECTION FACTOR (dB/m) |
| 1   | *5580.00    | 102.5 PK                |                |             | 1.00 H             | 166                  | 63.30            | 39.20                    |
| 2   | *5580.00    | 92.4 AV                 |                |             | 1.00 H             | 166                  | 53.20            | 39.20                    |
| 3   | 11160.00    | 59.5 PK                 | 74.0           | -14.5       | 1.00 H             | 147                  | 8.20             | 51.30                    |
| 4   | 11160.00    | 46.6 AV                 | 54.0           | -7.4        | 1.00 H             | 147                  | -4.70            | 51.30                    |
| 5   | #16740.00   | 64.0 PK                 | 74.0           | -10.0       | 1.00 H             | 90                   | 11.00            | 53.00                    |
| 6   | #16740.00   | 51.4 AV                 | 54.0           | -2.6        | 1.00 H             | 90                   | -1.60            | 53.00                    |
| ANTENNA POLARITY & TEST DISTANCE: VERTICAL AT 3 M   |             |                         |                |             |                    |                      |                  |                          |
| NO.   | FREQ. (MHz) | EMISSION LEVEL (dBuV/m) | LIMIT (dBuV/m) | MARGIN (dB) | ANTENNA HEIGHT (m) | TABLE ANGLE (Degree) | RAW VALUE (dBuV) | CORRECTION FACTOR (dB/m) |
| 1   | *5580.00    | 111.1 PK                |                |             | 1.27 V             | 287                  | 71.90            | 39.20                    |
| 2   | *5580.00    | 100.2 AV                |                |             | 1.27 V             | 287                  | 61.00            | 39.20                    |
| 3   | 11160.00    | 58.9 PK                 | 74.0           | -15.1       | 1.57 V             | 257                  | 7.60             | 51.30                    |
| 4   | 11160.00    | 47.1 AV                 | 54.0           | -6.9        | 1.57 V             | 257                  | -4.20            | 51.30                    |
| 5   | #16740.00   | 64.4 PK                 | 74.0           | -9.6        | 1.00 V             | 310                  | 11.40            | 53.00                    |
| 6   | #16740.00   | 51.6 AV                 | 54.0           | -2.4        | 1.00 V             | 310                  | -1.40            | 53.00                    |

**REMARKS:**

1. Emission level (dBuV/m) = Raw Value (dBuV) + Correction Factor (dB/m).
2. Correction Factor (dB/m) = Antenna Factor (dB/m) + Cable Factor (dB).
3. The other emission levels were very low against the limit.
4. Margin value = Emission level – Limit value.
5. " \* ": Fundamental frequency.
6. " # ": The radiated frequency is out of the restricted band.



A D T

| EUT TEST CONDITION       |                 | MEBSUREMENT DETBIL |                           |
|--------------------------|-----------------|--------------------|---------------------------|
| CHBNNEL                  | Channel 140     | FREQUENCY RBNGE    | 1 ~ 40GHz                 |
| INPUT POWER (SYSTEM)     | 120Vac, 60Hz    | DETECTOR FUNCTION  | Peak (PK)<br>Average (AV) |
| ENVIRONMENTBL CONDITIONS | 25deg. C, 67%RH | TESTED BY          | Cedric Wu                 |
| TEST MODE                | B               |                    |                           |

| ANTENNA POLARITY & TEST DISTANCE: HORIZONTAL AT 3 M |             |                         |                |             |                    |                      |                  |                          |
|---|-------------|-------------------------|----------------|-------------|--------------------|----------------------|------------------|--------------------------|
| NO.   | FREQ. (MHz) | EMISSION LEVEL (dBuV/m) | LIMIT (dBuV/m) | MARGIN (dB) | ANTENNA HEIGHT (m) | TABLE ANGLE (Degree) | RAW VALUE (dBuV) | CORRECTION FACTOR (dB/m) |
| 1   | *5700.00    | 104.3 PK                |                |             | 1.00 H             | 173                  | 64.80            | 39.50                    |
| 2   | *5700.00    | 92.2 AV                 |                |             | 1.00 H             | 173                  | 52.70            | 39.50                    |
| 3   | #5725.00    | 60.4 PK                 | 74.0           | -13.6       | 1.00 H             | 174                  | 20.90            | 39.50                    |
| 4   | #5725.00    | 46.4 AV                 | 54.0           | -7.6        | 1.00 H             | 174                  | 6.90             | 39.50                    |
| 5   | 11400.00    | 59.1 PK                 | 74.0           | -14.9       | 1.00 H             | 133                  | 7.50             | 51.60                    |
| 6   | 11400.00    | 46.5 AV                 | 54.0           | -7.5        | 1.00 H             | 133                  | -5.10            | 51.60                    |
| ANTENNA POLARITY & TEST DISTANCE: VERTICAL AT 3 M   |             |                         |                |             |                    |                      |                  |                          |
| NO.   | FREQ. (MHz) | EMISSION LEVEL (dBuV/m) | LIMIT (dBuV/m) | MARGIN (dB) | ANTENNA HEIGHT (m) | TABLE ANGLE (Degree) | RAW VALUE (dBuV) | CORRECTION FACTOR (dB/m) |
| 1   | *5700.00    | 111.4 PK                |                |             | 1.25 V             | 292                  | 71.90            | 39.50                    |
| 2   | *5700.00    | 100.0 AV                |                |             | 1.25 V             | 292                  | 60.50            | 39.50                    |
| 3   | #5725.00    | 65.4 PK                 | 74.0           | -8.6        | 1.25 V             | 290                  | 25.90            | 39.50                    |
| 4   | #5725.00    | 51.9 AV                 | 54.0           | -2.1        | 1.25 V             | 290                  | 12.40            | 39.50                    |
| 5   | 11400.00    | 59.4 PK                 | 74.0           | -14.6       | 1.60 V             | 267                  | 7.80             | 51.60                    |
| 6   | 11400.00    | 46.9 AV                 | 54.0           | -7.1        | 1.60 V             | 267                  | -4.70            | 51.60                    |

**REMARKS:**

1. Emission level (dBuV/m) = Raw Value (dBuV) + Correction Factor (dB/m).
2. Correction Factor (dB/m) = Antenna Factor (dB/m) + Cable Factor (dB).
3. The other emission levels were very low against the limit.
4. Margin value = Emission level – Limit value.
5. " \* ": Fundamental frequency.
6. " # ": The radiated frequency is out of the restricted band.

802.11n (40MHz)

| EUT TEST CONDITION       |                 | MEBSUREMENT DETBIL |                           |
|--------------------------|-----------------|--------------------|---------------------------|
| CHBNNEL                  | Channel 38      | FREQUENCY RBNGE    | 1 ~ 40GHz                 |
| INPUT POWER (SYSTEM)     | 120Vac, 60Hz    | DETECTOR FUNCTION  | Peak (PK)<br>Average (AV) |
| ENVIRONMENTBL CONDITIONS | 25deg. C, 67%RH | TESTED BY          | Cedric Wu                 |
| TEST MODE                | B               |                    |                           |

| ANTENNA POLARITY & TEST DISTANCE: HORIZONTAL AT 3 M |             |                         |                |             |                    |                      |                  |                          |
|---|-------------|-------------------------|----------------|-------------|--------------------|----------------------|------------------|--------------------------|
| NO.   | FREQ. (MHz) | EMISSION LEVEL (dBuV/m) | LIMIT (dBuV/m) | MARGIN (dB) | ANTENNA HEIGHT (m) | TABLE ANGLE (Degree) | RAW VALUE (dBuV) | CORRECTION FACTOR (dB/m) |
| 1   | 5150.00     | 58.6 PK                 | 74.0           | -15.4       | 1.00 H             | 185                  | 20.00            | 38.60                    |
| 2   | 5150.00     | 46.6 AV                 | 54.0           | -7.4        | 1.00 H             | 185                  | 8.00             | 38.60                    |
| 3   | *5190.00    | 94.0 PK                 |                |             | 1.00 H             | 186                  | 55.40            | 38.60                    |
| 4   | *5190.00    | 82.8 AV                 |                |             | 1.00 H             | 186                  | 44.20            | 38.60                    |
| 5   | #10380.00   | 57.8 PK                 | 74.0           | -16.2       | 1.00 H             | 135                  | 8.30             | 49.50                    |
| 6   | #10380.00   | 44.8 AV                 | 54.0           | -9.2        | 1.00 H             | 135                  | -4.70            | 49.50                    |
| ANTENNA POLARITY & TEST DISTANCE: VERTICAL AT 3 M   |             |                         |                |             |                    |                      |                  |                          |
| NO.   | FREQ. (MHz) | EMISSION LEVEL (dBuV/m) | LIMIT (dBuV/m) | MARGIN (dB) | ANTENNA HEIGHT (m) | TABLE ANGLE (Degree) | RAW VALUE (dBuV) | CORRECTION FACTOR (dB/m) |
| 1   | 5150.00     | 63.2 PK                 | 74.0           | -10.8       | 1.00 V             | 309                  | 24.60            | 38.60                    |
| 2   | 5150.00     | 51.7 AV                 | 54.0           | -2.3        | 1.00 V             | 309                  | 13.10            | 38.60                    |
| 3   | *5190.00    | 100.3 PK                |                |             | 1.00 V             | 309                  | 61.70            | 38.60                    |
| 4   | *5190.00    | 89.2 AV                 |                |             | 1.00 V             | 309                  | 50.60            | 38.60                    |
| 5   | #10380.00   | 58.2 PK                 | 74.0           | -15.8       | 1.00 V             | 265                  | 8.70             | 49.50                    |
| 6   | #10380.00   | 44.7 AV                 | 54.0           | -9.3        | 1.00 V             | 265                  | -4.80            | 49.50                    |

REMARKS:

1. Emission level (dBuV/m) = Raw Value (dBuV) + Correction Factor (dB/m).
2. Correction Factor (dB/m) = Antenna Factor (dB/m) + Cable Factor (dB).
3. The other emission levels were very low against the limit.
4. Margin value = Emission level – Limit value.
5. " \* ": Fundamental frequency.
6. " # ": The radiated frequency is out of the restricted band.



A D T

| EUT TEST CONDITION       |                 | MEBSUREMENT DETBIL |                           |
|--------------------------|-----------------|--------------------|---------------------------|
| CHBNNEL                  | Channel 46      | FREQUENCY RBNGE    | 1 ~ 40GHz                 |
| INPUT POWER (SYSTEM)     | 120Vac, 60Hz    | DETECTOR FUNCTION  | Peak (PK)<br>Average (AV) |
| ENVIRONMENTBL CONDITIONS | 25deg. C, 67%RH | TESTED BY          | Cedric Wu                 |
| TEST MODE                | B               |                    |                           |

| ANTENNA POLARITY & TEST DISTANCE: HORIZONTAL AT 3 M |             |                         |                |             |                    |                      |                  |                          |
|---|-------------|-------------------------|----------------|-------------|--------------------|----------------------|------------------|--------------------------|
| NO.   | FREQ. (MHz) | EMISSION LEVEL (dBuV/m) | LIMIT (dBuV/m) | MARGIN (dB) | ANTENNA HEIGHT (m) | TABLE ANGLE (Degree) | RAW VALUE (dBuV) | CORRECTION FACTOR (dB/m) |
| 1   | *5230.00    | 99.9 PK                 |                |             | 1.05 H             | 185                  | 61.30            | 38.60                    |
| 2   | *5230.00    | 88.5 AV                 |                |             | 1.05 H             | 185                  | 49.90            | 38.60                    |
| 3   | 5350.00     | 56.9 PK                 | 74.0           | -17.1       | 1.02 H             | 183                  | 18.10            | 38.80                    |
| 4   | 5350.00     | 44.6 AV                 | 54.0           | -9.4        | 1.02 H             | 183                  | 5.80             | 38.80                    |
| 5   | #10460.00   | 57.3 PK                 | 74.0           | -16.7       | 1.00 H             | 138                  | 7.70             | 49.60                    |
| 6   | #10460.00   | 45.2 AV                 | 54.0           | -8.8        | 1.00 H             | 138                  | -4.40            | 49.60                    |
| ANTENNA POLARITY & TEST DISTANCE: VERTICAL AT 3 M   |             |                         |                |             |                    |                      |                  |                          |
| NO.   | FREQ. (MHz) | EMISSION LEVEL (dBuV/m) | LIMIT (dBuV/m) | MARGIN (dB) | ANTENNA HEIGHT (m) | TABLE ANGLE (Degree) | RAW VALUE (dBuV) | CORRECTION FACTOR (dB/m) |
| 1   | *5230.00    | 105.5 PK                |                |             | 1.00 V             | 314                  | 66.90            | 38.60                    |
| 2   | *5230.00    | 93.9 AV                 |                |             | 1.00 V             | 314                  | 55.30            | 38.60                    |
| 3   | 5350.00     | 56.8 PK                 | 74.0           | -17.2       | 1.00 V             | 317                  | 18.00            | 38.80                    |
| 4   | 5350.00     | 44.4 AV                 | 54.0           | -9.6        | 1.00 V             | 317                  | 5.60             | 38.80                    |
| 5   | #10460.00   | 58.1 PK                 | 74.0           | -15.9       | 1.00 V             | 272                  | 8.50             | 49.60                    |
| 6   | #10460.00   | 45.1 AV                 | 54.0           | -8.9        | 1.00 V             | 272                  | -4.50            | 49.60                    |

**REMARKS:**

1. Emission level (dBuV/m) = Raw Value (dBuV) + Correction Factor (dB/m).
2. Correction Factor (dB/m) = Antenna Factor (dB/m) + Cable Factor (dB).
3. The other emission levels were very low against the limit.
4. Margin value = Emission level – Limit value.
5. " \* ": Fundamental frequency.
6. " # ": The radiated frequency is out of the restricted band.



A D T

| EUT TEST CONDITION       |                 | MEBSUREMENT DETBIL |                           |
|--------------------------|-----------------|--------------------|---------------------------|
| CHBNNEL                  | Channel 54      | FREQUENCY RBNGE    | 1 ~ 40GHz                 |
| INPUT POWER (SYSTEM)     | 120Vac, 60Hz    | DETECTOR FUNCTION  | Peak (PK)<br>Average (AV) |
| ENVIRONMENTBL CONDITIONS | 25deg. C, 67%RH | TESTED BY          | Cedric Wu                 |
| TEST MODE                | B               |                    |                           |

| ANTENNA POLARITY & TEST DISTANCE: HORIZONTAL AT 3 M |             |                         |                |             |                    |                      |                  |                          |
|---|-------------|-------------------------|----------------|-------------|--------------------|----------------------|------------------|--------------------------|
| NO.   | FREQ. (MHz) | EMISSION LEVEL (dBuV/m) | LIMIT (dBuV/m) | MARGIN (dB) | ANTENNA HEIGHT (m) | TABLE ANGLE (Degree) | RAW VALUE (dBuV) | CORRECTION FACTOR (dB/m) |
| 1   | 5150.00     | 47.0 PK                 | 74.0           | -27.0       | 1.20 H             | 180                  | 8.40             | 38.60                    |
| 2   | 5150.00     | 44.9 AV                 | 54.0           | -9.1        | 1.20 H             | 180                  | 6.30             | 38.60                    |
| 3   | *5270.00    | 101.0 PK                |                |             | 1.20 H             | 185                  | 62.30            | 38.70                    |
| 4   | *5270.00    | 90.3 AV                 |                |             | 1.20 H             | 185                  | 51.60            | 38.70                    |
| 5   | #10540.00   | 57.2 PK                 | 74.0           | -16.8       | 1.00 H             | 130                  | 7.40             | 49.80                    |
| 6   | #10540.00   | 45.9 AV                 | 54.0           | -8.1        | 1.00 H             | 130                  | -3.90            | 49.80                    |
| ANTENNA POLARITY & TEST DISTANCE: VERTICAL AT 3 M   |             |                         |                |             |                    |                      |                  |                          |
| NO.   | FREQ. (MHz) | EMISSION LEVEL (dBuV/m) | LIMIT (dBuV/m) | MARGIN (dB) | ANTENNA HEIGHT (m) | TABLE ANGLE (Degree) | RAW VALUE (dBuV) | CORRECTION FACTOR (dB/m) |
| 1   | 5150.00     | 56.1 PK                 | 74.0           | -17.9       | 1.35 V             | 325                  | 17.50            | 38.60                    |
| 2   | 5150.00     | 44.7 AV                 | 54.0           | -9.3        | 1.35 V             | 325                  | 6.10             | 38.60                    |
| 3   | *5270.00    | 107.0 PK                |                |             | 1.37 V             | 327                  | 68.30            | 38.70                    |
| 4   | *5270.00    | 95.9 AV                 |                |             | 1.37 V             | 327                  | 57.20            | 38.70                    |
| 5   | #10540.00   | 57.6 PK                 | 74.0           | -16.4       | 1.00 V             | 260                  | 7.80             | 49.80                    |
| 6   | #10540.00   | 45.8 AV                 | 54.0           | -8.2        | 1.00 V             | 260                  | -4.00            | 49.80                    |

**REMARKS:**

1. Emission level (dBuV/m) = Raw Value (dBuV) + Correction Factor (dB/m).
2. Correction Factor (dB/m) = Antenna Factor (dB/m) + Cable Factor (dB).
3. The other emission levels were very low against the limit.
4. Margin value = Emission level – Limit value.
5. " \* ": Fundamental frequency.
6. " # ": The radiated frequency is out of the restricted band.



A D T

| EUT TEST CONDITION       |                 | MEBSUREMENT DETBIL |                           |
|--------------------------|-----------------|--------------------|---------------------------|
| CHBNNEL                  | Channel 62      | FREQUENCY RBNGE    | 1 ~ 40GHz                 |
| INPUT POWER (SYSTEM)     | 120Vac, 60Hz    | DETECTOR FUNCTION  | Peak (PK)<br>Average (AV) |
| ENVIRONMENTBL CONDITIONS | 25deg. C, 67%RH | TESTED BY          | Cedric Wu                 |
| TEST MODE                | B               |                    |                           |

| ANTENNA POLARITY & TEST DISTANCE: HORIZONTAL AT 3 M |                |                         |                |             |                    |                      |                  |                          |
|---|----------------|-------------------------|----------------|-------------|--------------------|----------------------|------------------|--------------------------|
| NO.   | FREQ. (MHz)    | EMISSION LEVEL (dBuV/m) | LIMIT (dBuV/m) | MARGIN (dB) | ANTENNA HEIGHT (m) | TABLE ANGLE (Degree) | RAW VALUE (dBuV) | CORRECTION FACTOR (dB/m) |
| 1   | *5310.00       | 96.0 PK                 |                |             | 1.00 H             | 190                  | 57.20            | 38.80                    |
| 2   | *5310.00       | 84.7 AV                 |                |             | 1.00 H             | 190                  | 45.90            | 38.80                    |
| 3   | 5350.00        | 58.2 PK                 | 74.0           | -15.8       | 1.00 H             | 185                  | 19.40            | 38.80                    |
| 4   | 5350.00        | 46.4 AV                 | 54.0           | -7.6        | 1.00 H             | 185                  | 7.60             | 38.80                    |
| 5   | 10620.00       | 57.4 PK                 | 74.0           | -16.6       | 1.00 H             | 155                  | 7.30             | 50.10                    |
| 6   | 10620.00       | 45.0 AV                 | 54.0           | -9.0        | 1.00 H             | 155                  | -5.10            | 50.10                    |
| ANTENNA POLARITY & TEST DISTANCE: VERTICAL AT 3 M   |                |                         |                |             |                    |                      |                  |                          |
| NO.   | FREQ. (MHz)    | EMISSION LEVEL (dBuV/m) | LIMIT (dBuV/m) | MARGIN (dB) | ANTENNA HEIGHT (m) | TABLE ANGLE (Degree) | RAW VALUE (dBuV) | CORRECTION FACTOR (dB/m) |
| 1   | *5310.00       | 101.9 PK                |                |             | 1.36 V             | 326                  | 63.10            | 38.80                    |
| 2   | *5310.00       | 90.9 AV                 |                |             | 1.36 V             | 326                  | 52.10            | 38.80                    |
| 3   | 5350.00        | 67.1 PK                 | 74.0           | -6.9        | 1.35 V             | 234                  | 28.30            | 38.80                    |
| 4   | <b>5350.00</b> | <b>53.0 AV</b>          | <b>54.0</b>    | <b>-1.0</b> | <b>1.35 V</b>      | <b>234</b>           | <b>14.20</b>     | <b>38.80</b>             |
| 5   | 10620.00       | 57.3 PK                 | 74.0           | -16.7       | 1.00 V             | 264                  | 7.20             | 50.10                    |
| 6   | 10620.00       | 44.9 AV                 | 54.0           | -9.1        | 1.00 V             | 264                  | -5.20            | 50.10                    |

**REMARKS:**

1. Emission level (dBuV/m) = Raw Value (dBuV) + Correction Factor (dB/m).
2. Correction Factor (dB/m) = Antenna Factor (dB/m) + Cable Factor (dB).
3. The other emission levels were very low against the limit.
4. Margin value = Emission level – Limit value.
5. " \* ": Fundamental frequency.



A D T

| EUT TEST CONDITION       |                 | MEBSUREMENT DETBIL |                           |
|--------------------------|-----------------|--------------------|---------------------------|
| CHBNNEL                  | Channel 102     | FREQUENCY RBNGE    | 1 ~ 40GHz                 |
| INPUT POWER (SYSTEM)     | 120Vac, 60Hz    | DETECTOR FUNCTION  | Peak (PK)<br>Average (AV) |
| ENVIRONMENTBL CONDITIONS | 25deg. C, 67%RH | TESTED BY          | Cedric Wu                 |
| TEST MODE                | B               |                    |                           |

| ANTENNA POLARITY & TEST DISTANCE: HORIZONTAL AT 3 M |             |                         |                |             |                    |                      |                  |                          |
|---|-------------|-------------------------|----------------|-------------|--------------------|----------------------|------------------|--------------------------|
| NO.   | FREQ. (MHz) | EMISSION LEVEL (dBUV/m) | LIMIT (dBUV/m) | MARGIN (dB) | ANTENNA HEIGHT (m) | TABLE ANGLE (Degree) | RAW VALUE (dBUV) | CORRECTION FACTOR (dB/m) |
| 1   | 5460.00     | 57.0 PK                 | 74.0           | -17.0       | 1.12 H             | 165                  | 18.00            | 39.00                    |
| 2   | 5460.00     | 44.6 AV                 | 54.0           | -9.4        | 1.12 H             | 165                  | 5.60             | 39.00                    |
| 3   | #5470.00    | 60.4 PK                 | 74.0           | -13.6       | 1.10 H             | 160                  | 21.40            | 39.00                    |
| 4   | #5470.00    | 46.5 AV                 | 54.0           | -7.5        | 1.10 H             | 160                  | 7.50             | 39.00                    |
| 5   | *5510.00    | 94.2 PK                 |                |             | 1.13 H             | 162                  | 55.10            | 39.10                    |
| 6   | *5510.00    | 82.9 AV                 |                |             | 1.13 H             | 162                  | 43.80            | 39.10                    |
| 7   | 11020.00    | 59.8 PK                 | 74.0           | -14.2       | 1.00 H             | 165                  | 8.30             | 51.50                    |
| 8   | 11020.00    | 46.9 AV                 | 54.0           | -7.1        | 1.00 H             | 165                  | -4.60            | 51.50                    |
| ANTENNA POLARITY & TEST DISTANCE: VERTICAL AT 3 M   |             |                         |                |             |                    |                      |                  |                          |
| NO.   | FREQ. (MHz) | EMISSION LEVEL (dBUV/m) | LIMIT (dBUV/m) | MARGIN (dB) | ANTENNA HEIGHT (m) | TABLE ANGLE (Degree) | RAW VALUE (dBUV) | CORRECTION FACTOR (dB/m) |
| 1   | 5460.00     | 60.5 PK                 | 74.0           | -13.5       | 1.33 V             | 291                  | 21.50            | 39.00                    |
| 2   | 5460.00     | 47.1 AV                 | 54.0           | -6.9        | 1.33 V             | 291                  | 8.10             | 39.00                    |
| 3   | #5470.00    | 67.6 PK                 | 74.0           | -6.4        | 1.32 V             | 289                  | 28.60            | 39.00                    |
| 4   | #5470.00    | 51.8 AV                 | 54.0           | -2.2        | 1.32 V             | 289                  | 12.80            | 39.00                    |
| 5   | *5510.00    | 101.3 PK                |                |             | 1.43 V             | 287                  | 62.20            | 39.10                    |
| 6   | *5510.00    | 90.8 AV                 |                |             | 1.43 V             | 287                  | 51.70            | 39.10                    |
| 7   | 11020.00    | 58.8 PK                 | 74.0           | -15.2       | 1.00 V             | 257                  | 7.30             | 51.50                    |
| 8   | 11020.00    | 46.7 AV                 | 54.0           | -7.3        | 1.00 V             | 257                  | -4.80            | 51.50                    |

**REMARKS:**

1. Emission level (dBUV/m) = Raw Value (dBUV) + Correction Factor (dB/m).
2. Correction Factor (dB/m) = Antenna Factor (dB/m) + Cable Factor (dB).
3. The other emission levels were very low against the limit.
4. Margin value = Emission level – Limit value.
5. " \* ": Fundamental frequency.
6. " # ": The radiated frequency is out of the restricted band.





A D T

| EUT TEST CONDITION       |                 | MEBSUREMENT DETBIL |                           |
|--------------------------|-----------------|--------------------|---------------------------|
| CHBNNEL                  | Channel 110     | FREQUENCY RBNGE    | 1 ~ 40GHz                 |
| INPUT POWER (SYSTEM)     | 120Vac, 60Hz    | DETECTOR FUNCTION  | Peak (PK)<br>Average (AV) |
| ENVIRONMENTBL CONDITIONS | 25deg. C, 67%RH | TESTED BY          | Cedric Wu                 |
| TEST MODE                | B               |                    |                           |

| ANTENNA POLARITY & TEST DISTANCE: HORIZONTAL AT 3 M |             |                         |                |             |                    |                      |                  |                          |
|---|-------------|-------------------------|----------------|-------------|--------------------|----------------------|------------------|--------------------------|
| NO.   | FREQ. (MHz) | EMISSION LEVEL (dBuV/m) | LIMIT (dBuV/m) | MARGIN (dB) | ANTENNA HEIGHT (m) | TABLE ANGLE (Degree) | RAW VALUE (dBuV) | CORRECTION FACTOR (dB/m) |
| 1   | *5550.00    | 99.8 PK                 |                |             | 1.02 H             | 165                  | 60.70            | 39.10                    |
| 2   | *5550.00    | 89.3 AV                 |                |             | 1.02 H             | 165                  | 50.20            | 39.10                    |
| 3   | 11100.00    | 59.1 PK                 | 74.0           | -14.9       | 1.00 H             | 143                  | 7.80             | 51.30                    |
| 4   | 11100.00    | 46.6 AV                 | 54.0           | -7.4        | 1.00 H             | 143                  | -4.70            | 51.30                    |
| 5   | #16650.00   | 63.5 PK                 | 74.0           | -10.5       | 1.00 H             | 301                  | 10.90            | 52.60                    |
| 6   | #16650.00   | 50.8 AV                 | 54.0           | -3.2        | 1.00 H             | 301                  | -1.80            | 52.60                    |
| ANTENNA POLARITY & TEST DISTANCE: VERTICAL AT 3 M   |             |                         |                |             |                    |                      |                  |                          |
| NO.   | FREQ. (MHz) | EMISSION LEVEL (dBuV/m) | LIMIT (dBuV/m) | MARGIN (dB) | ANTENNA HEIGHT (m) | TABLE ANGLE (Degree) | RAW VALUE (dBuV) | CORRECTION FACTOR (dB/m) |
| 1   | *5550.00    | 108.4 PK                |                |             | 1.29 V             | 291                  | 69.30            | 39.10                    |
| 2   | *5550.00    | 97.4 AV                 |                |             | 1.29 V             | 291                  | 58.30            | 39.10                    |
| 3   | 11100.00    | 59.5 PK                 | 74.0           | -14.5       | 1.00 V             | 255                  | 8.20             | 51.30                    |
| 4   | 11100.00    | 47.1 AV                 | 54.0           | -6.9        | 1.00 V             | 255                  | -4.20            | 51.30                    |
| 5   | #16650.00   | 63.9 PK                 | 74.0           | -10.1       | 1.00 V             | 301                  | 11.30            | 52.60                    |
| 6   | #16650.00   | 51.1 AV                 | 54.0           | -2.9        | 1.00 V             | 301                  | -1.50            | 52.60                    |

**REMARKS:**

1. Emission level (dBuV/m) = Raw Value (dBuV) + Correction Factor (dB/m).
2. Correction Factor (dB/m) = Antenna Factor (dB/m) + Cable Factor (dB).
3. The other emission levels were very low against the limit.
4. Margin value = Emission level – Limit value.
5. " \* ": Fundamental frequency.
6. " # ": The radiated frequency is out of the restricted band.



A D T

| EUT TEST CONDITION       |                 | MEBSUREMENT DETBIL |                           |
|--------------------------|-----------------|--------------------|---------------------------|
| CHBNNEL                  | Channel 134     | FREQUENCY RBNGE    | 1 ~ 40GHz                 |
| INPUT POWER (SYSTEM)     | 120Vac, 60Hz    | DETECTOR FUNCTION  | Peak (PK)<br>Average (AV) |
| ENVIRONMENTBL CONDITIONS | 25deg. C, 67%RH | TESTED BY          | Cedric Wu                 |
| TEST MODE                | B               |                    |                           |

| ANTENNA POLARITY & TEST DISTANCE: HORIZONTAL AT 3 M |             |                         |                |             |                    |                      |                  |                          |
|---|-------------|-------------------------|----------------|-------------|--------------------|----------------------|------------------|--------------------------|
| NO.   | FREQ. (MHz) | EMISSION LEVEL (dBuV/m) | LIMIT (dBuV/m) | MARGIN (dB) | ANTENNA HEIGHT (m) | TABLE ANGLE (Degree) | RAW VALUE (dBuV) | CORRECTION FACTOR (dB/m) |
| 1   | *5670.00    | 97.8 PK                 |                |             | 1.00 H             | 177                  | 58.40            | 39.40                    |
| 2   | *5670.00    | 82.7 AV                 |                |             | 1.00 H             | 177                  | 43.30            | 39.40                    |
| 3   | #5725.00    | 54.4 PK                 | 74.0           | -19.6       | 1.00 H             | 180                  | 14.90            | 39.50                    |
| 4   | #5725.00    | 44.1 AV                 | 54.0           | -9.9        | 1.00 H             | 180                  | 4.60             | 39.50                    |
| 5   | 11340.00    | 58.7 PK                 | 74.0           | -15.3       | 1.00 H             | 125                  | 7.00             | 51.70                    |
| 6   | 11340.00    | 46.1 AV                 | 54.0           | -7.9        | 1.00 H             | 125                  | -5.60            | 51.70                    |
| ANTENNA POLARITY & TEST DISTANCE: VERTICAL AT 3 M   |             |                         |                |             |                    |                      |                  |                          |
| NO.   | FREQ. (MHz) | EMISSION LEVEL (dBuV/m) | LIMIT (dBuV/m) | MARGIN (dB) | ANTENNA HEIGHT (m) | TABLE ANGLE (Degree) | RAW VALUE (dBuV) | CORRECTION FACTOR (dB/m) |
| 1   | *5670.00    | 104.8 PK                |                |             | 1.26 V             | 290                  | 65.40            | 39.40                    |
| 2   | *5670.00    | 93.7 AV                 |                |             | 1.26 V             | 290                  | 54.30            | 39.40                    |
| 3   | #5725.00    | 56.0 PK                 | 74.0           | -18.0       | 1.21 V             | 291                  | 16.50            | 39.50                    |
| 4   | #5725.00    | 45.1 AV                 | 54.0           | -8.9        | 1.21 V             | 291                  | 5.60             | 39.50                    |
| 5   | 11340.00    | 58.6 PK                 | 74.0           | -15.4       | 1.00 V             | 248                  | 6.90             | 51.70                    |
| 6   | 11340.00    | 46.2 AV                 | 54.0           | -7.8        | 1.00 V             | 248                  | -5.50            | 51.70                    |

**REMARKS:**

1. Emission level (dBuV/m) = Raw Value (dBuV) + Correction Factor (dB/m).
2. Correction Factor (dB/m) = Antenna Factor (dB/m) + Cable Factor (dB).
3. The other emission levels were very low against the limit.
4. Margin value = Emission level – Limit value.
5. " \* ": Fundamental frequency.
6. " # ": The radiated frequency is out of the restricted band.

**BELOW 1GHz WORST-CASE DATA : 802.11n (20MHz)**

| EUT TEST CONDITION       |                 | MEASUREMENT DETAIL |               |
|--------------------------|-----------------|--------------------|---------------|
| CHANNEL                  | Channel 64      | FREQUENCY RANGE    | Below 1000MHz |
| INPUT POWER (SYSTEM)     | 120Vac, 60Hz    | DETECTOR FUNCTION  | Quasi-Peak    |
| ENVIRONMENTAL CONDITIONS | 25deg. C, 67%RH | TESTED BY          | Cedric Wu     |
| TEST MODE                | B               |                    |               |

| ANTENNA POLARITY & TEST DISTANCE: HORIZONTAL AT 3 M |             |                         |                |             |                    |                      |                  |                          |
|---|-------------|-------------------------|----------------|-------------|--------------------|----------------------|------------------|--------------------------|
| NO.   | FREQ. (MHz) | EMISSION LEVEL (dBuV/m) | LIMIT (dBuV/m) | MARGIN (dB) | ANTENNA HEIGHT (m) | TABLE ANGLE (Degree) | RAW VALUE (dBuV) | CORRECTION FACTOR (dB/m) |
| 1   | 175.43      | 37.9 QP                 | 43.5           | -5.6        | 2.00 H             | 295                  | 24.90            | 13.00                    |
| 2   | 187.07      | 38.6 QP                 | 43.5           | -4.9        | 1.50 H             | 286                  | 26.70            | 11.90                    |
| 3   | 359.77      | 33.1 QP                 | 46.0           | -12.9       | 1.00 H             | 3                    | 16.90            | 16.20                    |
| 4   | 749.79      | 36.0 QP                 | 46.0           | -10.0       | 1.25 H             | 56                   | 12.60            | 23.40                    |
| 5   | 792.48      | 39.9 QP                 | 46.0           | -6.1        | 1.00 H             | 43                   | 15.50            | 24.40                    |
| 6   | 905.02      | 35.0 QP                 | 46.0           | -11.0       | 1.25 H             | 230                  | 9.20             | 25.80                    |
| ANTENNA POLARITY & TEST DISTANCE: VERTICAL AT 3 M   |             |                         |                |             |                    |                      |                  |                          |
| NO.   | FREQ. (MHz) | EMISSION LEVEL (dBuV/m) | LIMIT (dBuV/m) | MARGIN (dB) | ANTENNA HEIGHT (m) | TABLE ANGLE (Degree) | RAW VALUE (dBuV) | CORRECTION FACTOR (dB/m) |
| 1   | 156.03      | 31.6 QP                 | 43.5           | -11.9       | 1.24 V             | 256                  | 17.60            | 14.00                    |
| 2   | 192.89      | 32.9 QP                 | 43.5           | -10.6       | 1.00 V             | 15                   | 21.50            | 11.40                    |
| 3   | 398.58      | 26.0 QP                 | 46.0           | -20.0       | 1.74 V             | 265                  | 8.90             | 17.10                    |
| 4   | 693.52      | 27.9 QP                 | 46.0           | -18.1       | 1.74 V             | 178                  | 5.80             | 22.10                    |
| 5   | 790.54      | 39.3 QP                 | 46.0           | -6.7        | 1.49 V             | 136                  | 14.90            | 24.40                    |
| 6   | 901.14      | 37.5 QP                 | 46.0           | -8.5        | 1.00 V             | 311                  | 11.70            | 25.80                    |

**REMARKS:**

1. Emission level (dBuV/m) = Raw Value (dBuV) + Correction Factor (dB/m).
2. Correction Factor (dB/m) = Antenna Factor (dB/m) + Cable Factor (dB).
3. The other emission levels were very low against the limit.
4. Margin value = Emission level – Limit value.



A D T

| EUT TEST CONDITION       |                 | MEASUREMENT DETAIL |               |
|--------------------------|-----------------|--------------------|---------------|
| CHANNEL                  | Channel 140     | FREQUENCY RANGE    | Below 1000MHz |
| INPUT POWER (SYSTEM)     | 120Vac, 60Hz    | DETECTOR FUNCTION  | Quasi-Peak    |
| ENVIRONMENTAL CONDITIONS | 25deg. C, 67%RH | TESTED BY          | Cedric Wu     |

| ANTENNA POLARITY & TEST DISTANCE: HORIZONTAL AT 3 M |             |                         |                |             |                    |                      |                  |                          |
|---|-------------|-------------------------|----------------|-------------|--------------------|----------------------|------------------|--------------------------|
| NO.   | FREQ. (MHz) | EMISSION LEVEL (dBuV/m) | LIMIT (dBuV/m) | MARGIN (dB) | ANTENNA HEIGHT (m) | TABLE ANGLE (Degree) | RAW VALUE (dBuV) | CORRECTION FACTOR (dB/m) |
| 1   | 198.71      | 40.5 QP                 | 43.5           | -3.0        | 1.25 H             | 278                  | 29.60            | 10.90                    |
| 2   | 249.17      | 30.9 QP                 | 46.0           | -15.1       | 1.00 H             | 96                   | 18.10            | 12.80                    |
| 3   | 408.28      | 29.5 QP                 | 46.0           | -16.5       | 1.50 H             | 39                   | 12.20            | 17.30                    |
| 4   | 693.52      | 29.1 QP                 | 46.0           | -16.9       | 1.75 H             | 264                  | 7.00             | 22.10                    |
| 5   | 800.24      | 37.4 QP                 | 46.0           | -8.6        | 1.00 H             | 38                   | 12.80            | 24.60                    |
| 6   | 949.65      | 38.3 QP                 | 46.0           | -7.7        | 1.25 H             | 242                  | 12.10            | 26.20                    |
| ANTENNA POLARITY & TEST DISTANCE: VERTICAL AT 3 M   |             |                         |                |             |                    |                      |                  |                          |
| NO.   | FREQ. (MHz) | EMISSION LEVEL (dBuV/m) | LIMIT (dBuV/m) | MARGIN (dB) | ANTENNA HEIGHT (m) | TABLE ANGLE (Degree) | RAW VALUE (dBuV) | CORRECTION FACTOR (dB/m) |
| 1   | 119.16      | 29.6 QP                 | 43.5           | -13.9       | 1.00 V             | 211                  | 17.90            | 11.70                    |
| 2   | 183.19      | 34.5 QP                 | 43.5           | -9.0        | 1.49 V             | 16                   | 22.30            | 12.20                    |
| 3   | 359.77      | 26.6 QP                 | 46.0           | -19.4       | 1.24 V             | 309                  | 10.40            | 16.20                    |
| 4   | 474.25      | 28.5 QP                 | 46.0           | -17.5       | 1.24 V             | 168                  | 9.60             | 18.90                    |
| 5   | 837.11      | 42.5 QP                 | 46.0           | -3.5        | 1.74 V             | 82                   | 17.40            | 25.10                    |
| 6   | 949.65      | 39.6 QP                 | 46.0           | -6.4        | 1.00 V             | 320                  | 13.40            | 26.20                    |

**REMARKS:**

1. Emission level (dBuV/m) = Raw Value (dBuV) + Correction Factor (dB/m).
2. Correction Factor (dB/m) = Antenna Factor (dB/m) + Cable Factor (dB).
3. The other emission levels were very low against the limit.
4. Margin value = Emission level – Limit value.

## 4.2 CONDUCTED EMISSION MEASUREMENT

### 4.2.1 LIMITS OF CONDUCTED EMISSION MEASUREMENT

| FREQUENCY OF EMISSION (MHz) | CONDUCTED LIMIT (dB $\mu$ V) |          |
|-----------------------------|------------------------------|----------|
|                             | Quasi-peak                   | Average  |
| 0.15 ~ 0.5                  | 66 to 56                     | 56 to 46 |
| 0.5 ~ 5                     | 56                           | 46       |
| 5 ~ 30                      | 60                           | 50       |

- NOTE:** 1. The lower limit shall apply at the transition frequencies.
2. The limit decreases in line with the logarithm of the frequency in the range of 0.15 to 0.50MHz.
3. All emanations from a class A/B digital device or system, including any network of conductors and apparatus connected thereto, shall not exceed the level of field strengths specified above.

### 4.2.2 TEST INSTRUMENTS

| DESCRIPTION & MANUFACTURER              | MODEL NO.                | SERIAL NO.     | DATE OF CALIBRATION | DUE DATE OF CALIBRATION |
|---|--------------------------|----------------|---------------------|-------------------------|
| Test Receiver<br>ROHDE & SCHWARZ        | ESCS30                   | 100291         | Nov. 23, 2011       | Nov. 22, 2012           |
| RF signal cable<br>Woken                | 5D-FB                    | Cable-HYC01-01 | Dec. 29, 2011       | Dec. 28, 2012           |
| LISN<br>ROHDE & SCHWARZ<br>(Peripheral) | ESH3-Z5                  | 100312         | Jul. 02, 2012       | Jul. 01, 2013           |
| LISN<br>ROHDE & SCHWARZ<br>(EUT)        | ESH3-Z5                  | 835239/001     | Feb. 07, 2012       | Feb. 06, 2013           |
| Software<br>ADT                         | BV ADT_Cond_<br>V7.3.7.3 | NA             | NA                  | NA                      |

- NOTE:** 1. The calibration interval of the above test instruments is 12 months and the calibrations are traceable to NML/ROC and NIST/USA.
2. The test was performed in HwaYa Shielded Room 1.
3. The VCCI Site Registration No. is C-2040.

### 4.2.3 TEST PROCEDURES

- The EUT was placed 0.4 meters from the conducting wall of the shielded room with EUT being connected to the power mains through a line impedance stabilization network (LISN). Other support units were connected to the power mains through another LISN. The two LISNs provide 50 ohm/ 50uH of coupling impedance for the measuring instrument.
- Both lines of the power mains connected to the EUT were checked for maximum conducted interference.
- The frequency range from 150kHz to 30MHz was searched. Emission levels under (Limit - 20dB) was not recorded.

**NOTE:** All modes of operation were investigated and the worst-case emissions are reported.

### 4.2.4 DEVIATION FROM TEST STANDARD

No deviation.

### 4.2.5 TEST SETUP

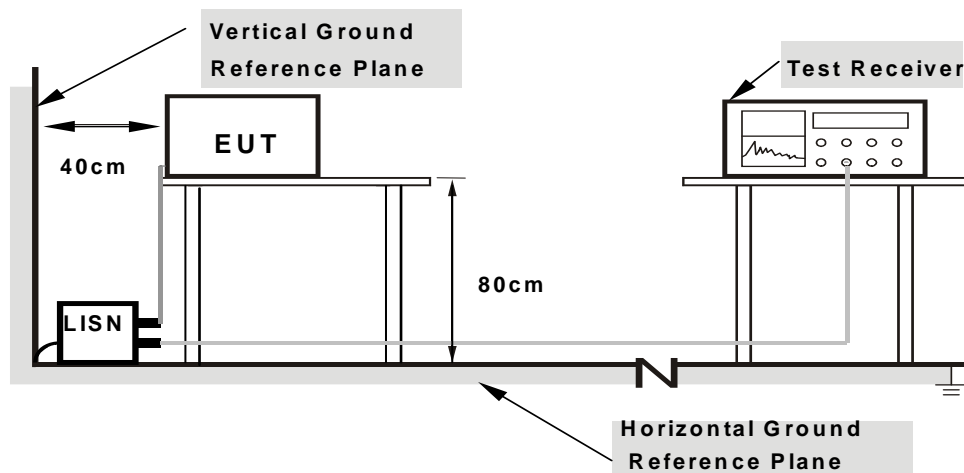

- Note:**
- Support units were connected to second LISN.
  - Both of LISNs (AMN) are 80 cm from EUT and at least 80 from other units and other metal planes

For the actual test configuration, please refer to the attached file (Test Setup Photo).

### 4.2.6 EUT OPERATING CONDITIONS

Same as 4.1.6.

### 4.2.7 TEST RESULTS

**CONDUCTED WORST-CASE DATA : 802.11n (20MHz)**

|                |            |                      |      |
|----------------|------------|----------------------|------|
| <b>PHASE</b>   | Line 1     | <b>6dB BANDWIDTH</b> | 9kHz |
| <b>CHANNEL</b> | Channel 64 | <b>TEST MODE</b>     | B    |

| No | Freq.<br>[MHz] | Corr. Factor<br>(dB) | Reading Value |       | Emission Level |       | Limit     |       | Margin |        |
|----|----------------|----------------------|---------------|-------|----------------|-------|-----------|-------|--------|--------|
|    |                |                      | [dB (uV)]     |       | [dB (uV)]      |       | [dB (uV)] |       | (dB)   |        |
|    |                |                      | Q.P.          | AV.   | Q.P.           | AV.   | Q.P.      | AV.   | Q.P.   | AV.    |
| 1  | 0.18903        | 0.13                 | 37.26         | 29.98 | 37.39          | 30.11 | 64.08     | 54.08 | -26.69 | -23.97 |
| 2  | 0.26730        | 0.13                 | 41.12         | 27.27 | 41.25          | 27.40 | 61.20     | 51.20 | -19.95 | -23.80 |
| 3  | 0.32614        | 0.13                 | 45.75         | 41.65 | 45.88          | 41.78 | 59.55     | 49.55 | -13.67 | -7.77  |
| 4  | 0.87335        | 0.18                 | 28.66         | 19.77 | 28.84          | 19.95 | 56.00     | 46.00 | -27.16 | -26.05 |
| 5  | 2.30832        | 0.24                 | 15.74         | 10.40 | 15.98          | 10.64 | 56.00     | 46.00 | -40.02 | -35.36 |
| 6  | 16.48989       | 0.98                 | 14.37         | 10.30 | 15.35          | 11.28 | 60.00     | 50.00 | -44.65 | -38.72 |

- REMARKS:**
1. Q.P. and AV. are abbreviations of quasi-peak and average individually.
  2. The emission levels of other frequencies were very low against the limit.
  3. Margin value = Emission level - Limit value
  4. Correction factor = Insertion loss + Cable loss
  5. Emission Level = Correction Factor + Reading Value.

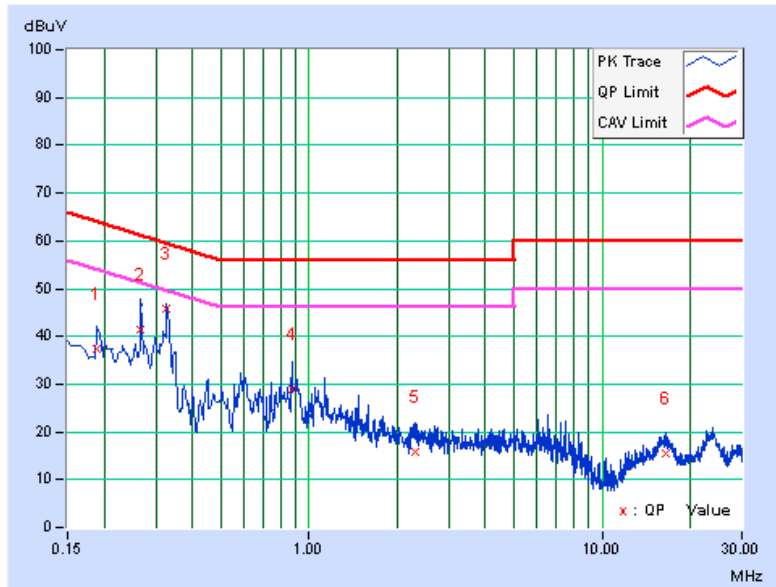



A D T

|         |            |               |      |
|---------|------------|---------------|------|
| PHASE   | Line 2     | 6dB BANDWIDTH | 9kHz |
| CHANNEL | Channel 64 | TEST MODE     | B    |

| No | Freq.<br>[MHz] | Corr. Factor<br>(dB) | Reading Value |       | Emission Level |       | Limit     |       | Margin |        |
|----|----------------|----------------------|---------------|-------|----------------|-------|-----------|-------|--------|--------|
|    |                |                      | [dB (uV)]     |       | [dB (uV)]      |       | [dB (uV)] |       | (dB)   |        |
|    |                |                      | Q.P.          | AV.   | Q.P.           | AV.   | Q.P.      | AV.   | Q.P.   | AV.    |
| 1  | 0.20031        | 0.14                 | 37.50         | 29.05 | 37.64          | 29.19 | 63.60     | 53.60 | -25.96 | -24.41 |
| 2  | 0.29467        | 0.14                 | 44.21         | 31.90 | 44.35          | 32.04 | 60.39     | 50.39 | -16.04 | -18.35 |
| 3  | 0.32357        | 0.15                 | 44.59         | 38.58 | 44.74          | 38.73 | 59.61     | 49.61 | -14.88 | -10.89 |
| 4  | 0.58384        | 0.17                 | 26.59         | 20.69 | 26.76          | 20.86 | 56.00     | 46.00 | -29.24 | -25.14 |
| 5  | 0.87372        | 0.20                 | 29.22         | 20.84 | 29.42          | 21.04 | 56.00     | 46.00 | -26.58 | -24.96 |
| 6  | 15.95031       | 0.82                 | 15.63         | 11.66 | 16.45          | 12.48 | 60.00     | 50.00 | -43.55 | -37.52 |

- REMARKS:**
1. Q.P. and AV. are abbreviations of quasi-peak and average individually.
  2. The emission levels of other frequencies were very low against the limit.
  3. Margin value = Emission level - Limit value
  4. Correction factor = Insertion loss + Cable loss
  5. Emission Level = Correction Factor + Reading Value.

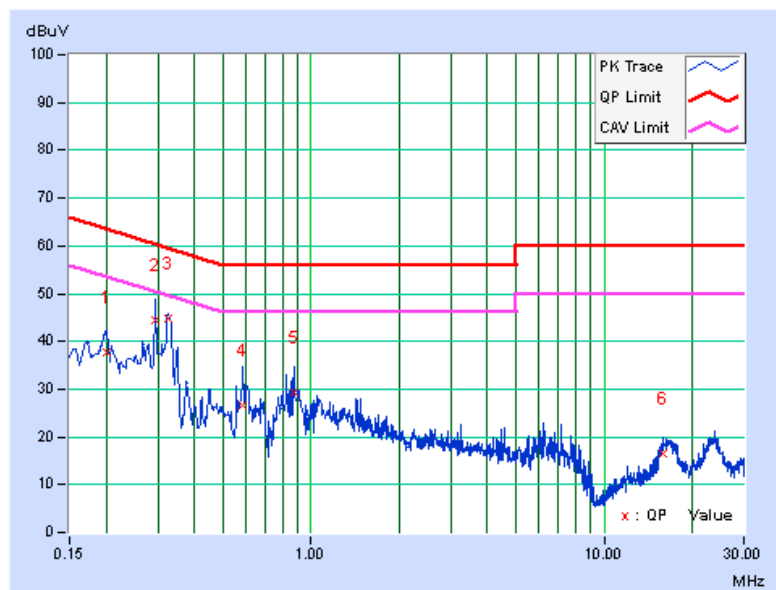





A D T

|                |             |                      |      |
|----------------|-------------|----------------------|------|
| <b>PHASE</b>   | Line 1      | <b>6dB BANDWIDTH</b> | 9kHz |
| <b>CHANNEL</b> | Channel 140 | <b>TEST MODE</b>     | B    |

| No       | Freq.<br>[MHz] | Corr. Factor<br>(dB) | Reading Value |              | Emission Level |              | Limit        |              | Margin        |              |
|----------|----------------|----------------------|---------------|--------------|----------------|--------------|--------------|--------------|---------------|--------------|
|          |                |                      | [dB (uV)]     |              | [dB (uV)]      |              | [dB (uV)]    |              | (dB)          |              |
|          |                |                      | Q.P.          | AV.          | Q.P.           | AV.          | Q.P.         | AV.          | Q.P.          | AV.          |
| 1        | 0.19510        | 0.13                 | 36.74         | 30.39        | 36.87          | 30.52        | 63.82        | 53.82        | -26.95        | -23.30       |
| 2        | 0.27480        | 0.13                 | 41.61         | 34.68        | 41.74          | 34.81        | 60.97        | 50.97        | -19.23        | -16.16       |
| <b>3</b> | <b>0.32595</b> | <b>0.13</b>          | <b>45.65</b>  | <b>41.83</b> | <b>45.78</b>   | <b>41.96</b> | <b>59.55</b> | <b>49.55</b> | <b>-13.77</b> | <b>-7.59</b> |
| 4        | 0.85380        | 0.18                 | 30.22         | 19.05        | 30.40          | 19.23        | 56.00        | 46.00        | -25.60        | -26.77       |
| 5        | 6.80873        | 0.48                 | 13.99         | 7.78         | 14.47          | 8.26         | 60.00        | 50.00        | -45.53        | -41.74       |
| 6        | 16.04415       | 0.96                 | 15.25         | 10.35        | 16.21          | 11.31        | 60.00        | 50.00        | -43.79        | -38.69       |

- REMARKS:**
1. Q.P. and AV. are abbreviations of quasi-peak and average individually.
  2. The emission levels of other frequencies were very low against the limit.
  3. Margin value = Emission level - Limit value
  4. Correction factor = Insertion loss + Cable loss
  5. Emission Level = Correction Factor + Reading Value.

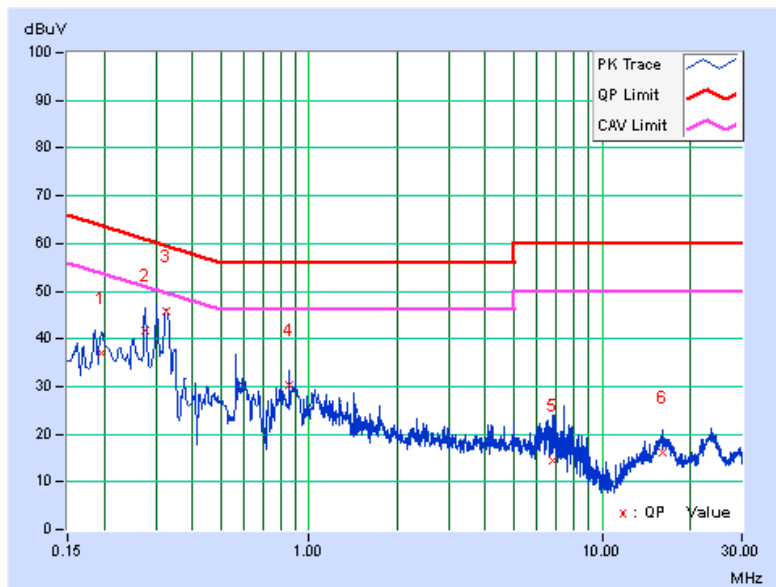

|         |             |               |      |
|---------|-------------|---------------|------|
| PHASE   | Line 2      | 6dB BANDWIDTH | 9kHz |
| CHANNEL | Channel 140 | TEST MODE     | B    |

| No | Freq.<br>[MHz] | Corr. Factor<br>(dB) | Reading Value |       | Emission Level |       | Limit     |       | Margin |        |
|----|----------------|----------------------|---------------|-------|----------------|-------|-----------|-------|--------|--------|
|    |                |                      | [dB (uV)]     |       | [dB (uV)]      |       | [dB (uV)] |       | (dB)   |        |
|    |                |                      | Q.P.          | AV.   | Q.P.           | AV.   | Q.P.      | AV.   | Q.P.   | AV.    |
| 1  | 0.17374        | 0.13                 | 37.33         | 28.11 | 37.46          | 28.24 | 64.78     | 54.78 | -27.32 | -26.54 |
| 2  | 0.26346        | 0.14                 | 39.15         | 28.83 | 39.29          | 28.97 | 61.32     | 51.32 | -22.03 | -22.35 |
| 3  | 0.32528        | 0.15                 | 45.52         | 41.27 | 45.67          | 41.42 | 59.57     | 49.57 | -13.90 | -8.15  |
| 4  | 0.57317        | 0.17                 | 31.89         | 20.20 | 32.06          | 20.37 | 56.00     | 46.00 | -23.94 | -25.63 |
| 5  | 0.86553        | 0.20                 | 30.64         | 18.18 | 30.84          | 18.38 | 56.00     | 46.00 | -25.16 | -27.62 |
| 6  | 6.27306        | 0.44                 | 14.92         | 9.04  | 15.36          | 9.48  | 60.00     | 50.00 | -44.64 | -40.52 |

- REMARKS:**
1. Q.P. and AV. are abbreviations of quasi-peak and average individually.
  2. The emission levels of other frequencies were very low against the limit.
  3. Margin value = Emission level - Limit value
  4. Correction factor = Insertion loss + Cable loss
  5. Emission Level = Correction Factor + Reading Value.

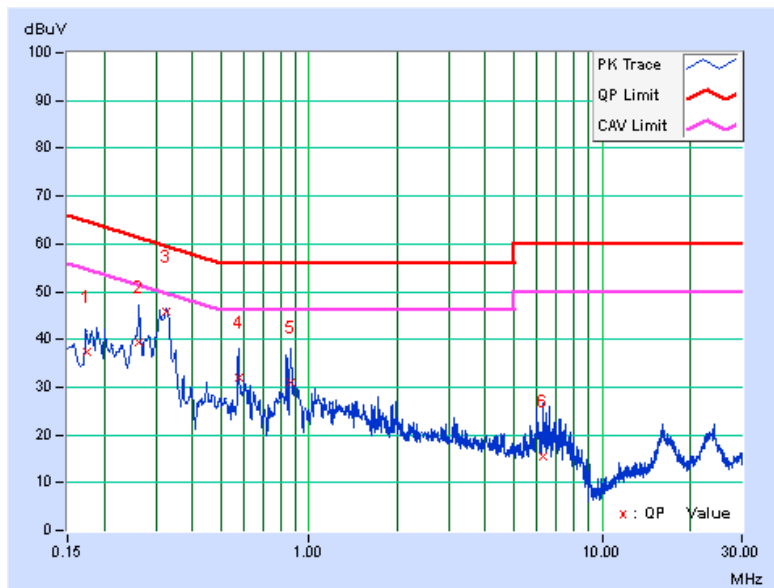

### 4.3 PEAK TRANSMIT POWER MEASUREMENT

#### 4.3.1 LIMITS OF PEAK TRANSMIT POWER MEASUREMENT

| FREQUENCY BAND   | LIMIT   |
|------------------|---|
| 5.150 ~ 5.250GHz | The lesser of 50mW (17dBm) or 4dBm + 10logB   |
| 5.250 ~ 5.350GHz | The lesser of 250mW (24dBm) or 11dBm + 10logB |
| 5.470 ~ 5.725GHz | The lesser of 250mW (24dBm) or 11dBm + 10logB |

**NOTE:** Where B is the 26dB emission bandwidth in MHz.

Per KDB 662911 D01 Multiple Transmitter Output v01r02 Method of conducted output power measurement on IEEE 802.11 devices,

Array Gain = 0 dB (i.e., no array gain) for  $N_{ANT} \leq 4$ ;

Array Gain = 0 dB (i.e., no array gain) for channel widths  $\geq 40$  MHz for any  $N_{ANT}$ ;

Array Gain =  $5 \log(N_{ANT} / NSS)$  dB or 3 dB, whichever is less for 20-MHz channel widths with  $N_{ANT} \geq 5$ .

For power measurements on all other devices: Array Gain =  $10 \log(N_{ANT} / NSS)$  dB.

#### 4.3.2 TEST SETUP

##### FOR POWER OUTPUT MEASUREMENT

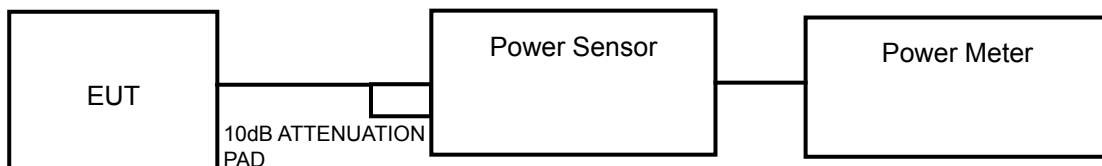

##### FOR 26dB BANDWIDTH

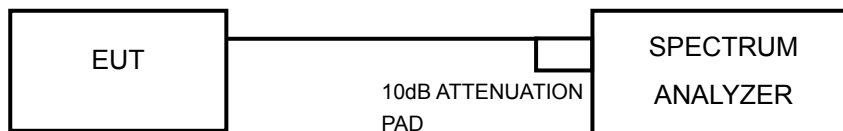

#### 4.3.3 TEST INSTRUMENTS

Refer to section 4.1.3 to get information of above instrument.

#### 4.3.4 TEST PROCEDURE

##### FOR AVERAGE POWER MEASUREMENT

Duty cycle of test signal is < 98 %. Method PM is used to perform output power measurement, trigger and gating function of wide band power meter is enabled to measure max output power of TX on burst. Duty factor is not added to measured value.

##### FOR 26dB BANDWIDTH

- 1) Set RBW = approximately 1% of the emission bandwidth.
- 2) Set the VBW > RBW.
- 3) Detector = Peak.
- 4) Trace mode = max hold.
- 5) Measure the maximum width of the emission that is 26 dB down from the peak of the emission. Compare this with the RBW setting of the analyzer. Readjust RBW and repeat measurement as needed until the RBW/EBW ratio is approximately 1%.

#### 4.3.5 DEVIATION FROM TEST STANDARD

No deviation.

#### 4.3.6 EUT OPERATING CONDITIONS

The software provided by client to enable the EUT under transmission condition continuously at specific channel frequencies individually.

#### 4.3.7 TEST RESULTS

##### POWER OUTPUT: 802.11a

| CHANNEL | CHANNEL FREQUENCY (MHz) | AVERAGE POWER (mW) | AVERAGE POWER (dBm) | POWER LIMIT (dBm) | PASS/FAIL |
|---------|-------------------------|--------------------|---------------------|-------------------|-----------|
| 36      | 5180                    | 11.99              | 10.79               | 17                | PASS      |
| 44      | 5220                    | 11.40              | 10.57               | 17                | PASS      |
| 48      | 5240                    | 14.89              | 11.73               | 17                | PASS      |
| 52      | 5260                    | 16.75              | 12.24               | 24                | PASS      |
| 60      | 5300                    | 13.46              | 11.29               | 24                | PASS      |
| 64      | 5320                    | 13.90              | 11.43               | 24                | PASS      |
| 100     | 5500                    | 14.39              | 11.58               | 24                | PASS      |
| 116     | 5580                    | 16.03              | 12.05               | 24                | PASS      |
| 140     | 5700                    | 19.59              | 12.92               | 24                | PASS      |

**802.11n (20MHz)****1TX**

| CHANNEL | CHANNEL FREQUENCY (MHz) | AVERAGE POWER (mW) | AVERAGE POWER (dBm) | POWER LIMIT (dBm) | PASS/FAIL |
|---------|-------------------------|--------------------|---------------------|-------------------|-----------|
| 36      | 5180                    | 6.11               | 7.86                | 17                | PASS      |
| 44      | 5220                    | 6.10               | 7.85                | 17                | PASS      |
| 48      | 5240                    | 6.28               | 7.98                | 17                | PASS      |
| 52      | 5260                    | 6.35               | 8.03                | 24                | PASS      |
| 60      | 5300                    | 6.40               | 8.06                | 24                | PASS      |
| 64      | 5320                    | 6.90               | 8.39                | 24                | PASS      |
| 100     | 5500                    | 4.41               | 6.44                | 24                | PASS      |
| 116     | 5580                    | 5.73               | 7.58                | 24                | PASS      |
| 140     | 5700                    | 11.04              | 10.43               | 24                | PASS      |

**2TX**

| CHAN. | CHAN. FREQ. (MHz) | AVERAGE POWER (dBm) |         | TOTAL POWER (mW) | TOTAL POWER (dBm) | POWER LIMIT (dBm) | PASS / FAIL |
|-------|-------------------|---------------------|---------|------------------|-------------------|-------------------|-------------|
|       |                   | CHAIN 0             | CHAIN 1 |                  |                   |                   |             |
| 36    | 5180              | 11.55               | 8.95    | 22.14            | 13.45             | 17                | PASS        |
| 44    | 5220              | 10.84               | 10.7    | <b>23.88</b>     | 13.78             | 17                | PASS        |
| 48    | 5240              | 11.49               | 9.89    | 23.84            | 13.77             | 17                | PASS        |
| 52    | 5260              | 11.54               | 12.17   | 30.74            | 14.88             | 24                | PASS        |
| 60    | 5300              | 12.68               | 12.9    | <b>38.03</b>     | 15.80             | 24                | PASS        |
| 64    | 5320              | 12.36               | 13.13   | 37.78            | 15.77             | 24                | PASS        |
| 100   | 5500              | 12.97               | 12.31   | 36.84            | 15.66             | 24                | PASS        |
| 116   | 5580              | 12.22               | 12.4    | 34.05            | 15.32             | 24                | PASS        |
| 140   | 5700              | 12.23               | 13.16   | <b>37.41</b>     | 15.73             | 24                | PASS        |



802.11n (40MHz)

1TX

| CHANNEL | CHANNEL FREQUENCY (MHz) | AVERAGE POWER (mW) | AVERAGE POWER (dBm) | POWER LIMIT (dBm) | PASS/FAIL |
|---------|-------------------------|--------------------|---------------------|-------------------|-----------|
| 38      | 5190                    | 2.90               | 4.63                | 17                | PASS      |
| 46      | 5230                    | 2.96               | 4.72                | 17                | PASS      |
| 54      | 5270                    | 3.03               | 4.82                | 24                | PASS      |
| 62      | 5310                    | 3.10               | 4.91                | 24                | PASS      |
| 102     | 5510                    | 2.56               | 4.08                | 24                | PASS      |
| 110     | 5550                    | 3.33               | 5.23                | 24                | PASS      |
| 134     | 5670                    | 4.40               | 6.43                | 24                | PASS      |

2TX

| CHAN. | CHAN. FREQ. (MHz) | AVERAGE POWER (dBm) |         | TOTAL POWER (mW) | TOTAL POWER (dBm) | POWER LIMIT (dBm) | PASS / FAIL |
|-------|-------------------|---------------------|---------|------------------|-------------------|-------------------|-------------|
|       |                   | CHAIN 0             | CHAIN 1 |                  |                   |                   |             |
| 38    | 5190              | 8.51                | 9.18    | 15.38            | 11.87             | 17                | PASS        |
| 46    | 5230              | 8.43                | 8.94    | 14.80            | 11.70             | 17                | PASS        |
| 54    | 5270              | 8.94                | 8.67    | 15.20            | 11.82             | 24                | PASS        |
| 62    | 5310              | 8.25                | 9.94    | 16.55            | 12.19             | 24                | PASS        |
| 102   | 5510              | 9.45                | 9.25    | 17.22            | 12.36             | 24                | PASS        |
| 110   | 5550              | 10.63               | 10.52   | 22.83            | 13.59             | 24                | PASS        |
| 134   | 5670              | 9.28                | 10.07   | 18.63            | 12.70             | 24                | PASS        |



A D T

**26dB BANDWIDTH: 802.11a**

| CHANNEL | CHANNEL FREQUENCY (MHz) | 26dBc BANDWIDTH (MHz) | PASS / FAIL |
|---------|-------------------------|-----------------------|-------------|
| 36      | 5180                    | 20.00                 | PASS        |
| 44      | 5220                    | 20.10                 | PASS        |
| 48      | 5240                    | 20.05                 | PASS        |
| 52      | 5260                    | 19.57                 | PASS        |
| 60      | 5300                    | 19.90                 | PASS        |
| 64      | 5320                    | 19.75                 | PASS        |
| 100     | 5500                    | 19.83                 | PASS        |
| 116     | 5580                    | 20.03                 | PASS        |
| 140     | 5700                    | 19.96                 | PASS        |





A D T

### 802.11n (20MHz)

#### 1TX

| CHANNEL | CHANNEL FREQUENCY (MHz) | 26dBc BANDWIDTH (MHz) | PASS / FAIL |
|---------|-------------------------|-----------------------|-------------|
| 36      | 5180                    | 20.36                 | PASS        |
| 44      | 5220                    | 20.39                 | PASS        |
| 48      | 5240                    | 20.33                 | PASS        |
| 52      | 5260                    | 20.34                 | PASS        |
| 60      | 5300                    | 20.31                 | PASS        |
| 64      | 5320                    | 20.39                 | PASS        |
| 100     | 5500                    | 20.38                 | PASS        |
| 116     | 5580                    | 20.32                 | PASS        |
| 140     | 5700                    | 20.34                 | PASS        |

#### 2TX

| CHANNEL | CHANNEL FREQUENCY (MHz) | 26dBc BANDWIDTH (MHz) |         | PASS / FAIL |
|---------|-------------------------|-----------------------|---------|-------------|
|         |                         | CHAIN 0               | CHAIN 1 |             |
| 36      | 5180                    | 20.10                 | 19.89   | PASS        |
| 44      | 5220                    | 20.24                 | 20.09   | PASS        |
| 48      | 5240                    | 20.10                 | 19.76   | PASS        |
| 52      | 5260                    | 20.08                 | 19.88   | PASS        |
| 60      | 5300                    | 20.15                 | 20.18   | PASS        |
| 64      | 5320                    | 20.18                 | 19.92   | PASS        |
| 100     | 5500                    | 20.08                 | 20.10   | PASS        |
| 116     | 5580                    | 20.13                 | 19.98   | PASS        |
| 140     | 5700                    | 20.27                 | 19.86   | PASS        |



802.11n (40MHz)

1TX

| CHANNEL | CHANNEL FREQUENCY (MHz) | 26dBc BANDWIDTH (MHz) | PASS / FAIL |
|---------|-------------------------|-----------------------|-------------|
| 38      | 5190                    | 41.82                 | PASS        |
| 46      | 5230                    | 41.76                 | PASS        |
| 54      | 5270                    | 41.85                 | PASS        |
| 62      | 5310                    | 41.64                 | PASS        |
| 102     | 5510                    | 41.72                 | PASS        |
| 110     | 5550                    | 41.72                 | PASS        |
| 134     | 5670                    | 41.77                 | PASS        |

2TX

| CHANNEL | CHANNEL FREQUENCY (MHz) | 26dBc BANDWIDTH (MHz) |         | PASS / FAIL |
|---------|-------------------------|-----------------------|---------|-------------|
|         |                         | CHAIN 0               | CHAIN 1 |             |
| 38      | 5190                    | 57.97                 | 41.72   | PASS        |
| 46      | 5230                    | 41.79                 | 41.46   | PASS        |
| 54      | 5270                    | 42.25                 | 41.57   | PASS        |
| 62      | 5310                    | 42.03                 | 41.57   | PASS        |
| 102     | 5510                    | 41.79                 | 41.47   | PASS        |
| 110     | 5550                    | 49.93                 | 41.33   | PASS        |
| 134     | 5670                    | 41.87                 | 41.59   | PASS        |

#### 4.4 PEAK POWER SPECTRAL DENSITY MEASUREMENT

##### 4.4.1 LIMITS OF PEAK POWER SPECTRAL DENSITY MEASUREMENT

| FREQUENCY BAND   | LIMIT |
|------------------|-------|
| 5.150 ~ 5.250GHz | 4dBm  |
| 5.250 ~ 5.350GHz | 11dBm |
| 5.470 ~ 5.725GHz | 11dBm |

##### 4.4.2 TEST SETUP

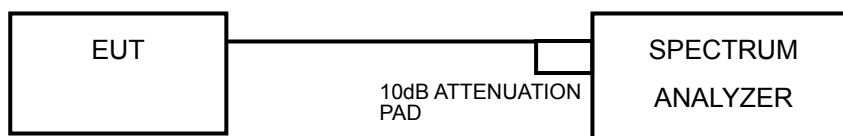

##### 4.4.3 TEST INSTRUMENTS

Refer to section 4.1.3 to get information of above instrument.

##### 4.4.4 TEST PROCEDURES

- 1) Set span to encompass the entire emission bandwidth (EBW) of the signal.
- 2) Set RBW = 1 MHz, Set VBW  $\geq$  3 MHz, Detector = RMS
- 3) Sweep time = 5 second.
- 4) Perform a single sweep.
- 5) Record the max value and add  $10 \log (1/\text{duty cycle})$

##### 4.4.5 DEVIATION FROM TEST STANDARD

No deviation.

##### 4.4.6 EUT OPERATING CONDITIONS

Same as 4.3.6.



### 4.4.7 TEST RESULTS

#### 802.11a

| CHANNEL | FREQUENCY (MHz) | PSD W/O DUTY FACTOR (dBm) | DUTY FACTOR | PSD WITH DUTY FACTOR (dBm) | MAXIMUM LIMIT (dBm) | PASS/FAIL |
|---------|-----------------|---------------------------|-------------|----------------------------|---------------------|-----------|
| 36      | 5180            | -0.79                     | 0.68        | -0.11                      | 4                   | PASS      |
| 44      | 5220            | 0.45                      | 0.68        | 1.13                       | 4                   | PASS      |
| 48      | 5240            | 1.97                      | 0.68        | 2.65                       | 4                   | PASS      |
| 52      | 5260            | 1.87                      | 0.68        | 2.55                       | 11                  | PASS      |
| 60      | 5300            | 1.35                      | 0.68        | 2.03                       | 11                  | PASS      |
| 64      | 5320            | 1.45                      | 0.68        | 2.13                       | 11                  | PASS      |
| 100     | 5500            | 1.13                      | 0.68        | 1.81                       | 11                  | PASS      |
| 116     | 5580            | 2.04                      | 0.68        | 2.72                       | 11                  | PASS      |
| 140     | 5700            | 4.57                      | 0.68        | 5.25                       | 11                  | PASS      |

**NOTE:** Refer to section 3.3 for duty cycle spectrum plot.



**802.11n (20MHz)**

**1TX**

| CHANNEL | FREQUENCY (MHz) | PSD W/O DUTY FACTOR (dBm) | DUTY FACTOR | PSD WITH DUTY FACTOR (dBm) | MAXIMUM LIMIT (dBm) | PASS/FAIL |
|---------|-----------------|---------------------------|-------------|----------------------------|---------------------|-----------|
| 36      | 5180            | -1.46                     | 0.76        | -0.70                      | 4                   | PASS      |
| 44      | 5220            | -1.52                     | 0.76        | -0.76                      | 4                   | PASS      |
| 48      | 5240            | -1.21                     | 0.76        | -0.45                      | 4                   | PASS      |
| 52      | 5260            | -1.24                     | 0.76        | -0.48                      | 11                  | PASS      |
| 60      | 5300            | -1.2                      | 0.76        | -0.44                      | 11                  | PASS      |
| 64      | 5320            | -1.01                     | 0.76        | -0.25                      | 11                  | PASS      |
| 100     | 5500            | -2.7                      | 0.76        | -1.94                      | 11                  | PASS      |
| 116     | 5580            | -1.58                     | 0.76        | -0.82                      | 11                  | PASS      |
| 140     | 5700            | 1.31                      | 0.76        | 2.07                       | 11                  | PASS      |

**NOTE:** Refer to section 3.3 for duty cycle spectrum plot.

**2TX**

| CHAN. | CHAN. FREQ. (MHz) | PSD (dBm) |         | TOTAL PSD W/O DUTY FACTOR (dBm) | DUTY FACTOR | TOTAL PSD WITH DUTY FACTOR (dBm) | MAX. LIMIT (dBm) | PASS / FAIL |
|-------|-------------------|-----------|---------|---------------------------------|-------------|----------------------------------|------------------|-------------|
|       |                   | CHAIN 0   | CHAIN 1 |                                 |             |                                  |                  |             |
| 36    | 5180              | -1.36     | -1.83   | 1.42                            | 1.33        | 2.75                             | 4                | PASS        |
| 44    | 5220              | -1.13     | -0.86   | 2.02                            | 1.33        | 3.35                             | 4                | PASS        |
| 48    | 5240              | -0.75     | -1.3    | 1.99                            | 1.33        | 3.32                             | 4                | PASS        |
| 52    | 5260              | 1.76      | 1.82    | 4.80                            | 1.33        | 6.13                             | 10.05            | PASS        |
| 60    | 5300              | 2.64      | 2.29    | 5.48                            | 1.33        | 6.81                             | 10.05            | PASS        |
| 64    | 5320              | 2.46      | 2.43    | 5.46                            | 1.33        | 6.79                             | 10.05            | PASS        |
| 100   | 5500              | 3.05      | 1.57    | 5.38                            | 1.33        | 6.71                             | 10.26            | PASS        |
| 116   | 5580              | 2.40      | 1.90    | 5.17                            | 1.33        | 6.50                             | 10.26            | PASS        |
| 140   | 5700              | 2.64      | 2.85    | 5.76                            | 1.33        | 2.75                             | 10.26            | PASS        |

**NOTE:**

- Method 1 of power density measurement of KDB 662911 is using for calculating total power density. Total power density is summing entire spectra across corresponding frequency bins on the various outputs by computer.
- Refer to section 3.3 for duty cycle spectrum plot.
- 5.18 ~ 5.24GHz:** Directional gain =  $2.59\text{dBi} + 10\log(2) = 5.60\text{dBi} < 6\text{dBi}$ , so the power density limit shall be not reduced limit.  
**5.26 ~ 5.32GHz:** Directional gain =  $3.94\text{dBi} + 10\log(2) = 6.95\text{dBi} > 6\text{dBi}$ , so the power density limit shall be reduced to  $11 - (6.95 - 6) = 10.05\text{dBm}$ .  
**5.50 ~ 5.70GHz:** Directional gain =  $3.73\text{dBi} + 10\log(2) = 6.74\text{dBi} > 6\text{dBi}$ , so the power density limit shall be reduced to  $11 - (6.74 - 6) = 10.26\text{dBm}$ .



**802.11n (40MHz)**

**1TX**

| CHANNEL | FREQUENCY (MHz) | PSD W/O DUTY FACTOR (dBm) | DUTY FACTOR | PSD WITH DUTY FACTOR (dBm) | MAXIMUM LIMIT (dBm) | PASS/FAIL |
|---------|-----------------|---------------------------|-------------|----------------------------|---------------------|-----------|
| 38      | 5190            | -5.06                     | 1.24        | -3.82                      | 4                   | PASS      |
| 46      | 5230            | -4.95                     | 1.24        | -3.71                      | 4                   | PASS      |
| 54      | 5270            | -5.00                     | 1.24        | -3.76                      | 11                  | PASS      |
| 62      | 5310            | -4.79                     | 1.24        | -3.55                      | 11                  | PASS      |
| 102     | 5510            | -5.8                      | 1.24        | -4.56                      | 11                  | PASS      |
| 110     | 5550            | -4.56                     | 1.24        | -3.32                      | 11                  | PASS      |
| 134     | 5670            | -3.24                     | 1.24        | -2.00                      | 11                  | PASS      |

**NOTE:** Refer to section 3.3 for duty cycle spectrum plot.

**2TX**

| CHAN. | CHAN. FREQ. (MHz) | PSD (dBm) |         | TOTAL PSD W/O DUTY FACTOR (dBm) | DUTY FACTOR | TOTAL PSD WITH DUTY FACTOR (dBm) | MAX. LIMIT (dBm) | PASS / FAIL |
|-------|-------------------|-----------|---------|---------------------------------|-------------|----------------------------------|------------------|-------------|
|       |                   | CHAIN 0   | CHAIN 1 |                                 |             |                                  |                  |             |
| 38    | 5190              | -2.68     | -2.73   | 0.31                            | 2.19        | 2.50                             | 4                | PASS        |
| 46    | 5230              | -2.65     | -2.98   | 0.20                            | 2.19        | 2.39                             | 4                | PASS        |
| 54    | 5270              | -1.9      | -2.62   | 0.77                            | 2.19        | 2.96                             | 10.05            | PASS        |
| 62    | 5310              | -2.67     | -2.12   | 0.62                            | 2.19        | 2.81                             | 10.05            | PASS        |
| 102   | 5510              | -1.4      | -2.63   | 1.04                            | 2.19        | 3.23                             | 10.26            | PASS        |
| 110   | 5550              | -0.33     | -1.49   | 2.14                            | 2.19        | 4.33                             | 10.26            | PASS        |
| 134   | 5670              | -1.63     | -1.94   | 1.23                            | 2.19        | 3.42                             | 10.26            | PASS        |

**NOTE:**

- Method 1 of power density measurement of KDB 662911 is using for calculating total power density. Total power density is summing entire spectra across corresponding frequency bins on the various outputs by computer.
- Refer to section 3.3 for duty cycle spectrum plot.
- 5.18 ~ 5.24GHz:** Directional gain = 2.59dBi + 10log(2) = 5.60dBi < 6dBi, so the power density limit shall be not reduced limit.

**5.26 ~ 5.32GHz:** Directional gain = 3.94dBi + 10log(2) = 6.95dBi > 6dBi, so the power density limit shall be reduced to 11-(6.95-6) = 10.05dBm.

**5.50 ~ 5.70GHz:** Directional gain = 3.73dBi + 10log(2) = 6.74dBi > 6dBi, so the power density limit shall be reduced to 11-(6.74-6) = 10.26dBm.

## 4.5 PEAK POWER EXCURSION MEASUREMENT

### 4.5.1 LIMITS OF PEAK POWER EXCURSION MEASUREMENT

Shall not exceed 13 dB.

### 4.5.2 TEST SETUP

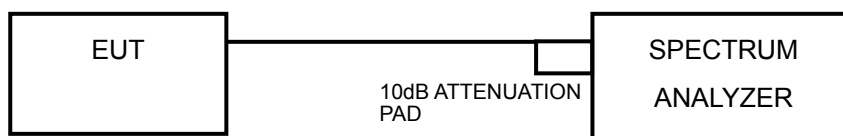

### 4.5.3 TEST INSTRUMENTS

Refer to section 4.1.3 to get information of above instrument.

### 4.5.4 TEST PROCEDURE

- 1) Set RBW = 1 MHz, VBW  $\geq$  3 MHz, Detector = peak.
- 2) Trace mode = max-hold. Allow the sweeps to continue until the trace stabilizes.
- 3) Use the peak search function to find the peak of the spectrum.
- 4) Measure the PPSD.
- 5) Compute the ratio of the maximum of the peak-max-hold spectrum to the PPSD.

### 4.5.5 DEVIATION FROM TEST STANDARD

No deviation.

### 4.5.6 EUT OPERATING CONDITIONS

Same as 4.2.6



A D T

### 4.5.7 TEST RESULTS

#### 802.11a

| CHAN. | CHANNEL FREQUENCY (MHz) | PEAK VALUE (dBm) | PSD W/O DUTY FACTOR (dBm) | PSD WITH DUTY FACTOR (dBm) | PEAK EXCURSION (dB) | LIMIT (dB) | PASS /FAIL |
|-------|-------------------------|------------------|---------------------------|----------------------------|---------------------|------------|------------|
| 36    | 5180                    | 10.79            | -0.79                     | -0.11                      | 10.90               | 13         | PASS       |
| 44    | 5220                    | 10.57            | 0.45                      | 1.13                       | 9.44                | 13         | PASS       |
| 48    | 5240                    | 11.73            | 1.97                      | 2.65                       | 9.08                | 13         | PASS       |
| 52    | 5260                    | 12.24            | 1.87                      | 2.55                       | 9.69                | 13         | PASS       |
| 60    | 5300                    | 11.29            | 1.35                      | 2.03                       | 9.26                | 13         | PASS       |
| 64    | 5320                    | 11.43            | 1.45                      | 2.13                       | 9.30                | 13         | PASS       |
| 100   | 5500                    | 11.58            | 1.13                      | 1.81                       | 9.77                | 13         | PASS       |
| 116   | 5580                    | 12.05            | 2.04                      | 2.72                       | 9.33                | 13         | PASS       |
| 140   | 5700                    | 12.92            | 4.57                      | 5.25                       | 7.67                | 13         | PASS       |

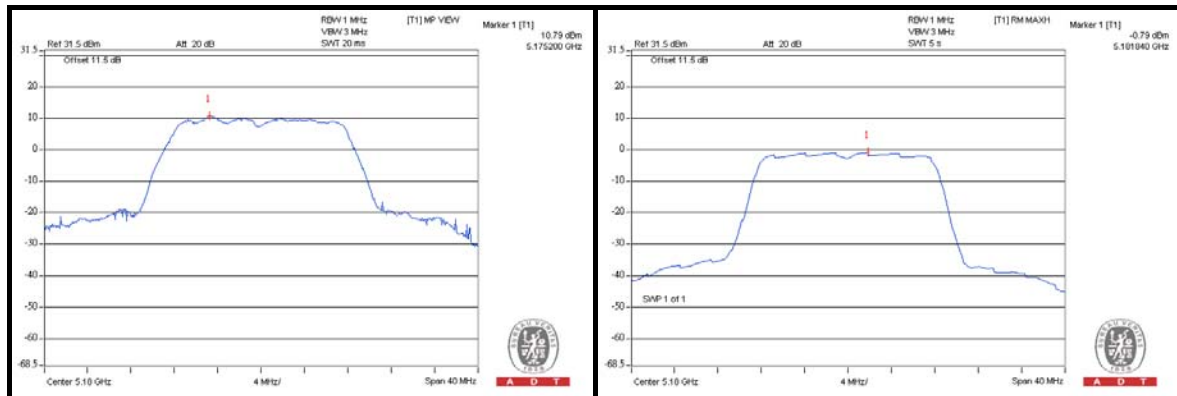





A D T

### 802.11n (20MHz)

#### 1TX

| CHAN. | CHANNEL FREQUENCY (MHz) | PEAK VALUE (dBm) | PSD W/O DUTY FACTOR (dBm) | PSD WITH DUTY FACTOR (dBm) | PEAK EXCURSION (dB) | LIMIT (dB) | PASS /FAIL |
|-------|-------------------------|------------------|---------------------------|----------------------------|---------------------|------------|------------|
| 36    | 5180                    | 7.86             | -1.46                     | -0.70                      | 8.56                | 13         | PASS       |
| 44    | 5220                    | 7.85             | -1.52                     | -0.76                      | 8.61                | 13         | PASS       |
| 48    | 5240                    | 7.98             | -1.21                     | -0.45                      | 8.43                | 13         | PASS       |
| 52    | 5260                    | 8.03             | -1.24                     | -0.48                      | 8.51                | 13         | PASS       |
| 60    | 5300                    | 8.06             | -1.2                      | -0.44                      | 8.50                | 13         | PASS       |
| 64    | 5320                    | 8.39             | -1.01                     | -0.25                      | 8.64                | 13         | PASS       |
| 100   | 5500                    | 6.44             | -2.7                      | -1.94                      | 8.38                | 13         | PASS       |
| 116   | 5580                    | 7.58             | -1.58                     | -0.82                      | 8.40                | 13         | PASS       |
| 140   | 5700                    | 10.43            | 1.31                      | 2.07                       | 8.36                | 13         | PASS       |

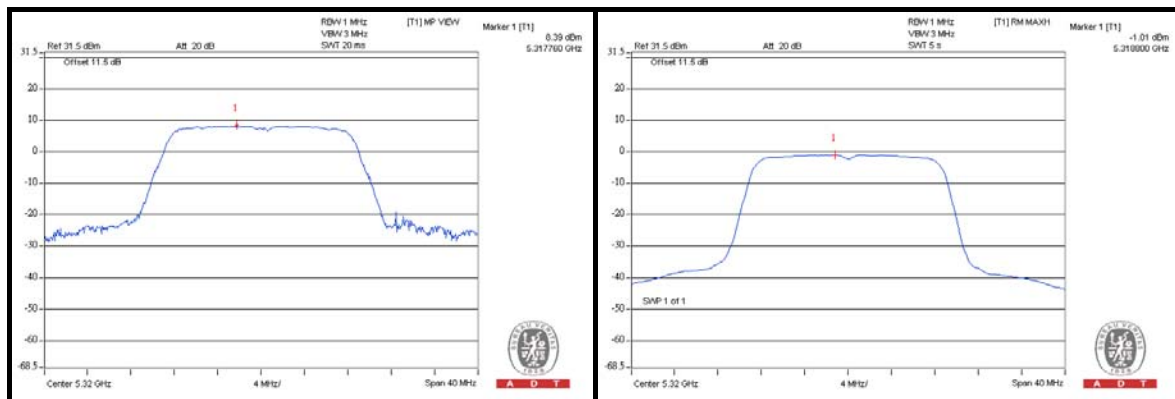



A D T

2TX

| TX chain | CHAN. | CHANNEL FREQUENCY (MHz) | PEAK VALUE (dBm) | PSD W/O DUTY FACTOR (dBm) | PSD WITH DUTY FACTOR (dBm) | PEAK EXCURSION (dB) | LIMIT (dB) | PASS /FAIL |
|----------|-------|-------------------------|------------------|---------------------------|----------------------------|---------------------|------------|------------|
| 0        | 36    | 5180                    | 11.55            | -1.36                     | -0.03                      | 11.58               | 13         | PASS       |
|          | 44    | 5220                    | 10.84            | -1.13                     | 0.20                       | 10.64               | 13         | PASS       |
|          | 48    | 5240                    | 11.49            | -0.75                     | 0.58                       | 10.91               | 13         | PASS       |
|          | 52    | 5260                    | 11.54            | 1.76                      | 3.09                       | 8.45                | 13         | PASS       |
|          | 60    | 5300                    | 12.68            | 2.64                      | 3.97                       | 8.71                | 13         | PASS       |
|          | 64    | 5320                    | 12.36            | 2.46                      | 3.79                       | 8.57                | 13         | PASS       |
|          | 100   | 5500                    | 12.97            | 3.05                      | 4.38                       | 8.59                | 13         | PASS       |
|          | 116   | 5580                    | 12.22            | 2.4                       | 3.73                       | 8.49                | 13         | PASS       |
|          | 140   | 5700                    | 12.57            | 2.64                      | 3.97                       | 8.6                 | 13         | PASS       |
| 1        | 36    | 5180                    | 8.95             | -1.83                     | -0.50                      | 9.45                | 13         | PASS       |
|          | 44    | 5220                    | 10.70            | -0.86                     | 0.47                       | 10.23               | 13         | PASS       |
|          | 48    | 5240                    | 9.89             | -1.30                     | 0.03                       | 9.86                | 13         | PASS       |
|          | 52    | 5260                    | 12.17            | 1.82                      | 3.15                       | 9.02                | 13         | PASS       |
|          | 60    | 5300                    | 12.90            | 2.29                      | 3.62                       | 9.28                | 13         | PASS       |
|          | 64    | 5320                    | 13.13            | 2.43                      | 3.76                       | 9.37                | 13         | PASS       |
|          | 100   | 5500                    | 12.31            | 1.57                      | 2.90                       | 9.41                | 13         | PASS       |
|          | 116   | 5580                    | 12.40            | 1.9                       | 3.23                       | 9.17                | 13         | PASS       |
|          | 140   | 5700                    | 12.98            | 2.85                      | 4.18                       | 8.80                | 13         | PASS       |

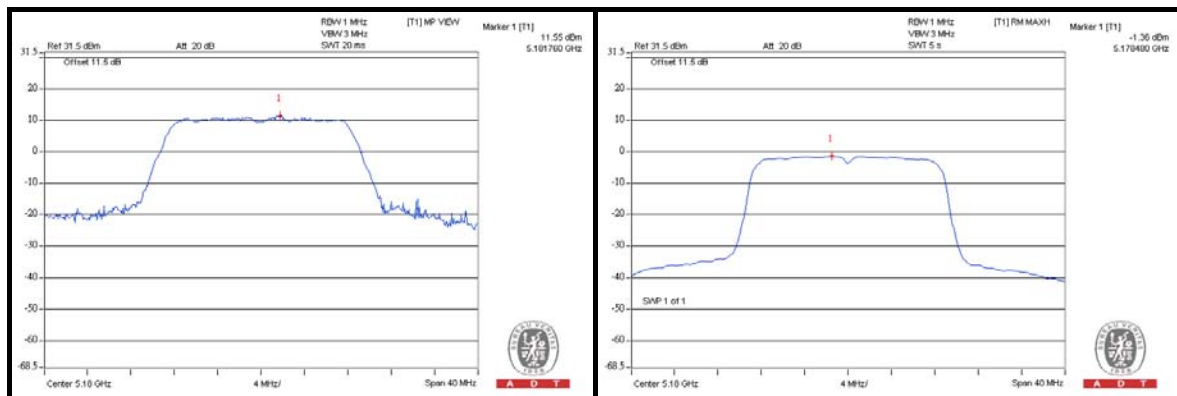



A D T

### 802.11n (40MHz)

#### 1TX

| CHAN. | CHANNEL FREQUENCY (MHz) | PEAK VALUE (dBm) | PSD W/O DUTY FACTOR (dBm) | PSD WITH DUTY FACTOR (dBm) | PEAK EXCURSION (dB) | LIMIT (dB) | PASS /FAIL |
|-------|-------------------------|------------------|---------------------------|----------------------------|---------------------|------------|------------|
| 38    | 5190                    | 4.63             | -5.06                     | -3.82                      | 8.45                | 13         | PASS       |
| 46    | 5230                    | 4.72             | -4.95                     | -3.71                      | 8.43                | 13         | PASS       |
| 54    | 5270                    | 4.82             | -5.00                     | -3.76                      | 8.58                | 13         | PASS       |
| 62    | 5310                    | 4.91             | -4.79                     | -3.55                      | 8.46                | 13         | PASS       |
| 102   | 5510                    | 4.08             | -5.8                      | -4.56                      | 8.64                | 13         | PASS       |
| 110   | 5550                    | 5.23             | -4.56                     | -3.32                      | 8.55                | 13         | PASS       |
| 134   | 5670                    | 6.43             | -3.24                     | -2.00                      | 8.43                | 13         | PASS       |

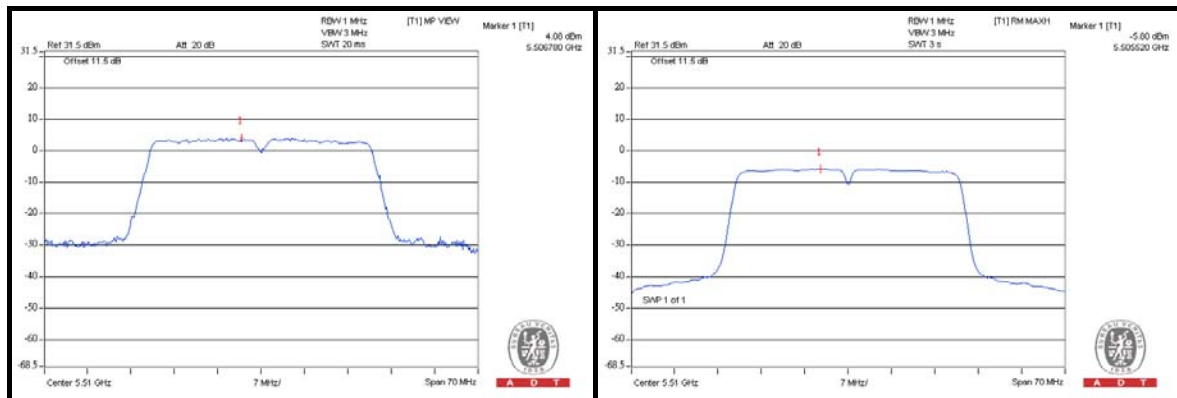



A D T

2TX

| TX chain | CHAN. | CHANNEL FREQUENCY (MHz) | PEAK VALUE (dBm) | PSD W/O DUTY FACTOR (dBm) | PSD WITH DUTY FACTOR (dBm) | PEAK EXCURSION (dB) | LIMIT (dB) | PASS /FAIL |
|----------|-------|-------------------------|------------------|---------------------------|----------------------------|---------------------|------------|------------|
| 0        | 38    | 5190                    | 8.51             | -2.68                     | -0.49                      | 9.00                | 13         | PASS       |
|          | 46    | 5230                    | 8.43             | -2.65                     | -0.46                      | 8.89                | 13         | PASS       |
|          | 54    | 5270                    | 8.94             | -1.90                     | 0.29                       | 8.65                | 13         | PASS       |
|          | 62    | 5310                    | 8.25             | -2.67                     | -0.48                      | 8.73                | 13         | PASS       |
|          | 102   | 5510                    | 9.45             | -1.4                      | 0.79                       | 8.66                | 13         | PASS       |
|          | 110   | 5550                    | 10.63            | -0.33                     | 1.86                       | 8.77                | 13         | PASS       |
|          | 134   | 5670                    | 9.28             | -1.63                     | 0.56                       | 8.72                | 13         | PASS       |
| 1        | 38    | 5190                    | 9.18             | -2.73                     | -0.54                      | 9.72                | 13         | PASS       |
|          | 46    | 5230                    | 8.94             | -2.98                     | -0.79                      | 9.73                | 13         | PASS       |
|          | 54    | 5270                    | 8.67             | -2.62                     | -0.43                      | 9.10                | 13         | PASS       |
|          | 62    | 5310                    | 9.94             | -2.12                     | 0.07                       | 9.87                | 13         | PASS       |
|          | 102   | 5510                    | 9.25             | -2.63                     | -0.44                      | 9.69                | 13         | PASS       |
|          | 110   | 5550                    | 10.52            | -1.49                     | 0.70                       | 9.82                | 13         | PASS       |
|          | 134   | 5670                    | 10.07            | -1.94                     | 0.25                       | 9.82                | 13         | PASS       |

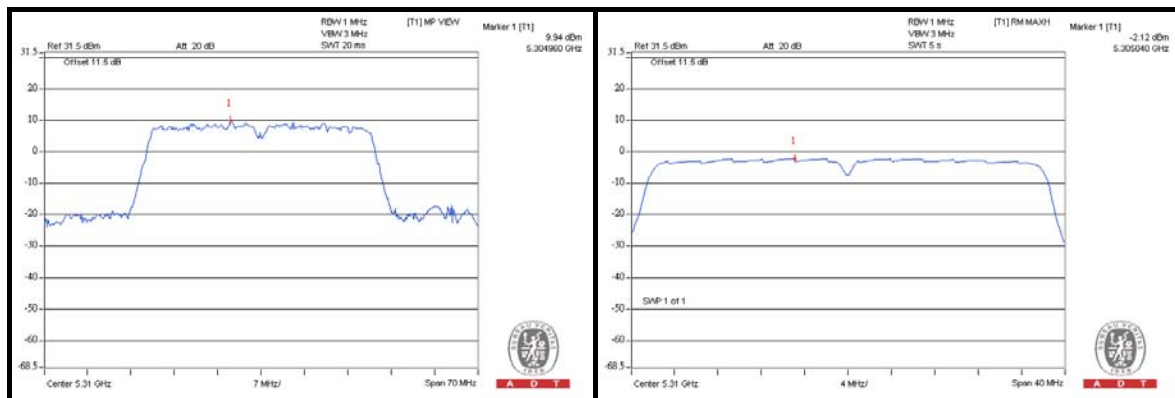

## 4.6 FREQUENCY STABILITY

### 4.6.1 LIMITS OF FREQUENCY STABILITY MEASUREMENT

The frequency of the carrier signal shall be maintained within band of operation

### 4.6.2 TEST SETUP

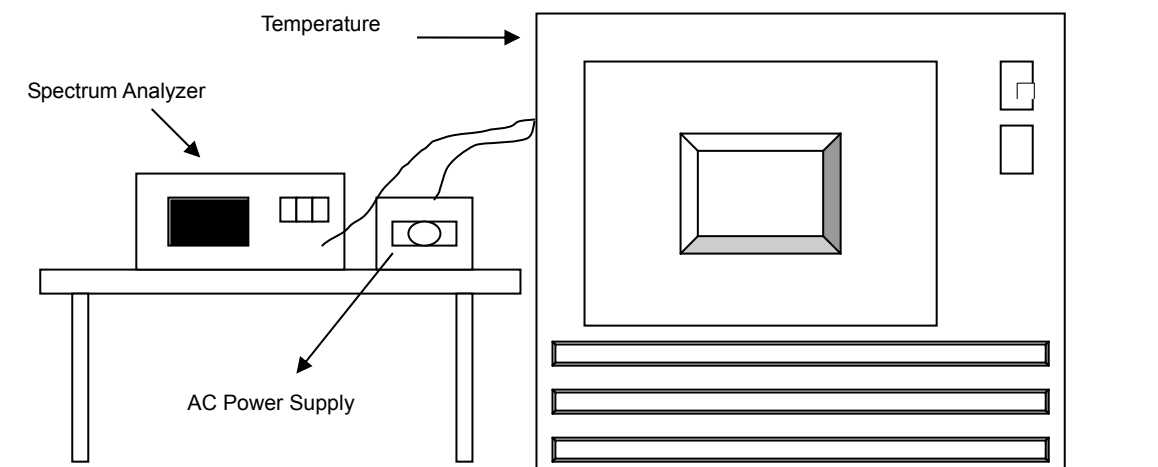

### 4.6.3 TEST INSTRUMENTS

Refer to section 4.1.3 to get information of above instrument.

#### 4.6.4 TEST PROCEDURE

- a. The EUT was placed inside the environmental test chamber and powered by nominal AC voltage.
- b. Turn the EUT on and couple its output to a spectrum analyzer.
- c. Turn the EUT off and set the chamber to the highest temperature specified.
- d. Allow sufficient time (approximately 30 min) for the temperature of the chamber to stabilize, turn the EUT on and measure the operating frequency after 2, 5, and 10 minutes.
- e. Repeat step 2 and 3 with the temperature chamber set to the lowest temperature.
- f. The test chamber was allowed to stabilize at +20 degree C for a minimum of 30 minutes. The supply voltage was then adjusted on the EUT from 85% to 115% and the frequency record.

#### 4.6.5 DEVIATION FROM TEST STANDARD

No deviation.

#### 4.6.6 EUT OPERATING CONDITION

Set the EUT transmit at un-modulation mode to test frequency stability.

#### 4.6.7 TEST RESULTS

| FREQUENCY STABILITY VERSUS TEMP. |                    |                          |                       |                          |                       |                          |                       |                          |                       |
|----------------------------------|--------------------|--------------------------|-----------------------|--------------------------|-----------------------|--------------------------|-----------------------|--------------------------|-----------------------|
| OPERATING FREQUENCY: 5200MHz     |                    |                          |                       |                          |                       |                          |                       |                          |                       |
| TEMP. (°C)                       | POWER SUPPLY (VAC) | 0 MINUTE                 |                       | 2 MINUTE                 |                       | 5 MINUTE                 |                       | 10 MINUTE                |                       |
|                                  |                    | Measured Frequency (MHz) | Frequency Drift (ppm) | Measured Frequency (MHz) | Frequency Drift (ppm) | Measured Frequency (MHz) | Frequency Drift (ppm) | Measured Frequency (MHz) | Frequency Drift (ppm) |
| 55                               | 120.0              | 5200.018879              | 3.631                 | 5200.019243              | 3.701                 | 5200.018955              | 3.645                 | 5200.018939              | 3.642                 |
| 50                               | 120.0              | 5200.018672              | 3.591                 | 5200.019115              | 3.676                 | 5200.018625              | 3.582                 | 5200.018638              | 3.584                 |
| 40                               | 120.0              | 5200.018928              | 3.640                 | 5200.018927              | 3.640                 | 5200.018907              | 3.636                 | 5200.018623              | 3.581                 |
| 30                               | 120.0              | 5200.018745              | 3.605                 | 5200.019191              | 3.691                 | 5200.019142              | 3.681                 | 5200.018425              | 3.543                 |
| 20                               | 120.0              | 5200.018576              | 3.572                 | 5200.019026              | 3.659                 | 5200.018868              | 3.628                 | 5200.018686              | 3.593                 |
| 10                               | 120.0              | 5200.018830              | 3.621                 | 5200.019172              | 3.687                 | 5200.019080              | 3.669                 | 5200.018936              | 3.642                 |
| 0                                | 120.0              | 5200.018729              | 3.602                 | 5200.018709              | 3.598                 | 5200.019148              | 3.682                 | 5200.018543              | 3.566                 |
| -10                              | 120.0              | 5200.018484              | 3.555                 | 5200.018695              | 3.595                 | 5200.018543              | 3.566                 | 5200.018966              | 3.647                 |
| -20                              | 120.0              | 5200.018595              | 3.576                 | 5200.018330              | 3.525                 | 5200.018868              | 3.628                 | 5200.018664              | 3.589                 |

| FREQUENCY STABILITY VERSUS VOLTAGE |                    |                          |                       |                          |                       |                          |                       |                          |                       |
|------------------------------------|--------------------|--------------------------|-----------------------|--------------------------|-----------------------|--------------------------|-----------------------|--------------------------|-----------------------|
| OPERATING FREQUENCY: 5200MHz       |                    |                          |                       |                          |                       |                          |                       |                          |                       |
| TEMP. (°C)                         | POWER SUPPLY (Vac) | 0 MINUTE                 |                       | 2 MINUTE                 |                       | 5 MINUTE                 |                       | 10 MINUTE                |                       |
|                                    |                    | Measured Frequency (MHz) | Frequency Drift (ppm) | Measured Frequency (MHz) | Frequency Drift (ppm) | Measured Frequency (MHz) | Frequency Drift (ppm) | Measured Frequency (MHz) | Frequency Drift (ppm) |
| 20                                 | 102.00             | 5200.020272              | 3.898                 | 5200.020587              | 3.959                 | 5200.020384              | 3.920                 | 5200.020470              | 3.937                 |
|                                    | 120.00             | 5200.018576              | 3.572                 | 5200.018698              | 3.596                 | 5200.018774              | 3.610                 | 5200.018742              | 3.604                 |
|                                    | 138.00             | 5200.022921              | 4.408                 | 5200.022903              | 4.404                 | 5200.023119              | 4.446                 | 5200.023017              | 4.426                 |

## 5. PHOTOGRAPHS OF THE TEST CONFIGURATION

Please refer to the attached file (Test Setup Photo).





## 6. INFORMATION ON THE TESTING LABORATORIES

We, Bureau Veritas Consumer Products Services (H.K.) Ltd., Taoyuan Branch, were founded in 1988 to provide our best service in EMC, Radio, Telecom and Safety consultation. Our laboratories are accredited and approved according to ISO/IEC 17025.

If you have any comments, please feel free to contact us at the following:

**Linko EMC/RF Lab**

Tel: 886-2-26052180

Fax: 886-2-26051924

**Hsin Chu EMC/RF Lab**

Tel: 886-3-5935343

Fax: 886-3-5935342

**Hwa Ya EMC/RF/Safety/Telecom Lab**

Tel: 886-3-3183232

Fax: 886-3-3270892

**Email:** [service.adt@tw.bureauveritas.com](mailto:service.adt@tw.bureauveritas.com)

**Web Site:** [www.bureauveritas-adt.com](http://www.bureauveritas-adt.com)

The address and road map of all our labs can be found in our web site also.

## 7. APPENDIX A - MODIFICATIONS RECORDERS FOR ENGINEERING CHANGES TO THE EUT BY THE LAB

No modifications were made to the EUT by the lab during the test.

---END---