

**FCC 47 CFR PART 15 SUBPART C AND ANSI C63.10:2013
TEST REPORT**

For

RocketGT

Model : S404

Trade Name : GLORIFY

Issued for

Qun-Tong Technology CO., LTD

**No. 223, Wuhe St., Wulong Village, Cyonglin Township,
Hsinchu County 30746, Taiwan**

Issued by

**Compliance Certification Services Inc.
Hsinchu Lab.**

**No.989-1, Wenshan Rd., Shangshan Village,
Qionglin Township, Hsinchu County 30741, Taiwan (R.O.C.)**

TEL: +886-3-5921698

FAX: +886-3-5921108

<http://www.ccsrf.com>

E-Mail : service@ccsrf.com

Issued Date: July 18, 2016



Note: This report shall not be reproduced except in full, without the written approval of Compliance Certification Services Inc. This document may be altered or revised by Compliance Certification Services Inc. personnel only, and shall be noted in the revision section of the document. The client should not use it to claim product endorsement by TAF or any government agencies. The test results of this report relate only to the tested sample identified in this report.

Revision History

Rev.	Issue Date	Revisions	Effect Page	Revised By
00	06/28/2016	Initial Issue	All Page 28	Gloria Chang
01	07/15/2016	Added FCC Designation Number	P.7	Gloria Chang
02	07/18/2016	Revised	P.11	Gloria Chang

TABLE OF CONTENTS

TITLE	PAGE NO.
1. TEST REPORT CERTIFICATION	4
2. EUT DESCRIPTION	5
3. DESCRIPTION OF TEST MODES	6
4. TEST METHODOLOGY	7
5. FACILITIES AND ACCREDITATION	7
5.1 FACILITIES	7
5.2 ACCREDITATIONS.....	7
5.3 MEASUREMENT UNCERTAINTY	8
6. SETUP OF EQUIPMENT UNDER TEST.....	9
7. FCC PART 15.231 REQUIREMENTS.....	10
7.1 20dB BANDWIDTH	10
7.2 LIMIT OF TRANSMISSION TIME	12
7.3 DUTY CYCLE CORRECTION FACTOR.....	14
7.4 RADIATED EMISSION.....	17
7.5 CONDUCTED EMISSION.....	24
APPENDIX SETUP PHOTOS	27

1. TEST REPORT CERTIFICATION

Applicant : Qun-Tong Technology CO., LTD
Address : No. 223, Wuhe St., Wulong Village, Cyonglin Township,
Hsinchu County 30746, Taiwan
Equipment Under Test : RokatGT
Model : S404
Trade Name : GLORIFY
Tested Date : May 05 ~ June 11, 2015

APPLICABLE STANDARD	
Standard	Test Result
FCC Part 15 Subpart C AND ANSI C63.10:2013	PASS

WE HEREBY CERTIFY THAT: The above equipment has been tested by Compliance Certification Services Inc., and found compliance with the requirements set forth in the technical standards mentioned above. The results of testing in this report apply only to the product/system, which was tested. Other similar equipment will not necessarily produce the same results due to production tolerance and measurement uncertainties.

Approved by:



Sb. Lu
Sr. Engineer

Reviewed by:



Gundam Lin
Sr. Engineer

2. EUT DESCRIPTION

Product Name	RocketGT
Model Number	S404
Identify Number	T150505S02
Received Date	May 05, 2015
Frequency Range	433.92 MHz
Transmit Power	71.54 dB μ V/m @ 3m
Channel Number	1 Channel
Type of Modulation	FSK
Antenna Type	Internal Antenna, Antenna Gain -1.13 dBi
Power Rating	3Vdc (From Battery)
Test Voltage	3Vdc

Remark :

1. The sample selected for test was engineering sample that approximated to production product and was provided by manufacturer.
2. For more details, please refer to the User's manual of the EUT.
3. This submittal(s) (test report) is intended for FCC ID:SUG-T3040001 filing to comply with Section 15.207, 15.209 and 15.231 of the FCC Part 15, Subpart C Rules.

3. DESCRIPTION OF TEST MODES

The EUT had been tested under operating condition.

There are one channels have been tested as following :

Channel	Frequency (MHz)
1	433.92

Radiated Emission (Below 1 GHz) Test:

1. The following test modes were scanned during the preliminary test:

No.	Pre-Test Mode
1	TX Mode

2. After the preliminary scan, the following test mode was found to produce the highest emission level.

Final Test Mode		
Emission	Radiated Emission	Mode 1
	Conducted Emission	N/A

Remark : Then, the above highest emission mode of the configuration of the EUT and cable was chosen for all final test items.

Radiated Emission Test (Above 1 GHz) :

Pre-Scan has been conducted to determine the worst-case mode from all possible combinations between available modulations, data rates and antenna ports (if EUT with antenna diversity architecture).

Mode 1

Remark : The field strength of spurious emission was measured in the following position: EUT stand-up position(Z axis), lie-down position(X, Z axis). The worst emission was found in stand-up position(Z axis) and the worst case was recorded.

4. TEST METHODOLOGY

The tests documented in this report were performed in accordance with ANSI C63.10:2013 and FCC CFR 47, 15.207, 15.209 and 15.231.

5. FACILITIES AND ACCREDITATION

5.1 FACILITIES

All measurement facilities used to collect the measurement data are located at

No.989-1, Wenshan Rd., Shangshan Village,
Qionglin Township, Hsinchu County 30741, Taiwan (R.O.C.)

The sites are constructed in conformance with the requirements of ANSI C63.10:2013 and CISPR 22. All receiving equipment conforms to CISPR 16-1-1, CISPR 16-1-2, CISPR 16-1-3, CISPR 16-1-4, CISPR 16-1-5.

5.2 ACCREDITATIONS

Our laboratories are accredited and approved by the following approval agencies according to ISO/IEC 17025.

Taiwan	TAF
---------------	-----

The measuring facility of laboratories has been authorized or registered by the following approval agencies.

Canada	INDUSTRY CANADA
Japan	VCCI
Taiwan	BSMI
USA	FCC MRA

Copies of granted accreditation certificates are available for downloading from our web site, <http://www.ccsrf.com>

Remark: FCC Designation Number TW1027.

5.3 MEASUREMENT UNCERTAINTY

The following table is for the measurement uncertainty, which is calculated as per the document CISPR 16-4-2.

PARAMETER	UNCERTAINTY
Semi Anechoic Chamber (966 Chamber_B) / Radiated Emission, 30 to 1000 MHz	+/- 3.97
Semi Anechoic Chamber (966 Chamber_B) / Radiated Emission, 1 to 18GHz	+/- 3.58
Semi Anechoic Chamber (966 Chamber_B) / Radiated Emission, 18 to 26 GHz	+/- 3.59
Semi Anechoic Chamber (966 Chamber_B) / Radiated Emission, 26 to 40 GHz	+/- 3.81
Conducted Emission (Mains Terminals), 9kHz to 30MHz	+/- 2.48

This uncertainty represents an expanded uncertainty expressed at approximately the 95% confidence level using a coverage factor of k=2.

Consistent with industry standard (e.g. CISPR 22, clause 11, Measurement Uncertainty) determining compliance with the limits shall be base on the results of the compliance measurement. Consequently the measure emissions being less than the maximum allowed emission result in this be a compliant test or passing test.

The acceptable measurement uncertainty value without requiring revision of the compliance statement is base on conducted and radiated emissions being less than U_{CISPR} which is 3.6dB and 5.2dB respectively. CCS values (called U_{Lab} in CISPR 16-4-2) is less than U_{CISPR} as shown in the table above. Therefore, MU need not be considered for compliance.

6. SETUP OF EQUIPMENT UNDER TEST

SUPPORT EQUIPMENT

N/A

SETUP DIAGRAM FOR TESTS

EUT & peripherals setup diagram is shown in appendix setup photos.

EUT OPERATING CONDITION

1. EUT & peripherals setup diagram is shown in appendix setup photos.
2. Power on all equipments.
TX Mode: Frequency: 433.92MHz.
3. All of the functions are under run.
4. Start test.

7. FCC PART 15.231 REQUIREMENTS

7.1 20dB BANDWIDTH

LIMITS

§15.231(c) The bandwidth of the emission shall be no wider than 0.25% of the center frequency for devices operating above 70 MHz and below 900 MHz. For devices operating above 900 MHz, the emission shall be no wider than 0.5% of the center frequency. Bandwidth is determined at the points 20 dB down from the modulated carrier.

TEST EQUIPMENT

Name of Equipment	Manufacturer	Model	Serial Number	Calibration Due
Spectrum Analyzer	Agilent	E4446A	MY43360132	06/04/2016
Test S/W	N/A			

Remark: Each piece of equipment is scheduled for calibration once a year.

TEST SETUP

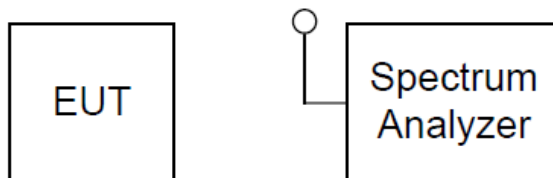

TEST PROCEDURE

The 20dB band width was measured with a spectrum analyzer connected to RF antenna while EUT was operating in transmit mode at the appropriate center frequency. The analyzer center frequency was set to the EUT carrier frequency, using the analyzer. Display Line and Marker Delta functions, the 20dB band width of the emission was determined.

TEST RESULTS

Channel Frequency (MHz)	20dB Bandwidth (kHz)	Limit (kHz)	Result
433.92	285.31	1084.8	PASS

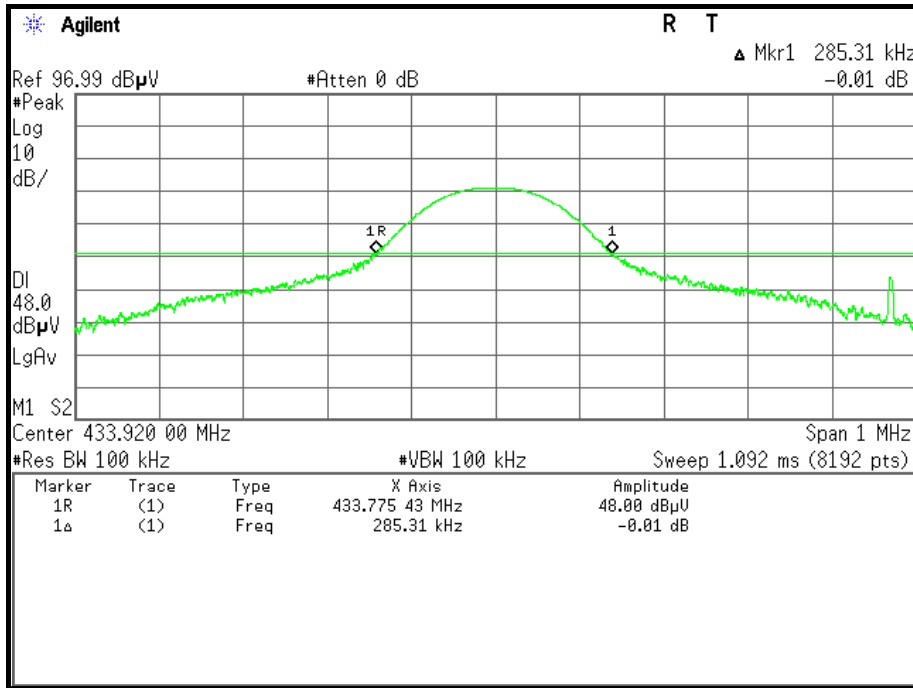

7.2 LIMIT OF TRANSMISSION TIME

LIMITS

§ 15.231(e) In addition, devices operated under the provisions of this paragraph shall be provided with a means for automatically limiting operation so that the duration of each transmission shall not be greater than one second and the silent period between transmissions shall be at least 30 times the duration of the transmission but in no case less than 10 seconds.

TEST EQUIPMENT

Name of Equipment	Manufacturer	Model	Serial Number	Calibration Due
Spectrum Analyzer	Agilent	E4446A	MY43360132	06/04/2016
Test S/W	N/A			

Remark: Each piece of equipment is scheduled for calibration once a year.

TEST SETUP

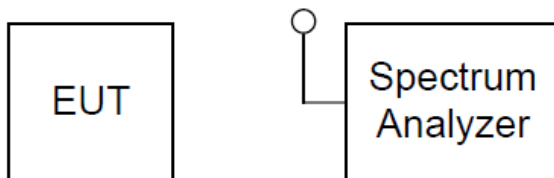

TEST PROCEDURE

The spectrum analyzer connected to RF antenna. The spectrum analyzer center frequency is set to the transmitter frequency. The RBW and VBW are set to 100 kHz.

TEST RESULTS

Channel Frequency (MHz)	Pulse Width (ms)	Number of Pulse	Transmission Time (ms)	Limit (Second)	Result
433.92	13.06	3	39.18	1	PASS

Transmission Time = Pulse Width × Number of Pulse = 13.06 × 3 = 39.18 (ms)

Channel Frequency (MHz)	Silent Period (Second)	30 Times Of The Transmission Time (Times)	Limit (Second)	Result
433.92	30.98	790.70	10	PASS

Times = Silent Period ÷ Transmission Time = 30.98 (s) ÷ 0.03918 (s) = 790.70

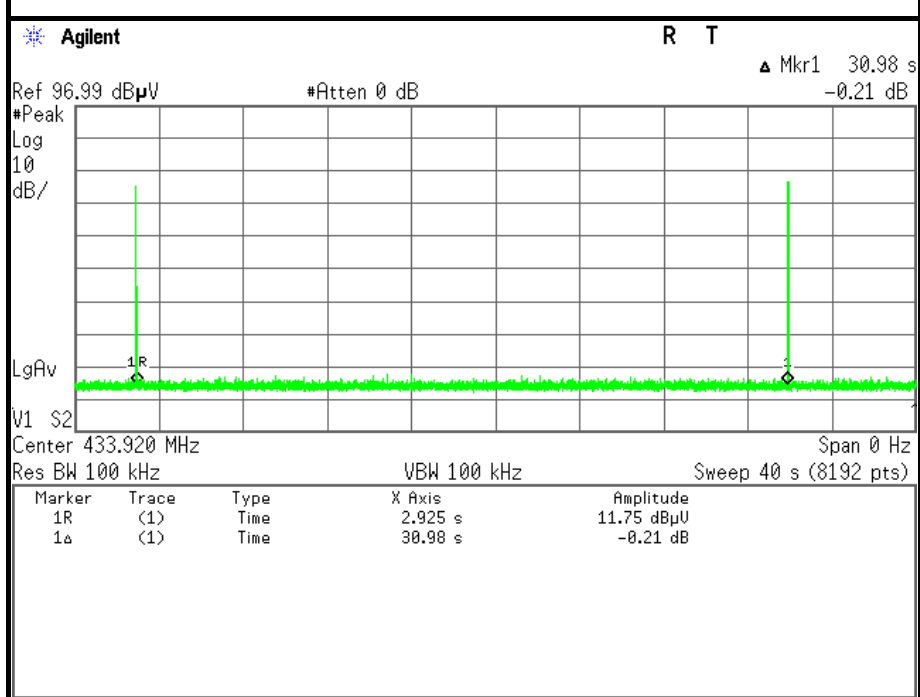
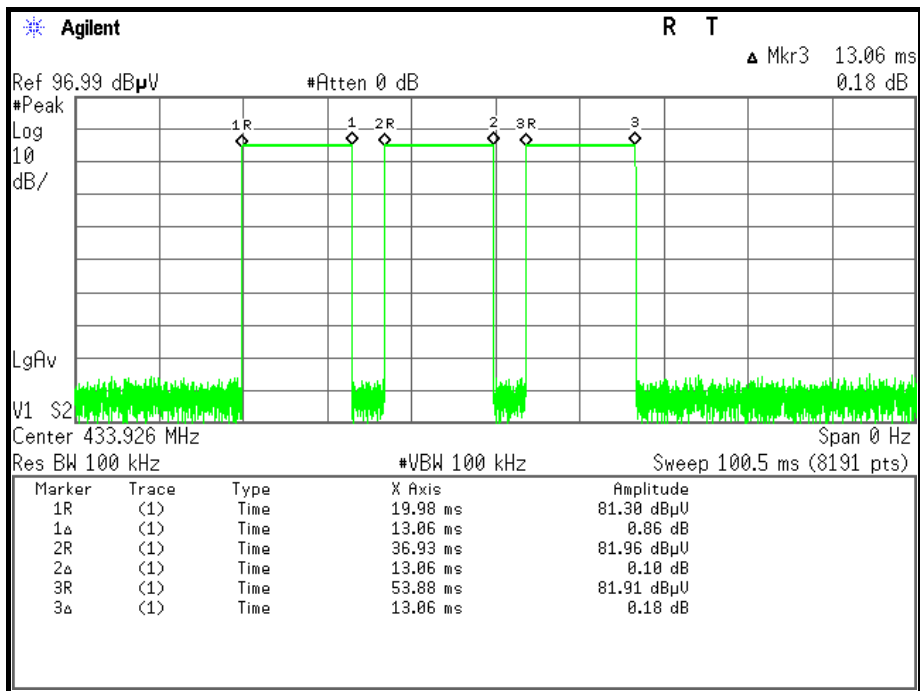

7.3 DUTY CYCLE CORRECTION FACTOR

LIMITS

Nil (No dedicated limit specified in the Rules).

TEST EQUIPMENT

Name of Equipment	Manufacturer	Model	Serial Number	Calibration Due
Spectrum Analyzer	Agilent	E4446A	MY43360132	06/04/2016
Test S/W	N/A			

Remark: Each piece of equipment is scheduled for calibration once a year.

TEST SETUP

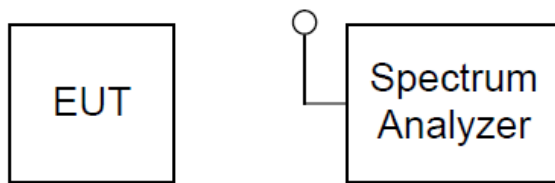

TEST PROCEDURE

1. Place the EUT on the table and set it in transmitting mode.
2. The spectrum analyzer connected to RF antenna.
3. Set center frequency of spectrum analyzer = operating frequency.
4. Set the spectrum analyzer as RBW, VBW=100 kHz, Span = 0Hz.
5. Repeat above procedures until all frequency measured were complete.

TEST RESULTS

$T_p = 100\text{ms}$

$T_{on} = 13.06 \times 3 = 39.18 \text{ (ms)}$

Duty Cycle Correction Factor = $20 \times \log (T_{on} / T_p) = 20 \times \log (39.18/100) = -8.14 \text{ dB}$

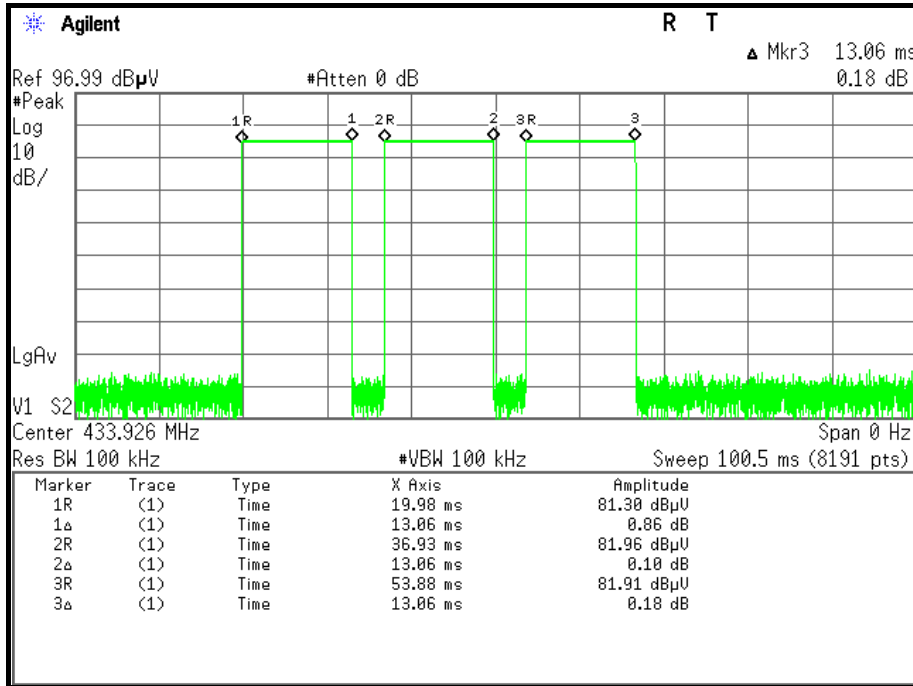

7.4 RADIATED EMISSION

LIMITS

(1) According to § 15.205 (a) Except as shown in paragraph (d) of this section, only spurious emissions are permitted in any of the frequency bands listed below:

MHz	MHz	MHz	GHz
0.090 - 0.110	16.42 - 16.423	399.9 - 410	4.5 - 5.15
¹ 0.495 - 0.505	16.69475 - 16.69525	608 - 614	5.35 - 5.46
2.1735 - 2.1905	16.80425 - 16.80475	960 - 1240	7.25 - 7.75
4.125 - 4.128	25.5 - 25.67	1300 - 1427	8.025 - 8.5
4.17725 - 4.17775	37.5 - 38.25	1435 - 1626.5	9.0 - 9.2
4.20725 - 4.20775	73 - 74.6	1645.5 - 1646.5	9.3 - 9.5
6.215 - 6.218	74.8 - 75.2	1660 - 1710	10.6 - 12.7
6.26775 - 6.26825	108 - 121.94	1718.8 - 1722.2	13.25 - 13.4
6.31175 - 6.31225	123 - 138	2200 - 2300	14.47 - 14.5
8.291 - 8.294	149.9 - 150.05	2310 - 2390	15.35 - 16.2
8.362 - 8.366	156.52475 - 156.52525	2483.5 - 2500	17.7 - 21.4
8.37625 - 8.38675	156.7 - 156.9	2655 - 2900	22.01 - 23.12
8.41425 - 8.41475	162.0125 - 167.17	3260 - 3267	23.6 - 24.0
12.29 - 12.293	167.72 - 173.2	3332 - 3339	31.2 - 31.8
12.51975 - 12.52025	240 - 285	3345.8 - 3338	36.43 - 36.5
12.57675 - 12.57725	322 - 335.4	3600 - 4400	(²)
13.36 - 13.41			

Remark:

1. ¹ Until February 1, 1999, this restricted band shall be 0.490-0.510 MHz.
2. ² Above 38.6

(2) According to § 15.205 (b) Except as provided in paragraphs (d) and (e), the field strength of emissions appearing within these frequency bands shall not exceed the limits shown in Section 15.209. At frequencies equal to or less than 1000 MHz, compliance with the limits in Section 15.209 shall be demonstrated using measurement instrumentation employing a CISPR quasi-peak detector. Above 1000 MHz, compliance with the emission limits in Section 15.209 shall be demonstrated based on the average value of the measured emissions. The provisions in Section 15.35 apply to these measurements.

(3) According to §15.231(b), In addition to the provisions of Section 15.205, the field strength of emissions from intentional radiators operated under this Section shall not exceed the following:

Fundamental Frequency (MHz)	Field Strength of Fundamental (microvolts/meter)	Field Strength of Spurious Emissions (microvolts/meter)
40.66 – 40.70	1000	100
70 – 130	500	50
130 – 174	500 to 1500 **	50 to 150 **
174 – 260	1500	150
260 – 470	1500 to 5000 **	150 to 500 **
Above 470	5000	500

Remark: ** linear interpolations

(4) According to § 15.209 (a) Except as provided elsewhere in this Subpart, the emissions from an intentional radiator shall not exceed the field strength levels specified in the following table :

Frequency (MHz)	Field Strength (microvolts/meter)	Measurement Distance (meters)
0.009 – 0.490	2400/F(KHz)	300
0.490 – 1.705	24000/F(KHz)	30
1.705 – 30.0	30	30
30 - 88	100 **	3
88 - 216	150 **	3
216 - 960	200 **	3
Above 960	500	3

Remark: **Except as provided in paragraph (g), fundamental emissions from intentional radiators operating under this Section shall not be located in the frequency bands 54-72 MHz, 76-88 MHz, 174-216 MHz or 470-806 MHz. However, operation within these frequency bands is permitted under other sections of this Part, e.g., Sections 15.231 and 15.241.

(5) According to § 15.209 (b) In the emission table above, the tighter limit applies at the band edges.

TEST EQUIPMENT

Radiated Emission / 966Chamber B

Name of Equipment	Manufacturer	Model	Serial Number	Calibration Due
Spectrum Analyzer	Agilent	E4446A	MY46180323	04/14/2016
EMI Test Receiver	Rohde & Schwarz	ESCS 30	835418/008	10/14/2015
Broad-Band Horn Antenna	Schwarzbeck	BBHA 9120 D	9120D-285	04/19/2016
Bi-log Antenna	Schwarzbeck	VULB 9168	9168-250	08/21/2015
Double-Ridged Waveguide Horn	ETS-LINDGREN	3117	00078733	12/02/2015
Horn Antenna	COM-POWER	AH-840	03077	12/17/2015
Pre-Amplifier	Agilent	8447D	2944A10052	07/15/2015
Pre-Amplifier	Agilent	8449B	3008A01916	07/15/2015
LOOP Antenna	EMCO	6502	8905-2356	09/23/2015
Test S/W	E3.815206a			

Remark: Each piece of equipment is scheduled for calibration once a year.

TEST SETUP

The diagram below shows the test setup that is utilized to make the measurements for emission from below 1GHz.

9kHz ~ 30MHz

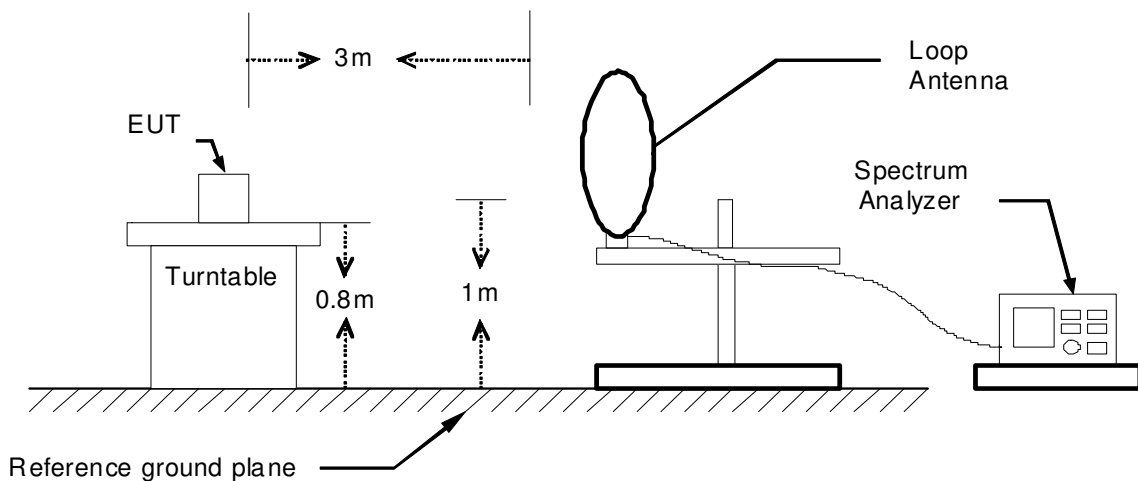

30MHz ~ 1GHz

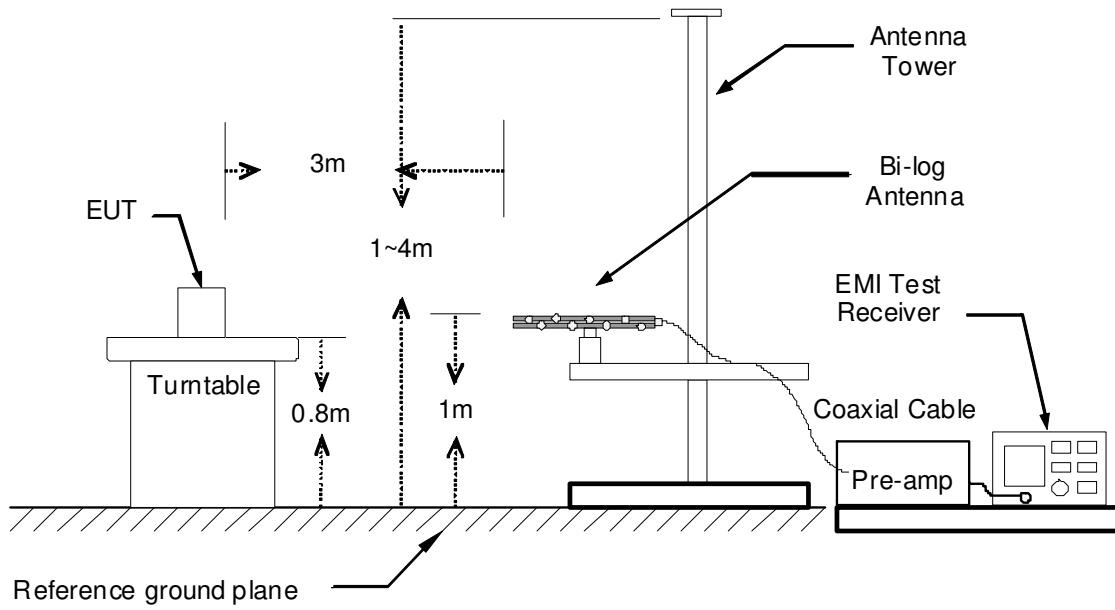

The diagram below shows the test setup that is utilized to make the measurements for emission above 1GHz.

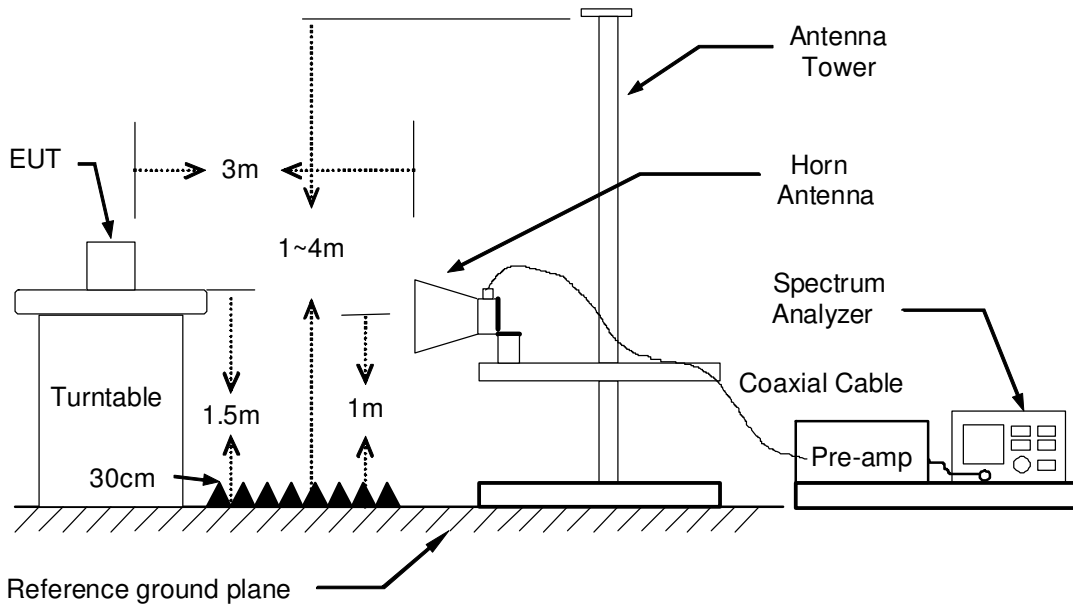

TEST PROCEDURE

1. The EUT was placed on the top of a rotating table 0.8 and 1.5 meters above the ground. The table was rotated 360 degrees to determine the position of the highest radiation.
2. While measuring the radiated emission below 1GHz, the EUT was set 3 meters away from the interference-receiving antenna, which was mounted on the top of a variable-height antenna tower. While measuring the radiated emission above 1GHz, the EUT was set 3 meters away from the interference-receiving antenna.
3. The antenna is a broadband antenna, and its height is varied from one meter to four meters above the ground to determine the maximum value of the field strength. Both horizontal and vertical polarization of the antenna are set to make the measurement.
4. For each suspected emission, the EUT was arranged to its worst case and then the antenna was tuned to heights from 1 meter to 4 meters and the table was turned from 0 degrees to 360 degrees to find the maximum reading.
5. The test-receiver system was set to Peak Detect Function and Specified Bandwidth with Maximum Hold Mode.
6. If the emission level of the EUT in peak mode was 10 dB lower than the limit specified, then testing could be stopped and the peak values of the EUT would be reported. Otherwise the emissions that did not have 10 dB margin would be re-tested one by one using peak, quasi-peak or average method as specified and then reported in a data sheet.

Remark :

1. *The resolution bandwidth and video bandwidth of test receiver/spectrum analyzer is 120 KHz for Peak detection (PK) and Quasi-peak detection (QP) at frequency below 1GHz.*
2. *The resolution bandwidth and video bandwidth of test receiver/spectrum analyzer is 1 MHz for Peak detection and frequency above 1GHz.*
3. *The resolution bandwidth of test receiver/spectrum analyzer is 1 MHz and the video bandwidth is 10 Hz for Average detection (AV) at frequency above 1GHz.*

TEST RESULTS

Below 1 GHz (9kHz ~ 30MHz)

No emission found between lowest internal used/generated frequency to 30MHz.

Below 1 GHz (30MHz ~ 1GHz)

Product Name	RoketGT	Test By	Audi Chang
Test Model	S404	Test Date	2015/05/07
Test Mode	Mode 1	Temp. & Humidity	26°C, 56%

966 Chamber_B at 3Meter / Horizontal								
Frequency (MHz)	Reading (dBµV)	Correction Factor (dB/m)	Result (dBµV/m)	Duty Cycle Correction Factor	Result (AVG/QP)	Limit (AVG/QP) (dBµV/m)	Margin (dB)	Remark
*433.92	77.92	-9.32	68.60	-8.14	60.46	72.86	-12.40	AVG
293.84	31.57	-12.00	19.57		19.57	46.00	-26.43	Peak
375.32	35.78	-10.48	25.30		25.30	46.00	-20.70	Peak
395.69	35.48	-10.07	25.42		25.42	46.00	-20.58	Peak
710.94	28.83	-4.82	24.01		24.01	46.00	-21.99	Peak
*868.08	44.79	-2.05	42.74	-8.14	34.06	46.00	-11.40	AVG

966 Chamber_B at 3Meter / Vertical								
Frequency (MHz)	Reading (dBµV)	Correction Factor (dB/m)	Result (dBµV/m)	Duty Cycle Correction Factor	Result (AVG/QP)	Limit (AVG/QP) (dBµV/m)	Margin (dB)	Remark
*433.92	80.86	-9.32	71.54	-8.14	63.40	72.86	-9.46	AVG
371.44	36.89	-10.56	26.33		26.33	46.00	-19.67	Peak
392.78	36.47	-10.13	26.35		26.35	46.00	-19.65	Peak
457.77	40.06	-8.91	31.15		31.15	46.00	-14.85	Peak
754.59	32.10	-3.69	28.40		28.40	46.00	-17.60	Peak
*868.08	49.51	-2.05	47.46	-8.14	39.32	46.00	-6.68	AVG

Remark:

1. Quasi-peak test would be performed if the peak result were greater than the quasi-peak limit.
2. Data of measurement within this frequency range shown " --- " in the table above means the reading of emissions are attenuated more than 20dB below the permissible limits or the field strength is too small to be measured.
3. Correction Factor (dB/m) = Antenna Factor (dB/m) + Cable Loss (dB) – PreAmp.Gain (dB).
4. Result (dBµV/m) = Reading (dBµV) + Correction Factor (dB/m).
5. Margin (dB) = Remark result (dBµV/m) - limit (dBµV/m).
6. (*) For Fundamental & Harmonics: Result(AVG) = Result(PK) + Duty Cycle Correction Factor.

Above 1 GHz

Product Name	RoketGT	Test By	Audi Chang
Test Model	S404	Test Date	2015/05/07
Test Mode	Mode 1	Temp. & Humidity	26°C, 56%

966 Chamber_B at 3Meter / Horizontal										
Frequency (MHz)	Reading-PK (dBuV)	Reading-AV (dBuV)	Correction Factor (dB/m)	Duty Cycle Correction Factor (dB)	Result-PK (dBuV/m)	Result-AV (dBuV/m)	Limit-PK (dBuV/m)	Limit-AV (dBuV/m)	Margin (dB)	Remark
1220.00	44.92	---	-3.16		41.76	---	74.00	54.00	-12.24	Peak
1995.00	42.61	---	1.73		44.35	---	74.00	54.00	-9.65	Peak
2545.00	43.41	---	3.10		46.51	---	74.00	54.00	-7.49	Peak
3040.00	42.77	---	4.11		46.88	---	74.00	54.00	-7.12	Peak
3935.00	41.83	---	5.85		47.68	---	74.00	54.00	-6.32	Peak
4575.00	41.10	---	7.80		48.90	---	74.00	54.00	-5.10	Peak

966 Chamber_B at 3Meter / Vertical										
Frequency (MHz)	Reading-PK (dBuV)	Reading-AV (dBuV)	Correction Factor (dB/m)	Duty Cycle Correction Factor (dB)	Result-PK (dBuV/m)	Result-AV (dBuV/m)	Limit-PK (dBuV/m)	Limit-AV (dBuV/m)	Margin (dB)	Remark
1455.00	43.81	---	-2.91		40.91	---	74.00	54.00	-13.09	Peak
1965.00	43.43	---	1.46		44.88	---	74.00	54.00	-9.12	Peak
2605.00	42.99	---	3.22		46.21	---	74.00	54.00	-7.79	Peak
3040.00	46.70	---	4.11		50.81	---	74.00	54.00	-3.19	Peak
3890.00	42.09	---	5.76		47.85	---	74.00	54.00	-6.15	Peak
4725.00	41.35	---	7.92		49.27	---	74.00	54.00	-4.73	Peak

Remark:

1. Measuring frequencies from 1 GHz to the 10th harmonic of highest fundamental frequency.
2. Average test would be performed if the peak result were greater than the average limit.
3. Data of measurement within this frequency range shown " --- " in the table above means the reading of emissions are attenuated more than 20dB below the permissible limits or the field strength is too small to be measured.
4. Measurements above show only up to 6 maximum emissions noted, or would be lesser, with " N/A " remark, if no specific emissions from the EUT are recorded (ie: margin>20dB from the applicable limit) and considered that's already beyond the background noise floor.
5. Result = Reading + Correction Factor
Margin = Result - Limit
Remark Peak = Result(PK) - Limit(AV)
Remark AVG = Result(AV) - Limit(AV)
6. " * " For Fundamental & Harmonics: Result-AV = Result(PK) + Duty Cycle Correction Factor

7.5 CONDUCTED EMISSION

LIMITS

§ 15.207 (a) Except as shown in paragraph (b) and (c) this section, for an intentional radiator that is designed to be connected to the public utility (AC) power line, the radio frequency voltage that is conducted back onto the AC power line on any frequency or frequencies within the band 150 kHz to 30 MHz shall not exceed the limits in the following table, as measured using a 50 μ H/50 ohms line impedance stabilization network (LISN). Compliance with the provisions of this paragraph shall be based on the measurement of the radio frequency voltage between each power line and ground at the power terminal. The lower limit applies at the boundary between the frequency ranges.

Frequency Range (MHz)	Conducted Limit (dB μ v)	
	Quasi-peak	Average
0.15 - 0.50	66 to 56	56 to 46
0.50 - 5.00	56	46
5.00 - 30.0	60	50

TEST EQUIPMENT

Name of Equipment	Manufacturer	Model	Serial Number	Calibration Due
L.I.S.N	Schwarzbeck	NSLK 8127	8127-465	08/06/2015
L.I.S.N	Schwarzbeck	NSLK 8127	8127-473	03/09/2016
EMI Test Receiver	Rohde & Schwarz	ESHS 30	838550/003	11/02/2015
Pulse Limiter	Rohde & Schwarz	ESH3-Z2	100111	06/30/2015
Test S/W	E3.815206a			

Remark: Each piece of equipment is scheduled for calibration once a year.

TEST SETUP

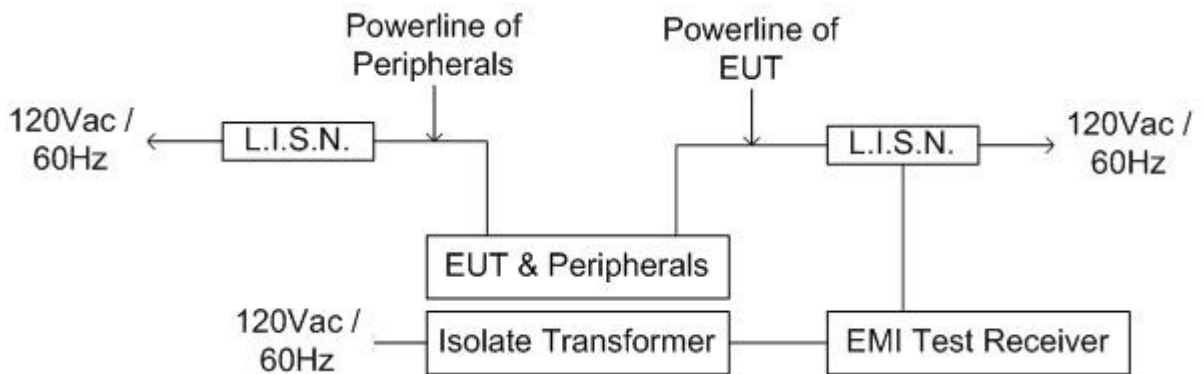
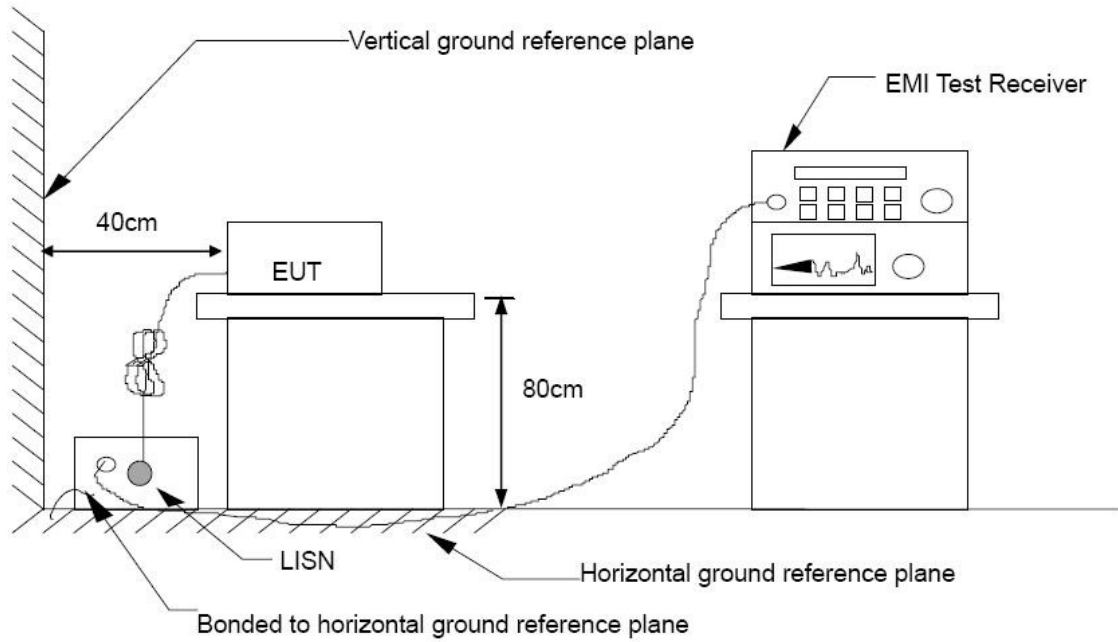

TEST PROCEDURE

The basic test procedure was in accordance with ANSI C63.10:2013.

The test procedure is performed in a 4m × 3m × 2.4m (L×W×H) shielded room.

The EUT along with its peripherals were placed on a 1.0m (W) × 1.5m (L) and 0.8m in height wooden table and the EUT was adjusted to maintain a 0.4 meter space from a vertical reference plane.

The EUT was connected to power mains through a line impedance stabilization network (LISN) which provides 50 ohm coupling impedance for measuring instrument and the chassis ground was bounded to the horizontal ground plane of shielded room. All peripherals were connected to the second LISN and the chassis ground also bounded to the horizontal ground plane of shielded room.

The EUT was located so that the distance between the boundary of the EUT and the closest surface of the LISN is 0.8 m. Where a mains flexible cord was provided by the manufacturer shall be 1 m long, or if in excess of 1 m, the excess cable was folded back and forth as far as possible so as to form a bundle not exceeding 0.4 m in length.

TEST RESULTS

Since the EUT is powered by DC source from battery, this test item is not applicable.