

8DPSK Channel- L

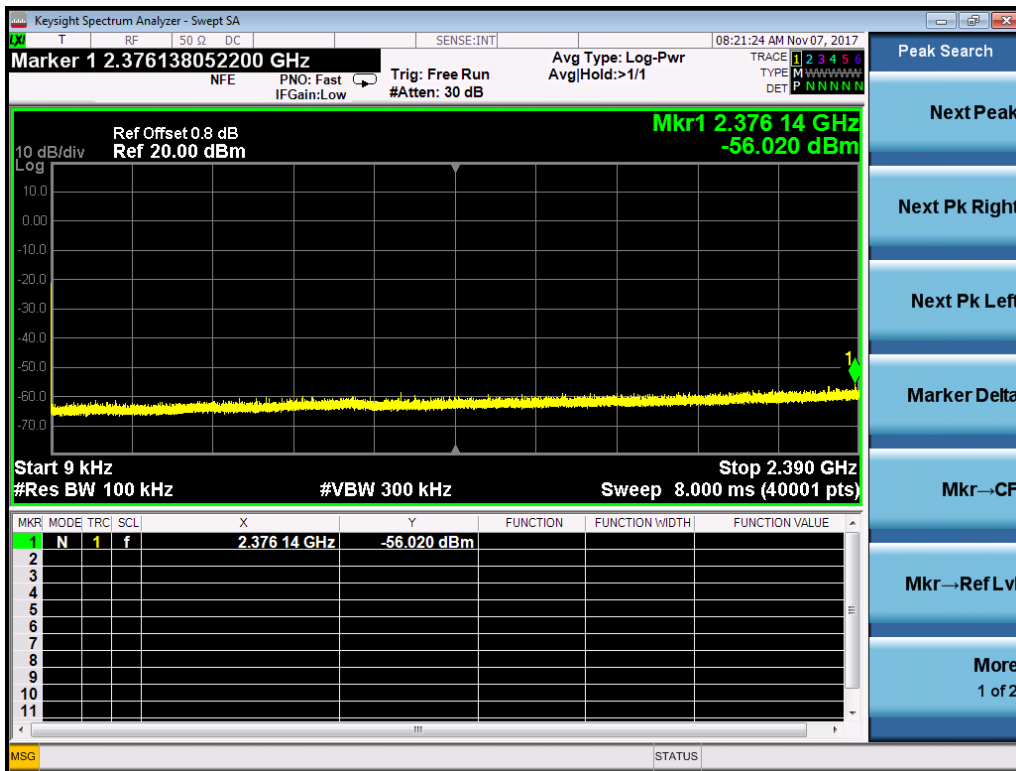

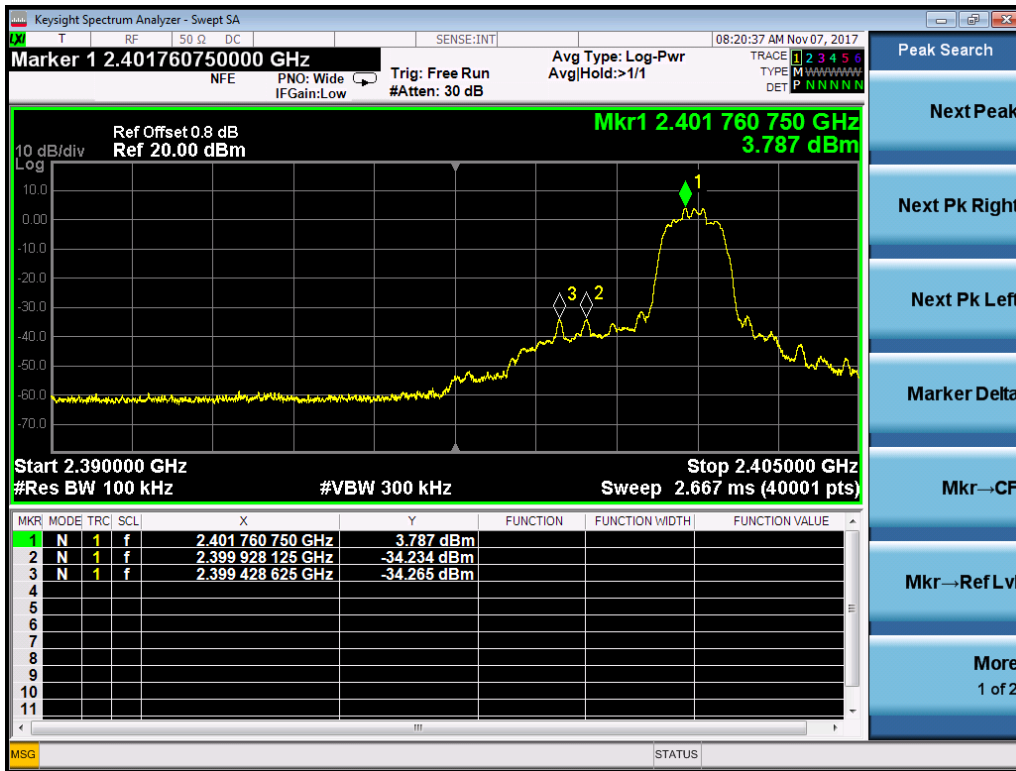

8DPSK Channel- M

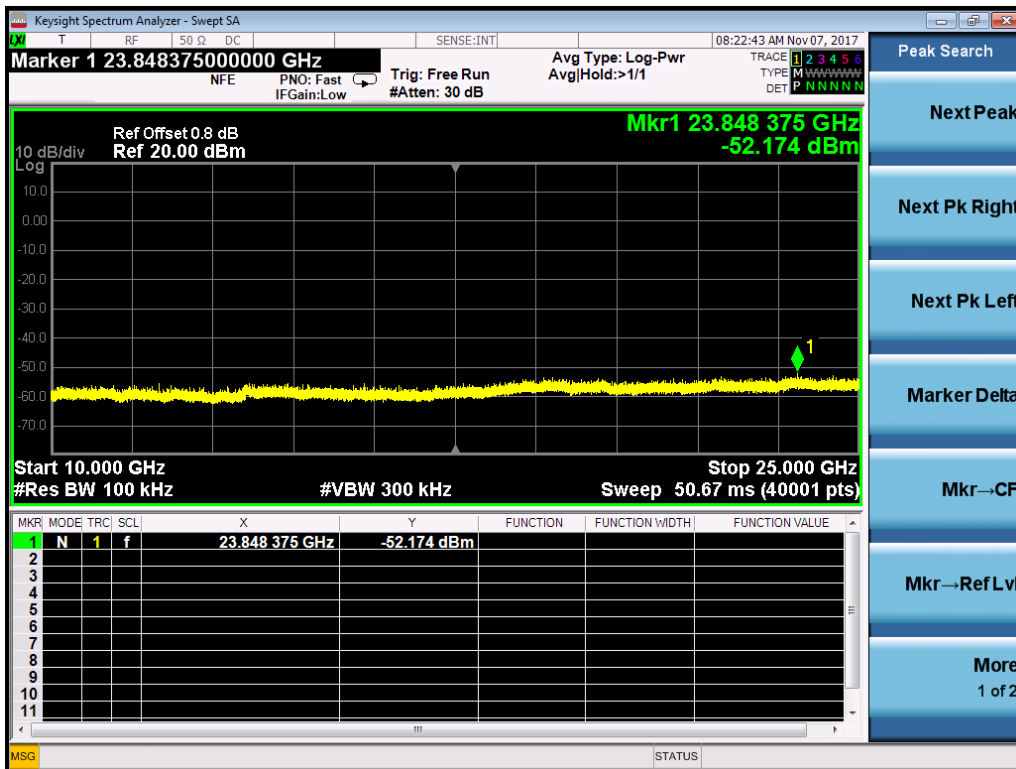
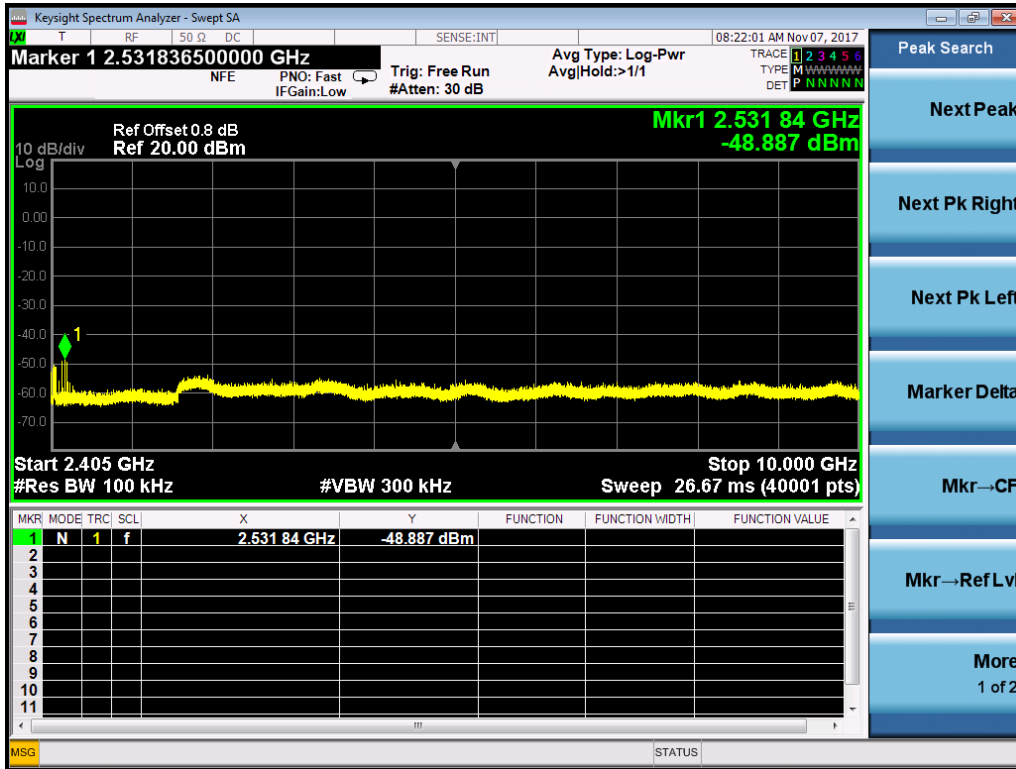
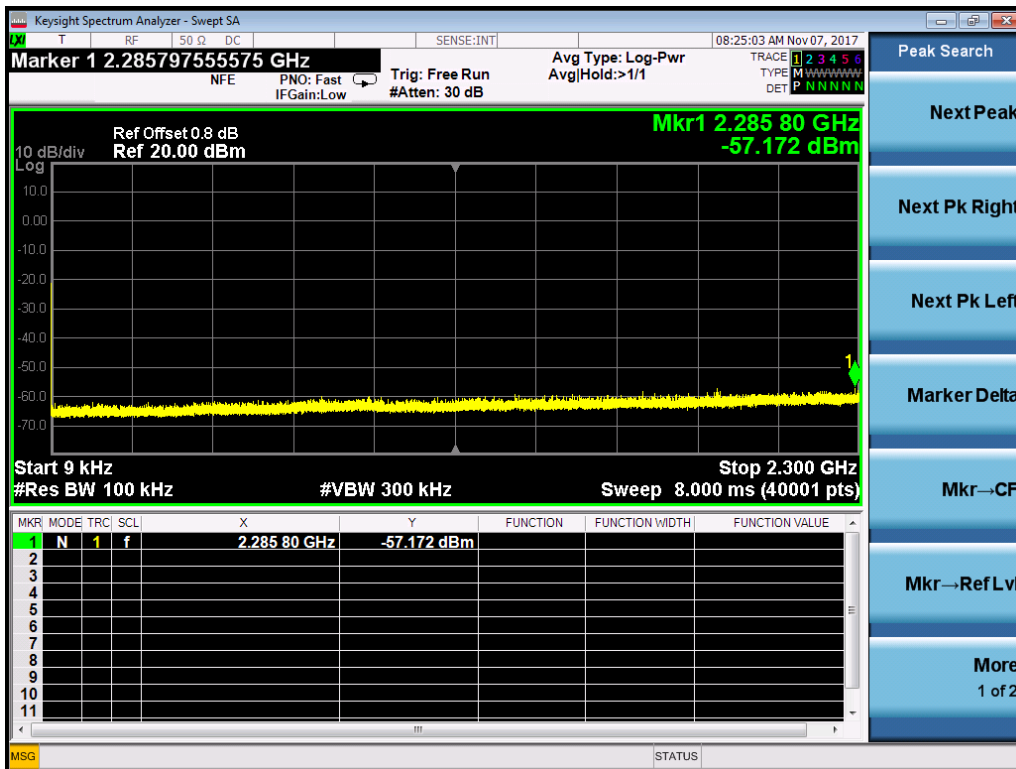
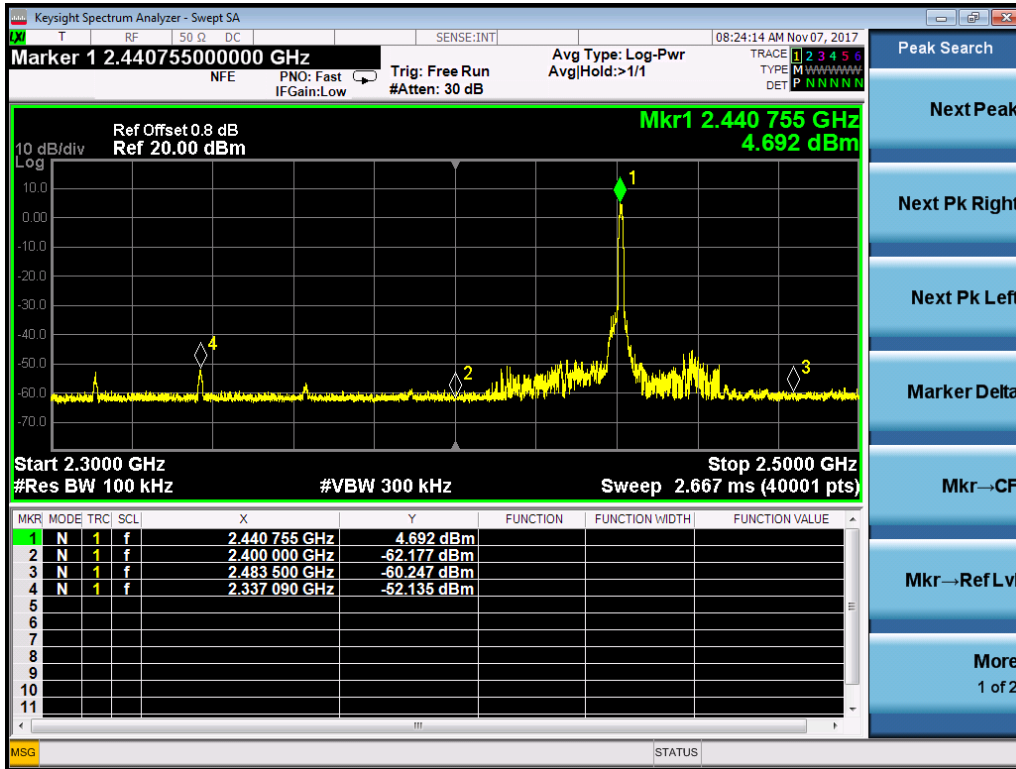

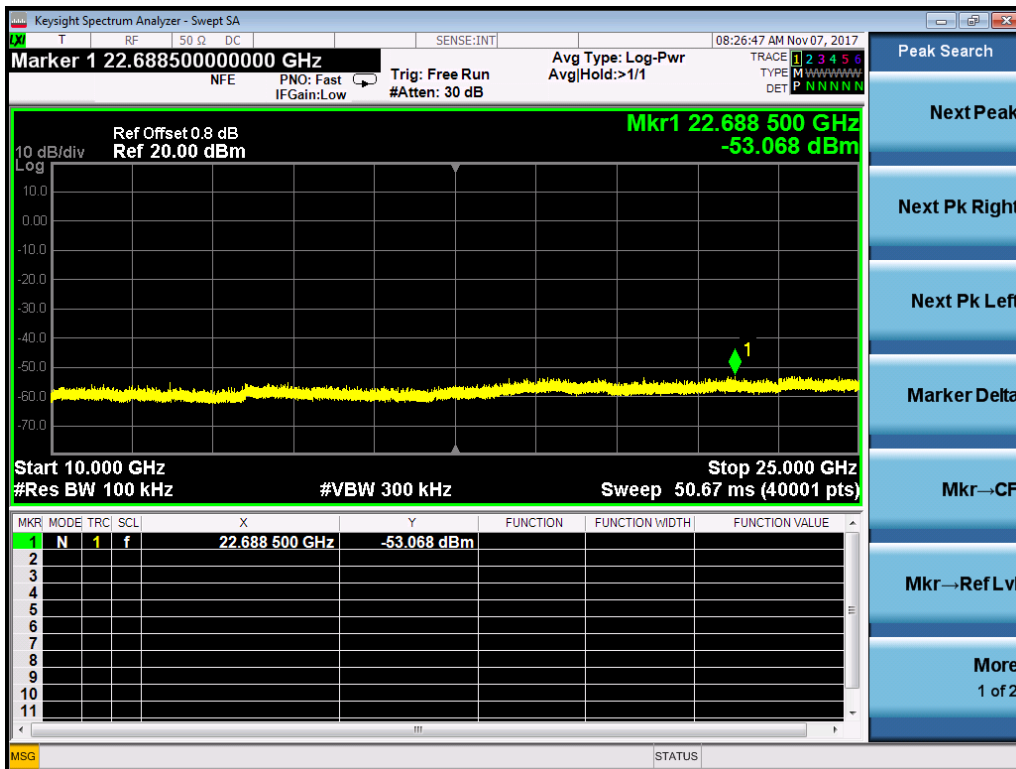
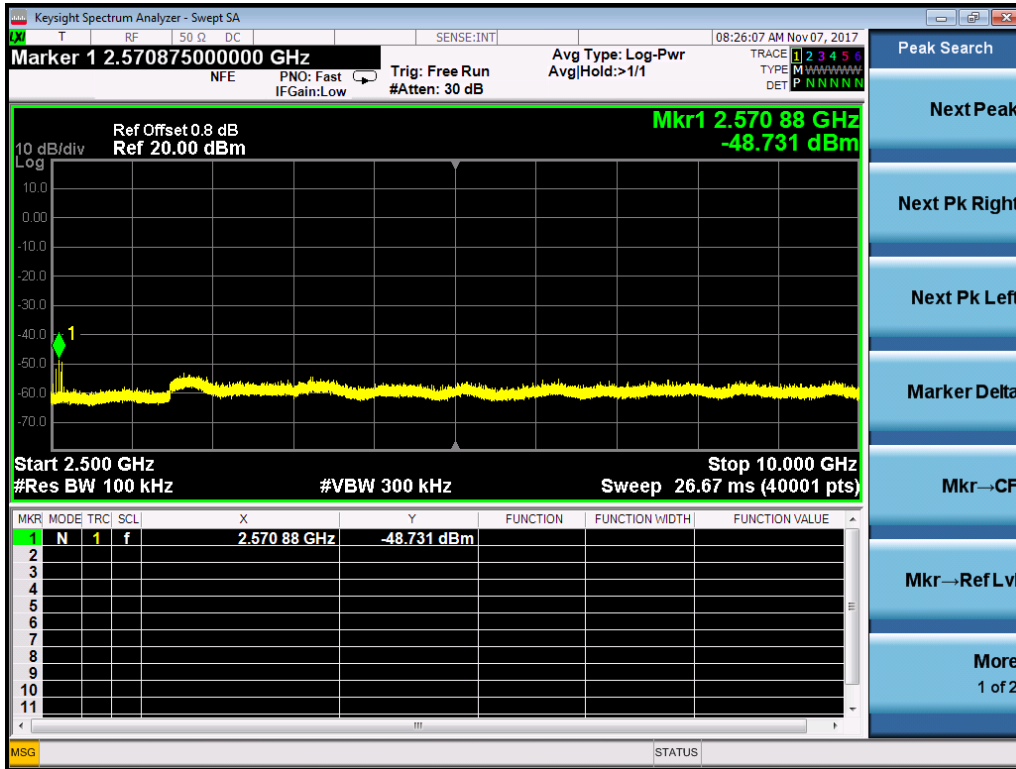

8DPSK Channel- H

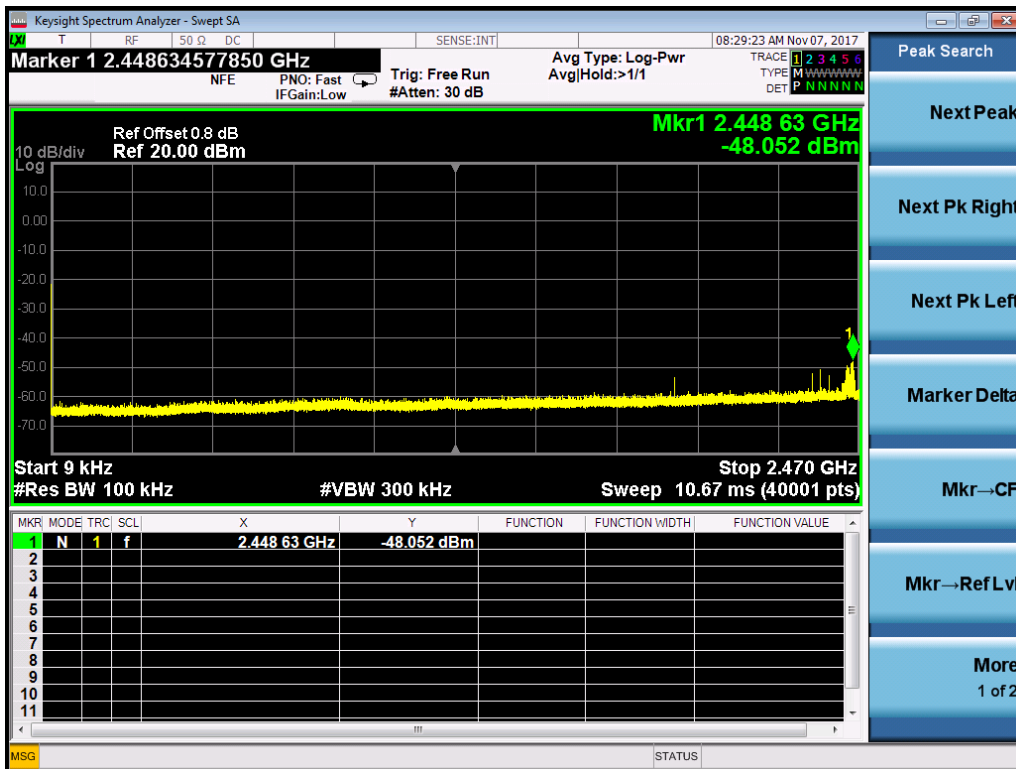
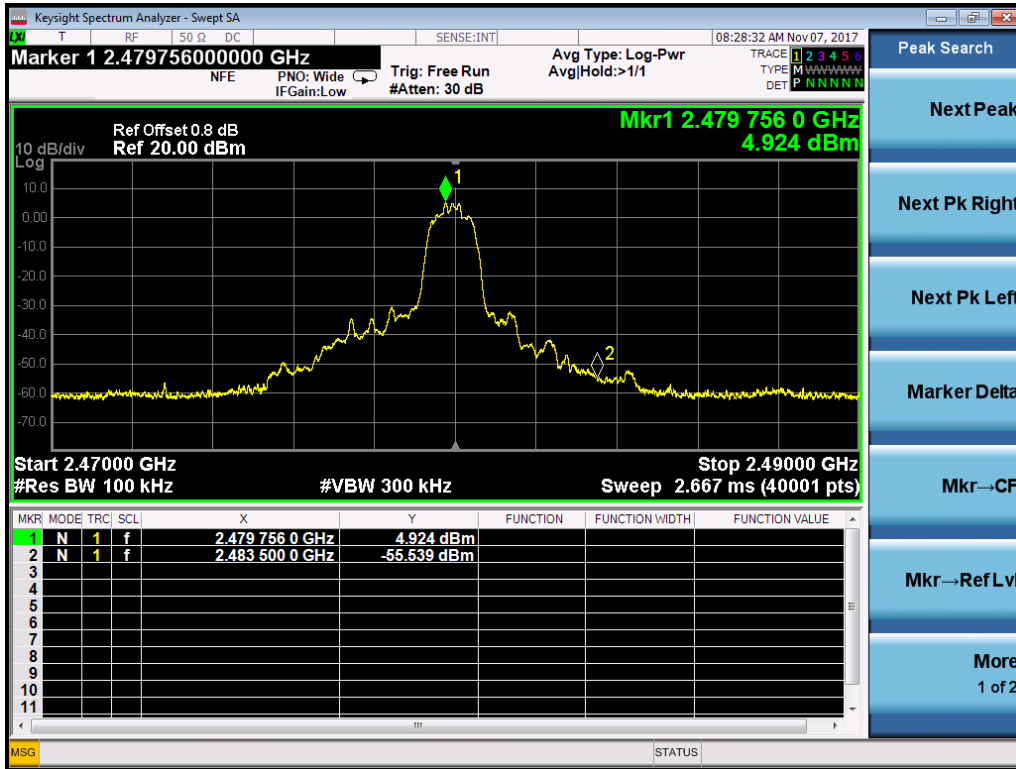

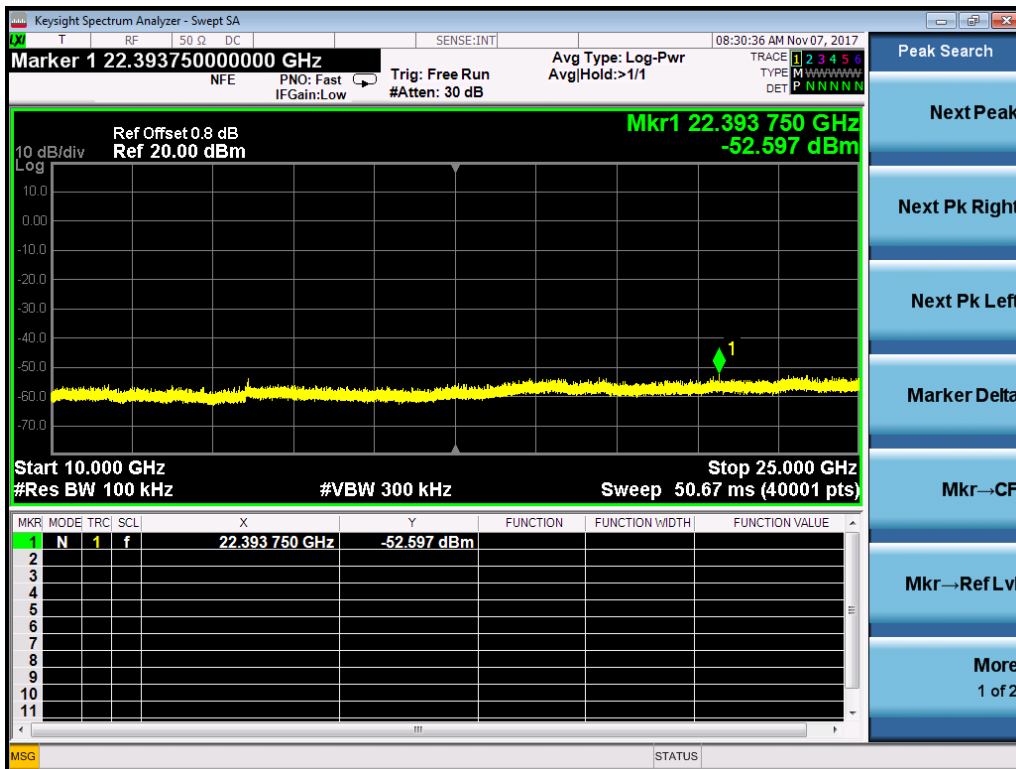
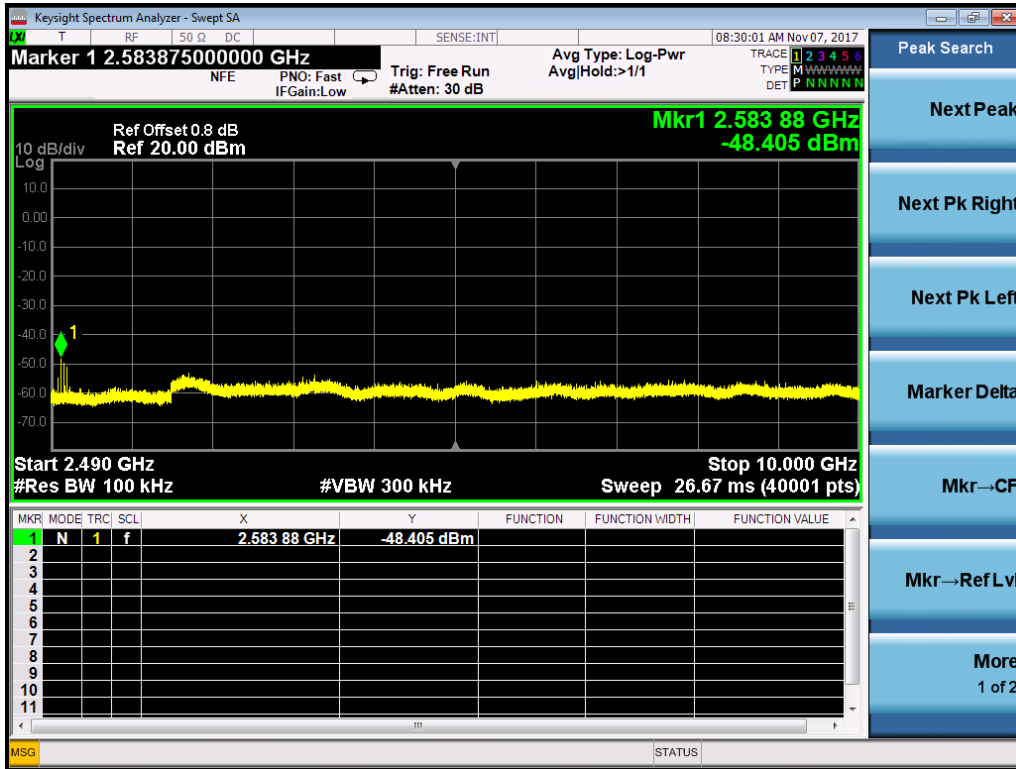

Hopping-GFSK

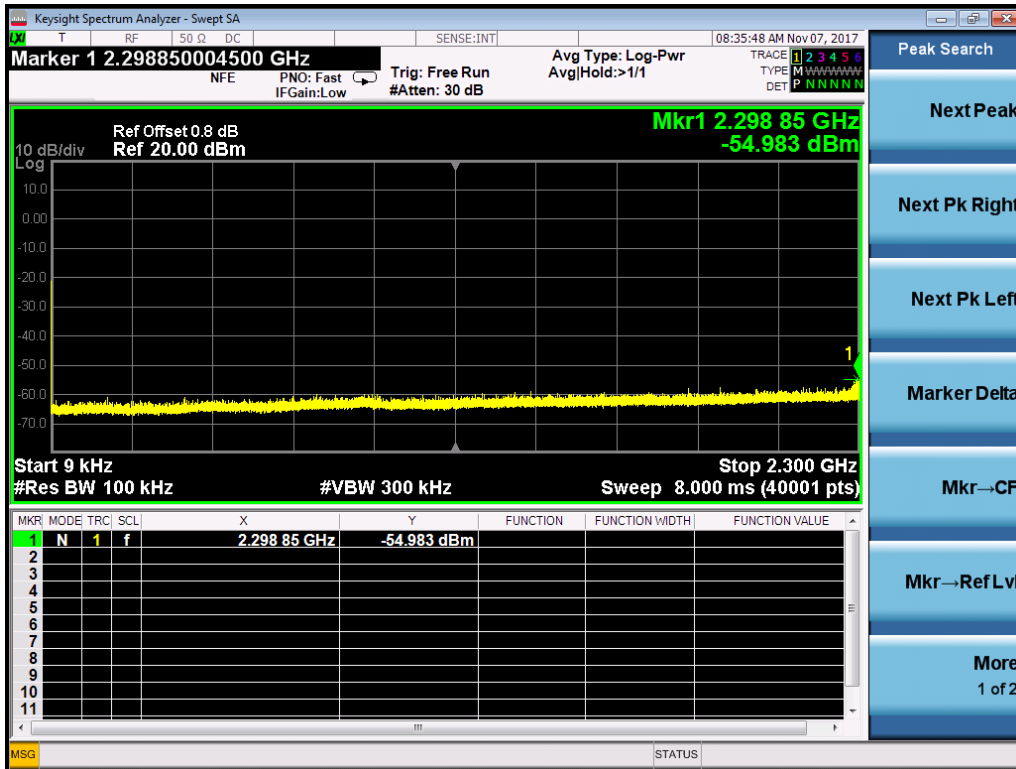
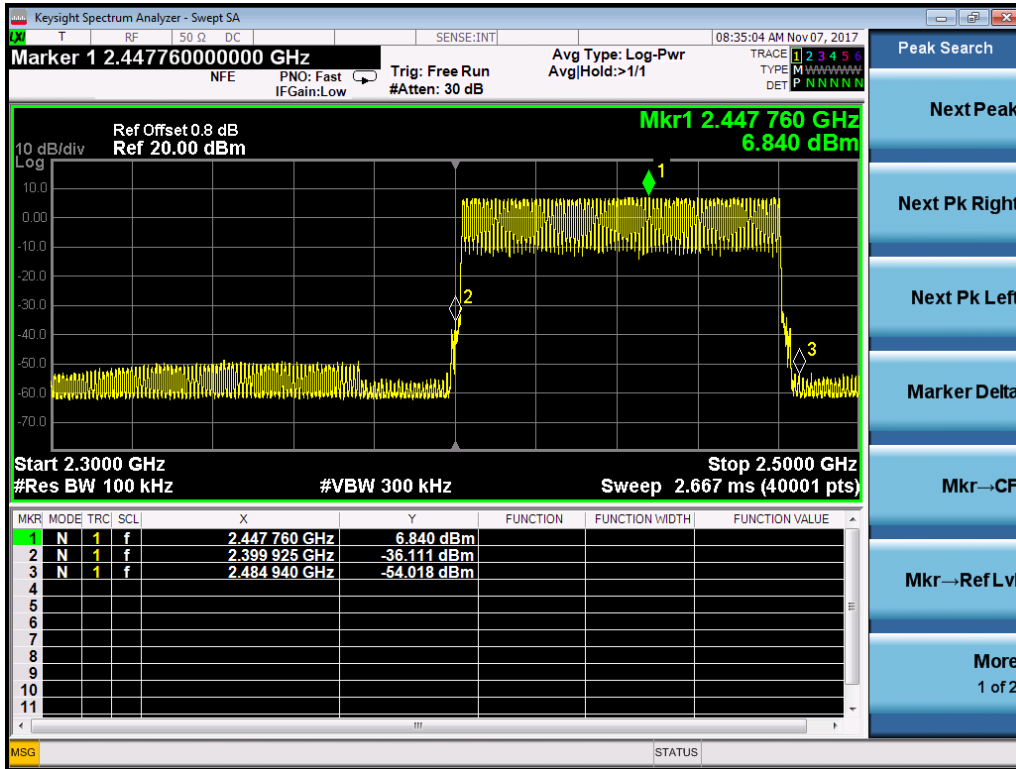



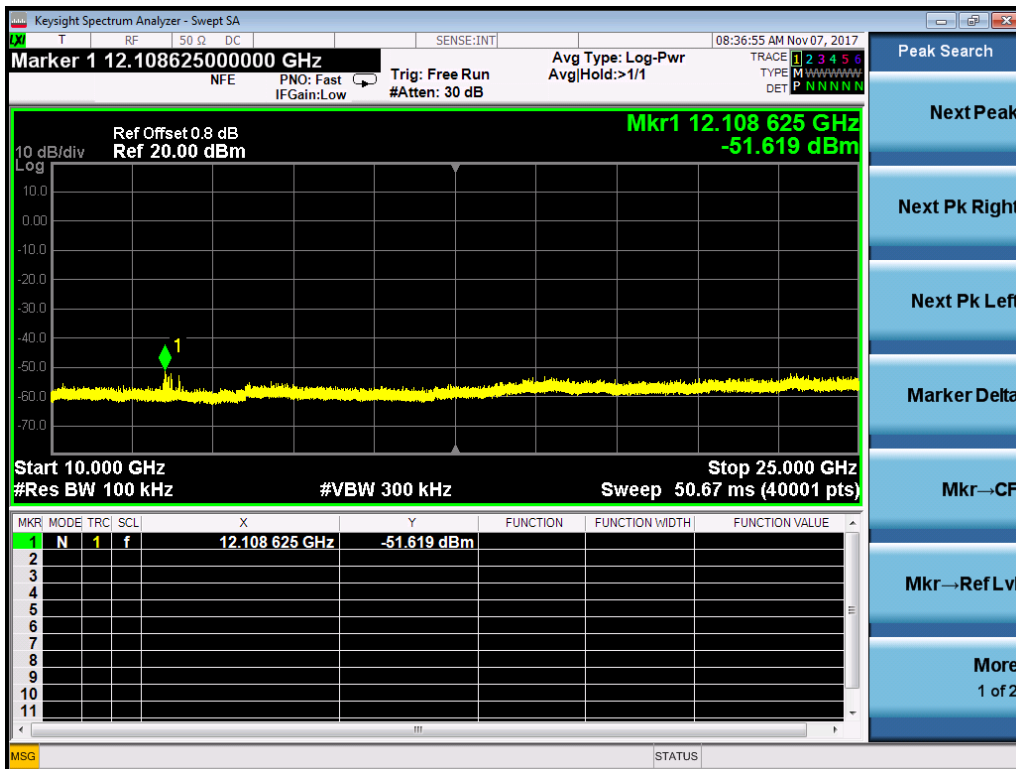
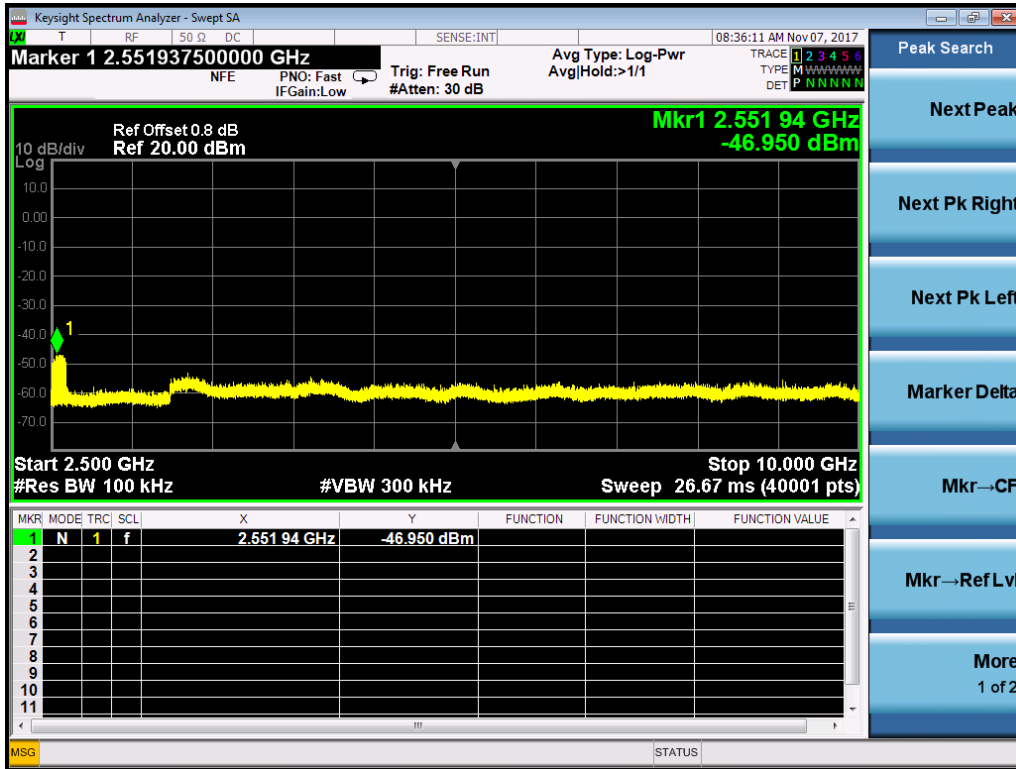

Hopping- $\pi/4$  DQPSK

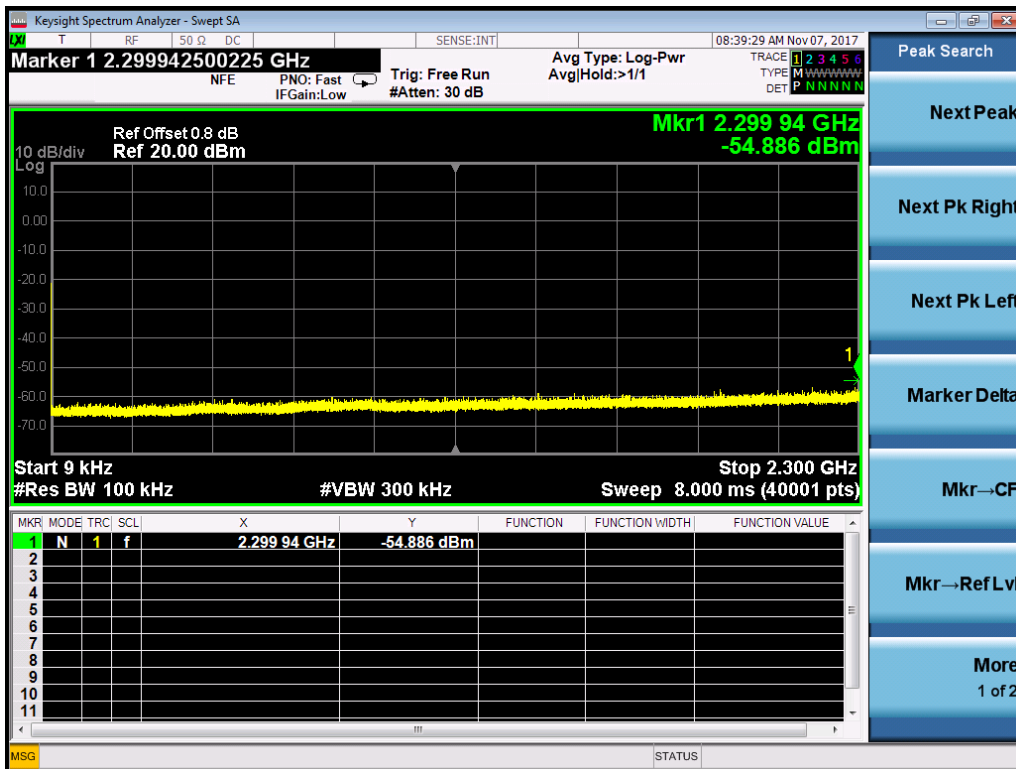
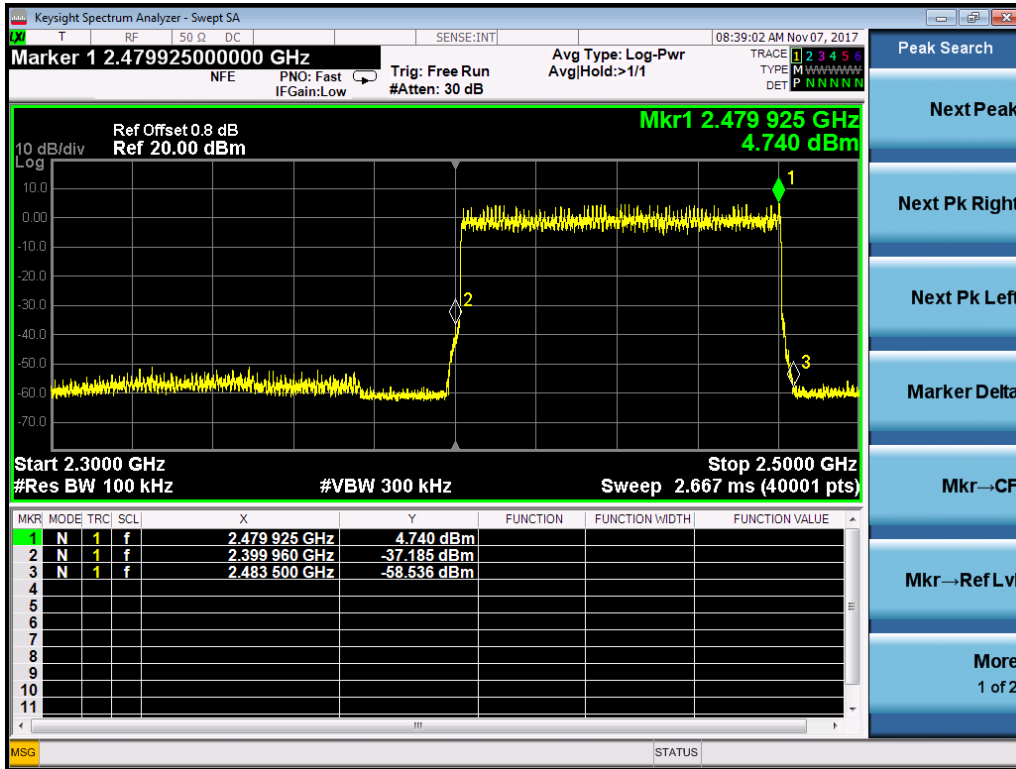

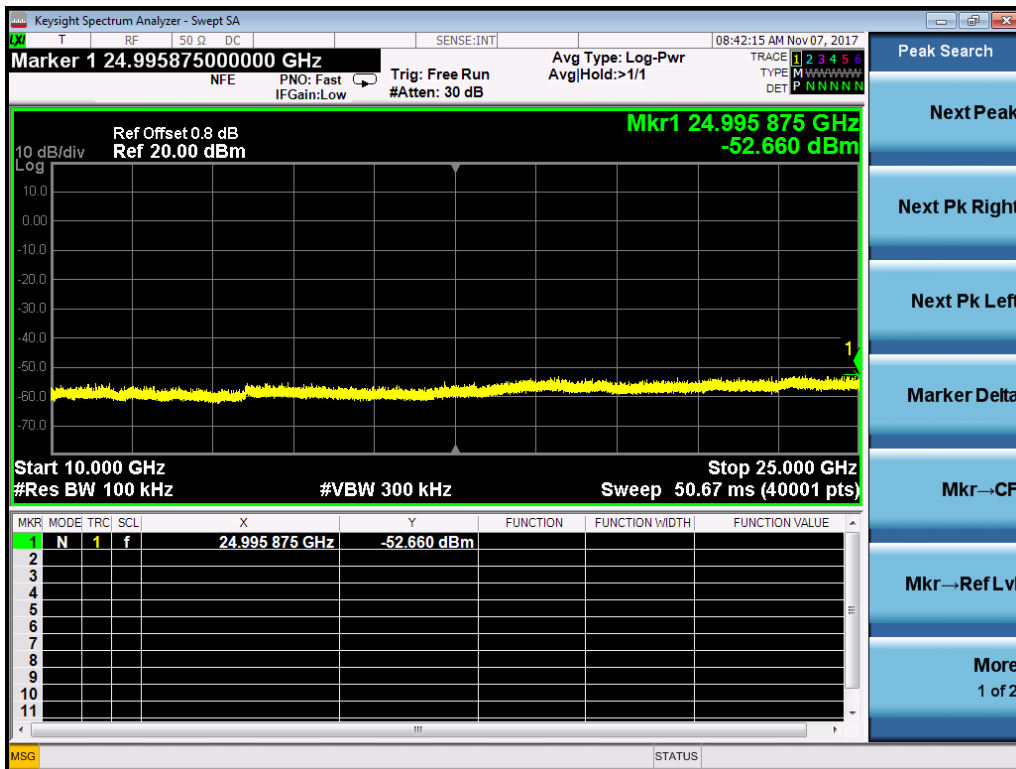
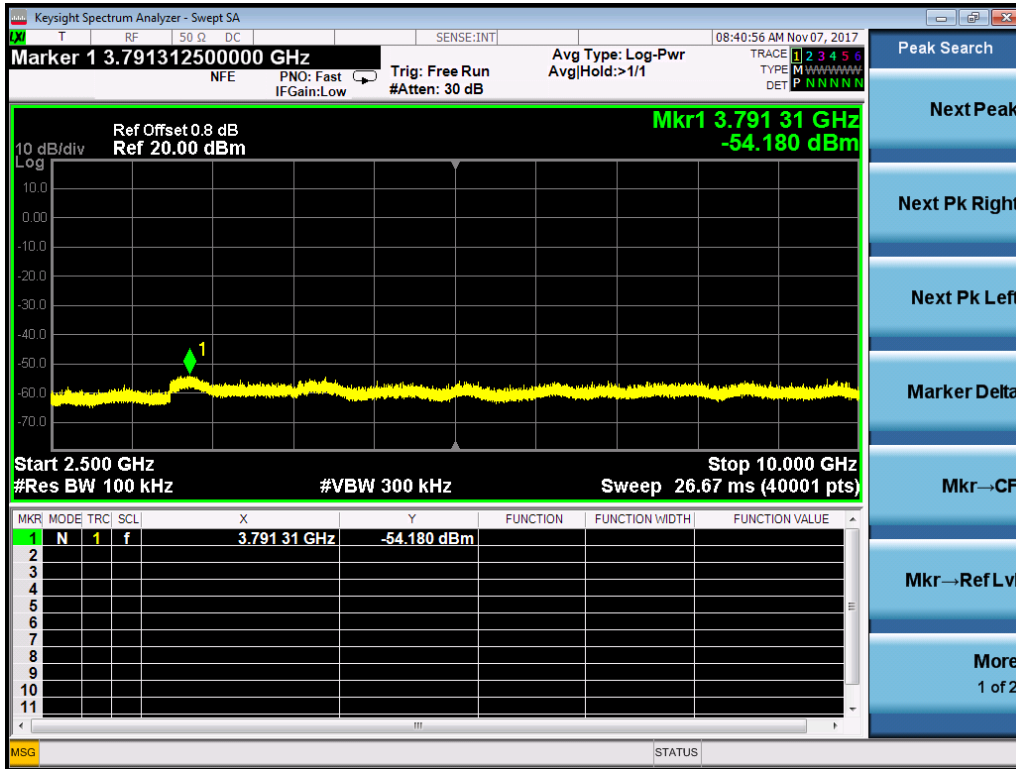

Hopping-8DPSK

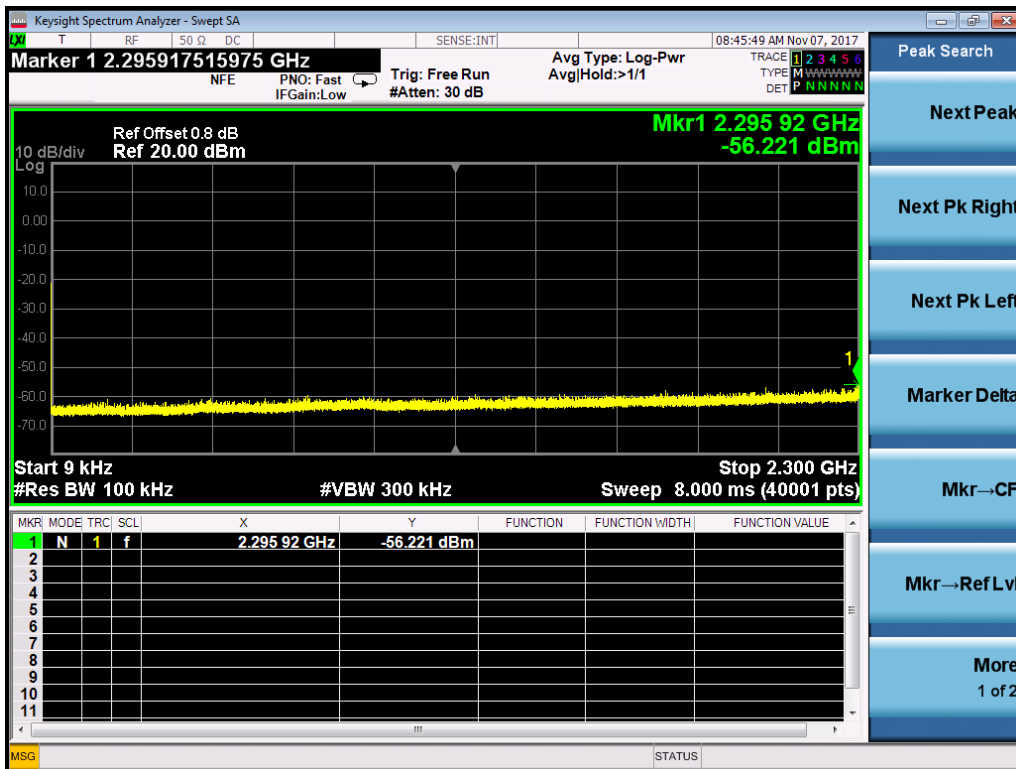
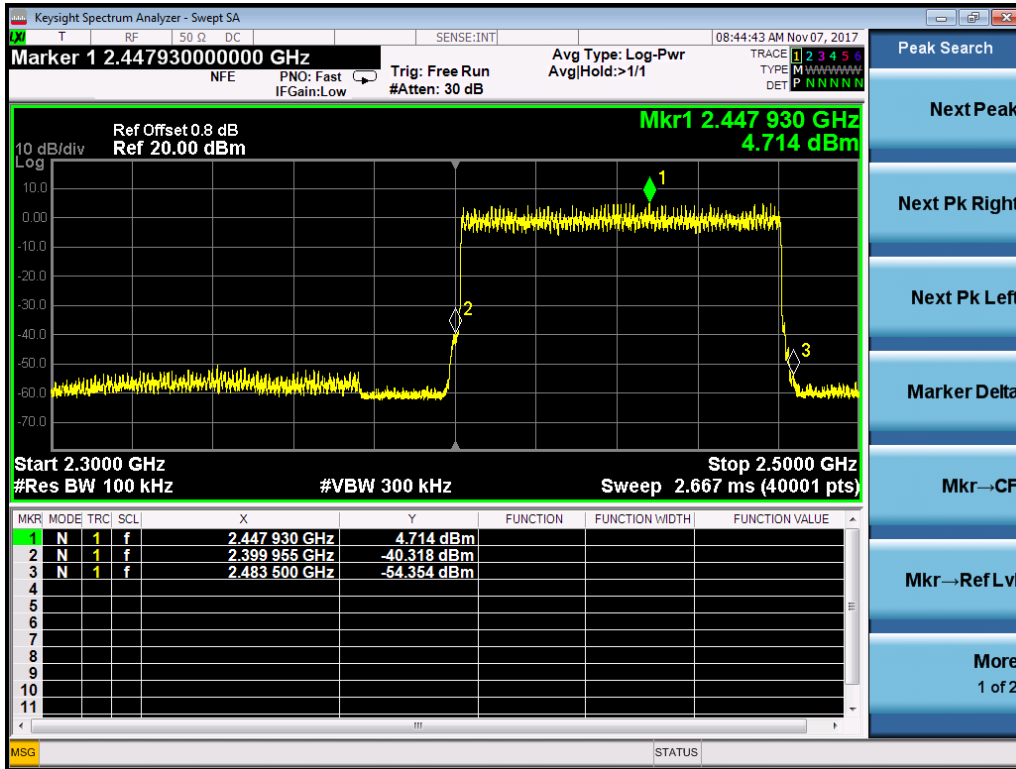

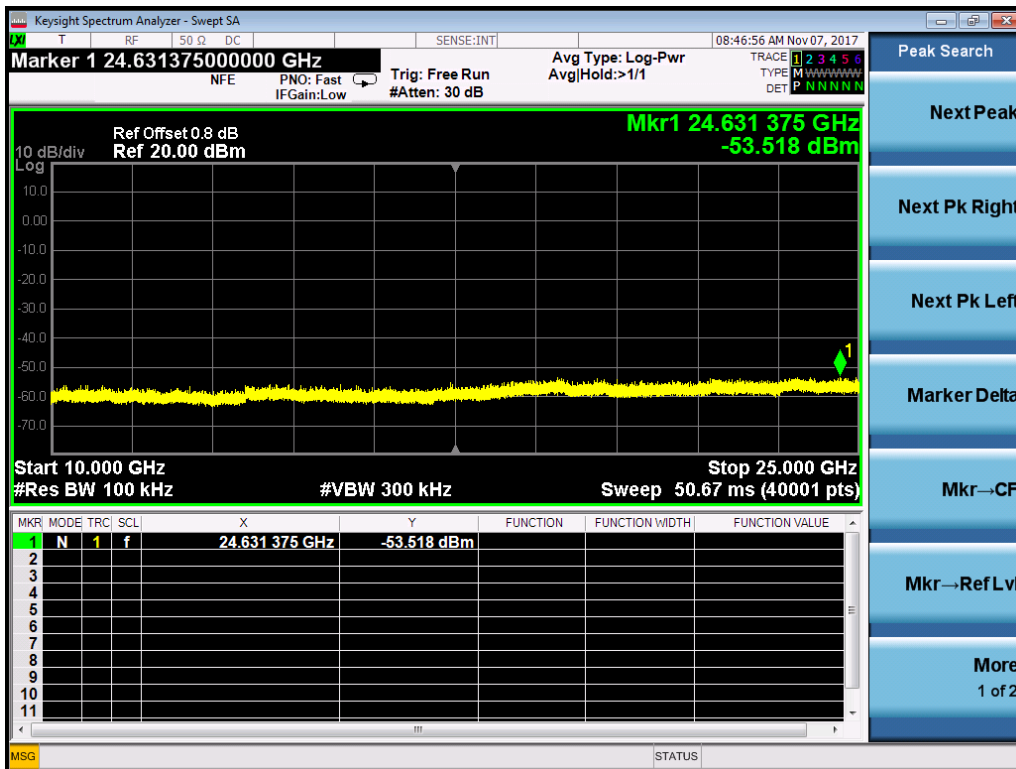
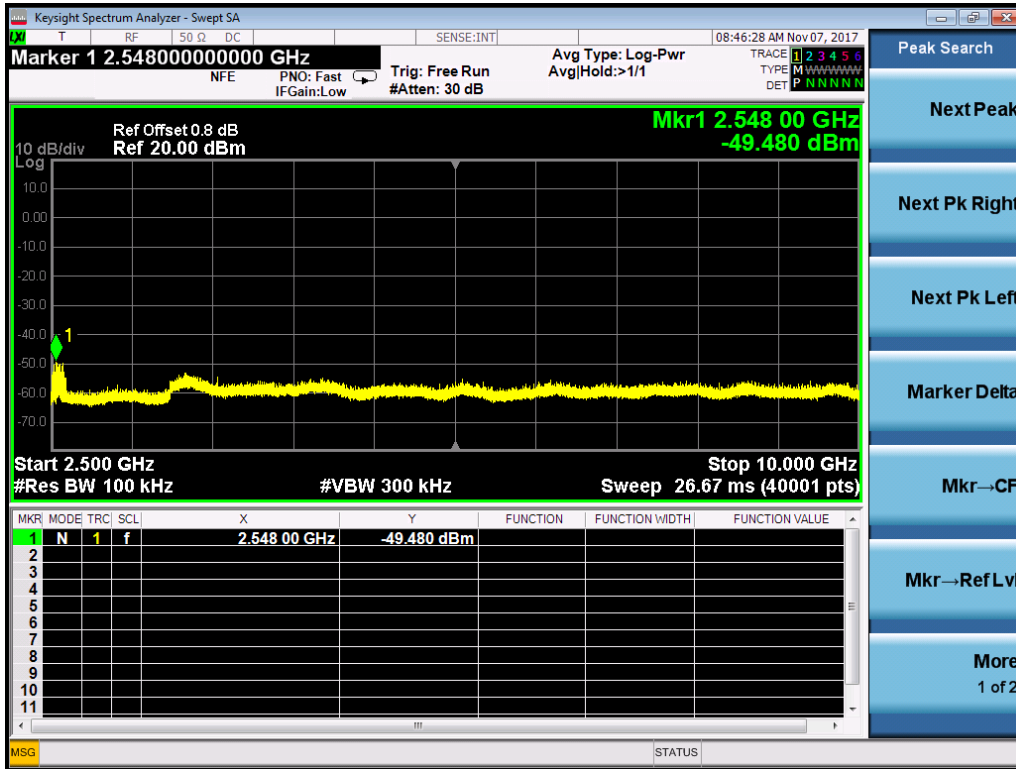

## 8. Power line conducted emission

Test result:Pass

### 8.1 Limit

Frequency of Emission (MHz)	Conducted Limit (dBuV)	
	QP	AV
0.15-0.5	66 to 56*	56 to 46 *
0.5-5	56	46
5-30	60	50

\* Decreases with the logarithm of the frequency.

### 8.2 Test configuration

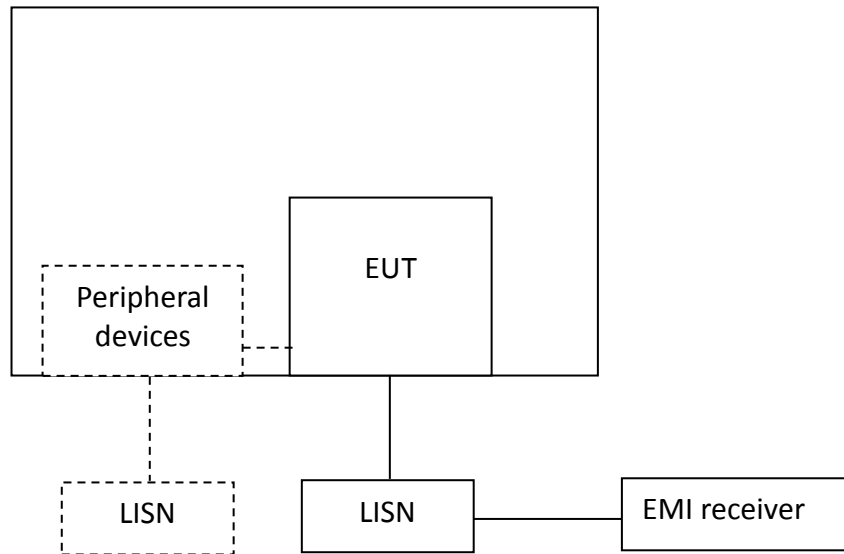

For table top equipment, wooden support is 0.8m height table

For floor standing equipment, wooden support is 0.12m height rack.

### **8.3 Test procedure and test set up**

The EUT are connected to the main power through a line impedance stabilization network (LISN). This provides a 50Ω/50uH coupling impedance for the measuring equipment. The peripheral devices are also connected to the main power through a LISN that provides a 50Ω/50uH coupling impedance with 50Ω termination.

Both sides (Line and Neutral) of AC line are checked for maximum conducted interference. In order to find the maximum emission, the relative positions of equipment and all of the interface cables must be changed according to ANSI C63.4 on conducted measurement. The bandwidth of the test receiver is set at 9 kHz.

The EUT was tested according to DA 00-705 (Filing and Measurement Guidelines for Frequency Hopping Spread Spectrum Systems)

**8.4 Test protocol**

Temperature : 25 °C  
Relative Humidity : 55 %

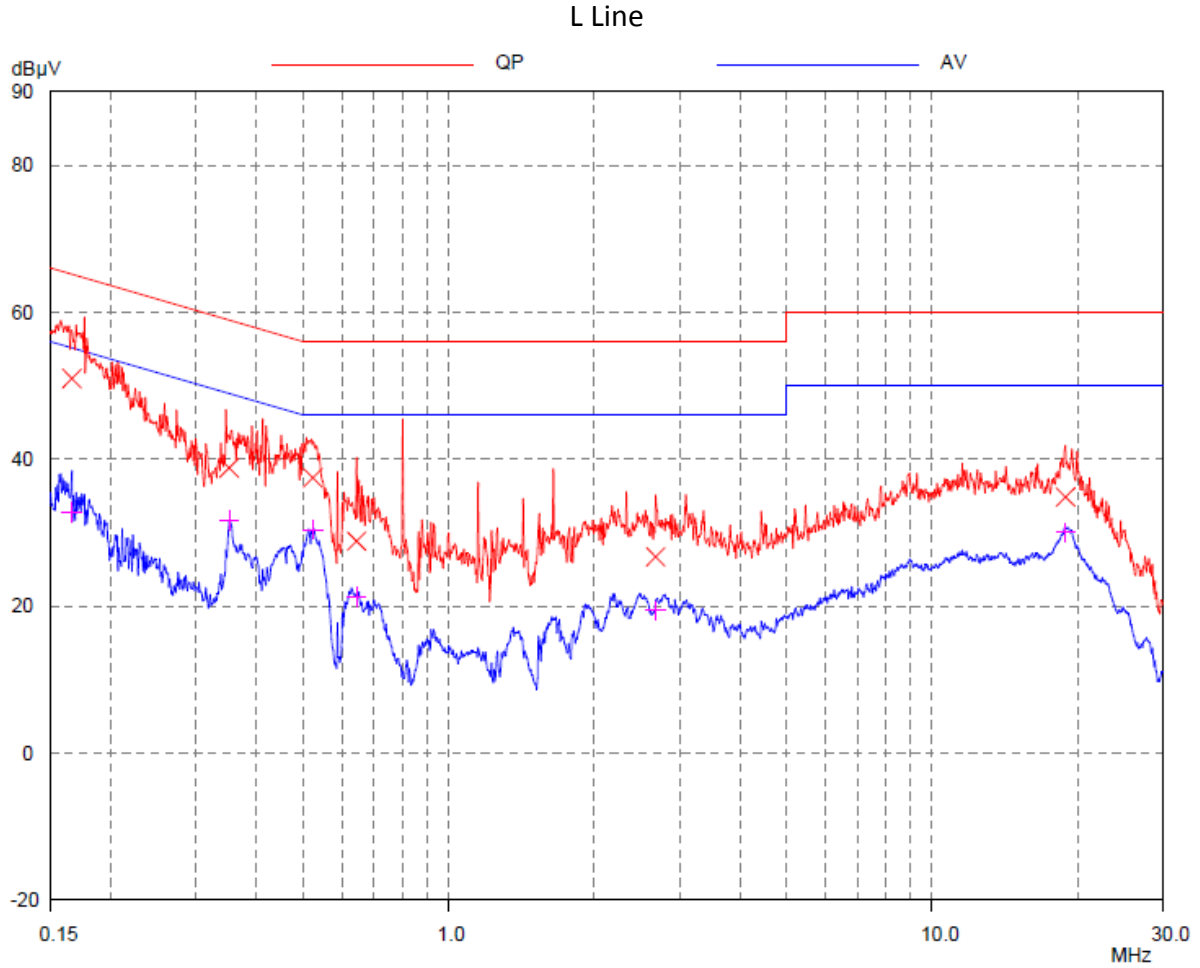

**Test Data:**

Frequency (MHz)	Quasi-peak			Average		
	level dB(µV)	Limit dB(µV)	Margin (dB)	level dB(µV)	limit dB(µV)	Margin (dB)
0.166	50.99	65.17	14.18	32.81	55.17	22.36
0.351	38.81	58.94	20.13	31.71	48.94	17.23
0.523	37.46	56.00	18.54	30.43	46.00	15.57
0.644	28.85	56.00	27.15	21.27	46.00	24.73
2.678	26.72	56.00	29.28	19.40	46.00	26.60
18.863	34.87	60.00	25.13	30.04	50.00	19.96



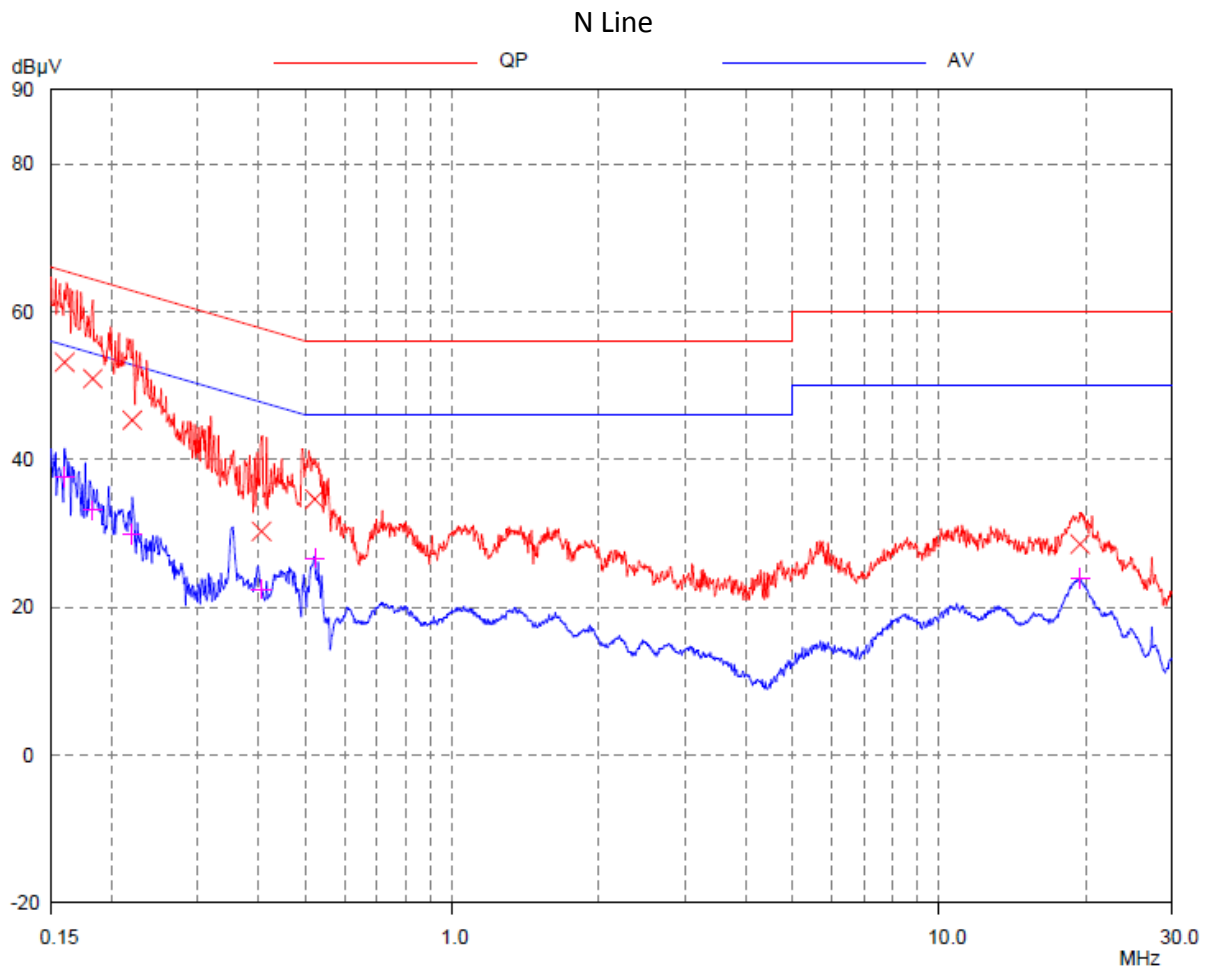

**Test Data:**

Frequency (MHz)	Quasi-peak			Average		
	level dB(µV)	Limit dB(µV)	Margin (dB)	level dB(µV)	limit dB(µV)	Margin (dB)
0.160	53.15	65.47	12.32	37.67	55.47	17.80
0.182	50.92	64.38	13.46	33.14	54.38	21.24
0.220	45.33	62.82	17.49	29.88	52.82	22.94
0.405	30.28	57.74	27.46	22.44	47.74	25.30
0.521	34.65	56.00	21.35	26.66	46.00	19.34
19.475	28.53	60.00	31.47	23.89	50.00	26.11

## 9. Number of Hopping Frequencies

Test result:Pass

### 9.1 Limit

Number of Hopping Frequencies in the 2400-2483.5 MHz band shall use at least 15 channels.

### 9.2 Test Configuration

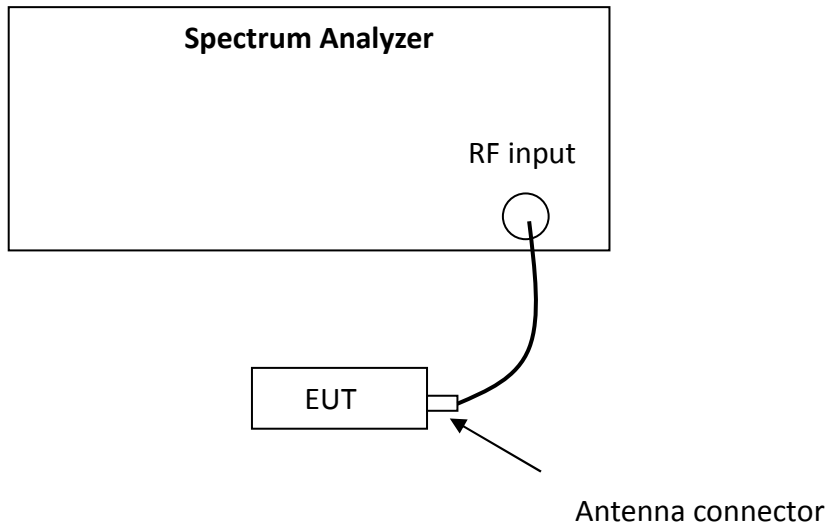

### 9.3 Test procedure and test setup

The channel number per FCC §15.247(a)(1)(iii) is measured using the Spectrum Analyzer with RBW=100kHz, VBW≥RBW, Sweep = auto, Detector = peak, Trace = max hold. The EUT was tested according to DA 00-705 (Filing and Measurement Guidelines for Frequency Hopping Spread Spectrum Systems).

### 9.4 Test protocol

Temperature : 25 °C  
Relative Humidity : 55 %

Channel Number	Limit
79	≥15

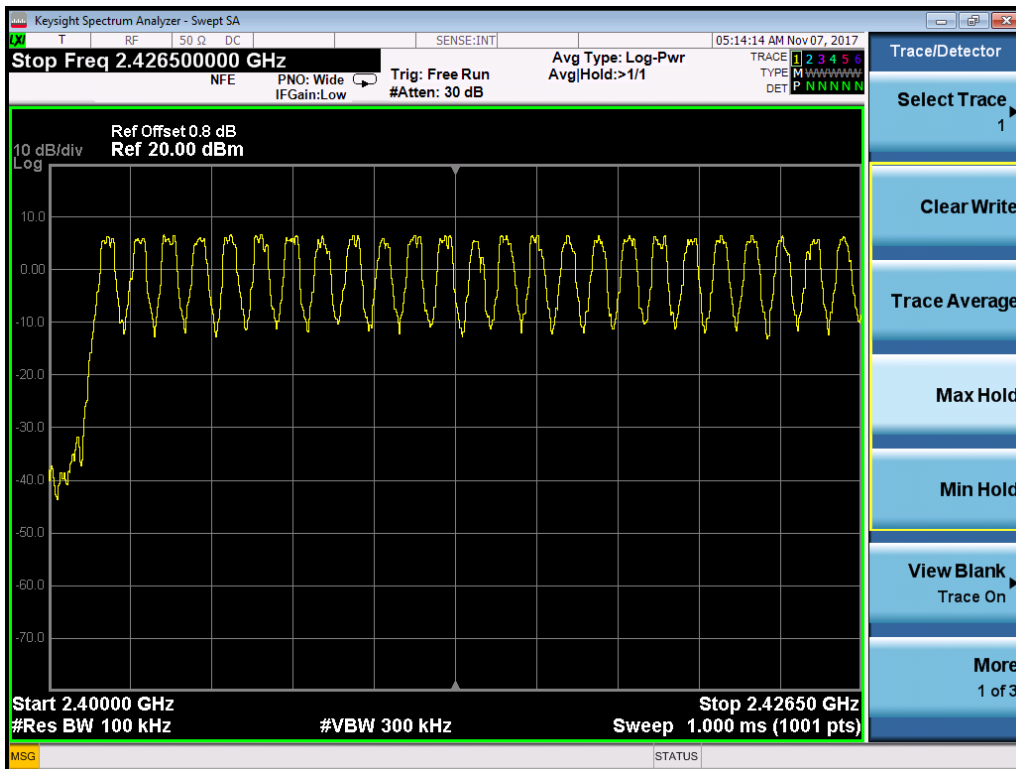
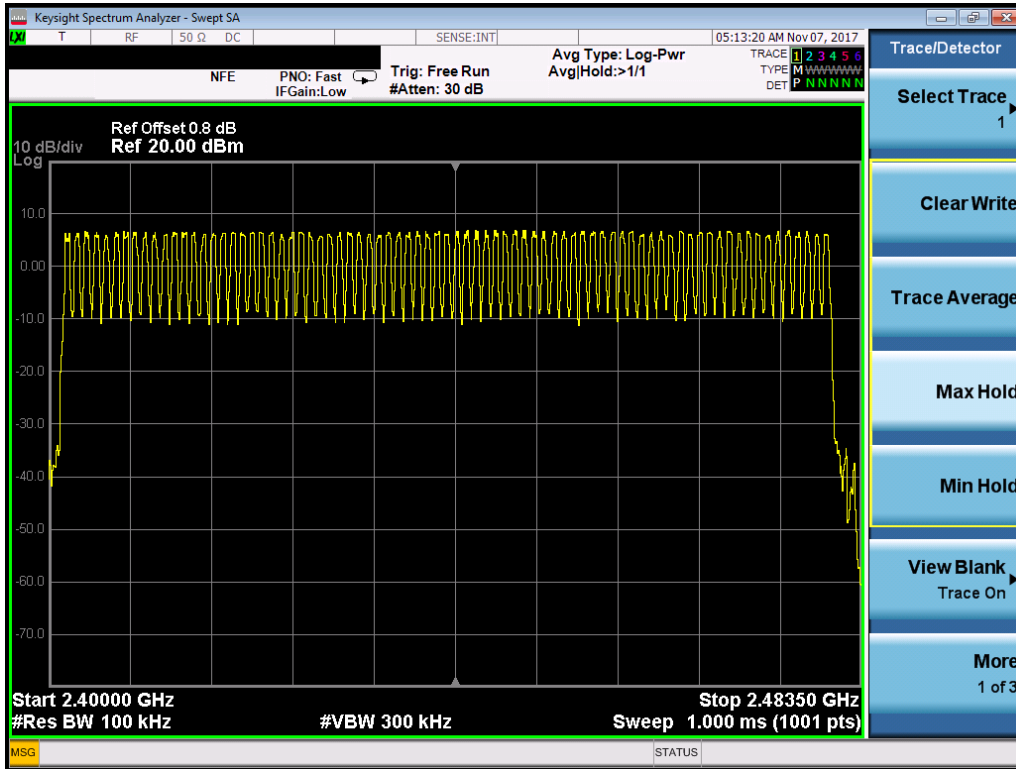

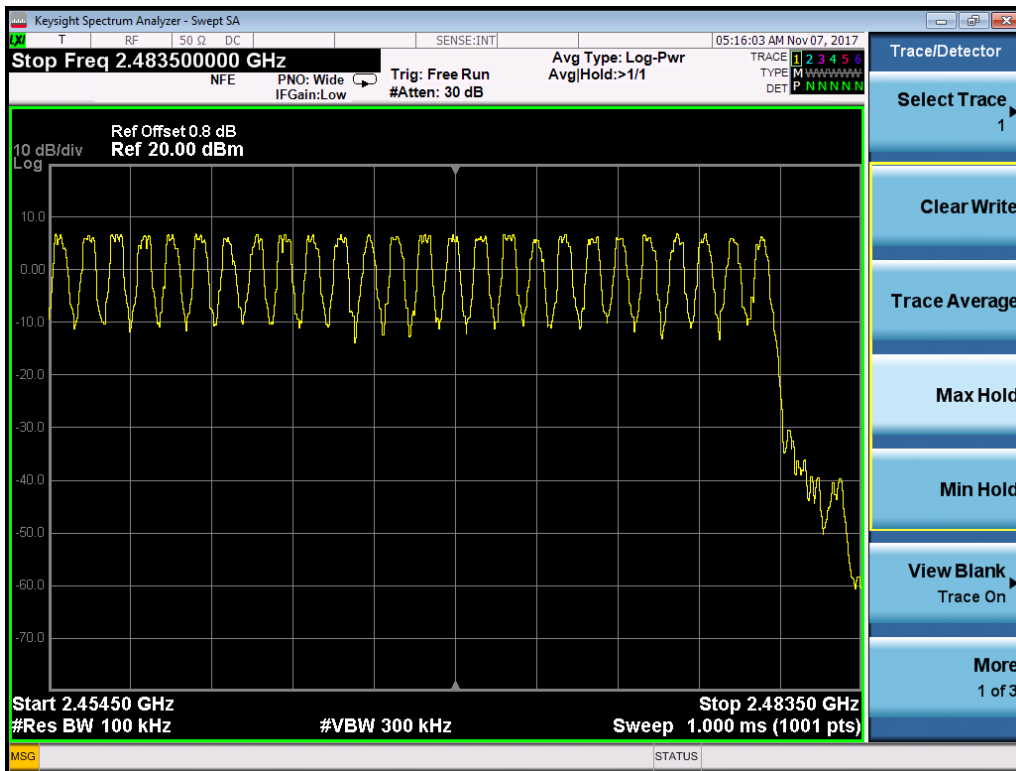
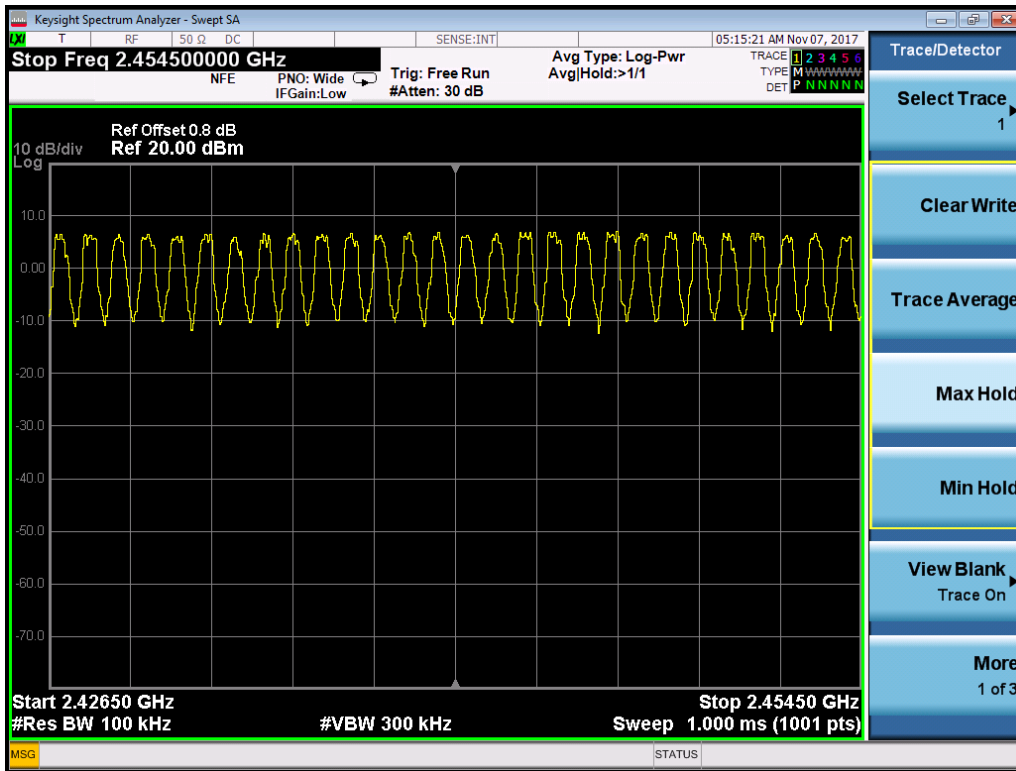

## 10. Dwell Time

**Test result:Pass**

### 10.1 Limit

The dwell time on any channel shall not be greater than 0.4 seconds within a period of 0.4 seconds multiplied by the number of hopping channels employed. Frequency hopping systems may avoid or suppress transmissions on a particular hopping frequency provided that a minimum of 15 channels are used.

### 10.2 Test Configuration

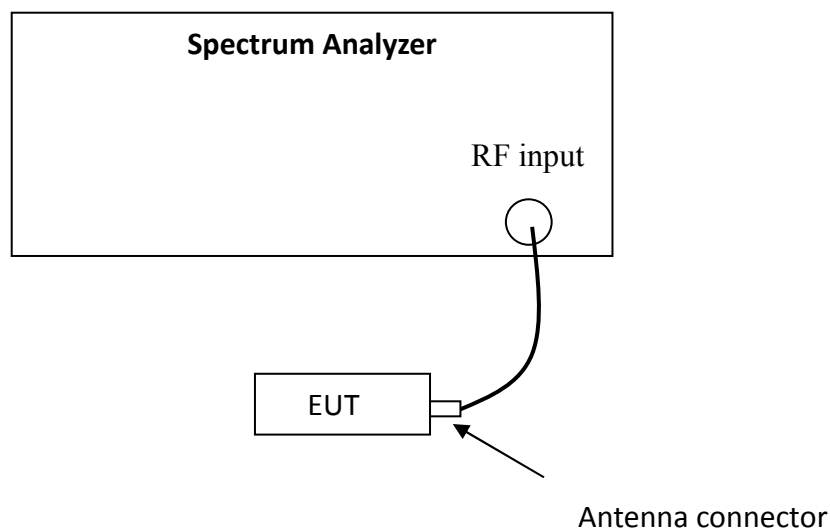

### 10.3 Test procedure and test setup

Dwell time per FCC §15.247(a)(1)(iii) is measured using the Spectrum Analyzer with Span = 0, RBW=1MHz, VBW≥RBW, Sweep can capture the entire dwell time, Detector = peak, Trace = max hold.

The EUT was tested according to DA 00-705 (Filing and Measurement Guidelines for Frequency Hopping Spread Spectrum Systems).

### 10.4 Test protocol

Temperature : 25 °C  
Relative Humidity : 55 %

8DPSK Modulation:

Packet	Occupancy time for single hop (ms) O	CH	Real observed period (s) P	Hops among Observed period I	Dwell time (ms) T	Limit (s)
DH1	0.387	L	3.16	32	123.84	≤0.4
		M	3.16	32	123.84	
		H	3.16	32	123.84	
DH3	1.640	L	3.16	16	262.40	
		M	3.16	16	262.40	
		H	3.16	16	262.40	
DH5	2.888	L	3.16	11	317.68	
		M	3.16	11	317.68	
		H	3.16	11	317.68	

Remark: 1. There are 79 channels in all. So the complete observed period  $P = 0.4 * 79 = 31.6$  s.  
2. Average time of occupancy  $T = O * I * 31.6 / P$

DH1

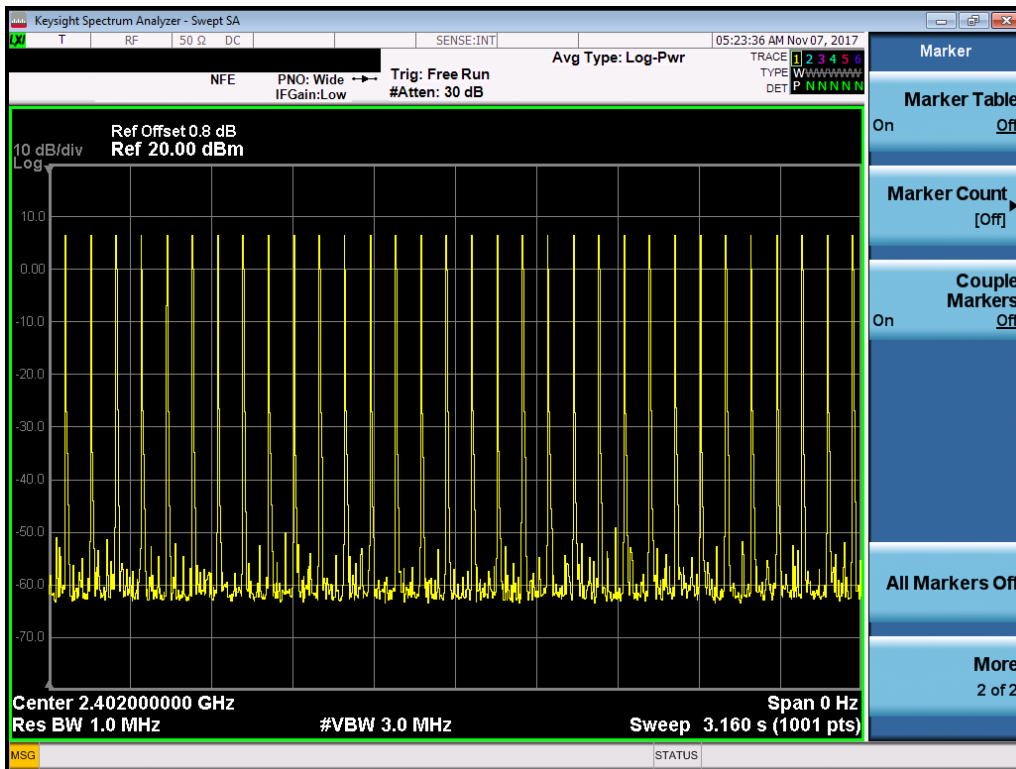
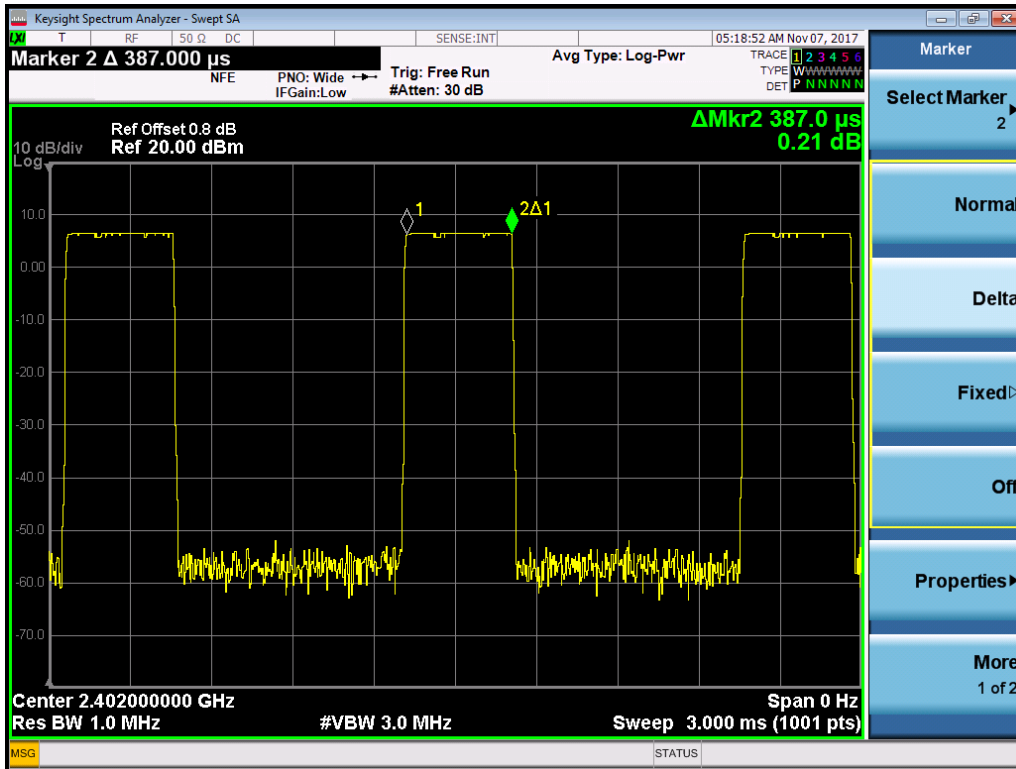

DH3

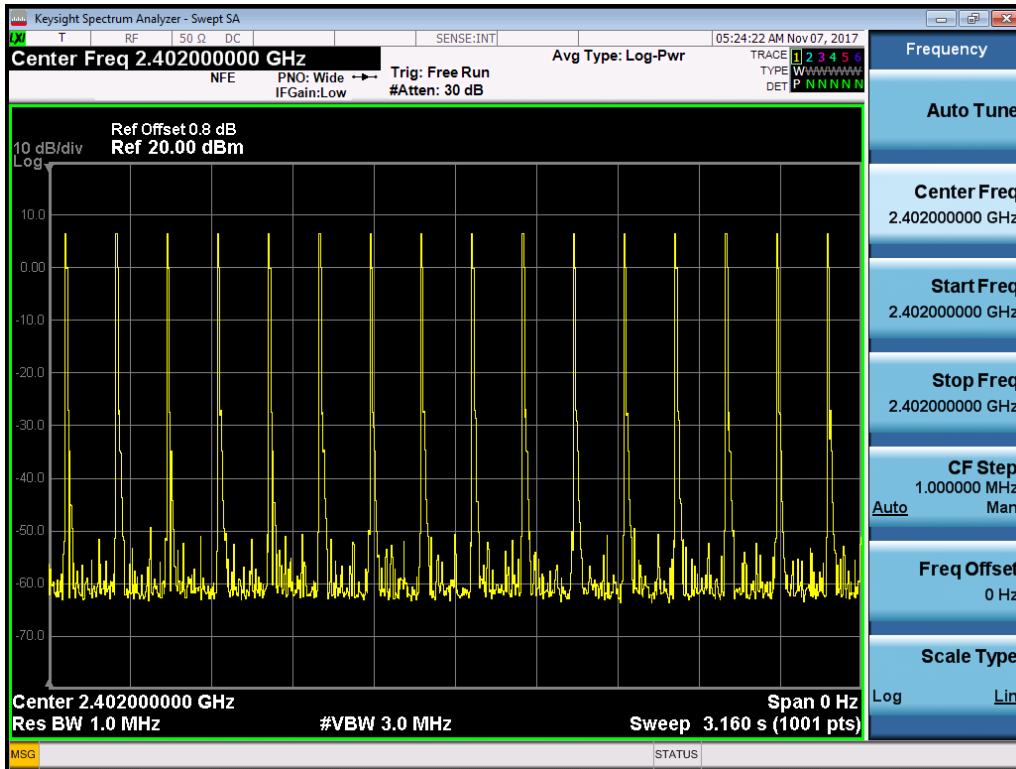
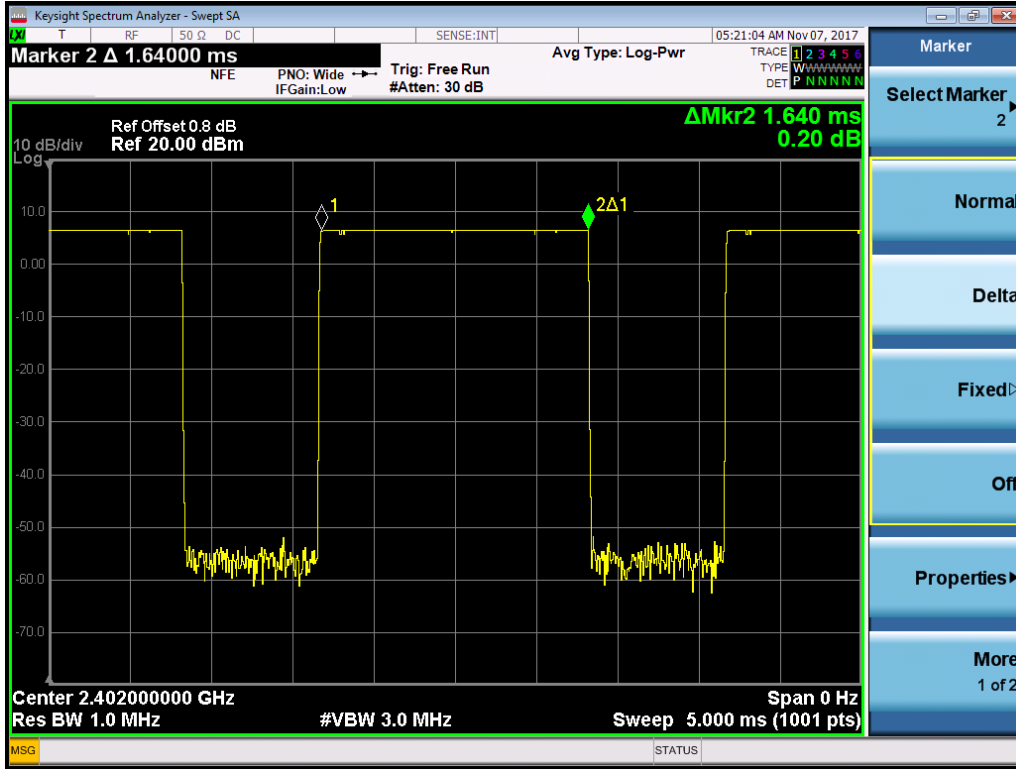



DH5

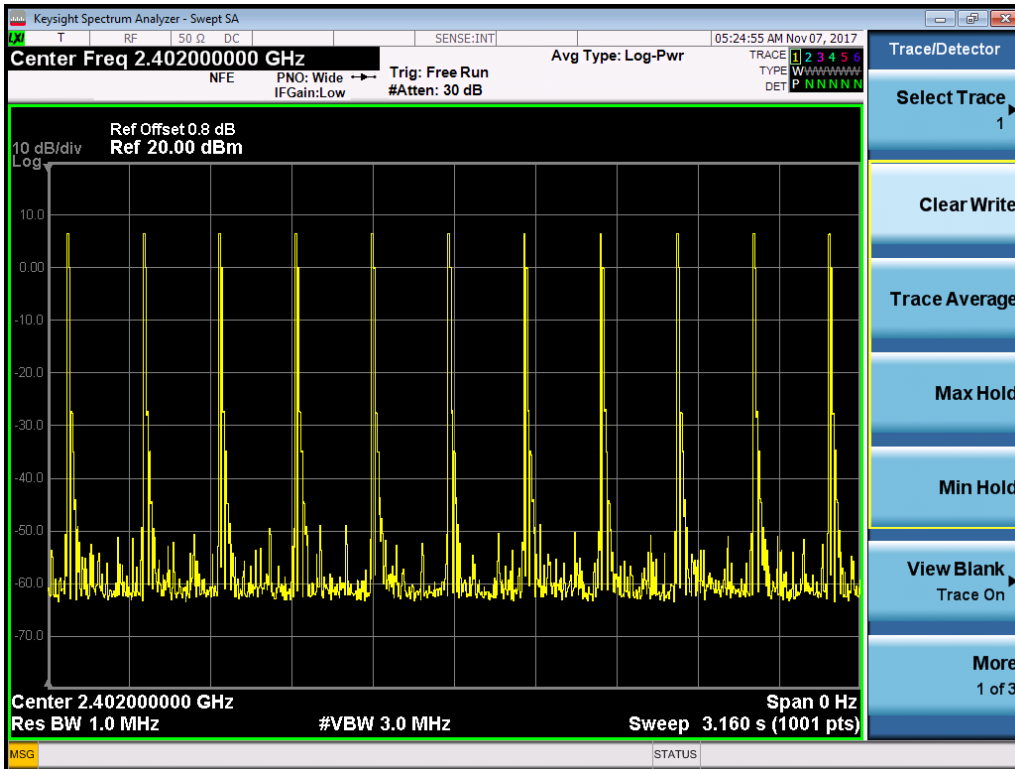
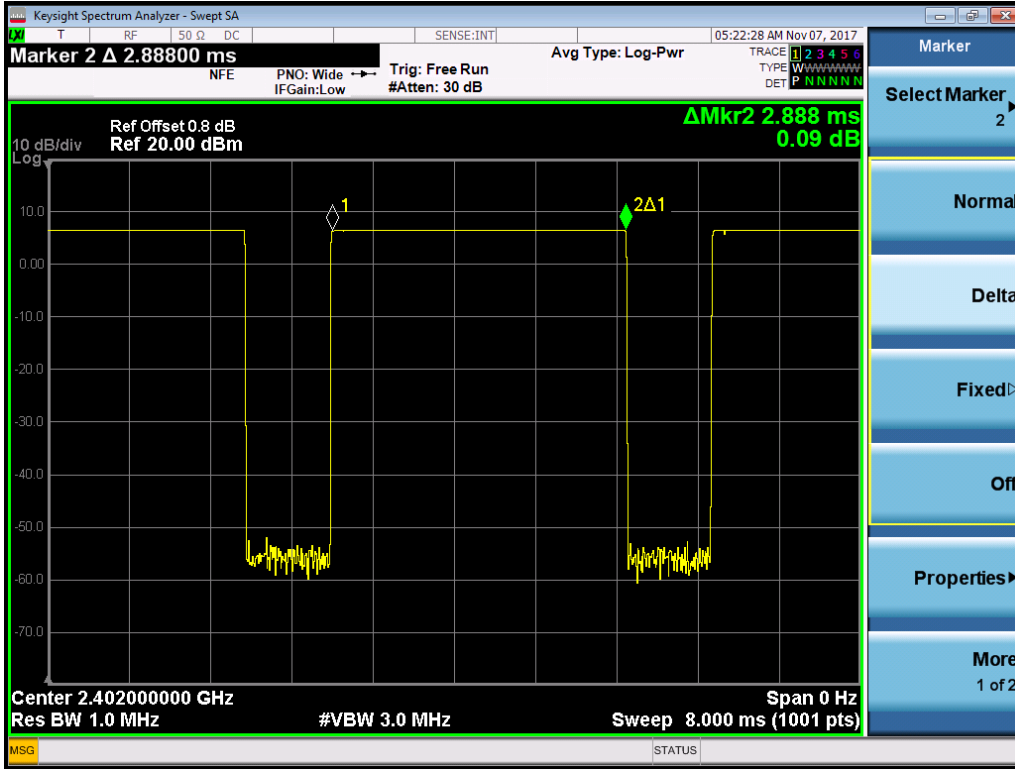

## 11. Occupied Bandwidth

Test result: Tested

### 11.1 Test limit

None

### 11.2 Test Configuration

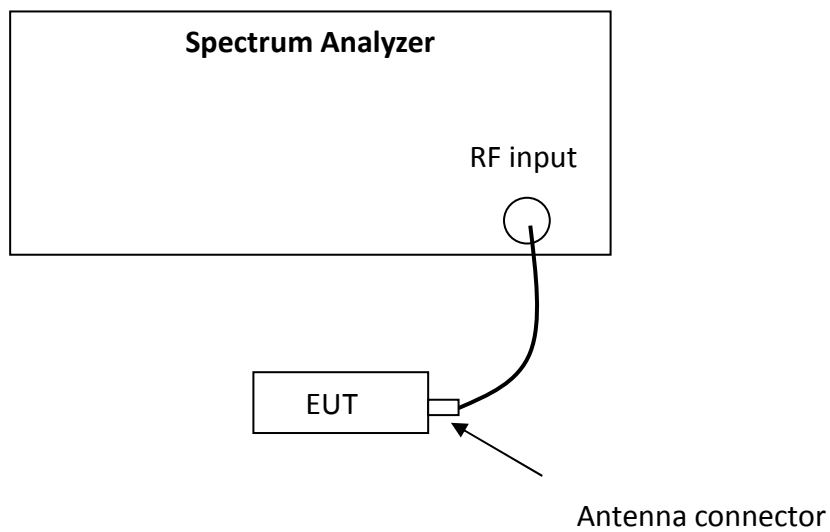

### 11.3 Test procedure and test setup

The occupied bandwidth per RSS-Gen Issue 4 Clause 6.6 was measured using the Spectrum Analyzer with the RBW close to 1% of the selected span,  $VBW = 3 * RBW$   
Detector = Sample, Sweep = Auto.

## 11.4 Test protocol

Temperature : 25 °C  
Relative Humidity : 55 %

Modulation	Channel	99% Occupied Bandwidth (kHz)
GFSK	L	846.87
	M	841.18
	H	842.27

Modulation	Channel	99% Occupied Bandwidth (kHz)
$\pi/4$ DQPSK	L	1165.60
	M	1166.40
	H	1169.20

Modulation	Channel	99% Occupied Bandwidth (kHz)
8DPSK	L	1157.40
	M	1157.80
	H	1161.30

*Note: The test plots please see Section 3 in this report.*

## 12. Spurious emission for receiver

Test result:NA

### 12.1 Test limit

The spurious emission shall test through 3 times tuneable or local oscillator frequency whichever is the higher, without exceeding 40 GHz.

If a conducted measurement is made, no spurious output signals appearing at the antenna terminals shall exceed 2nW per any 4 kHz spurious frequency in the band 30-1000 MHz, or 5nW above 1 GHz.

If a radiated measurement is made, all spurious emissions shall comply with the limits of Table below:

Frequency (MHz)	Field Strength (dBuV/m)	Measurement Distance (m)
30 - 88	40.0	3
88 - 216	43.5	3
216 - 960	46.0	3
Above 960	54.0	3

### 12.2 Test Configuration

Please refer to clause 6.2

### 12.3 Test procedure and test setup

Please refer to clause 6.3.

