

Quick Installation Guide

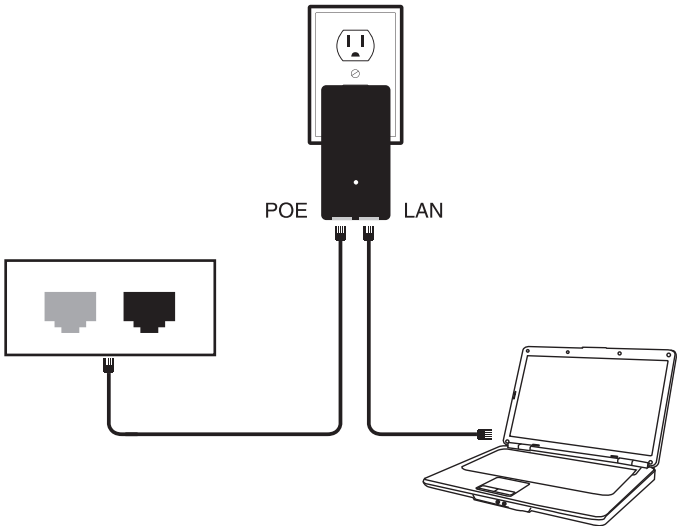

- 1 Open your "Network Connections"
- 2 Open your "Local Area Connections", and choose "Property" .

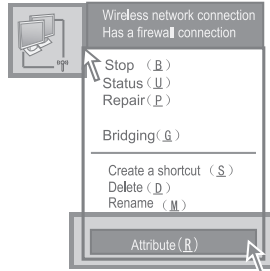
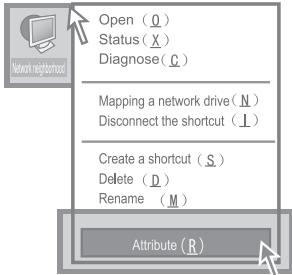

- 3 Double click "Internet Protocol (TCP/IP) Properties".

4

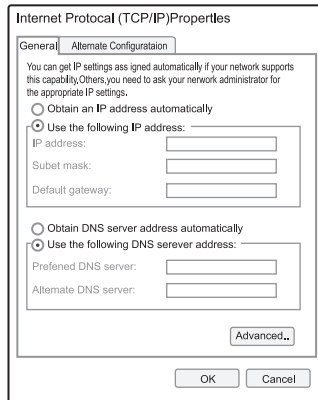
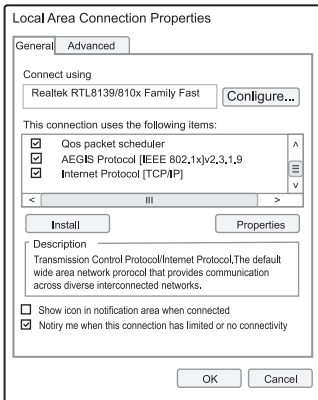

ADSL Mode (dialing)

Choose "ADSL", enter the user name and password of your broadband, and set your own SSID, and set your ip to 192.168.110.1, and save changes. (PS: the cable need be connected with WAN port in ADSL Mode)

Wireless Network

Easy Setup

Easy Setup

▶ ADSL

AP

Terminal Repeater

AP+WDS

Terminal(WDS)

Repeater(WDS)

Status

Connection

Firewall

System

Logut

Internet / WAN

User Name:

Password:

Reconnect Mode: (seconds)

Local Network / LAN

Router IP:

Local Network / LAN

Operation Mode:

Channel Width:

Transmit Power: (0-27dBm)

Wireless MAC Filter:

Access Point SSID:

Wireless Channel:

Encryption:

Password:

Save Changes

Reset

Steps of Setting up (refer to the left picture)

1. Write down ADSL and password
2. Set up IP address of Router (for example: 192.168.110.1)
3. Frequency setting (support 2.3–2.7G)

Note: in general, routers, mobile phone, laptop only could receive 2.4Ghz channel

(1) Firstly, choose "width of broadband"

(2) Secondly, choose the channel which you need in "wireless channel"

4. Write down the name of SSID (like: wifi, do not support Chinese SSID)
5. Choose encryption (like: choose WPA PSK, add wifi password)
6. Save and finish setting.

Environment setting

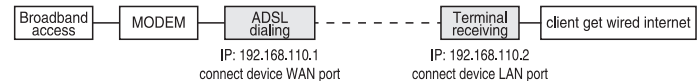





← Set your IP

←

Steps of Setting up (refer to the left picture)

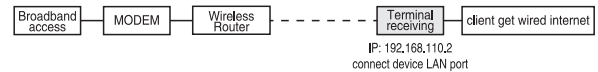
Environment setting



Note:

- 1.if the strength of signal light on,could connect QQ but could not open the website,Pls choose “connection” option at the left,DNS change to “Google DNS serve” .
- 2.when receiving CMCC,DNS change to “Operators provide default DNS serve” .

Environment setting

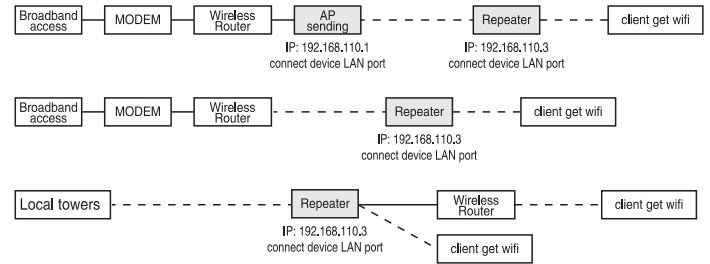

Note:

1. If the device signal indicator light is on, and it can connect to QQ but can't open the website, please click the left selection "connect", DNS change to "Google DNS server"
2. When receiving CMCC, DNS should change to "Operators of DNS server by default"

Setting setup (Reference the left picture):

1. Setting the router IP address : (For example: 192.168.110.3)
2. Setting SSID, scan the available wifi signal
3. Enter the name of SSID wifi signal (For example: wifi)
4. Choose the encryption (For example: WPA PSK, add wifi password)
5. Save the change , set up is finished

Q3 How to reset CPE?

Get device power on,long press RESET button(),device reboot.

Q4 How to solve the LAN can't get the IP address even the cable connect to the computer?

The cable must connect to the wireless bridge LAN port, if connect to WAN the will not get the IP address.

Q5 Why local Area Connection is on and off after installed device?

Detection method as below:

- 1.Try to change 1m cable,make sure it is not quality of cable problem.
- 2.Try to change channels,avoid signal quality problem cause disturbance.

Q6 Why the website blank and show the mistake that can't enter password ?

You can try to change the IE version , recommend the Google browser.

Q7 What's the mean of repeater ?

Repeater mean when receive the signal , it will transfer the signal meanwhile output the wireless signal. As the function of the amplifier.