



FCC TEST REPORT

REPORT NO.: RF931119H01
MODEL NO.: NS-5GT-WIRELESS ADSL A
RECEIVED: Nov. 19, 2004
TESTED: Dec. 22, 2004 to Jan. 05, 2005
ISSUED: Jan. 17, 2005

APPLICANT: Juniper Networks

ADDRESS: 1194 North Mathilda Avenue, Sunnyvale,
California 94089

ISSUED BY: Advance Data Technology Corporation

LAB LOCATION: No. 81-1, Lu Liao Keng, 9 Ling, Wu Lung Tsuen,
Chiung Lin Hsiang, Hsin Chu Hsien,
Taiwan, R.O.C.

This test report consists of 87 pages in total. It may be duplicated completely for legal use with the approval of the applicant. It should not be reproduced except in full, without the written approval of our laboratory. The client should not use it to claim product endorsement by CNLA, A2LA or any government agencies. The test results in the report only apply to the tested sample. The test results in this report are traceable to the national or international standards.



0536
ILAC MRA



No. 2177-01



Table of Contents

1	CERTIFICATION	5
2	SUMMARY OF TEST RESULTS	6
3	GENERAL INFORMATION	7
3.1	GENERAL DESCRIPTION OF EUT	7
3.2	DESCRIPTION OF TEST MODES	9
3.3	GENERAL DESCRIPTION OF APPLIED STANDARDS	9
3.4	DESCRIPTION OF SUPPORT UNITS	10
3.5	CONFIGURATION OF SYSTEM UNDER TEST	11
4	TEST TYPES AND RESULTS	13
4.1	CONDUCTED EMISSION MEASUREMENT	13
4.1.1	LIMITS OF CONDUCTED EMISSION MEASUREMENT	13
4.1.2	TEST INSTRUMENTS	13
4.1.3	TEST PROCEDURES	14
4.1.4	TEST SETUP	14
4.1.5	EUT OPERATING CONDITIONS	15
4.1.6	TEST RESULTS (WITH ADAPTER 1)	16
4.1.7	TEST RESULTS (WITH ADAPTER 2)	18
4.2	RADIATED EMISSION MEASUREMENT	20
4.2.1	LIMITS OF RADIATED EMISSION MEASUREMENT	20
4.2.2	TEST INSTRUMENTS	21
4.2.3	TEST PROCEDURES	22
4.2.4	TEST SETUP	23
4.2.5	EUT OPERATING CONDITIONS	23
4.2.6	TEST RESULTS (ANTENNA 1 – ADAPTER 1)	24
4.2.7	TEST RESULTS (ANTENNA 2 – ADAPTER 1)	25
4.2.8	TEST RESULTS (ANTENNA 3 – ADAPTER 1)	26
4.2.9	TEST RESULTS (ANTENNA 1 – ADAPTER 2)	27
4.2.10	TEST RESULTS (ANTENNA 2 – ADAPTER 2)	28
4.2.11	TEST RESULTS (ANTENNA 3 – ADAPTER 2)	29
4.2.12	TEST RESULTS (ANTENNA 1 – DSSS)	30
4.2.13	TEST RESULTS (ANTENNA 2 – DSSS)	33
4.2.14	TEST RESULTS (ANTENNA 3 – DSSS)	36
4.2.15	TEST RESULTS (ANTENNA 1 – OFDM)	39
4.2.16	TEST RESULTS (ANTENNA 2 – OFDM)	42
4.2.17	TEST RESULTS (ANTENNA 3 – OFDM)	45



4.3	6DB BANDWIDTH MEASUREMENT	48
4.3.1	LIMITS OF 6DB BANDWIDTH MEASUREMENT	48
4.3.2	TEST INSTRUMENTS	48
4.3.3	TEST PROCEDURE	49
4.3.4	TEST SETUP	49
4.3.5	EUT OPERATING CONDITIONS	49
4.3.6	TEST RESULTS – DSSS	50
4.3.7	TEST RESULTS – OFDM	53
4.4	MAXIMUM PEAK OUTPUT POWER	56
4.4.1	LIMITS OF MAXIMUM PEAK OUTPUT POWER MEASUREMENT	56
4.4.2	TEST INSTRUMENTS	56
4.4.3	TEST PROCEDURES	57
4.4.4	TEST SETUP	57
4.4.5	EUT OPERATING CONDITIONS	57
4.4.6	TEST RESULTS - DSSS	58
4.4.7	TEST RESULTS - OFDM	59
4.5	POWER SPECTRAL DENSITY MEASUREMENT	60
4.5.1	LIMITS OF POWER SPECTRAL DENSITY MEASUREMENT	60
4.5.2	TEST INSTRUMENTS	60
4.5.3	TEST PROCEDURE	61
4.5.4	TEST SETUP	61
4.5.5	EUT OPERATING CONDITIONS	61
4.5.6	TEST RESULTS – DSSS	62
4.5.7	TEST RESULTS – OFDM	65
4.6	BAND EDGES MEASUREMENT	68
4.6.1	LIMITS OF BAND EDGES MEASUREMENT	68
4.6.2	TEST INSTRUMENTS	68
4.6.3	TEST PROCEDURE	68
4.6.4	EUT OPERATING CONDITION	68
4.6.5	TEST RESULTS (ANTENNA 1 – DSSS)	69
4.6.6	TEST RESULTS (ANTENNA 2 – DSSS)	71
4.6.7	TEST RESULTS (ANTENNA 3 – DSSS)	73
4.6.8	TEST RESULTS (ANTENNA 1 – OFDM)	75
4.6.9	TEST RESULTS (ANTENNA 2 – OFDM)	77
4.6.10	TEST RESULTS (ANTENNA 3 – OFDM)	79
4.7	ANTENNA REQUIREMENT	81
4.7.1	STANDARD APPLICABLE	81



4.7.2	ANTENNA CONNECTED CONSTRUCTION.....	81
5	PHOTOGRAPHS OF THE TEST CONFIGURATION.....	82
6	INFORMATION ON THE TESTING LABORATORIES	87



1 CERTIFICATION

PRODUCT : NetScreen-5GT ADSL Wireless
BRAND NAME : Juniper
MODEL NO. : NS-5GT-WIRELESS ADSL A
TESTED: Dec. 22, 2004 to Jan. 05, 2005
APPLICANT : Juniper Networks
TEST ITEM: ENGINEERING SAMPLE
STANDARDS : 47 CFR Part 15, Subpart C (Section 15.247),
ANSI C63.4-2003

The above equipment (Model: NS-5GT-WIRELESS ADSL A) has been tested by **Advance Data Technology Corporation**, and found compliance with the requirement of the above standards. The test record, data evaluation & Equipment Under Test (EUT) configurations represented herein are true and accurate accounts of the measurements of the sample's EMC characteristics under the conditions specified in this report.

PREPARED BY : Carol Liao , **DATE:** Jan. 17, 2005
(Carol Liao)

TECHNICAL ACCEPTANCE : Hank Chung , **DATE:** Jan. 17, 2005
Responsible for RF (Hank Chung)

APPROVED BY : Eric Lin , **DATE:** Jan. 17, 2005
(Eric Lin, Manager)



2 SUMMARY OF TEST RESULTS

The EUT has been tested according to the following specifications:

APPLIED STANDARD: 47 CFR Part 15, Subpart C			
Standard Section	Test Type and Limit	Result	REMARK
15.207	AC Power Conducted Emission	PASS	Meet the requirement of limit Minimum passing margin is -13.02 dB at 0.189 MHz
15.247(a)(2)	Spectrum Bandwidth of a Direct Sequence Spread Spectrum System Limit: min. 500kHz	PASS	Meet the requirement of limit
15.247(b)	Maximum Peak Output Power Limit: max. 30dBm	PASS	Meet the requirement of limit
15.247(c)	Transmitter Radiated Emissions Limit: Table 15.209	PASS	Meet the requirement of limit Minimum passing margin is -1.00 dB at 2387.00 MHz
15.247(d)	Power Spectral Density Limit: max. 8dBm	PASS	Meet the requirement of limit
15.247(c)	Band Edge Measurement Limit: 20 dB less than the peak value of fundamental frequency	PASS	Meet the requirement of limit



3 GENERAL INFORMATION

3.1 GENERAL DESCRIPTION OF EUT

PRODUCT	NetScreen-5GT ADSL Wireless
MODEL NO.	NS-5GT-WIRELESS ADSL A
POWER SUPPLY	DC 12V from AC adapter
MODULATION TYPE	CCK, OFDM
RADIO TECHNOLOGY	DSSS, OFDM
TRANSFER RATE	1/2/5.5/6/9/11/12/18/24/36/48/54Mbps
FREQUENCY RANGE	2412MHz ~ 2462MHz
NUMBER OF CHANNEL	11
OUTPUT POWER	22.02 dBm
ANTENNA TYPE	Please see note 5 on next page
DATA CABLE	NA
I/O PORTS	ADSL port (RJ-11) x 1 LAN port (RJ-45) x 4 WAN port (RJ-45) x 1 Console port (RJ-45)x 1 Modem port (RJ-45)x 1
ASSOCIATED DEVICES	NA

NOTE:

1. The EUT operates in the 2.4GHz frequency spectrum with throughput of up to 54Mbps.
2. The EUT complies with IEEE 802.11g draft standards, and backwards compatible with IEEE 802.11b products.

3. The EUT must be supplied with a power adapter and following two different brands could be chosen:

Adapter 1:	
Brand:	FAIRWAY
Model No.:	VE15B-120
Input power :	100-240Vac 1.0A MAX 50-60Hz Input cable (unshielded, 1.8m)
Output power :	+12Vdc 1.5A
Adapter 2:	
Brand:	PHIHONG
Model No.:	PSA15W-120(NS)
Input power :	100-240Vac 0.4A , 50-60Hz Input cable (unshielded, 1.8m)
Output power :	12Vdc 1.25A

Note: The AC input cable of Adapter has four different plug types for US, EU, UK and AU.

4. The EUT has two antenna ports, one port only has Rx function, and the other port has Tx/Rx function (nearby the power port). There are three antennas provided to this EUT, please refer to the following table:

No.	Brand	Model No.	Gain (dBi)	Cable Loss	Antenna Type	Antenna Connector	Note
1	Arcadyan	120300009100J	2dBi	0dB	Dipole	RPSMA	Tx / Rx
2	Arcadyan	120300009300J	5dBi	3dB	Dipole	RPSMA	Tx / Rx
3	Arcadyan	FWM094505006J	6dBi	4dB	Directional	RPSMA	Tx / Rx

During the test, one antenna port which only has Rx function was connected Antenna 1 (Rx), and the other port was connected to Antenna 1~3 (Tx/Rx).

5. The above EUT information was declared by the manufacturer and for more detailed features description, please refer to the manufacturer's specifications or User's Manual.



3.2 DESCRIPTION OF TEST MODES

Eleven channels are provided in this EUT.

Channel	Frequency	Channel	Frequency
1	2412 MHz	7	2442 MHz
2	2417 MHz	8	2447 MHz
3	2422 MHz	9	2452 MHz
4	2427 MHz	10	2457 MHz
5	2432 MHz	11	2462 MHz
6	2437 MHz		

NOTE:

1. Below 1 GHz, the channel 1, 6, and 11 were pre-tested in chamber. The channel 11, worst case one, was chosen for final test.
2. Above 1 GHz, the channel 1, 6, and 11 were tested individually.
3. Transfer rate, 11Mbps with CCK technique and 6Mbps with OFDM technique, the worst case, were chosen for final test.
4. For Conducted Emission & Radiated Emissions tests (30MHz ~ 1GHz), the EUT was tested with two adapters.

3.3 GENERAL DESCRIPTION OF APPLIED STANDARDS

The EUT is a NetScreen-5GT ADSL Wireless. According to the specifications of the manufacturer, it must comply with the requirements of the following standards:

47 CFR Part 15, Subpart C. (15.247)
ANSI C63.4 : 2003

All tests have been performed and recorded as per the above standards.

NOTE: The EUT is also considered as a kind of computer peripheral, because the connection to computer is necessary for typical use. It has been verified to comply with the requirements of 47 CFR Part 15, Subpart B, Class B (DoC). The test report has been issued separately.



3.4 DESCRIPTION OF SUPPORT UNITS

The EUT has been tested as an independent unit together with other necessary accessories or support units. The following support units or accessories were used to form a representative test configuration during the tests.

No.	Product	Brand	Model No.	Serial No.	FCC ID
1	NOTEBOOK COMPUTER	DELL	C600	6DRV601	FCC DoC
2	CO-ROUTER	ZyXEL	IES-1000	S4Z3112558	NA
3	ADSL-ROUTER	Accton	AR5505AW-A-32	76NF3299EF4A4	NA

No.	Signal cable description
1	NA
2	NA
3	NA

Note: 1. All power cords of the above support units are unshielded (1.8m).

3.5 CONFIGURATION OF SYSTEM UNDER TEST

For Conducted Emission:

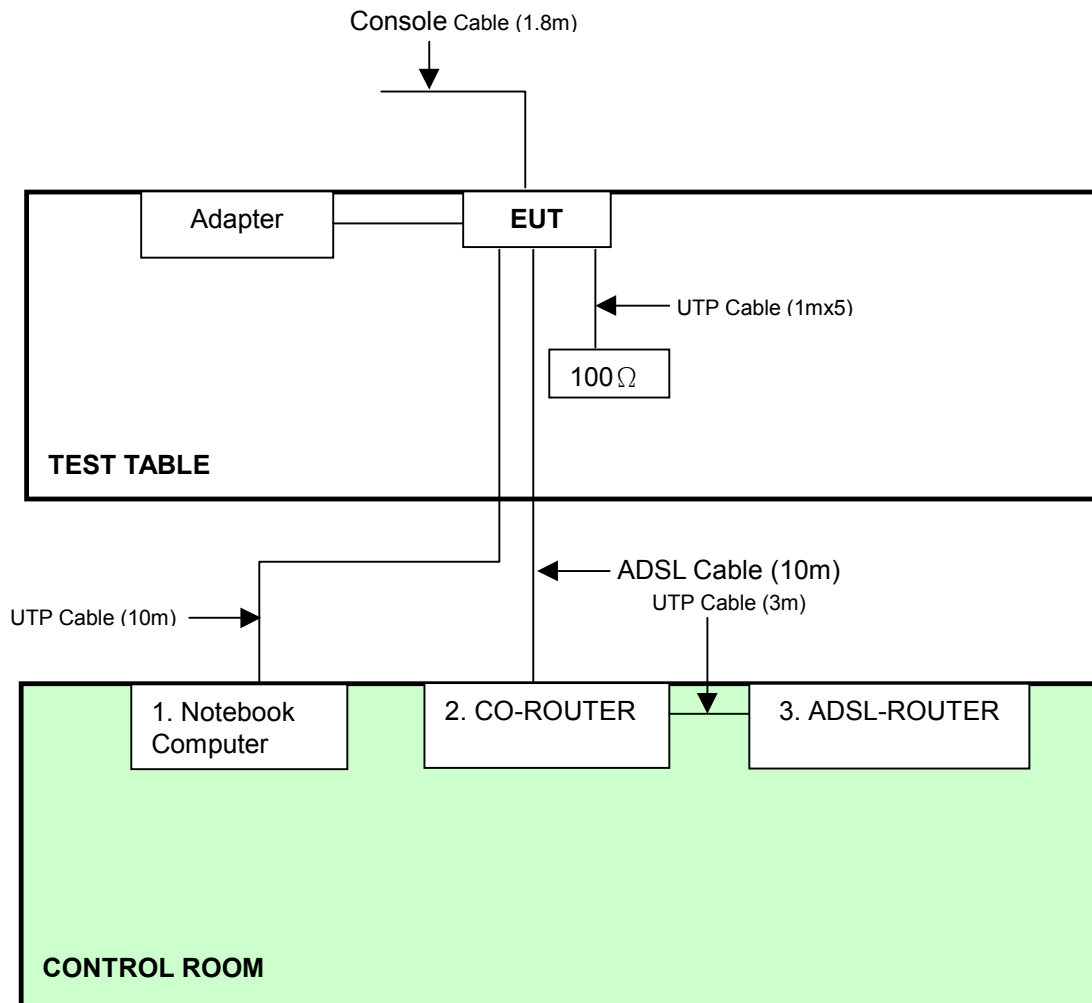

NOTE: 1. Support unit 1 ~ 3 were kept in the control room during the test.
 2. Please refer to the photos of test configuration in Item 5 also.

For Radiated Emission:

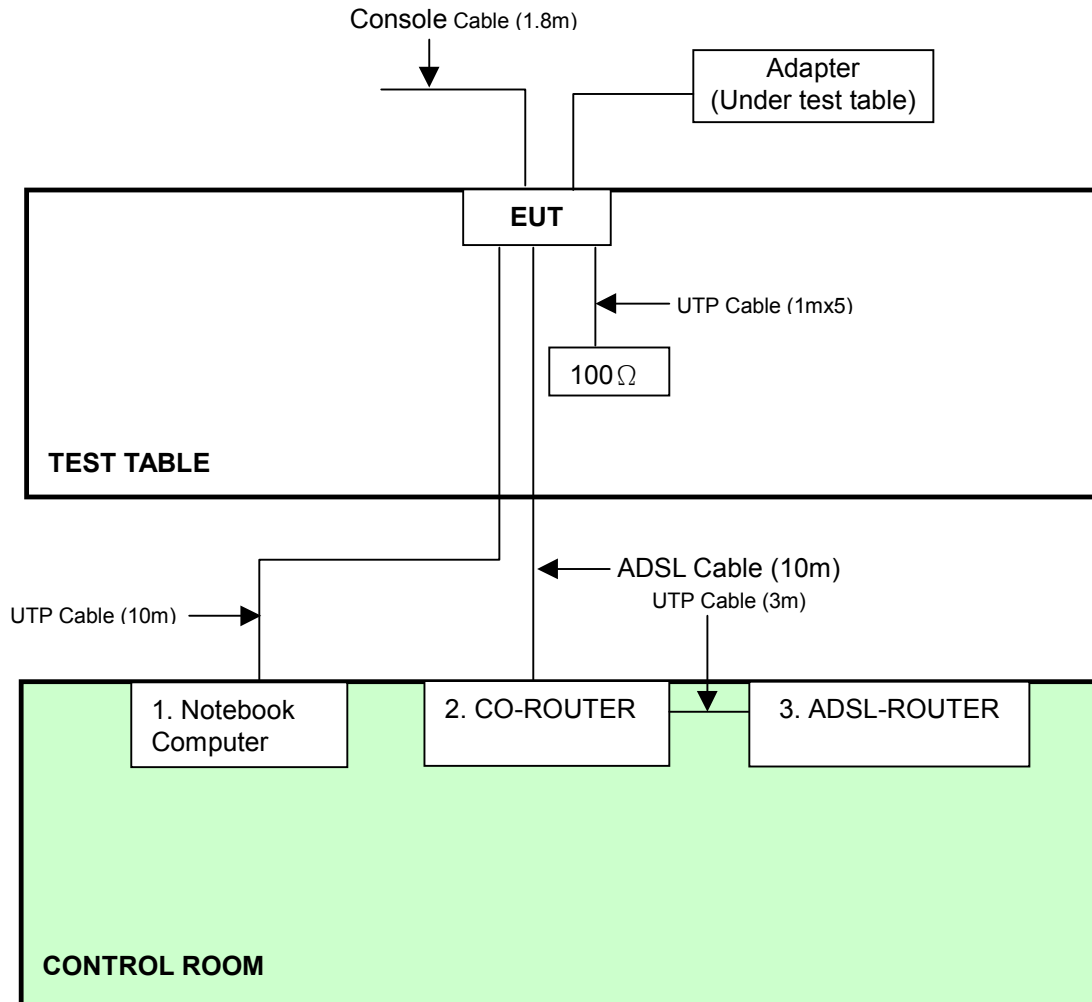

NOTE: 1. Support unit 1 ~ 3 were kept in the control room during the test.
 2. Please refer to the photos of test configuration in Item 5 also.



4 TEST TYPES AND RESULTS

4.1 CONDUCTED EMISSION MEASUREMENT

4.1.1 LIMITS OF CONDUCTED EMISSION MEASUREMENT

FREQUENCY OF EMISSION (MHz)	CONDUCTED LIMIT (dB μ V)	
	Quasi-peak	Average
0.15-0.5	66 to 56	56 to 46
0.5-5	56	46
5-30	60	50

NOTE:

1. The lower limit shall apply at the transition frequencies.
2. All emanations from a class B digital device or system, including any network of conductors and apparatus connected thereto, shall not exceed the level of field strengths specified above.

4.1.2 TEST INSTRUMENTS

DESCRIPTION & MANUFACTURER	MODEL NO.	SERIAL NO.	CALIBRATED UNTIL
ROHDE & SCHWARZ Test Receiver	ESCS 30	847124/029	Dec. 07, 2005
ROHDE & SCHWARZ LISN (for EUT)	ESHS-Z5	848773/004	Nov. 08, 2005
KYORITSU LISN (for peripheral)	KNW-407	8/1395/12	Jul. 23, 2005
RF Cable (JETBAO)	RG233/U	Cable_CA_01	Jul. 02, 2005
Terminator(for KYORITSU)	50	3	May 10, 2005
Software	Cond-V2e	NA	NA

NOTE:

1. The calibration interval of the above test instruments is 12 months and the calibrations are traceable to NML/ROC and NIST/USA.
2. The test was performed in ADT Shielded Room No. A.
3. The VCCI Con A Registration No. is C-817.
4. The measurement uncertainty is 2.53 dB, which is calculated as per the document CISPR 16-4

4.1.3 TEST PROCEDURES

- a. The EUT/HOST was placed 0.4 meters from the conducting wall of the shielded room with EUT/HOST being connected to the power mains through a line impedance stabilization network (LISN). Other support units were connected to the power mains through another LISN. The two LISNs provide 50 ohm/ 50uH of coupling impedance for the measuring instrument.
- b. Both lines of the power mains connected to the EUT/HOST were checked for maximum conducted interference.
- c. The frequency range from 150 kHz to 30 MHz was searched. Emission levels over 10dB under the prescribed limits could not be reported

4.1.4 TEST SETUP

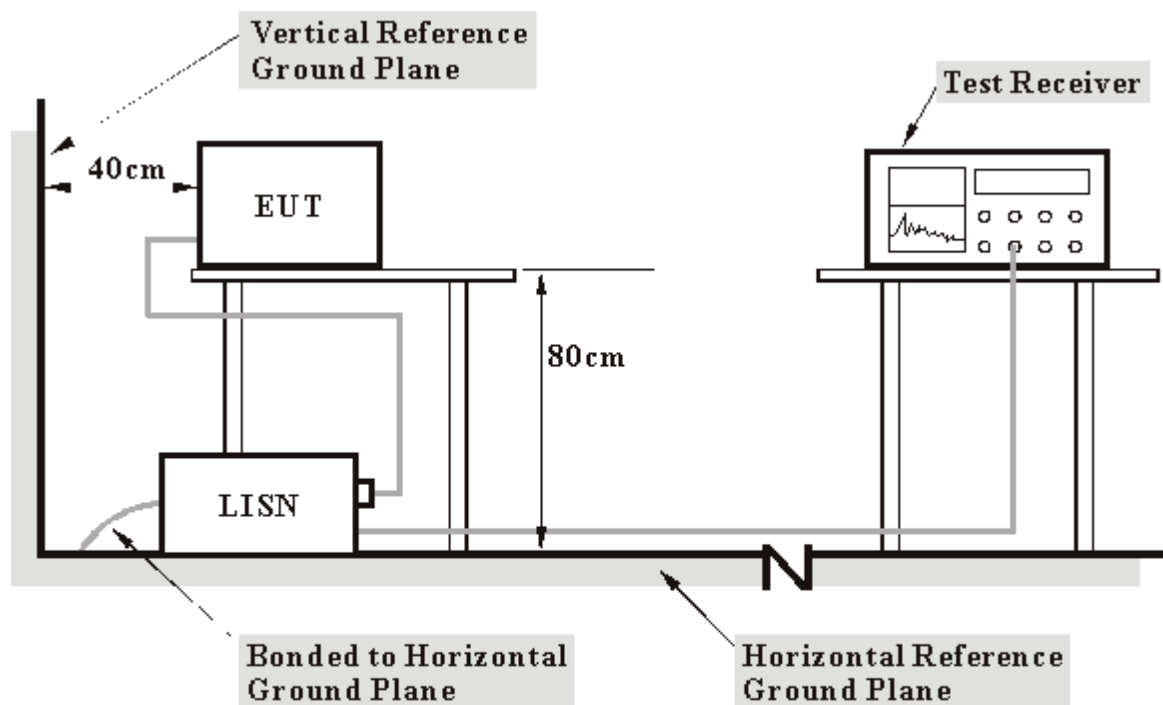

- Note:**
1. Support units were connected to second LISN.
 2. Both of LISNs (AMN) 80 cm from EUT and at the least 80 cm from other units and other metal planes support units.

For the actual test configuration, please refer to the related item – Photographs of the Test Configuration.



4.1.5 EUT OPERATING CONDITIONS

- a. Placed the EUT on the testing table.
- b. Prepared other computer systems (support unit 1 ~ 3) to act as a communication partner and placed them outside of testing area.
- c. The communication partner run test program "Hyperterminal" & "ART 485.exe" to enable EUT under transmission/receiving condition continuously at specific channel frequency via UTP cable and ADSL cable.



4.1.6 TEST RESULTS (With Adapter 1)

EUT	NetScreen-5GT ADSL Wireless	MODEL	NS-5GT-WIRELESS ADSL A
MODE	Channel 11	6dB BANDWIDTH	9 kHz
INPUT POWER (SYSTEM)	120Vac, 60 Hz	PHASE	Line (L)
ENVIRONMENTAL CONDITIONS	20 deg. C, 67%RH, 977 hPa	TESTED BY	Wen Yu

No	Freq. [MHz]	Corr. Factor (dB)	Reading Value		Emission Level		Limit		Margin	
			[dB (uV)]		[dB (uV)]		[dB (uV)]		(dB)	
			Q.P.	AV.	Q.P.	AV.	Q.P.	AV.	Q.P.	AV.
1	0.189	0.31	50.75	-	51.06	-	64.08	54.08	-13.02	-
2	0.255	0.32	40.57	-	40.89	-	61.58	51.58	-20.69	-
3	0.318	0.32	40.78	-	41.10	-	59.76	49.76	-18.66	-
4	0.443	0.34	35.52	-	35.86	-	57.01	47.01	-21.15	-
5	23.129	1.86	37.99	-	39.85	-	60.00	50.00	-20.15	-
6	25.000	1.90	41.06	-	42.96	-	60.00	50.00	-17.04	-

- REMARKS:**
1. Q.P. and AV. are abbreviations of quasi-peak and average individually.
 2. "-": The Quasi-peak reading value also meets average limit and measurement with the average detector is unnecessary.
 3. The emission levels of other frequencies were very low against the limit.
 4. Margin value = Emission level - Limit value
 5. Correction factor = Insertion loss + Cable loss
 6. Emission Level = Correction Factor + Reading Value.

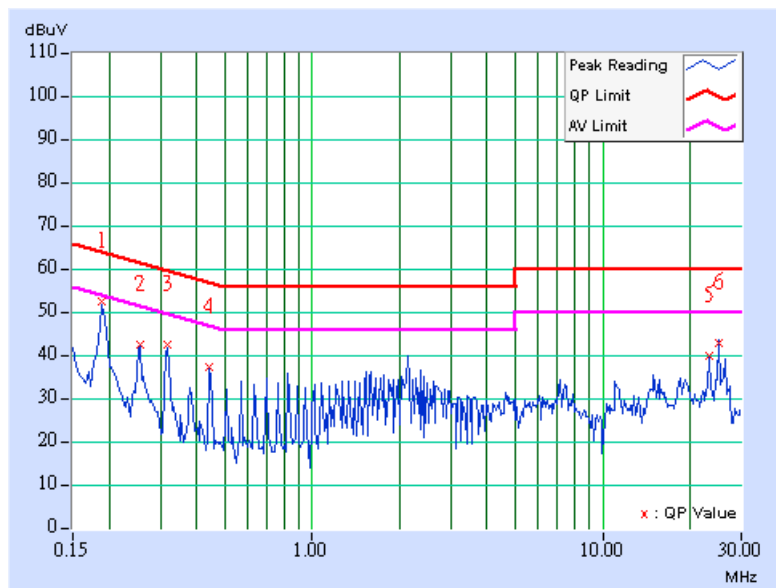



EUT	NetScreen-5GT ADSL Wireless	MODEL	NS-5GT-WIRELESS ADSL A
MODE	Channel 11	6dB BANDWIDTH	9 kHz
INPUT POWER (SYSTEM)	120Vac, 60 Hz	PHASE	Neutral (N)
ENVIRONMENTAL CONDITIONS	20 deg. C, 67%RH, 977 hPa	TESTED BY	Wen Yu

No	Freq. [MHz]	Corr. Factor (dB)	Reading Value		Emission Level		Limit		Margin	
			[dB (uV)]		[dB (uV)]		[dB (uV)]		(dB)	
			Q.P.	AV.	Q.P.	AV.	Q.P.	AV.	Q.P.	AV.
1	0.189	0.31	49.00	-	49.31	-	64.08	54.08	-14.77	-
2	0.255	0.32	39.30	-	39.62	-	61.58	51.58	-21.96	-
3	0.318	0.32	37.00	-	37.32	-	59.76	49.76	-22.44	-
4	0.822	0.39	34.47	-	34.86	-	56.00	46.00	-21.14	-
5	1.584	0.48	34.56	-	35.04	-	56.00	46.00	-20.96	-
6	25.000	1.70	40.52	-	42.22	-	60.00	50.00	-17.78	-

- REMARKS:**
1. Q.P. and AV. are abbreviations of quasi-peak and average individually.
 2. "-": The Quasi-peak reading value also meets average limit and measurement with the average detector is unnecessary.
 3. The emission levels of other frequencies were very low against the limit.
 4. Margin value = Emission level - Limit value
 5. Correction factor = Insertion loss + Cable loss
 6. Emission Level = Correction Factor + Reading Value.

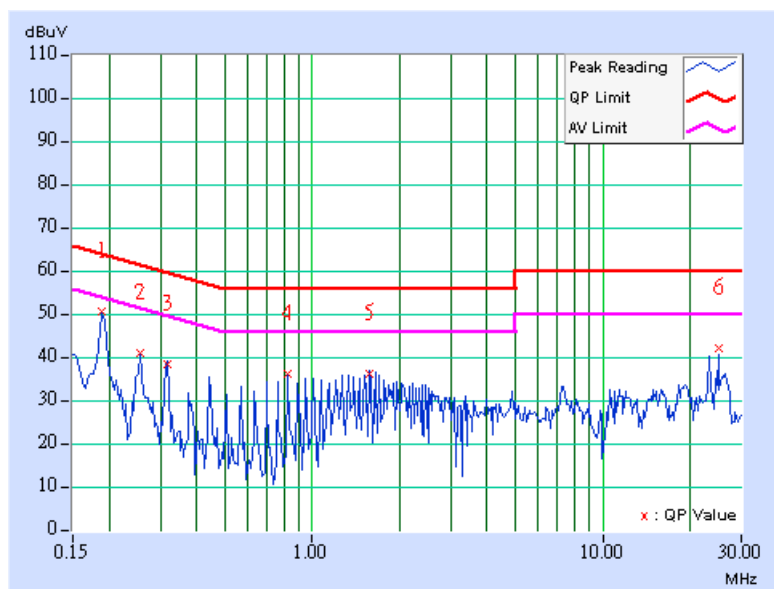



4.1.7 TEST RESULTS (With Adapter 2)

EUT	NetScreen-5GT ADSL Wireless	MODEL	NS-5GT-WIRELESS ADSL A
MODE	Channel 11	6dB BANDWIDTH	9 kHz
INPUT POWER (SYSTEM)	120Vac, 60 Hz	PHASE	Line (L)
ENVIRONMENTAL CONDITIONS	21 deg. C, 64%RH, 977 hPa	TESTED BY	Wen Yu

No	Freq. [MHz]	Corr. Factor (dB)	Reading Value		Emission Level		Limit		Margin	
			[dB (uV)]		[dB (uV)]		[dB (uV)]		(dB)	
			Q.P.	AV.	Q.P.	AV.	Q.P.	AV.	Q.P.	AV.
1	0.218	0.31	38.66	-	38.97	-	62.89	52.89	-23.92	-
2	0.552	0.35	37.87	-	38.22	-	56.00	46.00	-17.78	-
3	2.935	0.70	28.46	-	29.16	-	56.00	46.00	-26.84	-
4	5.254	0.97	28.78	-	29.75	-	60.00	50.00	-30.25	-
5	13.258	1.45	34.13	-	35.58	-	60.00	50.00	-24.42	-
6	27.156	1.92	31.72	-	33.64	-	60.00	50.00	-26.36	-

- REMARKS:**
1. Q.P. and AV. are abbreviations of quasi-peak and average individually.
 2. "-": The Quasi-peak reading value also meets average limit and measurement with the average detector is unnecessary.
 3. The emission levels of other frequencies were very low against the limit.
 4. Margin value = Emission level - Limit value
 5. Correction factor = Insertion loss + Cable loss
 6. Emission Level = Correction Factor + Reading Value.

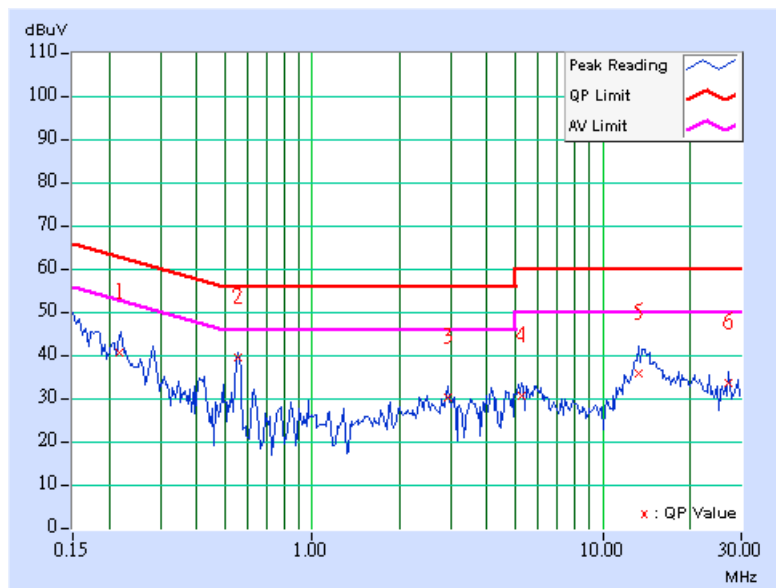



EUT	NetScreen-5GT ADSL Wireless	MODEL	NS-5GT-WIRELESS ADSL A
MODE	Channel 11	6dB BANDWIDTH	9 kHz
INPUT POWER (SYSTEM)	120Vac, 60 Hz	PHASE	Neutral (N)
ENVIRONMENTAL CONDITIONS	21 deg. C, 64%RH, 977 hPa	TESTED BY	Wen Yu

No	Freq. [MHz]	Corr. Factor (dB)	Reading Value		Emission Level		Limit		Margin	
			[dB (uV)]		[dB (uV)]		[dB (uV)]		(dB)	
			Q.P.	AV.	Q.P.	AV.	Q.P.	AV.	Q.P.	AV.
1	0.213	0.31	38.47	-	38.78	-	63.11	53.11	-24.33	-
2	0.412	0.33	36.10	-	36.43	-	57.61	47.61	-21.18	-
3	0.552	0.35	37.29	-	37.64	-	56.00	46.00	-18.36	-
4	2.916	0.69	27.84	-	28.53	-	56.00	46.00	-27.47	-
5	5.719	0.97	28.32	-	29.29	-	60.00	50.00	-30.71	-
6	13.766	1.37	35.41	-	36.78	-	60.00	50.00	-23.22	-

- REMARKS:**
1. Q.P. and AV. are abbreviations of quasi-peak and average individually.
 2. "-": The Quasi-peak reading value also meets average limit and measurement with the average detector is unnecessary.
 3. The emission levels of other frequencies were very low against the limit.
 4. Margin value = Emission level - Limit value
 5. Correction factor = Insertion loss + Cable loss
 6. Emission Level = Correction Factor + Reading Value.

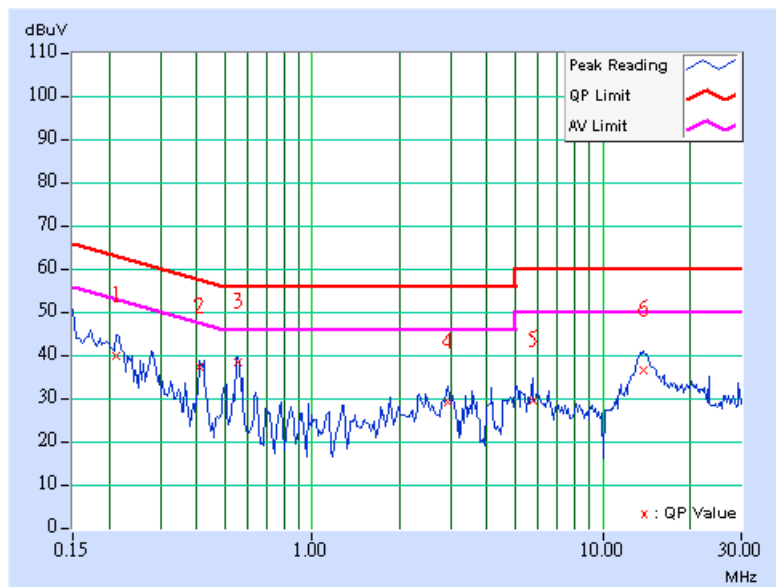



4.2 RADIATED EMISSION MEASUREMENT

4.2.1 LIMITS OF RADIATED EMISSION MEASUREMENT

Field strength limits are at the distance of 3 meters, emissions radiated outside of the specified bands, shall be according to the general radiated limits in 15.209 as following:

Frequencies (MHz)	Field strength (microvolts/meter)	Measurement distance (meters)
0.009-0.490	2400/F(kHz)	300
0.490-1.705	24000/F(kHz)	30
1.705-30.0	30	30
30-88	100	3
88-216	150	3
216-960	200	3
Above 960	500	3

NOTE:

1. The lower limit shall apply at the transition frequencies.
2. Emission level (dBuV/m) = 20 log Emission level (uV/m).
3. As shown in 15.35(b), for frequencies above 1000MHz, the field strength limits are based on average detector, however, the peak field strength of any emission shall not exceed the maximum permitted average limits, specified above by more than 20dB under any condition of modulation.



4.2.2 TEST INSTRUMENTS

DESCRIPTION & MANUFACTURER	MODEL NO.	SERIAL NO.	CALIBRATED UNTIL
HP Spectrum Analyzer	8594E	3710A04861	Sep. 23, 2005
ADVANTEST Spectrum Analyzer	R3271A	85060311	Jun. 29, 2005
CHASE RF Pre_Amplifier	CPA9232	1057	Aug 06, 2005
HP Pre_Amplifier	8449B	3008A01922	Oct. 13, 2005
ROHDE & SCHWARZ Test Receiver	ESCS30	100287	Dec. 08, 2005
CHASE Broadband Antenna	VULB9168	138	May 22, 2005
Schwarzbeck Horn_Antenna	BBHA9120	D124	Jun. 16, 2005
Schwarzbeck Horn_Antenna	BBHA 9170	BBHA9170192	Feb. 16, 2005
SCHWARZBECK Tunable Dipole Antenna	UHAP	897	Mar. 07, 2005
SCHWARZBECK Tunable Dipole Antenna	VHAP	880	Mar. 07, 2005
RF Switches (ARNITSU)	CS-201	1565157	Jul. 15, 2005
RF CABLE (Chaintek) 1GHz-20GHz	SF102	22054-2	Feb. 10. 2005
RF Cable(RICHTEC)	9913-30M	STCCAB-30M- 1GHz-021	Jul. 15, 2005
Software	AS60P8	NA	NA
CHANCE MOST Antenna Tower	AT-100	0203	NA
CHANCE MOST Turn Table	TT-100	0203	NA

Note: 1. The calibration interval of the above test instruments is 12 months (36 months for Tunable Dipole Antenna) and the calibrations are traceable to NML/ROC and NIST/USA.

2. The horn antenna and HP preamplifier (model: 8449B) are used only for the measurement of emission frequency above 1GHz if tested.
3. The test was performed in ADT Open Site No. C.
4. The FCC Site Registration No. is 656396.
5. The VCCI Site Registration No. is R-1626.
6. The CANADA Site Registration No. is IC 4824-3.
7. The following table is for the measurement uncertainty, which is calculated as per the document CISPR 16-4.

Measurement	Value
Radiated emissions (30MHz-1GHz)	2.98 dB
Radiated emissions (1GHz ~18GHz)	2.21 dB
Radiated emissions (18GHz ~20GHz)	1.88 dB



4.2.3 TEST PROCEDURES

- a. The EUT was placed on the top of a rotating table 0.8 meters above the ground at a 10 meter open area test site. The table was rotated 360 degrees to determine the position of the highest radiation.
- b. The EUT was set 3 meters away from the interference-receiving antenna, which was mounted on the top of a variable-height antenna tower.
- c. The antenna is a broadband antenna, and its height is varied from one meter to four meters above the ground to determine the maximum value of the field strength. Both horizontal and vertical polarizations of the antenna are set to make the measurement.
- d. For each suspected emission, the EUT was arranged to its worst case and then the antenna was tuned to heights from 1 meter to 4 meters and the rotatable table was turned from 0 degrees to 360 degrees to find the maximum reading.
- e. The test-receiver system was set to Peak Detect Function and Specified Bandwidth with Maximum Hold Mode.
- f. If the emission level of the EUT in peak mode was 10 dB lower than the limit specified, then testing could be stopped and the peak values of the EUT would be reported. Otherwise the emissions that did not have 10 dB margin would be re-tested one by one using peak, quasi-peak or average method as specified and then reported in a data sheet.

NOTE:

1. The resolution bandwidth and video bandwidth of test receiver/spectrum analyzer is 120kHz for Peak detection (PK) and Quasi-peak detection (QP) at frequency below 1GHz.
2. The resolution bandwidth and video bandwidth of test receiver/spectrum analyzer is 1 MHz for Peak detection at frequency above 1GHz.
3. The resolution bandwidth of test receiver/spectrum analyzer is 1 MHz and the video bandwidth is 300 Hz for Average detection (AV) at frequency above 1GHz.

4.2.4 TEST SETUP

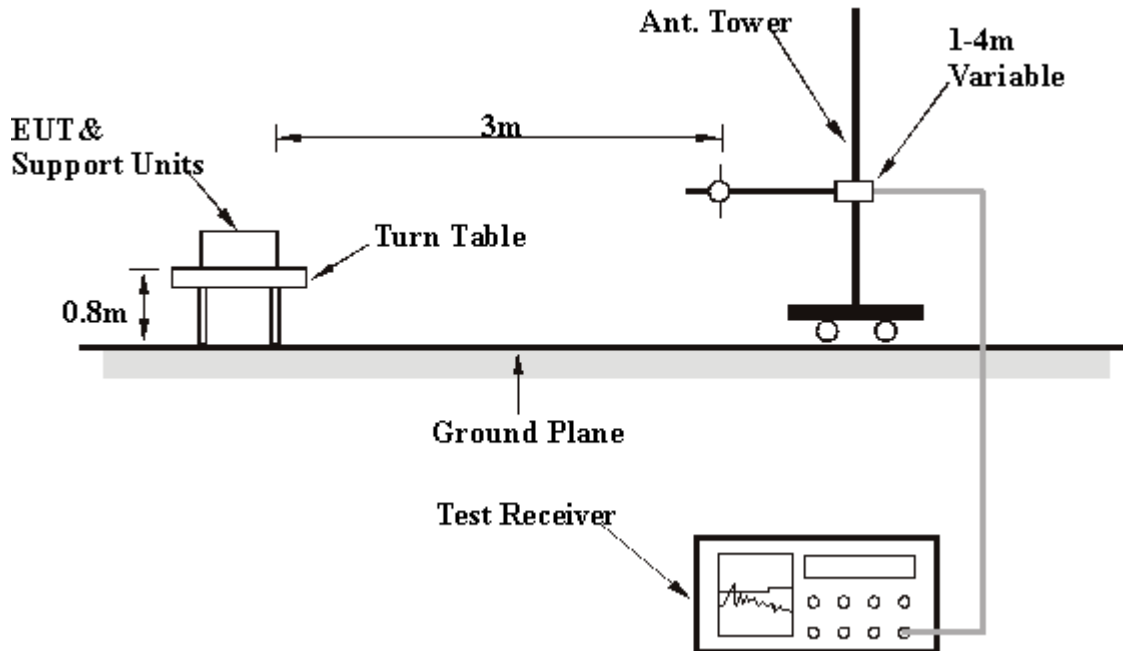

For the actual test configuration, please refer to the related item – Photographs of the Test Configuration.

4.2.5 EUT OPERATING CONDITIONS

Same as 4.1.5.

4.2.6 TEST RESULTS (ANTENNA 1 – Adapter 1)

EUT	NetScreen-5GT ADSL Wireless	MODEL	NS-5GT-WIRELESS ADSL A
MODE	Channel 11	FREQUENCY RANGE	30-1000 MHz
INPUT POWER (SYSTEM)	120Vac, 60 Hz	DETECTOR FUNCTION & BANDWIDTH	Quasi-Peak, 120kHz
ENVIRONMENTAL CONDITIONS	25 deg. C, 64%RH, 977 hPa	TESTED BY	Sky Liao

ANTENNA POLARITY & TEST DISTANCE: HORIZONTAL AT 3 M

No.	Freq. (MHz)	Emission Level (dBuV/m)	Limit (dBuV/m)	Margin (dB)	Antenna Height (m)	Table Angle (Degree)	Raw Value (dBuV)	Correction Factor (dB/m)
1	125.00	30.90 QP	43.50	-12.60	2.04 H	333	18.40	12.50
2	360.00	39.30 QP	46.00	-6.70	1.17 H	59	22.20	17.10
3	400.00	39.00 QP	46.00	-7.00	1.21 H	88	20.60	18.40
4	500.00	37.50 QP	46.00	-8.50	1.07 H	193	16.80	20.70
5	625.00	34.50 QP	46.00	-11.50	1.37 H	37	11.60	22.90
6	750.00	40.40 QP	46.00	-5.60	1.17 H	306	14.30	26.10
7	825.75	40.80 QP	46.00	-5.20	1.12 H	22	14.40	26.40
8	900.00	40.40 QP	46.00	-5.60	1.28 H	14	12.90	27.50

ANTENNA POLARITY & TEST DISTANCE: VERTICAL AT 3 M

No.	Freq. (MHz)	Emission Level (dBuV/m)	Limit (dBuV/m)	Margin (dB)	Antenna Height (m)	Table Angle (Degree)	Raw Value (dBuV)	Correction Factor (dB/m)
1	125.00	34.10 QP	43.50	-9.40	1.01 V	52	21.60	12.50
2	200.00	33.00 QP	43.50	-10.50	1.00 V	129	23.40	9.60
3	343.26	34.80 QP	46.00	-11.20	1.04 V	89	18.20	16.60
4	360.00	37.20 QP	46.00	-8.80	1.10 V	357	20.10	17.10
5	400.00	37.60 QP	46.00	-8.40	1.00 V	314	19.20	18.40
6	500.00	36.90 QP	46.00	-9.10	1.02 V	219	16.20	20.70
7	625.00	34.10 QP	46.00	-11.90	1.06 V	27	11.20	22.90
8	750.00	33.50 QP	46.00	-12.50	1.00 V	235	7.40	26.10
9	825.75	35.90 QP	46.00	-10.10	1.03 V	14	9.50	26.40
10	900.00	38.40 QP	46.00	-7.60	1.00 V	234	10.90	27.50

- REMARKS:**
1. Emission level(dBuV/m)=Raw Value(dBuV) + Correction Factor(dB/m)
 2. Correction Factor(dB/m) = Antenna Factor (dB/m) + Cable Factor (dB)
 3. The other emission levels were very low against the limit.
 4. Margin value = Emission level – Limit value.

4.2.7 TEST RESULTS (ANTENNA 2 – Adapter 1)

EUT	NetScreen-5GT ADSL Wireless	MODEL	NS-5GT-WIRELESS ADSL A
MODE	Channel 11	FREQUENCY RANGE	30-1000 MHz
INPUT POWER (SYSTEM)	120Vac, 60 Hz	DETECTOR FUNCTION & BANDWIDTH	Quasi-Peak, 120kHz
ENVIRONMENTAL CONDITIONS	25 deg. C, 64%RH, 977 hPa	TESTED BY	Sky Liao

ANTENNA POLARITY & TEST DISTANCE: HORIZONTAL AT 3 M

No.	Freq. (MHz)	Emission Level (dBuV/m)	Limit (dBuV/m)	Margin (dB)	Antenna Height (m)	Table Angle (Degree)	Raw Value (dBuV)	Correction Factor (dB/m)
1	125.00	33.50 QP	43.50	-10.00	2.34 H	353	21.00	12.50
2	360.00	38.70 QP	46.00	-7.30	1.35 H	68	21.60	17.10
3	400.00	38.80 QP	46.00	-7.20	1.22 H	51	20.40	18.40
4	500.00	37.90 QP	46.00	-8.10	1.01 H	168	17.20	20.70
5	625.00	37.20 QP	46.00	-8.80	1.58 H	48	14.30	22.90
6	750.00	40.50 QP	46.00	-5.50	1.21 H	348	14.40	26.10
7	825.75	40.30 QP	46.00	-5.70	1.18 H	31	13.90	26.40
8	900.00	40.10 QP	46.00	-5.90	1.34 H	7	12.60	27.50

ANTENNA POLARITY & TEST DISTANCE: VERTICAL AT 3 M

No.	Freq. (MHz)	Emission Level (dBuV/m)	Limit (dBuV/m)	Margin (dB)	Antenna Height (m)	Table Angle (Degree)	Raw Value (dBuV)	Correction Factor (dB/m)
1	125.00	35.00 QP	43.50	-8.50	1.01 V	43	22.50	12.50
2	200.00	33.60 QP	43.50	-9.90	1.00 V	139	24.00	9.60
3	343.26	35.80 QP	46.00	-10.20	1.01 V	100	19.20	16.60
4	360.00	37.50 QP	46.00	-8.50	1.10 V	336	20.40	17.10
5	400.00	37.80 QP	46.00	-8.20	1.01 V	249	19.40	18.40
6	500.00	36.90 QP	46.00	-9.10	1.02 V	253	16.20	20.70
7	625.00	33.90 QP	46.00	-12.10	1.01 V	17	11.00	22.90
8	750.00	32.90 QP	46.00	-13.10	1.06 V	201	6.80	26.10
9	825.75	36.30 QP	46.00	-9.70	1.03 V	12	9.90	26.40
10	900.00	37.90 QP	46.00	-8.10	1.06 V	234	10.40	27.50

- REMARKS:**
1. Emission level(dBuV/m)=Raw Value(dBuV) + Correction Factor(dB/m)
 2. Correction Factor(dB/m) = Antenna Factor (dB/m) + Cable Factor (dB)
 3. The other emission levels were very low against the limit.
 4. Margin value = Emission level – Limit value.



4.2.8 TEST RESULTS (ANTENNA 3 – Adapter 1)

EUT	NetScreen-5GT ADSL Wireless	MODEL	NS-5GT-WIRELESS ADSL A
MODE	Channel 11	FREQUENCY RANGE	30-1000 MHz
INPUT POWER (SYSTEM)	120Vac, 60 Hz	DETECTOR FUNCTION & BANDWIDTH	Quasi-Peak, 120kHz
ENVIRONMENTAL CONDITIONS	25 deg. C, 64%RH, 977 hPa	TESTED BY	Sky Liao

ANTENNA POLARITY & TEST DISTANCE: HORIZONTAL AT 3 M

No.	Freq. (MHz)	Emission Level (dBuV/m)	Limit (dBuV/m)	Margin (dB)	Antenna Height (m)	Table Angle (Degree)	Raw Value (dBuV)	Correction Factor (dB/m)
1	125.00	30.20 QP	43.50	-13.30	2.21 H	349	17.70	12.50
2	360.00	39.10 QP	46.00	-6.90	1.17 H	103	22.00	17.10
3	400.00	39.30 QP	46.00	-6.70	1.14 H	43	20.90	18.40
4	500.00	37.90 QP	46.00	-8.10	1.17 H	163	17.20	20.70
5	625.00	35.70 QP	46.00	-10.30	1.34 H	53	12.80	22.90
6	750.00	40.50 QP	46.00	-5.50	1.18 H	334	14.40	26.10
7	825.74	40.60 QP	46.00	-5.40	1.11 H	37	14.20	26.40
8	900.02	40.10 QP	46.00	-5.90	1.09 H	24	12.60	27.50

ANTENNA POLARITY & TEST DISTANCE: VERTICAL AT 3 M

No.	Freq. (MHz)	Emission Level (dBuV/m)	Limit (dBuV/m)	Margin (dB)	Antenna Height (m)	Table Angle (Degree)	Raw Value (dBuV)	Correction Factor (dB/m)
1	125.00	34.90 QP	43.50	-8.60	1.00 V	21	22.40	12.50
2	200.00	33.10 QP	43.50	-10.40	1.00 V	131	23.50	9.60
3	343.30	36.10 QP	46.00	-9.90	1.03 V	105	19.50	16.60
4	360.00	38.20 QP	46.00	-7.80	1.29 V	301	21.10	17.10
5	400.00	36.20 QP	46.00	-9.80	1.00 V	218	17.80	18.40
6	500.00	36.80 QP	46.00	-9.20	1.01 V	237	16.10	20.70
7	624.99	33.10 QP	46.00	-12.90	1.00 V	13	10.20	22.90
8	750.00	34.40 QP	46.00	-11.60	1.02 V	214	8.30	26.10
9	825.75	35.30 QP	46.00	-10.70	1.01 V	3	8.90	26.40
10	900.00	39.20 QP	46.00	-6.80	1.08 V	234	11.70	27.50

- REMARKS:**
1. Emission level(dBuV/m)=Raw Value(dBuV) + Correction Factor(dB/m)
 2. Correction Factor(dB/m) = Antenna Factor (dB/m) + Cable Factor (dB)
 3. The other emission levels were very low against the limit.
 4. Margin value = Emission level – Limit value.

4.2.9 TEST RESULTS (ANTENNA 1 – Adapter 2)

EUT	NetScreen-5GT ADSL Wireless	MODEL	NS-5GT-WIRELESS ADSL A
MODE	Channel 11	FREQUENCY RANGE	30-1000 MHz
INPUT POWER (SYSTEM)	120Vac, 60 Hz	DETECTOR FUNCTION & BANDWIDTH	Quasi-Peak, 120kHz
ENVIRONMENTAL CONDITIONS	25 deg. C, 64%RH, 977 hPa	TESTED BY	Sky Liao

ANTENNA POLARITY & TEST DISTANCE: HORIZONTAL AT 3 M

No.	Freq. (MHz)	Emission Level (dBuV/m)	Limit (dBuV/m)	Margin (dB)	Antenna Height (m)	Table Angle (Degree)	Raw Value (dBuV)	Correction Factor (dB/m)
1	125.00	29.10 QP	43.50	-14.40	2.34 H	356	16.60	12.50
2	360.00	40.10 QP	46.00	-5.90	1.22 H	64	23.00	17.10
3	400.00	39.60 QP	46.00	-6.40	1.06 H	48	21.20	18.40
4	500.00	37.80 QP	46.00	-8.20	1.08 H	168	17.10	20.70
5	625.00	34.10 QP	46.00	-11.90	1.34 H	2	11.20	22.90
6	750.00	40.50 QP	46.00	-5.50	1.27 H	312	14.40	26.10
7	825.75	40.90 QP	46.00	-5.10	1.07 H	69	14.50	26.40
8	900.00	40.60 QP	46.00	-5.40	1.15 H	21	13.10	27.50

ANTENNA POLARITY & TEST DISTANCE: VERTICAL AT 3 M

No.	Freq. (MHz)	Emission Level (dBuV/m)	Limit (dBuV/m)	Margin (dB)	Antenna Height (m)	Table Angle (Degree)	Raw Value (dBuV)	Correction Factor (dB/m)
1	125.00	33.40 QP	43.50	-10.10	1.03 V	28	20.90	12.50
2	200.00	34.60 QP	43.50	-8.90	1.00 V	148	25.00	9.60
3	343.26	34.60 QP	46.00	-11.40	1.00 V	100	18.00	16.60
4	360.00	38.60 QP	46.00	-7.40	1.00 V	327	21.50	17.10
5	400.00	37.00 QP	46.00	-9.00	1.00 V	328	18.60	18.40
6	500.00	37.00 QP	46.00	-9.00	1.04 V	265	16.30	20.70
7	625.00	33.90 QP	46.00	-12.10	1.03 V	48	11.00	22.90
8	750.00	34.30 QP	46.00	-11.70	1.00 V	210	8.20	26.10
9	825.75	37.80 QP	46.00	-8.20	1.00 V	61	11.40	26.40
10	900.00	38.40 QP	46.00	-7.60	1.00 V	186	10.90	27.50

- REMARKS:**
1. Emission level(dBuV/m)=Raw Value(dBuV) + Correction Factor(dB/m)
 2. Correction Factor(dB/m) = Antenna Factor (dB/m) + Cable Factor (dB)
 3. The other emission levels were very low against the limit.
 4. Margin value = Emission level – Limit value.



4.2.10 TEST RESULTS (ANTENNA 2 – Adapter 2)

EUT	NetScreen-5GT ADSL Wireless	MODEL	NS-5GT-WIRELESS ADSL A
MODE	Channel 11	FREQUENCY RANGE	30-1000 MHz
INPUT POWER (SYSTEM)	120Vac, 60 Hz	DETECTOR FUNCTION & BANDWIDTH	Quasi-Peak, 120kHz
ENVIRONMENTAL CONDITIONS	25 deg. C, 64%RH, 977 hPa	TESTED BY	Sky Liao

ANTENNA POLARITY & TEST DISTANCE: HORIZONTAL AT 3 M

No.	Freq. (MHz)	Emission Level (dBuV/m)	Limit (dBuV/m)	Margin (dB)	Antenna Height (m)	Table Angle (Degree)	Raw Value (dBuV)	Correction Factor (dB/m)
1	125.00	32.30 QP	43.50	-11.20	2.27 H	351	19.80	12.50
2	360.00	39.50 QP	46.00	-6.50	1.21 H	61	22.40	17.10
3	400.00	39.00 QP	46.00	-7.00	1.12 H	45	20.60	18.40
4	500.00	38.20 QP	46.00	-7.80	1.21 H	166	17.50	20.70
5	625.00	35.70 QP	46.00	-10.30	1.31 H	28	12.80	22.90
6	750.00	39.90 QP	46.00	-6.10	1.31 H	352	13.80	26.10
7	825.75	40.20 QP	46.00	-5.80	1.33 H	341	13.80	26.40
8	900.00	40.30 QP	46.00	-5.70	1.28 H	348	12.80	27.50

ANTENNA POLARITY & TEST DISTANCE: VERTICAL AT 3 M

No.	Freq. (MHz)	Emission Level (dBuV/m)	Limit (dBuV/m)	Margin (dB)	Antenna Height (m)	Table Angle (Degree)	Raw Value (dBuV)	Correction Factor (dB/m)
1	125.00	35.30 QP	43.50	-8.20	1.00 V	51	22.80	12.50
2	200.00	35.40 QP	43.50	-8.10	1.00 V	98	25.80	9.60
3	343.26	35.30 QP	46.00	-10.70	1.01 V	127	18.70	16.60
4	360.00	37.20 QP	46.00	-8.80	1.00 V	355	20.10	17.10
5	400.00	38.10 QP	46.00	-7.90	1.00 V	328	19.70	18.40
6	500.00	37.50 QP	46.00	-8.50	1.02 V	217	16.80	20.70
7	625.00	35.90 QP	46.00	-10.10	1.12 V	29	13.00	22.90
8	750.00	34.90 QP	46.00	-11.10	1.02 V	234	8.80	26.10
9	825.75	38.20 QP	46.00	-7.80	1.08 V	52	11.80	26.40
10	900.00	39.40 QP	46.00	-6.60	1.05 V	234	11.90	27.50

- REMARKS:**
1. Emission level(dBuV/m)=Raw Value(dBuV) + Correction Factor(dB/m)
 2. Correction Factor(dB/m) = Antenna Factor (dB/m) + Cable Factor (dB)
 3. The other emission levels were very low against the limit.
 4. Margin value = Emission level – Limit value.



4.2.11 TEST RESULTS (ANTENNA 3 – Adapter 2)

EUT	NetScreen-5GT ADSL Wireless	MODEL	NS-5GT-WIRELESS ADSL A
MODE	Channel 11	FREQUENCY RANGE	30-1000 MHz
INPUT POWER (SYSTEM)	120Vac, 60 Hz	DETECTOR FUNCTION & BANDWIDTH	Quasi-Peak, 120kHz
ENVIRONMENTAL CONDITIONS	25 deg. C, 64%RH, 977 hPa	TESTED BY	Sky Liao

ANTENNA POLARITY & TEST DISTANCE: HORIZONTAL AT 3 M

No.	Freq. (MHz)	Emission Level (dBuV/m)	Limit (dBuV/m)	Margin (dB)	Antenna Height (m)	Table Angle (Degree)	Raw Value (dBuV)	Correction Factor (dB/m)
1	125.00	27.50 QP	43.50	-16.00	2.42 H	238	15.10	12.50
2	200.00	24.30 QP	43.50	-19.20	1.87 H	92	14.70	9.60
3	250.00	25.10 QP	46.00	-20.90	1.47 H	224	11.10	14.00
4	360.00	38.20 QP	46.00	-7.80	1.14 H	85	21.10	17.10
5	400.00	38.80 QP	46.00	-7.20	1.08 H	42	20.40	18.40
6	500.00	36.90 QP	46.00	-9.10	1.02 H	162	16.20	20.70
7	625.00	33.60 QP	46.00	-12.40	1.35 H	341	10.70	22.90
8	750.00	40.30 QP	46.00	-5.70	1.13 H	335	14.20	26.10
9	825.74	40.30 QP	46.00	-5.70	1.17 H	42	13.90	26.40
10	900.02	40.10 QP	46.00	-5.90	1.02 H	38	12.60	27.50

ANTENNA POLARITY & TEST DISTANCE: VERTICAL AT 3 M

No.	Freq. (MHz)	Emission Level (dBuV/m)	Limit (dBuV/m)	Margin (dB)	Antenna Height (m)	Table Angle (Degree)	Raw Value (dBuV)	Correction Factor (dB/m)
1	125.00	34.30 QP	43.50	-9.20	1.00 V	357	21.80	12.50
2	160.00	29.60 QP	43.50	-13.90	1.01 V	317	18.30	11.40
3	200.00	30.20 QP	43.50	-13.30	1.02 V	152	20.60	9.60
4	250.00	27.90 QP	46.00	-18.10	1.31 V	158	13.90	14.00
5	343.26	33.80 QP	46.00	-12.20	1.00 V	149	17.30	16.60
6	360.01	38.30 QP	46.00	-7.70	1.18 V	314	21.20	17.10
7	375.00	32.40 QP	46.00	-13.60	1.08 V	135	14.90	17.60
8	400.00	35.80 QP	46.00	-10.20	1.02 V	238	17.40	18.40
9	500.00	35.60 QP	46.00	-10.40	1.38 V	141	14.90	20.70
10	624.99	32.30 QP	46.00	-13.70	1.05 V	32	9.40	22.90
11	750.00	33.40 QP	46.00	-12.60	1.02 V	242	7.20	26.10
12	825.75	34.20 QP	46.00	-11.80	1.00 V	355	7.80	26.40
13	900.01	38.80 QP	46.00	-7.20	1.02 V	243	11.30	27.50

- REMARKS:**
1. Emission level(dBuV/m)=Raw Value(dBuV) + Correction Factor(dB/m)
 2. Correction Factor(dB/m) = Antenna Factor (dB/m) + Cable Factor (dB)
 3. The other emission levels were very low against the limit.
 4. Margin value = Emission level – Limit value.



4.2.12 TEST RESULTS (ANTENNA 1 – DSSS)

EUT	NetScreen-5GT ADSL Wireless	MODEL	NS-5GT-WIRELESS ADSL A
MODE	Channel 1	FREQUENCY RANGE	1000~25000MHz
INPUT POWER (SYSTEM)	120Vac, 60 Hz	DETECTOR FUNCTION & BANDWIDTH	Peak (PK) Average (AV) 1 MHz
ENVIRONMENTAL CONDITIONS	26 deg. C, 66%RH, 977 hPa	TESTED BY	Sky Liao

ANTENNA POLARITY & TEST DISTANCE: HORIZONTAL AT 3 M

No.	Freq. (MHz)	Emission Level (dBuV/m)	Limit (dBuV/m)	Margin (dB)	Antenna Height (m)	Table Angle (Degree)	Raw Value (dBuV)	Correction Factor (dB/m)
1	2387.00	50.00 PK	74.00	-24.00	1.00 H	31	17.10	32.90
1	2387.00	42.80 AV	54.00	-11.20	1.00 H	31	9.90	32.90
2	2390.00	48.30 PK	74.00	-25.70	1.00 H	31	14.50	33.80
2	2390.00	41.10 AV	54.00	-12.90	1.00 H	31	7.30	33.80
3	*2412.00	103.70 PK			1.00 H	31	73.80	29.90
3	*2412.00	97.00 AV			1.00 H	31	67.10	29.90
4	2688.00	37.30 PK	74.00	-36.70	1.29 H	138	6.40	30.90
4	2688.00	27.10 AV	54.00	-26.90	1.29 H	138	-3.80	30.90
5	4824.00	46.90 PK	74.00	-27.10	1.10 H	52	10.70	36.20
5	4824.00	35.70 AV	54.00	-18.30	1.10 H	52	-0.50	36.20
6	7236.00	51.30 PK	74.00	-22.70	1.24 H	61	9.60	41.70
6	7236.00	40.50 AV	54.00	-13.50	1.24 H	61	-1.20	41.70

ANTENNA POLARITY & TEST DISTANCE: VERTICAL AT 3 M

No.	Freq. (MHz)	Emission Level (dBuV/m)	Limit (dBuV/m)	Margin (dB)	Antenna Height (m)	Table Angle (Degree)	Raw Value (dBuV)	Correction Factor (dB/m)
1	2387.00	60.10 PK	74.00	-13.90	1.00 V	7	27.30	32.90
1	2387.00	53.00 AV	54.00	-1.00	1.00 V	7	20.10	32.90
2	2390.00	58.50 PK	74.00	-15.50	1.00 V	7	24.70	33.80
2	2390.00	51.40 AV	54.00	-2.60	1.00 V	7	17.50	33.80
3	*2412.00	114.00 PK			1.00 V	7	84.10	29.90
3	*2412.00	107.20 AV			1.00 V	7	77.30	29.90
4	2688.00	41.20 PK	74.00	-32.80	1.15 V	40	10.40	30.90
4	2688.00	34.30 AV	54.00	-19.70	1.15 V	40	3.40	30.90
5	4824.00	50.10 PK	74.00	-23.90	1.14 V	24	13.90	36.20
5	4824.00	41.40 AV	54.00	-12.60	1.14 V	24	5.10	36.20
6	7236.00	54.60 PK	74.00	-19.40	1.24 V	44	12.90	41.70
6	7236.00	43.40 AV	54.00	-10.60	1.24 V	44	1.70	41.70

- REMARKS:**
1. Emission level(dBuV/m)=Raw Value(dBuV) + Correction Factor(dB/m)
 2. Correction Factor(dB/m) = Antenna Factor (dB/m) + Cable Factor (dB)
 3. The other emission levels were very low against the limit.
 4. Margin value = Emission level – Limit value.
 5. The limit value is defined as per 15.247
 6. “ * ” : Fundamental frequency



EUT	NetScreen-5GT ADSL Wireless	MODEL	NS-5GT-WIRELESS ADSL A
MODE	Channel 6	FREQUENCY RANGE	1000~25000MHz
INPUT POWER (SYSTEM)	120Vac, 60 Hz	DETECTOR FUNCTION & BANDWIDTH	Peak (PK) Average (AV) 1 MHz
ENVIRONMENTAL CONDITIONS	26 deg. C, 66%RH, 977 hPa	TESTED BY	Sky Liao

ANTENNA POLARITY & TEST DISTANCE: HORIZONTAL AT 3 M

No.	Freq. (MHz)	Emission Level (dBuV/m)	Limit (dBuV/m)	Margin (dB)	Antenna Height (m)	Table Angle (Degree)	Raw Value (dBuV)	Correction Factor (dB/m)
1	*2437.00	102.40 PK			1.45 H	167	72.40	30.00
1	*2437.00	95.70 AV			1.45 H	167	65.80	30.00
2	2688.00	38.80 PK	74.00	-35.20	1.30 H	167	8.00	30.90
2	2688.00	29.10 AV	54.00	-24.90	1.30 H	167	-1.80	30.90
3	4874.00	45.30 PK	74.00	-28.70	1.27 H	49	8.80	36.50
3	4874.00	34.40 AV	54.00	-19.60	1.27 H	49	-2.10	36.50
4	7311.00	51.60 PK	74.00	-22.40	1.27 H	37	9.80	41.80
4	7311.00	40.90 AV	54.00	-13.10	1.27 H	37	-0.90	41.80

ANTENNA POLARITY & TEST DISTANCE: VERTICAL AT 3 M

No.	Freq. (MHz)	Emission Level (dBuV/m)	Limit (dBuV/m)	Margin (dB)	Antenna Height (m)	Table Angle (Degree)	Raw Value (dBuV)	Correction Factor (dB/m)
1	*2437.00	113.40 PK			1.00 V	5	83.40	30.00
1	*2437.00	106.40 AV			1.00 V	5	76.40	30.00
2	2688.00	42.80 PK	74.00	-31.20	1.17 V	42	11.90	30.90
2	2688.00	38.10 AV	54.00	-15.90	1.17 V	42	7.20	30.90
3	4874.00	51.80 PK	74.00	-22.20	1.21 V	33	15.30	36.50
3	4874.00	40.50 AV	54.00	-13.50	1.21 V	33	4.00	36.50
4	7311.00	53.40 PK	74.00	-20.60	1.08 V	84	11.60	41.80
4	7311.00	43.70 AV	54.00	-10.30	1.08 V	84	1.90	41.80

- REMARKS:**
1. Emission level(dBuV/m)=Raw Value(dBuV) + Correction Factor(dB/m)
 2. Correction Factor(dB/m) = Antenna Factor (dB/m) + Cable Factor (dB)
 3. The other emission levels were very low against the limit.
 4. Margin value = Emission level – Limit value.
 5. The limit value is defined as per 15.247
 6. “ * “ : Fundamental frequency



EUT	NetScreen-5GT ADSL Wireless	MODEL	NS-5GT-WIRELESS ADSL A
MODE	Channel 11	FREQUENCY RANGE	1000~25000MHz
INPUT POWER (SYSTEM)	120Vac, 60 Hz	DETECTOR FUNCTION & BANDWIDTH	Peak (PK) Average (AV) 1 MHz
ENVIRONMENTAL CONDITIONS	26 deg. C, 66%RH, 977 hPa	TESTED BY	Sky Liao

ANTENNA POLARITY & TEST DISTANCE: HORIZONTAL AT 3 M								
No.	Freq. (MHz)	Emission Level (dBuV/m)	Limit (dBuV/m)	Margin (dB)	Antenna Height (m)	Table Angle (Degree)	Raw Value (dBuV)	Correction Factor (dB/m)
1	*2462.00	99.70 PK			1.46 H	33	69.70	30.10
1	*2462.00	92.80 AV			1.46 H	33	62.70	30.10
2	2483.50	44.00 PK	74.00	-30.00	1.46 H	33	13.80	30.10
2	2483.50	36.90 AV	54.00	-17.10	1.46 H	33	6.80	30.10
3	2688.00	41.00 PK	74.00	-33.00	1.30 H	166	10.10	30.90
3	2688.00	34.80 AV	54.00	-19.20	1.30 H	166	3.90	30.90
4	4924.00	46.40 PK	74.00	-27.60	1.20 H	57	9.70	36.70
4	4924.00	34.90 AV	54.00	-19.10	1.20 H	57	-1.80	36.70
5	7386.00	52.10 PK	74.00	-21.90	1.34 H	97	10.30	41.80
5	7386.00	40.90 AV	54.00	-13.10	1.34 H	97	-0.90	41.80

ANTENNA POLARITY & TEST DISTANCE: VERTICAL AT 3 M								
No.	Freq. (MHz)	Emission Level (dBuV/m)	Limit (dBuV/m)	Margin (dB)	Antenna Height (m)	Table Angle (Degree)	Raw Value (dBuV)	Correction Factor (dB/m)
1	*2462.00	113.00 PK			1.21 V	7	82.90	30.10
1	*2462.00	106.00 AV			1.21 V	7	76.00	30.10
2	2483.50	57.30 PK	74.00	-16.70	1.21 V	7	27.20	30.10
2	2483.50	50.10 AV	54.00	-3.90	1.21 V	7	20.00	30.10
3	2688.00	47.60 PK	74.00	-26.40	1.17 V	42	16.70	30.90
3	2688.00	44.90 AV	54.00	-9.10	1.17 V	42	14.00	30.90
4	4924.00	51.90 PK	74.00	-22.10	1.42 V	67	15.20	36.70
4	4924.00	40.20 AV	54.00	-13.80	1.42 V	67	3.50	36.70
5	7386.00	51.90 PK	74.00	-22.10	1.10 V	127	10.10	41.80
5	7386.00	40.80 AV	54.00	-13.20	1.10 V	127	-1.00	41.80

- REMARKS:**
1. Emission level(dBuV/m)=Raw Value(dBuV) + Correction Factor(dB/m)
 2. Correction Factor(dB/m) = Antenna Factor (dB/m) + Cable Factor (dB)
 3. The other emission levels were very low against the limit.
 4. Margin value = Emission level – Limit value.
 5. The limit value is defined as per 15.247
 6. “ * ” : Fundamental frequency



4.2.13 TEST RESULTS (ANTENNA 2 – DSSS)

EUT	NetScreen-5GT ADSL Wireless	MODEL	NS-5GT-WIRELESS ADSL A
MODE	Channel 1	FREQUENCY RANGE	1000~25000MHz
INPUT POWER (SYSTEM)	120Vac, 60 Hz	DETECTOR FUNCTION & BANDWIDTH	Peak (PK) Average (AV) 1 MHz
ENVIRONMENTAL CONDITIONS	26 deg. C, 66%RH, 977 hPa	TESTED BY	Sky Liao

ANTENNA POLARITY & TEST DISTANCE: HORIZONTAL AT 3 M

No.	Freq. (MHz)	Emission Level (dBuV/m)	Limit (dBuV/m)	Margin (dB)	Antenna Height (m)	Table Angle (Degree)	Raw Value (dBuV)	Correction Factor (dB/m)
1	2387.00	48.80 PK	74.00	-25.20	1.19 H	248	15.90	32.90
1	2387.00	41.40 AV	54.00	-12.60	1.19 H	248	8.50	32.90
2	2390.00	47.10 PK	74.00	-26.90	1.19 H	248	13.30	33.80
2	2390.00	39.70 AV	54.00	-14.30	1.19 H	248	5.90	33.80
3	*2412.00	102.50 PK			1.19 H	248	72.60	29.90
3	*2412.00	95.60 AV			1.19 H	248	65.70	29.90
4	2688.00	38.50 PK	74.00	-35.50	1.09 H	83	7.60	30.90
4	2688.00	28.90 AV	54.00	-25.10	1.09 H	83	-2.00	30.90
5	4824.00	45.60 PK	74.00	-28.40	1.32 H	49	9.40	36.20
5	4824.00	35.40 AV	54.00	-18.60	1.32 H	49	-0.80	36.20
6	7236.00	50.40 PK	74.00	-23.60	1.48 H	209	8.70	41.70
6	7236.00	40.10 AV	54.00	-13.90	1.48 H	209	-1.60	41.70

ANTENNA POLARITY & TEST DISTANCE: VERTICAL AT 3 M

No.	Freq. (MHz)	Emission Level (dBuV/m)	Limit (dBuV/m)	Margin (dB)	Antenna Height (m)	Table Angle (Degree)	Raw Value (dBuV)	Correction Factor (dB/m)
1	2387.00	59.80 PK	74.00	-14.20	1.00 V	8	26.90	32.90
1	2387.00	52.80 AV	54.00	-1.20	1.00 V	8	19.90	32.90
2	2390.00	58.20 PK	74.00	-15.80	1.00 V	8	24.40	33.80
2	2390.00	51.20 AV	54.00	-2.80	1.00 V	8	17.40	33.80
3	*2412.00	113.70 PK			1.00 V	8	83.80	29.90
3	*2412.00	107.00 AV			1.00 V	8	77.10	29.90
4	2688.00	42.60 PK	74.00	-31.40	1.26 V	38	11.70	30.90
4	2688.00	37.20 AV	54.00	-16.80	1.26 V	38	6.30	30.90
5	4824.00	52.70 PK	74.00	-21.30	1.03 V	234	16.50	36.20
5	4824.00	41.80 AV	54.00	-12.20	1.03 V	234	5.60	36.20
6	7236.00	51.90 PK	74.00	-22.10	1.38 V	194	10.20	41.70
6	7236.00	40.90 AV	54.00	-13.10	1.38 V	194	-0.80	41.70

- REMARKS:**
1. Emission level(dBuV/m)=Raw Value(dBuV) + Correction Factor(dB/m)
 2. Correction Factor(dB/m) = Antenna Factor (dB/m) + Cable Factor (dB)
 3. The other emission levels were very low against the limit.
 4. Margin value = Emission level – Limit value.
 5. The limit value is defined as per 15.247
 6. “ * ” : Fundamental frequency



EUT	NetScreen-5GT ADSL Wireless	MODEL	NS-5GT-WIRELESS ADSL A
MODE	Channel 6	FREQUENCY RANGE	1000~25000MHz
INPUT POWER (SYSTEM)	120Vac, 60 Hz	DETECTOR FUNCTION & BANDWIDTH	Peak (PK) Average (AV) 1 MHz
ENVIRONMENTAL CONDITIONS	26 deg. C, 66%RH, 977 hPa	TESTED BY	Sky Liao

ANTENNA POLARITY & TEST DISTANCE: HORIZONTAL AT 3 M

No.	Freq. (MHz)	Emission Level (dBuV/m)	Limit (dBuV/m)	Margin (dB)	Antenna Height (m)	Table Angle (Degree)	Raw Value (dBuV)	Correction Factor (dB/m)
1	*2437.00	102.80 PK			1.18 H	251	72.80	30.00
1	*2437.00	96.00 AV			1.18 H	251	66.00	30.00
2	2688.00	38.70 PK	74.00	-35.30	1.10 H	86	7.80	30.90
2	2688.00	29.10 AV	54.00	-24.90	1.10 H	86	-1.80	30.90
3	4874.00	45.40 PK	74.00	-28.60	1.35 H	52	8.90	36.50
3	4874.00	34.90 AV	54.00	-19.10	1.35 H	52	-1.60	36.50
4	7311.00	50.60 PK	74.00	-23.40	1.45 H	206	8.80	41.80
4	7311.00	40.20 AV	54.00	-13.80	1.45 H	206	-1.60	41.80

ANTENNA POLARITY & TEST DISTANCE: VERTICAL AT 3 M

No.	Freq. (MHz)	Emission Level (dBuV/m)	Limit (dBuV/m)	Margin (dB)	Antenna Height (m)	Table Angle (Degree)	Raw Value (dBuV)	Correction Factor (dB/m)
1	*2437.00	114.20 PK			1.12 V	6	84.20	30.00
1	*2437.00	107.90 AV			1.12 V	6	77.90	30.00
2	2688.00	43.10 PK	74.00	-30.90	1.28 V	43	12.20	30.90
2	2688.00	38.20 AV	54.00	-15.80	1.28 V	43	7.30	30.90
3	4874.00	52.80 PK	74.00	-21.20	1.14 V	247	16.30	36.50
3	4874.00	41.80 AV	54.00	-12.20	1.14 V	247	5.30	36.50
4	7311.00	52.40 PK	74.00	-21.60	1.37 V	202	10.60	41.80
4	7311.00	43.50 AV	54.00	-10.50	1.37 V	202	1.70	41.80

- REMARKS:**
1. Emission level(dBuV/m)=Raw Value(dBuV) + Correction Factor(dB/m)
 2. Correction Factor(dB/m) = Antenna Factor (dB/m) + Cable Factor (dB)
 3. The other emission levels were very low against the limit.
 4. Margin value = Emission level – Limit value.
 5. The limit value is defined as per 15.247
 6. “ * “ : Fundamental frequency



EUT	NetScreen-5GT ADSL Wireless	MODEL	NS-5GT-WIRELESS ADSL A
MODE	Channel 11	FREQUENCY RANGE	1000~25000MHz
INPUT POWER (SYSTEM)	120Vac, 60 Hz	DETECTOR FUNCTION & BANDWIDTH	Peak (PK) Average (AV) 1 MHz
ENVIRONMENTAL CONDITIONS	26 deg. C, 66%RH, 977 hPa	TESTED BY	Sky Liao

ANTENNA POLARITY & TEST DISTANCE: HORIZONTAL AT 3 M

No.	Freq. (MHz)	Emission Level (dBuV/m)	Limit (dBuV/m)	Margin (dB)	Antenna Height (m)	Table Angle (Degree)	Raw Value (dBuV)	Correction Factor (dB/m)
1	*2462.00	102.70 PK			1.19 H	249	72.60	30.10
1	*2462.00	95.90 AV			1.19 H	249	65.80	30.10
2	2483.50	47.00 PK	74.00	-27.00	1.19 H	249	16.90	30.10
2	2483.50	40.00 AV	54.00	-14.00	1.19 H	249	9.90	30.10
3	2688.00	41.10 PK	74.00	-32.90	1.05 H	86	10.20	30.90
3	2688.00	35.40 AV	54.00	-18.60	1.05 H	86	4.50	30.90
4	4924.00	45.80 PK	74.00	-28.20	1.37 H	53	9.10	36.70
4	4924.00	35.70 AV	54.00	-18.30	1.37 H	53	-1.00	36.70
5	7386.00	51.60 PK	74.00	-22.40	1.47 H	206	9.80	41.80
5	7386.00	41.30 AV	54.00	-12.70	1.47 H	206	-0.50	41.80

ANTENNA POLARITY & TEST DISTANCE: VERTICAL AT 3 M

No.	Freq. (MHz)	Emission Level (dBuV/m)	Limit (dBuV/m)	Margin (dB)	Antenna Height (m)	Table Angle (Degree)	Raw Value (dBuV)	Correction Factor (dB/m)
1	*2462.00	113.80 PK			1.14 V	5	83.70	30.10
1	*2462.00	107.20 AV			1.14 V	5	77.10	30.10
2	2483.50	58.10 PK	74.00	-15.90	1.14 V	5	28.00	30.10
2	2483.50	51.30 AV	54.00	-2.70	1.14 V	5	21.20	30.10
3	2688.00	46.50 PK	74.00	-27.50	1.19 V	46	15.60	30.90
3	2688.00	42.60 AV	54.00	-11.40	1.19 V	46	11.70	30.90
4	4924.00	52.10 PK	74.00	-21.90	1.12 V	247	15.40	36.70
4	4924.00	41.30 AV	54.00	-12.70	1.12 V	247	4.60	36.70
5	7386.00	51.60 PK	74.00	-22.40	1.45 V	184	9.80	41.80
5	7386.00	40.80 AV	54.00	-13.20	1.45 V	184	-1.00	41.80

- REMARKS:**
1. Emission level(dBuV/m)=Raw Value(dBuV) + Correction Factor(dB/m)
 2. Correction Factor(dB/m) = Antenna Factor (dB/m) + Cable Factor (dB)
 3. The other emission levels were very low against the limit.
 4. Margin value = Emission level – Limit value.
 5. The limit value is defined as per 15.247
 6. " * " : Fundamental frequency



4.2.14 TEST RESULTS (ANTENNA 3 – DSSS)

EUT	NetScreen-5GT ADSL Wireless	MODEL	NS-5GT-WIRELESS ADSL A
MODE	Channel 1	FREQUENCY RANGE	1000~25000MHz
INPUT POWER (SYSTEM)	120Vac, 60 Hz	DETECTOR FUNCTION & BANDWIDTH	Peak (PK) Average (AV) 1 MHz
ENVIRONMENTAL CONDITIONS	26 deg. C, 66%RH, 977 hPa	TESTED BY	Sky Liao

ANTENNA POLARITY & TEST DISTANCE: HORIZONTAL AT 3 M

No.	Freq. (MHz)	Emission Level (dBuV/m)	Limit (dBuV/m)	Margin (dB)	Antenna Height (m)	Table Angle (Degree)	Raw Value (dBuV)	Correction Factor (dB/m)
1	2387.00	46.40 PK	74.00	-27.60	1.25 H	26	13.50	32.90
1	2387.00	39.10 AV	54.00	-14.90	1.25 H	26	6.20	32.90
2	2390.00	44.70 PK	74.00	-29.30	1.25 H	26	10.90	33.80
2	2390.00	37.40 AV	54.00	-16.60	1.25 H	26	3.60	33.80
3	*2412.00	100.10 PK			1.25 H	26	70.20	29.90
3	*2412.00	93.30 AV			1.25 H	26	63.40	29.90
4	2688.00	39.20 PK	74.00	-34.80	1.32 H	352	8.30	30.90
4	2688.00	29.60 AV	54.00	-24.40	1.32 H	352	-1.30	30.90
5	4824.00	45.40 PK	74.00	-28.60	1.35 H	31	9.20	36.20
5	4824.00	34.30 AV	54.00	-19.70	1.35 H	31	-1.90	36.20
6	7236.00	50.10 PK	74.00	-23.90	1.41 H	12	8.40	41.70
6	7236.00	38.80 AV	54.00	-15.20	1.41 H	12	-2.90	41.70

ANTENNA POLARITY & TEST DISTANCE: VERTICAL AT 3 M

No.	Freq. (MHz)	Emission Level (dBuV/m)	Limit (dBuV/m)	Margin (dB)	Antenna Height (m)	Table Angle (Degree)	Raw Value (dBuV)	Correction Factor (dB/m)
1	2387.00	60.00 PK	74.00	-14.00	1.17 V	348	27.10	32.90
1	2387.00	52.90 AV	54.00	-1.10	1.17 V	348	20.00	32.90
2	2390.00	58.40 PK	74.00	-15.60	1.17 V	348	24.60	33.80
2	2390.00	51.30 AV	54.00	-2.70	1.17 V	348	17.50	33.80
3	*2412.00	113.90 PK			1.17 V	348	84.00	29.90
3	*2412.00	107.10 AV			1.17 V	348	77.20	29.90
4	2688.00	45.30 PK	74.00	-28.70	1.27 V	12	14.40	30.90
4	2688.00	41.10 AV	54.00	-12.90	1.27 V	12	10.20	30.90
5	4824.00	50.20 PK	74.00	-23.80	1.12 V	356	14.00	36.20
5	4824.00	41.30 AV	54.00	-12.70	1.12 V	356	5.10	36.20
6	7236.00	54.70 PK	74.00	-19.30	1.27 V	27	13.00	41.70
6	7236.00	43.50 AV	54.00	-10.50	1.27 V	27	1.80	41.70

- REMARKS:**
1. Emission level(dBuV/m)=Raw Value(dBuV) + Correction Factor(dB/m)
 2. Correction Factor(dB/m) = Antenna Factor (dB/m) + Cable Factor (dB)
 3. The other emission levels were very low against the limit.
 4. Margin value = Emission level – Limit value.
 5. The limit value is defined as per 15.247
 6. “ * ” : Fundamental frequency



EUT	NetScreen-5GT ADSL Wireless	MODEL	NS-5GT-WIRELESS ADSL A
MODE	Channel 6	FREQUENCY RANGE	1000~25000MHz
INPUT POWER (SYSTEM)	120Vac, 60 Hz	DETECTOR FUNCTION & BANDWIDTH	Peak (PK) Average (AV) 1 MHz
ENVIRONMENTAL CONDITIONS	26 deg. C, 66%RH, 977 hPa	TESTED BY	Sky Liao

ANTENNA POLARITY & TEST DISTANCE: HORIZONTAL AT 3 M

No.	Freq. (MHz)	Emission Level (dBuV/m)	Limit (dBuV/m)	Margin (dB)	Antenna Height (m)	Table Angle (Degree)	Raw Value (dBuV)	Correction Factor (dB/m)
1	*2437.00	100.30 PK			1.24 H	28	70.30	30.00
1	*2437.00	93.40 AV			1.24 H	28	63.40	30.00
2	2688.00	39.40 PK	74.00	-34.60	1.31 H	354	8.50	30.90
2	2688.00	29.90 AV	54.00	-24.10	1.31 H	354	-1.00	30.90
3	4874.00	45.20 PK	74.00	-28.80	1.31 H	24	8.70	36.50
3	4874.00	34.10 AV	54.00	-19.90	1.31 H	24	-2.40	36.50
4	7311.00	49.80 PK	74.00	-24.20	1.43 H	17	8.00	41.80
4	7311.00	38.60 AV	54.00	-15.40	1.43 H	17	-3.20	41.80

ANTENNA POLARITY & TEST DISTANCE: VERTICAL AT 3 M

No.	Freq. (MHz)	Emission Level (dBuV/m)	Limit (dBuV/m)	Margin (dB)	Antenna Height (m)	Table Angle (Degree)	Raw Value (dBuV)	Correction Factor (dB/m)
1	*2437.00	114.10 PK			1.18 V	350	84.10	30.00
1	*2437.00	107.20 AV			1.18 V	350	77.20	30.00
2	2688.00	47.30 PK	74.00	-26.70	1.29 V	18	16.40	30.90
2	2688.00	42.90 AV	54.00	-11.10	1.29 V	18	12.00	30.90
3	4874.00	49.80 PK	74.00	-24.20	1.13 V	347	13.30	36.50
3	4874.00	39.40 AV	54.00	-14.60	1.13 V	347	2.90	36.50
4	7311.00	54.60 PK	74.00	-19.40	1.24 V	31	12.80	41.80
4	7311.00	43.30 AV	54.00	-10.70	1.24 V	31	1.50	41.80

- REMARKS:**
1. Emission level(dBuV/m)=Raw Value(dBuV) + Correction Factor(dB/m)
 2. Correction Factor(dB/m) = Antenna Factor (dB/m) + Cable Factor (dB)
 3. The other emission levels were very low against the limit.
 4. Margin value = Emission level – Limit value.
 5. The limit value is defined as per 15.247
 6. “ * “ : Fundamental frequency



EUT	NetScreen-5GT ADSL Wireless	MODEL	NS-5GT-WIRELESS ADSL A
MODE	Channel 11	FREQUENCY RANGE	1000~25000MHz
INPUT POWER (SYSTEM)	120Vac, 60 Hz	DETECTOR FUNCTION & BANDWIDTH	Peak (PK) Average (AV) 1 MHz
ENVIRONMENTAL CONDITIONS	26 deg. C, 66%RH, 977 hPa	TESTED BY	Sky Liao

ANTENNA POLARITY & TEST DISTANCE: HORIZONTAL AT 3 M

No.	Freq. (MHz)	Emission Level (dBuV/m)	Limit (dBuV/m)	Margin (dB)	Antenna Height (m)	Table Angle (Degree)	Raw Value (dBuV)	Correction Factor (dB/m)
1	*2462.00	99.80 PK			1.26 H	23	69.70	30.10
1	*2462.00	93.10 AV			1.26 H	23	63.00	30.10
2	2483.50	44.10 PK	74.00	-29.90	1.26 H	23	14.00	30.10
2	2483.50	37.20 AV	54.00	-16.80	1.26 H	23	7.10	30.10
3	2688.00	39.60 PK	74.00	-34.40	1.29 H	354	8.70	30.90
3	2688.00	30.40 AV	54.00	-23.60	1.29 H	354	-0.50	30.90
4	4924.00	46.20 PK	74.00	-27.80	1.37 H	33	9.50	36.70
4	4924.00	35.40 AV	54.00	-18.60	1.37 H	33	-1.30	36.70
5	7386.00	50.30 PK	74.00	-23.70	1.37 H	16	8.50	41.80
5	7386.00	38.90 AV	54.00	-15.10	1.37 H	16	-2.90	41.80

ANTENNA POLARITY & TEST DISTANCE: VERTICAL AT 3 M

No.	Freq. (MHz)	Emission Level (dBuV/m)	Limit (dBuV/m)	Margin (dB)	Antenna Height (m)	Table Angle (Degree)	Raw Value (dBuV)	Correction Factor (dB/m)
1	*2462.00	113.40 PK			1.21 V	353	83.30	30.10
1	*2462.00	106.60 AV			1.21 V	353	76.50	30.10
2	2483.50	57.60 PK	74.00	-16.40	1.21 V	353	27.50	30.10
2	2483.50	50.70 AV	54.00	-3.30	1.21 V	353	20.60	30.10
3	2688.00	48.10 PK	74.00	-25.90	1.30 V	14	17.20	30.90
3	2688.00	45.50 AV	54.00	-8.50	1.30 V	14	14.60	30.90
4	4924.00	50.20 PK	74.00	-23.80	1.35 V	347	13.50	36.70
4	4924.00	39.10 AV	54.00	-14.90	1.35 V	347	2.40	36.70
5	7386.00	52.40 PK	74.00	-21.60	1.26 V	29	10.60	41.80
5	7386.00	41.30 AV	54.00	-12.70	1.26 V	29	-0.50	41.80

- REMARKS:**
1. Emission level(dBuV/m)=Raw Value(dBuV) + Correction Factor(dB/m)
 2. Correction Factor(dB/m) = Antenna Factor (dB/m) + Cable Factor (dB)
 3. The other emission levels were very low against the limit.
 4. Margin value = Emission level – Limit value.
 5. The limit value is defined as per 15.247
 6. " * " : Fundamental frequency



4.2.15 TEST RESULTS (ANTENNA 1 –OFDM)

EUT	NetScreen-5GT ADSL Wireless	MODEL	NS-5GT-WIRELESS ADSL A
MODE	Channel 1	FREQUENCY RANGE	1000~25000MHz
INPUT POWER (SYSTEM)	120Vac, 60 Hz	DETECTOR FUNCTION & BANDWIDTH	Peak (PK) Average (AV) 1 MHz
ENVIRONMENTAL CONDITIONS	26 deg. C, 66%RH, 977 hPa	TESTED BY	Sky Liao

ANTENNA POLARITY & TEST DISTANCE: HORIZONTAL AT 3 M

No.	Freq. (MHz)	Emission Level (dBuV/m)	Limit (dBuV/m)	Margin (dB)	Antenna Height (m)	Table Angle (Degree)	Raw Value (dBuV)	Correction Factor (dB/m)
1	2390.00	49.70 PK	74.00	-24.30	1.19 H	68	15.90	33.80
1	2390.00	41.50 AV	54.00	-12.50	1.19 H	68	7.70	33.80
2	*2412.00	98.70 PK			1.19 H	68	68.80	29.90
2	*2412.00	90.40 AV			1.19 H	68	60.50	29.90
3	2688.00	38.30 PK	74.00	-35.70	1.28 H	168	7.40	30.90
3	2688.00	29.80 AV	54.00	-24.20	1.28 H	168	-1.10	30.90
4	4824.00	46.10 PK	74.00	-27.90	1.34 H	54	9.90	36.20
4	4824.00	35.90 AV	54.00	-18.10	1.34 H	54	-0.30	36.20
5	7236.00	51.40 PK	74.00	-22.60	1.31 H	24	9.70	41.70
5	7236.00	39.80 AV	54.00	-14.20	1.31 H	24	-1.90	41.70

ANTENNA POLARITY & TEST DISTANCE: VERTICAL AT 3 M

No.	Freq. (MHz)	Emission Level (dBuV/m)	Limit (dBuV/m)	Margin (dB)	Antenna Height (m)	Table Angle (Degree)	Raw Value (dBuV)	Correction Factor (dB/m)
1	2390.00	60.50 PK	74.00	-13.50	1.00 V	8	26.70	33.80
1	2390.00	52.30 AV	54.00	-1.70	1.00 V	8	18.50	33.80
2	*2412.00	109.30 PK			1.00 V	8	79.40	29.90
2	*2412.00	101.20 AV			1.00 V	8	71.30	29.90
3	2688.00	43.20 PK	74.00	-30.80	1.18 V	42	12.40	30.90
3	2688.00	38.70 AV	54.00	-15.30	1.18 V	42	7.80	30.90
4	4824.00	47.20 PK	74.00	-26.80	1.35 V	48	11.00	36.20
4	4824.00	36.80 AV	54.00	-17.20	1.35 V	48	0.60	36.20
5	7236.00	52.90 PK	74.00	-21.10	1.26 V	39	11.20	41.70
5	7236.00	40.40 AV	54.00	-13.60	1.26 V	39	-1.30	41.70

- REMARKS:**
1. Emission level(dBuV/m)=Raw Value(dBuV) + Correction Factor(dB/m)
 2. Correction Factor(dB/m) = Antenna Factor (dB/m) + Cable Factor (dB)
 3. The other emission levels were very low against the limit.
 4. Margin value = Emission level – Limit value.
 5. The limit value is defined as per 15.247
 6. “ * “ : Fundamental frequency



EUT	NetScreen-5GT ADSL Wireless	MODEL	NS-5GT-WIRELESS ADSL A
MODE	Channel 6	FREQUENCY RANGE	1000~25000MHz
INPUT POWER (SYSTEM)	120Vac, 60 Hz	DETECTOR FUNCTION & BANDWIDTH	Peak (PK) Average (AV) 1 MHz
ENVIRONMENTAL CONDITIONS	26 deg. C, 66%RH, 977 hPa	TESTED BY	Sky Liao

ANTENNA POLARITY & TEST DISTANCE: HORIZONTAL AT 3 M

No.	Freq. (MHz)	Emission Level (dBuV/m)	Limit (dBuV/m)	Margin (dB)	Antenna Height (m)	Table Angle (Degree)	Raw Value (dBuV)	Correction Factor (dB/m)
1	*2437.00	98.00 PK			1.23 H	33	68.10	30.00
1	*2437.00	90.20 AV			1.23 H	33	60.20	30.00
2	2688.00	36.70 PK	74.00	-37.30	1.28 H	170	5.80	30.90
2	2688.00	45.30 AV	54.00	-8.70	1.28 H	170	14.50	30.90
3	4874.00	46.40 PK	74.00	-27.60	1.08 H	34	9.90	36.50
3	4874.00	35.60 AV	54.00	-18.40	1.08 H	34	-0.90	36.50
4	7311.00	50.20 PK	74.00	-23.80	1.19 H	28	8.40	41.80
4	7311.00	39.70 AV	54.00	-14.30	1.19 H	28	-2.10	41.80

ANTENNA POLARITY & TEST DISTANCE: VERTICAL AT 3 M

No.	Freq. (MHz)	Emission Level (dBuV/m)	Limit (dBuV/m)	Margin (dB)	Antenna Height (m)	Table Angle (Degree)	Raw Value (dBuV)	Correction Factor (dB/m)
1	*2437.00	109.30 PK			1.26 V	39	79.30	30.00
1	*2437.00	101.00 AV			1.26 V	39	71.00	30.00
2	2688.00	43.70 PK	74.00	-30.30	1.16 V	41	12.90	30.90
2	2688.00	39.40 AV	54.00	-14.60	1.16 V	41	8.50	30.90
3	4874.00	47.20 PK	74.00	-26.80	1.19 V	91	10.70	36.50
3	4874.00	35.60 AV	54.00	-18.40	1.19 V	91	-0.90	36.50
4	7311.00	52.70 PK	74.00	-21.30	1.27 V	18	10.90	41.80
4	7311.00	41.30 AV	54.00	-12.70	1.27 V	18	-0.50	41.80

- REMARKS:**
1. Emission level(dBuV/m)=Raw Value(dBuV) + Correction Factor(dB/m)
 2. Correction Factor(dB/m) = Antenna Factor (dB/m) + Cable Factor (dB)
 3. The other emission levels were very low against the limit.
 4. Margin value = Emission level – Limit value.
 5. The limit value is defined as per 15.247
 6. “ * “ : Fundamental frequency



EUT	NetScreen-5GT ADSL Wireless	MODEL	NS-5GT-WIRELESS ADSL A
MODE	Channel 11	FREQUENCY RANGE	1000~25000MHz
INPUT POWER (SYSTEM)	120Vac, 60 Hz	DETECTOR FUNCTION & BANDWIDTH	Peak (PK) Average (AV) 1 MHz
ENVIRONMENTAL CONDITIONS	26 deg. C, 66%RH, 977 hPa	TESTED BY	Sky Liao

ANTENNA POLARITY & TEST DISTANCE: HORIZONTAL AT 3 M								
No.	Freq. (MHz)	Emission Level (dBuV/m)	Limit (dBuV/m)	Margin (dB)	Antenna Height (m)	Table Angle (Degree)	Raw Value (dBuV)	Correction Factor (dB/m)
1	*2462.00	95.60 PK			1.23 H	34	65.50	30.10
1	*2462.00	88.00 AV			1.23 H	34	57.90	30.10
2	2483.50	45.90 PK	74.00	-28.10	1.23 H	34	15.80	30.10
2	2483.50	38.70 AV	54.00	-15.30	1.23 H	34	8.50	30.10
3	2688.00	39.50 PK	74.00	-34.50	1.28 H	165	8.60	30.90
3	2688.00	30.00 AV	54.00	-24.00	1.28 H	165	-0.90	30.90
4	4924.00	46.20 PK	74.00	-27.80	1.15 H	54	9.50	36.70
4	4924.00	35.70 AV	54.00	-18.30	1.15 H	54	-1.00	36.70
5	7386.00	52.70 PK	74.00	-21.30	1.24 H	63	10.90	41.80
5	7386.00	41.30 AV	54.00	-12.70	1.24 H	63	-0.50	41.80

ANTENNA POLARITY & TEST DISTANCE: VERTICAL AT 3 M								
No.	Freq. (MHz)	Emission Level (dBuV/m)	Limit (dBuV/m)	Margin (dB)	Antenna Height (m)	Table Angle (Degree)	Raw Value (dBuV)	Correction Factor (dB/m)
1	*2462.00	109.00 PK			1.27 V	33	78.90	30.10
1	*2462.00	100.90 AV			1.27 V	33	70.90	30.10
2	2483.50	60.00 PK	74.00	-14.00	1.27 V	33	29.90	30.10
2	2483.50	51.60 AV	54.00	-2.40	1.27 V	33	21.40	30.10
3	2688.00	43.20 PK	74.00	-30.80	1.16 V	43	12.30	30.90
3	2688.00	39.10 AV	54.00	-14.90	1.16 V	43	8.20	30.90
4	4924.00	46.80 PK	74.00	-27.20	1.08 V	57	10.10	36.70
4	4924.00	36.10 AV	54.00	-17.90	1.08 V	57	-0.60	36.70
5	7386.00	51.90 PK	74.00	-22.10	1.12 V	94	10.10	41.80
5	7386.00	41.80 AV	54.00	-12.20	1.12 V	94	0.00	41.80

- REMARKS:**
1. Emission level(dBuV/m)=Raw Value(dBuV) + Correction Factor(dB/m)
 2. Correction Factor(dB/m) = Antenna Factor (dB/m) + Cable Factor (dB)
 3. The other emission levels were very low against the limit.
 4. Margin value = Emission level – Limit value.
 5. The limit value is defined as per 15.247
 6. “ * “ : Fundamental frequency



4.2.16 TEST RESULTS (ANTENNA 2 –OFDM)

EUT	NetScreen-5GT ADSL Wireless	MODEL	NS-5GT-WIRELESS ADSL A
MODE	Channel 1	FREQUENCY RANGE	1000~25000MHz
INPUT POWER (SYSTEM)	120Vac, 60 Hz	DETECTOR FUNCTION & BANDWIDTH	Peak (PK) Average (AV) 1 MHz
ENVIRONMENTAL CONDITIONS	26 deg. C, 66%RH, 977 hPa	TESTED BY	Sky Liao

ANTENNA POLARITY & TEST DISTANCE: HORIZONTAL AT 3 M

No.	Freq. (MHz)	Emission Level (dBuV/m)	Limit (dBuV/m)	Margin (dB)	Antenna Height (m)	Table Angle (Degree)	Raw Value (dBuV)	Correction Factor (dB/m)
1	2390.00	46.90 PK	74.00	-27.10	1.13 H	324	13.10	33.80
1	2390.00	38.60 AV	54.00	-15.40	1.13 H	324	4.80	33.80
2	*2412.00	95.90 PK			1.13 H	324	66.00	29.90
2	*2412.00	87.50 AV			1.13 H	324	57.60	29.90
3	2688.00	37.60 PK	74.00	-36.40	1.21 H	75	6.70	30.90
3	2688.00	28.70 AV	54.00	-25.30	1.21 H	75	-2.10	30.90
4	4824.00	45.60 PK	74.00	-28.40	1.17 H	33	9.40	36.20
4	4824.00	35.90 AV	54.00	-18.10	1.17 H	33	-0.30	36.20
5	7236.00	51.60 PK	74.00	-22.40	1.38 H	89	9.90	41.70
5	7236.00	39.40 AV	54.00	-14.60	1.38 H	89	-2.30	41.70

ANTENNA POLARITY & TEST DISTANCE: VERTICAL AT 3 M

No.	Freq. (MHz)	Emission Level (dBuV/m)	Limit (dBuV/m)	Margin (dB)	Antenna Height (m)	Table Angle (Degree)	Raw Value (dBuV)	Correction Factor (dB/m)
1	2390.00	61.20 PK	74.00	-12.80	1.17 V	8	27.40	33.80
1	2390.00	52.60 AV	54.00	-1.40	1.17 V	8	18.80	33.80
2	*2412.00	110.00 PK			1.17 V	8	80.10	29.90
2	*2412.00	101.60 AV			1.17 V	8	71.70	29.90
3	2688.00	43.50 PK	74.00	-30.50	1.19 V	34	12.60	30.90
3	2688.00	39.30 AV	54.00	-14.70	1.19 V	34	8.40	30.90
4	4824.00	47.40 PK	74.00	-26.60	1.38 V	46	11.20	36.20
4	4824.00	37.10 AV	54.00	-16.90	1.38 V	46	0.90	36.20
5	7236.00	52.40 PK	74.00	-21.60	1.27 V	75	10.70	41.70
5	7236.00	40.30 AV	54.00	-13.70	1.27 V	75	-1.40	41.70

- REMARKS:**
1. Emission level(dBuV/m)=Raw Value(dBuV) + Correction Factor(dB/m)
 2. Correction Factor(dB/m) = Antenna Factor (dB/m) + Cable Factor (dB)
 3. The other emission levels were very low against the limit.
 4. Margin value = Emission level – Limit value.
 5. The limit value is defined as per 15.247
 6. “ * “ : Fundamental frequency



EUT	NetScreen-5GT ADSL Wireless	MODEL	NS-5GT-WIRELESS ADSL A
MODE	Channel 6	FREQUENCY RANGE	1000~25000MHz
INPUT POWER (SYSTEM)	120Vac, 60 Hz	DETECTOR FUNCTION & BANDWIDTH	Peak (PK) Average (AV) 1 MHz
ENVIRONMENTAL CONDITIONS	26 deg. C, 66%RH, 977 hPa	TESTED BY	Sky Liao

ANTENNA POLARITY & TEST DISTANCE: HORIZONTAL AT 3 M

No.	Freq. (MHz)	Emission Level (dBuV/m)	Limit (dBuV/m)	Margin (dB)	Antenna Height (m)	Table Angle (Degree)	Raw Value (dBuV)	Correction Factor (dB/m)
1	*2437.00	96.10 PK			1.08 H	327	66.10	30.00
1	*2437.00	87.60 AV			1.08 H	327	57.60	30.00
2	2688.00	38.40 PK	74.00	-35.60	1.26 H	75	7.50	30.90
2	2688.00	29.30 AV	54.00	-24.70	1.26 H	75	-1.60	30.90
3	4874.00	45.80 PK	74.00	-28.20	1.23 H	29	9.30	36.50
3	4874.00	36.10 AV	54.00	-17.90	1.23 H	29	-0.40	36.50
4	7311.00	51.10 PK	74.00	-22.90	1.25 H	85	9.30	41.80
4	7311.00	39.00 AV	54.00	-15.00	1.25 H	85	-2.80	41.80

ANTENNA POLARITY & TEST DISTANCE: VERTICAL AT 3 M

No.	Freq. (MHz)	Emission Level (dBuV/m)	Limit (dBuV/m)	Margin (dB)	Antenna Height (m)	Table Angle (Degree)	Raw Value (dBuV)	Correction Factor (dB/m)
1	*2437.00	110.40 PK			1.16 V	12	80.40	30.00
1	*2437.00	101.80 AV			1.16 V	12	71.80	30.00
2	2688.00	43.80 PK	74.00	-30.20	1.24 V	41	12.90	30.90
2	2688.00	40.40 AV	54.00	-13.60	1.24 V	41	9.50	30.90
3	4874.00	47.80 PK	74.00	-26.20	1.35 V	57	11.30	36.50
3	4874.00	36.80 AV	54.00	-17.20	1.35 V	57	0.30	36.50
4	7311.00	52.30 PK	74.00	-21.70	1.25 V	73	10.50	41.80
4	7311.00	40.50 AV	54.00	-13.50	1.25 V	73	-1.30	41.80

- REMARKS:**
1. Emission level(dBuV/m)=Raw Value(dBuV) + Correction Factor(dB/m)
 2. Correction Factor(dB/m) = Antenna Factor (dB/m) + Cable Factor (dB)
 3. The other emission levels were very low against the limit.
 4. Margin value = Emission level – Limit value.
 5. The limit value is defined as per 15.247
 6. “ * “ : Fundamental frequency



EUT	NetScreen-5GT ADSL Wireless	MODEL	NS-5GT-WIRELESS ADSL A
MODE	Channel 11	FREQUENCY RANGE	1000~25000MHz
INPUT POWER (SYSTEM)	120Vac, 60 Hz	DETECTOR FUNCTION & BANDWIDTH	Peak (PK) Average (AV) 1 MHz
ENVIRONMENTAL CONDITIONS	26 deg. C, 66%RH, 977 hPa	TESTED BY	Sky Liao

ANTENNA POLARITY & TEST DISTANCE: HORIZONTAL AT 3 M

No.	Freq. (MHz)	Emission Level (dBuV/m)	Limit (dBuV/m)	Margin (dB)	Antenna Height (m)	Table Angle (Degree)	Raw Value (dBuV)	Correction Factor (dB/m)
1	*2462.00	96.30 PK			1.16 H	331	66.20	30.10
1	*2462.00	87.90 AV			1.16 H	331	57.80	30.10
2	2483.50	46.60 PK	74.00	-27.40	1.16 H	331	16.50	30.10
2	2483.50	38.60 AV	54.00	-15.40	1.16 H	331	8.50	30.10
3	2688.00	39.30 PK	74.00	-34.70	1.27 H	78	8.40	30.90
3	2688.00	30.20 AV	54.00	-23.80	1.27 H	78	-0.70	30.90
4	4924.00	45.80 PK	74.00	-28.20	1.21 H	36	9.10	36.70
4	4924.00	34.00 AV	54.00	-20.00	1.21 H	36	-2.70	36.70
5	7386.00	51.50 PK	74.00	-22.50	1.43 H	84	9.70	41.80
5	7386.00	40.30 AV	54.00	-13.70	1.43 H	84	-1.50	41.80

ANTENNA POLARITY & TEST DISTANCE: VERTICAL AT 3 M

No.	Freq. (MHz)	Emission Level (dBuV/m)	Limit (dBuV/m)	Margin (dB)	Antenna Height (m)	Table Angle (Degree)	Raw Value (dBuV)	Correction Factor (dB/m)
1	*2462.00	109.50 PK			1.19 V	7	79.50	30.10
1	*2462.00	101.30 AV			1.19 V	7	71.20	30.10
2	2483.50	60.50 PK	74.00	-13.50	1.19 V	7	30.40	30.10
2	2483.50	52.00 AV	54.00	-2.00	1.19 V	7	21.90	30.10
3	2688.00	43.90 PK	74.00	-30.10	1.15 V	43	13.00	30.90
3	2688.00	40.80 AV	54.00	-13.20	1.15 V	43	9.90	30.90
4	4924.00	47.20 PK	74.00	-26.80	1.36 V	44	10.50	36.70
4	4924.00	35.80 AV	54.00	-18.20	1.36 V	44	-0.90	36.70
5	7386.00	52.10 PK	74.00	-21.90	1.31 V	69	10.30	41.80
5	7386.00	40.20 AV	54.00	-13.80	1.31 V	69	-1.60	41.80

- REMARKS:**
1. Emission level(dBuV/m)=Raw Value(dBuV) + Correction Factor(dB/m)
 2. Correction Factor(dB/m) = Antenna Factor (dB/m) + Cable Factor (dB)
 3. The other emission levels were very low against the limit.
 4. Margin value = Emission level – Limit value.
 5. The limit value is defined as per 15.247
 6. “ * “ : Fundamental frequency



4.2.17 TEST RESULTS (ANTENNA 3 –OFDM)

EUT	NetScreen-5GT ADSL Wireless	MODEL	NS-5GT-WIRELESS ADSL A
MODE	Channel 1	FREQUENCY RANGE	1000~25000MHz
INPUT POWER (SYSTEM)	120Vac, 60 Hz	DETECTOR FUNCTION & BANDWIDTH	Peak (PK) Average (AV) 1 MHz
ENVIRONMENTAL CONDITIONS	26 deg. C, 66%RH, 977 hPa	TESTED BY	Sky Liao

ANTENNA POLARITY & TEST DISTANCE: HORIZONTAL AT 3 M

No.	Freq. (MHz)	Emission Level (dBuV/m)	Limit (dBuV/m)	Margin (dB)	Antenna Height (m)	Table Angle (Degree)	Raw Value (dBuV)	Correction Factor (dB/m)
1	2390.00	44.20 PK	74.00	-29.80	1.21 H	22	10.40	33.80
1	2390.00	36.20 AV	54.00	-17.80	1.21 H	22	2.40	33.80
2	*2412.00	93.20 PK			1.21 H	22	63.30	29.90
2	*2412.00	85.10 AV			1.21 H	22	55.20	29.90
3	2688.00	39.20 PK	74.00	-34.80	1.28 H	349	8.30	30.90
3	2688.00	29.10 AV	54.00	-24.90	1.28 H	349	-1.80	30.90
4	4824.00	45.30 PK	74.00	-28.70	1.42 H	15	9.10	36.20
4	4824.00	34.10 AV	54.00	-19.90	1.42 H	15	-2.10	36.20
5	7236.00	49.90 PK	74.00	-24.10	1.47 H	21	8.20	41.70
5	7236.00	37.80 AV	54.00	-16.20	1.47 H	21	-3.90	41.70

ANTENNA POLARITY & TEST DISTANCE: VERTICAL AT 3 M

No.	Freq. (MHz)	Emission Level (dBuV/m)	Limit (dBuV/m)	Margin (dB)	Antenna Height (m)	Table Angle (Degree)	Raw Value (dBuV)	Correction Factor (dB/m)
1	2390.00	61.30 PK	74.00	-12.70	1.29 V	356	27.50	33.80
1	2390.00	52.80 AV	54.00	-1.20	1.29 V	356	19.00	33.80
2	*2412.00	110.10 PK			1.29 V	356	80.20	29.90
2	*2412.00	101.70 AV			1.29 V	356	71.80	29.90
3	2688.00	43.40 PK	74.00	-30.60	1.23 V	16	12.50	30.90
3	2688.00	39.10 AV	54.00	-14.90	1.23 V	16	8.20	30.90
4	4824.00	47.10 PK	74.00	-26.90	1.45 V	23	10.90	36.20
4	4824.00	36.30 AV	54.00	-17.70	1.45 V	23	0.10	36.20
5	7236.00	52.40 PK	74.00	-21.60	1.32 V	17	10.70	41.70
5	7236.00	40.60 AV	54.00	-13.40	1.32 V	17	-1.10	41.70

- REMARKS:**
1. Emission level(dBuV/m)=Raw Value(dBuV) + Correction Factor(dB/m)
 2. Correction Factor(dB/m) = Antenna Factor (dB/m) + Cable Factor (dB)
 3. The other emission levels were very low against the limit.
 4. Margin value = Emission level – Limit value.
 5. The limit value is defined as per 15.247
 6. “ * ” : Fundamental frequency



EUT	NetScreen-5GT ADSL Wireless	MODEL	NS-5GT-WIRELESS ADSL A
MODE	Channel 6	FREQUENCY RANGE	1000~25000MHz
INPUT POWER (SYSTEM)	120Vac, 60 Hz	DETECTOR FUNCTION & BANDWIDTH	Peak (PK) Average (AV) 1 MHz
ENVIRONMENTAL CONDITIONS	26 deg. C, 66%RH, 977 hPa	TESTED BY	Sky Liao

ANTENNA POLARITY & TEST DISTANCE: HORIZONTAL AT 3 M

No.	Freq. (MHz)	Emission Level (dBuV/m)	Limit (dBuV/m)	Margin (dB)	Antenna Height (m)	Table Angle (Degree)	Raw Value (dBuV)	Correction Factor (dB/m)
1	*2437.00	93.10 PK			1.22 H	25	63.10	30.00
1	*2437.00	85.20 AV			1.22 H	25	55.20	30.00
2	2688.00	39.10 PK	74.00	-34.90	1.31 H	347	8.20	30.90
2	2688.00	29.40 AV	54.00	-24.60	1.31 H	347	-1.50	30.90
3	4874.00	45.50 PK	74.00	-28.50	1.38 H	19	9.00	36.50
3	4874.00	34.40 AV	54.00	-19.60	1.38 H	19	-2.10	36.50
4	7311.00	49.60 PK	74.00	-24.40	1.43 H	23	7.80	41.80
4	7311.00	37.50 AV	54.00	-16.50	1.43 H	23	-4.30	41.80

ANTENNA POLARITY & TEST DISTANCE: VERTICAL AT 3 M

No.	Freq. (MHz)	Emission Level (dBuV/m)	Limit (dBuV/m)	Margin (dB)	Antenna Height (m)	Table Angle (Degree)	Raw Value (dBuV)	Correction Factor (dB/m)
1	*2437.00	109.60 PK			1.27 V	353	79.60	30.00
1	*2437.00	101.20 AV			1.27 V	353	71.20	30.00
2	2688.00	43.60 PK	74.00	-30.40	1.26 V	18	12.70	30.90
2	2688.00	39.50 AV	54.00	-14.50	1.26 V	18	8.60	30.90
3	4874.00	46.20 PK	74.00	-27.80	1.47 V	28	9.70	36.50
3	4874.00	35.10 AV	54.00	-18.90	1.47 V	28	-1.40	36.50
4	7311.00	52.70 PK	74.00	-21.30	1.29 V	15	10.90	41.80
4	7311.00	40.70 AV	54.00	-13.30	1.29 V	15	-1.10	41.80

- REMARKS:**
1. Emission level(dBuV/m)=Raw Value(dBuV) + Correction Factor(dB/m)
 2. Correction Factor(dB/m) = Antenna Factor (dB/m) + Cable Factor (dB)
 3. The other emission levels were very low against the limit.
 4. Margin value = Emission level – Limit value.
 5. The limit value is defined as per 15.247
 6. “ * “ : Fundamental frequency



EUT	NetScreen-5GT ADSL Wireless	MODEL	NS-5GT-WIRELESS ADSL A
MODE	Channel 11	FREQUENCY RANGE	1000~25000MHz
INPUT POWER (SYSTEM)	120Vac, 60 Hz	DETECTOR FUNCTION & BANDWIDTH	Peak (PK) Average (AV) 1 MHz
ENVIRONMENTAL CONDITIONS	26 deg. C, 66%RH, 977 hPa	TESTED BY	Sky Liao

ANTENNA POLARITY & TEST DISTANCE: HORIZONTAL AT 3 M

No.	Freq. (MHz)	Emission Level (dBuV/m)	Limit (dBuV/m)	Margin (dB)	Antenna Height (m)	Table Angle (Degree)	Raw Value (dBuV)	Correction Factor (dB/m)
1	*2462.00	93.60 PK			1.09 H	25	63.50	30.10
1	*2462.00	85.20 AV			1.09 H	25	55.10	30.10
2	2483.50	43.90 PK	74.00	-30.10	1.09 H	25	13.80	30.10
2	2483.50	35.90 AV	54.00	-18.10	1.09 H	25	5.80	30.10
3	2688.00	40.10 PK	74.00	-33.90	1.34 H	351	9.20	30.90
3	2688.00	30.20 AV	54.00	-23.80	1.34 H	351	-0.70	30.90
4	4924.00	46.10 PK	74.00	-27.90	1.35 H	14	9.40	36.70
4	4924.00	35.10 AV	54.00	-18.90	1.35 H	14	-1.60	36.70
5	7386.00	50.20 PK	74.00	-23.80	1.46 H	24	8.40	41.80
5	7386.00	37.80 AV	54.00	-16.20	1.46 H	24	-4.00	41.80

ANTENNA POLARITY & TEST DISTANCE: VERTICAL AT 3 M

No.	Freq. (MHz)	Emission Level (dBuV/m)	Limit (dBuV/m)	Margin (dB)	Antenna Height (m)	Table Angle (Degree)	Raw Value (dBuV)	Correction Factor (dB/m)
1	*2462.00	109.80 PK			1.28 V	354	79.70	30.10
1	*2462.00	101.50 AV			1.28 V	354	71.40	30.10
2	2483.50	60.80 PK	74.00	-13.20	1.28 V	354	30.70	30.10
2	2483.50	52.20 AV	54.00	-1.80	1.28 V	354	22.10	30.10
3	2688.00	45.20 PK	74.00	-28.80	1.31 V	8	14.30	30.90
3	2688.00	41.30 AV	54.00	-12.70	1.31 V	8	10.40	30.90
4	4924.00	46.50 PK	74.00	-27.50	1.43 V	31	9.80	36.70
4	4924.00	35.60 AV	54.00	-18.40	1.43 V	31	-1.10	36.70
5	7386.00	51.90 PK	74.00	-22.10	1.27 V	19	10.10	41.80
5	7386.00	41.10 AV	54.00	-12.90	1.27 V	19	-0.70	41.80

- REMARKS:**
1. Emission level(dBuV/m)=Raw Value(dBuV) + Correction Factor(dB/m)
 2. Correction Factor(dB/m) = Antenna Factor (dB/m) + Cable Factor (dB)
 3. The other emission levels were very low against the limit.
 4. Margin value = Emission level – Limit value.
 5. The limit value is defined as per 15.247
 6. “ * “ : Fundamental frequency



4.3 6dB BANDWIDTH MEASUREMENT

4.3.1 LIMITS OF 6dB BANDWIDTH MEASUREMENT

The minimum of 6dB Bandwidth Measurement is 0.5 MHz.

4.3.2 TEST INSTRUMENTS

Description & Manufacturer	Model No.	Serial No.	Calibrated Until
R&S SPECTRUM ANALYZER	FSP40	100036	Nov. 23, 2005

NOTE:

- 1.The measurement uncertainty is less than +/- 2.6dB, which is calculated as per the NAMAS document NIS81.
- 2.The calibration interval of the above test instruments is 12 months and the calibrations are traceable to NML/ROC and NIST/USA.

4.3.3 TEST PROCEDURE

The transmitter output was connected to the spectrum analyzer through an attenuator. The bandwidth of the fundamental frequency was measured by spectrum analyzer with 100 kHz RBW and 100 kHz VBW. The 6 dB bandwidth is defined as the total spectrum the power of which is higher than peak power minus 6 dB.

4.3.4 TEST SETUP



For the actual test configuration, please refer to the related Item – Photographs of the Test Configuration.

4.3.5 EUT OPERATING CONDITIONS

The software(ART 48build5) provided by client to enable the EUT under transmission condition continuously at lowest, middle and highest channel frequencies individually.



4.3.6 TEST RESULTS – DSSS

EUT	NetScreen-5GT ADSL Wireless		
MODEL	NS-5GT-WIRELESS ADSL A	ENVIRONMENTAL CONDITIONS	26 deg. C, 65%RH, 977 hPa
INPUT POWER (SYSTEM)	120Vac, 60 Hz	TESTED BY	Sky Liao

CHANNEL	CHANNEL FREQUENCY (MHz)	6 dB BANDWIDTH (MHz)	MINIMUM LIMIT (MHz)	PASS/FAIL
1	2412	11.85	0.5	PASS
6	2437	11.70	0.5	PASS
11	2462	11.25	0.5	PASS



CH1

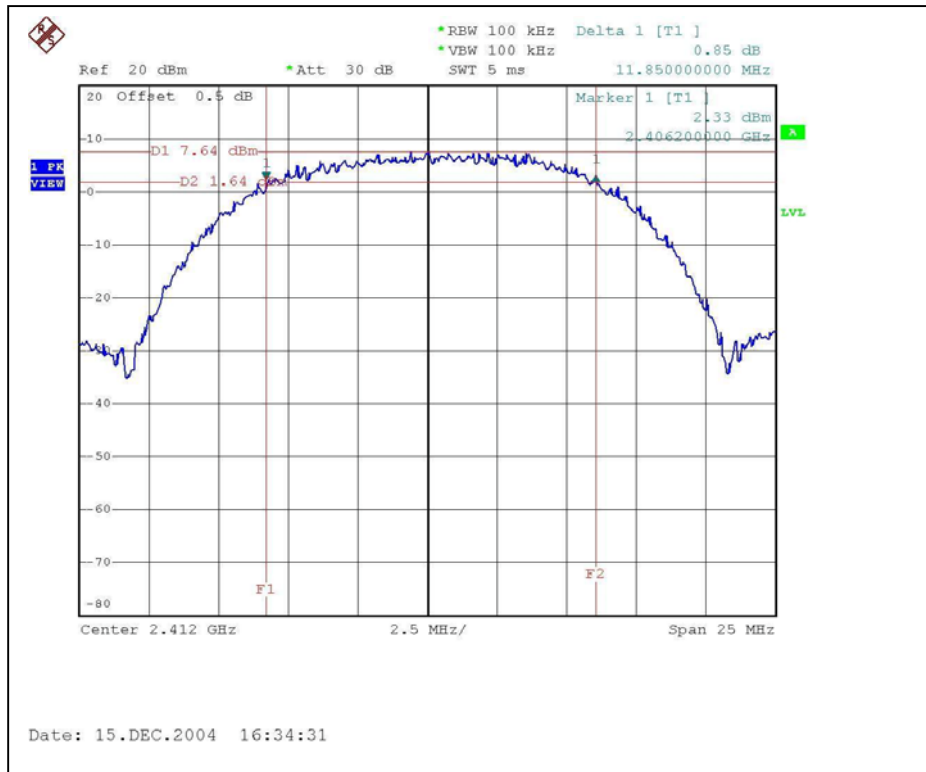

CH6

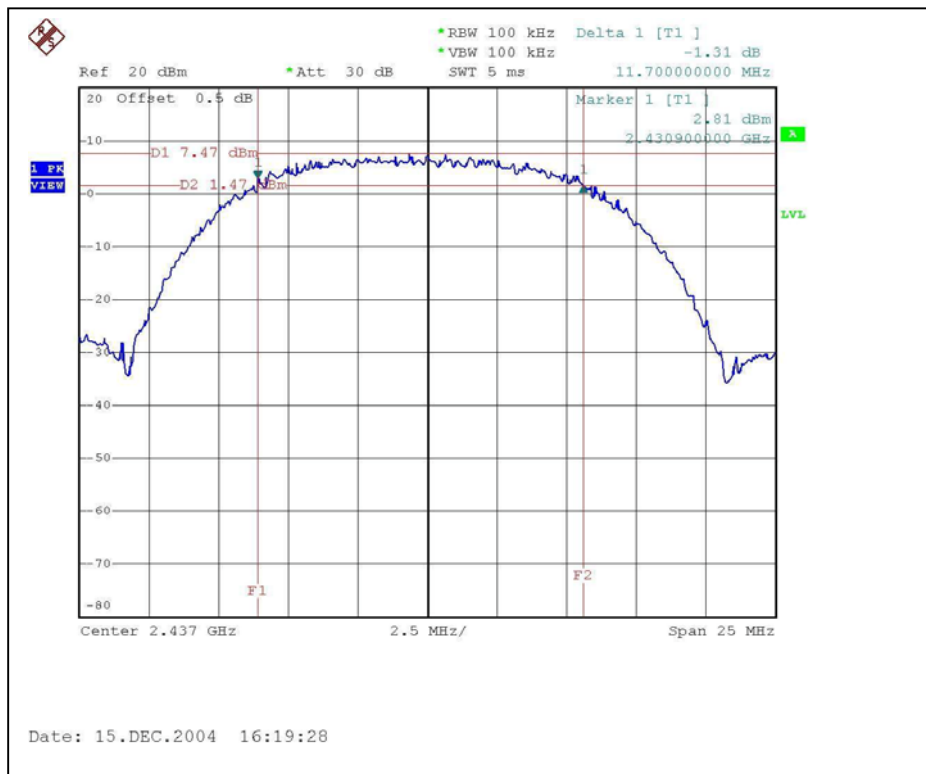



CH11

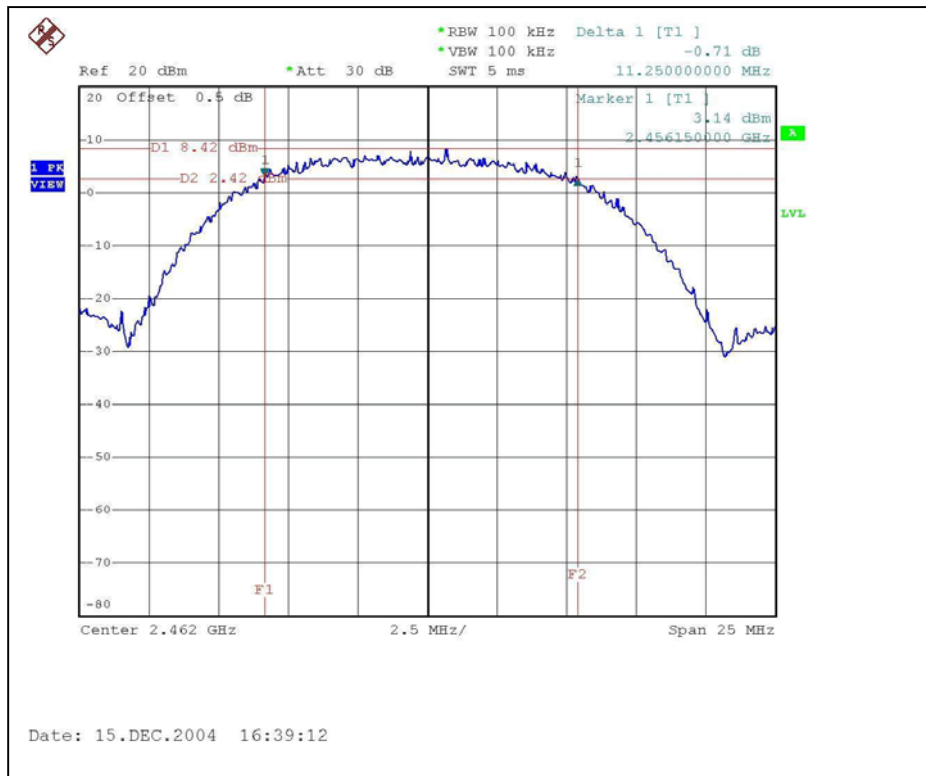



4.3.7 TEST RESULTS – OFDM

EUT	NetScreen-5GT ADSL Wireless		
MODEL	NS-5GT-WIRELESS ADSL A	ENVIRONMENTAL CONDITIONS	26 deg. C, 65%RH, 977 hPa
INPUT POWER (SYSTEM)	120Vac, 60 Hz	TESTED BY	Sky Liao

CHANNEL	CHANNEL FREQUENCY (MHz)	6 dB BANDWIDTH (MHz)	MINIMUM LIMIT (MHz)	PASS/FAIL
1	2412	16.35	0.5	PASS
6	2437	16.00	0.5	PASS
11	2462	15.95	0.5	PASS



CH1

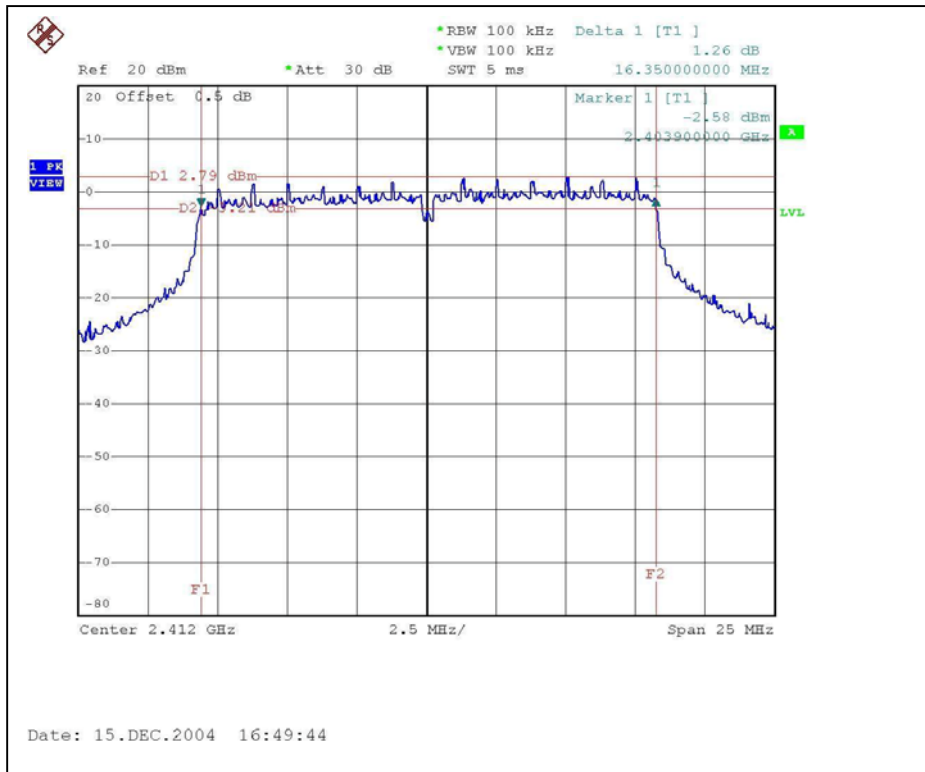

CH6

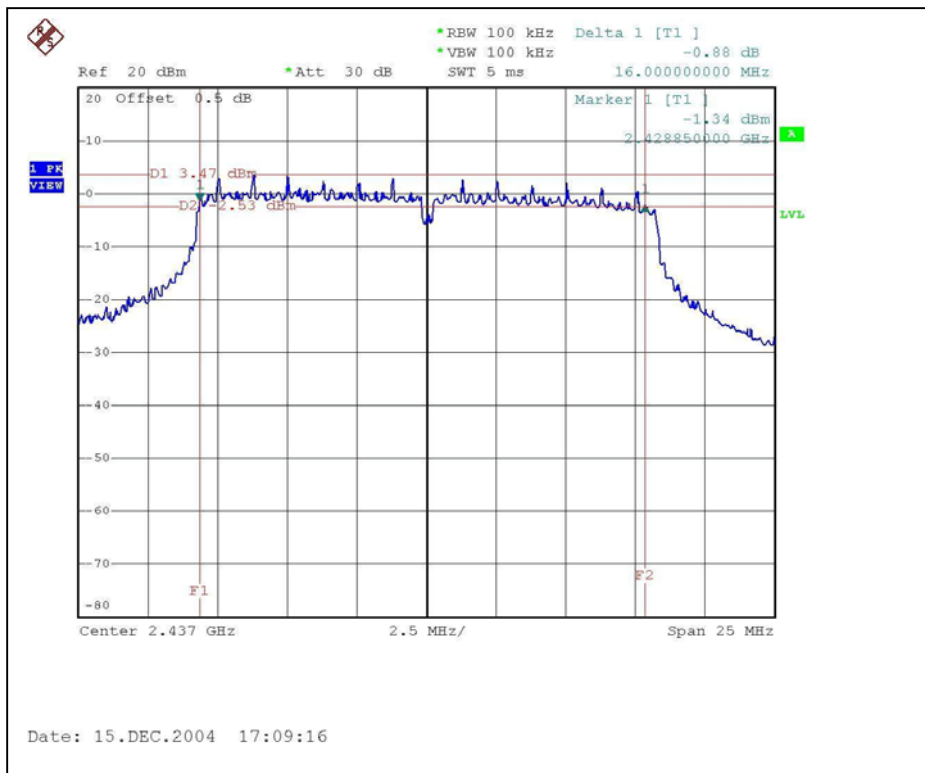



CH11

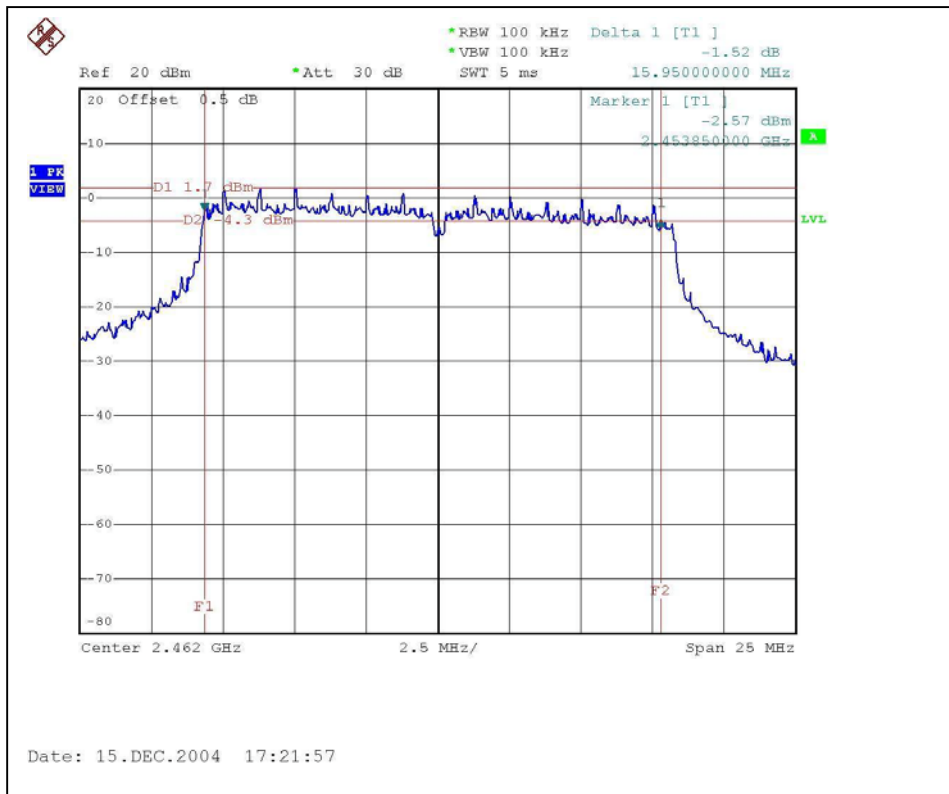



4.4 MAXIMUM PEAK OUTPUT POWER

4.4.1 LIMITS OF MAXIMUM PEAK OUTPUT POWER MEASUREMENT

The Maximum Peak Output Power Measurement is 30dBm.

4.4.2 TEST INSTRUMENTS

Description & Manufacturer	Model No.	Serial No.	Calibrated Until
R&S SPECTRUM ANALYZER	FSP40	100036	Nov. 23, 2005
Agilent SIGNAL GENERATOR	E8257C	MY43321031	May. 06, 2005
TEKTRONIX OSCILLOSCOPE	TDS 220	B027241	Jun. 30, 2005
NARDA DETECTOR	4503A	FSCM99899	NA

NOTE:

The calibration interval of the above test instruments is 12 months and the calibrations are traceable to NML/ROC and NIST/USA.

4.4.3 TEST PROCEDURES

1. A detector was used on the output port of the EUT. An oscilloscope was used to read the peak response of the detector.
2. Replaced the EUT by the signal generator. The center frequency of the S.G was adjusted to the center frequency of the measured channel.
3. Adjusted the power to have the same peak reading on oscilloscope. Record the power level.

4.4.4 TEST SETUP

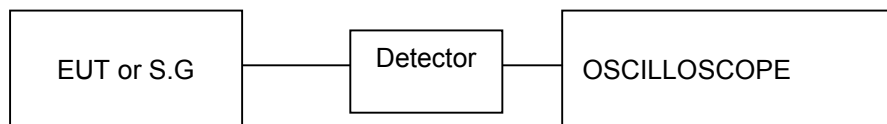

4.4.5 EUT OPERATING CONDITIONS

Same as Item 4.3.5



4.4.6 TEST RESULTS - DSSS

EUT	NetScreen-5GT ADSL Wireless		
MODEL	NS-5GT-WIRELESS ADSL A	ENVIRONMENTAL CONDITIONS	26 deg. C, 65%RH, 977 hPa
INPUT POWER (SYSTEM)	120Vac, 60 Hz	TESTED BY	Sky Liao

CHANNEL	CHANNEL FREQUENCY (MHz)	PEAK POWER OUTPUT (dBm)	PEAK POWER LIMIT (dBm)	PASS/FAIL
1	2412	21.54	30	PASS
6	2437	21.13	30	PASS
11	2462	21.08	30	PASS



4.4.7 TEST RESULTS - OFDM

EUT	NetScreen-5GT ADSL Wireless		
MODEL	NS-5GT-WIRELESS ADSL A	ENVIRONMENTAL CONDITIONS	26 deg. C, 65%RH, 977 hPa
INPUT POWER (SYSTEM)	120Vac, 60 Hz	TESTED BY	Sky Liao

CHANNEL	CHANNEL FREQUENCY (MHz)	PEAK POWER OUTPUT (dBm)	PEAK POWER LIMIT (dBm)	PASS/FAIL
1	2412	21.83	30	PASS
6	2437	22.02	30	PASS
11	2462	20.87	30	PASS