

SAR EVALUATION REPORT

For

Simoco Australasia Pty Ltd

1270 Ferntree Gully Road, Scoresby, Melbourne, Victoria, Australia

FCC ID: STZSDP600TU

Report Type: Class II Permissive Change	Product Type: SDP650 TU and SDP660 TU Two-Way Radio
Report Number:	RSZ161101012-20AA1
Report Date:	2017-01-08
Reviewed By:	Manager <i>Jesse Huang</i>
Prepared By:	Bay Area Compliance Laboratories Corp. (Kunshan) No.248 Chenghu Road, Kunshan, Jiangsu province, China Tel: +86-0512-86175000 Fax: +86-0512-88934268 www.baclcorp.com.cn

Attestation of Test Results					
EUT Information		Company Name	Simoco Australasia Pty Ltd		
		EUT Description	SDP650 TU and SDP660 TU Two-Way Radio		
		Model Number	SDP650 TU, SDP660 TU		
		FCC ID	STZSDP600TU		
		Serial Number	16110101203		
		Test Date	2016-12-08 and 2016-12-09		
Freq (MHz)	Model	Modulation	Max. SAR Level(s) Reported (1g-SAR)		Limit (W/Kg)
406.1 - 480	SDP660 TU	Digital	12.5kHz	Face up: 1.82 W/kg (<i>corrected by Multiplying 50 %.</i>) Body-Back: 2.01 W/kg (<i>corrected by Multiplying 50 %.</i>)	8.0
		Analog	12.5kHz	Face up: 3.21 W/kg (<i>corrected by Multiplying 50 %.</i>) Body-Back: 3.46 W/kg (<i>corrected by Multiplying 50 %.</i>)	
	SDP650 TU	Digital	12.5kHz	Face up: 1.68 W/kg (<i>corrected by Multiplying 50 %.</i>) Body-Back: 1.89 W/kg (<i>corrected by Multiplying 50 %.</i>)	
		Analog	12.5kHz	Face up: 3.12 W/kg (<i>corrected by Multiplying 50 %.</i>) Body-Back: 3.34 W/kg (<i>corrected by Multiplying 50 %.</i>)	
Applicable Standards		Part 2.1093 Radiofrequency radiation exposure evaluation: portable devices.			
		IEC62209-2:2010 Human exposure to radio frequency fields from hand-held and body-mounted wireless communication devices – Human models, instrumentation, and procedures – Part 2: Procedure to determine the specific absorption rate (SAR) for wireless communication devices used in close proximity to the human body.			
		IEEE1528:2013 IEEE Recommended Practice for Determining the Peak Spatial-Average Specific Absorption Rate (SAR) in the Human Head from Wireless Communications Devices: Measurement Techniques			
		KDB procedures KDB 447498 D01 v06: Mobile and Portable Devices RF Exposure Procedures and Equipment Authorization Policies. KDB 865664 D01v01r04: SAR measurement 100 MHz to 6 GHz v01. KDB 865664 D02 RF Exposure Reporting v01r02 KDB 643646D01 v01r03: SAR test Reduction Considerations for Occupational PTT Radios.			
<p>Note: This wireless device has been shown to be capable of compliance for localized specific absorption rate SAR for Occupational /Controlled Exposure Environment limits specified in ANSI/IEEE Standards and has been tested in accordance with the measurement procedures specified in IEEE 1528-2013 and RF exposure KDB procedures.</p> <p>The results and statements contained in this report pertain only to the device(s) evaluated.</p>					

TABLE OF CONTENTS

DOCUMENT REVISION HISTORY4

EUT DESCRIPTION5

TECHNICAL SPECIFICATION5

REFERENCE, STANDARDS, AND GUIDELINES6

SAR LIMITS7

FACILITIES.....8

POWER REFERENCE MEASUREMENT9

AREA SCAN9

ZOOM SCAN10

POWER DRIFT MEASUREMENT10

Z-SCAN10

DESCRIPTION OF TEST SYSTEM 11

EQUIPMENT LIST AND CALIBRATION16

EQUIPMENTS LIST & CALIBRATION INFORMATION 16

SAR MEASUREMENT SYSTEM VERIFICATION17

LIQUID VERIFICATION17

EUT TEST STRATEGY AND METHODOLOGY22

CONDUCTED OUTPUT POWER MEASUREMENT24

PROVISION APPLICABLE24

TEST PROCEDURE24

SAR MEASUREMENT RESULTS26

APPENDIX A MEASUREMENT UNCERTAINTY29

DOCUMENT REVISION HISTORY

Revision Number	Report Number	Description of Revision	Date of Revision
0	SAR_Report_TRaC_60320_6130147_FCC_SDP660_V2	Original Report	2013-07-24
1	RSZ161101012-20AA1	Class II Permissive Change	2017-01-08

Note: This is the Class II Permissive Change application of the device. The difference between the original device and the current one is as follows:

1. Change the antenna.

Base on the difference above, we retest SAR item.

EUT DESCRIPTION

This report has been prepared on behalf of Simoco Australasia Pty Ltd and their product, FCC ID: STZSDP600TU, Model: SDP650 TU,SDP660 TU or the EUT (Equipment under Test) as referred to in the rest of this report.

Note:

1. This series products model: SDP650 TU and SDP660 TU, the difference between SDP650 TU and SDP660 TU is that they have different screen size and keyboard, we select SDP660 TU model as main test model, and select the worst case for the SDP650 TU model to test, there is no other electrical change has been made to the two model equipment, please refer to the product similarity letter.
2. All measurement and test data in this report was gathered from production sample serial number: 16110101203(Assigned by BACL, Kunshan). The EUT supplied by the applicant was received on 2016-11-24.

Technical Specification

Product Type	Portable
Exposure Category:	Occupational/Controlled Exposure
Antenna Type(s):	External Antenna
Body-Worn Accessories:	Belt Clip and Headset Cable
Face-Head Accessories:	None
Modulation Type:	4FSK&FM
Frequency Band:	406.1-480MHz
Dimensions (L*W*H):	151 mm (L)×65 mm (W)×41 mm (H)
Exclusion antenna	
Power Source:	7.4V Rechargeable Li-ION Battery
Normal Operation:	Face Up and Body-worn

REFERENCE, STANDARDS, AND GUIDELINES

FCC:

The Report and Order requires routine SAR evaluation prior to equipment authorization of portable transmitter devices, including portable telephones. For portable devices, the RF radiation exposure evaluation requirement was provided in part 2.1093. According to KDB447498 D01 “General RF Exposure Guidance”, the device should be evaluated at maximum output power (radiated from the antenna) under “worst-case” conditions for normal or intended use, incorporating normal antenna operating positions, device peak performance frequencies and positions for maximum RF energy coupling.

This report describes the methodology and results of experiments performed on wireless data terminal. The objective was to determine if there is RF radiation and if radiation is found, what is the extent of radiation with respect to safety limits. SAR (Specific Absorption Rate) is the measure of RF exposure determined by the amount of RF energy absorbed by human body (or its parts) – to determine how the RF energy couples to the body or head which is a primary health concern for body worn devices.

CE:

The order requires routine SAR evaluation prior to equipment authorization of portable transmitter devices, including portable telephones. For portable devices, the limitation of exposure of the general public to electromagnetic fields was recommended on Council Recommendation 1999/519/EC. According to the Standard IEC62209-1/2, the device should be evaluated at maximum output power (radiated from the antenna) under “worst-case” conditions for normal or intended use, incorporating normal antenna operating positions, device peak performance frequencies and positions for maximum RF energy coupling.

This report describes the methodology and results of experiments performed on wireless data terminal. The objective was to determine if there is RF radiation and if radiation is found, what is the extent of radiation with respect to safety limits. SAR (Specific Absorption Rate) is the measure of RF exposure determined by the amount of RF energy absorbed by human body (or its parts) – to determine how the RF energy couples to the body or head which is a primary health concern for body portable devices.

The test configurations were laid out on a specially designed test fixture to ensure the reproducibility of measurements. Each configuration was scanned for SAR. Analysis of each scan was carried out to characterize the above effects in the device.

SAR Limits

FCC Limit (1g Tissue)

EXPOSURE LIMITS	SAR (W/kg)	
	(General Population / Uncontrolled Exposure Environment)	(Occupational / Controlled Exposure Environment)
Spatial Average (averaged over the whole body)	0.08	0.4
Spatial Peak (averaged over any 1 g of tissue)	1.60	8.0
Spatial Peak (hands/wrists/feet/ankles averaged over 10 g)	4.0	20.0

CE Limit (10g Tissue)

EXPOSURE LIMITS	SAR (W/kg)	
	(General Population / Uncontrolled Exposure Environment)	(Occupational / Controlled Exposure Environment)
Spatial Average (averaged over the whole body)	0.08	0.4
Spatial Peak (averaged over any 10 g of tissue)	2.0	10
Spatial Peak (hands/wrists/feet/ankles averaged over 10 g)	4.0	20.0

Population/Uncontrolled Environments are defined as locations where there is the exposure of individual who have no knowledge or control of their exposure.

Occupational/Controlled Environments are defined as locations where there is exposure that may be incurred by people who are aware of the potential for exposure (i.e. as a result of employment or occupation).

FACILITIES

The test site used by Bay Area Compliance Laboratories Corp. (Kunshan) to collect test data is located on No.248 Chenghu Road, Kunshan, Jiangsu province, China.

DASY4 SAR Evaluation Procedure

Power Reference Measurement

The Power Reference Measurement and Power Drift Measurement jobs are useful jobs for monitoring the power drift of the device under test in the batch process. Both jobs measure the field at a specified reference position, at a selectable distance from the phantom surface. The reference position can be either the selected section's grid reference point or a user point in this section. The reference job projects the selected point onto the phantom surface, orients the probe perpendicularly to the surface, and approaches the surface using the selected detection method. The Minimum distance of probe sensors to surface determines the closest measurement point to phantom surface. By default, the Minimum distance of probe sensors to surface is 4mm. This distance can be modified by the user, but cannot be smaller than the Distance of sensor calibration points to probe tip as defined in the probe properties.

Area Scan

The Area Scan is used as a fast scan in two dimensions to find the area of high field values, before doing a finer measurement around the hot spot. The sophisticated interpolation routines implemented in DASY4 software can find the maximum locations even in relatively coarse grids.

The scanning area is defined by an editable grid. This grid is anchored at the grid reference point of the selected section in the phantom. When the Area Scan's property sheet is brought-up, grid settings can be edited by a user.

When an Area Scan has measured all reachable points, it computes the field maxima found in the scanned area, within a range of the global maximum. The range (in dB) is specified in the standards for compliance testing. For example, a 2 dB range is required in IEEE 1528-2013, IEC 62209-1:2006 and IEC 62209-2:2010 standards, whereby 3 dB is a requirement when compliance is assessed in accordance with the ARIB standard (Japan). If only one Zoom Scan follows the Area Scan, then only the absolute maximum will be taken as reference. For cases where multiple maximums are detected, the number of Zoom Scans has to be increased accordingly.

After measurement is completed, all maxima and their coordinates are listed in the Results property page. The maximum selected in the list is highlighted in the 3-D view. For the secondary maxima returned from an Area Scan, the user can specify a lower limit (peak SAR value), in addition to the Find secondary maxima within x dB condition. Only the primary maximum and any secondary maxima within x dB from the primary maximum and above this limit will be measured.

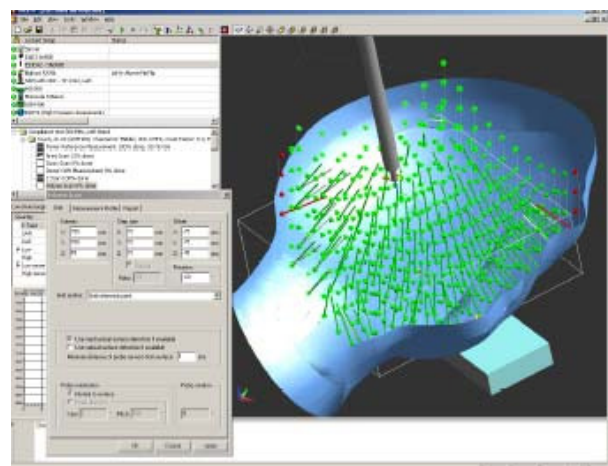
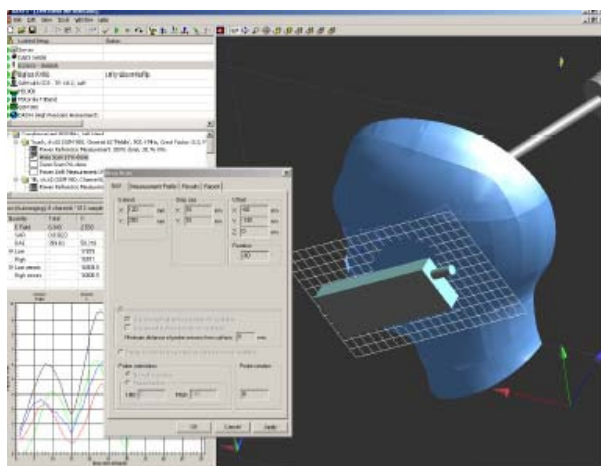

Zoom Scan

Zoom Scans are used to assess the peak spatial SAR values within a cubic averaging volume containing 1 g and 10 g of simulated tissue. The default Zoom Scan measures 5 x 5 x 7 points within a cube whose base faces are centered around the maxima found in a preceding area scan job within the same procedure. When the measurement is done, the Zoom Scan evaluates the averaged SAR for 1 g and 10 g and displays these values next to the job's label.

Power drift measurement

The Power Drift Measurement job measures the field at the same location as the most recent power reference measurement job within the same procedure, and with the same settings. The Power Drift Measurement gives the field difference in dB from the reading conducted within the last Power Reference Measurement. Several drift measurements are possible for one reference measurement. This allows a user to monitor the power drift of the device under test within a batch process. The measurement procedure is the same as Step 1.

Z-Scan

The Z Scan job measures points along a vertical straight line. The line runs along the Z axis of a one-dimensional grid. A user can anchor the grid to the section reference point, to any defined user point or to the current probe location. As with any other grids, the local Z axis of the anchor location establishes the Z axis of the grid.

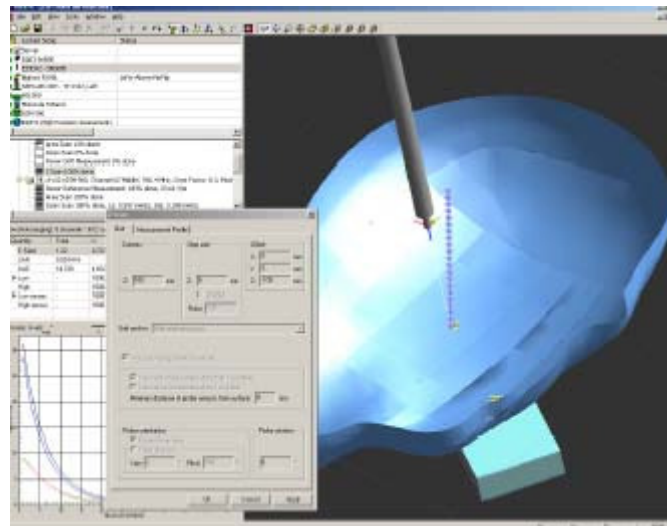

DESCRIPTION OF TEST SYSTEM

These measurements were performed with the automated near-field scanning system DASY4 from Schmid & Partner Engineering AG (SPEAG) which is the Fifth generation of the system shown in the figure hereinafter:



DASY4 System Description

The DASY4 system for performing compliance tests consists of the following items:

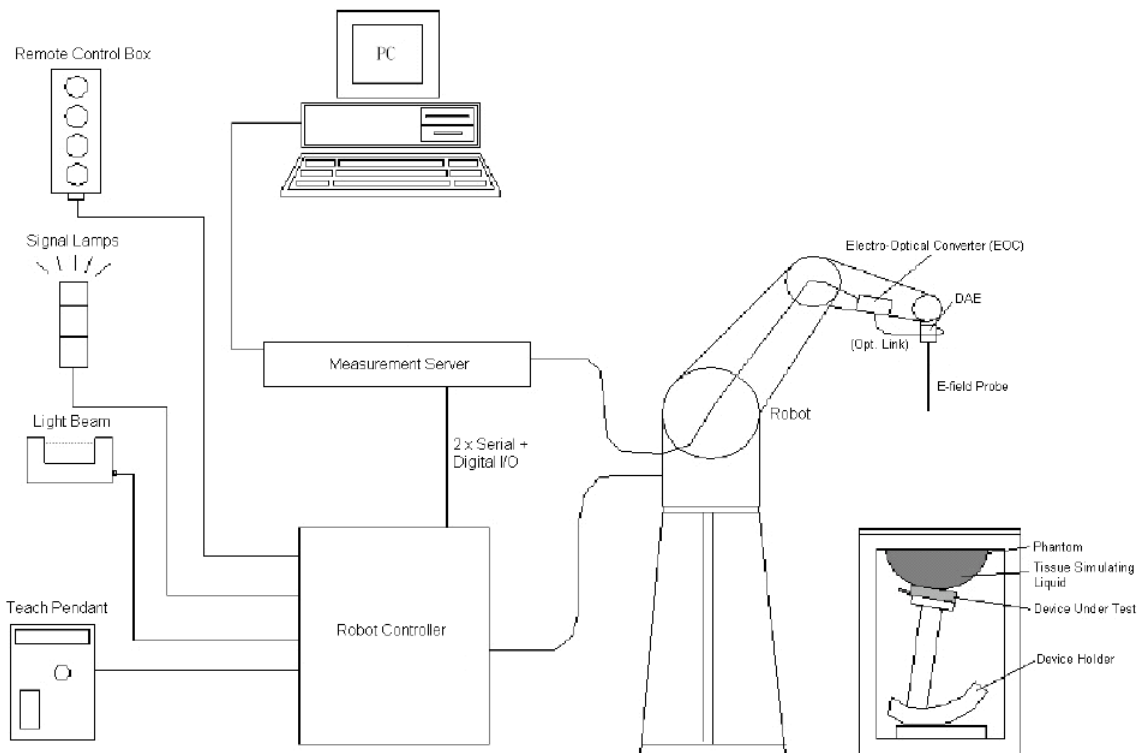

- A standard high precision 6-axis robot (Staubli TX=RX family) with controller, teach pendant and software. An arm extension for accommodating the data acquisition electronics (DAE).
- An isotropic field probe optimized and calibrated for the targeted measurement.
- A data acquisition electronics (DAE) which performs the signal amplification, signal multiplexing, AD-conversion, offset measurements, mechanical surface detection, collision detection, etc. The unit is battery powered with standard or rechargeable batteries. The signal is optically transmitted to the EOC.
- The Electro-optical converter (EOC) performs the conversion from optical to electrical signals for the digital communication to the DAE. To use optical surface detection, a special version of the EOC is required. The EOC signal is transmitted to the measurement server.
- The function of the measurement server is to perform the time critical tasks such as signal filtering, control of the robot operation and fast movement interrupts.
- The Light Beam used is for probe alignment. This improves the (absolute) accuracy of the probe positioning.
- A computer running Win7 professional operating system and the DASY42 software.
- Remote control and teach pendant as well as additional circuitry for robot safety such as warning lamps, etc.
- The phantom, the device holder and other accessories according to the targeted measurement.

DASY4 Measurement Server

The DASY4 measurement server is based on a PC/104 CPU board with a 400MHz intel ULV Celeron, 128MB chip-disk and 128MB RAM. The necessary circuits for communication with the DAE4 (or DAE3) electronics box, as well as the 16 bit AD converter system for optical detection and digital I/O interface are contained on the DASY4 I/O board, which is directly connected to the PC/104 bus of the CPU board.



The measurement server performs all real-time data evaluation of field measurements and surface detection, controls robot movements and handles safety operation. The PC operating system cannot interfere with these time critical processes. All connections are supervised by a watchdog, and disconnection of any of the cables to the measurement server will automatically disarm the robot and disable all program-controlled robot movements. Furthermore, the measurement server is equipped with an expansion port which is reserved for future applications. Please note that this expansion port does not have a standardized point out, and therefore only devices provided by SPEAG can be connected. Devices from any other supplier could seriously damage the measurement server.

Data Acquisition Electronics

The data acquisition electronics (DAE4) consist of a highly sensitive electrometer-grade preamplifier with auto-zeroing, a channel and gain-switching multiplexer, a fast 16 bit AD-converter and a command decoder with a control logic unit. Transmission to the measurement server is accomplished through an optical downlink for data and status information, as well as an optical uplink for commands and the clock.

The mechanical probe mounting device includes two different sensor systems for frontal and sideways probe contacts. They are used for mechanical surface detection and probe collision detection.

The input impedance of both the DAE4 as well as of the DAE3 box is 200M Ω ; the inputs are symmetrical and floating. Common mode rejection is above 80 dB.

EX3DV4 E-Field Probes

Frequency	10 MHz to > 6 GHz Linearity: ± 0.2 dB (30 MHz to 6 GHz)
Directivity	± 0.3 dB in TSL (rotation around probe axis) ± 0.5 dB in TSL (rotation normal to probe axis)
Dynamic Range	10 μ W/g to > 100 mW/g Linearity: ± 0.2 dB (noise: typically < 1 μ W/g)
Dimensions	Overall length: 337 mm (Tip: 20 mm) Tip diameter: 2.5 mm (Body: 12 mm) Typical distance from probe tip to dipole centers: 1 mm
Application	High precision dosimetric measurements in any exposure scenario (e.g., very strong gradient fields); the only probe that enables compliance testing for frequencies up to 6 GHz with precision of better 30%.
Compatibility	DASY3, DASY4, DASY42 SAR and higher, EASY4/MRI

SAM Twin Phantom

The SAM twin phantom is a fiberglass shell phantom with 2mm shell thickness (except the ear region, where shell thickness increases to 6 mm). The phantom has three measurement areas:

- _ Left hand
- _ Right hand
- _ Flat phantom

The phantom table for the DASY systems based on the TX90XL and RX160L robots have the size of 100 x 50 x 85 cm (L x W x H). The phantom table for the compact DASY systems based on the RX60L robot have the size of 100 x 75 x 91 cm (L x W x H); these tables are reinforced for mounting of the robot onto the table.

For easy dislocation these tables have fork lift cut outs at the bottom.

The bottom plate contains three pairs of bolts for locking the device holder. The device holder positions are adjusted to the standard measurement positions in the three sections. Only one device holder is necessary if two phantoms are used (e.g., for different liquids)

A white cover is provided to cover the phantom during o_-periods to prevent water evaporation and changes in the liquid parameters. Free space scans of devices on top of this phantom cover are possible.

Three reference marks are provided on the phantom counter. These reference marks are used to teach the absolute phantom position relative to the robot.



Robots

The DASY4 system uses the high precision industrial robots RX90XL from Staubli SA (France). The TX robot family is the successor of the well known RX robot family and offers the same features important for our application:

- High precision (repeatability 0.02mm)
- High reliability (industrial design)
- Low maintenance costs (virtually maintenance free due to direct drive gears; no belt drives)
- Jerk-free straight movements (brushless synchron motors; no stepper motors)
- Low ELF interference (motor control fields shielded via the closed metallic construction shields)

The above mentioned robots are controlled by the Staubli CS8c robot controllers. All information regarding the use and maintenance of the robot arm and the robot controller is contained on the CDs delivered along with the robot. Paper manuals are available upon request direct from Staubli.

Area Scans

Area scans are defined prior to the measurement process being executed with a user defined variable spacing between each measurement point (integral) allowing low uncertainty measurements to be conducted. Scans defined for FCC applications utilize a 10mm² step integral, with 1mm interpolation used to locate the peak SAR area used for zoom scan assessments.

Where the system identifies multiple SAR peaks (which are within 25% of peak value) the system will provide the user with the option of assessing each peak location individually for zoom scan averaging.

Zoom Scan (Cube Scan Averaging)

The averaging zoom scan volume utilized in the DASY4 software is in the shape of a cube and the side dimension of a 1 g or 10 g mass is dependent on the density of the liquid representing the simulated tissue. A density of 1000 kg/m³ is used to represent the head and body tissue density and not the phantom liquid density, in order to be consistent with the definition of the liquid dielectric properties, i.e. the side length of the 1 g cube is 10mm, with the side length of the 10 g cube 21,5mm.

When the cube intersects with the surface of the phantom, it is oriented so that 3 vertices touch the surface of the shell or the center of a face is tangent to the surface. The face of the cube closest to the surface is modified in order to conform to the tangent surface.

The zoom scan integer steps can be user defined so as to reduce uncertainty, but normal practice for typical test applications (including FCC) utilize a physical step of 5x5x8 (8mmx8mmx5mm) providing a volume of 32mm³ in the X & Y axis, and 35mm in the Z axis.

Tissue Dielectric Parameters for Head and Body Phantoms

The head tissue dielectric parameters recommended by the IEEE SCC-34/SC-2 in P1528 have been incorporated in the following table. These head parameters are derived from planar layer models simulating the highest expected SAR for the dielectric properties and tissue thickness variations in a human head. Other head and body tissue parameters that have not been specified in P1528 are derived from the tissue dielectric parameters computed from the 4-Cole-Cole equations described in Reference [12] and extrapolated according to the head parameters specified in P1528.

Recommended Tissue Dielectric Parameters for Head and Body

Frequency (MHz)	Head Tissue		Body Tissue	
	ϵ_r	σ (S/m)	ϵ_r	σ (S/m)
150	52.3	0.76	61.9	0.80
300	45.3	0.87	58.2	0.92
450	43.5	0.87	56.7	0.94
835	41.5	0.90	55.2	0.97
900	41.5	0.97	55.0	1.05
915	41.5	0.98	55.0	1.06
1450	40.5	1.20	54.0	1.30
1610	40.3	1.29	53.8	1.40
1800-2000	40.0	1.40	53.3	1.52
2450	39.2	1.80	52.7	1.95
3000	38.5	2.40	52.0	2.73
5800	35.3	5.27	48.2	6.00

EQUIPMENT LIST AND CALIBRATION

Equipments List & Calibration Information

Equipment	Model	S/N	Calibration Date	Calibration Due Date
Robot	RX90	5L79A1	N/A	N/A
DASY4 Test Software	DASY4.5	N/A	N/A	N/A
DASY4 Measurement Server	DASY 4.5.12	1180	N/A	N/A
Data Acquisition Electronics	DAE4	772	2016/10/25	2017/10/24
E-Field Probe	EX3DV4	7441	2016/11/15	2017/11/14
Dipole, 450 MHz	D450V3	1096	2016/11/07	2019/11/06
Mounting Device	SD 000 H01 KA	N/A	N/A	N/A
Oval Flat Phantom	ELI V8.0	2051	N/A	N/A
Simulated Tissue 450 MHz Head	TS-450-H	N/A	Each Time	/
Simulated Tissue 450 MHz Body	TS-450-B	N/A	Each Time	/
Network Analyzer	8753B	2625A00809	2016/10/06	2017/10/05
S-Parameter Test Set	85047A	3033A02428	2016/10/06	2017/10/05
Dielectric probe kit	85070B	US33020324	N/A	N/A
Signal Generator	SMBV100A	261558	2016-07-04	2017-07-04
Power Meter	E4419B	MY41291878	2016/01/08	2017/01/07
Power Meter Sensor	E9301A	US39210953	2016/05/30	2017/05/29
Power Amplifier	10S1G4M1	18060	N/A	N/A
Directional Coupler	488Z	N/A	N/A	N/A
Attenuator	20dB, 100W	N/A	N/A	N/A
Attenuator	3dB, 150W	N/A	N/A	N/A

SAR MEASUREMENT SYSTEM VERIFICATION

Liquid Verification

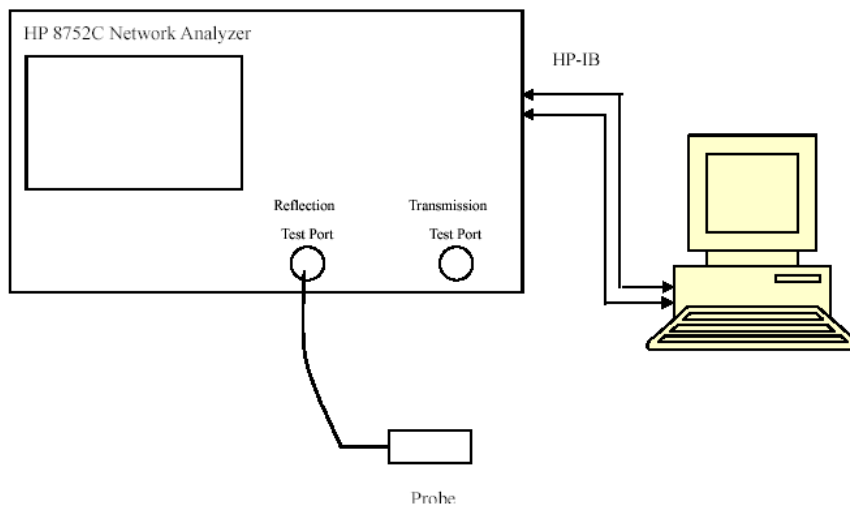

Liquid Verification Setup Block Diagram

Liquid Verification Results

Frequency (MHz)	Liquid Type	Liquid Parameter		Target Value		Delta (%)		Tolerance (%)
		ϵ_r	σ (S/m)	ϵ_r	σ (S/m)	$\Delta\epsilon_r$	$\Delta\sigma$ (S/m)	
406.1125	Simulated Tissue 450MHz Head	43.47	0.87	43.50	0.87	-0.069	0.000	±5
418.0125	Simulated Tissue 450MHz Head	43.63	0.88	43.50	0.87	0.299	1.149	±5
435.0125	Simulated Tissue 450MHz Head	43.74	0.87	43.50	0.87	0.552	0.000	±5
439.9875	Simulated Tissue 450MHz Head	43.75	0.88	43.50	0.87	0.575	1.149	±5
450	Simulated Tissue 450MHz Head	43.81	0.87	43.50	0.87	0.713	0.000	±5
450.0125	Simulated Tissue 450MHz Head	43.81	0.87	43.50	0.87	0.713	0.000	±5
464.0125	Simulated Tissue 450MHz Head	43.87	0.87	43.50	0.87	0.851	0.000	±5
479.9875	Simulated Tissue 450MHz Head	43.91	0.89	43.50	0.87	0.943	2.299	±5

*Liquid Verification was performed on 2016-12-08.

Frequency (MHz)	Liquid Type	Liquid Parameter		Target Value		Delta (%)		Tolerance (%)
		ϵ_r	σ (S/m)	ϵ_r	σ (S/m)	$\Delta\epsilon_r$	$\Delta\sigma$ (S/m)	
406.1125	Simulated Tissue 450MHz Body	56.74	0.96	56.70	0.94	0.071	2.128	±5
418.0125	Simulated Tissue 450MHz Body	56.80	0.96	56.70	0.94	0.176	2.128	±5
435.0125	Simulated Tissue 450MHz Body	56.86	0.95	56.70	0.94	0.282	1.064	±5
439.9875	Simulated Tissue 450MHz Body	56.88	0.95	56.70	0.94	0.317	1.064	±5
450	Simulated Tissue 450MHz Body	57.02	0.95	56.70	0.94	0.564	1.064	±5
450.0125	Simulated Tissue 450MHz Body	57.02	0.95	56.70	0.94	0.564	1.064	±5
464.0125	Simulated Tissue 450MHz Body	56.97	0.95	56.70	0.94	0.476	1.064	±5
479.9875	Simulated Tissue 450MHz Body	57.08	0.96	56.70	0.94	0.670	2.128	±5

*Liquid Verification was performed on 2016-12-09.

System Accuracy Verification

Prior to the assessment, the system validation kit was used to test whether the system was operating within its specifications of $\pm 10\%$. The validation results are tabulated below. And also the corresponding SAR plot is attached as well in the SAR plots files.

System Verification Setup Block Diagram

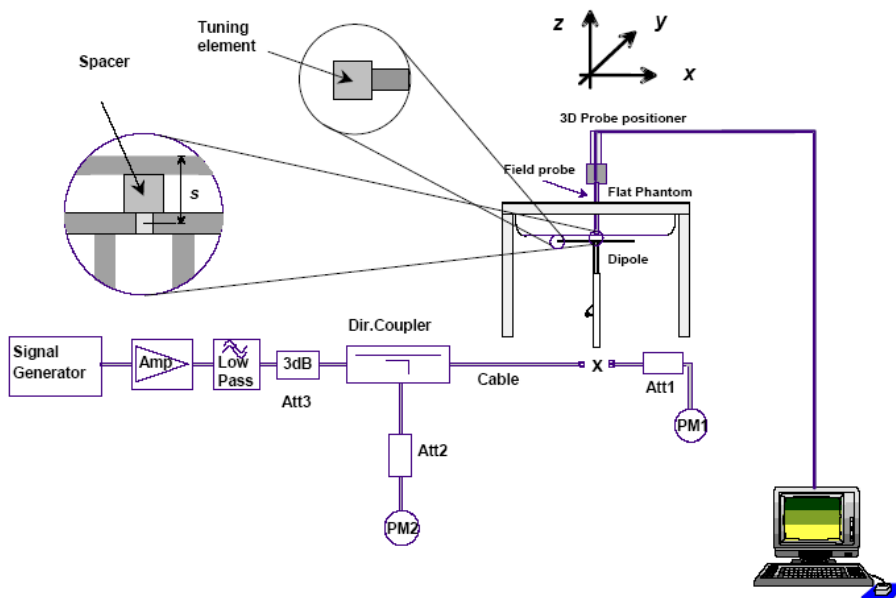

System Accuracy Check Results

Date	Frequency Band	Liquid Type	Measured SAR (W/Kg)		Target Value (W/Kg)	Delta (%)	Tolerance (%)
2016-12-08	450	Head	1g	4.46	4.53	-1.545	± 10
2016-12-09		Body	1g	4.83	4.55	6.154	± 10

Note:

The power inputted to dipole is 0.1 Watt; the SAR values are normalized to 1 Watt forward power by multiplying 10 times.

SAR SYSTEM VALIDATION DATA

Test Laboratory: Bay Area Compliance Labs Corp.(Kunshan)

DUT: Dipole 450 MHz; Type: D450V3; S/N: 1096

Program Name: 450 MHz Head

Communication System: CW; Frequency: 450 MHz; Duty Cycle: 1:1

Medium parameters used: $f = 450 \text{ MHz}$; $\sigma = 0.87 \text{ S/m}$; $\epsilon_r = 43.81$; $\rho = 1000 \text{ kg/m}^3$

Phantom section: Flat Section

DASY4 Configuration:

- Probe: EX3DV4 – SN7441; ConvF(10.98, 10.98, 10.98); Calibrated: 15/11/2016
- Sensor-Surface: 4mm (Mechanical Surface Detection)
- Electronics: DAE – SN772; Calibrated: 25/10/2016
- Phantom: ELI v8.0; Type: QDOVA004AA; Serial: TP-2051
- Measurement SW: DASY4, V4.5 Build 19; Postprocessing SW: SEMCAD, V1.8 Build 145

450 Head system check /Area Scan (91x181x1): Measurement grid: $dx=10\text{mm}$, $dy=10\text{mm}$

Maximum value of SAR (interpolated) = 0.512 mW/g

450 Head system check /Zoom Scan (7x7x7)/Cube 0: Measurement grid: $dx=5\text{mm}$, $dy=5\text{mm}$, $dz=5\text{mm}$

Reference Value = 26.8 V/m; Power Drift = 0.131 dB

Peak SAR (extrapolated) = 0.663 W/kg

SAR(1 g) = 0.446 mW/g; SAR(10 g) = 0.295 mW/g

Maximum value of SAR (measured) = 0.496 mW/g

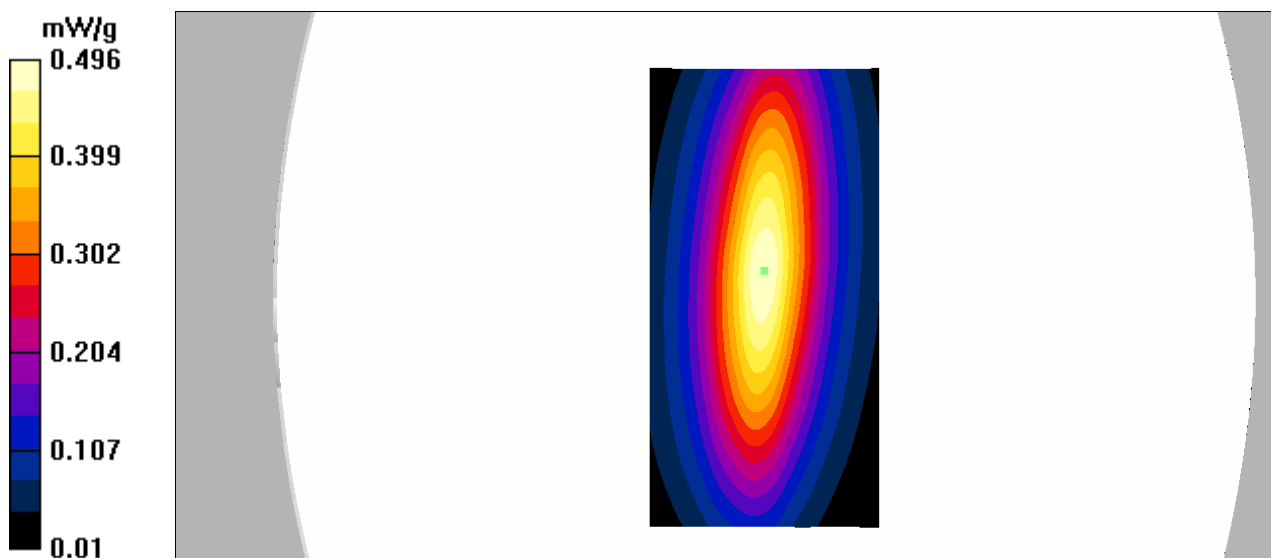

Test Laboratory: Bay Area Compliance Labs Corp.(Kunshan)

DUT: Dipole 450 MHz; Type: D450V3; S/N: 1096

Program Name: 450 MHz Body

Communication System: CW; Frequency: 450 MHz; Duty Cycle: 1:1

Medium parameters used: $f = 450 \text{ MHz}$; $\sigma = 0.95 \text{ S/m}$; $\epsilon_r = 57.02$; $\rho = 1000 \text{ kg/m}^3$

Phantom section: Flat Section

DASY4 Configuration:

- Probe: EX3DV4 – SN7441; ConvF(12.08, 12.08, 12.08); Calibrated: 15/11/2016
- Sensor-Surface: 4mm (Mechanical Surface Detection)
- Electronics: DAE – SN772; Calibrated: 25/10/2016
- Phantom: ELI v8.0; Type: QDOVA004AA; Serial: TP-2051
- Measurement SW: DASY4, V4.5 Build 19; Postprocessing SW: SEMCAD, V1.8 Build 145

450 Body system check /Area Scan (91x181x1): Measurement grid: $dx=10\text{mm}$, $dy=10\text{mm}$

Maximum value of SAR (interpolated) = 0.556 mW/g

450 Body system check /Zoom Scan (7x7x7)/Cube 0: Measurement grid: $dx=5\text{mm}$, $dy=5\text{mm}$, $dz=5\text{mm}$

Reference Value = 28.6 V/m; Power Drift = -0.039 dB

Peak SAR (extrapolated) = 0.679 W/kg

SAR(1 g) = 0.483 mW/g; SAR(10 g) = 0.32 mW/g

Maximum value of SAR (measured) = 0.522 mW/g

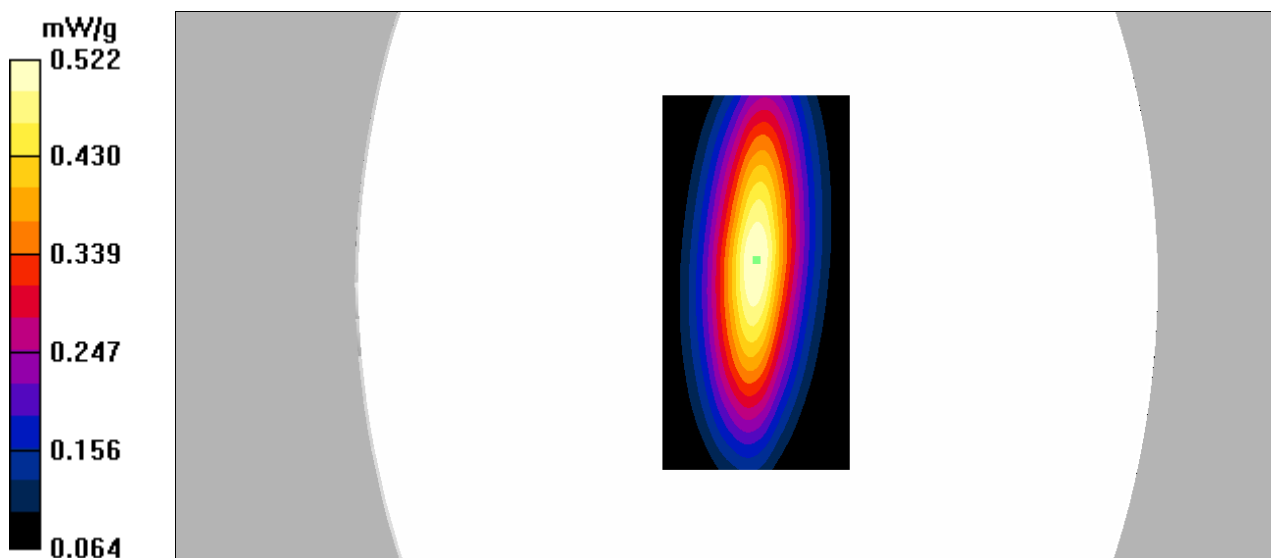

EUT TEST STRATEGY AND METHODOLOGY

Test Positions for front-of-face configurations

A typical example of a front-of-face device is a two-way radio that is held at a distance from the face of the user when transmitting. In these cases the device under test shall be positioned at the distance to the phantom surface that corresponds to the intended use as specified by the manufacturer in the user instructions. If the intended use is not specified, a separation distance of 25 mm between the phantom surface and the device shall be used.

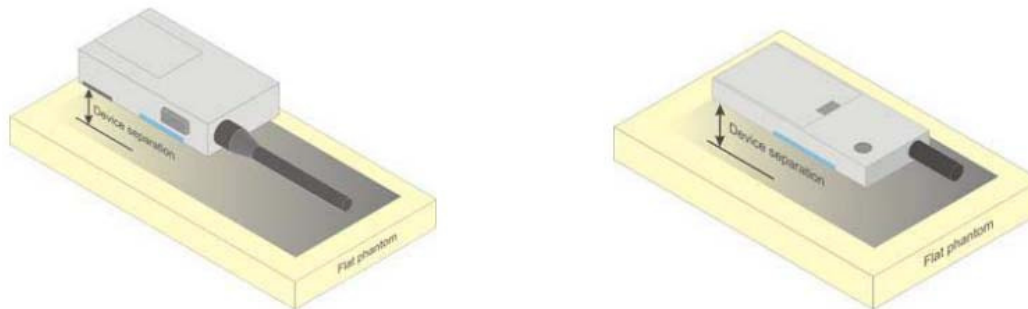

Test positions for body-worn and other configurations

Body-worn operating configurations should be tested with the belt-clips and holsters attached to the device and positioned against a flat phantom in normal use configurations. Devices with a headset output should be tested with a headset connected to the device. When multiple accessories that do not contain metallic components are supplied with the device, the device may be tested with only the accessory that dictates the closest spacing to the body. When multiple accessories that contain metallic components are supplied with the device, the device must be tested with each accessory that contains a unique metallic component. If multiple accessories share an identical metallic component (e.g., the same metallic belt-clip used with different holsters with no other metallic components), only the accessory that dictates the closest spacing to the body must be tested.

Body-worn accessories may not always be supplied or available as options for some devices that are intended to be authorized for body-worn use. A separation distance of 1.5 cm between the back of the device and a flat phantom is recommended for testing body-worn SAR compliance under such circumstances. Other separation distances may be used, but they should not exceed 2.5 cm. In these cases, the device may use body-worn accessories that provide a separation distance greater than that tested for the device provided however that the accessory contains no metallic components.

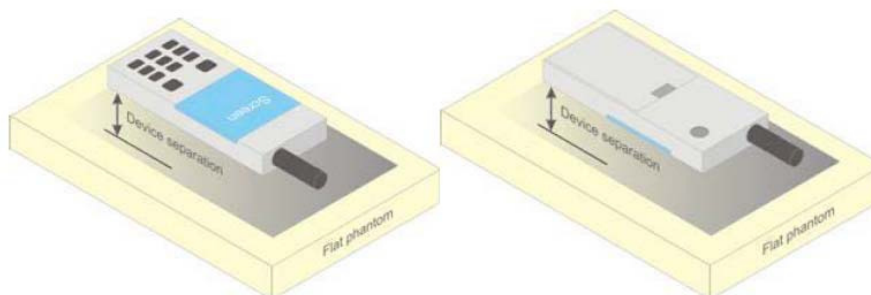

Figure 5 – Test positions for body-worn devices

For EUT Positioning Procedures

The EUT is a portable device operational at the body and face. The intended operating positions are "at the face" with the EUT at least 2.5cm from the mouth, and "at the body" by means of the offered body worn accessories. Body worn audio and PTT operation is accomplished by means of optional remote accessories that are connected to the radio.

Body

The EUT was positioned in normal use configuration against the phantom with the offered body worn accessory with the offered audio accessories as applicable

Head

Not applicable

Face

The EUT was positioned with its' front side separated 2.5cm from the phantom

SAR Evaluation Procedure

The evaluation was performed with the following procedure:

Step 1: Measurement of the SAR value at a fixed location above the ear point or central position was used as a reference value for assessing the power drop. The SAR at this point is measured at the start of the test and then again at the end of the testing.

Step 2: The SAR distribution at the exposed side of the head was measured at a distance of 4 mm from the inner surface of the shell. The area covered the entire dimension of the head or EUT and the horizontal grid spacing was 10 mm x 10 mm. Based on these data, the area of the maximum absorption was determined by spline interpolation. The first Area Scan covers the entire dimension of the EUT to ensure that the hotspot was correctly identified.

Step 3: Around this point, a volume of 30 mm x 30 mm x 30 mm was assessed by measuring 7x 7 x 7 points. On the basis of this data set, the spatial peak SAR value was evaluated under the following procedure:

- 1) The data at the surface were extrapolated, since the center of the dipoles is 1.2 mm away from the tip of the probe and the distance between the surface and the lowest measuring point is 1.3 mm. The extrapolation was based on a least square algorithm. A polynomial of the fourth order was calculated through the points in z-axes. This polynomial was then used to evaluate the points between the surface and the probe tip.
- 2) The maximum interpolated value was searched with a straightforward algorithm. Around this maximum the SAR values averaged over the spatial volumes (1 g or 10 g) were computed by the 3D-Spline interpolation algorithm. The 3D-Spline is composed of three one dimensional splines with the "Not a knot"-condition (in x, y and z-directions). The volume was integrated with the trapezoidal-algorithm. One thousand points (10 x 10 x 10) were interpolated to calculate the averages.

All neighboring volumes were evaluated until no neighboring volume with a higher average value was found.

Step 4: Re-measurement of the SAR value at the same location as in Step 1. If the value changed by more than 5%, the evaluation was repeated.

CONDUCTED OUTPUT POWER MEASUREMENT

Provision Applicable

The measured peak output power should be greater and within 5% than EMI measurement.

Test Procedure

The RF output of the transmitter was connected to the input of the Signal Analyzer through sufficient attenuation.

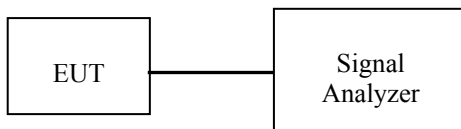

Maximum Output Power among production units

Max. tune-up tolerance power limit for Production Unit (dBm)	
PTT/Mode	Frequency(406.1-480MHz)
Digital-12.5K	37.00
Analog-12.5K	37.00

Test Results:

SDP660 TU

Mode	Frequency Spacing (kHz)	Frequency (MHz)	Output(dBm)	Output Power(W)	Power level
Digital	12.5	406.1125	36.86	4.853	High
		418.0125	36.95	4.955	High
		435.0125	36.86	4.853	High
		439.9875	36.82	4.808	High
		450.0125	36.92	4.764	High
		464.0125	36.78	4.920	High
		479.9875	36.80	4.786	High
Analog	12.5	406.1125	36.81	4.797	High
		418.0125	36.91	4.909	High
		435.0125	36.83	4.819	High
		439.9875	36.79	4.775	High
		450.0125	36.97	4.819	High
		464.0125	36.83	4.977	High
		479.9875	36.85	4.842	High

SDP650 TU

Mode	Frequency Spacing (kHz)	Frequency (MHz)	Output(dBm)	Output Power(W)	Power level
Digital	12.5	406.1125	36.85	4.842	High
		418.0125	36.94	4.943	High
		435.0125	36.83	4.819	High
		439.9875	36.82	4.808	High
		450.0125	36.89	4.753	High
		464.0125	36.77	4.887	High
		479.9875	36.77	4.753	High
Analog	12.5	406.1125	36.80	4.786	High
		418.0125	36.87	4.864	High
		435.0125	36.85	4.842	High
		439.9875	36.76	4.742	High
		450.0125	36.98	4.819	High
		464.0125	36.83	4.989	High
		479.9875	36.87	4.819	High

Note: The measurement was made in the room temperature.

SAR MEASUREMENT RESULTS

This page summarizes the results of the performed dosimetric evaluation.

SAR Test Data

Environmental Conditions

Temperature:	22.3-23.5 °C	21.9-22.3 °C
Relative Humidity:	52 %	50 %
ATM Pressure:	1013 mbar	1009 mbar
Test Date:	2016-12-08	2016-12-09

Testing was performed by Jack Xu, Apple Wu, Judy Huang.

Digital (Modulation 4FSK Channel Spacing 12.5 kHz):

Model number	Antenna	Frequency (MHz)	Max. Meas. Power (dBm)	Max. Rated Power (dBm)	1 g SAR Value (W/Kg)				
					Scaled Factor	Meas. SAR	Scaled SAR	50%	Plot
Face up (2.5cm)									
SDP660 TU	Antenna 1# (400-440MHz)	406.1125	/	/	/	/	/	/	/
		418.0125	36.95	37.00	1.012	2.75	2.78	1.39	1#
		439.9875	/	/	/	/	/	/	/
	Antenna 2# (435-485MHz)	435.0125	/	/	/	/	/	/	/
		450.0125	36.92	37.00	1.019	3.58	3.65	1.82	2#
		464.0125	/	/	/	/	/	/	/
SDP650 TU	Antenna 1# (400-440MHz)	418.0125	36.94	37.00	1.014	2.76	2.80	1.40	5#
	Antenna 2# (435-485MHz)	450.0125	36.89	37.00	1.026	3.27	3.35	1.68	6#
Body-Back with Belt Clip (0.0cm)									
SDP660 TU	Antenna 1# (400-440MHz)	406.1125	/	/	/	/	/	/	/
		418.0125	36.95	37.00	1.012	3.25	3.29	1.64	3#
		439.9875	/	/	/	/	/	/	/
	Antenna 2# (435-485MHz)	435.0125	/	/	/	/	/	/	/
		450.0125	36.92	37.00	1.019	3.95	4.02	2.01	4#
		464.0125	/	/	/	/	/	/	/
SDP650 TU	Antenna 1# (400-440MHz)	418.0125	36.94	37.00	1.014	2.39	2.42	1.21	7#
	Antenna 2# (435-485MHz)	450.0125	36.89	37.00	1.026	3.69	3.78	1.89	8#

Analog (Modulation FM; Channel Spacing 12.5 kHz):

Model number	Antenna	Frequency (MHz)	Max. Meas. Power (dBm)	Max. Rated Power (dBm)	1 g SAR Value (W/Kg)				
					Scaled Factor	Meas. SAR	Scaled SAR	50%	Plot
Face up (2.5cm)									
SDP660 TU	Antenna 1# (400-440MHz)	406.1125	/	/	/	/	/	/	/
		418.0125	36.91	37.00	1.021	5.28	5.39	2.70	9#
		439.9875	/	/	/	/	/	/	/
	Antenna 2# (435-485MHz)	435.0125	/	/	/	/	/	/	/
		450.0125	36.97	37.00	1.007	6.37	6.41	3.21	10#
		464.0125	/	/	/	/	/	/	/
SDP650 TU	Antenna 1# (400-440MHz)	418.0125	36.87	37.00	1.030	5.43	5.59	2.80	13#
	Antenna 2# (435-485MHz)	450.0125	36.98	37.00	1.005	6.21	6.24	3.12	14#
Body-Back with Belt Clip (0.0cm)									
SDP660 TU	Antenna 1# (400-440MHz)	406.1125	/	/	/	/	/	/	/
		418.0125	36.91	37.00	1.021	4.6	4.70	2.35	11#
		439.9875	/	/	/	/	/	/	/
	Antenna 2# (435-485MHz)	435.0125	/	/	/	/	/	/	/
		450.0125	36.97	37.00	1.007	6.87	6.92	3.46	12#
		464.0125	/	/	/	/	/	/	/
SDP650 TU	Antenna 1# (400-440MHz)	418.0125	36.87	37.00	1.030	5.05	5.20	2.60	15#
	Antenna 2# (435-485MHz)	450.0125	36.98	37.00	1.005	6.65	6.68	3.34	16#

Note:

1. When the 1-g SAR tested using the default battery and default accessories is $\leq 3.5W/Kg$ (corrected by Multiplying 50%), testing for other channels are optional.
2. For PTT, only simplex communication technology was supported, so the SAR value needs to be corrected by Multiplying 50%.
3. Passive body-worn and audio accessories generally do not apply to the head SAR of PTT radios.
4. The whole antenna and radiating structures that may contribute to the measured SAR or influence the SAR distribution has been included in the area scan.
5. This series products model: SDP650 TU and SDP660 TU, the difference between SDP650 TU and SDP660 TU is that they have different screen size and keyboard, we select SDP660 TU model as main test model to fully test, and select the worst case for the SDP650 TU model to test.

SAR Measurement Variability

In accordance with published RF Exposure KDB procedure 865664 D01 SAR measurement 100 MHz to 6 GHz v01. These additional measurements are repeated after the completion of all measurements requiring the same head or body tissue-equivalent medium in a frequency band. The test device should be returned to ambient conditions (normal room temperature) with the battery fully charged before it is re-mounted on the device holder for the repeated measurement(s) to minimize any unexpected variations in the repeated results

- 1) Repeated measurement is not required when the original highest measured SAR is < 0.80 W/kg.
- 2) When the original highest measured SAR is ≥ 0.80 W/kg, repeat that measurement once.
- 3) Perform a second repeated measurement only if the ratio of largest to smallest SAR for the original and first repeated measurements is > 1.20 or when the original or repeated measurement is ≥ 1.45 W/kg (~ 10% from the 1-g SAR limit).
- 4) Perform a third repeated measurement only if the original, first or second repeated measurement is ≥ 1.5 W/kg and the ratio of largest to smallest SAR for the original, first and second repeated measurements is > 1.20.
- 5) The same procedures should be adapted for measurements according to occupational exposure limits by applying a factor of 2.5 for extremity exposure and a factor of 5 for occupational exposure to the corresponding SAR thresholds.

The Highest Measured SAR Configuration in Each Frequency Band

Face up

Frequency Band	Freq.(MHz)	EUT Position	Meas. SAR (W/kg)		Largest to Smallest SAR Ratio
			Original	Repeated	
/	/	/	/	/	/

Body-Back with Belt Clip

Frequency Band	Freq.(MHz)	EUT Position	Meas. SAR (W/kg)		Largest to Smallest SAR Ratio
			Original	Repeated	
/	/	/	/	/	/

Note:

Second Repeated Measurement is not required since the ratio of the largest to smallest SAR for the original and first repeated measurement is not > 1.20.

APPENDIX A MEASUREMENT UNCERTAINTY

The uncertainty budget has been determined for the measurement system and is given in the following Table.

Measurement uncertainty evaluation for IEEE1528-2013 SAR test

Source of uncertainty	Tolerance/uncertainty ± %	Probability distribution	Divisor	ci (1 g)	ci (10 g)	Standard uncertainty ± %, (1 g)	Standard uncertainty ± %, (10 g)
Measurement system							
Probe calibration	6.55	N	1	1	1	6.6	6.6
Axial Isotropy	4.7	R	√3	1	1	2.7	2.7
Hemispherical Isotropy	9.6	R	√3	0	0	0.0	0.0
Boundary effect	1.0	R	√3	1	1	0.6	0.6
Linearity	4.7	R	√3	1	1	2.7	2.7
Detection limits	1.0	R	√3	1	1	0.6	0.6
Readout electronics	0.3	N	1	1	1	0.3	0.3
Response time	0.0	R	√3	1	1	0.0	0.0
Integration time	0.0	R	√3	1	1	0.0	0.0
RF ambient conditions – noise	1.0	R	√3	1	1	0.6	0.6
RF ambient conditions–reflections	1.0	R	√3	1	1	0.6	0.6
Probe positioner mech. Restrictions	0.8	R	√3	1	1	0.5	0.5
Probe positioning with respect to phantom shell	6.7	R	√3	1	1	3.9	3.9
Post-processing	2.0	R	√3	1	1	1.2	1.2
Test sample related							
Test sample positioning	2.8	N	1	1	1	2.8	2.8
Device holder uncertainty	6.3	N	1	1	1	6.3	6.3
Drift of output power	5.0	R	√3	1	1	2.9	2.9
Phantom and set-up							
Phantom uncertainty (shape and thickness tolerances)	4.0	R	√3	1	1	2.3	2.3
Liquid conductivity target)	5.0	R	√3	0.64	0.43	1.8	1.2
Liquid conductivity meas.)	2.5	N	1	0.64	0.43	1.6	1.1
Liquid permittivity target)	5.0	R	√3	0.6	0.49	1.7	1.4
Liquid permittivity meas.)	2.5	N	1	0.6	0.49	1.5	1.2
Combined standard uncertainty		RSS				12.2	12.0
Expanded uncertainty 95 % confidence interval)						24.3	23.9

Measurement uncertainty evaluation for IEC62209-2 SAR test

Source of uncertainty	Tolerance/ uncertainty ± %	Probability distribution	Divisor	ci (1 g)	ci (10 g)	Standard uncertainty ± %, (1 g)	Standard uncertainty ± %, (10 g)
Measurement system							
Probe calibration	6.55	N	1	1	1	6.6	6.6
Axial Isotropy	4.7	R	$\sqrt{3}$	1	1	2.7	2.7
Hemispherical Isotropy	9.6	R	$\sqrt{3}$	0	0	0.0	0.0
Linearity	4.7	R	$\sqrt{3}$	1	1	2.7	2.7
Modulation Response	0.0	R	$\sqrt{3}$	1	1	0.0	0.0
Detection limits	1.0	R	$\sqrt{3}$	1	1	0.6	0.6
Boundary effect	1.0	R	$\sqrt{3}$	1	1	0.6	0.6
Readout electronics	0.3	N	1	1	1	0.3	0.3
Response time	0.0	R	$\sqrt{3}$	1	1	0.0	0.0
Integration time	0.0	R	$\sqrt{3}$	1	1	0.0	0.0
RF ambient conditions – noise	1.0	R	$\sqrt{3}$	1	1	0.6	0.6
RF ambient conditions–reflections	1.0	R	$\sqrt{3}$	1	1	0.6	0.6
Probe positioner mech. Restrictions	0.8	R	$\sqrt{3}$	1	1	0.5	0.5
Probe positioning with respect to phantom shell	6.7	R	$\sqrt{3}$	1	1	3.9	3.9
Post-processing	2.0	R	$\sqrt{3}$	1	1	1.2	1.2
Test sample related							
Device holder Uncertainty	6.3	N	1	1	1	6.3	6.3
Test sample positioning	2.8	N	1	1	1	2.8	2.8
Power scaling	4.5	R	$\sqrt{3}$	1	1	2.6	2.6
Drift of output power	5.0	R	$\sqrt{3}$	1	1	2.9	2.9
Phantom and set-up							
Phantom uncertainty (shape and thickness tolerances)	4.0	R	$\sqrt{3}$	1	1	2.3	2.3
Algorithm for correcting SAR for deviations in permittivity and conductivity	1.9	N	1	1	0.84	1.1	0.9
Liquid conductivity (meas.)	2.5	N	1	0.64	0.43	1.6	1.1
Liquid permittivity (meas.)	2.5	N	1	0.6	0.49	1.5	1.2
Temp. unc. - Conductivity	1.7	R	$\sqrt{3}$	0.78	0.71	0.8	0.7
Temp. unc. - Permittivity	0.3	R	$\sqrt{3}$	0.23	0.26	0.0	0.0
Combined standard uncertainty		RSS				12.2	12.1
Expanded uncertainty 95 % confidence interval)						24.5	24.2

Appendixes

Refer to separated files for the following appendixes.

APPENDIX B PROBE & DIPOLES CALIBRATION CERTIFICATES.

APPENDIX C TEST POSITION PHOTOS.

APPENDIX D SAR plots.

******* END OF REPORT *******