

S

T

S

L

A

B



RADIO TEST REPORT

Report No.: STS2011058W09

Issued for

Klipsch L.L.C.

3502 Woodview Trace, Suite 200, Indianapolis, Indiana, United States

Product Name:	Bluetooth earphone
Brand Name:	N/A
Model Name:	Klipsch T5 II True Wireless ANC
Series Model:	Klipsch T5 II True Wireless ANC McLaren
FCC ID:	STI-T5IITWSANC
IC:	5788A-T5IITWSANC
Test Standard:	FCC Part 15.247 RSS-247 Issue 2, February 2017 RSS-Gen Issue 5 ,March 2019

Any reproduction of this document must be done in full. No single part of this document may be reproduced without permission from STS, all test data presented in this report is only applicable to presented test sample.

Shenzhen STS Test Services Co., Ltd.
A 1/F, Building B, Zhuoke Science Park, No.190 Chongqing Road, HepingShequ,
Fuyong Sub-District, Bao'an District, Shenzhen, Guang Dong, China
TEL: +86-755 3688 6288 FAX: +86-755 3688 6277 E-mail: sts@stsapp.com





TEST RESULT CERTIFICATION

Applicant's Name.....: Klipsch L.L.C.
 Address: 3502 Woodview Trace, Suite 200, Indianapolis, Indiana, United States
Manufacturer's Name: XIAMEN ACOUSYCOM ELECTRONIC CO.,LTD
 Address: NO.268-269 TONG-AN GARDEN, TONG-AN INDUSTRIAL PARK , TONG-AN, XIAMEN, FUJIAN, CHINA

Product Description

Product Name.....: Bluetooth earphone
 Brand Name: N/A
 Model Name: Klipsch T5 II True Wireless ANC
 Series Model.....: Klipsch T5 II True Wireless ANC McLaren
 FCC Part15.247

Test Standards.....: RSS-247 Issue 2, February 2017
 RSS-Gen Issue 5 ,March 2019

Test Procedure: ANSI C63.10-2013

This device described above has been tested by STS, the test results show that the equipment under test (EUT) is in compliance with the FCC/IC requirements. And it is applicable only to the tested sample identified in the report.

This report shall not be reproduced except in full, without the written approval of STS, this document may be altered or revised by STS, personal only, and shall be noted in the revision of the document.

Date of Test

Date of receipt of test item: 10 Nov. 2020
 Date (s) of performance of tests: 10 Nov. 2020 ~ 13 Jan. 2021
 Date of Issue.....: 13 Jan. 2021

Test Result.....: **Pass**

Testing Engineer :

(Chris Chen)

Technical Manager :

(Sean she)

Authorized Signatory :

(Vita Li)





Table of Contents

1. SUMMARY OF TEST RESULTS	6#
1.1 TEST FACTORY	7#
1.2 MEASUREMENT UNCERTAINTY	7#
2. GENERAL INFORMATION	8#
2.1 GENERAL DESCRIPTION OF THE EUT	8#
2.2 DESCRIPTION OF THE TEST MODES	10#
2.3 TEST SOFTWARE AND POWER LEVEL	10#
2.4 BLOCK DIAGRAM SHOWING THE CONFIGURATION OF SYSTEM TESTED	11#
2.5 DESCRIPTION OF NECESSARY ACCESSORIES AND SUPPORT UNITS	12#
2.6 EQUIPMENTS LIST	13#
3. EMC EMISSION TEST	15#
3.1 CONDUCTED EMISSION MEASUREMENT	15#
3.2 TEST PROCEDURE	16#
3.3 TEST SETUP	16#
3.4 EUT OPERATING CONDITIONS	16#
3.5 TEST RESULTS	17#
4. RADIATED EMISSION MEASUREMENT	19#
4.1 RADIATED EMISSION LIMITS	19#
4.2 TEST PROCEDURE	22#
4.3 TEST SETUP	23#
4.4 EUT OPERATING CONDITIONS	23#
4.5 FIELD STRENGTH CALCULATION	24#
4.6 TEST RESULTS	25#
5. CONDUCTED SPURIOUS & BAND EDGE EMISSION	38#
5.1 LIMIT	38#
5.2 TEST PROCEDURE	38#
5.3 TEST SETUP	38#
5.4 EUT OPERATION CONDITIONS	38#
5.5 TEST RESULTS	39#
6. POWER SPECTRAL DENSITY TEST	47#
6.1 LIMIT	47#
6.2 TEST PROCEDURE	47#
6.3 TEST SETUP	47#



Table of Contents

6.4 EUT OPERATION CONDITIONS	47#
6.5 TEST RESULTS	48#
7. BANDWIDTH TEST	52#
7.1 LIMIT	52#
7.2 TEST PROCEDURE	52#
7.3 TEST SETUP	52#
7.4 EUT OPERATION CONDITIONS	52#
7.5 TEST RESULTS	53#
8. PEAK OUTPUT POWER TEST	61#
8.1 LIMIT	61#
8.2 TEST PROCEDURE	61#
8.3 TEST SETUP	62#
8.4 EUT OPERATION CONDITIONS	62#
8.5 TEST RESULTS	63#
9. ANTENNA REQUIREMENT	66#
9.1 STANDARD REQUIREMENT	66#
9.2 EUT ANTENNA	66#
10. FREQUENCY STABILITY	67#
10.1 LIMITS OF FREQUENCY STABILITY MEASUREMENT	67#
10.2 TEST PROCEDURE	67#
10.3 TEST RESULT	67#
11. EUT TEST PHOTO	69#



Revision History

Rev.	Issue Date	Report NO.	Effect Page	Contents
00	13 Jan. 2021	STS2011058W09	ALL	Initial Issue





1. SUMMARY OF TEST RESULTS

Test procedures according to the technical standards:
KDB 558074 D01 15.247 Meas Guidance v05r02.

FCC Part 15.247, Subpart C RSS-247 Issue 2			
Standard Section	Test Item	Judgment	Remark
15.207 RSS-Gen 8.8	Conducted Emission	PASS	--
15.247 (a)(2) RSS-Gen 6.7 RSS-247 5.2 (a)	6dB&99% Bandwidth	PASS	--
15.247 (b)(3) RSS-247 5.4 (d)	Output Power	PASS	--
15.209 (a) RSS-Gen 8.9/8.10	Radiated Spurious Emission	PASS	--
15.247 (d) RSS-247 5.5 RSS-Gen 8.9/8.10	Conducted Spurious & Band Edge Emission	PASS	--
15.247 (e) RSS-247 5.2 (b)	Power Spectral Density	PASS	--
15.205 RSS-Gen 8.9/8.10	Restricted bands of operation	PASS	--
Part 15.247(d)/part 15.209(a) RSS-247 5.5 RSS-Gen 8.9/8.10	Band Edge Emission	PASS	--
15.203 RSS-Gen 6.8	Antenna Requirement	PASS	--
RSS-Gen 6.11/8.11	Frequency Stability	PASS	--

NOTE:

- (1) 'N/A' denotes test is not applicable in this Test Report.
- (2) All tests are according to ANSI C63.10-2013.



1.1 TEST FACTORY

SHENZHEN STS TEST SERVICES CO., LTD

Add. : A 1/F, Building B, Zhuoke Science Park, No.190 Chongqing Road, HepingShequ, Fuyong Sub-District, Bao'an District, Shenzhen, Guang Dong, China

FCC test Firm Registration Number: 625569

IC test Firm Registration Number: 12108A

A2LA Certificate No.: 4338.01

1.2 MEASUREMENT UNCERTAINTY

The reported uncertainty of measurement $y \pm U$, where expanded uncertainty U is based on a standard uncertainty multiplied by a coverage factor of $k=2$, providing a level of confidence of approximately **95** %.

No.	Item	Uncertainty
1	RF output power, conducted	$\pm 0.68\text{dB}$
2	Unwanted Emissions, conducted	$\pm 2.988\text{dB}$
3	All emissions, radiated 30-1GHz	$\pm 4.39\text{dB}$
4	All emissions, radiated 1G-6GHz	$\pm 5.10\text{dB}$
5	All emissions, radiated >6G	$\pm 5.48\text{dB}$
6	Conducted Emission (9KHz-150KHz)	$\pm 2.79\text{dB}$
7	Conducted Emission (150KHz-30MHz)	$\pm 2.80\text{dB}$



2. GENERAL INFORMATION

2.1 GENERAL DESCRIPTION OF THE EUT

Product Name	Bluetooth earphone	
Trade Name	N/A	
Model Name	Klipsch T5 II True Wireless ANC	
Series Model	Klipsch T5 II True Wireless ANC McLaren	
Model Difference	The difference in appearance color and shape (with and without lugs), the PCB board principle is exactly the same.	
Product Description	The EUT is a Bluetooth earphone	
	Operation Frequency:	2402~2480 MHz
	Modulation Type:	GFSK
	Radio Technology:	BLE
	Bluetooth Version:	5.0
	Bluetooth Configuration:	LE(Support 1M PHY, 2M PHY)
	Number Of Channel:	40
	Antenna Designation:	Please refer to the Note 4.
Antenna Gain (dBi)	-1 dBi	
Channel List	Please refer to the Note 3.	
Charging Box	Input: DC 5 V Output: DC 5V	
Earphone	Rated Voltage: DC 3.7V Capacity: 50mAh	
Hardware version number	V1.2	
Software version number	V1.5.1	
Connecting I/O Port(s)	Please refer to the Note 1.	

Note:

1. For a more detailed features description, please refer to the manufacturer's specifications or the User Manual.
2. This report is only for the right earphone.



3.

Channel List							
Channel	Frequency (MHz)	Channel	Frequency (MHz)	Channel	Frequency (MHz)	Channel	Frequency (MHz)
00	2402	10	2422	20	2442	30	2462
01	2404	11	2424	21	2444	31	2464
02	2406	12	2426	22	2446	32	2466
03	2408	13	2428	23	2448	33	2468
04	2410	14	2430	24	2450	34	2470
05	2412	15	2432	25	2452	35	2472
06	2414	16	2434	26	2454	36	2474
07	2416	17	2436	27	2456	37	2476
08	2418	18	2438	28	2458	38	2478
09	2420	19	2440	29	2460	39	2480

4.

Table for Filed Antenna

Ant.	Brand	Model Name	Antenna Type	Connector	Gain (dBi)	NOTE
1	N/A	Klipsch T5 II True Wireless ANC	Loop antenna	N/A	-1 dBi	BLE ANT

Note: The antenna information refer the manufacturer provide report, applicable only to the tested sample identified in the report.



2.2 DESCRIPTION OF THE TEST MODES

For conducted test items and radiated spurious emissions
Each of these EUT operation mode(s) or test configuration mode(s) mentioned below was evaluated respectively.

Worst Mode	Description	Data/Modulation
Mode 1	TX CH00(2402MHz)	1 MHz/GFSK
Mode 2	TX CH19(2440MHz)	1 MHz/GFSK
Mode 3	TX CH39(2480MHz)	1 MHz/GFSK

Worst Mode	Description	Data/Modulation
Mode 1	TX CH00(2402MHz)	2M PHY /GFSK
Mode 2	TX CH19(2440MHz)	2M PHY /GFSK
Mode 3	TX CH39(2480MHz)	2M PHY /GFSK

Note:

- (1) The measurements are performed at all Bit Rate of Transmitter, the worst data was reported.
- (2) We have be tested for all available U.S. voltage and frequencies(For 120V,50/60Hz and 240V, 50/60Hz) for which the device is capable of operation, and the worst case of 120V/60Hz is shown in the report.
- (3) The battery is fully-charged during the radited and RF conducted test.

For AC Conducted Emission

Test Case	
AC Conducted Emission	Mode 4 : Keeping BT TX

2.3 TEST SOFTWARE AND POWER LEVEL

During testing channel & power controlling software provided by the customer was used to control the operating channel as well as the output power level.

RF Function	Type	Mode Or Modulation type	Ant Gain(dBi)	Power Class	Software For Testing
BLE(With 2M PHY)	BLE_1M PHY	GFSK	-1	Default	Airoha.Tool.Kit
	BLE_2M PHY	GFSK	-1	Default	

2.4 BLOCK DIAGRAM SHOWING THE CONFIGURATION OF SYSTEM TESTED

Radiated Spurious Emission Test

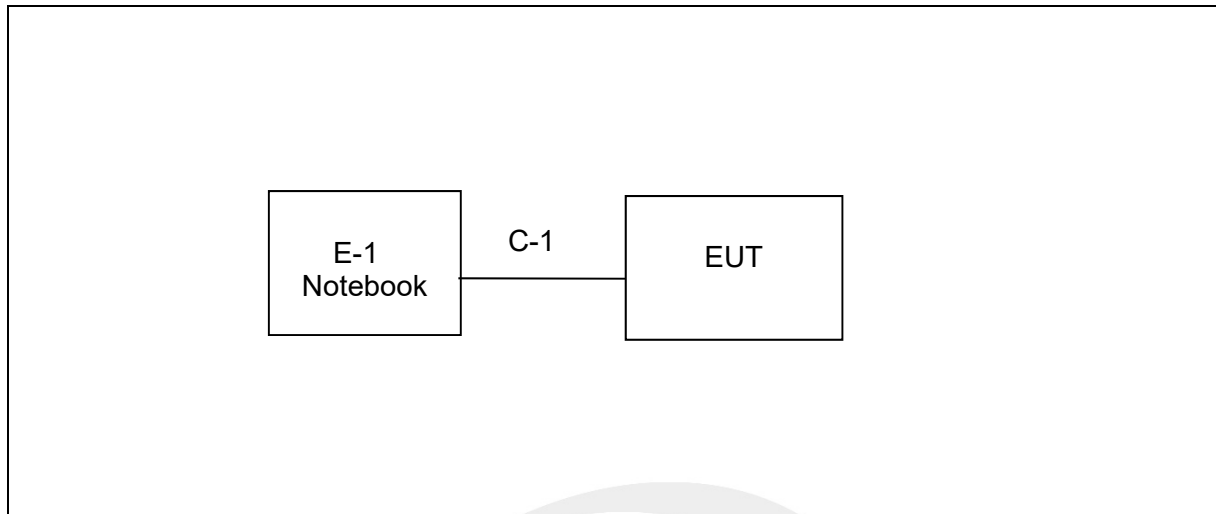

Conducted Emission Test

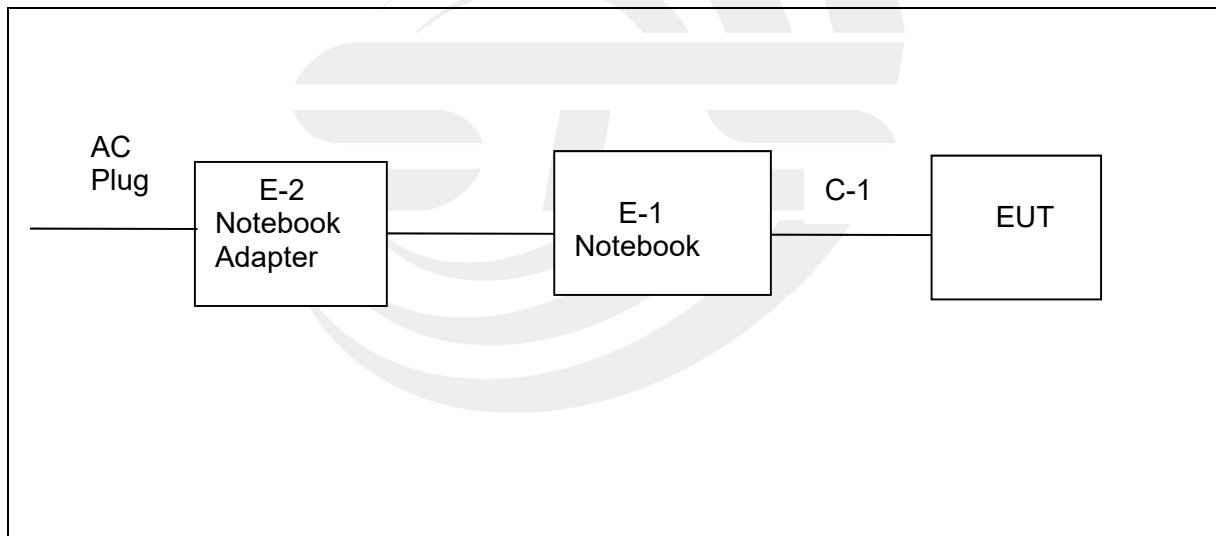



2.5 DESCRIPTION OF NECESSARY ACCESSORIES AND SUPPORT UNITS

The EUT has been tested as an independent unit together with other necessary accessories or support units. The following support units or accessories were used to form a representative test configuration during the tests.

Necessary accessories

Item	Equipment	Mfr/Brand	Model/Type No.	Length	Note
N/A	N/A	N/A	N/A	N/A	N/A

Support units

Item	Equipment	Mfr/Brand	Model/Type No.	Length	Note
E-1	Notebook	LENOVO	ThinkPad E470	N/A	N/A
E-2	Notebook Adapter	LENOVO	ADLX45DLC3A	N/A	N/A
C-1	USB Cable	N/A	N/A	150cm	NO

Note:

- (1) For detachable type I/O cable should be specified the length in cm in 『Length』 column.
- (2) "YES" is means "with core"; "NO" is means "without core".



2.6 EQUIPMENTS LIST

Radiation Test equipment

Kind of Equipment	Manufacturer	Type No.	Serial No.	Last calibration	Calibrated until
Test Receiver	R&S	ESCI	101427	2020.10.12	2021.10.11
Signal Analyzer	R&S	FSV 40-N	101823	2020.10.10	2021.10.09
Active loop Antenna	ZHINAN	ZN30900C	16035	2019.07.11	2021.07.10
Bilog Antenna	TESEQ	CBL6111D	34678	2020.10.12	2022.10.11
Horn Antenna	SCHWARZBECK	BBHA 9120D	02014	2019.10.15	2021.10.14
SHF-EHF Horn Antenna (18G-40GHz)	A-INFO	LB-180400-KF	J211020657	2020.10.12	2022.10.11
Pre-Amplifier (0.1M-3GHz)	EM	EM330	060665	2020.10.12	2021.10.11
Pre-Amplifier (1G-18GHz)	SKET	LNPA-01018G-45	SK2018080901	2020.10.12	2021.10.11
Pre-Amplifier (18G-40GHz)	SKET	LNPA-1840-50	SK2018101801	2020.10.10	2021.10.09
Temperature & Humidity	HH660	Mieo	N/A	2020.10.13	2021.10.12
Turn table	EM	SC100_1	60531	N/A	N/A
Antenna mast	EM	SC100	N/A	N/A	N/A
Test SW	FARAD	EZ-EMC(Ver.STSLAB-03A1 RE)			

Conduction Test equipment

Kind of Equipment	Manufacturer	Type No.	Serial No.	Last calibration	Calibrated until
Test Receiver	R&S	ESCI	101427	2020.10.12	2021.10.11
LISN	R&S	ENV216	101242	2020.10.12	2021.10.11
LISN	EMCO	3810/2NM	23625	2020.10.12	2021.10.11
Temperature & Humidity	HH660	Mieo	N/A	2020.10.13	2021.10.12
Test SW	FARAD	EZ-EMC(Ver.STSLAB-03A1 CE)			



RF Connected Test

Kind of Equipment	Manufacturer	Type No.	Serial No.	Last calibration	Calibrated until
Power Sensor	Keysight	U2021XA	MY55520005	2020.10.10	2021.10.09
			MY55520006	2020.10.10	2021.10.09
			MY56120038	2020.10.10	2021.10.09
			MY56280002	2020.10.10	2021.10.09
Signal Analyzer	Agilent	N9020A	MY51110105	2020.03.05	2021.03.04
Temperature & Humidity	HH660	Mieo	N/A	2020.10.13	2021.10.12
MIMO Power measurement test Set	Keysight	U2021XA	MY55520005	2020.10.10	2021.10.09
Test SW	FARAD	EZ-EMC(Ver.STSLAB-03A1 RE)			

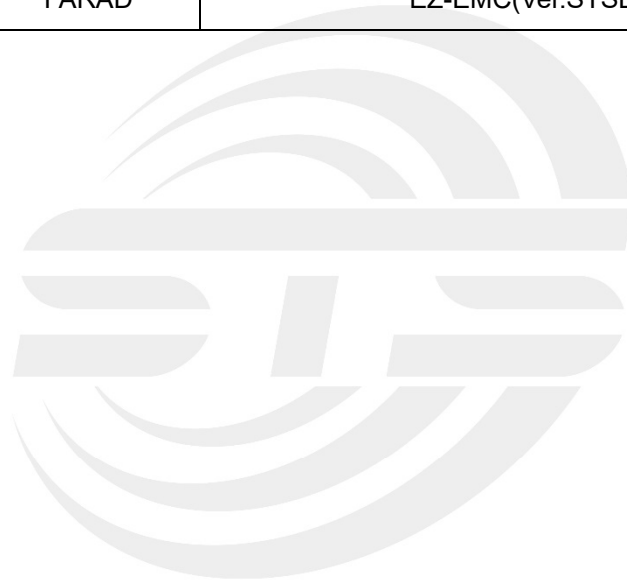



3. EMC EMISSION TEST

3.1 CONDUCTED EMISSION MEASUREMENT

3.1.1 POWER LINE CONDUCTED EMISSION LIMITS

The radio frequency voltage that is conducted back onto the AC power line on any frequency or frequencies, within the band 150 kHz to 30 MHz, shall not exceed the limits in the following table.

FREQUENCY (MHz)	Conducted Emission limit (dBuV)	
	Quasi-peak	Average
0.15 -0.5	66 - 56 *	56 - 46 *
0.50 -5.0	56.00	46.00
5.0 -30.0	60.00	50.00

Note:

- (1) The tighter limit applies at the band edges.
- (2) The limit of “ * ” marked band means the limitation decreases linearly with the logarithm of the frequency in the range.

The following table is the setting of the receiver

Receiver Parameters	Setting
Attenuation	10 dB
Start Frequency	0.15 MHz
Stop Frequency	30 MHz
IF Bandwidth	9 kHz

3.2 TEST PROCEDURE

- a. The EUT is 0.8 m from the horizontal ground plane and 0.4 m from the vertical ground plane with EUT being connected to the power mains through a line impedance stabilization network (LISN). All other support equipments are powered from additional LISN(s). The LISN provides 50 Ohm/ 50uH of coupling impedance for the measuring instrument.
- b. Interconnecting cables that hang closer than 40 cm to the ground plane shall be folded back and forth in the center forming a bundle 30 to 40 cm long.
- c. I/O cables that are not connected to a peripheral shall be bundled in the center. The end of the cable may be terminated, if required, using the correct terminating impedance. The overall length shall not exceed 1 m.
- d. LISN is at least 80 cm from the nearest part of EUT chassis.
- e. For the actual test configuration, please refer to the related Item –EUT Test Photos.

3.3 TEST SETUP

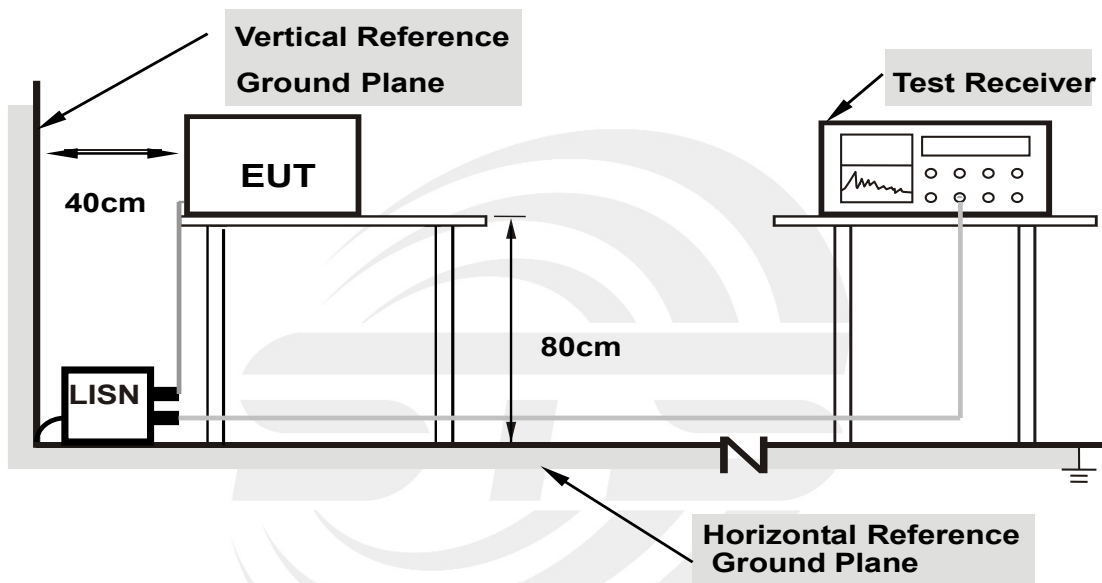

- Note: 1. Support units were connected to second LISN.**
2. Both of LISNs (AMN) are 80 cm from EUT and at least 80 cm from other units and other metal planes support units.

3.4 EUT OPERATING CONDITIONS

The EUT was configured for testing in a typical fashion (as a customer would normally use it). The EUT has been programmed to continuously transmit during test. This operating condition was tested and used to collect the included data.



3.5 TEST RESULTS

Temperature:	24.5(C)	Relative Humidity:	45%RH
Test Voltage:	AC 120V/60Hz	Phase:	L
Test Mode:	Mode 4		

No.	Frequency (MHz)	Reading (dBUV)	Correct Factor(dB)	Result (dBUV)	Limit (dBUV)	Margin (dB)	Remark
1	0.1900	38.14	20.30	58.44	64.04	-5.60	QP
2	0.1900	22.96	20.30	43.26	54.04	-10.78	AVG
3	0.2500	35.41	20.54	55.95	61.76	-5.81	QP
4	0.2500	19.46	20.54	40.00	51.76	-11.76	AVG
5	0.6780	21.53	20.29	41.82	56.00	-14.18	QP
6	0.6780	7.32	20.29	27.61	46.00	-18.39	AVG
7	2.0700	27.78	20.14	47.92	56.00	-8.08	QP
8	2.0700	12.63	20.14	32.77	46.00	-13.23	AVG
9	8.3820	13.57	19.88	33.45	60.00	-26.55	QP
10	8.3820	2.09	19.88	21.97	50.00	-28.03	AVG
11	22.0140	17.77	20.64	38.41	60.00	-21.59	QP
12	22.0140	5.02	20.64	25.66	50.00	-24.34	AVG

Remark:

1. All readings are Quasi-Peak and Average values
2. Margin = Result (Result = Reading + Factor) – Limit
3. Factor=LISN factor+Cable loss+Limiter (10dB)

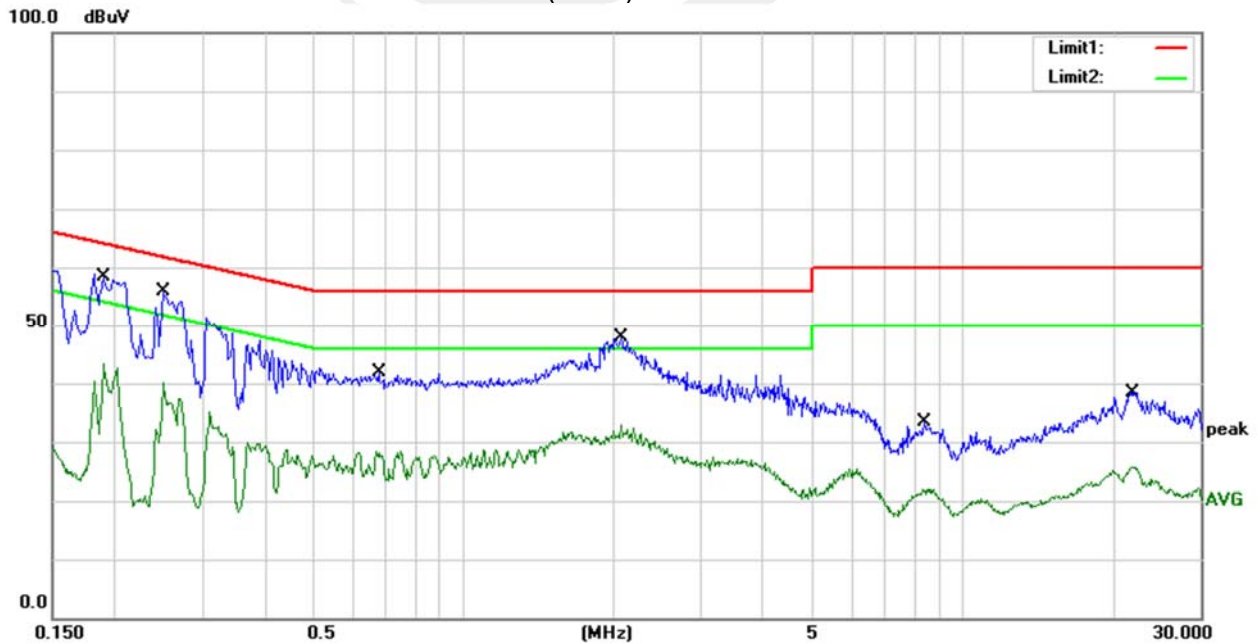



Temperature:	24.5(C)	Relative Humidity:	45%RH
Test Voltage:	AC 120V/60Hz	Phase:	N
Test Mode:	Mode 4		

No.	Frequen cy (MHz)	Reading (dBuV)	Correct Factor(d B)	Result (dBuV)	Limit (dBuV)	Margin (dB)	Remark
1	0.1860	38.96	20.29	59.25	64.21	-4.96	QP
2	0.1860	21.72	20.29	42.01	54.21	-12.20	AVG
3	0.3060	29.58	20.75	50.33	60.08	-9.75	QP
4	0.3060	13.33	20.75	34.08	50.08	-16.00	AVG
5	0.7580	21.92	20.26	42.18	56.00	-13.82	QP
6	0.7580	7.60	20.26	27.86	46.00	-18.14	AVG
7	2.0660	29.57	20.14	49.71	56.00	-6.29	QP
8	2.0660	14.59	20.14	34.73	46.00	-11.27	AVG
9	8.1220	17.29	19.88	37.17	60.00	-22.83	QP
10	8.1220	6.05	19.88	25.93	50.00	-24.07	AVG
11	26.0580	21.62	20.75	42.37	60.00	-17.63	QP
12	26.0580	8.52	20.75	29.27	50.00	-20.73	AVG

Remark:

1. All readings are Quasi-Peak and Average values
2. Margin = Result (Result =Reading + Factor)–Limit
3. Factor=LISN factor+Cable loss+Limiter (10dB)

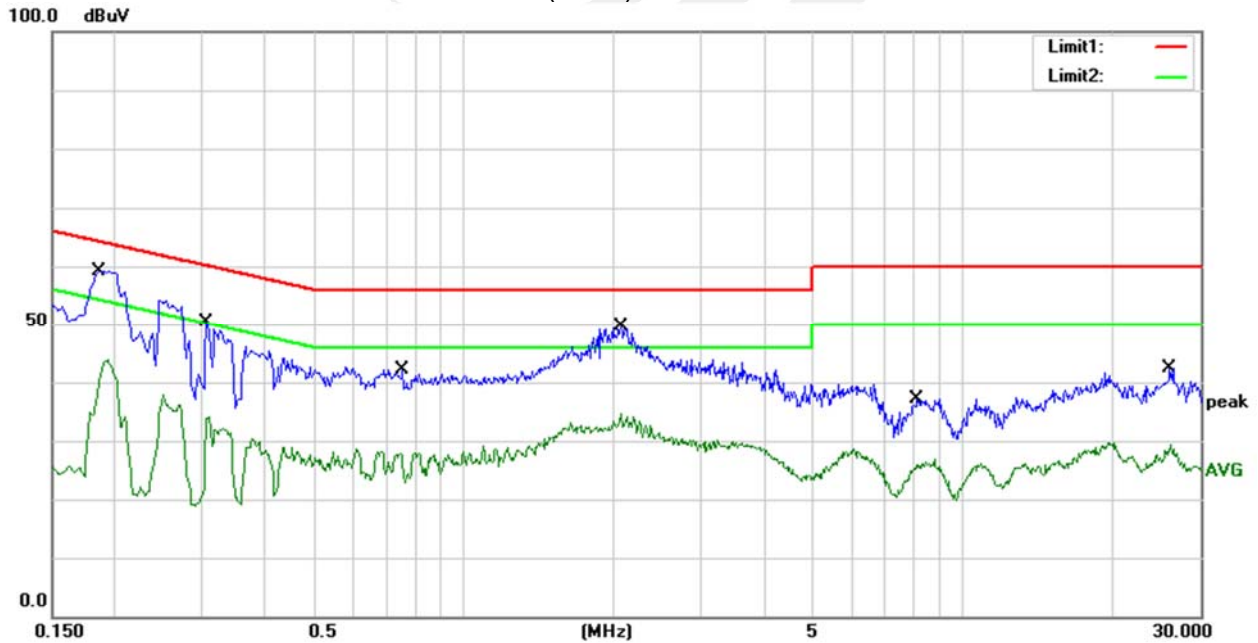



4. RADIATED EMISSION MEASUREMENT

4.1 RADIATED EMISSION LIMITS

In any 100 kHz bandwidth outside the operating frequency band. In case the emission fall within the Restricted band specified on Part15.205(a)&209(a), RSS-Gen Issue 5 and RSS-247 Issue 2, February 2017 (5.5) limit in the table and according to ANSI C63.10-2013 below has to be followed.

LIMITS OF RADIATED EMISSION MEASUREMENT (Frequency Range 9kHz-1000MHz)

Frequencies (MHz)	Field Strength (micorvolts/meter)	Measurement Distance (meters)
0.009~0.490	2400/F(KHz)	300
0.490~1.705	24000/F(KHz)	30
1.705~30.0	30	30
30~88	100	3
88~216	150	3
216~960	200	3
Above 960	500	3

LIMITS OF RADIATED EMISSION MEASUREMENT (Above 1000MHz)

FREQUENCY (MHz)	(dBuV/m) (at 3M)	
	PEAK	AVERAGE
Above 1000	74	54

Notes:

- (1) The limit for radiated test was performed according to FCC PART 15C.
- (2) The tighter limit applies at the band edges.
- (3) Emission level (dBuV/m)=20log Emission level (uV/m).

LIMITS OF RESTRICTED FREQUENCY BANDS

FCC:

FREQUENCY (MHz)	FREQUENCY (MHz)	FREQUENCY (MHz)	FREQUENCY (GHz)
0.090-0.110	16.42-16.423	399.9-410	4.5-5.15
0.495-0.505	16.69475-16.69525	608-614	5.35-5.46
2.1735-2.1905	16.80425-16.80475	960-1240	7.25-7.75
4.125-4.128	25.5-25.67	1300-1427	8.025-8.5
4.17725-4.17775	37.5-38.25	1435-1626.5	9.0-9.2
4.20725-4.20775	73-74.6	1645.5-1646.5	9.3-9.5
6.215-6.218	74.8-75.2	1660-1710	10.6-12.7
6.26775-6.26825	108-121.94	1718.8-1722.2	13.25-13.4
6.31175-6.31225	123-138	2200-2300	14.47-14.5
8.291-8.294	149.9-150.05	2310-2390	15.35-16.2
8.362-8.366	156.52475-156.52525	2483.5-2500	17.7-21.4
8.37625-8.38675	156.7-156.9	2690-2900	22.01-23.12
8.41425-8.41475	162.0125-167.17	3260-3267	23.6-24.0
12.29-12.293	167.72-173.2	3332-3339	31.2-31.8
12.51975-12.52025	240-285	3345.8-3358	36.43-36.5
12.57675-12.57725	322-335.4	3600-4400	Above 38.6
13.36-13.41			



IC:

FREQUENCY (MHz)	FREQUENCY (MHz)	FREQUENCY (GHz)
0.090 - 0.110	149.9 - 150.05	9.0 - 9.2
0.495 - 0.505	156.52475 - 156.52525	9.3 - 9.5
2.1735 - 2.1905	156.7 - 156.9	10.6 - 12.7
3.020 - 3.026	162.0125 - 167.17	13.25 - 13.4
4.125 - 4.128	167.72 - 173.2	14.47 - 14.5
4.17725 - 4.17775	240 - 285	15.35 - 16.2
4.20725 - 4.20775	322 - 335.4	17.7 - 21.4
5.677 - 5.683	399.9 - 410	22.01 - 23.12
6.215 - 6.218	608 - 614	23.6 - 24.0
6.26775 - 6.26825	960 - 1427	31.2 - 31.8
6.31175 - 6.31225	1435 - 1626.5	36.43 - 36.5
8.291 - 8.294	1645.5 - 1646.5	Above 38.6
8.362 - 8.366	1660 - 1710	
8.37625 - 8.38675	1718.8 - 1722.2	
8.41425 - 8.41475	2200 - 2300	
12.29 - 12.293	2310 - 2390	
12.51975 - 12.52025	2483.5 - 2500	
12.57675 - 12.57725	2655 - 2900	
13.36 - 13.41	3260 - 3267	
16.42 - 16.423	3332 - 3339	
16.69475 - 16.69525	3345.8 - 3358	
16.80425 - 16.80475	3500 - 4400	
25.5 - 25.67	4500 - 5150	
37.5 - 38.25	5350 - 5460	
73 - 74.6	7250 - 7750	
74.8 - 75.2	8025 - 8500	
108 - 138		



For Radiated Emission

Spectrum Parameter	Setting
Attenuation	Auto
Detector	Peak/QP/AV
Start Frequency	9 KHz/150KHz(Peak/QP/AV)
Stop Frequency	150KHz/30MHz(Peak/QP/AV)
RB / VB (emission in restricted band)	200Hz (From 9kHz to 0.15MHz)/ 9KHz (From 0.15MHz to 30MHz); 200Hz (From 9kHz to 0.15MHz)/ 9KHz (From 0.15MHz to 30MHz)

Spectrum Parameter	Setting
Attenuation	Auto
Detector	Peak/QP
Start Frequency	30 MHz(Peak/QP)
Stop Frequency	1000 MHz (Peak/QP)
RB / VB (emission in restricted band)	120 KHz / 300 KHz

Spectrum Parameter	Setting
Attenuation	Auto
Detector	Peak/AV
Start Frequency	1000 MHz(Peak/AV)
Stop Frequency	10th carrier hamonic(Peak/AV)
RB / VB (emission in restricted band)	1 MHz / 3 MHz(Peak) 1 MHz/1/T MHz(AVG)

For Restricted band

Spectrum Parameter	Setting
Detector	Peak/AV
Start/Stop Frequency	Lower Band Edge: 2310 to 2410 MHz Upper Band Edge: 2475 to 2500 MHz
RB / VB	1 MHz / 3 MHz(Peak) 1 MHz/1/T MHz(AVG)



Receiver Parameter	Setting
Start ~ Stop Frequency	9kHz~90kHz / RB 200Hz for PK & AV
Start ~ Stop Frequency	90kHz~110kHz / RB 200Hz for QP
Start ~ Stop Frequency	110kHz~490kHz / RB 200Hz for PK & AV
Start ~ Stop Frequency	490kHz~30MHz / RB 9kHz for QP
Start ~ Stop Frequency	30MHz~1000MHz / RB 120kHz for QP

4.2 TEST PROCEDURE

- a. The measuring distance at 3 m shall be used for measurements at frequency 0.009MHz up to 1GHz, and above 1GHz.
- b. The EUT was placed on the top of a rotating table 0.8 m (above 1GHz is 1.5 m) above the ground at a 3 m anechoic chamber test site. The table was rotated 360 degree to determine the position of the highest radiation.
- c. The height of the equipment shall be 0.8 m (above 1GHz is 1.5 m); the height of the test antenna shall vary between 1 m to 4 m. Horizontal and vertical polarization of the antenna are set to make the measurement.
- d. The initial step in collecting conducted emission data is a spectrum analyzer peak detector mode pre-scanning the measurement frequency range. Significant peaks are then marked and QuasiPeak detector mode will be re-measured.
- e. If the Peak Mode measured value is compliance with and lower than Quasi Peak Mode Limit, the EUT shall be deemed to meet QP Limits and no additional QP Mode measurement was performed.
- f. For the actual test configuration, please refer to the related Item –EUT Test Photos.

Note:

Both horizontal and vertical antenna polarities were tested and performed pretest to three orthogonal axis. The worst case emissions were reported.

4.3 TEST SETUP

(A) Radiated Emission Test-Up Frequency Below 30MHz

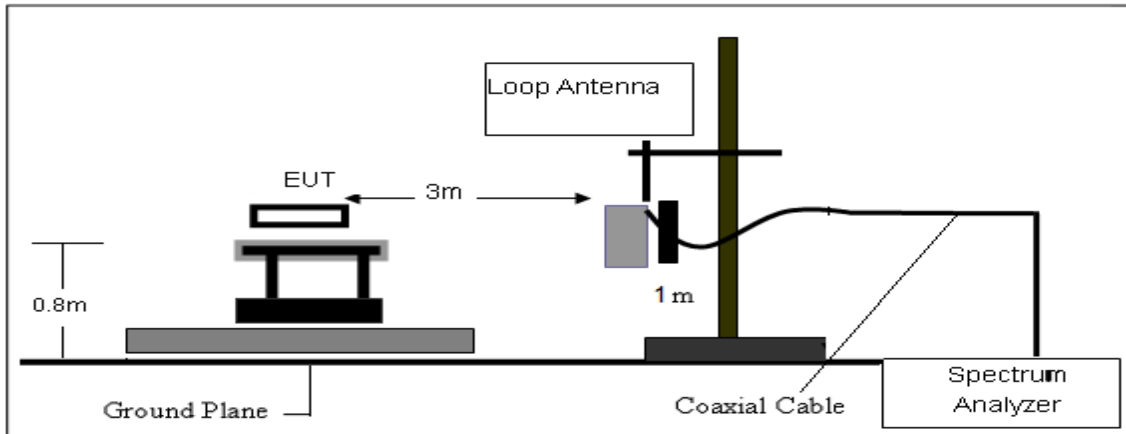

(B) Radiated Emission Test-Up Frequency 30MHz~1GHz

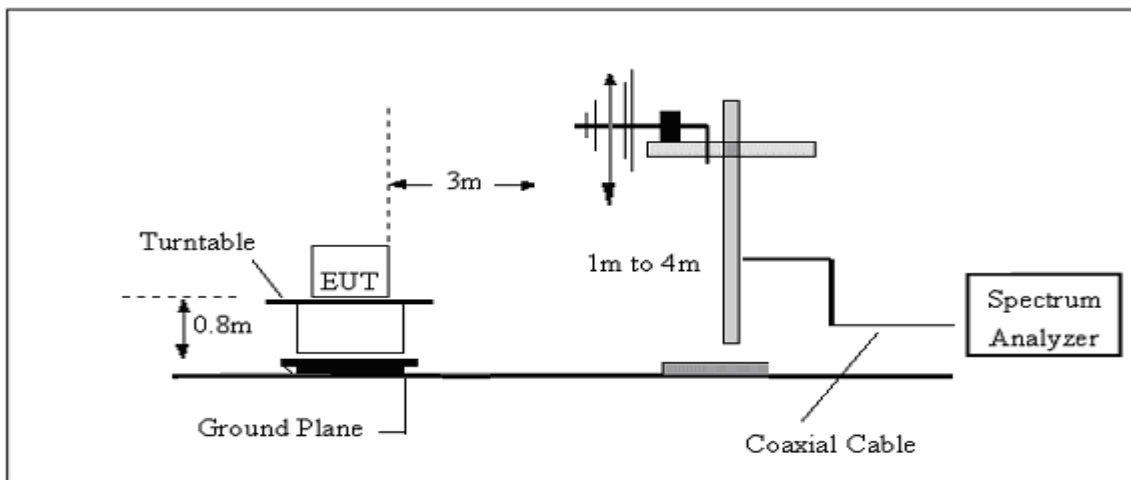

(C) Radiated Emission Test-Up Frequency Above 1GHz

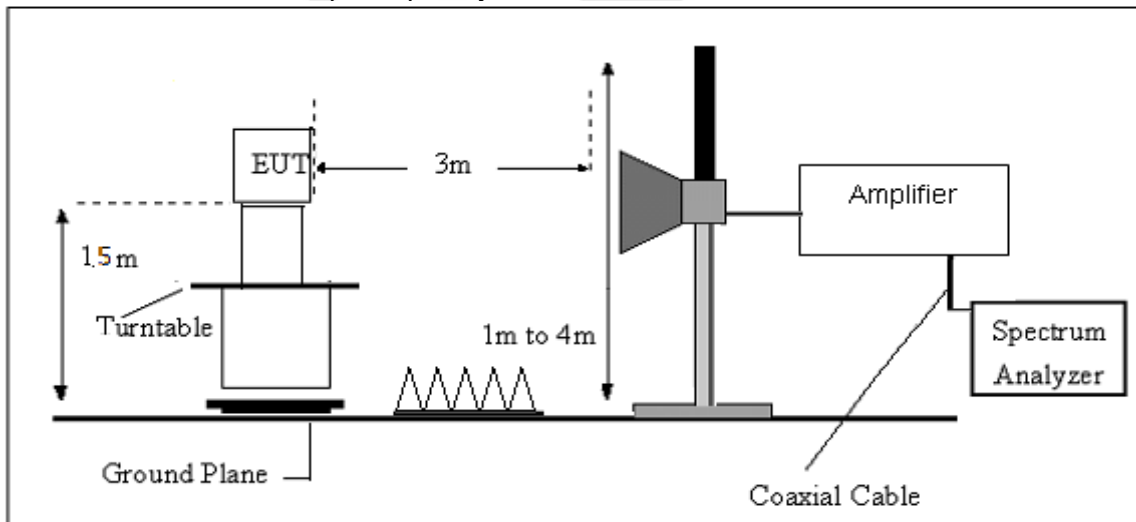

4.4 EUT OPERATING CONDITIONS

The EUT tested system was configured as the statements of 2.3 Unless otherwise a special operating condition is specified in the follows during the testing.



4.5 FIELD STRENGTH CALCULATION

The field strength is calculated by adding the Antenna Factor and Cable Factor and subtracting the Amplifier Gain and Duty Cycle Correction Factor (if any) from the measured reading. The basic equation with a sample calculation is as follows:

$$FS = RA + AF + CL - AG$$

Where

FS = Field Strength

CL = Cable Attenuation Factor (Cable Loss)

RA = Reading Amplitude

AG = Amplifier Gain

AF = Antenna Factor

For example

Frequency (MHz)	FS (dB μ V/m)	RA (dB μ V/m)	AF (dB)	CL (dB)	AG (dB)	Factor (dB)
300	40	58.1	12.2	1.6	31.9	-18.1

$$\text{Factor} = \text{AF} + \text{CL} - \text{AG}$$





4.6 TEST RESULTS

(Between 9KHz – 30 MHz)

Temperature:	23.1(C)	Relative Humidity:	60%RH
Test Voltage:	DC 3.7V	Polarization:	--
Test Mode:	TX Mode		

Freq. (MHz)	Reading (dBuV/m)	Limit (dBuV/m)	Margin (dB)	State P/F
--	--	--	--	PASS
--	--	--	--	PASS

Note:

The amplitude of spurious emissions which are attenuated by more than 20dB below the permissible value has no need to be reported.

Distance extrapolation factor = $40 \log(\text{specific distance}/\text{test distance})(\text{dB})$;

Limit line = specific limits(dBuv) + distance extrapolation factor.

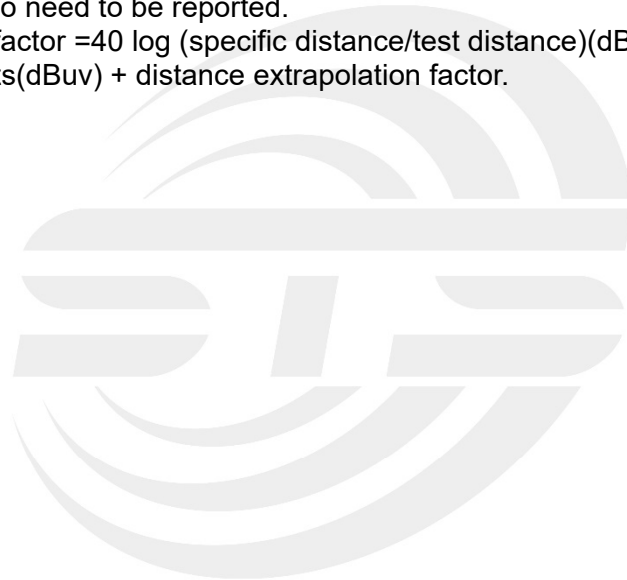



(30MHz -1000MHz)

1M PHY

Temperature:	23.1(C)	Relative Humidity:	60%RH
Test Voltage:	DC 3.7V	Phase:	Horizontal
Test Mode:	Mode 1/2/3 (Mode 1 worst mode)		

No.	Frequency (MHz)	Reading (dBuV)	Correct Factor(dB/m)	Result (dBuV/m)	Limit (dBuV/m)	Margin (dB)	Remark
1	34.8500	29.22	-15.34	13.88	40.00	-26.12	QP
2	215.2700	41.80	-20.17	21.63	43.50	-21.87	QP
3	408.3000	32.03	-10.66	21.37	46.00	-24.63	QP
4	504.3300	31.82	-7.98	23.84	46.00	-22.16	QP
5	724.5200	35.93	-2.89	33.04	46.00	-12.96	QP
6	975.7500	29.06	2.38	31.44	54.00	-22.56	QP

Remark:

- Margin = Result (Result =Reading + Factor)-Limit
- Factor= Antenna factor+Cable attenuation factor(cable loss)-Amplifier gain

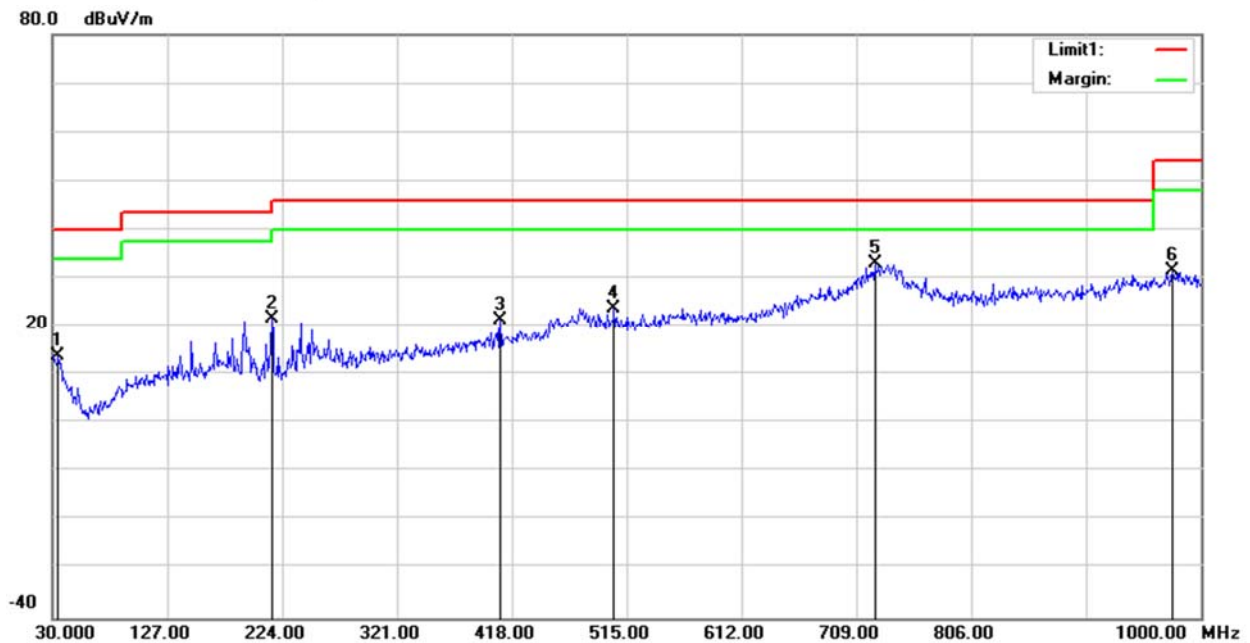



Temperature:	23.1(C)	Relative Humidity:	60%RH
Test Voltage:	DC 3.7V	Phase:	Vertical
Test Mode:	Mode 1/2/3 (Mode 1 worst mode)		

No.	Frequency (MHz)	Reading (dBuV)	Correct Factor(dB/m)	Result (dBuV/m)	Limit (dBuV/m)	Margin (dB)	Remark
1	41.6400	32.89	-18.93	13.96	40.00	-26.04	QP
2	167.7400	30.68	-19.58	11.10	43.50	-32.40	QP
3	311.3000	30.77	-14.40	16.37	46.00	-29.63	QP
4	565.4400	28.97	-5.55	23.42	46.00	-22.58	QP
5	741.0100	28.99	-2.11	26.88	46.00	-19.12	QP
6	943.7400	29.84	1.46	31.30	46.00	-14.70	QP

Remark:

- Margin = Result (Result =Reading + Factor)-Limit
- Factor= Antenna factor+Cable attenuation factor(cable loss)-Amplifier gain

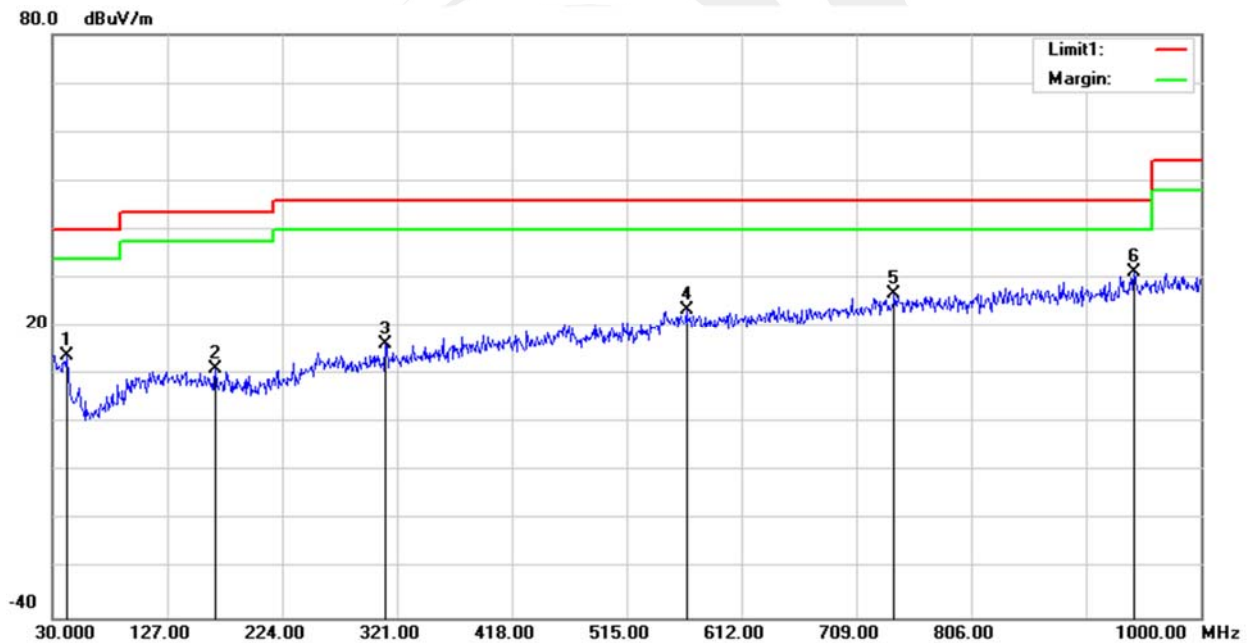



2M PHY

Temperature:	23.1(C)	Relative Humidity:	60%RH
Test Voltage:	DC 3.7V	Phase:	Horizontal
Test Mode:	Mode 1/2/3 (Mode 1 worst mode)		

No.	Frequency (MHz)	Reading (dBuV)	Correct Factor(dB/m)	Result (dBuV/m)	Limit (dBuV/m)	Margin (dB)	Remark
1	31.9400	27.30	-13.86	13.44	40.00	-26.56	QP
2	215.2700	42.34	-20.17	22.17	43.50	-21.33	QP
3	474.2600	32.01	-8.85	23.16	46.00	-22.84	QP
4	725.4900	35.51	-2.82	32.69	46.00	-13.31	QP
5	948.5900	28.60	1.56	30.16	46.00	-15.84	QP
6	985.4500	30.04	2.33	32.37	54.00	-21.63	QP

Remark:

- Margin = Result (Result =Reading + Factor) –Limit
- Factor= Antenna factor+Cable attenuation factor(cable loss)-Amplifier gain

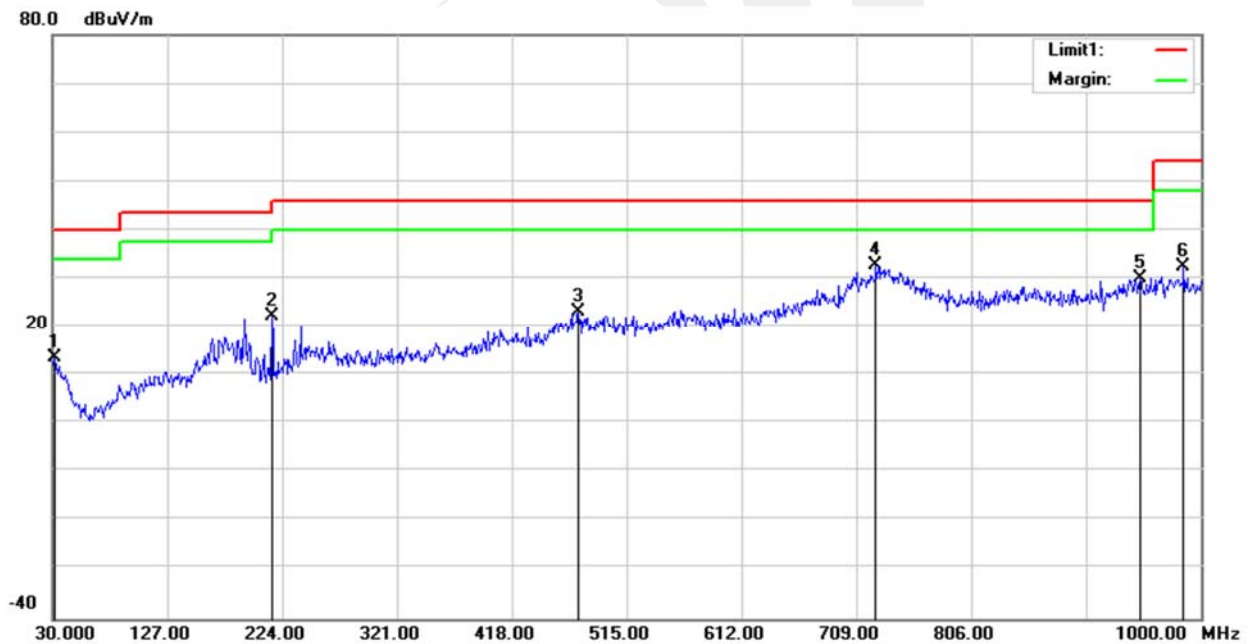



Temperature:	23.1(C)	Relative Humidity:	60%RH
Test Voltage:	DC 3.7V	Phase:	Vertical
Test Mode:	Mode 1/2/3 (Mode 1 worst mode)		

No.	Frequency (MHz)	Reading (dBuV)	Correct Factor(dB/m)	Result (dBuV/m)	Limit (dBuV/m)	Margin (dB)	Remark
1	40.6700	34.24	-18.40	15.84	40.00	-24.16	QP
2	121.1800	30.78	-18.32	12.46	43.50	-31.04	QP
3	312.2700	31.31	-14.36	16.95	46.00	-29.05	QP
4	557.6800	29.77	-5.55	24.22	46.00	-21.78	QP
5	829.2800	29.09	-0.83	28.26	46.00	-17.74	QP
6	980.6000	29.77	2.63	32.40	54.00	-21.60	QP

Remark:

- Margin = Result (Result =Reading + Factor)-Limit
- Factor= Antenna factor+Cable attenuation factor(cable loss)-Amplifier gain

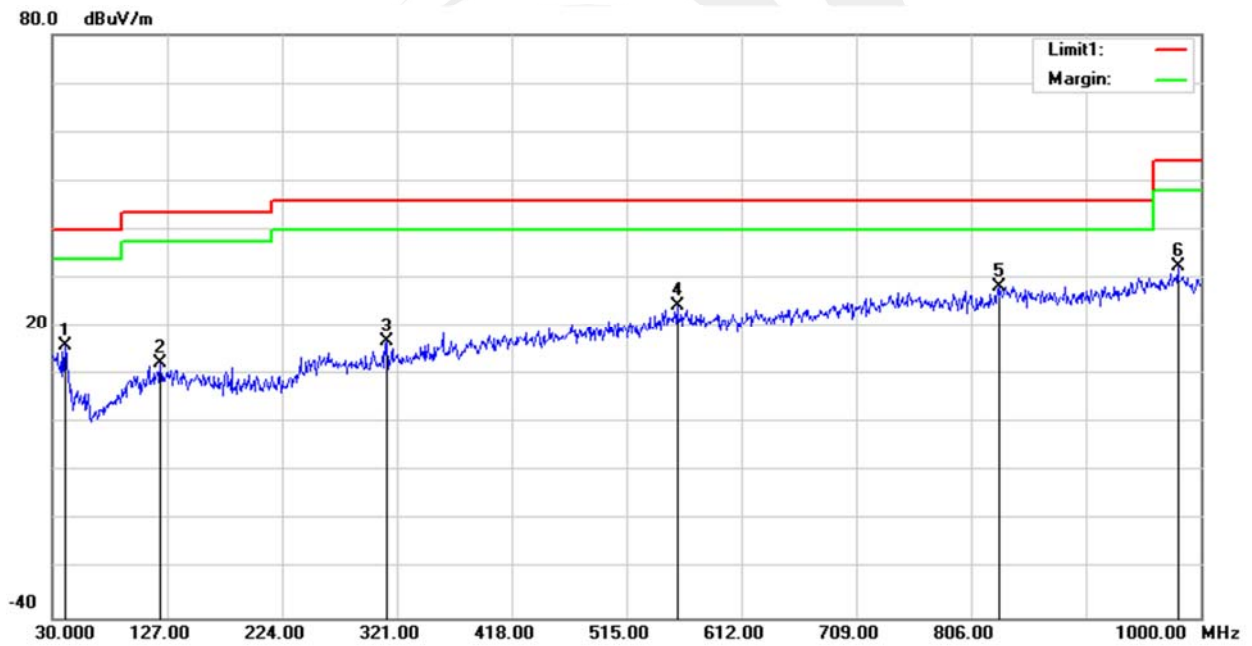



(1GHz-25GHz) Spurious emission Requirements

1M PHY
GFSK

Frequency (MHz)	Meter Reading (dBμV)	Amplifier (dB)	Loss (dB)	Antenna Factor (dB/m)	Corrected Factor (dB)	Emission Level (dBμV/m)	Limits (dBμV/m)	Margin (dB)	Detector Type	Comment
Low Channel (2402 MHz)										
3264.72	61.20	44.70	6.70	28.20	-9.80	51.40	74.00	-22.60	PK	Vertical
3264.72	51.74	44.70	6.70	28.20	-9.80	41.94	54.00	-12.06	AV	Vertical
3264.72	61.10	44.70	6.70	28.20	-9.80	51.30	74.00	-22.70	PK	Horizontal
3264.72	50.81	44.70	6.70	28.20	-9.80	41.01	54.00	-12.99	AV	Horizontal
4804.51	59.48	44.20	9.04	31.60	-3.56	55.92	74.00	-18.08	PK	Vertical
4804.51	49.77	44.20	9.04	31.60	-3.56	46.21	54.00	-7.79	AV	Vertical
4804.56	58.67	44.20	9.04	31.60	-3.56	55.11	74.00	-18.89	PK	Horizontal
4804.56	49.41	44.20	9.04	31.60	-3.56	45.85	54.00	-8.15	AV	Horizontal
5359.87	48.22	44.20	9.86	32.00	-2.34	45.88	74.00	-28.12	PK	Vertical
5359.87	39.15	44.20	9.86	32.00	-2.34	36.81	54.00	-17.19	AV	Vertical
5359.82	48.39	44.20	9.86	32.00	-2.34	46.05	74.00	-27.95	PK	Horizontal
5359.82	38.04	44.20	9.86	32.00	-2.34	35.70	54.00	-18.30	AV	Horizontal
7205.72	53.70	43.50	11.40	35.50	3.40	57.10	74.00	-16.90	PK	Vertical
7205.72	44.67	43.50	11.40	35.50	3.40	48.07	54.00	-5.93	AV	Vertical
7205.89	53.73	43.50	11.40	35.50	3.40	57.13	74.00	-16.87	PK	Horizontal
7205.89	44.76	43.50	11.40	35.50	3.40	48.16	54.00	-5.84	AV	Horizontal
Middle Channel (2440 MHz)										
3264.68	62.01	44.70	6.70	28.20	-9.80	52.21	74.00	-21.79	PK	Vertical
3264.68	50.58	44.70	6.70	28.20	-9.80	40.78	54.00	-13.22	AV	Vertical
3264.57	61.76	44.70	6.70	28.20	-9.80	51.96	74.00	-22.04	PK	Horizontal
3264.57	51.32	44.70	6.70	28.20	-9.80	41.52	54.00	-12.48	AV	Horizontal
4880.45	59.55	44.20	9.04	31.60	-3.56	55.99	74.00	-18.01	PK	Vertical
4880.45	50.45	44.20	9.04	31.60	-3.56	46.89	54.00	-7.11	AV	Vertical
4880.53	58.56	44.20	9.04	31.60	-3.56	55.00	74.00	-19.00	PK	Horizontal
4880.53	50.56	44.20	9.04	31.60	-3.56	47.00	54.00	-7.00	AV	Horizontal
5359.62	48.28	44.20	9.86	32.00	-2.34	45.93	74.00	-28.07	PK	Vertical
5359.62	39.09	44.20	9.86	32.00	-2.34	36.74	54.00	-17.26	AV	Vertical
5359.60	47.67	44.20	9.86	32.00	-2.34	45.33	74.00	-28.67	PK	Horizontal
5359.60	38.99	44.20	9.86	32.00	-2.34	36.64	54.00	-17.36	AV	Horizontal
7320.70	54.83	43.50	11.40	35.50	3.40	58.23	74.00	-15.77	PK	Vertical
7320.70	44.49	43.50	11.40	35.50	3.40	47.89	54.00	-6.11	AV	Vertical
7320.77	53.59	43.50	11.40	35.50	3.40	56.99	74.00	-17.01	PK	Horizontal
7320.77	44.17	43.50	11.40	35.50	3.40	47.57	54.00	-6.43	AV	Horizontal



High Channel (2480 MHz)										
3264.90	61.50	44.70	6.70	28.20	-9.80	51.70	74.00	-22.30	PK	Vertical
3264.90	51.25	44.70	6.70	28.20	-9.80	41.45	54.00	-12.55	AV	Vertical
3264.66	61.03	44.70	6.70	28.20	-9.80	51.23	74.00	-22.77	PK	Horizontal
3264.66	51.24	44.70	6.70	28.20	-9.80	41.44	54.00	-12.56	AV	Horizontal
4960.58	59.44	44.20	9.04	31.60	-3.56	55.88	74.00	-18.12	PK	Vertical
4960.58	50.43	44.20	9.04	31.60	-3.56	46.87	54.00	-7.13	AV	Vertical
4960.38	58.66	44.20	9.04	31.60	-3.56	55.10	74.00	-18.90	PK	Horizontal
4960.38	50.23	44.20	9.04	31.60	-3.56	46.67	54.00	-7.33	AV	Horizontal
5359.68	48.71	44.20	9.86	32.00	-2.34	46.37	74.00	-27.63	PK	Vertical
5359.68	39.35	44.20	9.86	32.00	-2.34	37.00	54.00	-17.00	AV	Vertical
5359.59	47.72	44.20	9.86	32.00	-2.34	45.37	74.00	-28.63	PK	Horizontal
5359.59	38.48	44.20	9.86	32.00	-2.34	36.13	54.00	-17.87	AV	Horizontal
7439.88	53.52	43.50	11.40	35.50	3.40	56.92	74.00	-17.08	PK	Vertical
7439.88	44.18	43.50	11.40	35.50	3.40	47.58	54.00	-6.42	AV	Vertical
7439.84	53.65	43.50	11.40	35.50	3.40	57.05	74.00	-16.95	PK	Horizontal
7439.84	44.15	43.50	11.40	35.50	3.40	47.55	54.00	-6.45	AV	Horizontal

Note:

1) Factor = Antenna Factor + Cable Loss – Pre-amplifier.

Emission Level = Reading + Factor

2) The frequency emission of peak points that did not show above the forms are at least 20dB below the limit, the frequency emission is mainly from the environment noise.



2M PHY GFSK

Frequency (MHz)	Meter Reading (dBμV)	Amplifier (dB)	Loss (dB)	Antenna Factor (dB/m)	Corrected Factor (dB)	Emission Level (dBμV/m)	Limits (dBμV/m)	Margin (dB)	Detector Type	Comment
Low Channel (2402 MHz)										
3264.72	61.20	44.70	6.70	28.20	-9.80	51.40	74.00	-22.60	PK	Vertical
3264.72	51.74	44.70	6.70	28.20	-9.80	41.94	54.00	-12.06	AV	Vertical
3264.72	61.10	44.70	6.70	28.20	-9.80	51.30	74.00	-22.70	PK	Horizontal
3264.72	50.81	44.70	6.70	28.20	-9.80	41.01	54.00	-12.99	AV	Horizontal
4804.51	59.48	44.20	9.04	31.60	-3.56	55.92	74.00	-18.08	PK	Vertical
4804.51	49.77	44.20	9.04	31.60	-3.56	46.21	54.00	-7.79	AV	Vertical
4804.56	58.67	44.20	9.04	31.60	-3.56	55.11	74.00	-18.89	PK	Horizontal
4804.56	49.41	44.20	9.04	31.60	-3.56	45.85	54.00	-8.15	AV	Horizontal
5359.87	48.22	44.20	9.86	32.00	-2.34	45.88	74.00	-28.12	PK	Vertical
5359.87	39.15	44.20	9.86	32.00	-2.34	36.81	54.00	-17.19	AV	Vertical
5359.82	48.39	44.20	9.86	32.00	-2.34	46.05	74.00	-27.95	PK	Horizontal
5359.82	38.04	44.20	9.86	32.00	-2.34	35.70	54.00	-18.30	AV	Horizontal
7205.72	53.70	43.50	11.40	35.50	3.40	57.10	74.00	-16.90	PK	Vertical
7205.72	44.67	43.50	11.40	35.50	3.40	48.07	54.00	-5.93	AV	Vertical
7205.89	53.73	43.50	11.40	35.50	3.40	57.13	74.00	-16.87	PK	Horizontal
7205.89	44.76	43.50	11.40	35.50	3.40	48.16	54.00	-5.84	AV	Horizontal
Middle Channel (2440 MHz)										
3264.68	62.01	44.70	6.70	28.20	-9.80	52.21	74.00	-21.79	PK	Vertical
3264.68	50.58	44.70	6.70	28.20	-9.80	40.78	54.00	-13.22	AV	Vertical
3264.57	61.76	44.70	6.70	28.20	-9.80	51.96	74.00	-22.04	PK	Horizontal
3264.57	51.32	44.70	6.70	28.20	-9.80	41.52	54.00	-12.48	AV	Horizontal
4880.45	59.55	44.20	9.04	31.60	-3.56	55.99	74.00	-18.01	PK	Vertical
4880.45	50.45	44.20	9.04	31.60	-3.56	46.89	54.00	-7.11	AV	Vertical
4880.53	58.56	44.20	9.04	31.60	-3.56	55.00	74.00	-19.00	PK	Horizontal
4880.53	50.56	44.20	9.04	31.60	-3.56	47.00	54.00	-7.00	AV	Horizontal
5359.62	48.28	44.20	9.86	32.00	-2.34	45.93	74.00	-28.07	PK	Vertical
5359.62	39.09	44.20	9.86	32.00	-2.34	36.74	54.00	-17.26	AV	Vertical
5359.60	47.67	44.20	9.86	32.00	-2.34	45.33	74.00	-28.67	PK	Horizontal
5359.60	38.99	44.20	9.86	32.00	-2.34	36.64	54.00	-17.36	AV	Horizontal
7320.70	54.83	43.50	11.40	35.50	3.40	58.23	74.00	-15.77	PK	Vertical
7320.70	44.49	43.50	11.40	35.50	3.40	47.89	54.00	-6.11	AV	Vertical
7320.77	53.59	43.50	11.40	35.50	3.40	56.99	74.00	-17.01	PK	Horizontal
7320.77	44.17	43.50	11.40	35.50	3.40	47.57	54.00	-6.43	AV	Horizontal



High Channel (2480 MHz)										
3264.90	61.50	44.70	6.70	28.20	-9.80	51.70	74.00	-22.30	PK	Vertical
3264.90	51.25	44.70	6.70	28.20	-9.80	41.45	54.00	-12.55	AV	Vertical
3264.66	61.03	44.70	6.70	28.20	-9.80	51.23	74.00	-22.77	PK	Horizontal
3264.66	51.24	44.70	6.70	28.20	-9.80	41.44	54.00	-12.56	AV	Horizontal
4960.58	59.44	44.20	9.04	31.60	-3.56	55.88	74.00	-18.12	PK	Vertical
4960.58	50.43	44.20	9.04	31.60	-3.56	46.87	54.00	-7.13	AV	Vertical
4960.38	58.66	44.20	9.04	31.60	-3.56	55.10	74.00	-18.90	PK	Horizontal
4960.38	50.23	44.20	9.04	31.60	-3.56	46.67	54.00	-7.33	AV	Horizontal
5359.68	48.71	44.20	9.86	32.00	-2.34	46.37	74.00	-27.63	PK	Vertical
5359.68	39.35	44.20	9.86	32.00	-2.34	37.00	54.00	-17.00	AV	Vertical
5359.59	47.72	44.20	9.86	32.00	-2.34	45.37	74.00	-28.63	PK	Horizontal
5359.59	38.48	44.20	9.86	32.00	-2.34	36.13	54.00	-17.87	AV	Horizontal
7439.88	53.52	43.50	11.40	35.50	3.40	56.92	74.00	-17.08	PK	Vertical
7439.88	44.18	43.50	11.40	35.50	3.40	47.58	54.00	-6.42	AV	Vertical
7439.84	53.65	43.50	11.40	35.50	3.40	57.05	74.00	-16.95	PK	Horizontal
7439.84	44.15	43.50	11.40	35.50	3.40	47.55	54.00	-6.45	AV	Horizontal

Note:

1) Factor = Antenna Factor + Cable Loss – Pre-amplifier.

Emission Level = Reading + Factor

2) The frequency emission of peak points that did not show above the forms are at least 20dB below the limit, the frequency emission is mainly from the environment noise.



4.6 TEST RESULTS (Restricted Bands Requirements)

1M PHY
GFSK-Low
Horizontal

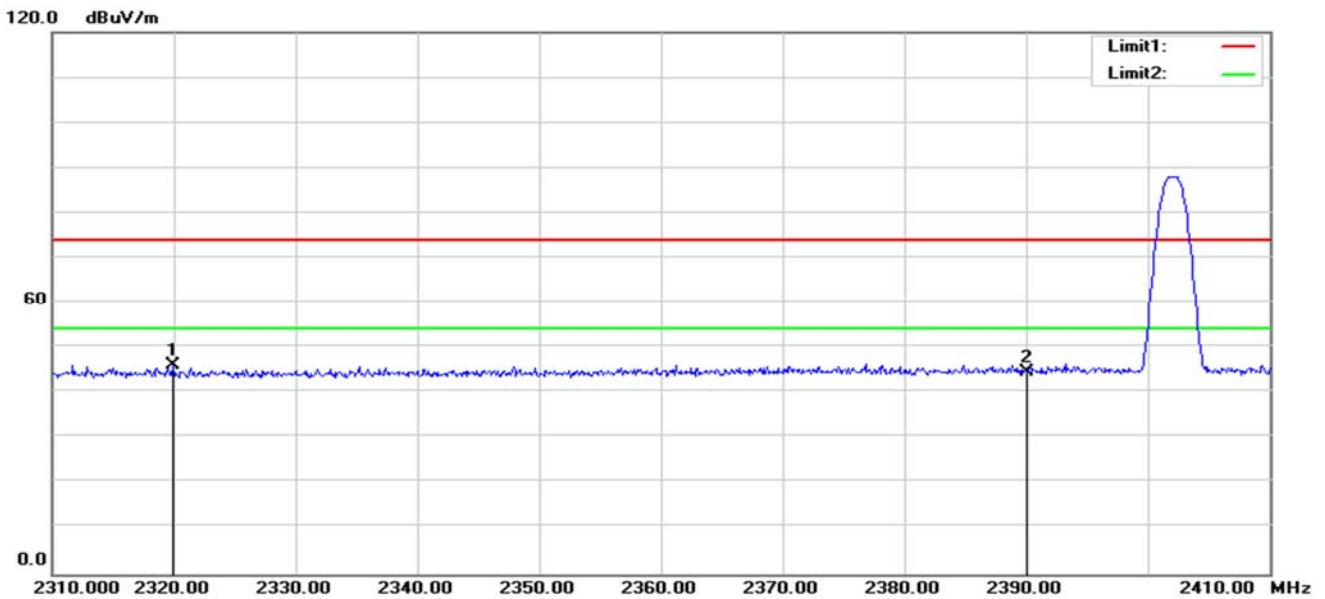

No.	Frequency (MHz)	Reading (dBuV)	Correct Factor(dB/m)	Result (dBuV/m)	Limit (dBuV/m)	Margin (dB)	Remark
1	2319.900	42.34	3.58	45.92	74.00	-28.08	peak
2	2390.000	40.14	4.34	44.48	74.00	-29.52	peak

Vertical

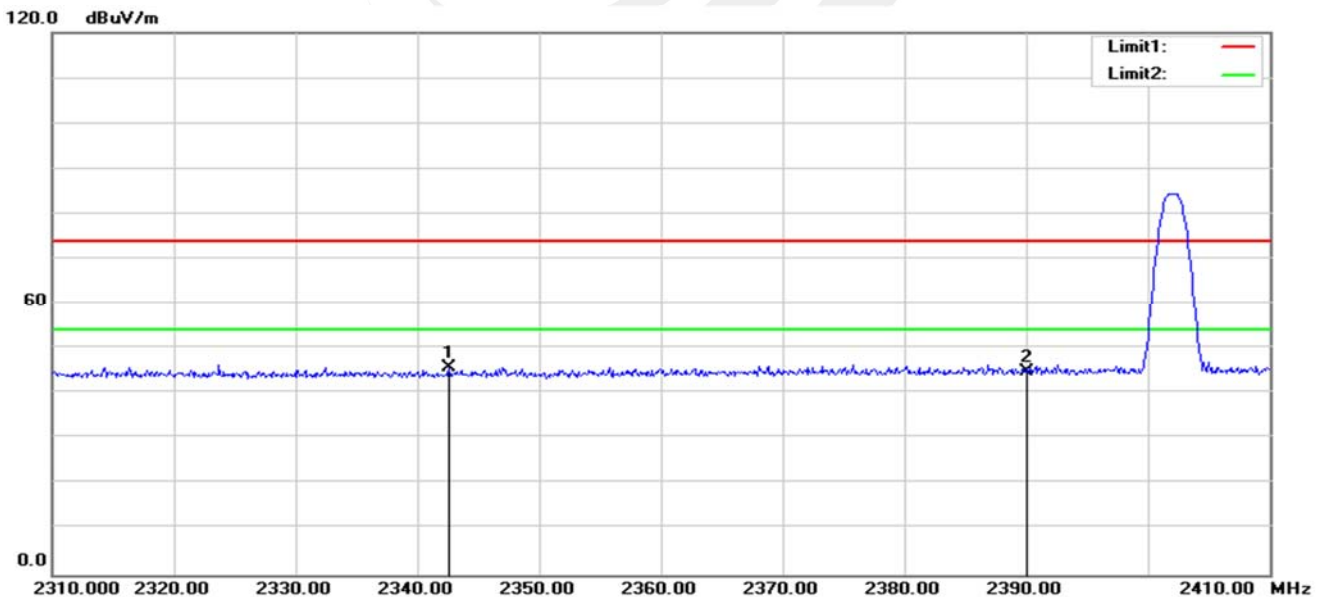

No.	Frequency (MHz)	Reading (dBuV)	Correct Factor(dB/m)	Result (dBuV/m)	Limit (dBuV/m)	Margin (dB)	Remark
1	2342.600	42.14	3.70	45.84	74.00	-28.16	peak
2	2390.000	40.49	4.34	44.83	74.00	-29.17	peak



GFSK-High
Horizontal

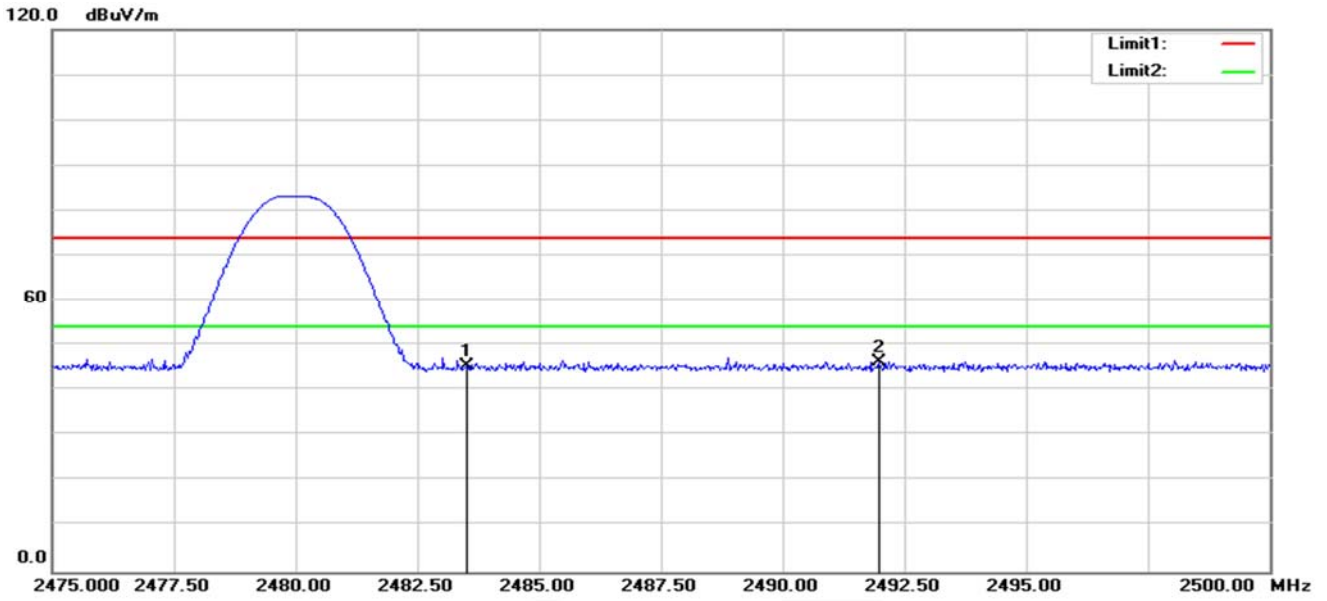

No.	Frequency (MHz)	Reading (dBuV)	Correct Factor(dB/m)	Result (dBuV/m)	Limit (dBuV/m)	Margin (dB)	Remark
1	2483.500	40.89	4.60	45.49	74.00	-28.51	peak
2	2491.975	41.81	4.63	46.44	74.00	-27.56	peak

Vertical

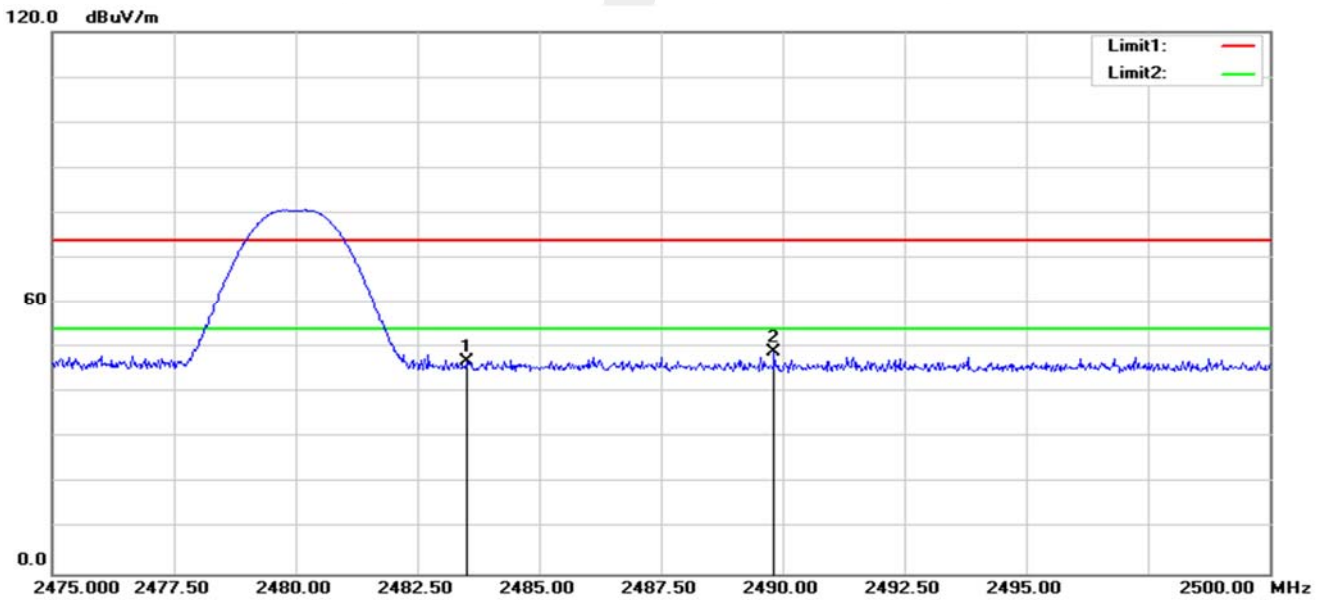

No.	Frequency (MHz)	Reading (dBuV)	Correct Factor(dB/m)	Result (dBuV/m)	Limit (dBuV/m)	Margin (dB)	Remark
1	2483.500	42.27	4.60	46.87	74.00	-27.13	peak
2	2489.825	44.34	4.63	48.97	74.00	-25.03	peak



2M PHY
GFSK-Low
Horizontal

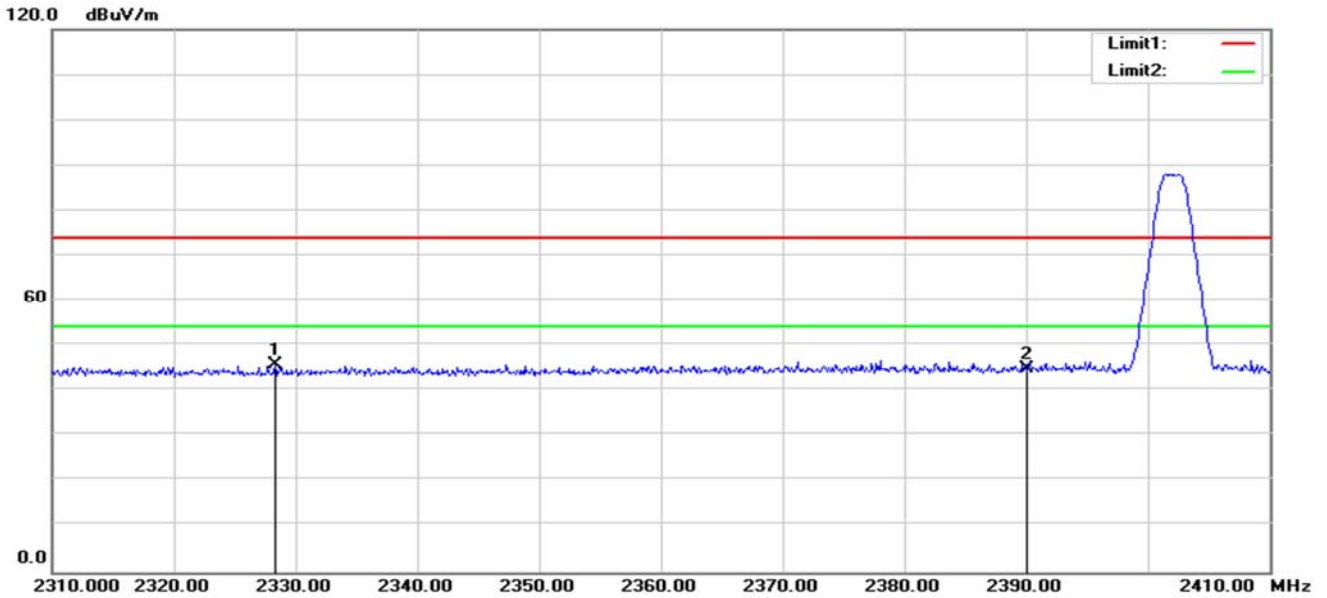

No.	Frequency (MHz)	Reading (dBuV)	Correct Factor(dB/m)	Result (dBuV/m)	Limit (dBuV/m)	Margin (dB)	Remark
1	2328.300	42.01	3.63	45.64	74.00	-28.36	peak
2	2390.000	40.57	4.34	44.91	74.00	-29.09	peak

Vertical

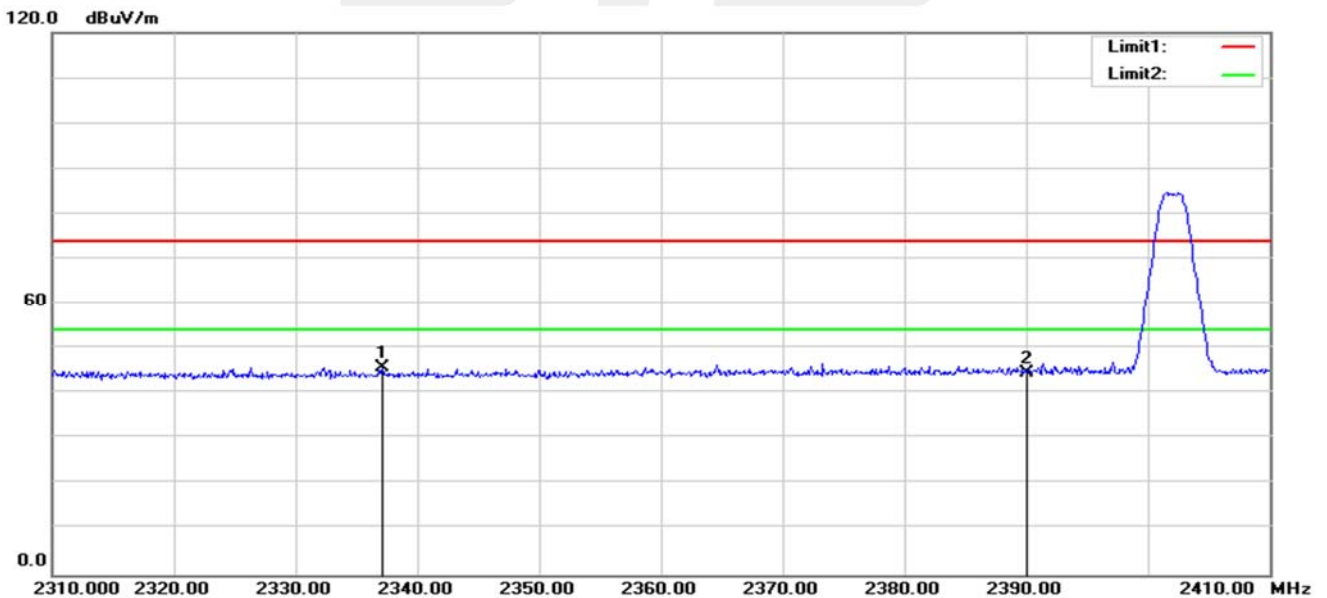

No.	Frequency (MHz)	Reading (dBuV)	Correct Factor(dB/m)	Result (dBuV/m)	Limit (dBuV/m)	Margin (dB)	Remark
1	2337.100	42.07	3.67	45.74	74.00	-28.26	peak
2	2390.000	40.11	4.34	44.45	74.00	-29.55	peak



GFSK-High
Horizontal

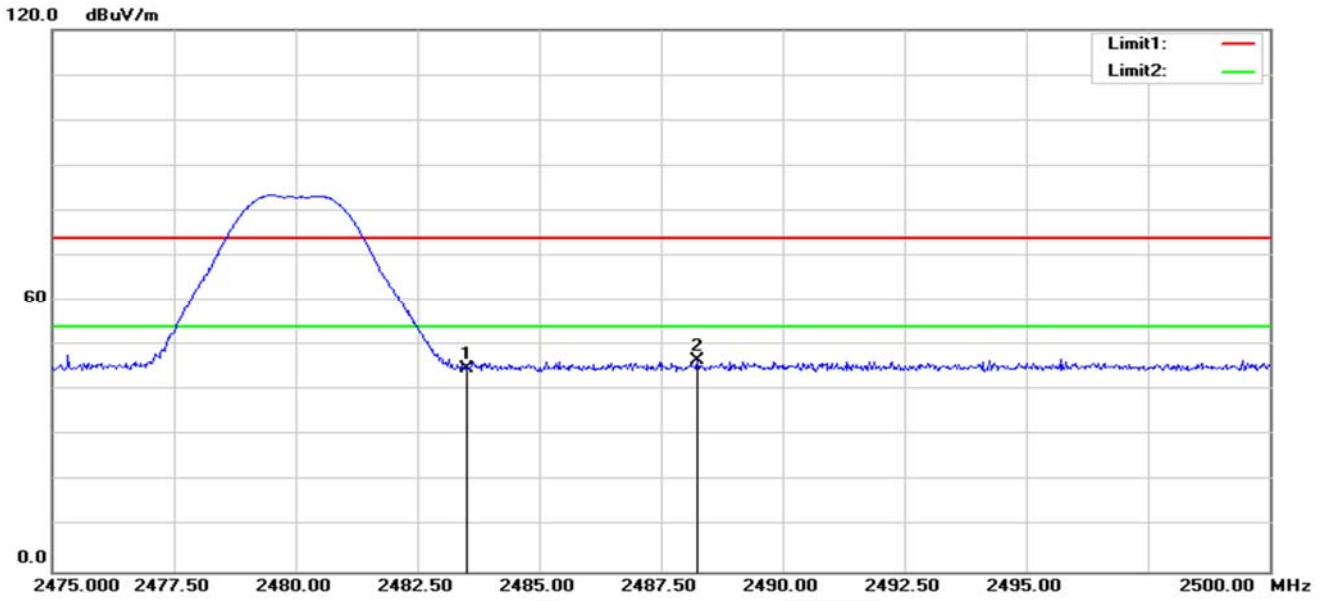

No.	Frequency (MHz)	Reading (dBuV)	Correct Factor(dB/m)	Result (dBuV/m)	Limit (dBuV/m)	Margin (dB)	Remark
1	2483.500	40.32	4.60	44.92	74.00	-29.08	peak
2	2488.250	42.15	4.62	46.77	74.00	-27.23	peak

Vertical

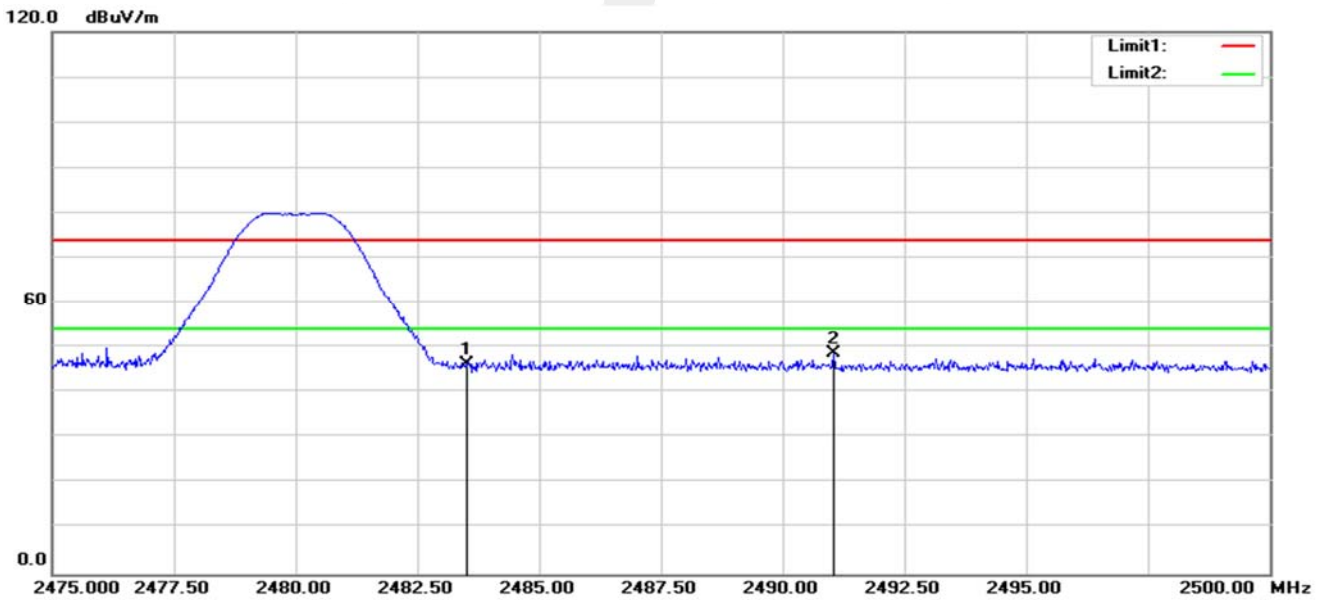

No.	Frequency (MHz)	Reading (dBuV)	Correct Factor(dB/m)	Result (dBuV/m)	Limit (dBuV/m)	Margin (dB)	Remark
1	2483.500	41.70	4.60	46.30	74.00	-27.70	peak
2	2491.050	44.24	4.63	48.87	74.00	-25.13	peak

5. CONDUCTED SPURIOUS & BAND EDGE EMISSION

5.1 LIMIT

According to FCC section 15.247(d)&RSS-247 Issue 2, in any 100kHz bandwidth outside the frequency band in which the spread spectrum or digitally modulated intentional radiator is operating, the radio frequency power that is produced by the intentional radiator shall be at least 20dB below that in the 100kHz bandwidth within the band that contains the highest level of the desired power, based on either an RF conducted or a radiated measurement.

5.2 TEST PROCEDURE

Spectrum Parameter	Setting
Detector	Peak
Start/Stop Frequency	30 MHz to 10th carrier harmonic
RB / VB (emission in restricted band)	100 KHz/300 KHz
Trace-Mode:	Max hold

For Band edge

Spectrum Parameter	Setting
Detector	Peak
Start/Stop Frequency	Lower Band Edge: 2300 – 2407 MHz Upper Band Edge: 2475 – 2500 MHz
RB / VB (emission in restricted band)	100 KHz/300 KHz
Trace-Mode:	Max hold

5.3 TEST SETUP



The EUT which is powered by the Battery, is connected to the Spectrum Analyzer; the RF load attached to the EUT antenna terminal is 50 Ohm; the path loss as the factor is calibrated to correct the reading. Make the measurement with the spectrum analyzer's resolution bandwidth(RBW) = 100 kHz. In order to make an accurate measurement, set the span greater than RBW.

5.4 EUT OPERATION CONDITIONS

Please refer to section 3.4 of this report.



5.5 TEST RESULTS

Temperature:	25 °C	Relative Humidity:	50%
Test Voltage:	DC 3.7V	Test Mode:	TX Mode /CH00, CH19, CH39

1M PHY
00 CH





19 CH

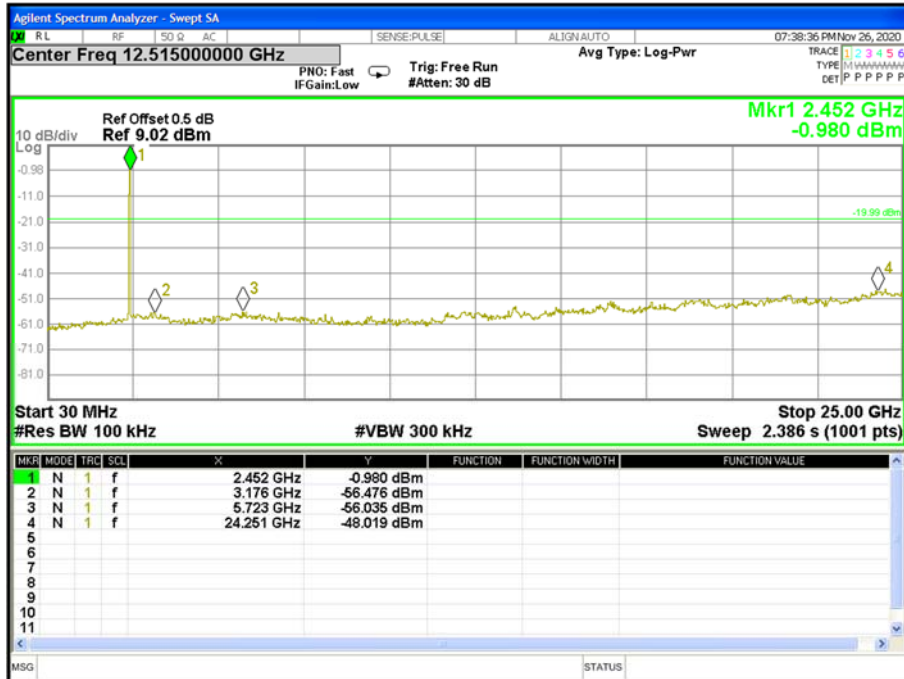

39 CH

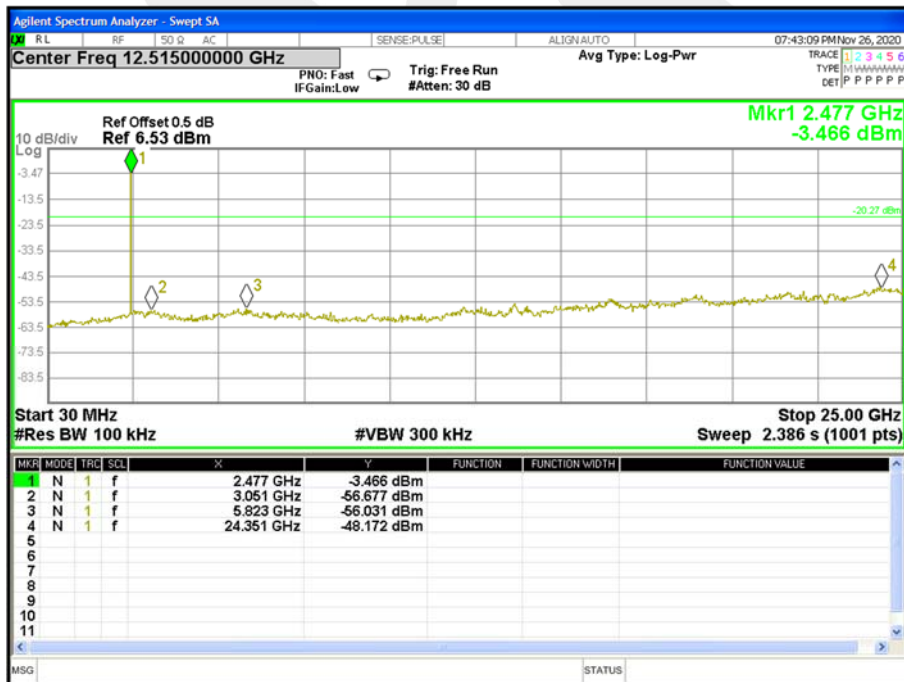



For Band edge(it's also the reference level for conducted spurious emission)

00 CH

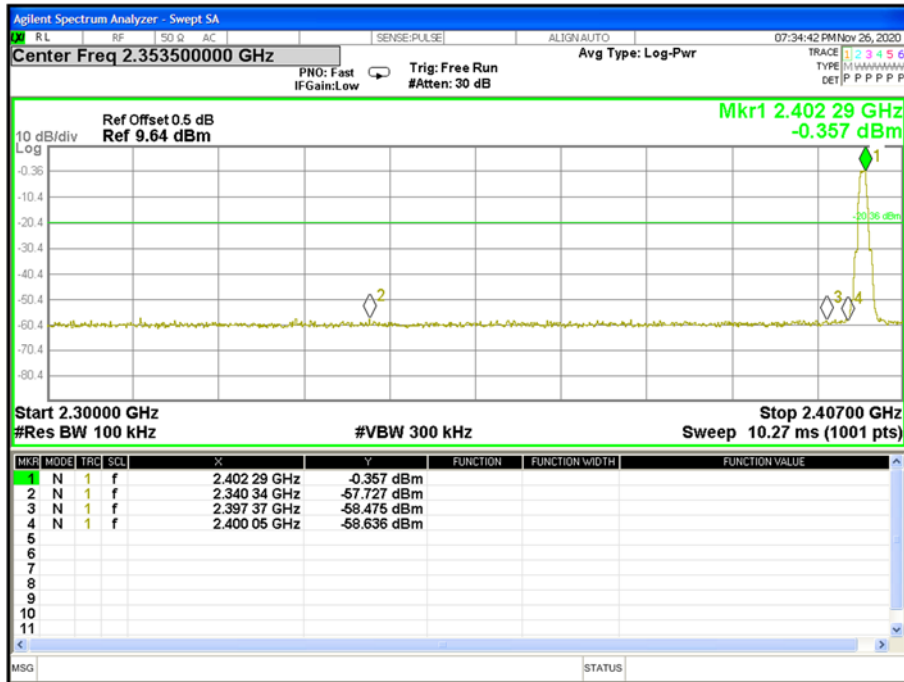

19 CH

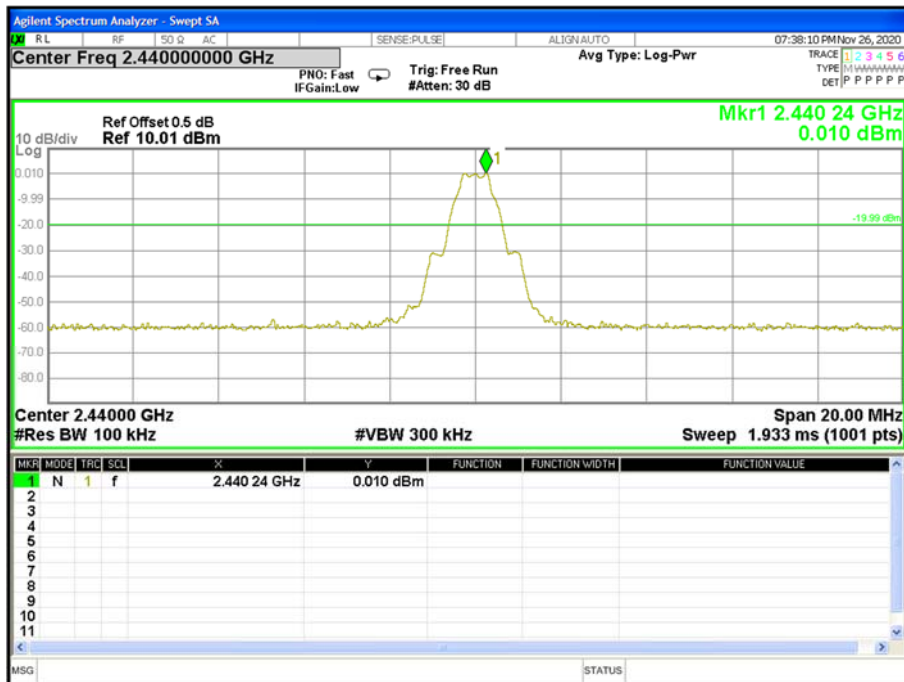



2M PHY
00 CH

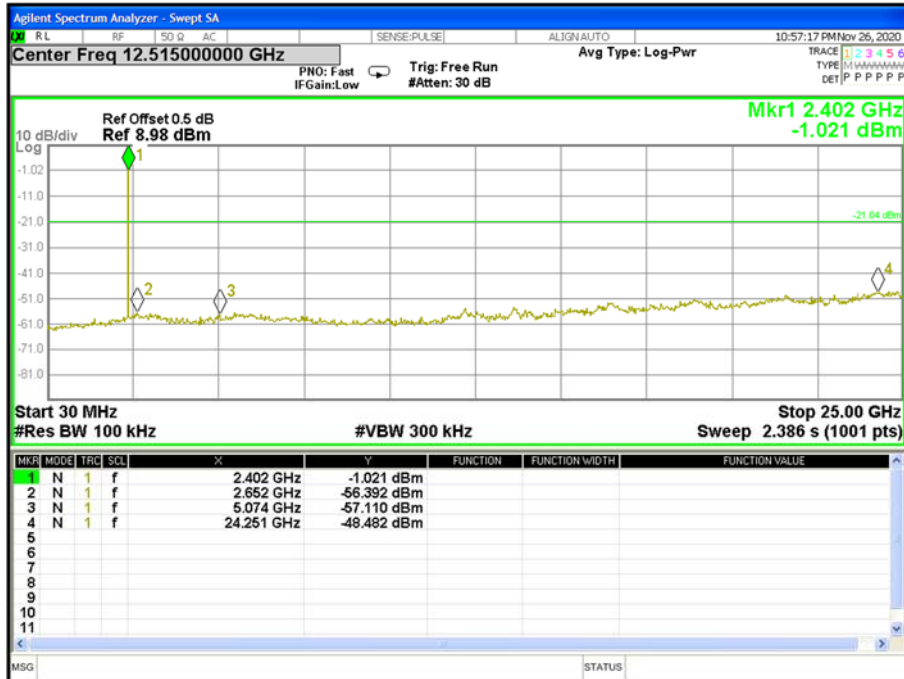



19 CH

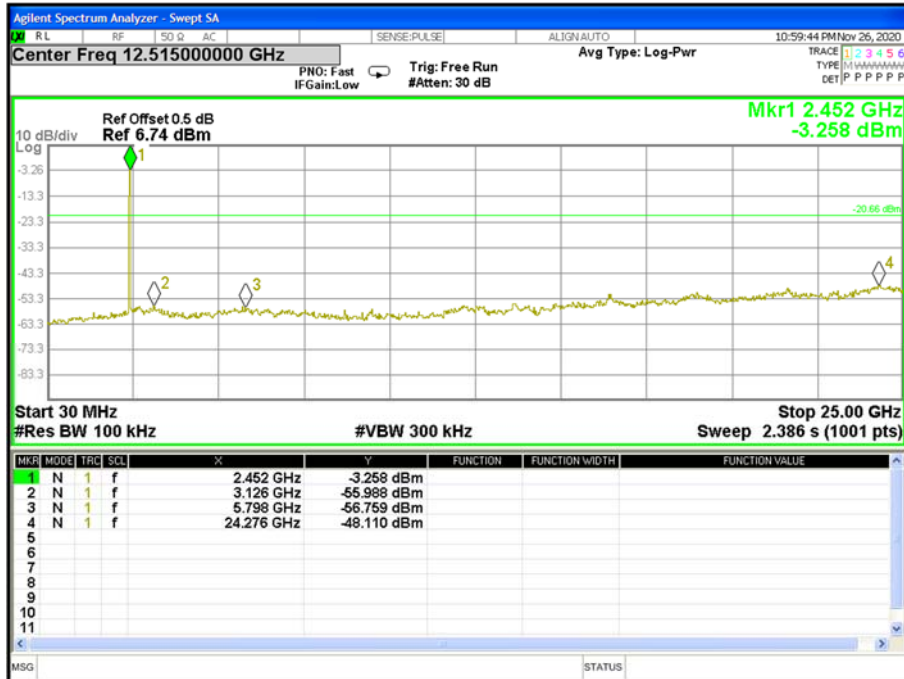

39 CH

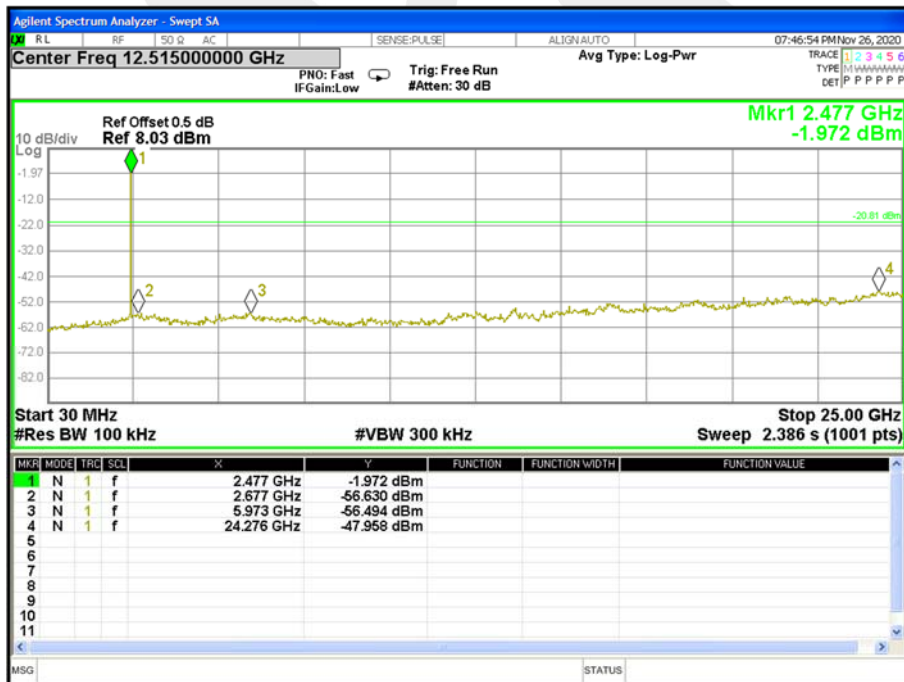



For Band edge(it's also the reference level for conducted spurious emission)

00 CH

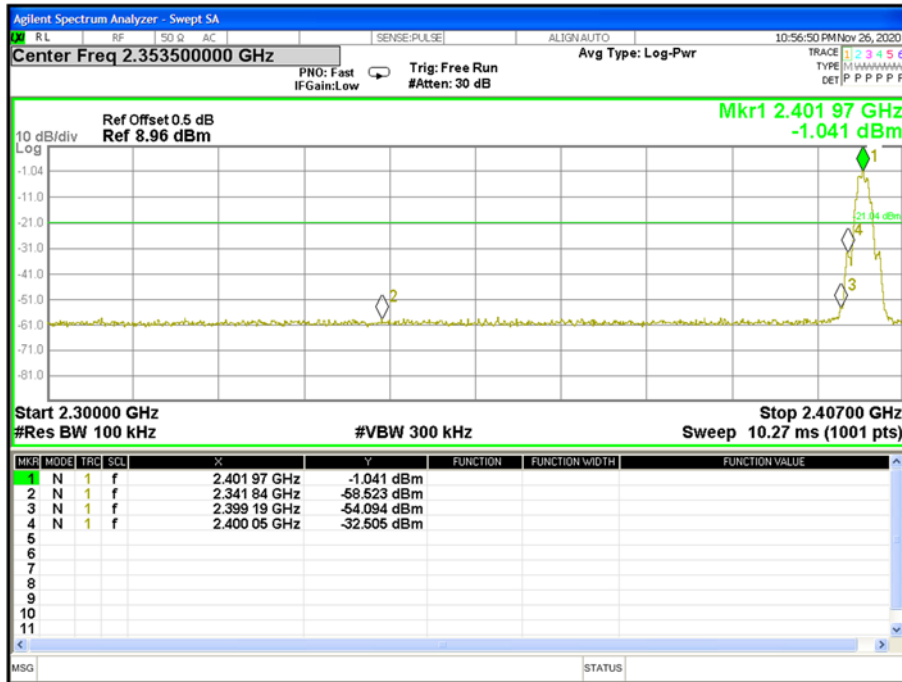

19 CH

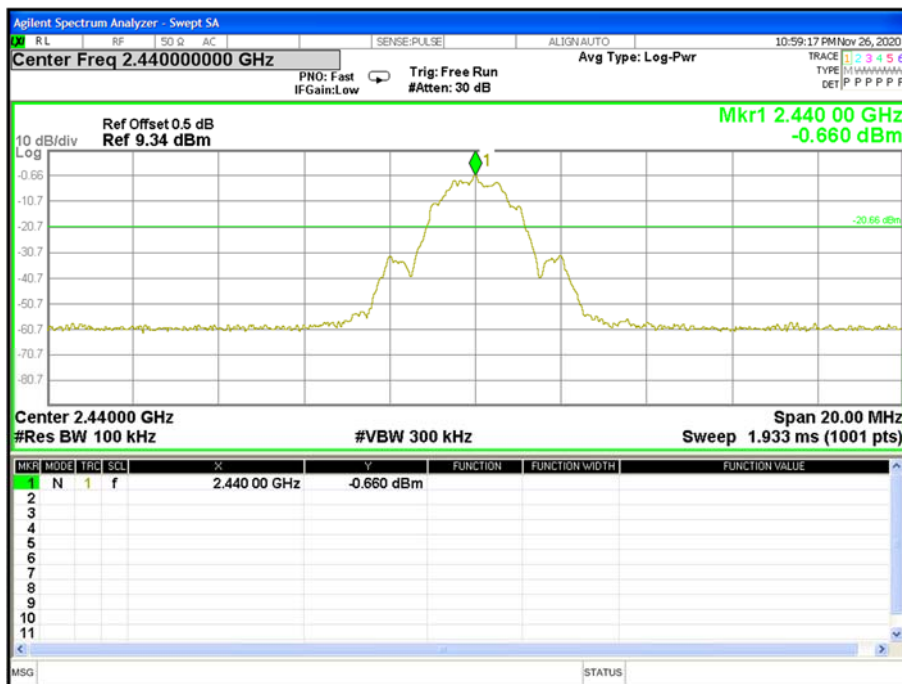



39 CH

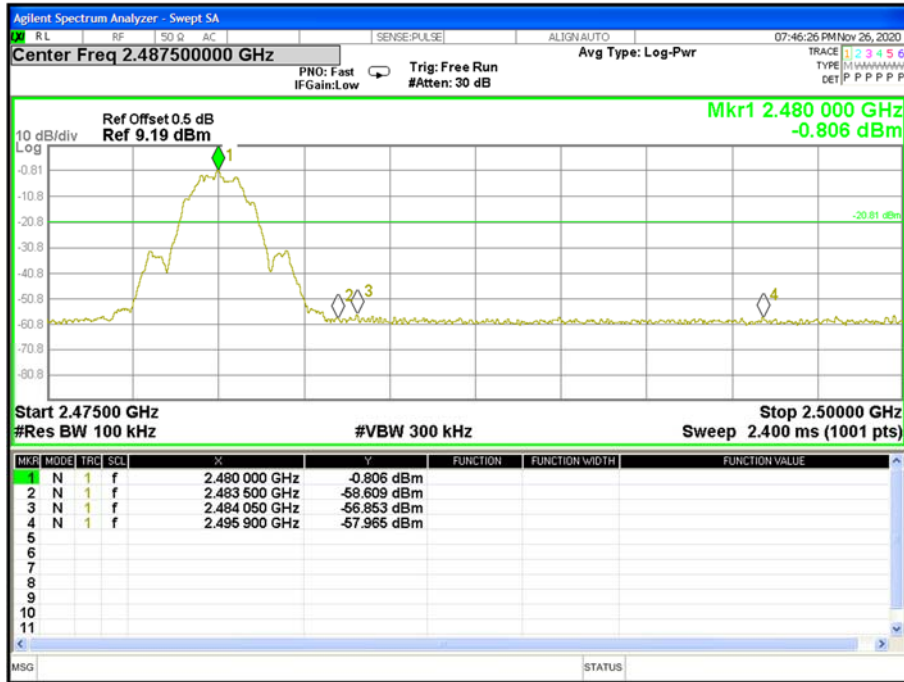

6. POWER SPECTRAL DENSITY TEST

6.1 LIMIT

FCC Part 15.247, Subpart C RSS-247 Issue 2				
Section	Test Item	Limit	Frequency Range (MHz)	Result
15.247(e) RSS-247 Issue 2	Power Spectral Density	≤ 8 dBm (RBW ≥ 3 KHz)	2400-2483.5	PASS

6.2 TEST PROCEDURE

1. Set analyzer center frequency to DTS channel center frequency.
2. Set the span to 1.5 times the DTS channel bandwidth.
3. Set the RBW to: $100 \text{ kHz} \geq \text{RBW} \geq 3 \text{ kHz}$.
4. Set the VBW $\geq 3 \times \text{RBW}$.
5. Detector = peak.
6. Sweep time = auto couple.
7. Trace mode = max hold.
8. Allow trace to fully stabilize.
9. Use the peak marker function to determine the maximum amplitude level.
10. If measured value exceeds limit, reduce RBW (no less than 3 kHz) and repeat.

6.3 TEST SETUP



6.4 EUT OPERATION CONDITIONS

Please refer to section 3.4 of this report.



6.5 TEST RESULTS

Temperature:	25 °C	Relative Humidity:	60%
Test Voltage:	DC 3.7V	Test Mode:	TX Mode /CH00, CH19, CH39

1M PHY

Frequency	Power Density	Limit (dBm/3KHz)	Result
	(dBm/3kHz)		
2402 MHz	-15.035	≤8	PASS
2440 MHz	-14.722	≤8	PASS
2480 MHz	-14.920	≤8	PASS

TX CH00

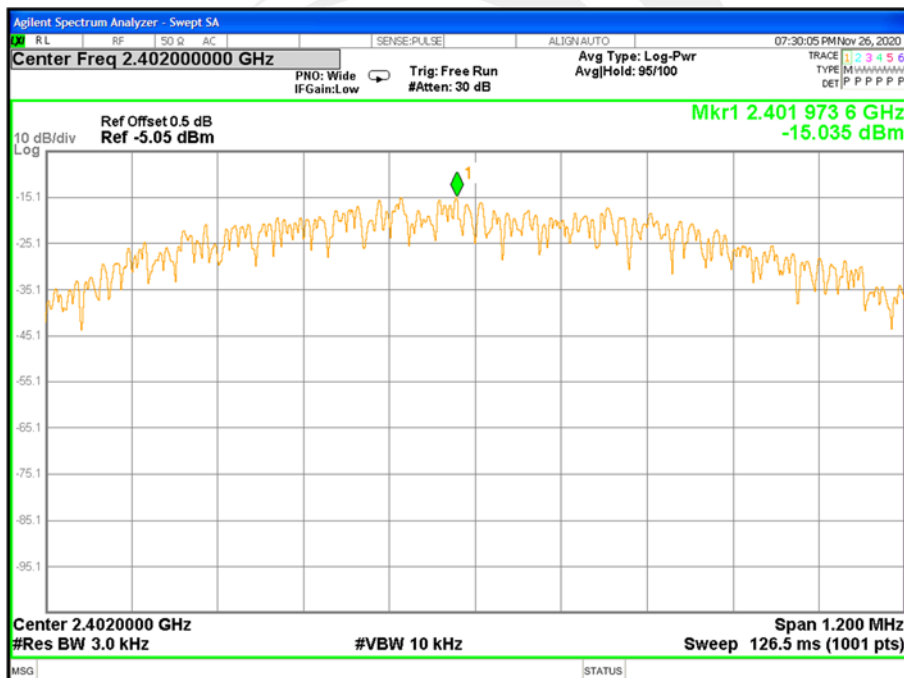



TX CH19

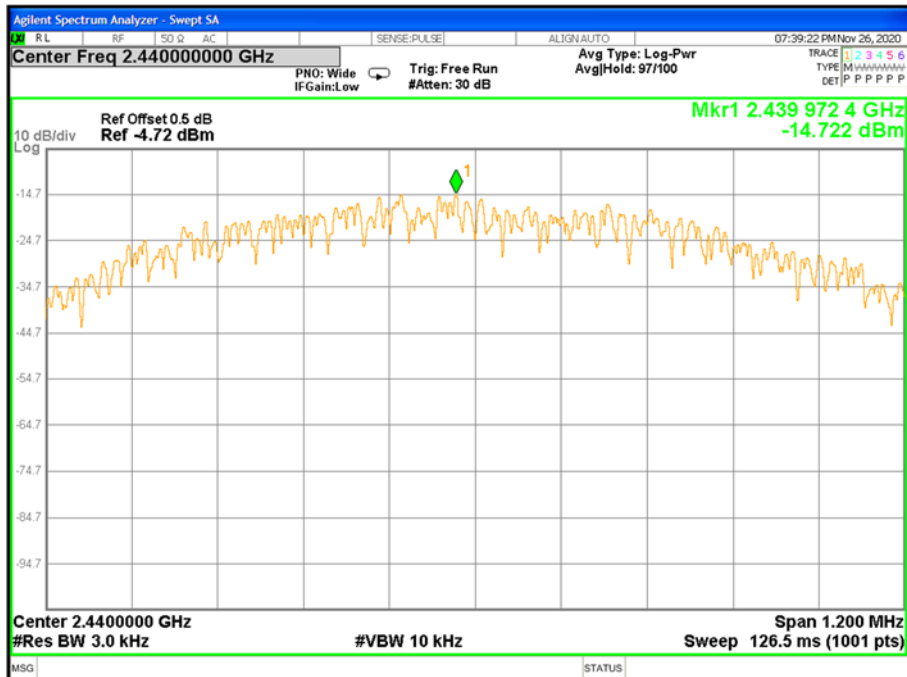

TX CH39

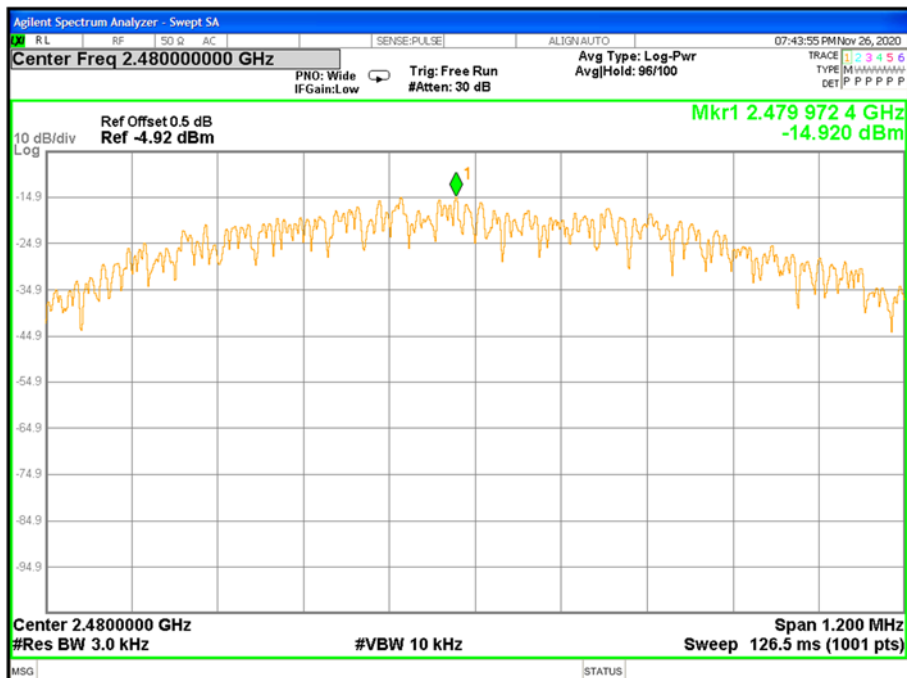



2M PHY

Frequency	Power Density	Limit (dBm/3KHz)	Result
	(dBm/3kHz)		
2402 MHz	-15.035	≤8	PASS
2440 MHz	-14.722	≤8	PASS
2480 MHz	-14.920	≤8	PASS

TX CH00

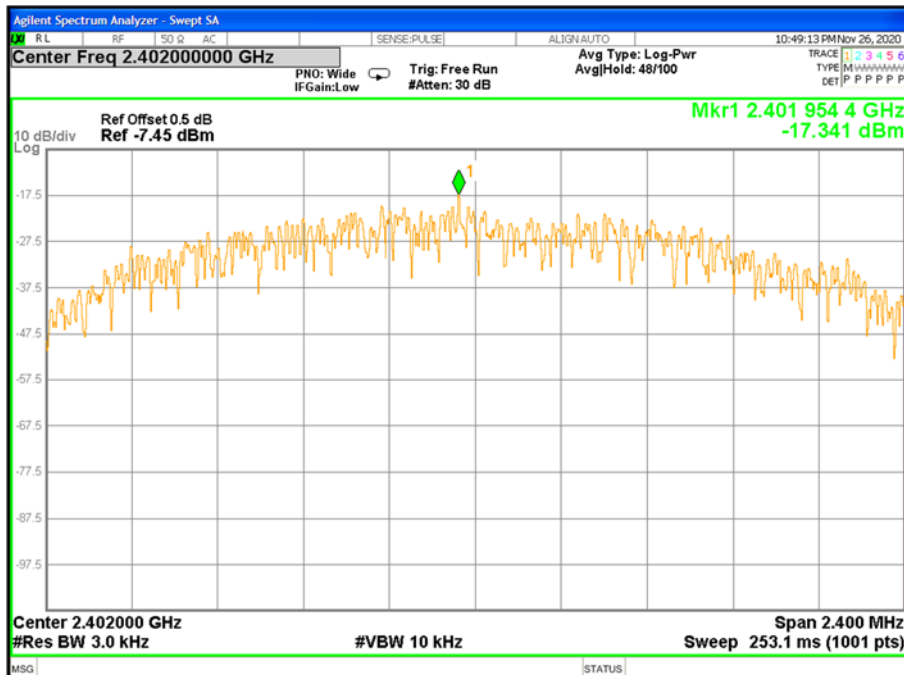



TX CH19

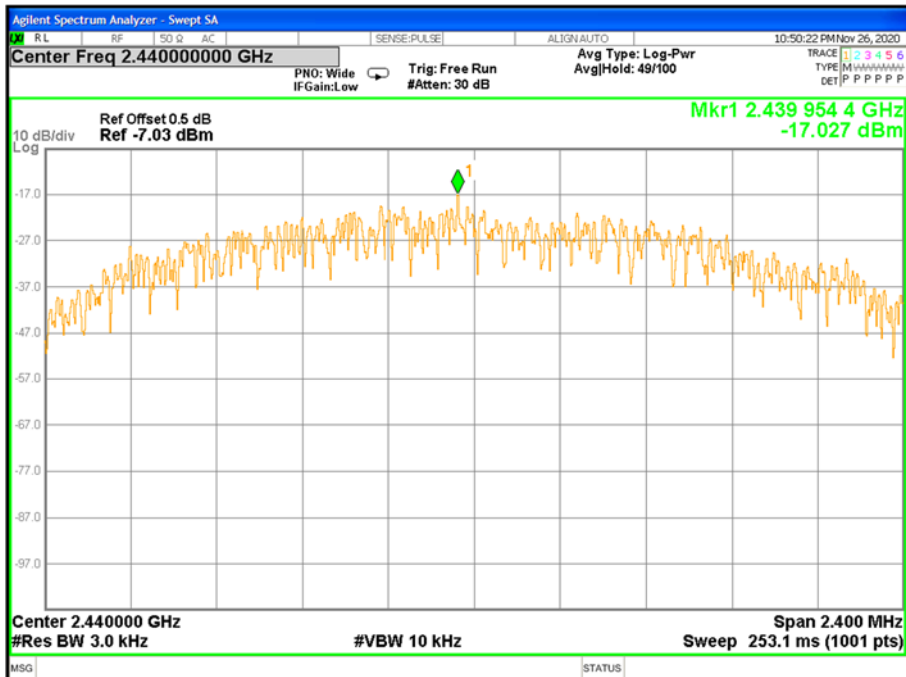

TX CH39

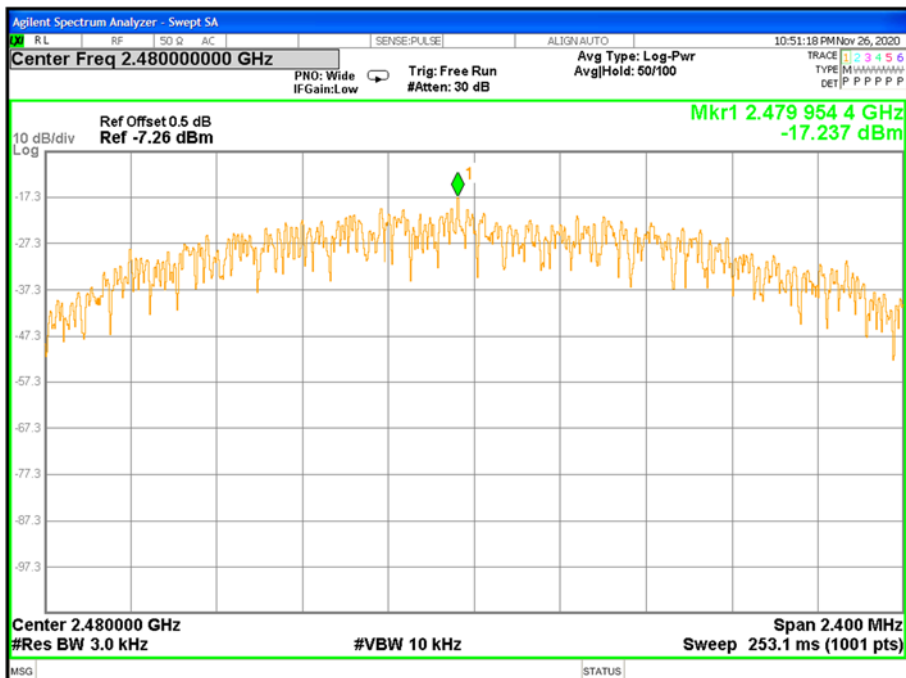

7. BANDWIDTH TEST

7.1 LIMIT

FCC Part 15.247, Subpart C RSS-Gen Clause 6.7				
Section	Test Item	Limit	Frequency Range (MHz)	Result
15.247(a)(2) RSS-247 5.2 (a)	Bandwidth	$\geq 500\text{KHz}$ (6dB bandwidth)	2400-2483.5	PASS
RSS-Gen Clause 6.7	99% Bandwidth	For reporting purposes only.	2400-2483.5	PASS

7.2 TEST PROCEDURE

Connect the UUT to the spectrum analyser and use the following settings:

Center Frequency	The centre frequency of the channel under test
Detector	Peak
RBW	For 6 dB Bandwidth : 100KHz For 99% Bandwidth : 1% to 5% of the occupied bandwidth
VBW	For 6dB Bandwidth : $\geq 3 \times \text{RBW}$ For 99% Bandwidth : approximately $3 \times \text{RBW}$
Trace	Max hold
Sweep	Auto

Allow the trace to stabilize and measure the maximum width of the emission that is constrained by the frequencies associated with the two outermost amplitude points (upper and lower frequencies) that are attenuated by 6 dB and 99% relative to the maximum level measured in the fundamental emission.

7.3 TEST SETUP

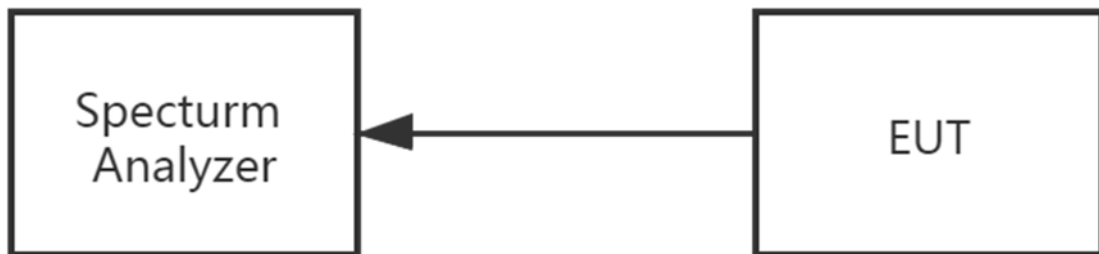

7.4 EUT OPERATION CONDITIONS

Please refer to section 3.4 of this report.



7.5 TEST RESULTS

Temperature:	25 °C	Relative Humidity:	60%
Test Voltage:	DC 3.7V	Test Mode:	TX Mode /CH00, CH19, CH39

1M PHY

Frequency	6dB Bandwidth (KHz)	99% Bandwidth (KHz)	6dB Bandwidth Limit (KHz)	Result
2402 MHz	710.200	1043.500	≥500KHz	PASS
2440 MHz	713.000	1042.300	≥500KHz	PASS
2480 MHz	714.100	1042.000	≥500KHz	PASS

6dB Bandwidth TX CH 00

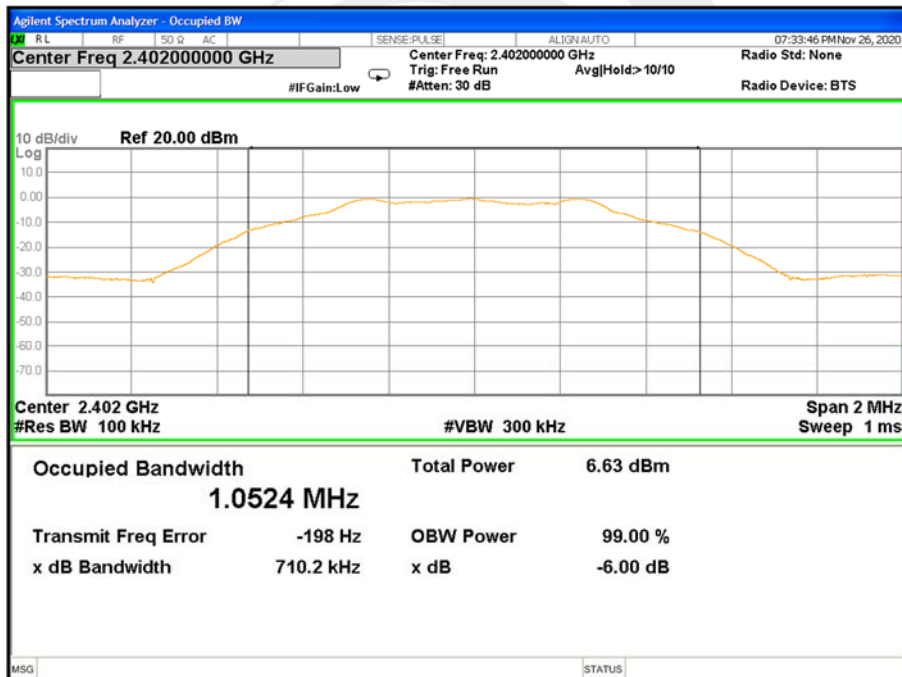



6dB Bandwidth TX CH 19

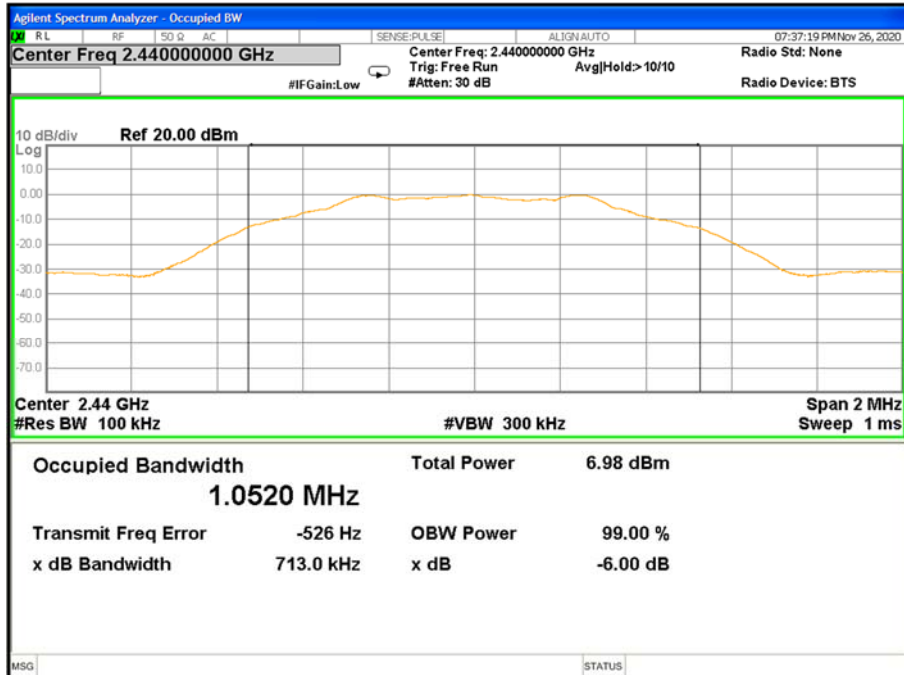

6dB Bandwidth TX CH 39

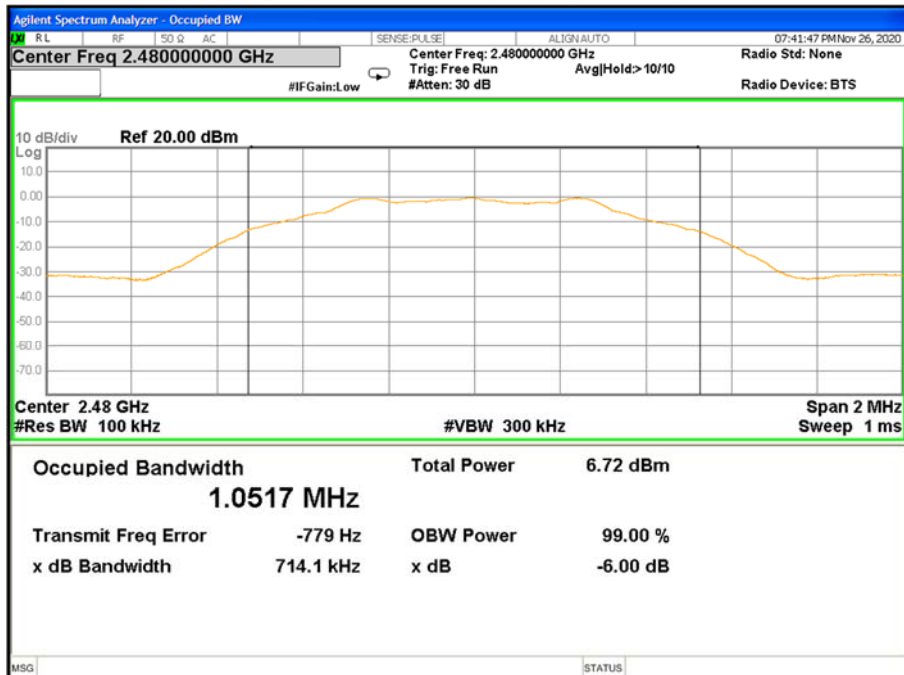



99% Bandwidth TX CH 00

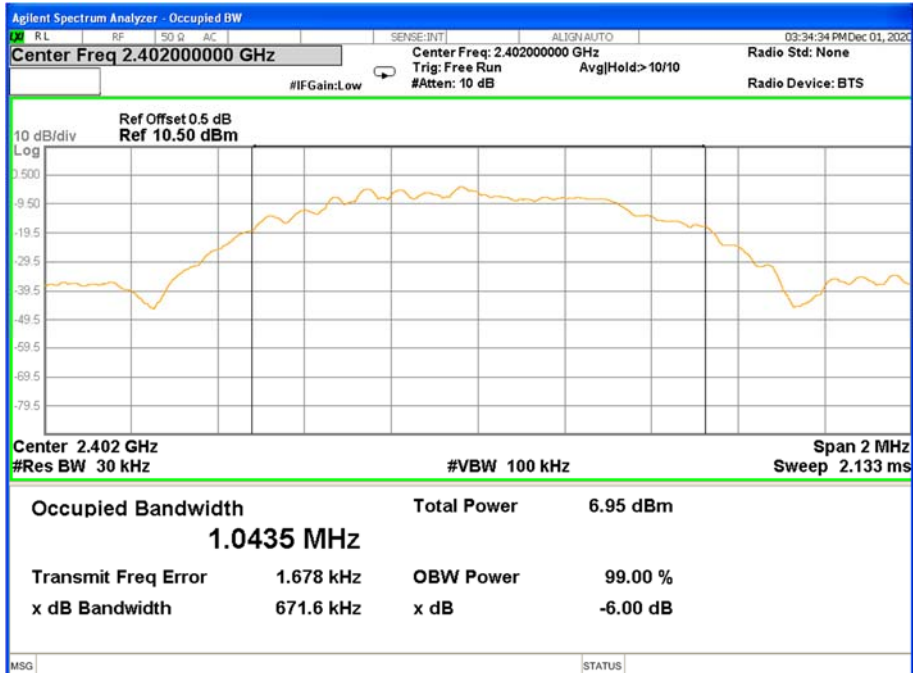

99% Bandwidth TX CH 19

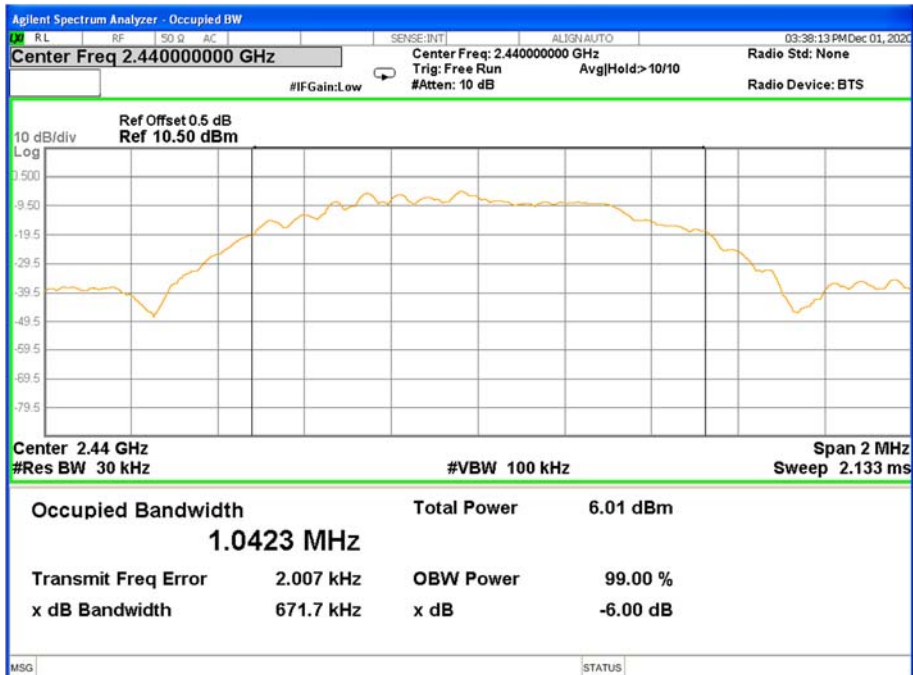



99% Bandwidth TX CH 39

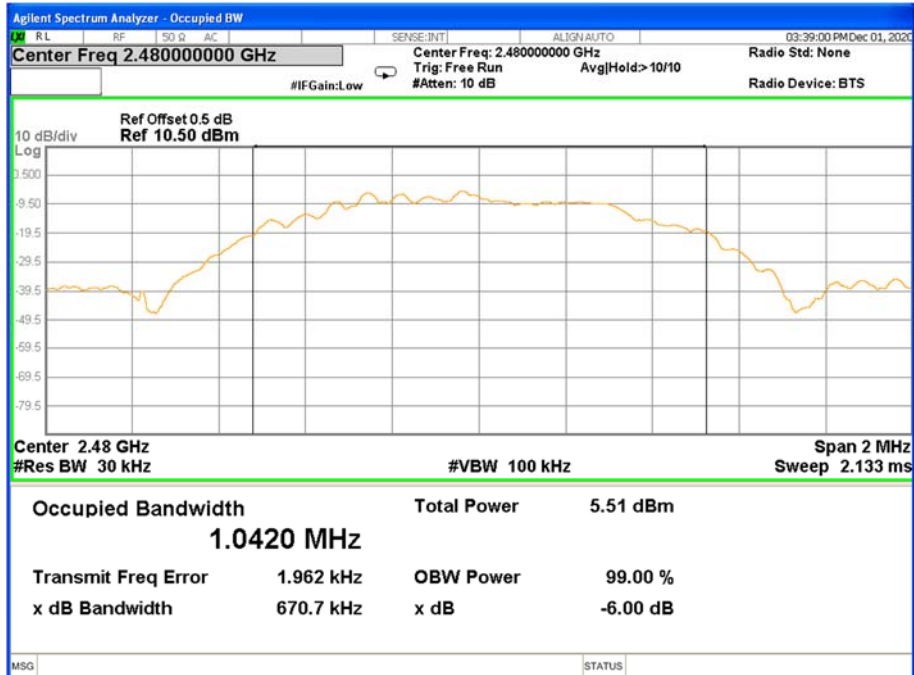



2M PHY

Frequency	6dB Bandwidth (KHz)	99% Bandwidth (KHz)	6dB Bandwidth Limit (KHz)	Result
2402 MHz	710.200	1043.500	≥500KHz	PASS
2440 MHz	713.000	1042.300	≥500KHz	PASS
2480 MHz	714.100	1042.000	≥500KHz	PASS

6dB Bandwidth TX CH 00

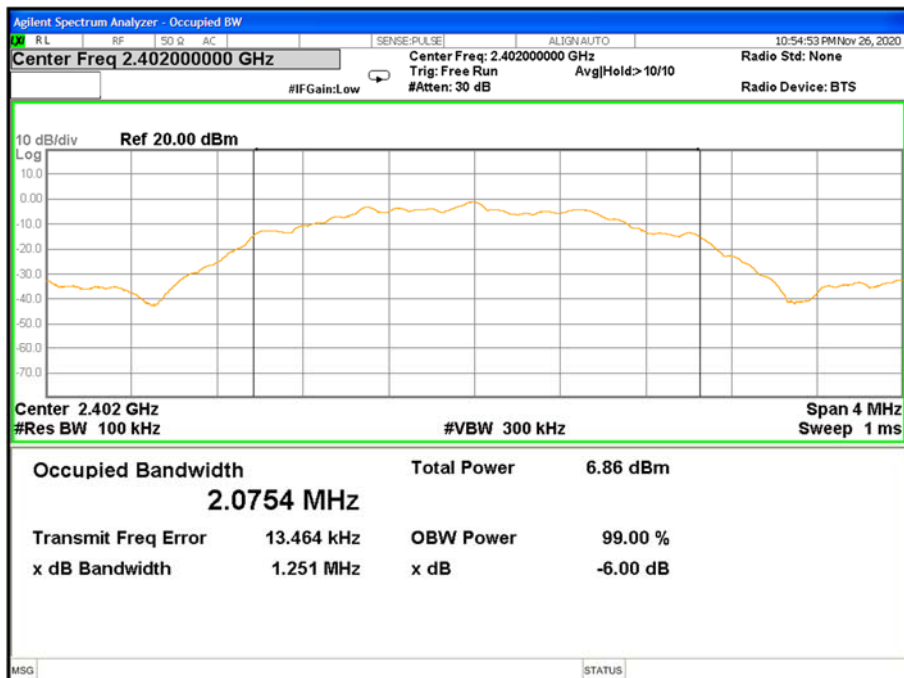



6dB Bandwidth TX CH 19

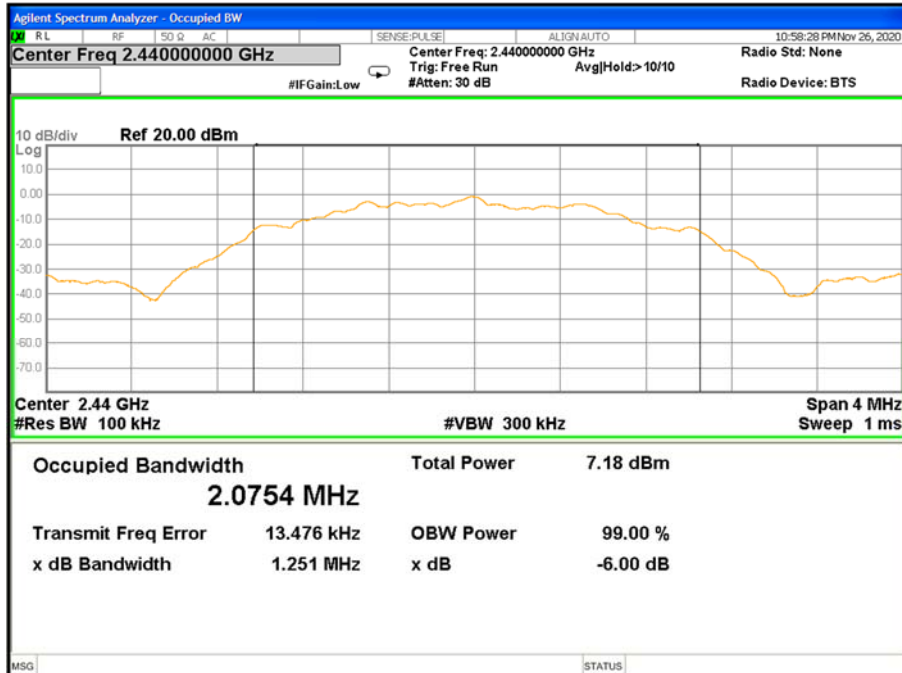

6dB Bandwidth TX CH 39

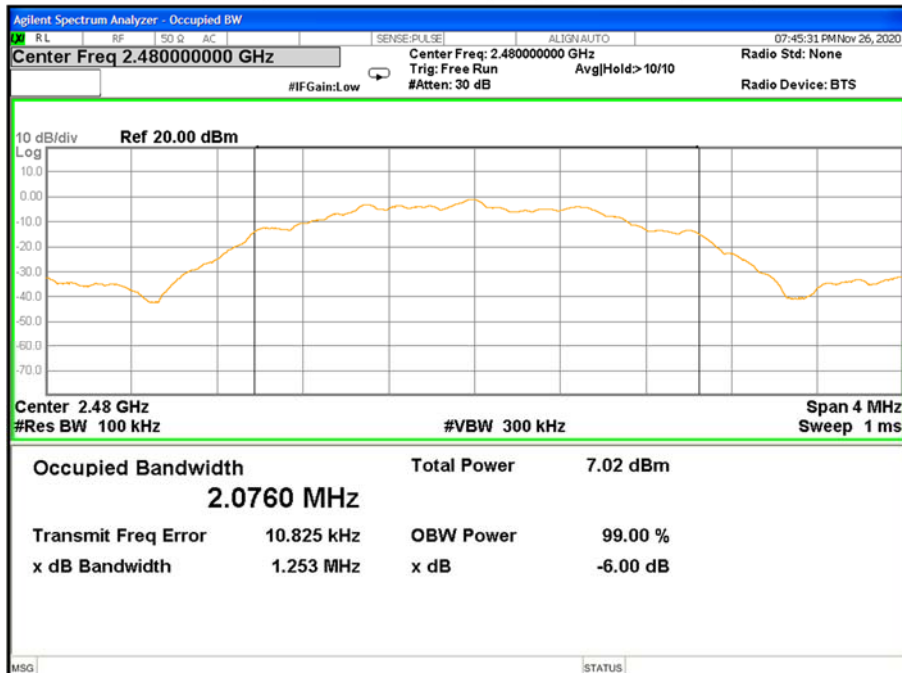



99% Bandwidth TX CH 00

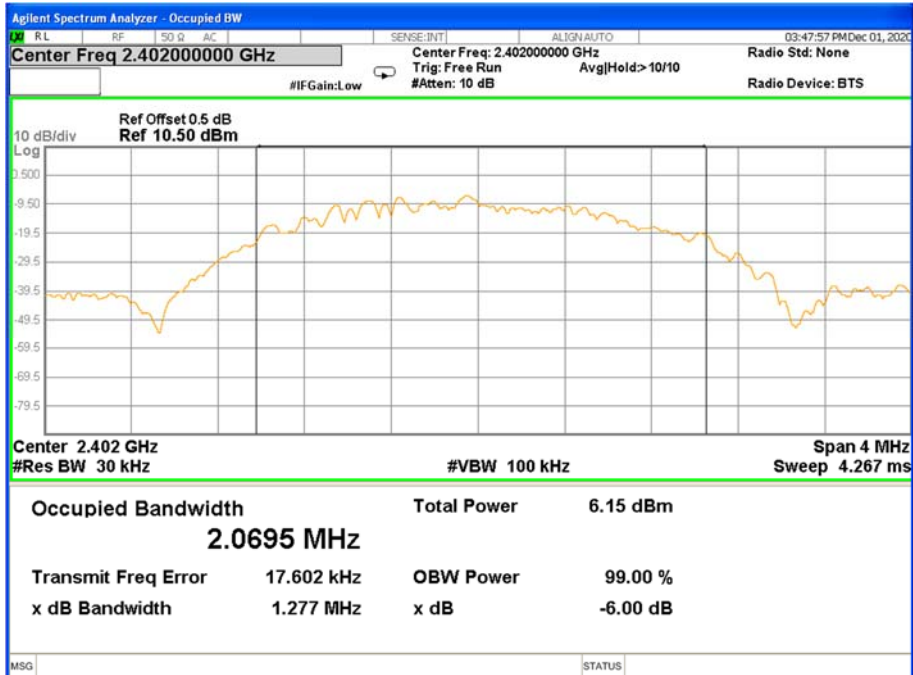

99% Bandwidth TX CH 19

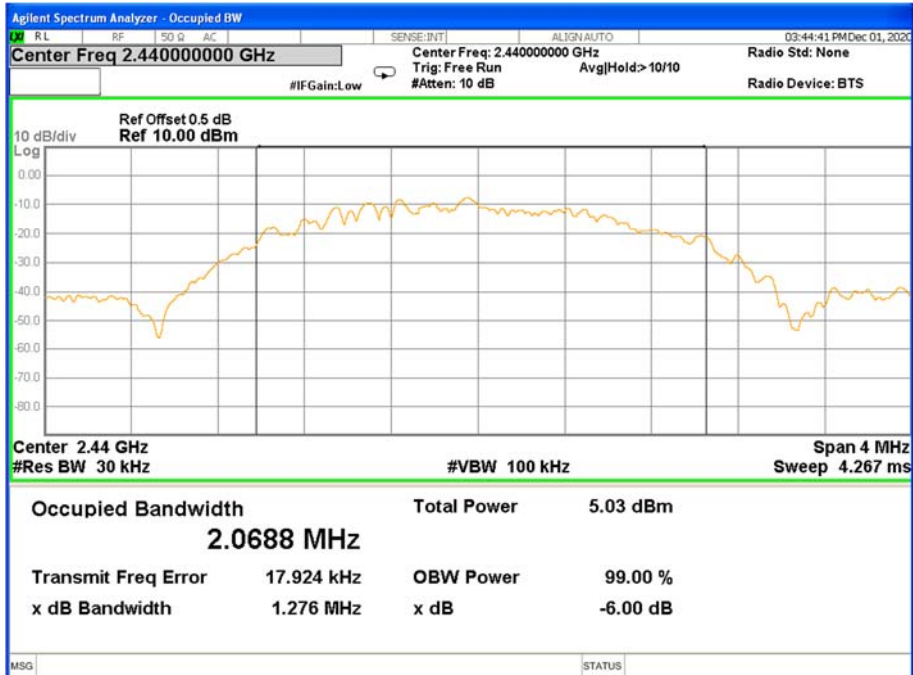



99% Bandwidth TX CH 39

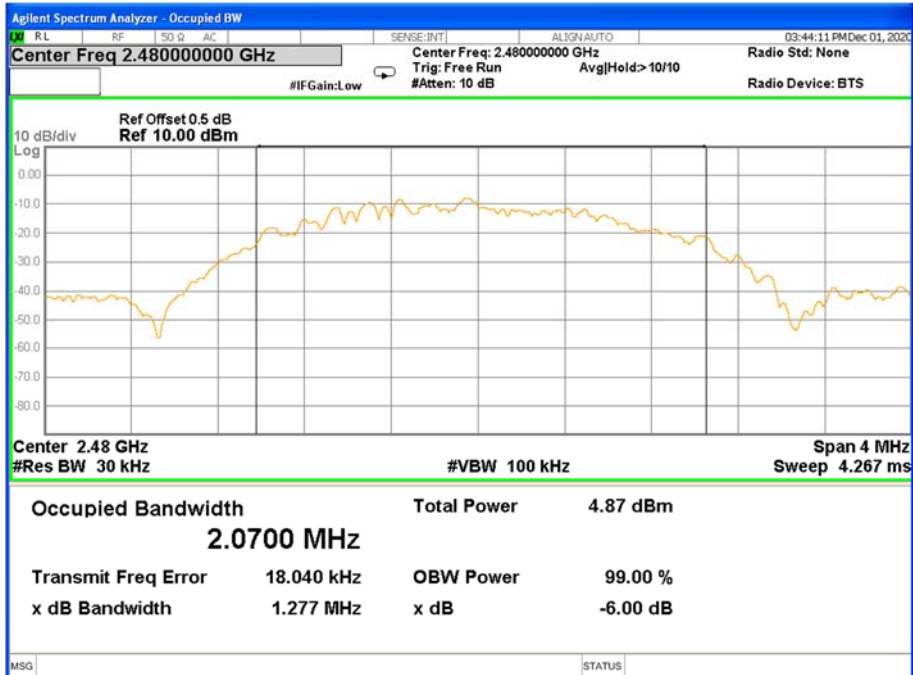



8. PEAK OUTPUT POWER TEST

8.1 LIMIT

FCC Part 15.247, Subpart C RSS-247 Issue 2				
Section	Test Item	Limit	Frequency Range (MHz)	Result
15.247(b)(3) RSS 247 Issue 2	Output Power	1 watt or 30dBm	2400-2483.5	PASS
RSS-247	EIRP	4W	2400-2483.5	PASS

8.2 TEST PROCEDURE

One of the following procedures may be used to determine the maximum peak conducted output power of a DTS EUT.

RBW \geq DTS bandwidth

The following procedure shall be used when an instrument with a resolution bandwidth that is greater than the DTS bandwidth is available to perform the measurement:

- Set the RBW \geq DTS bandwidth.
- Set VBW \geq [3 \times RBW].
- Set span \geq [3 \times RBW].
- Sweep time = auto couple.
- Detector = peak.
- Trace mode = max hold.
- Allow trace to fully stabilize.
- Use peak marker function to determine the peak amplitude level.

Integrated band power method:

The following procedure can be used when the maximum available RBW of the instrument is less than the

DTS bandwidth:

- Set the RBW = 1 MHz.
- Set the VBW \geq [3 \times RBW].
- Set the span \geq [1.5 \times DTS bandwidth].
- Detector = peak.
- Sweep time = auto couple.
- Trace mode = max hold.
- Allow trace to fully stabilize.
- Use the instrument's band/channel power measurement function with the band limits set equal to the DTS bandwidth edges (for some instruments, this may require a manual override to select the peak detector). If the instrument does not have a band power function, then sum the spectrum levels (in linear power units) at intervals equal to the RBW extending across the DTS channel bandwidth.

PKPM1 Peak power meter method:

The maximum peak conducted output power may be measured using a broadband peak RF power meter. The power meter shall have a video bandwidth that is greater than or equal to the DTS bandwidth and shall use a fast-responding diode detector.

8.3 TEST SETUP

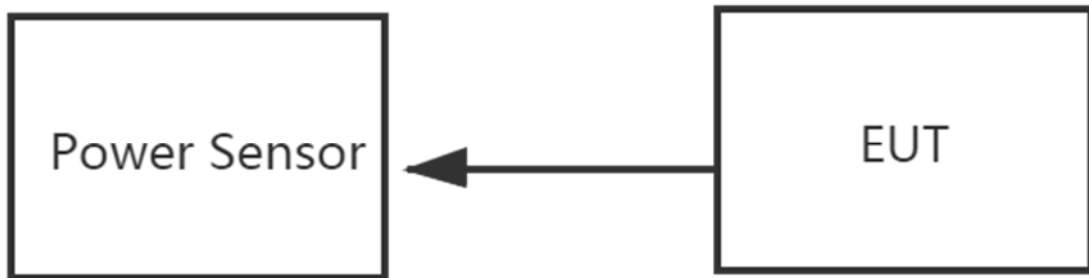

8.4 EUT OPERATION CONDITIONS

The EUT tested system was configured as the statements of 2.3 Unless otherwise a special operating condition is specified in the follows during the testing.





8.5 TEST RESULTS

Temperature:	25 °C	Relative Humidity:	60%
Test Voltage:	DC 3.7V	Test Mode:	TX Mode /CH00, CH19, CH39

1M PHY

Test Channe	Frequency	Peak Conducted Output Power	Average Conducted Output Power	LIMIT
	(MHz)	(dBm)	(dBm)	dBm
CH0	2402	0.73	-1.62	30
CH19	2440	0.67	-1.68	30
CH39	2480	0.27	-2.09	30

2M PHY

Test Channe	Frequency	Peak Conducted Output Power	Average Conducted Output Power	LIMIT
	(MHz)	(dBm)	(dBm)	dBm
CH0	2402	0.73	-1.62	30
CH19	2440	0.67	-1.68	30
CH39	2480	0.27	-2.09	30

Note: Our power sensor test AVG power has no duty cycle display. The power sensor measures AVG power is Burst power. The software has considered the factor of the duty cycle factor, so it is unnecessary to add it again.

EIRP
1M PHY

Test Channe	Frequency	Peak Conducted Output Power	Antenna Gain	EIRP Power	LIMIT
	(MHz)	(dBm)	(dBi)	(dBm)	dBm
CH0	2402	0.73	-1.00	-0.27	36.02
CH19	2440	0.67	-1.00	-0.33	36.02
CH39	2480	0.27	-1.00	-0.73	36.02

2M PHY

Test Channe	Frequency	Peak Conducted Output Power	Antenna Gain	EIRP Power	LIMIT
	(MHz)	(dBm)	(dBi)	(dBm)	dBm
CH0	2402	0.73	-1.00	-0.27	36.02
CH19	2440	0.67	-1.00	-0.33	36.02
CH39	2480	0.27	-1.00	-0.73	36.02



Duty cycle
1M PHY



Ton	Tp	Duty cycle(%)	Duty factor(dB)
0.414	0.628	65.92%	1.81

2M PHY



Ton	Tp	Duty cycle(%)	Duty factor(dB)
0.226	0.626	36.10%	4.42



9. ANTENNA REQUIREMENT

9.1 STANDARD REQUIREMENT

15.203&RSS Gen Issue 5 requirement: For intentional device, according to 15.203&RSS Gen Issue 5: an intentional radiator shall be designed to ensure that no antenna other than that furnished by the responsible party shall be used with the device.

9.2 EUT ANTENNA

The EUT antenna is PCB Antenna. It comply with the standard requirement.





10. FREQUENCY STABILITY

10.1 LIMITS OF FREQUENCY STABILITY MEASUREMENT

The frequency tolerance of the carrier signal shall be maintained within +/-0.02% of the operating frequency over a temperature variation of -30 degrees to 50 degrees C at normal supply voltage, and for a variation in primary supply voltage from 85% to 115% of the rated supply voltage at a temperature of 20 degrees.

10.2 TEST PROCEDURE

1. The EUT was placed inside the environmental test chamber and powered by nominal DC voltage.
2. Turn the EUT on and couple its output to spectrum analyzer.
3. Turn the EUT off and set the chamber to the highest temperature specified.
4. Allow sufficient time (approximately 30 min) for the temperature of the chamber to stabilize, turn the EUT on and measure the operating frequency after 2,5, and 10 minutes.
5. Repeat step 2 and 3 with the temperature chamber set to the lowest temperature.
6. The test chamber was allowed to stabilize at +20 degree C for a minimum of 30 minutes. The supply voltage was then adjusted on the EUT from 85% to 115% and the frequency record.

10.3 TEST RESULT

1M PHY

Channel 19 (2440MHz)

Voltage vs. Frequency Stability

Voltage(V)	Measurement Frequency(MHz)
4.255	2440.0022
3.7	2440.0019
3.145	2440.0013
Max.Deviation(MHz)	0.0022
Max.Deviation(ppm)	0.90

Rated working voltage: DC 3.7V

Temperature vs. Frequency Stability

Temperature(°C)	Measurement Frequency(MHz)
-30	2440.0025
-20	2440.0024
-10	2440.0022
0	2440.0020
10	2440.0016
20	2440.0024
30	2440.0025
40	2440.0025
50	2440.0016
Max.Deviation(MHz)	0.0025
Max.Deviation(ppm)	1.02



2M PHY

Channel 39 (2441MHz)

Voltage vs. Frequency Stability

Voltage(V)	Measurement Frequency(MHz)
4.255	2440.0022
3.7	2440.0019
3.145	2440.0013
Max.Deviation(MHz)	0.0022
Max.Deviation(ppm)	0.90

Rated working voltage: DC 3.7V

Temperature vs. Frequency Stability

Temperature(°C)	Measurement Frequency(MHz)
-30	2440.0025
-20	2440.0024
-10	2440.0022
0	2440.0020
10	2440.0016
20	2440.0024
30	2440.0025
40	2440.0025
50	2440.0016
Max.Deviation(MHz)	0.0025
Max.Deviation(ppm)	1.02

