

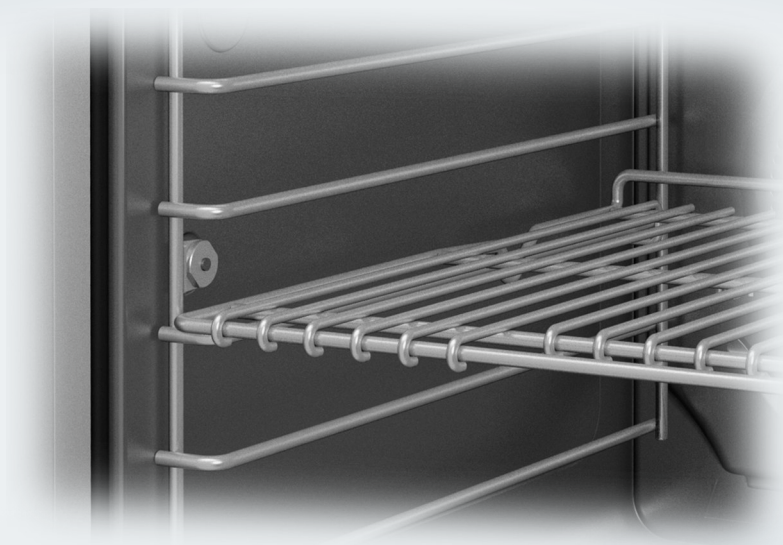

Operating and Installation Instructions



Oven





To prevent accidents and machine damage, read these instructions **before** installation or use.

Contents

IMPORTANT SAFETY INSTRUCTIONS	7
Guide to the oven	16
Control panel	17
Sensor buttons.....	18
Touch display.....	19
Symbols.....	20
Basic operation.....	21
Features	23
Model numbers	23
Data plate	23
Items included.....	23
Standard and optional accessories.....	23
Shelf runners.....	24
Universal tray and Wire oven rack.....	24
FlexiClips with wire rack	25
Rotisserie	28
Oven controls	29
Safety features.....	29
System lock 	29
Safety cut-out.....	29
Cooling fan.....	29
Vented oven door.....	29
Safety Door Lock for Self Clean.....	29
PerfectClean treated surfaces	30
Self Clean ready accessories.....	30
Before using for the first time	31
General settings.....	31
Heating up the oven for the first time and rinsing the steam injection system.....	33
Settings	35
Accessing the "Settings" menu.....	35
Changing and saving settings.....	35
Settings overview.....	36
Language 	38
Time of day.....	38
Display.....	38
Clock Type.....	38
Clock Format.....	38
Set.....	38
Synchronize.....	38

Date.....	39
Lighting.....	39
Start screen.....	39
Brightness.....	39
Volume.....	40
Buzzer tones.....	40
Keypad tone.....	40
Welcome melody.....	40
Units of measurement.....	40
Weight.....	40
Temperature.....	40
Cooling fan.....	41
Default temperatures.....	41
Self Clean.....	42
Safety.....	42
System lock 	42
Sensor lock	43
Catalyzer.....	43
Calibrate temperature.....	44
Electrical Version.....	44
Sensor group.....	44
Showroom Program.....	45
Demo Mode.....	45
Factory default.....	45
MyMiele	46
To add an entry.....	46
Editing MyMiele.....	47
Deleting entries.....	47
Sorting entries.....	47
Alarm + Timer	48
Using the Alarm 	48
Setting the alarm.....	48
Changing an alarm.....	48
Deleting an alarm.....	48
Using the Timer 	49
Setting the timer.....	49
Resetting the timer.....	50
Canceling the timer.....	50
Guide to the modes	51

Contents

Operation	54
Energy saving tips.....	54
Quick Guide.....	55
Cooling fan	55
Additional functions	56
Changing the temperature.....	56
Rapid PreHeat.....	57
Rapid PreHeat.....	57
Using the Crisp function (Moisture Reduction).....	58
Changing the oven mode.....	58
Setting additional durations.....	59
Turning off automatically.....	60
Turning on and off automatically.....	60
Sequence of a cooking program that turns on and off automatically.....	61
Changing the set time.....	61
Canceling cooking.....	61
Moisture Plus 	62
Cooking with the Moisture Plus  function.....	63
Setting the temperature.....	63
Setting the number of bursts of steam.....	63
When to add the bursts of steam.....	63
Changing the type of heating.....	64
Injecting bursts of steam.....	65
Automatic burst of steam.....	65
1, 2 or 3 Bursts of steam.....	65
Evaporating residual moisture.....	66
Starting residual moisture evaporation immediately.....	67
Skipping residual moisture evaporation.....	67
Gourmet Center	68
MasterChef.....	68
MasterChef Plus.....	68
Using the MasterChef and MasterChef Plus programs.....	68
Notes on using these programs.....	69
Search.....	70
Favorites	71
Creating a Favorite.....	71
Starting a Favorite.....	72
Changing Favorites.....	73
Changing cooking stages.....	73
Changing the name.....	74

Deleting a Favorite.....	74
Bake	75
Roast	77
Wireless Roast Probe.....	78
How it works.....	78
When to use the wireless roast probe.....	79
Important notes regarding the wireless roast probe.....	79
Using the wireless roast probe.....	81
Time left display.....	82
Using residual heat.....	83
Slow Roasting	84
Using the Slow Roasting function.....	85
Adjusting the Slow Roasting temperature.....	86
Broil	87
Special Modes	91
Defrost.....	92
Dehydrate.....	93
Reheat.....	94
Warm-up Cookware.....	94
Proof.....	95
Pizza.....	95
Sabbath Program.....	96
Gentle Bake.....	97
Canning.....	98
Frozen food.....	99
Cleaning and care	100
Unsuitable cleaning agents.....	100
Tips.....	101
Normal soiling.....	101
Wireless Roast Probe.....	101
Stubborn soiling.....	102
Self Cleaning  the oven interior.....	103
Preparing for the Self Clean program.....	103
Starting the Self Clean program.....	104
Starting the Self Clean program.....	104
Delaying the start of the Self Clean program.....	104
At the end of the Self Clean program.....	105
The Self Clean program is canceled.....	106

Contents

Removing the door.....	107
Installing the door.....	108
Removing the shelf runners.....	109
Frequently asked questions.....	110
Technical Service.....	115
Caring for the environment.....	116
Plumbing.....	117
Notes on connecting to the water supply.....	117
Attaching the stainless steel hose to the oven.....	118
Connecting to the water supply.....	118
Electrical connection.....	119
Installation diagrams.....	120
Appliance and cut-out dimensions.....	120
Undercounter installation.....	120
Installation into a tall cabinet.....	121
Installing the oven.....	122
Copyright and licenses.....	123

IMPORTANT SAFETY INSTRUCTIONS

When using the appliance, follow basic safety precautions, including the following:

Read all instructions before installation and use of the oven to prevent accidents and machine damage.

This appliance complies with current safety requirements. Improper use of the appliance can lead to personal injury and material damage.

Read all instructions before installing or using the oven for the first time. Only use the appliance for its intended purpose.

Keep these operating instructions in a safe place and pass them on to any future user.

Use

- ▶ This appliance is intended for residential use only. Use only as described in these operating instructions.
- ▶ This appliance is not intended for outdoor use.
- ▶ Only use this oven for residential cooking, and the purposes described in this manual. Other uses are not permitted and can be dangerous.
- ▶ **Risk of Fire!** Do not use this oven to store or dry flammable materials.
- ▶ Persons who lack physical, sensory or mental abilities, or experience with the appliance should not use it without supervision or instruction by a responsible person.

IMPORTANT SAFETY INSTRUCTIONS

Children

- ▶ Children should not be left alone or unattended in an area where an oven is in use. Never allow children to operate, sit or stand on any part of the oven. **Caution:** Do not store items of interest to children in cabinets above an oven. Children climbing on the oven to reach these items could be injured.
- ▶ Burn Hazard - Do not allow children to use the oven. Failure to do so can result in severe burns or serious injury.
- ▶ As with any appliance, close supervision is necessary when used by children.
- ▶ Danger of suffocation! Ensure that any plastic wrappings, bags, etc. are disposed of safely and kept out of the reach of children.
- ▶ Danger of burns. The oven gets hot at the oven door glass, the vapor vent, the handle and the operating controls. Do not allow children to touch or play in, on or near the oven.
- ▶ Danger of burns.
Children's skin is more sensitive to high temperatures than that of adults. The oven becomes hotter during self-cleaning than it does in normal use. Do not let children touch the oven while the Self Clean program is running.

Technical safety

- ▶ This appliance must be installed and connected in compliance with the installation instructions.
- ▶ Installation, repair and maintenance work should be performed by a Miele authorized service technician in accordance with national and local safety regulations and the provided installation instructions. Contact Miele's Technical Service Department for examination, repair or adjustment. Repairs and other work by unauthorized persons could be dangerous and may void the warranty.

IMPORTANT SAFETY INSTRUCTIONS

- ▶ Changes or modifications not expressly approved by Miele may void the user's authority to operate the oven.
- ▶ Before installing the oven, check for externally visible damage. Do not operate a damaged appliance.
- ▶ To guarantee the electrical safety of this appliance, continuity must exist between the appliance and an effective grounding system. This appliance must be grounded. Connect only to properly grounded outlet. See "Electrical connection - GROUNDING INSTRUCTIONS". It is imperative that this basic safety requirement be met. If there is any doubt, have the electrical system of the house checked by a qualified electrician.
- ▶ Before installation, make sure that the voltage and frequency listed on the data plate correspond with the household electrical supply. This data must correspond to prevent injury and machine damage. Consult a qualified electrician if in doubt.
- ▶ Before installation or service, disconnect the power supply to the work area by
 - removing the fuse,
 - "tripping" the circuit breaker, or
 - unplugging the unit. Pull the plug not the cord.
- ▶ Extension cords do not guarantee the required safety of the appliance (e.g. danger of overheating). Do not use an extension cord to connect this appliance to electricity.
- ▶ The oven is not to be operated until it has been properly installed within cabinetry.
- ▶ Danger of electric shock!
Under no circumstances open the outer casing of the appliance.
- ▶ This appliance must not be used in a non-stationary location (e.g. on a ship).

IMPORTANT SAFETY INSTRUCTIONS

- ▶ Do not repair or replace any part of the appliance unless specifically recommended in the operating instructions. All other servicing should be referred to a qualified technician.
- ▶ Defective components should be replaced by Miele original spare parts only. Only with these parts can the manufacturer guarantee the safety of the appliance.
- ▶ In order for the oven to function correctly, it requires an adequate supply of cool air. Ensure that the air flow is not impaired (e.g. insulation in the cabinetry). Also be sure that the cool air supply is not heated by other sources nearby.
- ▶ If the oven is installed behind a cabinet door, do not close the door while the oven is in operation. Heat and moisture can build up behind the closed door and cause damage to the oven, cabinetry and flooring. Do not close the door until the oven has completely cooled down.
- ▶ The water intake valve must be installed in an area accessible after installation.
- ▶ The protective sleeve of the water intake hose must not be damaged or become kinked. This will cause it to leak.
- ▶ The integrated Waterproof System offers protection from water damage, provided the following conditions are met:
 - The oven is properly installed (electric and water).
 - A damaged appliance is dangerous. Contact Miele for repair immediately.
 - The water supply has been turned off when the appliance is not going to be used for a longer period of time (e.g. vacation).
- ▶ Hard and mineral rich water can damage the oven. Only use pre-filtered, softened, demineralized water from the fixed water supply.



IMPORTANT SAFETY INSTRUCTIONS

Proper use

 The oven becomes very hot while in use. Use caution to ensure that you are not burned on the heating elements or interior surfaces of the oven. Use pot holders when placing food in the oven, adjusting the racks, etc. in a hot oven.

- ▶ Caution: Heating elements may be hot even though they are not glowing. Interior surfaces of an oven become hot enough to cause burns. External parts of the oven such as the door glass, vents, and the control panel can become hot. During and after use, do not touch, or let clothing or other flammable materials come into contact with heating elements or interior surfaces of the oven until they have had sufficient time to cool.
- ▶ Do not let food sit in the oven more than one hour before or after cooking. Doing so can result in food poisoning or sickness.
- ▶ It is important that the heat is evenly distributed throughout the food being cooked. This can be achieved by stirring and/or turning the food.
- ▶ Use only dry, heat-resistant potholders. Moist or damp potholders used on hot surfaces may result in steam burns. Do not let potholders come in contact with oil or grease. Do not substitute dish towels or other bulky items for potholders. Do not let potholders touch hot heating elements.
- ▶ Loose fitting or hanging garments present a fire hazard. Wear proper apparel while operating the appliance.
- ▶ Do not heat unopened containers of food in the oven, pressure may cause the containers to burst and result in injury.
- ▶ Never pour cold water onto hot surfaces in a hot oven. The steam created could cause serious burns or scalding and the sudden change in temperature can damage the enamel in the oven.

IMPORTANT SAFETY INSTRUCTIONS

- ▶ During cooking processes using moisture and during the residual moisture evaporation process steam is produced which can cause serious injury by scalding. Do not open the door while a burst of steam is being released or during the evaporation process.
- ▶ To prevent burns, always place oven racks at their desired height while the oven is cool. If the rack must be moved while the oven is hot, do not let pot holders touch hot heating elements.
- ▶ Open the door carefully to allow hot air or steam to escape before placing or removing food.
- ▶ To prevent burns, allow the heating elements to cool before cleaning by hand.
- ▶ Do not leave the oven door open unnecessarily as someone may trip over it or be injured by it.
- ▶ Never leave the appliance unattended when cooking with oil or fat. They can ignite if overheated. Do not use water on grease fires. Turn off the oven immediately and suffocate the flames by keeping the oven door closed.
- ▶ Never store flammable liquids and materials in, above or under an oven, or near cooking surfaces.
- ▶ Do not use the oven to heat the room. The high temperatures radiated could cause objects near the oven to catch fire.
- ▶ Broiling food for an excessively long time can cause it to dry out with the risk of catching fire.
Do not exceed recommended broiling times.
- ▶ Some foods dry out very quickly and can be ignited by high broiling temperatures. Do not use broiling modes for crisping rolls or bread, or to dry flowers or herbs. Instead use the Convection Bake  or Surround  modes.

IMPORTANT SAFETY INSTRUCTIONS

- ▶ Use caution when using alcohol in your recipes. Alcohol evaporates at high temperatures but may, in rare circumstances, combust on the hot heating elements.
- ▶ Plastic containers, which are not heat-resistant, melt and may ignite at high temperatures and can damage the oven. Use only plastic containers that are indicated by the manufacturer as being suitable for use in ovens.
- ▶ When residual heat is used to keep food warm, the high level of humidity and condensation can cause damage in the oven. The control panel, countertop or cabinetry may also be damaged. Do not switch the oven off completely while food is inside it, but select the lowest possible temperature for the oven mode you are using. This will ensure the fan will automatically continue to run.
- ▶ It is recommended to cover all cooked food that is left in the oven to be kept warm. This will prevent moisture from condensing on the interior of the oven.
- ▶ To avoid damage, do not place aluminum foil, pots, pans or baking sheets directly on the oven floor. This can cause a build up of heat that will damage the oven floor.
- ▶ Do not slide pots or pans on the oven floor. This could scratch and damage the surface.
- ▶ The door can support a maximum weight of 15 kg. Do not sit on or lean against an open door, and do not place heavy objects on it. Also make sure that nothing can get trapped between the door and the oven cavity. The oven could get damaged.
- ▶ This oven must only be used for cooking food. Fumes, vapors or heat given off by glues, plastics or flammable liquids and materials could be hazardous. Do not use it as a dryer, kiln, dehumidifier, etc.
- ▶ Do not cover or block any vent openings.
- ▶ Do not let metal objects (aluminum foil, pans) come in contact with the heating element.

IMPORTANT SAFETY INSTRUCTIONS

- ▶ Make certain that the power cords of small appliances do not come in contact with or get caught in the oven door.
- ▶ When baking frozen pizzas or pies, place them on the wire rack lined with parchment paper. Do not use the baking tray or the roasting pan for frozen foods with a large surface area. The tray or pan could become warped and difficult to remove from the oven when hot. Frozen foods like french fries, chicken nuggets, etc. can be baked on the baking tray.

Cleaning and care

- ▶ Do not use a steam cleaner to clean this oven. Steam could penetrate electrical components and cause a short circuit.
- ▶ Only clean parts listed in these Operating and Installation Instructions.
- ▶ Scratches on the door glass can cause the glass to break. Do not use abrasive cleaners, hard sponges, brushes or sharp metal tools to clean the door glass.
- ▶ The shelf runners can be removed for cleaning purposes (see "Cleaning and care"). Ensure they are correctly fitted after cleaning and never operate the oven without the shelf runners inserted.
- ▶ There is a seal around the oven interior which seals the inside of the door. Take care not to rub, damage or move the gasket.
- ▶ Do not use oven cleaners. Commercial oven cleaners or oven liners of any kind should not be used in or around any part of the oven.
- ▶ Debris should be removed before running the Self Clean program. If not removed this debris can smoke causing the self-cleaning program to turn itself off.

IMPORTANT SAFETY INSTRUCTIONS

Accessories

- ▶ Use only genuine original Miele spare parts. If spare parts or accessories from other manufacturers are used, the warranty may become void.
- ▶ Only use the Miele roast probe supplied with this oven. If it is faulty, it must only be replaced with a Miele genuine roast probe.
- ▶ Very high temperatures can damage the wireless roast probe and cause the silicon to melt. Do not keep the roast probe in the oven. Do not use the roast probe in Broil modes (except for Convection Broil).
- ▶ This oven complies with Industry Canada licence-exempt RSS standard(s) and part 15 of the FCC Rules. Operation is subject to the following two conditions: (1) This device may not cause harmful interference, and (2) this device must accept any interference received, including interference that may cause undesired operation.
- ▶ The high temperatures used during self-cleaning will damage accessories that are not designed for cleaning in the Self Clean program. Please remove these accessories from the oven before starting the Self Clean program. This also applies to accessories purchased separately (see "Cleaning and care").

Preparing your appliance for an extended vacation

- ▶ If you elect to turn off the water to your home for an extended period of time, please note that this may not be enough to reduce the risk of a leak. To be completely safe, you must turn off the water supply to each individual appliance. This means under the sink for a dishwasher, at the laundry bib for your washer, etc.

SAVE THESE INSTRUCTIONS AND REVIEW THEM PERIODICALLY

Guide to the oven

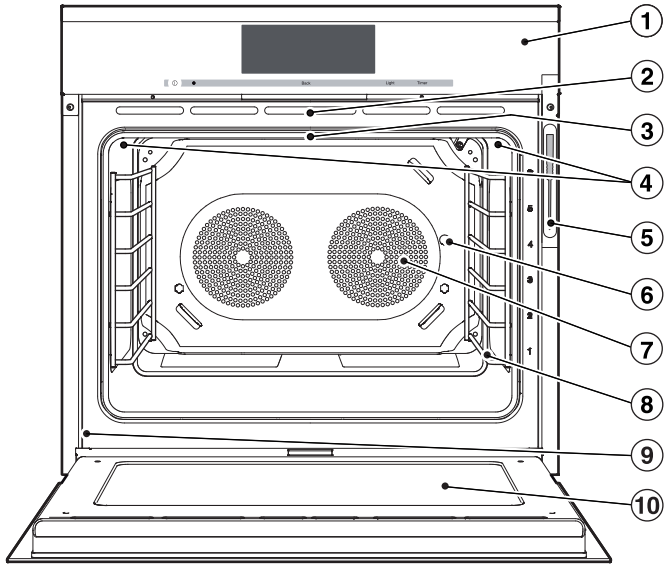

- ① Control panel
- ② Door with contact switch* and lock for Self Clean program
- ③ Browning / Broiling element
- ④ Oven interior lighting
- ⑤ Wireless roast probe
- ⑥ Rotisserie motor
- ⑦ Twin power connection fans with heating element
- ⑧ Runners with 6 shelf levels
- ⑨ Data plate
- ⑩ Clean Glass door

* This switch ensures that the heating elements and the convection fans turn off when the door is opened during use.

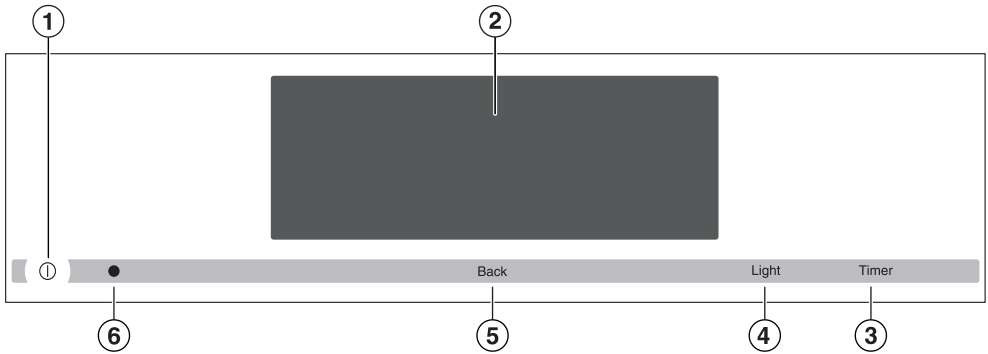

- ① On / Off ① button
Turns the oven on or off
- ② Display
Displays the time of day and information on the operation
- ③ "Timer" sensor button
To set the timer
- ④ "Light" sensor button
For turning the oven interior lighting on and off
- ⑤ "Back" sensor button
To go back one step at a time
- ⑥ Optical interface
(for service technician use only)

Control panel

Sensor buttons

The sensors react to touch. Each touch is confirmed with an audible tone. This tone can be turned off (see "Settings – Volume - Keypad tone").

Sensor button	Function	Notes
Timer	For activating and deactivating timer / alarm	<p>If a list of options is shown in the display, or if a cooking process is running, you can enter a timer duration (e.g. when boiling eggs on the cooktop) or an alarm time, i.e. a specific time, at any point (see "Alarm + Timer").</p> <p>If the time of day display is turned off, the "Timer" sensor will not react until the oven is turned on.</p>
Light	For turning the oven interior lighting on and off	<p>If a menu appears in the display or if a cooking process is running, touching "Light" will turn the interior light on or off.</p> <p>If the time of day display is turned off, the "Light" sensor will not react until the oven is turned on.</p> <p>The oven interior lighting turns off after 15 seconds during a cooking process or remains constantly turned on, depending on the setting selected.</p>
Back	To go back a step	

Touch display

The touch screen can be scratched by hard objects, e.g. pens and pencils. Only touch the screen with your fingers.

Touching the display with your finger emits a small electrical charge which in turn triggers an electrical pulse that is detected by the surface of the Touch display.

The Touch display is organized into three areas:

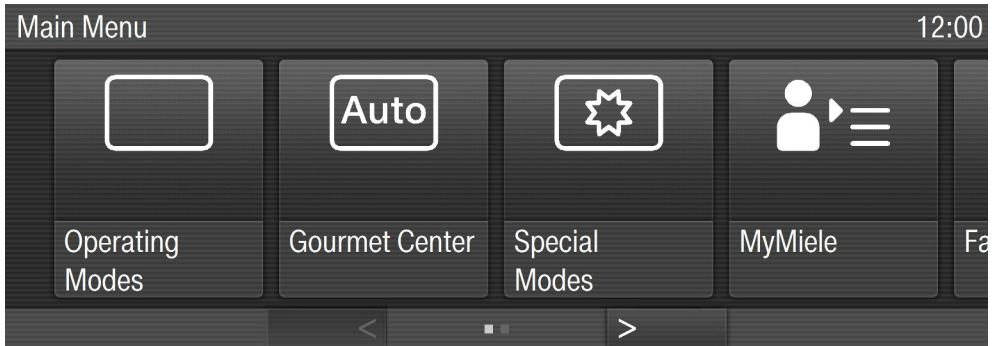

The top line shows what menu level you are currently in. To get to a submenu, tap on the appropriate menu name or "... " in the main menu. The time of day appears on the right.







The middle row shows the current menu and options. You can scroll to the right or left by swiping your finger across the display to the right or left. An item can be selected by tapping it.

In the bottom line you can scroll with the arrows from left to right.

Control panel

Symbols

The following symbols may appear in the display:

Symbol	Description
	Some settings, e.g. display brightness and buzzer volume, are selected using a bar chart.
	This symbol indicates that there is additional information and advice about using the oven. Select OK to access the information.
	The system lock or sensor lock is active (see "Settings - System Lock  "). The oven cannot be operated.
	Alarm
	Timer
	Core temperature when using the roast probe

Basic operation

Each time you touch a possible option the relevant field will light up orange.

To select or open a menu

- Touch the desired field to select it.

Scrolling

You can scroll left or right.

- Swipe the screen, i.e. place your finger on the Touch display and move it in the desired direction.
- Or: Using your finger you can tap the arrows < and > to scroll left or right.

Exiting a menu

- Select "Back".

Entering numbers

You can enter numbers by scrolling through and touching the roller, or by using the numerical keypad.

To enter numbers using the roller:

- Swipe the roller up or down to select the desired number.

Control panel

To enter numbers using the numerical keypad:



- Touch  in the bottom right of the input field.

The numerical keypad appears.

- Touch the required numbers.

Once you have entered a valid value, the OK sensor will light up green. The last figure entered can be deleted by using the arrow.

- Touch "OK".

Entering letters

Enter a name using a keyboard. Try to use short, concise names.

- Select the required letters or characters.
- Touch Save.

Model numbers

A list of the ovens described in these operating instructions can be found on the back page.

Data plate

The data plate located on the front frame of the oven is visible when the door is open.

Printed on the data plate are the model number, serial number and the connection data (voltage/frequency/maximum rated load) of the oven.

Have this information available when contacting Miele Technical Service.

Items included

The oven is supplied with:

- the operating and installation instructions,
- screws for securing your oven in the cabinetry, and
- various accessories.

Standard and optional accessories

Accessories vary depending on model. **All ovens are supplied with shelf runners, universal tray and wire oven rack.** Depending on the model, Miele ovens may be supplied with the accessories listed.

All accessories and cleaning and care products in these instructions are designed to be used with Miele ovens.

They can be ordered from the Mieleusa.com website or Miele.

When ordering, please have ready the model number of your oven and of the desired accessories.

Features

Shelf runners

The shelf runners are located on the right and left-hand sides of the oven with the levels for inserting accessories.

The shelf level numbers are indicated on the front of the oven frame.

Each level consists of a strut on which you can place the wire oven rack, for example.

The runners can be removed for cleanings purposes. See "Cleaning and Care".

Universal tray and Wire oven rack

Universal tray HUBB30-1

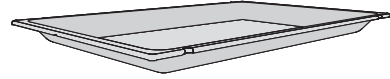

Wire oven rack HBBR30-2

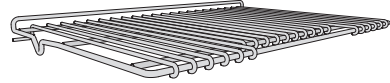

Non-tip safety notches are located on the shorter sides of these accessories. These prevent the trays being pulled completely out of the side runners when you only wish to pull them out partially.

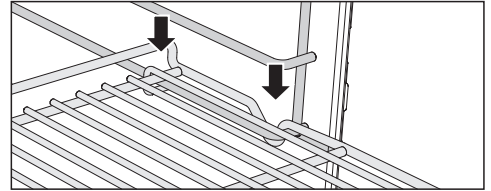

Always place the wire oven rack on the runner with the notch facing down.

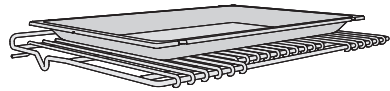

When using the universal tray, place it directly on the wire oven rack.

FlexiClips with wire rack HFCBBR30-2

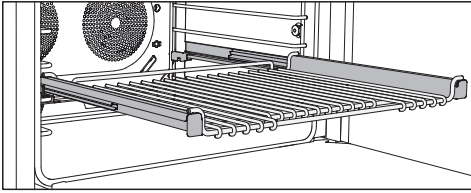

The FlexiClips with wire rack can be mounted on any shelf level and pulled completely out of the oven. This allows you to see the food easily.

The FlexiClips with wire rack is pushed in and then locked onto a level.

The rack can hold a maximum of 33 lbs (15 kg).

Installing and removing the FlexiClips with wire rack

⚠ Danger of burns! Make sure the heating elements are turned off and that the oven cavity is cool.

Do not pull the FlexiClips apart during installation or removal.

- Hold the FlexiClips with wire rack with both hands and position it in front of the desired level.

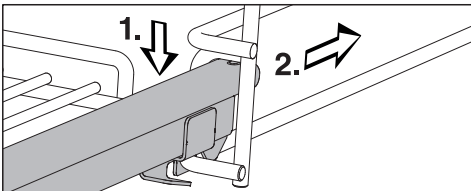

- Insert the FlexiClips with wire rack onto the level (1.) and slide it along the struts of the level (2.) until it clicks into place.

If the FlexiClips with wire rack jams when sliding it onto the level, pull it out using some force and reinsert.

To removing the FlexiClips with wire rack:

- Push the FlexiClips with wire rack in all the way.

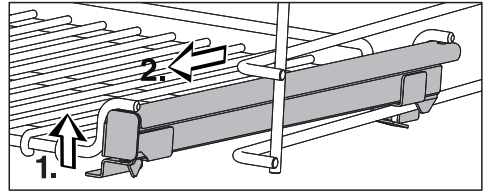

- Using both hands lift the front of the FlexiClips with wire rack on both sides (1.) and pull it out of the level (2.).

Using the universal tray

- When using the universal tray, place it directly on the FlexiClips with wire rack.

Features

Perforated baking tray HBBL71

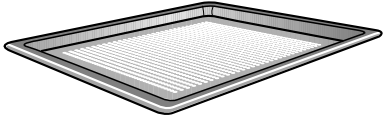

The perforated baking tray has been specially developed for the preparation of baked goods.

The tiny perforations assist in browning the underside of baked goods.

The tray can also be used for dehydrating or drying food.

The surface has been treated with PerfectClean enamel for easy cleaning.

The perforated baking tray can be placed on the rack.

Grilling and Roasting insert HGBB30-1

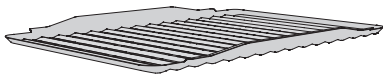

The grilling and roasting insert is placed in the universal tray.

The drippings from the meat or poultry are collected under the insert reducing spattering in the oven. The drippings can then be used for gravy and sauces.

The surface has been treated with PerfectClean enamel for easy cleaning.

Round baking form HBF27-1



This circular form is suitable for cooking fresh or frozen pizzas, flat cakes, tarts and baked goods.

The surface has been treated with PerfectClean enamel.

Gourmet Baking Stone HBS60

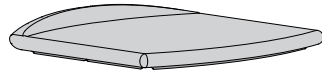

The baking stone is ideal for baking dishes with a crisp bottom such as pizza and bread.

The baking stone is made from a heat retaining stone and is glazed. Place the stone directly on the wire rack.

A wooden paddle is supplied with it for placing food on and off the stone.

Gourmet Casserole Dishes HUB and Lids HBD

Miele Gourmet Casserole Dishes can be placed directly on the wire oven rack. They have an anti-stick coating.

The oven dishes have depths of 8 1/2" (22 cm) or 13 3/4" (35 cm). They have the same width and height.

Matching lids are also available separately.

Depth: 8 1/2"
(22 cm)

HUB61-22

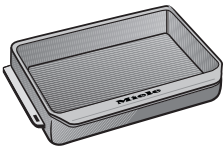

HBD60-22

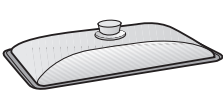

Depth: 13 3/4"
(35 cm)

HUB61-35

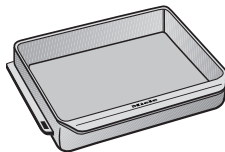

HBD60-35

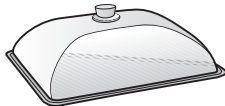

Wireless Roast Probe

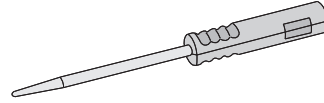

The oven is equipped with a wireless roast probe that enables you to monitor the temperature of the cooking process simply and accurately (see "Roasting - Wireless roast probe"). The roast probe is kept in the front frame of the oven.

Features

Rotisserie HDGR30+

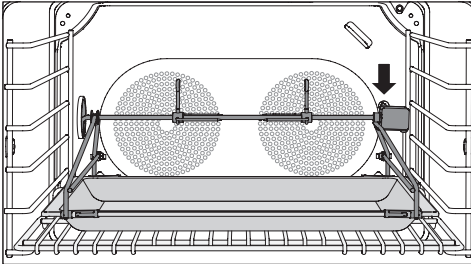

The rotisserie is ideal for broiled foods such as meat, poultry or kebabs. The food browns evenly on all sides as it rotates (see "Broil - Using the rotisserie to Broil").

The rotisserie is placed on the universal tray and connected to the motors in the back wall of the oven.

The rotisserie can support a maximum weight of 11 lbs (5 kg).

Opener

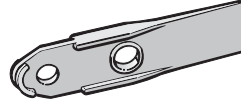

The opener allows you to open the cover of the over light.

Miele Oven Cleaner

Miele oven cleaner is suitable for removing stubborn soiling. It is not necessary to preheat the oven before use.

Oven controls

The oven controls allow you to use the various cooking modes to bake, roast and broil.

It also allows you to access:

- the time of day display,
- a timer,
- a timer to automatically turn cooking programs on and off,
- Moisture Plus cooking,
- the MasterChef programs,
- the MasterChef Plus programs,
- the creating of a Favorite program,
- settings that can be customized.

Safety features

System lock

The system lock prevents the oven from being used unintentionally (see "Settings - System lock").

The system lock will remain activated even after a power failure.

Safety cut-out

The oven automatically turns itself off automatically if it is used for an exceedingly long period. The length of time depends on the oven mode being used.

Cooling fan

The cooling fan comes on automatically when a cooking program is started. The cooling fan mixes hot air from the oven cavity with cool room air before venting it out into the kitchen through vents located between the appliance door and the control panel.

The cooling fan will continue to run for a while after a program is complete to prevent moisture from building up in the oven, on the control panel or surrounding cabinetry.

When the temperature in the oven has fallen sufficiently, the cooling fan will turn off automatically.

Vented oven door

The oven door glass has a heat-reflective coating.

When the oven is operating, air is circulated through the door to keep the outer pane cool.

The door can be removed and disassembled for cleaning purposes, see "Cleaning and care".

Safety Door Lock for Self Clean

For safety, the door is locked as soon as the Self-Clean program is started. After the program has finished, the door will remain locked until the temperature in the oven has fallen below 535°F (280°C).

Features

PerfectClean treated surfaces

The revolutionary PerfectClean enamel is a smooth, non-stick surface that cleans easily with a sponge.

Food and soiling from baking and roasting can be easily removed from these surfaces.

Do not use ceramic knives as these will scratch the PerfectClean surface.

Follow the instructions in the "Cleaning and Care" section of this manual so the anti-stick and easy cleaning properties are retained.

The following have all been treated with PerfectClean:

- Universal tray
- Grilling and Roasting insert
- Perforated baking tray
- Round baking form

Self Clean ready accessories

The following accessories can be left in the oven during the Self Clean program.

- Shelf runners,
- FlexiClips with wire rack
- Wire oven rack

See "Cleaning and care" for more information.

Before using for the first time

General settings

 The oven must not be operated until it has been properly installed within cabinetry.

The oven will turn on automatically when it is connected to the power supply.

Welcome screen

A welcome greeting is displayed. You will then be asked to select some basic settings which are needed before the appliance can be used.

- Follow the instructions on the display.

Setting the language

- Select the desired language.
- Confirm with OK.

Setting the country

- Select the desired country.
- Confirm with OK.

Setting the voltage (electrical version)

 The voltage set must match that of the house as to not damage the oven.

Confirm the voltage before setting. In doubt contact a qualified technician.

- Select the voltage.
- Confirm with OK.

Setting the date

You can enter numbers by scrolling through and touching the roller, or by using the numerical keypad.

- Set the day, month and year.
- Confirm with OK.

Before using for the first time

Set the time of day

You can enter numbers by scrolling through and touching the roller, or by using the numerical keypad.

- Set the time of day in hours and minutes.
- Confirm with OK.

The time of day can be displayed in 12 hour format (see "Settings - Time of day - Clock format").

Time of day display

You will then be asked when you want the time of day to show in the display when the oven is turned off (see "Settings - Time of day - Display"):

- On

The time is always visible in the display.

- Off

The display appears dark to save energy. Some modes are limited.

- Night Dimming

The time only shows in the display between 5:00 am and 11:00 pm. It turns off at night to save energy.

- Select the desired option.
- Confirm with OK.

Information regarding energy consumption will appear in the display.

- Confirm with OK.
- Follow further instructions in the display.

Set-up Successfully Completed is displayed.

- Confirm with OK.

The oven is now ready to use.

If you accidentally select the wrong language, follow the instructions described in "Settings - Language ".

Before using for the first time

Heating up the oven for the first time and rinsing the steam injection system

New ovens can give off an unpleasant odor on first use. Heating up the oven for at least 1 hour with nothing in it will get rid of this smell. It is a good idea to rinse the steam injection system at the same time.

Ensure that the kitchen is well ventilated while the appliance is being heated up for the first time. Close doors to other rooms to prevent the smell spreading throughout the house.

- Remove any protective wrapping and sticky labels from the oven.
- Before heating the oven up, wipe the interior with a damp cloth to remove any dust or bits of packaging that may have accumulated in the oven cavity during storage and unpacking.
- Insert the FlexiClip telescopic runners (available to order) to the shelf runners and insert all trays and the rack.
- Turn on the oven.

The main menu will appear.

- Select Operating Modes.
- Select Moisture Plus .

The default temperature is displayed (320°F/160°C).

The oven heating, lighting and cooling fan will turn on.

- Set the maximum temperature (485°F/250°C).

- Confirm with OK.
- Select Automatic burst of steam.

After a short time, a burst of steam is injected automatically.

 Risk of injury!
Steam can cause scalding.
Do not open the door during a steam burst.

Heat up the oven for at least one hour.

After at least an hour:

- Turn the oven off.

Before using for the first time

After heating up for the first time

 Danger of burns! Allow the oven to cool before cleaning.

- Turn on the oven.
- Select Light to turn on the oven light.
- Take all accessories out of the oven and clean them by hand (see "Cleaning and care").
- Clean the oven interior with warm water and liquid dish soap, applied with a soft sponge or cloth.
- Dry all surfaces with a soft cloth.
- Turn the lighting and the oven off.

Leave the oven door open until the oven interior is completely dry.

Accessing the "Settings" menu

From the main menu:

- Select  Settings.

They can be checked and changed, if needed.

Settings cannot be altered while a cooking program is in progress.

Changing and saving settings

- Select  Settings.
- Swipe across the screen until the desired setting appears, then touch it to select.



The settings which are currently selected will have a colored frame around them.

- Swipe across the screen until the desired option appears, then touch it to select it.
- Confirm with OK.

The setting is now saved.

Settings

Settings overview

Option	Available settings
Language 	... / deutsch / english / ... Country
Time	Display On / Off * / Night Dimming Clock Type Analog * / Digital Clock Format 24 h / 12 h (am/pm) * Set
Date	
Lighting	On / On for 15 seconds *
Start Screen	Main Menu Operating Modes Gourmet Center Special Modes MyMiele Favorites
Brightness	
Volume	Buzzer tones Keypad tone Welcome Melody
Units of Measurement	Weight g / lb/oz * Temperature °C / °F *
Cooling Fan	Temperature Controlled * Time Controlled

* Factory default

Option	Available settings
Self Clean	With reminder Without reminder *
Default temperatures	
Safety	System Lock On / Off * Sensor Lock On / Off *
Catalyzer	■■■■■□□□
Calibrate Temperature	■■■■■□□□
Electrical Version	208V / 60Hz 220V / 60Hz 230V / 50Hz 240V / 60Hz
Sensor group	1-9
Showroom Program	Demo Mode On / Off *
Factory default	Settings Favorites Default Temperatures MyMiele

* Factory default

Settings

Language

The desired country and language can be set.

After selecting and confirming your choice, the language selected will appear in the display.

Tip: If you accidentally select a language you do not understand, select the  symbol to return to the submenu.

Time of day

Display

Select how you would like the time of day to appear in the display when the oven is turned off:

- On

The time of day will always appears in the display. To turn the "Light" on and off or use the "Timer" touch the relevant sensor.

- Off

The display is turned off to save energy. The oven has to be turned on before you can use it. This also applies when using the Alarm + Timer and the oven light.

- Night Dimming

To save energy, the time is only visible in the display between 5:00 am and 11:00 pm. The rest of the time it is not visible.

Clock Type

You can choose from an analogue clock face or a digital (h:min) display.

The date will also appear in the digital clock display.

Clock Format

You can select the clock format for the time of day:

- 24 h

The time of day is shown in a 24 hour clock format.

- 12 h (am/pm)

The time of day is shown in a 12 hour clock format.

Set

Set the hours and the minutes.

If there is a power failure, the current time of day will reappear once the power has been restored. The time is stored in memory for about 200 hours.

Synchronize

This menu item only appears if you are connected to the Miele@Home system (see separate instructions).

Date

Set the date.

When the oven is turned off, the date only appears if the oven is set to "Time – Clock Type – Digital".

Lighting

- On

The interior lighting is turned on during the entire cooking period.

- On for 15 seconds

The oven lighting turns off 15 seconds after a program starts. Touching "Light" turns it on for another 15 seconds.

Start screen

The main menu will appear in the display when the oven is turned on. You can change this default setting so that, for instance, the oven modes or MyMiele settings appear in the display.

Brightness

The display brightness is represented by a bar with seven segments.



- Select **Darker** or **Lighter**, to change the brightness of the display.

Settings

Volume

Buzzer tones

The volume is represented by a bar with seven segments.



Maximum volume is selected when all segments are filled. If none of the segments are filled, the volume is turned off.

- Select **Quieter** or **Louder**, to adjust the volume.
- Select **On** or **Off** to turn the buzzer tones on or off.

Keypad tone

The volume is represented by a bar with seven segments.



Maximum volume is selected when all segments are filled. If none of the segments are filled, the volume is turned off.

- Select **Quieter** or **Louder**, to adjust the volume.
- Select **On** or **Off**, to turn the keypad tone on or off.

Welcome melody

You can turn the welcome melody on or off. It sounds when the **On / Off** button  is touched.

Units of measurement

Weight

– g

The weight of food in MasterChef programs is shown in grams.

– lb/oz

The weight of food in MasterChef programs is shown in pounds and ounces.

Temperature

– °C

The temperature is displayed in Celsius.

– °F

The temperature is displayed in Fahrenheit.

Cooling fan

The cooling fan will continue to run for some time after the oven has been turned off to prevent humidity from building up in the oven, on the control panel or in the surrounding cabinetry.

- Temperature Controlled

The cooling fan turns off when the temperature in the oven drops below 160°F (70°C).

- Time Controlled

The cooling fan will turn off after approx. 25 minutes.

Condensation can cause the cabinetry and the countertop to be damaged. This could lead to corrosion of the appliance.

When keeping food warm in the oven, increases to the Time Controlled setting can lead to condensation of the control panel, moisture on the countertop and on the cabinetry.

Do not adjust the Time Controlled setting and try not to leave food in the warm oven.

Default temperatures

If you often cook with temperatures that differ from the default, it makes sense to change the default temperatures.

After selecting this option, a list of oven modes will appear in the display.

- Select the desired mode.

The default temperature is displayed along with the available temperature range.

- Change the default temperature.

- Confirm with OK.

Settings

Self Clean

- With reminder

A reminder to run the Self Program program will appear in the display.

- Without reminder

You will not be reminded to run the Self Clean program.

Safety

System lock

The system lock prevents the oven being turned on inadvertently.

The system lock will remain activated even after a power failure.

Select **On** to activate the system lock.

The timer can still be used when the system lock is active.

- **On**

The system lock is now active. If you want to use the oven, touch  for at least 6 seconds.

- **Off**

The system lock is not active. The oven can be used as normal.

Sensor lock

The sensor button lock prevents you from accidentally turning the oven off or changing a cooking program.

– On

Before you can use a mode, touch  for at least 6 seconds.

– Off

The buttons respond immediately to a finger touch.

Catalyzer

The level of odor reduction is represented by a bar with seven segments.



Maximum odor reduction is selected when all segments are filled. If none of the segments are filled the catalyzer is turned off.

- Select **Minimum** or **Maximum** to change the level of odor reduction.
- Select **On** or **Off** to turn the catalyzer on and off.

Settings

Calibrate temperature

Using temperature calibration the temperature can be modified, in all modes and MasterChef programs, so that it is slightly higher or lower than shown.

The temperature calibration is represented by a bar with seven segments.



If all of the segments are filled the oven temperature is much higher than indicated in the display. If no segment is filled the oven temperature is much lower than indicated.

- Select + or —, to adjust the temperature calibration.
- Confirm with OK.

Electrical Version

Setting the voltage (electrical version)

- Select the desired voltage and corresponding frequency.
- Confirm with OK.

Sensor group

By factory default, the oven automatically detects the wireless roast probe. If you have purchased a new Miele roast probe the group will have to be adjusted (e.g. P1-D01-0000001).

- Select the group that is printed on the metal tip of the wireless roast probe.

The group is located at the second position of the 12 digit code (P1-P9).

- Confirm with OK.

Showroom Program

This mode enables the oven to be demonstrated in showrooms without heating up. It should not be set for domestic use.

Demo Mode

If you have demo mode activated Demo Mode is active. The appliance will not heat up **will appear when you turn on the oven.**

- On
Touch OK for at least 4 seconds to activate demo mode.
- Off
Touch for at least 4 seconds to deactivate demo mode. The oven can then be used as normal.

Factory default

- Settings
Any settings that have been altered will be reset to the factory default setting.
- Favorites
All Favorites will be deleted.
- Default temperatures
Any default temperatures that have been changed will reset to the factory default settings.
- MyMiele
All MyMiele entries will be deleted.

MyMiele

You can personalize your oven using the MyMiele  function by inputting frequently used processes.

It is particularly useful with MasterChef program as you do not need to work through every screen in order to start your program.



You can also set processes that you have entered into MyMiele to appear in the Start screen (see "Settings – Start screen").

To add an entry

You can add up to 20 entries.

- Select MyMiele.
- Select Add entry.

You can select options listed in the following categories:

- Operating Modes
- Gourmet Center Auto
- Special Modes 
- Favorites 

- Confirm with OK.

The selected option with its symbol will appear in the list.

- Proceed as above for further entries as required. You can only chose options that have not already been selected.

Editing MyMiele

After selecting **Edit** you can

- add entries as long as MyMiele contains fewer than 20 entries,
- delete entries,
- sort entries as long as MyMiele contains more than 4 entries.

Deleting entries

- Select MyMiele.
- Select **Edit**.
- Select **Delete** entry.
- Select the entry that you want to delete.
- Confirm with **OK**.

The entry will then be removed from the list.

Sorting entries

The order can be rearranged as long as there are more than 4 entries.

- Select MyMiele.
- Select **Edit**.
- Select **Sort** entry.
- Select the position you want to move it to.
- Confirm with **OK**.

The entry will now appear in the position selected.

Alarm + Timer

Using "Timer", you can set an alarm for a specific time or set the timer duration to time an activity in the kitchen e.g. boiling eggs.

Two alarms can be set simultaneously, two timer durations or an alarm and a kitchen timer duration.

Using the Alarm

The alarm can be used to set a specific time at which the oven buzzer will sound.

Setting the alarm

If the setting Time - Display - Off is selected, you will need to turn the oven off before setting the alarm. The alarm time will then appear in the display when the oven is turned off.

- Select "Timer".
- Select New Alarm.
- Set the time for the alarm.
- Confirm with OK.

When the oven is switched off, the alarm time and  will appear instead of the time of day.

If you are cooking at the same time or if you are in a different menu, the alarm time and  will appear in the top right-hand corner of the display.

At the set alarm time

- the Alarm symbol  will flash next to the time in the display.
- a buzzer will sound if turned on (see "Settings - Volume - Buzzer tones").
- Select "Timer" or the alarm in the upper right of the display.

The buzzer will turn off and the symbols in the display will go out.

Changing an alarm

- Select the alarm in the upper right of the display or select "Timer" and the desired alarm.

The alarm selected appears.

- Set the new time for the alarm.
- Confirm with OK.

The adjusted alarm time is now saved and will appear in the display.

Deleting an alarm

- Select the alarm in the upper right of the display or select "Timer" and the desired alarm.

The alarm selected appears.

- Select Reset.

The alarm will be deleted.

Using the Timer

The timer can be used to time any activity in the kitchen , e.g. boiling eggs.

The timer can also be used at the same time as a cooking program if a start and finish time have been set, e.g. a reminder to stir the dish or add seasoning.

A maximum time of 9 hours and 59 minutes can be set for the timer.

Tip: Use the timer in Moisture Plus  to remind you to inject the bursts of steam at the desired time.

Setting the timer

When the setting Time - Display - Off is set the oven must be turned on to set the timer. The timer can then be seen counting down in the display when the oven is turned off.

Boiling eggs and setting the timer for 6 minutes and 20 seconds

- Select "Timer".
- Select New Timer Time.
- Set the timer for the required time.
- Confirm with OK.

When the oven is turned off, the timer duration counts down in the display and  appears instead of the time of day.

If you are cooking at the same time or if you are in a different menu, the timer duration and  will appear in the top right-hand corner of the display.

Alarm + Timer

At the end of the timer

- the Timer symbol  flashes,
 - the time starts counting upwards,
 - A buzzer will sound if turned on (see "Settings - Volume - Buzzer tones").
- Select "Timer" or the timer in the upper right of the display.

The buzzer will turn off and the symbols in the display will go out.

Resetting the timer

- Select the timer in the upper right of the display, or select "Timer" and the desired timer.

The time previously set appears.

- Set a new timer duration.
- Confirm with OK.

The changed time is saved and will count down in seconds.

Canceling the timer

- Select the timer in the upper right of the display, or select "Timer" and the desired timer.







The time previously set appears.

- Select `Reset`.







The timer has been canceled.

Guide to the modes





The oven has a wide range of modes for preparing a variety of foods.

Oven modes	Default temperature	Temperature range
Convection Bake  Use this mode for baking and roasting on several levels at the same time. You can cook at lower temperatures than with the Surround  mode because the fan distributes the heat evenly throughout the cavity for a consistent baking temperature.	325°F (160°C)	75–475°F (25–275°C)
Surround  This premium baking mode uses heat from the upper and lower elements to create perfect results on all baking recipes.	350°F (180°C)	75–525°F (25–275°C)
Moisture Plus  Infuse up to 3 bursts of moisture, either manually or time driven, throughout the cooking program to ensure a soft, moist interior with a crispy crust. MasterChef Plus programs use Moisture Plus during the cooking/baking process.	320°F (160°C)	265–480°F (130–250°C)
Intensive  This mode gently circulates heated air from the lower heating element using the fan to create a brick oven environment. Ideal for baking pizza, focaccia, pies and tarts that require a crisp base and moist toppings.	400°F (170°C)	125–475°F (50–250°C)
Auto Roast  For a premium result, the meat is seared at a high temperature keeping meat tender and juicy.	320°F (160°C)	200–450°F (100–230°C)

Guide to the modes

Oven modes	Default temperature	Temperature range
Surround Roast  For roasting traditional recipes, e.g. pot roast, and braising or cooking at low temperatures.	355°F (180°C)	30–525°F (280°C)
Convection Roast  This mode uses the convection fan to circulate heated air throughout the oven. Ideal for cooking delicate cuts of meat, fish and crispy poultry.	320°F (160°C)	30–475°F (250°C)
Bake  This mode uses traditional baking techniques to perfect pies and biscuits.	375°F (190°C)	125–450°F (50–225°C)
Browning  For a perfectly browned topping, for example when making a gratin or browning the top of a casserole.	375°F (190°C)	100–475°F (250°C)
Maxi Broil  The entire upper heating element is used for intense heating from above. This function gives excellent browning and searing results. Perfect grilling large quantities of steak, chops, kebabs, etc.	465°F (240°C)	200–575°F (300°C)
Broil  For grilling smaller quantities of steak, chops, kebabs, etc.	465°F (240°C)	200–575°F (300°C)

Guide to the modes

Oven modes	Default temperature	Temperature range
Convection Broil  This mode distributes hot air from the Browning/ Broiling element over the food using the fan. This allows for a lower temperature to be used then when using Broil  . Ideal for broiling thicker cuts of meat (e.g. chicken, roulades).	375°F (200°C)	200-500°F (100-250°C)
Rotisserie  The rotisserie evenly broils and adds a finishing touch to items such as stuffed meat, tied roasts, poultry, vegetables and kabobs.	400°F (240°C)	350 (200)– 575°F (300°C)
Gentle Bake  A combination of different heating elements ensures excellent baked good, gratins and lasagna.	375°F (190°C)	200-475°F (100-250°C)

Operation

Energy saving tips

- Remove any accessories from the oven that you do not require for cooking.
- Try not to open the door when cooking.
- If a temperature range is given, it is best to select the lower temperature and check the food after the shortest cooking time given.
- The default setting for the Time of Day display Time - Display - Off will consume the least amount of energy.
- With the factory default setting Lighting - On for 15 seconds the oven interior lighting turns off automatically after 15 seconds. It can be turned on again at any time by touching "Light".
- When cooking with automatic shut-off or the wireless roast probe, the oven heating will turn off automatically shortly before the end of cooking. The residual heat is sufficient to finish the cooking process. Energy Save will appear in the display. The cooling fan or hot air fan (depending on mode used) will remain on.
- The oven turns off automatically if a button is not pressed to save power. The amount of time before the oven turns off depends on the selected settings, e.g. mode, temperature, cooking duration, etc.

Quick Guide

- Turn on the oven.

The main menu will appear.

- Place the food in the oven.
- Select Operating Modes.
- Select the desired mode.

The oven mode and default temperature will appear.

The oven heating, lighting and cooling fan will turn on.

- Adjust the default temperature if necessary.

The default temperature will be automatically accepted within a few seconds. If necessary, select *Change* to go back to the temperature setting (see "Additional functions - Changing the temperature").

- Confirm with OK.

The required and the actual temperatures will appear.

You will see the temperature rising in the display. A buzzer will sound when the oven temperature is reached if this option is selected (see "Settings - Volume - Buzzer tone").

After the cooking process:

- Take the food out of the oven.
- Turn the oven off.

Cooling fan

After the cooking process the cooling fan will continue to run for a while after a program is complete to prevent moisture from building up in the oven, on the control panel or surrounding cabinetry.

When the temperature in the oven has fallen sufficiently the cooling fan will turn off automatically.

The default setting can be changed if desired (see "Settings - Cooling Fan").





Additional functions

You have placed the food in the oven, selected a mode and set the temperature.

By selecting Additional Settings you can adjust cooking times and adjust additional settings.

- Select Change.
- Select Additional Settings.

Additional options will appear in the display for you to select for change if desired.

- Duration
- Core temperature (This will only appear if you are using the wireless roast probe. You cannot set a cooking duration when using the roast probe.)
- Ready at
- Start at (This will appear if a Duration or Ready at time has been set.)
- Rapid PreHeat (This only appears if a temperature of more than 210°F (100°C) has been set for Convection Bake , Auto Roast , Surround  or Moisture Plus .
- Crisp function (This moisture reduction feature will allow surfaces to crisp on the outside.)
- Change type of heating (This option will only appear with Moisture Plus . You can combine bursts of steam with another type of heating.)
- Change Operating Mode (You can change the cooking mode during operation.)

Changing the temperature

As soon as a cooking mode is selected, a default temperature will appear in the display together with its possible range (see "Guide to the modes").

- If the default temperature is suitable for your recipe, confirm it with "OK".
- If it is not suitable for your recipe, you can change it for this particular cooking program.

You can also permanently reset the default temperature to suit your personal cooking habits (See "Settings - Default temperatures").

Example: You have selected Convection Bake  and 350°F (170°C) and can see the temperature increasing.





You want to reduce the target temperature to 310°F (155°C).

- Select Change.
- Changing the temperature
- Confirm with OK.

The adjusted target temperature is saved. The target and actual temperatures are displayed.

Rapid PreHeat

Rapid PreHeat can be used to speed up the preheating phase.

The Rapid heat-up function switches on automatically if you set a temperature of more than 212°F (100°C) for Convection Bake , Auto Roast , Surround  and Moisture Plus .

Do not use Rapid PreHeat to preheat the oven when baking pizzas or delicates mixtures (e.g. small baked goods, sponge). These will brown too quickly.

You can turn-off Rapid PreHeat for a relevant cooking process.

Rapid PreHeat

– On

The Browning / Broiling and ring heating elements turn on together with the fan to enable the oven to reach the required temperature as quickly as possible.

– Off

Only the heating elements associated with the cooking program are turned on.

To turn the Rapid PreHeat function off:

- Select Change.
- Select Additional Settings.
- Select Rapid PreHeat.

In Rapid PreHeat, Off will appear.

- Confirm with OK.

Rapid PreHeat has been deactivated.

Instead of Rapid PreHeat, Preheating will appear in the display.

- Select the required oven mode and temperature.
- Rapid PreHeat should be turned off when baking pizza or delicate mixtures.
- Wait for the preheating phase to complete.

A buzzer will sound when the set temperature is reached, if the buzzer is set (see "Settings").

- Place the food in the oven.

Additional functions

Using the Crisp function (Moisture Reduction)

It is a good idea to use this function when cooking items which are moist on the inside but which should be crispy on the outside, e.g. french fries, croquettes or breaded meats.

It is also suitable for deep fruit cakes, such as apple cake.

You have placed the food in the oven, selected a mode and set the temperature.

You can activate the "Crisp function" with any oven mode. It must be activated separately for a cooking process. For best results, activate it at the beginning of the cooking process.

- Select Change.
- Select Additional Settings.
- Select Crisp function.

In Crisp function, On will appear.

- Confirm with OK.

Moisture reduction is now activated.

Changing the oven mode

You can change the oven mode during operation.

- Select Change.
- Select Additional Settings.
- Select Change Operating Mode.
- Select the desired mode.

The new mode will appear in the display together with its default temperature.

- Change the temperature, if necessary.
- Confirm with OK.

The oven mode has been changed.

The times entered will be kept.

Setting additional durations

You have placed the food in the oven, selected a mode and set the temperature.

By entering **Duration**, **Ready at** or **Start at** you can automatically turn the cooking program on or off.

– Duration

Enter the cooking duration required. Once the duration set has elapsed, the heating will turn off automatically. The maximum duration that can be set is 12:00 hours.

A cooking duration cannot be entered if you are using the wireless roast probe. When using the roast probe, the cooking duration is determined by when the set core temperature is reached.

– Ready at

You can specify when you would like the cooking program to complete. The oven will turn off automatically at the time set.

A **Ready at** time cannot be entered if you are using the wireless roast probe. When using the roast probe the end time is determined by when the set core temperature is reached.

– Start at

Set the time you would like cooking to start at. The oven will turn on automatically at the time set.

Start at can only be used together with **Duration** or **Ready at**, except when using the wireless roast probe.

Additional functions

Turning off automatically

It is now 11:45. The food takes 30 minutes to cook and should be ready at 12:15.

Select **Duration** and set 00:30 h or select **Ready at** and set the time for 12:15.

The oven will turn off automatically after this duration has elapsed or the time set has been reached.

Setting the duration

- Select **Change**.
- Select **Additional Settings**.
- Set the cooking duration.
- Confirm with **OK**.

Setting the "Ready at" time

- Select **Change**.
- Select **Additional Settings**.
- In the **Ready at** field, set the time at which the food should be ready.
- Confirm with **OK**.

Turning on and off automatically

It is recommended to use the automatic On/Off feature when roasting. Do not delay the start of the program for too long when baking. Cake mixtures and doughs will dry out, and the leavening agents will lose their effectiveness.

To turn a cooking program on and off automatically, you have a choice of how to enter the time parameters:

- **Duration and Ready at**
- **Duration and Start at**
- **Ready at and Start at**

It is now 11:30. The food takes 30 minutes to cook and should be ready at 12:30.

- Select **Change**.
- Select **Additional Settings**.
- In the **Duration** field, set 0:30 h.
- In the **Ready at** field, set 12:30 h.
- Confirm with **OK**.

The **Start at** time will be automatically calculated. **Start at 12:00** will appear in the display.

The oven will turn on automatically when this time is reached.

Sequence of a cooking program that turns on and off automatically

Up until the start time the mode, the selected temperature, *Start at* and the start time will appear in the display.

After the program has started you can follow the preheating phase in the display until the required temperature has been reached.

Once this temperature is reached, a buzzer will sound if turned on (see "Settings - Volume - Buzzer tone").

After the preheating phase the remaining time will appear in the display.

The time will count down in the display. The last minute counts down in seconds.

At the end of the cooking process a buzzer will sound if turned on (see "Settings - Volume - Buzzer tones").

The oven heating and lighting are turned on. *Program Finished* appears in the display.

You have the option to save the program as a Favorite (see "Favorites") or to increase the cooking duration using *Change*. Select "Back" to go back to the main menu.

During the cooling down phase the cooling fan will continue to run.

Changing the set time

- Select *Change*.

All options that can be changed will appear.

- Change the desired time.
- Confirm with OK.

These settings will be deleted in the event of a power failure.

Canceling cooking

- Touch "Back" twice.

Cancel Cooking? appears in the display.

- Select *Yes*.

The oven heating and lighting will turn off, and any durations set will be deleted.

Moisture Plus

Your oven is equipped with a steam injection system for cooking with moisture. Baking, roasting and cooking with Moisture Plus  guarantees optimized steam and air conduction for excellent cooking and browning results.

After selecting Moisture plus  you need to set the temperature and the number of bursts of steam.

Available options are:

- Automatic burst of steam
This requires enough water for one burst of steam. The burst of steam will be injected into the oven automatically after the heating-up phase.
- 1 Burst of steam
2 Bursts of steam
3 Bursts of steam
You need to add the appropriate amount of water for the number of bursts of steam. You have to release the bursts of steam yourself.

The water is injected as bursts of steam into the oven cavity during the cooking program. The steam inlets are located at the rear left corner of the roof of the oven.

One burst of steam takes approx. 5–8 minutes. The number of bursts of steam and when they are injected will depend on the type of food being cooked:

- **Yeast doughs** will rise better if steam is injected at the beginning of the program.

- **Bread and rolls** will also rise better if exposed to steam at the start. Injecting a burst of steam at the end of the program will give the bread and rolls a shiny crust.
- When **roasting meat with a high fat content**, injecting steam at the beginning of roasting will help render the fat.

Moisture Plus is not suitable for mixtures which contain a lot of moisture, such as choux pastry and meringues, as the addition of steam does not allow them to dry out sufficiently.

Cooking with the Moisture Plus function

It is normal for condensation to form on the inside of the door during steam injection. This will dissipate during the course of the cooking program.

- Prepare the food and place in the oven if no preheating is required.
- Select Operating Modes.
- Select Moisture Plus .

The default temperature (320°F/160°C) is displayed

The oven heating, lighting and cooling fan will turn on.

Setting the temperature

- Set the required temperature.
- Confirm with OK.

Setting the number of bursts of steam

The oven will draw in water automatically from the water supply and then release the steam at the specified times. You will hear some pumping noises during the water intake process.

- If you wish the burst of steam to be injected into the oven automatically after the heating-up phase, select Automatic burst of steam.
- If you wish to inject one or more bursts of steam manually at specific times, select 1 Burst of steam, 2 Bursts of steam or 3 Bursts of steam.

When to add the bursts of steam

This option will only appear in the display after you have selected 1, 2 or 3 bursts of steam.

Tip: If you have selected more than one burst of steam, the 2nd one should be released at least 10 minutes after starting the program.

Manual bursts of steam

- To trigger bursts of steam yourself, select Manually. Set the timer to remind yourself.

Time-controlled steam

- If you want to time when to release the bursts of steam, select Time Controlled.
- Set the time for each burst of steam. The oven will draw in water and then release the steam at the specified times. The time counts down as soon as the program is started.
- Confirm with OK.

Changing the type of heating

All four modes (Convection Bake, Surround, Intensive and Auto Roast) are available to use with Moisture Plus , however Convection Bake is set as the default mode.

- Select Change.
- Select Additional Settings.
- Select Change type of heating.
- Select the desired mode.
- Confirm with OK.

Cooking will be carried out using the different type of heating selected.

Injecting bursts of steam

Steam can cause scalding. Do not open the door during bursts of steam. Also, condensation on the sensors will cause then to have a slow reaction time.

Automatic burst of steam

Automatic burst of steam appears in the display.

Once the preheating phase has been completed, the automatic burst of steam is injected.

The water will vaporize in the oven whilst steam is being released and Burst of steam active will appear in the display.

After the burst of steam Burst of steam, completed will appear in the display.

- Continue cooking until the end of the cooking duration.

1, 2 or 3 Bursts of steam

Manual bursts of steam

When Manually has been selected, you can trigger bursts of steam once Start Manual burst of steam appears.

Please wait until the preheating phase is completed to allow the steam to be distributed evenly by the warm air in the oven.

Tip: Set the "Timer" as a reminder.

- Select Start Manual burst of steam.

The burst of steam will be released and Burst of steam active will appear in the display.

- Proceed as described to inject further bursts of steam.

Burst of steam, completed will appear in the display after each burst of steam.

- Continue cooking until the end of the cooking duration.

Time-controlled steam

The oven will release the steam after the specified amount of time.

Moisture Plus

Evaporating residual moisture

When cooking using the addition of moisture, the water will be equally distributed between the number of bursts of steam and used up as long as the program is not interrupted.

However, if a program using the addition of moisture is interrupted before all the bursts of steam have been injected, the water for these unused bursts of steam will remain in the system.

The next time Moisture Plus  or a MasterChef Plus program is used Evaporate Residual Moisture? will appear in the display with the options Skip and Yes.

It is best to start the evaporation of residual water right away so that only fresh water is used during a cooking program.

The residual moisture evaporation process

The oven will heat up and the residual water in the oven compartment will evaporate.

Depending on the amount of water, this can take up to approximately 30 minutes.

Steam can cause scalding.
Do not open the door.

The moisture will condense on the door and in the oven compartment and needs to be wiped off after the oven has cooled down.

Starting residual moisture evaporation immediately

Steam can cause scalding.
Do not open the door.

- Select the Moisture Plus  function or a MasterChef Plus program.

Evaporate Residual Moisture? **appears**.

- Select Yes.

Evaporate Residual Moisture and the timer settings **appear**.

The evaporation process will begin. The duration will count down in the display.

The duration displayed depends on the amount of water in the system. This may alter the duration of the evaporation process.

At the end of the residual water evaporation process Program Finished **appears**:

- Select "Back".

A cooking process using Moisture Plus  or a MasterChef Plus program can now be carried out.

The moisture will condense on the door and in the oven cavity and needs to be wiped off after the oven has cooled down.

Skipping residual moisture evaporation

 Skipping the residual moisture evaporation process can cause water to overflow into the oven cavity.
Do not cancel the evaporation process.

- Select the Moisture Plus  function or a MasterChef Plus program.

Evaporate Residual Moisture? **appears**.

- Select Skip.

A cooking process using Moisture Plus  or a MasterChef Plus program can now be carried out.

You will be prompted to carry out the evaporation of the residual moisture process the next time you select the Moisture Plus  function or a MasterChef Plus program and when you turn the oven off.

Gourmet Center

Your oven has a wide range of MasterChef, and MasterChef Plus programs that enable you to achieve excellent cooking results with ease. Simply select the appropriate program for the type of food you are cooking and follow the instructions in the display.

In the Gourmet Center you will find:

- MasterChef programs for the preparation of cakes, meats, fish dishes, desserts, etc.
- MasterChef Plus program for the preparation of bread with Moisture Plus.

MasterChef

The MasterChef programs can be found under **Gourmet Center**  – MasterChef.

- Baked Goods
- Fish
- Meat
- Pizza
- Potatoes
- Poultry

MasterChef Plus

In MasterChef Plus a variety of bread programs are available. These MasterChef programs work with Moisture Plus.

Using the MasterChef and MasterChef Plus programs

From the main menu:

- Select **Gourmet Center**.
- Select **MasterChef** or **MasterChef Plus**.

A list of food types will appear in the display.

- Select the food category (for MasterChef Plus, only one category is available).

The MasterChef or MasterChef Plus programs available for the food category selected will appear.

- Select the desired MasterChef or MasterChef Plus program.

Each step you need to take before starting the program will appear in the display.

Depending on the program selected the following information or instruction will appear in the display:

- type of cookware,
- shelf level,
- using the wireless roast probe,
- duration.
- Follow the instructions in the display.

Notes on using these programs

- The oven interior should be at room temperature before starting a MasterChef program.
- Some programs require a preheating phase before food is placed in the oven. A prompt will appear to tell you when to add the food.
- The duration quoted for MasterChef programs is an estimate. It may increase or decrease depending on the program. When using the roast probe, the duration will be determined by when the core temperature is reached. The duration, in particular with meat, will vary depending on the initial temperature of the food.

Gourmet Center

Search

You can search **Gourmet Center** by food type and by the name of the **MasterChef** program.

There is a full text search which can also be used to search for parts of words.

From the main menu:

- Select **Gourmet Center**.

A list of food types will appear in the display.

- Select **Search**.
- Use the keyboard to type in the search text, e.g. "Bread".

The number of hits will be shown in the bottom right of the display.

If no match is found, or if there are more than 40 matches, the **hits** field will be deactivated and you will need to change the search text.

- Select **hits**.

The food types and **MasterChef** program available will then appear.

- Select the **MasterChef** program or the food type, and choose the **MasterChef** program

The **MasterChef** program will start.

- Follow the instructions in the display.

You can create and save up to 20 of your own programs.

- Each one can have up to 10 cooking stages. This enables you to save your most frequently used recipes very accurately. Each stage contains a mode, temperature and duration or core temperature.
- You can specify the shelf level(s) for the food.
- You can enter a program name for your recipe.

When you next select the program, it will start automatically.

There are different ways of creating a Favorite:

- At the end of running a MasterChef Program, save it as a separate program.
- After running a program with a set duration, select **Save**.

Then name the program.

Creating a Favorite

- Select **Favorites**.
- Select **Create Program**.

You can now specify the settings for cooking stage 1.

Follow the instructions in the display:

- Select and confirm the cooking mode, temperature and duration or core temperature.

Depending on the mode selected you can add the functions **Rapid PreHeat** and **Crisp** function in **Additional Settings**.

Settings for the 1st cooking stage have now been set.

More cooking stages can be added, for example, if you would like to add another cooking mode to follow the first.

- If additional cooking stages are required, select **Add** and proceed as you did for the 1st cooking stage.
- When you have completed setting the cooking stages, select **Finish**.

Set the shelf level(s) to be used:

- Select the desired level(s).
- Confirm with **OK**.

A summary of your settings will appear in the display.

- Check the settings and select **OK** to confirm, or select **Change** to correct the settings.
- Select **Save**.
- Enter the program name using the keyboard.

Favorites

You can add a line break for longer program names using the ↵ symbol.

- Once you have entered the program name select **Save**.

A message will appear in the display confirming that the name has been saved.

- Confirm with **OK**.

You can start the saved program immediately, delay the start or change the cooking stages.

More information regarding **Change Cooking Stages** can be found in "Changing favorites".

Starting a Favorite

- Place the food in the oven.

- Select **Favorites**.

The program names will appear in the display.

- Select the desired program.

You can start the saved program immediately, delay the start or show the cooking stages.

- Start Now

The program will start right away and the oven heating will turn on.

- Start Later

This option will only appear if you are using the wireless roast probe. You can specify when you would like the program to start. The oven heating will turn on automatically at the time set.

- Ready at

You can specify when you would like the cooking program to complete. The oven will turn off automatically at the time set.

- Start at

You can specify when you want the program to start. The oven heating will turn on automatically at the time you set.

– Display Stages

A summary of your settings will appear in this display. You can adjust the setting under **Change** (see "Changing Favorites").

- Select the desired menu item.
- Confirm the message regarding which shelf level to use with **OK**.

The selected program will begin automatically right away or at the time set.

Changing Favorites

Changing cooking stages

Cooking stages in a MasterChef program that have been saved under a different name cannot be changed.

- Select **Favorites**.

The program names will appear in the display.

- Select **Edit**.
- Select **Change Program**.
- Select the desired program.
- Select **Change Cooking Stages**.

The setting specified for a cooking stage can be changed or more cooking stages can be added to the program.

- Change the program as desired (see "Creating a Favorite").
- Check the settings and select **OK** to confirm.
- Select **Save**.
- If necessary, change the name (see "Creating a Favorite") and select **Save**.

The changes made to the program will be saved.

Favorites

Changing the name

- Select Favorites.

The program names will appear in the display.

- Select Edit.
- Select Change Program.
- Select the desired program.
- Select Change name.
- Change the name (see "Creating a Favorite) and select Save.

A message will appear in the display confirming that the name has been saved.

- Confirm with OK.

The new program name will be saved.

Deleting a Favorite

- Select Favorites.

The program names will appear in the display.

- Select Edit.
- Select Delete Program.
- Select the desired program.
- Select Yes.



The program is deleted.

You can delete all of your Favorites at the same time (see "Settings - Factory Default - Favorites").

Eating food which has been cooked correctly is important for good health.



Only bake cakes, pizza, french fries, etc. until they are golden brown. Do not overcook them.

Oven modes

Depending on how you would like the food prepared, you can use Convection Bake , Intensive , Moisture Plus  or Surround .

Bakeware

The bakeware used depends on the oven mode chosen and how the food is prepared.

- Convection Bake , Intensive , Moisture Plus :

Baking tray, universal tray, any heat-resistant baking dishes.

- Surround :

Dark metal, enamel or aluminum baking tins with a matte finish, as well as heat-resistant glass, ceramic and coated dishes can be used. Avoid bright, shiny metal tins as they result in uneven or poor browning, and in some cases cakes might not cook properly.

- Always place baking pans on the wire rack.
Position rectangular pans with the longer side across the width of the rack. This will allow for optimum heat distribution and even baking results.
- When baking cakes with fruit toppings or deep cakes, place the tin in the universal tray to catch any spillages.

Parchment paper / Greasing the pan

All Miele accessories (baking tray, universal tray and round baking form) are treated with PerfectClean enamel.

Surfaces treated with PerfectClean enamel generally **do not need** to be greased or covered with parchment paper.

Parchment paper is only needed with:

- anything with a high salt content (e.g. pretzels, bread sticks), because sodium can damage the PerfectClean surface;
- meringues or dishes with a high egg-white content, because they are more likely to stick,
- frozen food cooked on the wire rack.

Bake

Temperature

As a general rule, select the lower temperature given in the chart.





Choosing a baking temperature higher than those recommended may reduce the cooking time, but will lead to uneven browning, and unsatisfactory cooking results.

Baking duration

Check if the food is cooked at the end of the shortest duration quoted. To check if a cake is ready insert a wooden skewer or toothpick into the center, it should come out clean.

Shelf levels





The shelf level that you place the food on for baking depends on the oven mode and the number of trays being used.

- **Convection Bake** 
 - 1 Tray: Level 3
 - 2 Trays: Levels 1+3 / 2+4
 - 3 Trays: Levels 1+3+5
- **Moisture Plus** 
 - 1 Tray: Level 3
- **Intensive Bake** 
 - 1 Tray: Level 2 or 3
- **Surround** 
 - 1 Tray: Level 3

Bake moist cakes and muffins on a maximum of two levels at the same time.

Always follow USDA guidelines on food safety.

Oven modes

Depending on how you would like the food cooked, you can use Convection Bake / Convection Roast , Moisture Plus , Auto Roast , Surround / Surround Roast  or a MasterChef program.





Cookware

Any heat-resistant cookware can be used:

Wire oven rack, grilling and roasting insert (if available) on top of the universal tray, roasting pans, heat-resistant glass/earthen/cast iron cooking and roasting bags.

Temperature

As a general rule, select the lower temperature given in the chart. If higher temperatures are used, the meat will brown on the outside, but will not be properly cooked through.

When cooking with Convection Bake / Convection Roast , Moisture Plus  or Auto Roast  select a temperature approx. 25°F (20°C) lower than for Surround / Surround Roast .

Shelf levels

In most cases level 3 should be used. With large items, such as a turkey, use level 1 or 2.

Tips

- Resting time: At the end of the program, take the roast out of the oven, cover with aluminum foil and let stand for about 10 minutes. This helps retain the juices when the meat is sliced.
- The larger the cut of meat to be roasted, the lower the temperature should be. The roasting process will take a little longer, but the meat will be cooked evenly and the outside will become crisp.
- Use a roast probe for accurate cooking temperatures and best results.

Roast

Wireless Roast Probe

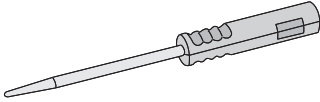

The wireless roast probe enables the roasting process to be monitored simply and reliably. It can be cleaned in the dishwasher.

How it works

The metal tip of the wireless roast probe is inserted into the food. There is a temperature sensor in the metal tip which measures the core temperature of the food during cooking.

The temperature sensor is located approx. 3/4" (2 cm) from the tip. Insert the wireless roast probe so that the temperature sensor is positioned centrally (see "Important notes about using the roast probe").

The rise in the core temperature reflects the extent to which the food is cooked. You can program the core temperature to be lower or higher, depending on whether you want your meat to be rare, medium or well done.

A core temperature of up to 210°F (99°C) can be set. Please refer to the roasting chart and "Slow Roasting" for the core temperatures applicable for different types of meat.

The cooking time will be similar when cooking with or without the wireless roast probe.

The core temperature value is sent via radio signal from the transmitter in the handle of the wireless roast probe via the antenna in the back wall of the oven to the appliance's electronic unit as soon as the food with the roast probe is placed in the oven

Uninterrupted transmission of the radio signal is only possible with the door shut. If the oven door is opened during the cooking program, e.g. to baste the meat, then the radio signal is interrupted. It will resume once the door has been closed. It will take a few seconds for the current core temperature to show up in the display again.

The temperature sensor will be destroyed at temperatures above 212°F (100°C). Inserted inside the food, there is no risk of damage since the maximum adjustable core temperature is 210°F (99°C).

If you are not using the wireless roast probe, do not keep it in the oven during cooking. Always put it back into the storage sleeve in the front frame of the oven.

When to use the wireless roast probe

Apart from MasterChef programs, Special Modes and Favorites, the wireless roast probe can be used with the following functions:

- Auto Roast 
- Convection Bake 
- Intensive 
- Surround 
- Moisture Plus 
- Convection Broil 

Important notes regarding the wireless roast probe

To ensure the probe works correctly, please observe the following instructions.

- Do not use deep, narrow, metal cooking containers, as these will weaken the radio signal.
- Do not place any metal items above the wireless roast probe, such as lids, aluminum foil, wire oven racks or universal trays on a shelf level above the food with the roast probe. Glass lids may be used.
- Do not use another standard metal cooking thermometer at the same time.
- Do not allow the handle of the wireless roast probe to sit in any sauce or cooking liquid, or to rest on the food or on the edge of the cooking container.

Danger of breaking!

Do not use the wireless roast probe to lift or carry the food.

Roast

In addition please note:

- The meat can be placed in a pot or on the rack in the universal tray.
- The metal tip of the wireless roast probe must be fully inserted into the center of the food. The handle should be angled upwards towards the corners or the door of the oven.
Make sure it is not horizontal.

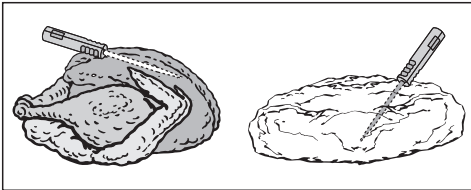

- When cooking poultry, insert the metal tip into the thickest part of the breast. You can find the thickest part of the breast by pressing the area with your thumb and index finger.
- Do not let the metal tip touch any bones or insert it into a fatty area of the meat. If fat or bone come into contact with the probe, this can lead to the oven being turned off too early.
- If the meat is very heavily marbled with fat, select the highest core temperature given in the roasting chart.
- When using roasting bags or aluminum foil, insert the probe through the bag or foil into the center of the meat. You can also place the meat, with the roast probe inserted, inside the foil. Follow the roasting bag / aluminum foil manufacturer's instructions.

- The wireless roast probe can only be inserted horizontally into flat food, e.g. fish. Therefore place flat food in glass or ceramic cooking containers, the walls of a metal container will disturb the radio signals.

If the wireless roast probe is no longer recognized during cooking, a message will appear in the display. Change the position of the probe in the food.

Using the wireless roast probe

- Remove the wireless roast probe from its holder in the door.
- Insert the metal tip of the wireless roast probe fully into the food. Make sure that the handle is angled upwards.
- Place the food in the oven.
- Close the door.
- Select an oven mode or MasterChef program.

The message `Continue cooking with roast probe?` will appear.

- Select `Yes`.
- Adjust the default temperature if necessary.
- Change the default core temperature if necessary.

The core temperatures cannot be changed for the MasterChef programs.

You can also start the process at a later time. Select `Additional Settings` and set a time in the `Start at` field. In MasterChef program select `Start Later`.

You can estimate approximately when the food will be ready as the duration of the cooking program is about the same as if you were cooking food without using the wireless roast probe.

`Duration` and `Ready at` cannot be set because the total time depends on how long it takes for the core temperature to be reached.

Roast

Time left display

After a certain time, the estimated duration of the cooking process remaining (time left) will appear in the display.

The time left is calculated from the cooking temperature selected, the required core temperature and the pattern of the increasing core temperature.

The time left first shown is an estimate. As the cooking process continues, the time is revised continuously, and a more accurate figure is shown.

The time left will be deleted if the cooking or core temperature is changed or if a different mode is selected. If the door is opened for a longer time, the time left will be recalculated.

Displaying the core temperature

As soon as the time remaining appears, you can also display the actual core temperature.

- Select Change.
- Select Display core temperature.
- Select On.
- Confirm with OK.

The actual core temperature will also appear in the display.

Using residual heat

Shortly before the end of the cooking program the oven heating will turn off. The residual heat in the oven is sufficient to complete the cooking process.

Using the residual heat in the oven saves energy.

Energy Save Phase will appear in the display to show that the oven is in energy save mode. The measured core temperature is no longer visible.

The cooling fan and hot air fan (if turned on) will continue to run.

When the selected core temperature has been reached,

- Program Finished appears in the display,
- A buzzer will sound if turned on (see "Settings - Volume - Buzzer tones").

Tip: If the food is not sufficiently cooked, insert the probe into another place and repeat the program.

Slow Roasting

This cooking method is ideal for cooking beef, pork, veal or lamb when a tender result is desired.

First, using a cooktop sear the meat on all sides to seal in the juices.

Then place the meat in a preheated oven. It will be cooked at a low temperature for an extended time allowing the meat to become very tender.

The meat will rest and the juices start to circulate evenly throughout.

This gives the meat a very tender and juicy result.



Tips

- Use fresh, lean meat that has been trimmed. Remove the bones before cooking.
- When searing, use a suitable cooking oil or fat that can withstand high temperatures (e.g. clarified butter, vegetable oil).
- Do not cover the meat during cooking.

Cooking will take approx. 2-4 hours, depending on the size and weight of the meat, as well as the desired degree of doneness and browning.

Cooking duration / Core temperatures

Always follow USDA guidelines on food safety.

Meat	 [min]	 [°F / °C]
Sirloin		
– rare	50–70	118/48
– medium	100–130	135/57
– well done	160–190	156/69
Pork Tenderloin	80–100	145/63
Smoked Pork Chop *	140–170	154/68
Veal Loin *	100–130	145/63
Saddle of Lamb *	50–80	140/60

* boneless

After the cooking process

Because the cooking temperatures are very low:

- the meat can be carved immediately, it does not need to rest.
- the cooking result will not be affected if the meat is left in the oven after the program is complete. It can be kept warm until you serve it.
- the meat is at an ideal temperature to eat right away. Serve on heated plates with a hot sauce or gravy to keep it warm.

Using the Slow Roasting function

- Select Special Modes.
- Select Slow Roasting.
- Set the required temperature.
- Set the core temperature.
- Follow the instructions in the display. Let the wire oven rack and universal tray preheat in the oven.
- While the oven is preheating, sear the meat on all sides on the cooktop.



Danger of burns!

When the oven is hot use pot holders to insert, remove or turn the food, or when adjusting the oven shelves, etc.

- **Once** Use the roast probe appears in the display, place the seared meat on the rack and insert the wireless roast probe, so that the metal tip is fully in the center of the meat.

For more information see "Roasting - Wireless roast probe".

- Place the universal tray on the rack and then place the rack into the oven on the shelf level indicated.



Use Caution!

The Browning / Broiling element will be hot. Danger of Burns!

- Close the door.

When the program is completed Program Finished will appear in the display and a buzzer will sound, if turned on (see Settings - Volume - Buzzer tone").

If the meat is not cooked to your satisfaction you can extend the cooking time.

Slow Roasting

Adjusting the Slow Roasting temperature

Use the wire oven rack with the universal tray on top.
Do not use the Rapid PreHeat function to preheat the oven.

- Place the rack with the universal tray on shelf level 3.
- Select Operating Modes.
- Select Surround  and a temperature of 265°F (130°C).
- Change the preheating function by selecting Change - Additional Settings - Rapid PreHeat - Off.
- Preheat the oven along with the universal tray and wire rack for approx. 15 minutes.
- While the oven is preheating, sear the meat on all sides on the cooktop.



Danger of burns!

When the oven is hot use pot holders to insert, remove or turn the food, or when adjusting the oven shelves, etc.

- Place the seared meat on the wire oven rack.
- Select Change.
- Reduce the temperature to 210°F (100°C).
- Continue cooking until the end of the cooking duration.

You can set the cooking process to automatically finish (see "Additional functions - Setting the duration").



Danger of burns!

Broil with the oven door closed. If you broil with the door open the hot air will escape from the oven before it has been cooled by the cooling fan.

The controls will get hot.

Cooking accessories

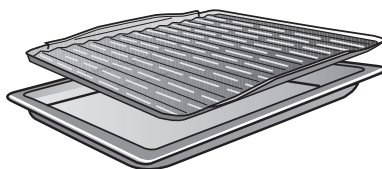

Use the universal tray with a grilling and roasting insert (if available) on top. The insert protects the oven from splatter and collects the juices underneath. The juices can then be used for gravy and sauces.

Temperature

As a general rule, select the lower temperature given in the chart. If higher temperatures are used, the meat will brown on the outside, but will not be properly cooked through.

Preheating

Always preheat the oven for about 5 minutes with the door closed before Broiling.

Oven modes

Maxi Broil

This mode gives excellent browning and searing results. Use this function for chops, ribs, large quantities of meat and browning large dishes.

The entire Browning / Broiling element will get hot and glow red.

Broil

This mode is excellent for broiling or searing smaller quantities. Use this mode for chops, ribs, small quantities of meat, and browning small dishes.

The center of the Browning / Broiling element glows red to generate the required heat.

Convection Broil

Use this function for thick pieces of meat, London broil.

The Browning / Broiling element and the fan turn on alternately.

Broil

Shelf levels

Select the shelf level according to the thickness of the food.

- Thin cuts: Shelf level 4 or 5
- Thick cuts: Shelf level 2 or 3

Broiling duration

Thick pieces of fish and meat take approx. 6-8 minutes per side. Thicker pieces will take longer. It is best to broil food that has a consistent thickness at the same time so each piece cooks evenly.

Testing doneness

Always follow USDA guidelines for safe food temperatures.

Preparing food for broiling

Rinse the meat under cold water and pat dry. Do not season the meat with salt before broiling, this will draw out the juices.

Brush the meat with oil, if necessary. Do not use other types of fat as they can easily burn and cause smoke.

Clean fish as usual. To enhance the flavor, salt or lemon can be added.

Broil

- Place the grilling and roasting insert (if available) in the universal tray.
- Place the food on top.
- Select the required oven mode and temperature.
- Preheat the Browning/Broiling element for approx. 5 minutes with the door closed.



Danger of burns!

When the oven is hot use pot holders to insert, remove or turn the food, or when adjusting the oven shelves, etc.

- Place the food on the appropriate shelf level (see the "Broiling chart").
- Close the door.
- Turn the food halfway through cooking.

Broil

Using the rotisserie to Broil

The rotisserie is an optional accessory for the Rotisserie  function.

The rotisserie can support a maximum weight of 11 lbs (5 kg).

- Place the wire oven rack or the FlexiClips with wire rack in shelf level 1.

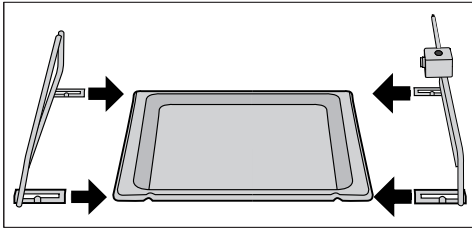

- Push the latched on the rotisserie into the notches of the universal tray.
- Secure the meat to the rotisserie spit using clips, making sure it is held centrally. The meat needs to be balanced in the middle for even rotation.

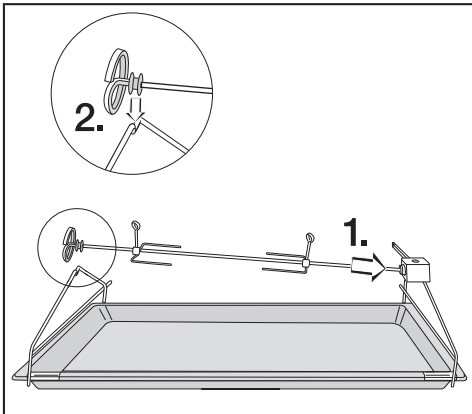

- Insert the pointed end of the rotisserie (1.) into the motor slot at the back of the rotisserie set up and set the other end onto the holder (2.) as illustrated.

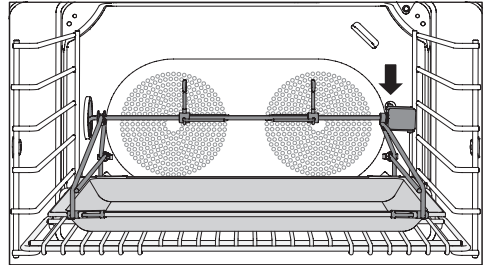

- Slide the universal tray including rotisserie on the wire oven rack or the FlexiClip rail with wire oven rack. Insert the spit into the motor slot at the back of the oven.
- Close the door.
- Select the Rotisserie  function.
- Set the temperature and duration.

The rotisserie motor will turn on after a short time. The rotation will brown the food evenly on all sides.

After the cooking process:

- Take the food out of the oven.
- Turn the oven off.

In addition to the MasterChef programs your oven has a variety of Special Modes.

■ **Select** Special Modes.

The following Special Modes are available:

- Defrost
- Dehydrate
- Reheat
(to reheat plated meals)
- Warm-up Cookware
- Proof
- Slow Roasting
See "Slow Roasting" for more information.
- Pizza
- Sabbath Program

This section also gives information on the following applications:

- Gentle Bake
- Canning
- Frozen food

Special Modes

Defrost

Use the Defrost mode to gently defrost frozen food.

The temperature can be set between 75-125°F (25-50°C).

- Select Special Modes.
- Select Defrost.
- If necessary, adjust the default temperature and set the duration.
- Follow the instructions in the display.

Air is circulated throughout the cabinet to gently defrost the food.

 Danger of salmonella poisoning!
Observe proper hygiene rules when defrosting poultry.
Do not use the defrosting liquid.

Tips

- If possible, remove the packaging and put the food on the roasting pan or a suitable dish.
- When defrosting poultry catch the defrosting liquid in a suitable dish.

Dehydrate

This program is designed for traditional drying of food to preserve it.

The temperature can be set between 175-210°F (80-100°C).

It is important that fruit and vegetables are ripe and not bruised before they are dehydrated.

- Prepare the food for dehydrating.
 - Peel and core apples, and cut into slices 1/4" (.5 cm) thick.
 - Core plums if necessary.
 - Peel, core and cut pears into wedges.
 - Peel and slice bananas.
 - Clean mushrooms, then either halve or slice them.
 - Remove parsley and dill from the stem.
- Distribute the food evenly over the roasting pan.

You could also use the rack or perforated baking tray, if available.

- Select Special Modes.
- Select Dehydrate.
- If necessary, adjust the default temperature and set the duration.
- Follow the instructions in the display.

Food	Approx. dehydrating time
Fruit	2–8 hours
Vegetables	3–8 hours
Herbs*	50–60 minutes

* Because this program uses the fan, it is recommended that you use Surround with a temperature of 175-210°F (80-100°C) for drying herbs.

- Reduce the temperature if condensation begins to form in the oven.

 **Danger of burns!**
Use pot holders when removing the dehydrated food from the oven.

- Allow the fruit or vegetables to cool down after dehydrating.

Dried fruit must be completely dry, but also soft and elastic. Juice should not escape when cut.

- Store in sealed glass jars or tins.

Special Modes

Reheat

This program uses moisture and is designed for reheating plated meals.

Available options are:

- Pizza
- Large Oven Dish
- Bakes

Use heat-resistant cookware.

- Place the food to be reheated in a dish on the rack. Do not cover it.
- Select Special Modes.
- Select Reheat.
- Select the desired dish and adjust the power level.
- Follow the instructions in the display.



Danger of burns!

Use pot holders when removing dishes from the oven. Condensation may accumulate on the bottom of the dish.

Warm-up Cookware

This program is designed to warm your cookware.

The temperature can be set between 120-175°F (50-80°C).

Use heat-resistant cookware.

- Place the rack on shelf level 3 and place the cookware to be heated on it.
- Select Special Modes.
- Select Warm-up Cookware.
- If necessary, adjust the default temperature and set the duration.
- Follow the instructions in the display.



Danger of burns!

Use pot holders when removing dishes from the oven. Condensation may accumulate on the bottom of the dish.

Proof

This program was designed to proof dough without humidity.

The temperature can be set between 85-120°F (30-50°C).

- Select Special Modes.
- Select Proof.
- If necessary, adjust the default temperature and set the duration.
- Follow the instructions in the display.

If you would like to proof dough with the addition of moisture, select the appropriate MasterChef program.

Pizza

This program is designed specifically for baking pizza.

The temperature can be set between 320-480°F (160-250°C).

- Select Special Modes.
- Select Pizza.
- If necessary, adjust the default temperature and set the duration.
- Follow the instructions in the display.



Special Modes

Sabbath Program

This program is designed for religious observance.

Select the Sabbath Program and then select the oven mode and temperature.

The program will only start once the door is opened and closed:

- The cooking process will start after about 5 minutes using Surround  or Bake .
- The oven will heat up to the temperature you have set and will maintain this temperature for a maximum of 72 hours.
- The interior lighting does not come on, even when the door is opened.

If Settings - Lighting - On has been selected, the lighting will remain turned on throughout the program.

- Sabbath Program appears in the display constantly.
- The time of day is turned off.

Once the Sabbath Program has started it cannot be changed or saved as a Favorites.

Using the Sabbath Program

The program can only be canceled by turning the oven off.

- Select Special Modes.
- Select Sabbath Program.
- Select the desired mode.

The Sabbath Program cannot be started if the timer is being used.

- Set the required temperature.
- Confirm with OK.

The oven is now ready for use.

Sabbath Program  and the temperature set will appear.

- Open the door to start the program.
- Place the food in the oven.
- Close the door.

The oven heating will turn on after 5 minutes.

To end the program early:

- Turn the oven off.

Gentle Bake

The Gentle Bake mode is ideal for casseroles and gratins which require a crisp topping.

The temperature can be set between 210-480°F (100-250°C).

- Select Operating Modes.
- Select Gentle Bake and change the default temperature if necessary.
- Follow the instructions in the display.

Special Modes

Canning

Always follow the USDA canning guidelines.

Canning containers

 **Danger of injury!**
Do not use the appliance to heat up or can food in sealed jars or containers. Pressure will build up inside them and they can explode causing damage to the appliance, as well as the risk of injury and scalding.

Only use jars designed for canning:

- Canning jars,
- Jars with twist-off lids.

Canning fruit and vegetables

It is recommended to use the Convection Bake  mode.

The instructions are for 6, 32 oz (1 liter) glass jars.

- Place the universal tray on shelf level 3 and place the jars on the pan.
- Select Convection Bake  and a temperature of 300-340°F (150-170°C).
- Wait until bubbles rise evenly in the jars.

Then reduce the temperature to avoid a boil-over.

Fruit / Cucumbers

- As soon as bubbles are visible in the jars select the lowest temperature. Then leave the jars in the warm oven for an additional 25-30 minutes.

Vegetables

- Reduce the temperature to 210°F (100°C) as soon as bubbles are visible in the jars.
- After the canning duration has completed, select the lowest temperature and leave the jars in the oven for an additional 25-30 minutes.

After canning

 **Danger of burns!**
Use pot holders when removing the jars from the oven.

- Take the jars out of the oven.
- Cover the jars with a towel and leave to set for approx. 24 hours.
- Make sure all jars are closed properly when storing them.

Frozen food

Tips for pizza, French fries, croquettes and similar items

- For best results place frozen pizza on parchment paper on the wire rack.
- Small frozen items such as french fries can be cooked on the baking tray or roasting pan.
- For small frozen items, use the lowest temperature recommended by the manufacturer.
- Turn small frozen items several times during cooking.

Preparation

Eating food which has been cooked correctly is important for good health.

- Select the oven mode and temperatures recommended by the manufacturer.
- Preheat the oven.
- Place the food in the preheated oven on the recommended shelf level.
- Check the food at the end of the shortest time recommended on the packaging.

Cleaning and care



Danger of burns!

Make sure the heating elements are turned off and allowed to cool completely.



Danger of injury! The steam from a steam cleaner could reach electrical components and cause a short circuit.

Do not use a steam cleaner to clean this appliance.

All surfaces can discolor or be damaged if unsuitable cleaning agents are used. The front of the oven, in particular, will be damaged by oven cleaners and descalers.

All surfaces are susceptible to scratches. Scratches on glass surfaces could cause a breakage.

Remove any cleaning agent residues immediately.

Unsuitable cleaning agents

To better maintain your appliance avoid the following:

- cleaners containing soda, ammonia, thinners, or chlorides,
- cleaners containing descaling agents or lime removers,
- abrasive cleaning agents e.g. powder or cream cleansers, pumice stones,
- solvent-based cleaners,
- stainless steel cleaners,
- dishwasher soap (powder),
- glass cleaning agents,
- ceramic cooktop cleaner,
- hard, abrasive brushes or sponges, e.g. pot scourers, brushes or sponges which have been previously used with abrasive cleaning agents,
- eraser sponges,
- metal scrapers,
- steel wool,
- spot cleaners,
- oven cleaners*,
- stainless steel spiral pads*.

* Can be used to remove very heavy soiling from PerfectClean treated surfaces.

Soiling not removed immediately can become difficult to remove. Continued use without cleaning will make the oven much harder to clean. Remove any soiling immediately.

The accessories are not dishwasher-safe, with the exception of the wireless roast probe.

Tips

- Soiling caused by spilt juices and cake mixtures is best removed while the oven is still warm. Use caution and make sure the oven is not too hot - Danger of burns.
- To make cleaning easier you can dismantle the oven door, remove the side runners and lower the Browning/Broiling element.

Normal soiling

There is a seal around the oven interior which seals the inside of the door. Take care not to rub, damage or move the gasket.

- Remove normal soiling immediately using a clean sponge with warm water and liquid dish soap applied with a clean, damp microfiber cloth.
- After cleaning, ensure that any detergent residue is removed with clean water. This is particularly important when cleaning surfaces treated with PerfectClean enamel as detergent residue can impair the non-stick properties.
- After cleaning, dry the surfaces with a soft cloth.

Wireless Roast Probe

The wireless roast probe can be cleaned in the dishwasher.

Cleaning and care

Stubborn soiling

Spilt fruit and roasting juices may permanently discolor surfaces of the oven. This discoloration is permanent but will not affect the performance of the oven. Do not use force to remove these stains. Clean using the instructions in this manual.

- Baked on deposits can be removed with a glass scraper or a non-abrasive stainless steel scrubbing pad.
- Stubborn soiling on PerfectClean surfaces can be cleaned using Miele Oven Cleaner. It must only be applied to cold surfaces in accordance with the instructions on the packaging.

Non-Miele oven spray must only be used in a cold oven and for no longer than 10 minutes.

- If necessary, the rough side of a dish sponge can be used to remove the soiling.
- After cleaning, remove all oven cleaning agent residues thoroughly with clean water, and dry with a soft cloth.

Self Cleaning the oven interior

Instead of cleaning the oven by hand you can use the Self Clean program .

Any soiling is broken down into ash by the high temperatures.

This oven has three levels for self cleaning, each with a different duration.

- Level 1 for light soiling
- Level 2 for heavier soiling
- Level 3 for very heavy soiling

Once the Self Clean program has been started, the door will automatically locked. The door cannot be opened again until the program has ended.

If desired, the timer can be used to delay the start of the Self Clean program.

At the end of the program any residues, such as ash from the cleaning process, can be easily wiped away.

Preparing for the Self Clean program

The high temperatures used during self cleaning will damage accessories that are not designed for cleaning in the Self Clean program. Please remove these accessories from the oven before starting the Self Clean program. This also applies to accessories purchased separately.

The following accessories are suitable for cleaning during the Self Clean program and can remain in the oven:

- Shelf runners,
- FlexiClips with wire rack HFCBBR30-2,
- Wire oven rack HBBR30-2.
- Take all accessories that are not "Self Clean safe" out of the oven.
- Place the wire oven rack on the top shelf level.

If not removed, coarse soiling can smoke and cause the Self Clean program to turn itself off.

- Remove any coarse soiling before running the Self Clean program.

Cleaning and care

Starting the Self Clean program



Risk of burns!

When Self Cleaning the front of the oven becomes hotter than with normal oven use.

Prevent children from touching the oven during the Self Clean program.

- Select Maintenance.
- Select Self Clean.
- Select the level required according to the level of soiling.
- Confirm with OK.

Follow the instructions in the display.

- Confirm with OK.

Starting the Self Clean program

- To start the Self Clean program immediately, select *Start Now*.
- Confirm with OK.

The Self Clean program will now start.

The door locks automatically. The oven heating and the cooling fan will then turn on automatically.

The oven light will not turn on during the Self Clean program.

The remaining time for the Self Clean program appears. The duration cannot be changed.

You can use the timer while the Self Clean program is running. At the end of the kitchen timer time the buzzer will sound and the Timer symbol  will flash. The time will then continue to increase in the display.

As soon as "Timer" is pressed, the buzzer and the flashing indicator will turn off.

Delaying the start of the Self Clean program

- To delay the start of the Self Clean program, select *Start Later*.
- Set the time you would like the program to start at.
- Confirm with OK.

The door will lock automatically. *Start at* and the set start time appear in the display.

Up until the start time you can alter the start and end time with *Change*.

As soon as the start time has been reached, the oven heating and the cooling fan will turn on automatically. The duration remaining will appear in the display.

At the end of the Self Clean program

When the duration remaining reaches 00:00 h, a message will appear in the display to tell you that the door is unlocking.

When the door lock has been deactivated:

- Program Finished appears in the display,
- A buzzer will sound if turned on (see "Settings - Volume - Buzzer tones").

■ Turn the oven off.

Acoustic and visual signals are turned off.



Danger of burns!

Danger of burns! Wait until the oven has cooled down before removing any residual soiling left in the oven compartment from the Self Clean program.

- Wipe any residues (e.g.ash) left behind after the Self Clean program out of the oven compartment and off of any accessories. The amount of ash will vary depending on how dirty the oven was.

Most soiling can be easily removed using a clean, soft sponge and a mild solution of warm water and liquid dish soap.

Depending on the degree of soiling before cleaning, there may be a visible layer of soiling across the inner glass pane on the door. This should be removed using the scouring side of a dish sponge or with a stainless steel spiral sponge and liquid dish soap.

- After the Self Clean program pull the FlexiClips with wire rack apart several times.

Please note:

- There is a seal around the oven interior which seals the inside of the door. Take care not to rub, damage or move the gasket.
- The FlexiClips with wire rack may appear discolored or a lighter color in places after they have been cleaned. This will not affect the function of the runners in any way.
- Spilt fruit juices may cause lasting discoloration to enameled surfaces. This discoloration is permanent but will not affect the efficiency of the enamel. Do not attempt to remove these marks.

Cleaning and care

The Self Clean program is canceled

If the Self Clean program is canceled the oven door will remain locked until the temperature inside the oven drops to below 535°F (280°C).

The following will cause the Self Clean program to cancel:

- Turning the oven off.
- A power failure.

If you turn the oven off the display still show Turn appliance off?.

- If you would like to cancel the Self Clean program, select Yes.

The door will unlock once the temperature in the oven has dropped below 535°F (280°C) and the oven is turned off.

- If you would like to continue running the Self Clean program, select No.

The Self Clean program will continue.

Once the power returns after a power failure, Program Canceled Cooling Down will appear in the display.

The door will unlock once the temperature in the oven has dropped below 535°F (280°C) and the oven is turned off.

A buzzer will sound if turned on (see "Settings - Volume - Buzzer tones").

Program Finished appears in the display.

- Select "Back".
- Start the Self Clean program again.

Removing the door

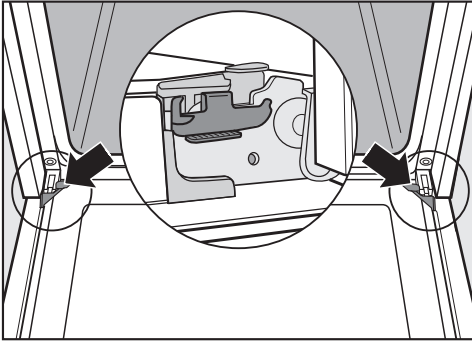

The door is connected with brackets on each door hinge.
Before the door can be removed the hinges must first be unlocked.

- Open the door fully.

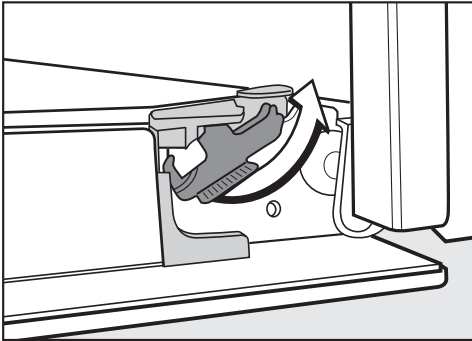

- Release the locking clamps by turning them as far as they will go.

Do not attempt to take the door off the brackets when it is in the horizontal position, the brackets will spring back against the oven.

Do not use the handle to pull the door off the brackets, the handle could break.

- Close the door until it rests partially open.



- Holding the door securely at both sides, lift it straight upwards.

Cleaning and care

Installing the door

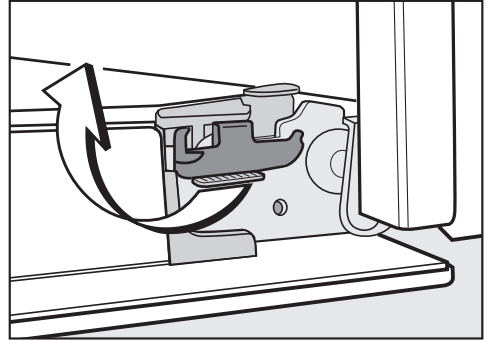
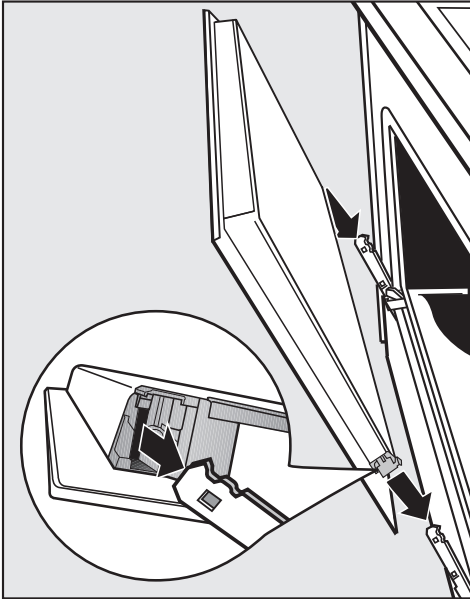

- Flip both locking clamps back up as far as they will go into a horizontal position.

- Hold both sides of the door securely and carefully fit it back into the brackets. Make sure that the door goes on straight.
- Open the door fully.

If the locking clamps are not locked the door can become easily detached from the brackets and be damaged. Be sure the locking clamps are always locked.

Removing the shelf runners

⚠ Danger of injury!
Do not use the oven without the shelf runners correctly inserted.

The FlexiClips with wire rack must be removed before the shelf runners (see "Features - FlexiClips with rack").

⚠ Danger of burns! Make sure the heating elements are turned off and that the oven cavity is cool.

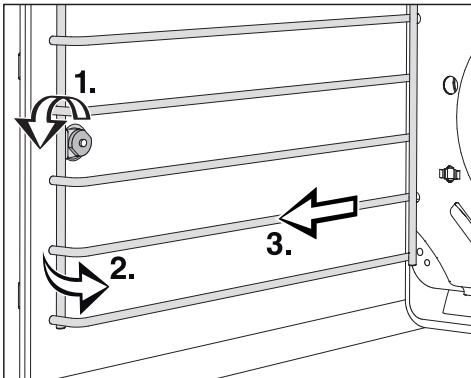

- Loosen the screw (1.).
- Pull the runners out of the holder (2.) at the front of the oven, and then pull them out of the oven (3.).





The runners can be **reinstalled** in the reverse order.

- Be sure that all parts are installed correctly.

Frequently asked questions

The following faults can be corrected without contacting the Miele Service Department. If in doubt, please contact Miele.



 **Danger of injury!** Repairs should only be carried out by a qualified and trained professional in accordance with local and national safety regulations. Unauthorized repairs could cause personal injury or machine damage.

Problem	Possible cause and remedy
This display is dark.	<p>The time of day display is deactivated. When the appliance is turned off, the time of day display is turned off.</p> <ul style="list-style-type: none">■ As soon as the oven is turned on, the time of day will appear. If you want it to be displayed continuously, the setting to turn the time of day display back on must be changed (see "Settings – Time of day - Display").
	<p>There is no power to the appliance.</p> <ul style="list-style-type: none">■ Check if the circuit breaker has tripped.
System Lock  appears in the display when the oven is turned on.	<p>The system lock  is On.</p> <ul style="list-style-type: none">■ You can unlock the oven to start a cooking program by pressing  for at least 6 seconds.■ To permanently deactivate the lock, see "Settings - System Lock .



Frequently asked questions

Problem	Possible cause and remedy
The oven does not heat up.	Demo mode is activated. The oven can be operated by will not heat up. ■ Deactivate Demo mode (see "Settings – Showroom Program").
Power Failure - Program Canceled appears in the display.	There has been a power failure which has caused the current cooking process to stop. ■ Turn the oven off and then back on again. ■ Restart the cooking process.
12:00 appears in the display.	The power supply was interrupted for longer than 200 hours. ■ Reset the date and time.
Maximum operating duration reached appears in the display.	The oven was operated for an unusually long period of time. The Safety cut-out feature has been activated. ■ Confirm with OK. Clear the message Program Finished by selecting "Back". The oven is now ready to use.
⚠ Fault XX appears in the display.	A fault has occurred that you cannot resolve. ■ Contact Miele Technical Service.
Door not locked appears in the display.	The Self Cleaning program door lock is not locking. ■ Turn the oven off and then back on again. Then restart the Self Clean program. ■ If the message appears again, contact Miele Technical Service.
Door not released appears in the display.	The door lock for the Self Clean program will not deactivate. ■ Turn the oven off and then back on again. ■ If the door lock still does not deactivate itself, contact Miele.
No signal to roast probe. Reposition roast probe in the oven. appears in the display.	The wireless roast probe is not recognized. ■ Reposition the probe in the food. If the oven still does not recognize the wireless roast probe, it may be faulty. A replacement roast probe can be ordered from Miele.

Frequently asked questions

Problem	Possible cause and remedy
<p>Fault with moisture control - the Gourmet Center programs will operate without moisture appears in the display after a MasterChef Plus program is displayed.</p>	<p>The steam injection system is faulty.</p> <ul style="list-style-type: none"> ■ Contact Miele Technical Service. <p>In the meantime a program without moisture can be run.</p>
<p>Fault with moisture control - Moisture Plus program not available appears in the display after selecting Moisture Plus .</p>	<p>The steam injection system is faulty.</p> <ul style="list-style-type: none"> ■ Contact Miele Technical Service. ■ Use the Convection Bake  program instead of Moisture Plus .
<p>Programs using moisture will not take in water.</p>	<p>Demo mode is activated. The oven can be operated but the pump for the steam injection system does not work.</p> <ul style="list-style-type: none"> ■ Deactivate Demo mode (see "Settings – Showroom Program").
	<p>The pump for the steam injection system is faulty.</p> <ul style="list-style-type: none"> ■ Contact Miele Technical Service.
<p>A noise is heard after the cooking process is complete.</p>	<p>The fan remains turned on after a cooking program (see "Settings - Cooling fan").</p>
<p>The oven has turned itself off.</p>	<p>The oven turns off automatically if a button is not pressed after a certain amount of time or after a cooking program has ended to save power.</p> <ul style="list-style-type: none"> ■ Turn the oven back on.
<p>Baked goods are not cooked properly after following the times given in the chart.</p>	<p>A different temperature than that given in the recipe was used.</p> <ul style="list-style-type: none"> ■ Select the temperature required for the recipe.
	<p>The ingredient quantities are different from those given in the recipe.</p> <ul style="list-style-type: none"> ■ Double check the recipe. The addition of more liquid or more eggs will make a wetter mixture which will take longer to cook.

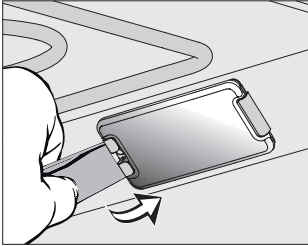
Frequently asked questions

Problem	Possible cause and remedy
<p>The browning is uneven.</p>	<p>The wrong temperature or shelf level was selected.</p> <ul style="list-style-type: none"> ■ There will always be a slight unevenness. If the unevenness is great, check whether the correct temperature and shelf level were selected.
	<p>That material or color of the bakeware is not suitable for the oven mode selected.</p> <ul style="list-style-type: none"> ■ When using Surround  use matte, dark colored pans. Light colored, shiny pans will not produce as desirable results.
	<p>The catalyzer has been set at too high a level. This can lead to an uneven browning result on more delicate food such as sponge cakes.</p> <ul style="list-style-type: none"> ■ Set the odor reduction catalyzer to a lower level or turn it off (see "Settings - Catalyzer").
<p>The oven lighting turns off after a short time.</p>	<p>The oven is factory set to turn off automatically after 15 seconds. This setting can be changed (see "Settings - Lighting").</p>
<p>The oven lighting does not turn on.</p> 	<p>The halogen bulb needs to be replaced.</p> <div style="border: 1px solid gray; padding: 5px; margin: 5px 0;"> <p> Danger of burns! Make sure the heating elements are turned off and allowed to cool completely.</p> </div> <div style="border: 1px solid gray; padding: 5px; margin: 5px 0;"> <p>The lamp cover may be damaged if it falls. When removing the cover hold it firmly so that it does not fall. Place a towel on the oven floor and open door to avoid damage.</p> </div> <ul style="list-style-type: none"> ■ Disconnect the appliance from the power supply. ■ Loosen the bulb cover with the tool supplied at the back of the frame. ■ Do not touch the halogen blub with bare fingers. Observe the manufacturers instructions. Remove the halogen bulb. ■ Replace it with a new halogen bulb (Osram 66725 AM/A, 230 V, 25 W, G9). ■ Press the bulb cover back into place. ■ Reconnect the oven to the electrical supply.

Frequently asked questions

Problem	Possible cause and remedy
There is soiling in the oven after the Self Clean program.	<p>The Self Clean program burns off soiling in the oven and leaves it as ash.</p> <ul style="list-style-type: none">■ Using a soft sponge, warm water and liquid dish soap remove the ashes. <p>If coarse soiling remains, start the Self Clean program again with a longer duration.</p>

After sales service

In the event of a fault which you cannot easily correct yourself, please contact:

- your Miele dealer, or
- the Miele Technical Service Department.

See back cover for contact details.

Please quote the model and serial number of your appliance when contacting Miele.

This information is given on the data plate, visible on the front frame of the oven, with the door fully open.

Warranty

For further information, please refer to your warranty booklet.

Caring for the environment

Disposal of the packing material

The cardboard box and packing materials protect the appliance during shipping. They have been designed to be biodegradable and recyclable.

Ensure that any plastic wrappings, bags, etc. are disposed of safely and kept out of the reach of children.
Danger of suffocation!

Disposal of your old appliance

Do not dispose of this appliance with your household waste.

Old appliances may contain materials that can be recycled. Please contact your local recycling authority about the possibility of recycling these materials.

Before discarding an old appliance ensure that it presents no danger to children while being stored for disposal. Unplug it from the outlet, cut off its power cord and remove any doors to prevent hazards.

Notes on connecting to the water supply

The appliance must be connected to the water supply by a qualified professional.

Disconnect the appliance from the electrical power supply before connecting the water line.

Turn off the water supply before connecting the water lines for the oven.

- The full length must not exceed 24' 7" (7.5 m) total.

Ensure that the shut-off valve is accessible after installation.

If the stainless steel hose supplied is damaged, it must only be replaced with an original Miele replacement hose, available from Miele. The hose must be suitable for supplying drinking water.

- All devices used for connecting the appliance to the water supply must comply with the current national and local safety regulations in the country in which the appliance is being installed.
- **Connect the oven to a cold water supply only.**
- The oven must only be connected to a water supply with a shut-off valve.
- A water shut-off valve must be provided between the stainless steel hose and the household water supply to ensure that the water supply can be cut off if necessary.
- The water shut-off valve must be accessible after installation.
- The water pressure must be between 14.5 and 145 psi (1 and 10 bar) are. If the pressure is higher, install a pressure reducing valve.
- The supplied stainless steel hose has a length of 4' 11" (1.5 m). If necessary, longer hosing is available. The hose must not be shortened.

Plumbing

Attaching the stainless steel hose to the oven

Make sure that the stainless steel hose is not kinked or damaged. The stainless steel hose must **not** be shortened.

- Remove the cover from the hard water port at the back of the oven.
- Take the angled side of the stainless steel hose and check whether a sealing ring is present. If necessary, insert one.
- Screw the stainless steel hose coupling nut onto the threaded union.
- Ensure that the hose is correctly fitted and that it is water-tight.

Connecting to the water supply

Danger of electric shock!
Disconnect the oven from the electrical supply before connecting to the water supply.

A faucet with a 3/8" connection thread is required for the connection.

- Check that the sealing ring is present. Replace, if necessary, before connecting the hose to the water supply.

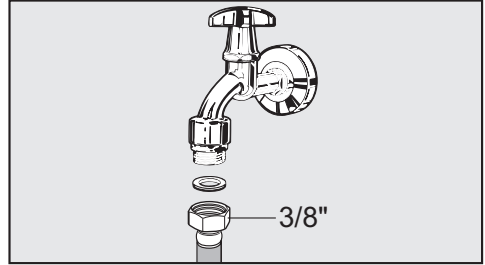

- Connect the stainless steel hose to the water supply.

Old or previously used tubing should never be used.

Only use the stainless steel hose supplied.

- Ensure that the hose is correctly fitted and that it is water-tight.
- Slowly open the shut-off valve to the water supply and check for leaks. If necessary, check whether the sealing ring and fittings are tight.

You can now continue with the installation (See "Installation").

CAUTION:

Before servicing, disconnect the power supply by either removing the fuse, shutting off the power main or manually "tripping" the circuit breaker.

Installation, repair and maintenance work must be performed by a Miele authorized service technician. Work by unqualified persons could be dangerous and may void the warranty.

Before connecting the appliance to the power supply, make sure that the voltage and frequency listed on the data plate correspond with the household electrical supply. This data must correspond to prevent machine damage. Consult an electrician if in doubt.

Only operate the appliance after it has been installed into cabinetry.

The plug must be plugged into an appropriate outlet that is installed and grounded in accordance with all local codes and ordinances.

WARNING: THIS APPLIANCE MUST BE GROUNDED

Installer: Please leave these instructions with the consumer.

Electrical connection

The oven is equipped with a power cord approx. 7' 2" (2.2 m) in length with a NEMA 14-30 P plug ready for connection to the power supply:

– 120/208 V, 30 A, 60 Hz

or

– 120/240 V, 30 A, 60 Hz

The voltage can be adjusted (see "Settings - Electrical Version").

SAVE THESE INSTRUCTIONS FOR THE ELECTRICAL INSPECTOR'S USE.

Copyright and licenses

Miele uses software to operate and control the appliance.

The copyright authorisation from Miele and other relevant software suppliers (e.g. Adobe) must be respected.

Miele and their suppliers reserve the rights to the software components.

In particular the following are prohibited:

- copying and distribution,
- modifications and derivations,
- decompilation, reverse engineering, disassembling and other such reductions of software.

This product contains Adobe® Flash® Player Software under licence from Adobe Systems Incorporated, Adobe Macromedia Software LLC. Adobe and Flash are registered trademarks of Adobe Systems Incorporated.

Components which fall under GNU General Public Licence and further Open Source licenses are integrated into the software.

An overview of the integrated Open Source components and a copy of the current licence can be obtained at <http://www.miele.com/device-software-licenses>. You will need to enter the specific product name.

Miele will provide the source code for all components of software licensed under the GNU General Public License and comparable Open Source licenses.

For source code requests, please email info@miele.com.

Please have the model and serial number of your appliance available before contacting Technical Service.



U.S.A.
Miele, Inc.

National Headquarters

9 Independence Way
Princeton, NJ 08540
Phone: 800-843-7231
609-419-9898
Fax: 609-419-4298
www.mieleusa.com

**Technical Service & Support
Nationwide**

Phone: 800-999-1360
Fax: 888-586-8056

TechnicalService@mieleusa.com

Canada
Miele Limited

Headquarters and Showroom

161 Four Valley Drive
Vaughan, ON L4K 4V8
Phone: 800-643-5381
Fax: 905-532-2290
www.miele.ca
professional@miele.ca
(commercial enquiries)

MieleCare National Service

Phone: 800-565-6435
905-532-2272
Fax: 905-532-2292
customer-care@miele.ca
(general and technical enquiries)



www.miele-shop.com

