

PARTIAL TEST REPORT
No.: 18-1-0210201T03a

According to:

FCC Regulations

Part 15.205, Part 15.209, Part 15.247

ISED-Regulations

RSS-Gen, Issue 5, RSS-247, Issue 2

for

Miele & Cie. KG

Wireless Food Probe System
(Host: HR1956-2)

Contains FCC ID: SSVNAEPI02

Contains ISED: 5669B-NAEPI02



Laboratory Accreditation and Listings	
  Deutsche Akkreditierungsstelle D-PL-12047-01-01 D-PL-12047-01-03 D-PL-12047-01-04	
Accredited EMC-Test Laboratory	
 WiFi ALLIANCE	ctia Authorized TM Test Lab Lab Code: 20011130-00
accredited according to DIN EN ISO/IEC 17025	
CETECOM GmbH Laboratory Radio Communications & Electromagnetic Compatibility Im Teelbruch 116 • 45219 Essen • Germany Registered in Essen, Germany, Reg. No.: HRB Essen 8984 Tel.: + 49 (0) 20 54 / 95 19-954 • Fax: + 49 (0) 20 54 / 95 19-964 E-mail: info@cetecom.com • Internet: www.cetecom.com	

Table of contents

1. SUMMARY OF TEST RESULTS	3
1.1. Tests overview of US (FCC) and Canada ISSED(RSS) Standards.....	3
2. ADMINISTRATIVE DATA	5
2.1. Identification of the testing laboratory.....	5
2.2. Test location	5
2.3. Organizational items.....	5
2.4. Applicant’s details	5
2.5. Manufacturer’s details	5
3. EQUIPMENT UNDER TEST (EUT)	6
3.1. Certification data of main EUT declared by applicant.....	6
3.2. Technical data of EUT declared by applicant.....	6
3.3. EUT: Type, S/N etc. and short descriptions used in this test report	7
3.4. Auxiliary Equipment (AE): Type, S/N etc. and short descriptions.....	7
3.5. EUT set-ups	8
3.6. EUT operating modes	8
3.7. EUT Software Settings	8
4. DESCRIPTION OF TEST SYSTEM SET-UP’S	9
4.1. Test system set-up for conducted measurements on antenna port	9
4.2. Test system set-up for AC power-line conducted emission measurements	10
4.3. Test system set-up for radiated magnetic field measurements below 30 MHz.....	11
4.4. Test system set-up for radiated electric field measurement 30 MHz to 1 GHz	12
4.5. Test system set-up for radiated electric field measurement above 1 GHz.....	13
5. MEASUREMENTS	14
5.1. General Limit - Conducted emissions on AC-Power lines	14
5.2. RF-Parameter – RF Power conducted.....	15
5.3. RF-Parameter – Duty Cycle.....	17
5.4. General Limit - Radiated field strength emissions below 30 MHz.....	19
5.5. General Limit - Radiated field strength emissions. 30 MHz - 1 GHz.....	21
5.6. General Limit - Radiated emissions. above 1 GHz.....	23
5.7. RF-Parameter - Radiated Band Edge compliance measurements	25
5.8. Measurement uncertainties	27
6. ABBREVIATIONS USED IN THIS REPORT	28
7. ACCREDITATION DETAILS OF CETECOM’S LABORATORIES AND TEST SITES	28
8. INSTRUMENTS AND ANCILLARY	29
8.1. Test software and firmware of equipment	29
8.2. Single instruments and test systems.....	29
8.3. Legend	30
9. VERSIONS OF TEST REPORTS (CHANGE HISTORY)	30

Table of Annex

Annex No.	Contents	Reference Description	Total Pages
Annex 1	Test results	CETECOM_TR18-1-0210201T03a-A1	21
Annex 2	External photographs of EUT	CETECOM_TR18-1-0210201T03a-A2	8
Annex 3	Test set-up photographs	CETECOM_TR18-1-0210201T03a-A3	6

The listed attachments are an integral part of this report.

1. Summary of test results

The test results apply exclusively to the test samples as presented in this Report. The CETECOM GmbH does not assume responsibility for any conclusions and generalizations taken in conjunction with other specimens or samples of the type of the item presented to tests.

The test results apply exclusively to the test samples as presented in this report. The CETECOM GmbH does not assume responsibility for any conclusions and generalizations taken in conjunction with other specimens or samples of the type of the item presented to tests. Also we refer on special conditions which the applicant should fulfill according FCC: §2.927 to §2.948 & ISSED: RSP-100, Issue 11, special focus regarding modification of the equipment and availability of sample equipment for market surveillance tests.

The presented Equipment Under Test (in this report, hereinafter referred as EUT) integrates a Proprietary 2.4 GHz RF Transceiver (Hopping Mode). The module is certified and obtained FCC ID: SSVNAEPI02 and ISSED: 5669B-NAEPI02.

Following test cases have been performed to show compliance with valid Part 15.205/15.209/15.247 of the FCC CFR Title 47 Rules, Edition 4th November 2016 & ISSED RSS-247 Issue 2/ RSS-Gen Issue 5 standards.

1.1. Tests overview of US (FCC) and Canada ISSED(RSS) Standards

Test cases	Port	References and Limits			EUT set-up	EUT op. mode	Result
		FCC Standard	RSS Section	Test limit			
TX-Mode							
20 dB bandwidth	Antenna terminal (conducted)	§15.247 (a)(1)	RSS-247, Issue 2: Chapter 5.1 a (1)	At least 25 kHz or 2/3 of 20 dB bandwidth	2	1 + 2	Remark 1)
Channel carrier frequency separation			RSS-247, Issue 2: Chapter 5.1 b		2	2	
99% occupied bandwidth	Antenna terminal (conducted)	2.1049(h)	RSS-Gen, Issue 5: Chapter 6.7	99% Power bandwidth	2	1	Remark 1)
Number of Hopping Channels	Antenna terminal (conducted)	§15.247 (a)(1) (iii)	RSS-247, Issue 2: Chapter 5.1 d	At least 15 Hopping Channels	2	2	Remark 1)
Channel average Occupancy time and number of channels	Antenna terminal (conducted)	§15.247 (a)(1) (iii)	RSS-247, Issue 2: Chapter 5.1 d	0.4 seconds	2	2	Pass
Transmitter Peak output power	Antenna terminal (conducted)	§15.247 (b)(1)	RSS-247, Issue 2: Chapter 5.1 b	< 125 mW or 1W	2	1	Pass
Transmitter frequency stability	Antenna terminal (conducted)	--	RSS-Gen Issue 5, Chapter 6.11	Operation within designated operational band	2	1	Remark 1)
Transmitter Peak output power radiated	Enclosure (radiated)	§15.247 (b)(4)	RSS-247, Issue 2: 5.1 (2)	< 125 mW (EIRP) for antenna with directional gain less 6 dBi	--	--	Pass (calculated)
Out-Of-Band RF- emissions	Antenna terminal (conducted)	§15.247 (d)	RSS-247, Issue 2, Chapter 5.5	20 dBc Conducted Emissions in restricted bands	2	1	Pass
Band-Edge emissions	Enclosure (radiated)	§15.247 (d)	RSS-247, Issue 2, Chapter 5.5 RSS-Gen: Issue 5: §8.9 Table 5+6+7	Emissions in restricted bands must meet the general field strength radiated limits	1	1 + 2	Pass

General field strength emissions + restricted bands	Enclosure + Interconnecting cables (radiated)	§15.247 (d) §15.205 §15.209	RSS-247, Issue 2, Chapter 5.5 RSS-Gen: Issue 5: §8.9 Table 5+6+7	Emissions in restricted bands must meet the general field-strength radiated limits	1	1	Remark 1)
AC-Power Lines Conducted Emissions	AC-Power lines	§15.207	RSS-Gen, Issue 5: Chapter 8.8 Table 4	FCC §15.107 class B limits §15.207 limits ISED: Table 3, Chapter 8.8	1	1	Pass
RX Mode							
RECEIVER Radiated emissions	Enclosure+ Inter-connecting cables (radiated)	§15.109 §15.33 §15.35	RSS-Gen, Issue 5: Chapter 7.3	FCC 15.109 class B limits ISED-limits: Table 2, Chapter 7.1.2	--	--	No tested within this test report*

Remark 1) : Please see information on tested module in TR18-1-0081401T01a-C1

Attestation:

I declare that all measurements were performed by me or under my supervision and that all measurements have been performed and are correct to my best knowledge and belief to Industry Canada standards. All requirements as shown in above table are met in accordance with enumerated standards.

.....
Dipl.-Ing. Niels Jeß
Responsible for test section

.....
B.Sc. Mohamed Ahmed
Responsible for test report

2. Administrative Data

2.1. Identification of the testing laboratory

Company name:	CETECOM GmbH
Address:	Im Teelbruch 116 45219 Essen - Kettwig Germany
Responsible for testing laboratory:	Dipl.-Ing. Niels Jeß
Deputy:	Dipl.-Ing. Volker Briddigkeit

2.2. Test location

2.2.1. Test laboratory "CTC"

Company name:	see chapter 2.1. Identification of the testing laboratory
---------------	---

2.3. Organizational items

Responsible for test report and Project leader:	B.Sc. Mohamed Ahmed
Receipt of EUT:	2018-06-20
Date(s) of test:	2018-12-03 o 2019-01-03
Date of report:	2019-02-20

Version of template:	13.02

2.4. Applicant's details

Applicant's name:	Miele & Cie. KG
Address:	Carl-Miele-Platz 1 59302 Oelde Germany
Contact:	Mr. Andreas Fabrizius

2.5. Manufacturer's details

Manufacturer's name:	see applicant's details
Address:	see applicant's details

3. Equipment under test (EUT)

3.1. Certification data of main EUT declared by applicant

Module	EPI7684 built inside Host EUT A
Module Type	Transceiver
FCC Certification	
FCC ID	SSVNAEPI02
ISED Certification	
ISED	5669B
PMN	EPI7684
UPN	NAEPI02
HVIN	10478824
FVIN	4726

3.2. Technical data of EUT declared by applicant

Module	EPI7684		
Module Type	Transceiver		
Main Function	Proprietary 2.4 GHz RF Transceiver (Hopping Mode)		
Frequency Band	2.4 GHz ISM Band (2400-2483.5 MHz)		
Frequency Channels (Range)	2401.623-2481.284 MHz		
Number of Channels	600 Frequency Hopping Channels		
Channel Bandwidth	11,43kHz		
Channels Power Settings	According to Applicant's declaration (Max. Typical Power Values)		
	Channel	Channel Power	
	Lowest Channel : 2401.623 MHz	Power 20dBm	
	Middle Channel : 2441.380 MHz	Power 20dBm	
	Highest Channel : 2481.280 MHz	Power 0dBm	
Type of Modulation	none		
Emission Designator	N0X		
Hopping Sequence	Pseudo Random Sequence based on applicant's information refer to separate document from the costumer		
Antenna Connections	<input checked="" type="checkbox"/> External, separate 1 RF Transceiver Port		
Antenna Details			
Antenna Type	Loop Antenna		
Antenna Ports Number Type	1	2.4 GHz only	
Antenna Gain (Peak)	-11 dBi (According to Applicant's declaration)		
Total Number of Antennas	1		
Test Mode. Settings	PM_SAW Measurement Software		
Other Installed Options	None		
Power Supply	<input checked="" type="checkbox"/> AC power only: 120. V DC using Laboratory Power Supply(set. 1)		
Power Supply	<input checked="" type="checkbox"/> DC power only: 13. V DC + 3 V DC using Laboratory Power Supply (set. 2)		
Special EMI Components	--		
EUT Sample Type	<input type="checkbox"/> Production	<input checked="" type="checkbox"/> Pre-Production	<input type="checkbox"/> Engineering
Firmware	<input type="checkbox"/> for normal use	<input checked="" type="checkbox"/> Special version for test execution (see chapter 3.7)	
FCC / IC labels attached	<input type="checkbox"/> Yes	<input checked="" type="checkbox"/> No	

3.3. EUT: Type, S/N etc. and short descriptions used in this test report

Short description*)	EUT	Type	S/N serial number	HW hardware status	SW software status
EUT A S04	Miele	Oven HR1956-2	153703216	Pre-Production (B0-Series)	Pre-Production (B0-Series)
EUT B S01	EPI7684	Transceiver	0000143-18-08	Pre-Production (B0-Series)	Pre-Production (B0-Series) ID 4726-3801
EUT C S01	EPI7684	Transceiver	0000164-18-08	Pre-Production (B0-Series)	Pre-Production (B0-Series) ID 4726-3801

*) EUT short description is used to simplify the identification of the EUT in this test report.

3.4. Auxiliary Equipment (AE): Type, S/N etc. and short descriptions

AE short description *)	Auxiliary Equipment	Type	S/N serial number	HW hardware status	SW software status
AE 1	DC Power Cable	--	--	--	--
AE 2	Loop Antenna	TBD	10697963	Production	--
AE 3	Wireless Food Probe System	--	10478813	Production	--
AE 4	USB Cable	--	--	--	--
AE 5	Voltcraft VLP 1303 Pro	DC power Supply	E00085	--	--
AE 6	Dell Notebook (ctc522013)	Latitude E6430	GB3WXY1	Intel Core I5	Windows 7 Professional (64bit)

*) AE short description is used to simplify the identification of the auxiliary equipment in this test report.

3.5. EUT set-ups

EUT set-up no.*)	Combination of EUT and AE	Description
set. 1	EUT A + EUT B + AE 2 + AE 3 (+ AE 4 + AE 6) AE 4 and AE 6 was only used for setting the Test Mode	Radiated Measurements and Conducted Emissions
set. 2	EUT C + AE 1 + (+ AE4+ AE 5 + AE 6) AE 4, AE 5 and AE 6 was only used for setting the Test Mode	Conducted Measurements

*) EUT set-up no. is used to simplify the identification of the EUT set-up in this test report.

3.6. EUT operating modes

EUT operating mode no.*)	Description of operating modes	Additional information
op. 1	TX-Fixed Channel (Modulated)- Mode	The EUT was put to Fixed Channel Continuous transmissions mode (Frequency Power Settings) for Lowest Channel : 2401.623 MHz Power 20dBm Middle Channel : 2441.380 MHz Power 20dBm Highest Channel : 2481.280 MHz Power 0dBm
op. 2	TX-Hopping Channels (Modulated)- Mode	The EUT was put to all Channels Hopping (Modulated) Continuous transmissions mode with help of special Test Software.

*) EUT operating mode no. is used to simplify the test report.

3.7. EUT Software Settings

Special Test software was used
Software Name: **PM_SAW-Reader**
Software Version: **v0.2.0.134**
Software Date: **2015**

Freq. settings on the software

Lowest Channel : 2401.750 MHz |
Middle Channel : 2441.517 MHz |
Highest Channel : 2481.417 MHz |

Freq. measured on the Spectrum Analyser.

Lowest Channel : 2401.623 MHz |
Middle Channel : 2441.380 MHz |
Highest Channel : 2481.280 MHz |

4. Description of test system set-up's

4.1. Test system set-up for conducted measurements on antenna port

Conducted RF-Setup 2 (W2 Set-up)

General description:

The EUT's RF-signal is coupled out by a suitable antenna coupling connector (1). The signal is first attenuated (2) then connected to spectrum-analyzer (4) for RF-conducted measurements. The specific attenuation loss is determined prior to the measurement within a set-up attenuation measurement. These are then taken into account by correcting the measurement readings of the spectrum-analyzer.

Schematic:

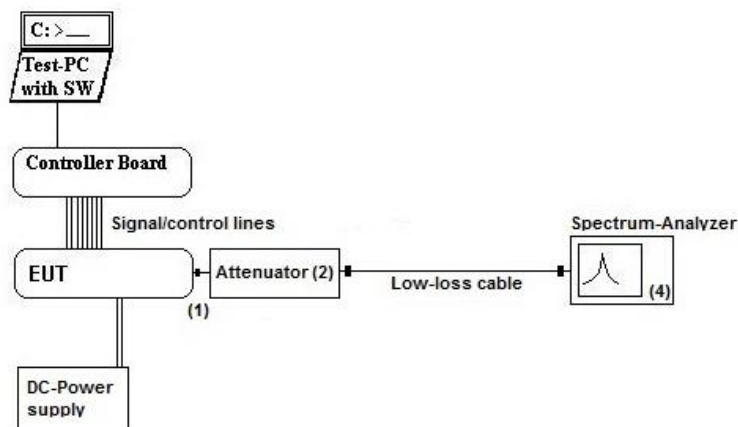

Testing method:

ANSI C63.10:2013

Used Equipment

Passive Elements

Test Equipment

Remark:

20 dB Attenuator

Power Meter OSP-B157

See List of equipment under each test case and chapter 8 for calibration info

Low loss RF-cables

DC-Power Supply

Spectrum-Analyser

Measurement uncertainty

See chapter 5.8

4.2. Test system set-up for AC power-line conducted emission measurements

Specification: ANSI C63.4-2009 chapter 7, ANSI C63.10-2013 chapter 6.2

General Description: The radio frequency voltage conducted back into the AC power line in the frequency range 150 kHz to 30 MHz has to be investigated. Compliance should be tested by measuring the radio frequency voltage between each power line and ground at the power terminals in the stated frequency range. A 50 Ohm / 50 μH line impedance stabilization network (LISN) is used coupling the interface to the measurement equipment. The EUT power input leads are connected through the LISN to the AC-power source. The LISN enclosure is electrically connected to the ground plane. The measuring instrument is connected to the coaxial output of the LISN. Tabletop devices were set-up on a 80 cm height above reference ground plane, floor standing equipment 10 cm raised above ground plane. Measurements have been performed on each phase line and neutral line of the devices AC-power lines. The EUT was power supplied with 120 V/60 Hz. The EUT was tested in the defined operating mode and installed (connected) to accessory equipment according the general description of use given by the applicant.

Schematic:

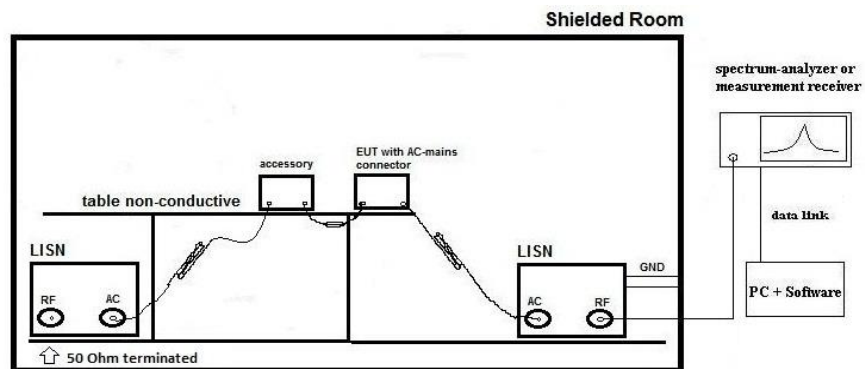

Only schematic view, we refer to figure 6, 7 and 8 of ANSI C63.4-2009 for more details.

Testing method: **Exploratory, preliminary measurements** as a first step, determines the worst-case phase line (neutral or phase) as well as the most critical operating mode of the equipment. A complete frequency-sweep with PK-Detector is performed on each current-carrying conductor.

Final testing for power phases and critical frequencies (Margin to AV- or QP limit lower than 3 dB) as a second step includes measurements with receivers detector set to Quasi-Peak and Average.

Formula:
 $V_C = V_R + C_L$ (1)
 $M = L_T - V_C$ (2)

V_C = measured Voltage –corrected value
 V_R = Receiver reading
 C_L = Cable loss
 M = Margin
 L_T = Limit

Values are in dB, positive margin means value is below limit.

4.3. Test system set-up for radiated magnetic field measurements below 30 MHz

Specification: ANSI C63.10-2013 chapter 6.4 (§6.4.4.2)

General Description: Evaluating the radiated field emissions are done first by an exploratory emission measurement and a final measurement for most critical frequencies determined.

The loop antenna was placed at 1 m height above ground plane and 3 m measurement distance from set-up for investigations. Because of reduced measurement distance, correction data were applied, as stated in chapter “General Limit - Radiated field strength emissions below 30 MHz“. The tests are performed in the semi anechoic room recognized by the regulatory commission.

Schematic:

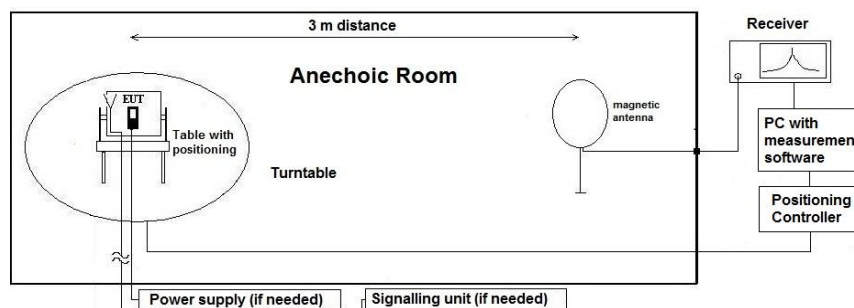

Testing method:

Exploratory, preliminary measurement

The EUT and its associated accessories are placed on a non-conductive position manipulator (tipping device) of 0.8 m height which is placed on the turntable. By rotating the turntable (step 90°, range 0° to 360°) and the EUT itself either on 3-orthogonal axis (portable equipment) or 2-orthogonal axis (defined operational position of EUT), the emission spectrum was recorded. The loop antenna was moved at least to 2-perpendicular axes (antenna vector in direction of EUT and parallel to EUT) in order to maximize the emissions. The results are documented in a diagram. Critical frequencies (low margin to limit) are saved within a data reduction table for further investigations. If various operating modes are supported, further investigations are made to find the worst-case. Also the interconnection cables and equipment position were varied in order to maximize the emissions.

Final measurement on critical frequencies

Based on the exploratory measurements, the most critical frequencies are re-measured by maintaining the EUT's worst-case operation mode, cable position, etc.

First a frequency zoom around the critical frequency is done to locate the frequency more precisely. After this step, for all identified critical frequencies, the maximum peak was determined.

Following parameters were varied: the turntable angle continuously in the range 0 to 360 degree, the EUT itself either over 3-orthogonal axis (not defined usage position) or 2-orthogonal axis (defined usage position).

On the determined worst-case position, a final measurement with necessary bandwidth and detector according standard has been carried out.

Formula:

$$E_C = E_R + AF + C_L + D_F - G_A$$

$$M = L_T - E_C$$

- AF = Antenna factor
- C_L = Cable loss
- D_F = Distance correction factor
- E_C = Electrical field – corrected value
- E_R = Receiver reading
- G_A = Gain of pre-amplifier (if used)
- L_T = Limit
- M = Margin

All units are dB-units, positive margin means value is below limit.

Distance correction:

Reference for applied correction (extrapolating) factors due to reduced measurement distance:

ANSI C63.10:2013, §6.4.4.2 - Equations (2) + (3) + (4)

4.4. Test system set-up for radiated electric field measurement 30 MHz to 1 GHz

Specification: ANSI C63.4-2014 chapter 8.2.3, ANSI C63.10-2013 chapter 6.5

General Description: Evaluating the field emissions have to be done first by an exploratory emissions measurement and a final measurement for most critical frequencies. The tests are performed in a NSA-compliant semi anechoic room (SAR) recognized by the regulatory commissions.

Schematic:

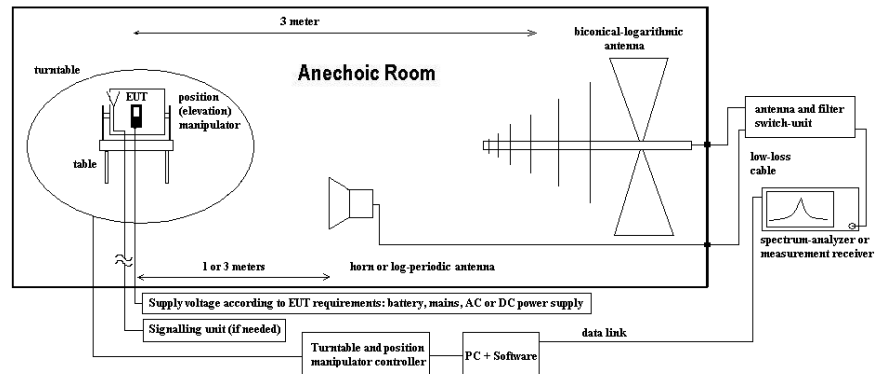

Testing method:

Exploratory, preliminary measurements

The EUT and its associated accessories are placed on a non-conductive position manipulator (tipping device) of 0.8 m height which is placed on the turntable. By rotating the turntable (range 0° to 360°, step 90°) and the EUT itself either on 3-orthogonal axis (portable equipment) or 2-orthogonal axis (defined operational position of EUT) the emission spectrum and its characteristics was recorded with an EMI-receiver, broadband antenna and software.

Measurement antenna: horizontal and vertical, heights: 1,0 m and 1,82 m as worst-case determined by an exploratory emission measurements. The results are documented in a diagram. Critical frequencies (low margin to limit) are saved within a table for further investigations. If various operating modes are supported, further investigations are made to find the worst-case of them. Also the interconnection cables and equipment position were varied in order to maximize the emissions.

Final measurement on critical frequencies

Based on the exploratory measurements, the most critical frequencies are re-measured by maintaining the EUT's worst-case operation mode, cable position, etc. either on 10m OATS or 3m semi-anechoic room.

First a frequency zoom around the critical frequency is done to locate the frequency more precisely. After this step, for all identified critical frequencies, the maximum peak was determined.

Following parameters were varied: the turntable angle continuously in the range 0 to 360 degree, the EUT itself either over 3-orthogonal axis (not defined usage position) or 2-orthogonal axis (defined usage position). The measurement antenna height between 1 m and 4 m.

On the determined worst-case position, a final measurement with necessary bandwidth and detector according standard has been carried out.

Formula:

$$E_C = E_R + AF + C_L + D_F - G_A \quad (1)$$

$$M = L_T - E_C \quad (2)$$

AF = Antenna factor

C_L = Cable loss

D_F = Distance correction factor (if used)

E_C = Electrical field – corrected value

E_R = Receiver reading

G_A = Gain of pre-amplifier (if used)

L_T = Limit

M = Margin

All units are dB-units, positive margin means value is below limit.

4.5. Test system set-up for radiated electric field measurement above 1 GHz

Specification: ANSI C63.4-2014 chapter 8.3

General Description: Evaluating the emissions have to be done first by an exploratory emissions measurement and a final measurement for most critical frequencies. The tests are performed in a CISPR 16-1-4:2010 compliant semi anechoic room (SAR) with the ground covered with absorber recognized by the regulatory commission. The measurement distance was set to 3 meter for frequencies up to 18 GHz and 2 meter above 18 GHz. A logarithmic periodic antenna is used for the frequency range 30 MHz to 1 GHz. Horn antennas are used for frequency range 1 GHz to 40 GHz. The EUT is aligned within 3 dB beam width of the measurement antenna with three orthogonal axis measurements on the EUT.

Schematic:

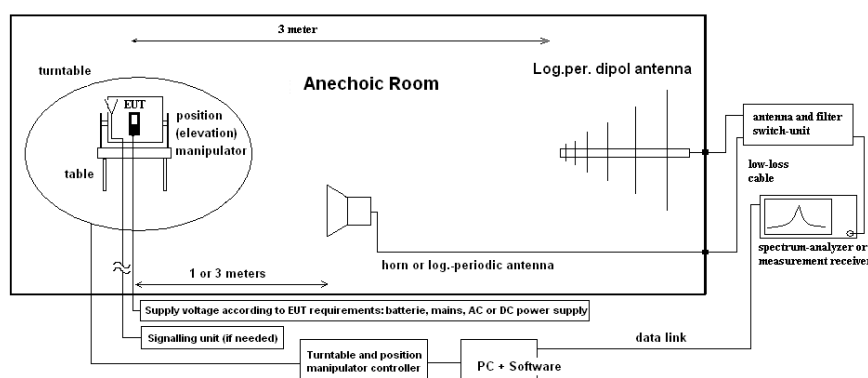

Testing method:

Exploratory, preliminary measurements

The EUT and its associated accessories are placed on the turntable. By rotating the turntable (range 0° to 360°, step 15) the emission spectrum and its characteristics was recorded with an EMI-receiver, broadband antenna and software.

The measurements are performed in horizontal and vertical polarization of the measurement antennas. The results are documented in a diagram. Critical frequencies (low margin to limit) are saved within a table for further investigations. If various operating modes are supported, further investigations are made to find the worst-case of them. Also the interconnection cables and equipment position were varied in order to maximize the emissions.

Final measurement on critical frequencies

Based on the exploratory measurements, the most critical frequencies are re-measured by maintaining the EUT's worst-case operation mode, cable position, etc.

First a frequency zoom around the critical frequency is done to locate the frequency more precisely. After this step, for all identified critical frequencies, the maximum peak was determined. Following parameters were varied: the turntable angle continuously in the range 0 to 360 degree, The measurement antenna height is being varied between 1 m and 4 m and being tilted

On the determined worst-case position, a final measurement with necessary bandwidth and detector according standard has been carried out. On the determined worst-case position, a final measurement with necessary bandwidth and detector according standard has been carried out.

Formula:

$$E_C = E_R + AF + C_L + D_F - G_A \quad (1)$$

$$M = L_T - E_C \quad (2)$$

- E_C = Electrical field – corrected value
- E_R = Receiver reading
- M = Margin
- L_T = Limit
- AF = Antenna factor
- C_L = Cable loss
- D_F = Distance correction factor (if used)
- G_A = Gain of pre-amplifier (if used)

All units are dB-units, positive margin means value is below limit.

5. Measurements

5.1. General Limit - Conducted emissions on AC-Power lines

5.1.1. Test location and equipment

test location	<input checked="" type="checkbox"/> CETECOM Duesseldorf (Chapter 2.2.1)		<input type="checkbox"/> Please see Chapter 2.2.2	
test site	<input type="checkbox"/> 25911 EMI field < 1GHz; SAC5	<input type="checkbox"/> 25912 EMI field > 1GHz; SAC5	<input checked="" type="checkbox"/> 25341 Shielded room laboratory 1	
Receiver	<input type="checkbox"/> 25311 ESU 40	<input checked="" type="checkbox"/> 25370 ESR 7	<input type="checkbox"/> 25235 ESCS 30	
Antenna	<input type="checkbox"/> 25038 HFH2-Z2	<input type="checkbox"/> 25357 HL562E	<input type="checkbox"/> 25364 HF907	
LISN	<input checked="" type="checkbox"/> 25021 ESH2-Z5	<input type="checkbox"/> 25156 ESH3-Z6	<input type="checkbox"/> 25263 ESH3-Z6	
signalling	<input type="checkbox"/> 25xxx CMU 200	<input type="checkbox"/> 25xxx CMU 200	<input type="checkbox"/> 594 CMW500	<input type="checkbox"/> not used
DC voltage	<input type="checkbox"/> 25036 HP 6267 B			
AC voltage	<input type="checkbox"/> 230 V 50 Hz via Power Supply XANTREX XFR150-18		<input checked="" type="checkbox"/> 120 V 60 Hz via EM Test DPA 503N	

5.1.2. Requirements

FCC	<input type="checkbox"/> Part 15 Subpart B, §15.107 (a) Class B <input checked="" type="checkbox"/> Part 15 Subpart C, §15.207									
ISED	<input checked="" type="checkbox"/> RSS-Gen, Issue 4 Chapter 8.8, Table 3 <input type="checkbox"/> ICES-003, Issue 6 Section 6.1 Class B Table 2									
ANSI	<input type="checkbox"/> C63.4-2014 <input checked="" type="checkbox"/> C63.10-2009									
Limit	Frequency [MHz]	<input checked="" type="checkbox"/> Conducted limit Class B								
		<table border="1" style="width:100%; text-align:center;"> <tr> <th>QUASI-Peak [dBµV]</th> <th>AVERAGE [dBµV]</th> </tr> <tr> <td>0.15 – 0.5</td> <td>66 to 56*</td> </tr> <tr> <td>0.5 – 5</td> <td>56</td> </tr> <tr> <td>5 – 30</td> <td>60</td> </tr> </table>	QUASI-Peak [dBµV]	AVERAGE [dBµV]	0.15 – 0.5	66 to 56*	0.5 – 5	56	5 – 30	60
	QUASI-Peak [dBµV]	AVERAGE [dBµV]								
	0.15 – 0.5	66 to 56*								
0.5 – 5	56									
5 – 30	60									
0.15 – 0.5	66 to 56*									
0.5 – 5	56									
5 – 30	60									
Remark: * decreases with the logarithm of the frequency										

5.1.3. Test condition and test set-up

Signal link to test system (if used):	<input checked="" type="checkbox"/> air link	<input type="checkbox"/> cable connection	<input type="checkbox"/> none
EUT-grounding	<input type="checkbox"/> none	<input checked="" type="checkbox"/> with power supply	<input type="checkbox"/> additional connection
Equipment set up	<input checked="" type="checkbox"/> table top (40 cm distance to reference ground plane (wall))		<input type="checkbox"/> floor standing EUT stands isolated on reference ground plane (floor)
Climatic conditions	Temperature: (22±3°C)		Rel. humidity: (40±20)%
EMI-Receiver or Analyzer settings	Scan data	<input type="checkbox"/> 9 – 150 kHz, RBW = 200 Hz, Step = 61 Hz <input checked="" type="checkbox"/> 150 kHz – 30 MHz RBW = 9 kHz, Step = 4 kHz <input type="checkbox"/> other:	
	Scan-Mode	6 dB EMI-Receiver Mode	
	Pre-measurement Final measurement	Peak detector, Repetitive-Scan, max-hold, sweep-time 50 µs per frequency point Average & Quasi-peak detector at critical frequencies	
General measurement procedures	Please see chapter "Test system set-up for AC power line conducted emissions measurements"		

5.1.4. AC-Power Lines Conducted Emissions Results

Set-up no.: 1			EUT OP-mode no.: 2	
Diagram-No.	Used Detector	Power line	Mode Details	Result
1.01	<input checked="" type="checkbox"/> Peak (pre-scan) <input type="checkbox"/> CAV (final) <input checked="" type="checkbox"/> QP (final)	L1/ L2 / N	Normal Hopping Mode	Pass
Remark 1: For further details please refer → Annex 1: Test results CETECOM_TR18-1-0210101T01a-A1				

5.2. RF-Parameter – RF Power conducted

5.2.1. Test location and equipment (for reference numbers please see chapter 'List of test equipment')

test location	<input checked="" type="checkbox"/> CETECOM Essen (Chapter. 2.2.1)	<input type="checkbox"/> 443 System CTC-FAR-EMI-	<input type="checkbox"/> Please see Chapter. 2.2.3
test site	<input type="checkbox"/> 441 EMI SAR	<input type="checkbox"/> 487 SAR NSA	<input type="checkbox"/> 337 OATS
receiver	<input type="checkbox"/> 377 ESCS30	<input type="checkbox"/> 001 ESS	<input checked="" type="checkbox"/> 347 Radio.lab.
otherwise	<input type="checkbox"/> 489 ESU 40	<input type="checkbox"/> 620 ESU 26	<input type="checkbox"/>
spectr. analys.	<input type="checkbox"/> 600 NRVD	<input type="checkbox"/> 357 NRV-Z1	<input type="checkbox"/> 693 TS8997
power supply	<input checked="" type="checkbox"/> 683 FSU	<input type="checkbox"/> 120 FSEM	<input type="checkbox"/> 264 FSEK
otherwise	<input type="checkbox"/> 456 EA 3013A	<input type="checkbox"/> 457 EA 3013A	<input type="checkbox"/> 459 EA 2032-50
Supply voltage	<input type="checkbox"/> 230 V 50 Hz via public mains	<input checked="" type="checkbox"/> 13 V DC + 3 V DC see (AE5)	<input type="checkbox"/> 268 EA- 3050
	<input checked="" type="checkbox"/> 613 20 dB Attenuator	<input type="checkbox"/> 248 6 dB Attenuator	<input type="checkbox"/> 529 Power divider
			<input type="checkbox"/> - cable OTA20
			<input type="checkbox"/> 530 10dB Atten
			<input type="checkbox"/> K5 Cable

5.2.2. Requirements:

FCC	<input checked="" type="checkbox"/> §15.247 (b) (1)
ISED	<input checked="" type="checkbox"/> RSS-247, Issue 2. Chapter 5.1 b
ANSI	<input checked="" type="checkbox"/> C63.10-2013 Chapter 6.101

5.2.3. Reference: EUT antenna characteristics:

- Directional Gain < 6 dBi (measured: difference between measured conducted and radiated eirp. power)
- Directional Gain > 6 dBi (measured / applicant's declaration) -> conducted power reduction necessary

5.2.4. EUT settings:

For FHHS-systems hopping mode was switched-off so three fixed modulated channels could be measured. The EUT was instructed to send with 20dBm at Low and Mid frequency and <0dBm at High frequency according applicants instructions. Different modulation characteristics have been checked, e.g. data rates which EUT can operate.

5.2.5. Measurement method:

The measurement was performed in non-hopping transmission mode with the carrier set to lowest, middle and highest channel. The power was also checked for different data rates, modulation scheme or packet types if applicable.

5.2.6. Settings on Spectrum-Analyzer:

Center Frequency	Nominal channel frequency
Span	176 kHz
Resolution Bandwidth (RBW)	30 kHz > 20dB-Bandwidth of the signal
Video Bandwidth (VBW)	3 times the resolution bandwidth = 300kHz
Sweep time	coupled
Detector	Peak, Max hold mode
Sweep Mode	Repetitive mode

5.2.7. Conducted Power Results:

Conducted Output Power Measurements					
Temperature :+21 °C		Voltage Supply 13 V DC - 3 V DC		Setup: 2	Op. Mode: 1
Frequency Hopping OFF					
Channel	Frequency	Max. Peak Output Power (Conducted)		Plot No.	
	[MHz]	[dBm]	[mW]		
Low	2401.62	20.8	120.226	Remark 1	
Mid	2441.38	20	100		
high	2481.28	2.2	1.66		
Conducted Output Power Limits- FCC 15.247		20.97 dBm	125 mW or 1W		
Conducted Output Power Limits - RSS-247, Issue 2					
Remark 1: For further details please refer → Annex 1: Test results - CETECOM_TR18-1-0210101T01a-A1					

5.2.8. Conducted Peak Output Power Verdict: Pass

5.3. RF-Parameter – Duty Cycle

5.3.1. Test location and equipment (for reference numbers please see chapter 'List of test equipment')

test location	<input checked="" type="checkbox"/> CETECOM Essen (Chapter. 2.2.1)		<input type="checkbox"/> 443 System CTC-FAR-EMI-		<input type="checkbox"/> Please see Chapter. 2.2.3	
test site	<input type="checkbox"/> 441 EMI SAR	<input type="checkbox"/> 487 SAR NSA	<input type="checkbox"/> 337 OATS	<input checked="" type="checkbox"/> 347 Radio.lab.	<input type="checkbox"/>	<input type="checkbox"/>
receiver	<input type="checkbox"/> 377 ESCS30	<input type="checkbox"/> 001 ESS	<input type="checkbox"/> 489 ESU 40	<input type="checkbox"/> 620 ESU 26	<input type="checkbox"/>	<input type="checkbox"/>
otherwise	<input type="checkbox"/> 600 NRVD	<input type="checkbox"/> 357 NRV-Z1	<input type="checkbox"/> 693 TS8997			
spectr. analys.	<input checked="" type="checkbox"/> 683 FSU	<input type="checkbox"/> 120 FSEM	<input type="checkbox"/> 264 FSEK	<input type="checkbox"/> 714 FSW 67	<input type="checkbox"/>	<input type="checkbox"/>
power supply	<input type="checkbox"/> 456 EA 3013A	<input type="checkbox"/> 457 EA 3013A	<input type="checkbox"/> 459 EA 2032-50	<input type="checkbox"/> 268 EA- 3050	<input type="checkbox"/> 494 AG6632A	<input type="checkbox"/> 354 NGPE 40
otherwise	<input type="checkbox"/> 613 20 dB Attenuator	<input type="checkbox"/> 248 6 dB Attenuator	<input type="checkbox"/> 529 Power divider	<input type="checkbox"/> - cable OTA20	<input type="checkbox"/> 530 10dB Atten	<input type="checkbox"/> K5 Cable
Supply voltage	<input type="checkbox"/> 230 V 50 Hz via public mains		<input checked="" type="checkbox"/> 13 V DC + 3 V DC (AE5)			

5.3.2. EUT settings

For FHSS-systems hopping mode was switched-on so that occupancy time of Frequency Hopping channels could be measured. The EUT was instructed to send with maximum power (if adjustable) according applicants instructions.

5.3.3. Measurement method:

The measurement was performed with a spectrum analyzer set to ZERO span. The device was set to work within the defined specification with frequency Hopping Mode ON. The spectrum-analyzer was set the MAX-Hold positive peak detector mode. The sweep time set as long as necessary to capture the full signal burst per hopping channel. The burst on-period is captured by setting appropriate markers in the rising and falling edges.

Method of measurement: conducted
 radiated

Calculated with following formulas:

Duty cycle:	$x = \frac{T_{x_{on}}}{T_{x_{on}} + T_{x_{off}}}$	Duty cycle factor [dB]:	$10 \log \left(\frac{1}{x} \right)$
-------------	---	-------------------------	--------------------------------------

- The results were corrected in order to evaluate for worst-case result each time when average values are necessary for example average radiated emissions or similar
 No correction necessary: Duty-Cycle > 98%

5.3.4. Duty Cycle Results:

Duty Cycle Measurements					
Temperature :+21 °C		Voltage Supply 13 V DC + 3 V DC		Setup: 2	Op. Mode: 2
Frequency Hopping ON					
Channel	Single Transmission Time	Repetition Time	Duty Cycle	Duty Cycle	Plot No.
[Number]	[milliseconds]	[milliseconds]		[dB]	Remark 1
low	0,344609	259,134	0,00132985	28,76	
Mid	0,344609	258,173	0,0013348	28,75	
high	0,201923	258,173	0,00078212	31,07	
Remark 1: For further details please refer → Annex 1: CETECOM_TR18-1-0210201T03a-A1					

5.4. General Limit - Radiated field strength emissions below 30 MHz

5.4.1. Test location and equipment

test location	<input checked="" type="checkbox"/> CETECOM Duesseldorf (Chapter 2.2.1)		<input type="checkbox"/> Please see Chapter 2.2.2	
test site	<input checked="" type="checkbox"/> 25911 EMI field < 1GHz; SAC5	<input type="checkbox"/> 25912 EMI field > 1GHz; SAC5	<input type="checkbox"/> 25901 EMI conducted	
Receiver	<input type="checkbox"/> 25311 ESU 40	<input checked="" type="checkbox"/> 25348 ESR 7	<input type="checkbox"/>	
Antenna	<input type="checkbox"/> 25038 HFH2-Z2	<input checked="" type="checkbox"/> 25357 HL562E	<input type="checkbox"/> 25364 HF907	
LISN	<input type="checkbox"/> 25261 ESH2-Z5	<input type="checkbox"/> 25156 ESH3-Z6	<input type="checkbox"/> 25263 ESH3-Z6	
signalling	<input type="checkbox"/> 20547 CMU 200	<input type="checkbox"/> 25xxx CMU 200	<input type="checkbox"/> 20594 CMW500	<input type="checkbox"/> not used
DC voltage	<input type="checkbox"/> 25036 HP 6267 B	<input type="checkbox"/> 100 V	<input type="checkbox"/> 25289 24V via TDK-Lambda Americas Inc.	
AC voltage	<input type="checkbox"/> 230 V 50 Hz via public mains		<input checked="" type="checkbox"/> 25289 120 V 60 Hz via EM Test DPA 503N	

5.4.2. Requirements

FCC	Part 15. Subpart C. §15.205 & §15.209		<input checked="" type="checkbox"/> Part 15.247 (d)	
ISED	RSS-Gen: Issue 5: §8.9 Table 5 RSS-247, Issue 2, Chapter 5.5			
ANSI	C63.10-2013			
Frequency [MHz]	Field strength limit		Distance [m]	Remarks
	[µV/m]	[dBµV/m]		
0.009 – 0.490	2400/f (kHz)	67.6 – 20Log(f) (kHz)	300	Correction factor used due to measurement distance of 3 m
0.490 – 1.705	24000/f (kHz)	87.6 – 20Log(f) (kHz)	30	Correction factor used due to measurement distance of 3 m
1.705 – 30	30	29.5	30	Correction factor used due to measurement distance of 3 m

5.4.3. Test condition and test set-up

Signal link to test system (if used):		<input type="checkbox"/> air link	<input type="checkbox"/> cable connection	<input type="checkbox"/> none
EUT-grounding		<input checked="" type="checkbox"/> none	<input type="checkbox"/> with power supply	<input type="checkbox"/> additional connection
Equipment set up		<input checked="" type="checkbox"/> table top		<input type="checkbox"/> floor standing
Climatic conditions		Temperature: (22±3°C)		Rel. humidity: (40±20)%
EMI-Receiver or Analyzer Settings	Scan data	<input checked="" type="checkbox"/> 9 – 150 kHz RBW/VBW = 200 Hz Scan step = 80 Hz <input checked="" type="checkbox"/> 150 kHz – 30 MHz RBW/VBW = 9 kHz Scan step = 4 kHz <input type="checkbox"/> other:		
	Scan-Mode Detector Mode: Sweep-Time	<input checked="" type="checkbox"/> 6 dB EMI-Receiver Mode <input type="checkbox"/> 3dB Spectrum analyser Mode Peak (pre-measurement) and Quasi-PK/Average (final if applicable) Repetitive-Scan. max-hold Coupled – calibrated display if continuous signal otherwise adapted to EUT's individual transmission duty-cycle		
General measurement procedures		Please see chapter "Test system set-up radiated magnetic field measurements below 30 MHz"		

5.4.4. Radiated Field Strength Emissions – 9 kHz to 30 MHz Results

Radiated Field Strength Emissions – 9 kHz to 30 MHz									
Temperature :+21 °C			Frequency Hopping OFF						
Diagram No. (Remark 1)	Carrier Channel	Channel Power	Set-up no.	OP-mode no.	Other Remarks	Used detector			Verdict
	Range					PK	AV	QP	
2.01	Low	2401.623 20dBm	1	1	--	<input checked="" type="checkbox"/>	<input type="checkbox"/>	<input type="checkbox"/>	Pass
Remark 1: For further details please refer → Annex 1:CETECOM_TR18-1-0210201T03a-A1									

5.4.5. Correction factors due to reduced meas. distance (f< 30 MHz)

The used correction factors when the measurement distance is reduced compared to regulatory measurement distance. are calculated according Extrapolation formulas valid for EUT's with maximum dimension of 0.625xLambda. Formula 2+3+4 as presented in ANSI C63.10. Chapter 6.4.4 are used for the calculations of proper extrapolation factors.

Frequency Range	f [kHz/MHz]	Lambda [m]	Far-Field Point [m]	Distance Limit accord. 15.209 [m]	1st Condition (dmeas < d _{near-field})	2te Condition (Limit distance bigger d _{near-field})	Distance Correction accord. Formula
kHz	9,00E+03	33333,33	5305,17	300	fulfilled	not fulfilled	-80,00
	1,00E+04	30000,00	4774,65		fulfilled	not fulfilled	-80,00
	2,00E+04	15000,00	2387,33		fulfilled	not fulfilled	-80,00
	3,00E+04	10000,00	1591,55		fulfilled	not fulfilled	-80,00
	4,00E+04	7500,00	1193,66		fulfilled	not fulfilled	-80,00
	5,00E+04	6000,00	954,93		fulfilled	not fulfilled	-80,00
	6,00E+04	5000,00	795,78		fulfilled	not fulfilled	-80,00
	7,00E+04	4285,71	682,09		fulfilled	not fulfilled	-80,00
	8,00E+04	3750,00	596,83		fulfilled	not fulfilled	-80,00
	9,00E+04	3333,33	530,52		fulfilled	not fulfilled	-80,00
	1,00E+05	3000,00	477,47		fulfilled	not fulfilled	-80,00
	1,25E+05	2400,00	381,97		fulfilled	not fulfilled	-80,00
	2,00E+05	1500,00	238,73		fulfilled	fulfilled	-78,02
	3,00E+05	1000,00	159,16		fulfilled	fulfilled	-74,49
	4,00E+05	750,00	119,37		fulfilled	fulfilled	-72,00
	4,90E+05	612,24	97,44		fulfilled	fulfilled	-70,23
	5,00E+05	600,00	95,49		fulfilled	not fulfilled	-40,00
	6,00E+05	500,00	79,58		fulfilled	not fulfilled	-40,00
7,00E+05	428,57	68,21	fulfilled	not fulfilled	-40,00		
8,00E+05	375,00	59,68	fulfilled	not fulfilled	-40,00		
9,00E+05	333,33	53,05	fulfilled	not fulfilled	-40,00		
MHz	1,00	300,00	47,75	30	fulfilled	not fulfilled	-40,00
	1,59	188,50	30,00		fulfilled	not fulfilled	-40,00
	2,00	150,00	23,87		fulfilled	fulfilled	-38,02
	3,00	100,00	15,92		fulfilled	fulfilled	-34,49
	4,00	75,00	11,94		fulfilled	fulfilled	-32,00
	5,00	60,00	9,55		fulfilled	fulfilled	-30,06
	6,00	50,00	7,96		fulfilled	fulfilled	-28,47
	7,00	42,86	6,82		fulfilled	fulfilled	-27,13
	8,00	37,50	5,97		fulfilled	fulfilled	-25,97
	9,00	33,33	5,31		fulfilled	fulfilled	-24,95
	10,00	30,00	4,77		fulfilled	fulfilled	-24,04
	10,60	28,30	4,50		fulfilled	fulfilled	-23,53
	11,00	27,27	4,34		fulfilled	fulfilled	-23,21
	12,00	25,00	3,98		fulfilled	fulfilled	-22,45
	13,56	22,12	3,52		fulfilled	fulfilled	-21,39
	15,00	20,00	3,18		fulfilled	fulfilled	-20,51
	15,92	18,85	3,00		fulfilled	fulfilled	-20,00
	17,00	17,65	2,81		not fulfilled	fulfilled	-20,00
	18,00	16,67	2,65		not fulfilled	fulfilled	-20,00
	20,00	15,00	2,39		not fulfilled	fulfilled	-20,00
	21,00	14,29	2,27		not fulfilled	fulfilled	-20,00
23,00	13,04	2,08	not fulfilled	fulfilled	-20,00		
25,00	12,00	1,91	not fulfilled	fulfilled	-20,00		
27,00	11,11	1,77	not fulfilled	fulfilled	-20,00		
29,00	10,34	1,65	not fulfilled	fulfilled	-20,00		
30,00	10,00	1,59	not fulfilled	fulfilled	-20,00		

5.5. General Limit - Radiated field strength emissions. 30 MHz - 1 GHz

5.5.1. Test location and equipment

test location	<input checked="" type="checkbox"/> CETECOM Duesseldorf (Chapter 2.2.1)		<input type="checkbox"/> Please see Chapter 2.2.2	
test site	<input checked="" type="checkbox"/> 25911 EMI field < 1GHz; SAC5	<input type="checkbox"/> 25912 EMI field > 1GHz; SAC5	<input type="checkbox"/> 25901 EMI conducted	
Receiver	<input type="checkbox"/> 25311 ESU 40	<input checked="" type="checkbox"/> 25348 ESR 7	<input type="checkbox"/>	
Antenna	<input type="checkbox"/> 25038 HFH2-Z2	<input checked="" type="checkbox"/> 25357 HL562E	<input type="checkbox"/> 25364 HF907	
LISN	<input type="checkbox"/> 25261 ESH2-Z5	<input type="checkbox"/> 25156 ESH3-Z6	<input type="checkbox"/> 25263 ESH3-Z6	
signalling	<input type="checkbox"/> 20547 CMU 200	<input type="checkbox"/> 25xxx CMU 200	<input type="checkbox"/> 20594 CMW500	<input type="checkbox"/> not used
DC voltage	<input type="checkbox"/> 25036 HP 6267 B	<input type="checkbox"/> 100 V	<input type="checkbox"/> 25289 24V via TDK-Lambda Americas Inc.	
AC voltage	<input type="checkbox"/> 230 V 50 Hz via public mains		<input checked="" type="checkbox"/> 25289 120 V 60 Hz via EM Test DPA 503N	

5.5.2. Requirements/Limits

FCC		<input type="checkbox"/> Part 15 Subpart B. §15.109. class B <input checked="" type="checkbox"/> Part 15 Subpart C. §15.209 @ frequencies defined in §15.205 <input checked="" type="checkbox"/> Part 15.247 (d)	
ISED		<input checked="" type="checkbox"/> RSS-Gen.. Issue 5. Chapter 8.9. Table 4+6 (licence-exempt radio apparatus) <input type="checkbox"/> RSS-Gen.. Issue 5. Chapter 7.1.2. Table 2 (receiver) <input type="checkbox"/> ICES-003. Issue 6. Table 5 (Class B) <input checked="" type="checkbox"/> RSS-247. Issue 2. Chapter 5	
ANSI		<input type="checkbox"/> C63.4-2014 <input checked="" type="checkbox"/> C63.10-2013	
Limit	Frequency [MHz]	Radiated emissions limits. 3 meters	
		QUASI Peak [μ V/m]	QUASI-Peak [dB μ V/m]
	30 - 88	100	40.0
	88 - 216	150	43.5
	216 - 960	200	46.0
	above 960	500	54.0

5.5.3. Restricted bands of operation (FCC §15.205/ RSS-Gen. Issue 4 Chapter 8.9. Table 4)

MHz	MHz	MHz	GHz
0.090-0.110	16.42-16.423	399.9-410	4.5-5.15
0.495-0.505	16.69475-16.69525	608-614	5.35-5.46
2.1735-2.1905	16.80425-16.80475	960-1240	7.25-7.75
4.125-4.128	25.5-25.67	1300-1427	8.025-8.5
4.20725-4.20775	37.5-38.25	1645.5-1646.5	9.3-9.5
6.215-6.218	73-74.6	1660-1710	10.6-12.7
6.26775-6.26825	74.8-75.2	1718.8-1722.2	13.25-13.4
6.31175-6.31225	108-121.94	2200-2300	14.47-14.5
8.291-8.294	123-138	2310-2390	15.35-16.2
8.362-8.366	149.9-150.05	2483.5-2500	17.7-21.4
8.37625-8.38675	156.52475-156.52525	2690-2900	22.01-23.12
8.41425-8.41475	156.7-156.9	3260-3267	23.6-24.0
12.29-12.293	162.0125-167.17	3332-3339	31.2-31.8
12.51975-12.52025	167.72-173.2	3345.8-3358	36.43-36.5
12.57675-12.57725	240-285	3600-4400	--
13.36-13.41	322-335.4	--	--
Remark: only spurious emissions are allowed within these frequency bands not exceeding the limits per §15.209			

5.5.4. Test condition and measurement test set-up

Signal link to test system (if used):		<input type="checkbox"/> air link	<input type="checkbox"/> cable connection	<input type="checkbox"/> none
EUT-grounding		<input type="checkbox"/> none	<input type="checkbox"/> with power supply	<input type="checkbox"/> additional connection
Equipment set up		<input checked="" type="checkbox"/> table top 0.8m height		<input type="checkbox"/> floor standing
Climatic conditions		Temperature: (22±3°C)		Rel. humidity: (40±20)%
EMI-Receiver (Analyzer) Settings	Scan frequency range:	<input checked="" type="checkbox"/> 30 – 1000 MHz <input type="checkbox"/> other:		
	Scan-Mode	<input checked="" type="checkbox"/> 6 dB EMI-Receiver Mode <input type="checkbox"/> 3 dB spectrum analyser mode		
	Detector	Peak / Quasi-peak		
	RBW/VBW	100 kHz/300 kHz		
	Mode:	Repetitive-Scan. max-hold		
Scan step	80 kHz			
Sweep-Time	Coupled – calibrated display if continuous tx-signal otherwise adapted to EUT's individual duty-cycle			
General measurement procedures		Please see chapter “Test system set-up for electric field measurement in the range 30 MHz to 1 GHz”		

5.5.5. Radiated Field Strength Emissions – 30 MHz to 1 GHz Results

Radiated Field Strength Emissions – 30 MHz to 1 GHz									
Temperature :+21 °C			Frequency Hopping OFF						
Diagram No. (Remark 1)	Carrier Channel	Channel Power	Set-up no.	OP-mode no.	Other Remarks	Used detector			Verdict
	Range					PK	AV	QP	
3.01	Low	2401.623 20dBm	1	1	--	<input checked="" type="checkbox"/>	<input type="checkbox"/>	<input checked="" type="checkbox"/>	Pass
Remark 1: For further details please refer → Annex 1:CETECOM_TR18-1-0210201T03a-A1									

5.6. General Limit - Radiated emissions. above 1 GHz

5.6.1. Test location and equipment

test location	<input checked="" type="checkbox"/> CETECOM Duesseldorf (Chapter 2.2.1)		<input type="checkbox"/> Please see Chapter 2.2.2	
test site	<input checked="" type="checkbox"/> 25911 EMI field < 1GHz; SAC5	<input checked="" type="checkbox"/> 25912 EMI field > 1GHz; SAC5	<input type="checkbox"/> 25901 EMI conducted	
spectr. analys.	<input type="checkbox"/> 25311 ESU 40	<input checked="" type="checkbox"/> 25348 ESR 7	<input checked="" type="checkbox"/> 25387 FSU 26	<input checked="" type="checkbox"/> 714 FSW 67
Antenna	<input checked="" type="checkbox"/> 302 BBHA9170	<input checked="" type="checkbox"/> 25357 HL562E	<input checked="" type="checkbox"/> 25364 HF907	
LISN	<input type="checkbox"/> 25261 ESH2-Z5	<input type="checkbox"/> 25156 ESH3-Z6	<input type="checkbox"/> 25263 ESH3-Z6	
signalling	<input type="checkbox"/> 20547 CMU 200	<input type="checkbox"/> 25xxx CMU 200	<input type="checkbox"/> 20594 CMW500	<input type="checkbox"/> not used
DC voltage	<input type="checkbox"/> 25036 HP 6267 B		<input type="checkbox"/> 25289 24V via TDK-Lambda Americas Inc.	
AC voltage	<input type="checkbox"/> 230 V 50 Hz via public mains		<input checked="" type="checkbox"/> 25289 120 V 60 Hz via EM Test DPA 503N	

5.6.2. Requirements/Limits (CLASS B equipment)

FCC	<input type="checkbox"/> Part 15 Subpart B. §15.109 class B <input checked="" type="checkbox"/> Part 15 Subpart C. §15.209 for frequencies defined in §15.205 <input checked="" type="checkbox"/> Part 15.247 (d)			
ISED	<input checked="" type="checkbox"/> RSS-Gen.. Issue 5. Chapter 8.9. Table 4+6 (transmitter licence exempt) <input type="checkbox"/> RSS-Gen.. Issue 5. Chapter 8.9. Table 2 (receiver) <input type="checkbox"/> ICES-003. Issue 6. Chapter 6.2.2. Table 7 (class B) <input checked="" type="checkbox"/> RSS-247. Issue 2. Chapter 5			
ANSI	<input type="checkbox"/> C63.4-2014 <input checked="" type="checkbox"/> C63.10-2013			
Frequency [MHz]	Limits			
	AV [µV/m]	AV [dBµV/m]	Peak [µV/m]	Peak [dBµV/m] or [dBm/MHz]
above 1 GHz for frequencies as defined in §15.205 or RSS-Gen.. Issue 4. §8.10 - Table 6	500	54.0	5000	74.0 dBµV/m

5.6.3. Test condition and measurement test set-up

Signal link to test system (if used):	<input type="checkbox"/> air link	<input type="checkbox"/> cable connection	<input type="checkbox"/> none
EUT-grounding	<input checked="" type="checkbox"/> none	<input type="checkbox"/> with power supply	<input type="checkbox"/> additional connection
Equipment set up	<input checked="" type="checkbox"/> table top 1.5m height		<input type="checkbox"/> floor standing
Climatic conditions	Temperature: (22±3°C)		Rel. humidity: (40±20)%
Spectrum-Analyzer settings	Scan frequency range: <input checked="" type="checkbox"/> 1 – 18 GHz <input type="checkbox"/> 18 – 25 GHz <input type="checkbox"/> 18 – 40 GHz <input type="checkbox"/> other: <input checked="" type="checkbox"/> 6 dB EMI-Receiver Mode <input type="checkbox"/> 3 dB Spectrum analyser Mode Peak and Average 1 MHz / 3 MHz Mode: Repetitive-Scan. max-hold 400 kHz Sweep-Time Coupled – calibrated display if CW signal otherwise adapted to EUT's individual duty-cycle		
General measurement procedures	Please see chapter "Test system set-up for radiated electric field measurements above 1 GHz"		

5.6.4. Radiated Field Strength Emissions – 1 GHz to 18 GHz Results

Radiated Field Strength Emissions – 1 GHz to 18 GHz									
Temperature :+21 °C		Frequency Hopping OFF							
Diagram No. (Remark 1)	Carrier Channel	Channel Data Rate Power	Set-up no.	OP-mode no.	Other Remarks	Used detector			Verdict
						PK	AV	QP	
4.01a	Low	2401.623 20dBm	1	1	1GHz – 3GHz	<input checked="" type="checkbox"/>	<input checked="" type="checkbox"/>	<input type="checkbox"/>	Pass
4.01b	Low	2441.385 20dBm	1	1	3GHz – 18GHz	<input checked="" type="checkbox"/>	<input checked="" type="checkbox"/>	<input type="checkbox"/>	Pass
Remark 1: For further details please refer → Annex 1: Test results - CETECOM_TR18-1-0210201T03a-A1									

5.6.5. Radiated Field Strength Emissions – 18 GHz to 25 GHz Results

Radiated Field Strength Emissions – 18 GHz to 26.5 GHz									
Temperature :+21 °C		Frequency Hopping OFF							
Diagram No. (Remark 1)	Carrier Channel	Channel Data Rate Power	Set-up no.	OP-mode no.	Other Remarks	Used detector			Verdict
						PK	AV	QP	
4.01c	Low	2401.623 20dBm	1	1	18GHz – 26.5GHz	<input checked="" type="checkbox"/>	<input checked="" type="checkbox"/>	<input type="checkbox"/>	Pass
Remark 1: For further details please refer → Annex 1: Test results - CETECOM_TR18-1-0210201T03a-A1									

5.7. RF-Parameter - Radiated Band Edge compliance measurements

5.7.1. Test location and equipment

test location	<input checked="" type="checkbox"/> CETECOM Duesseldorf (Chapter 2.2.1)			<input type="checkbox"/> Please see Chapter 2.2.2	
test site	<input checked="" type="checkbox"/> 25911 EMI field < 1GHz; SAC5	<input checked="" type="checkbox"/> 25912 EMI field > 1GHz; SAC5	<input type="checkbox"/> 25901 EMI conducted		
spectr. analys.	<input type="checkbox"/> 25311 ESU 40	<input checked="" type="checkbox"/> 25348 ESR 7	<input checked="" type="checkbox"/> 25387 FSU 26	<input checked="" type="checkbox"/> 714 FSW 67	
Antenna	<input checked="" type="checkbox"/> 302 BBHA9170	<input checked="" type="checkbox"/> 25357 HL562E	<input checked="" type="checkbox"/> 25364 HF907		
LISN	<input type="checkbox"/> 25261 ESH2-Z5	<input type="checkbox"/> 25156 ESH3-Z6	<input type="checkbox"/> 25263 ESH3-Z6		
signalling	<input type="checkbox"/> 20547 CMU 200	<input type="checkbox"/> 25xxx CMU 200	<input type="checkbox"/> 20594 CMW500	<input type="checkbox"/> not used	
DC voltage	<input type="checkbox"/> 25036 HP 6267 B		<input type="checkbox"/> 25289 24V via TDK-Lambda Americas Inc.		
AC voltage	<input type="checkbox"/> 230 V 50 Hz via public mains		<input checked="" type="checkbox"/> 25289 120 V 60 Hz via EM Test DPA 503N		

5.7.2. Requirements/Limits

FCC	<input type="checkbox"/> Part 15 Subpart B. §15.109 class B <input type="checkbox"/> Part 15 subpart C. §15.209 @ frequencies defined in §15.205 <input checked="" type="checkbox"/> Part 15.247 (d)
ISED	<input checked="" type="checkbox"/> RSS-247. Issue 2. Chapter 5 <input checked="" type="checkbox"/> RSS-Gen: Issue 5: §8.9 Table 4+5+6
ANSI	<input type="checkbox"/> C63.4-2009 <input type="checkbox"/> C63.4-2014 <input type="checkbox"/> C63.10-2009 <input checked="" type="checkbox"/> C63.10-2013. Chapter 6.10.6

5.7.3. Test condition and measurement test set-up

Signal ink to test system (if used):	<input type="checkbox"/> air link	<input type="checkbox"/> cable connection	<input checked="" type="checkbox"/> none
EUT-grounding	<input checked="" type="checkbox"/> none	<input type="checkbox"/> with power supply	<input type="checkbox"/> additional connection
Equipment set up	<input checked="" type="checkbox"/> table top 1.5m height <input type="checkbox"/> floor standing		
Climatic conditions	Temperature: (22±3°C)		Rel. humidity: (40±20)%
Spectrum-Analyzer settings	Scan frequency range: <input type="checkbox"/> 1 – 18 GHz <input type="checkbox"/> 18 – 25 GHz <input type="checkbox"/> 18 – 40 GHz <input checked="" type="checkbox"/> other: see diagrams Scan-Mode: <input type="checkbox"/> 6 dB EMI-Receiver Mode <input checked="" type="checkbox"/> 3 dB Spectrum analyser Mode Detector: Peak and Average RBW/VBW: Left band-edge: 100kHz/300kHz Right band-edge: 1 MHz / 3 MHz Mode: Repetitive-Scan. max-hold Scan step: 40kHz or 400 kHz Sweep-Time: Coupled – calibrated display if CW signal otherwise adapted to EUT’s individual duty-cycle		
General measurement procedures	Please see chapter “Test system set-up for radiated electric field measurements above 1 GHz” for general measurements procedures in anechoic chamber.		

5.7.4. Measurement Method

For uncritical results where a measurement resolution bandwidth of 1MHz can clearly show the compliance without influencing the results, a field strength measurement was performed to show compliance.

For critical results a Marker-Delta marker method was used for showing compliance to restricted bands. The method is according ANSI C63.10:2013. Chapter 6.10.6 “Marker-Delta method”.. The method consists of three independent steps:

- 1. Step:** Prior to the measurement the fundamental radiated In-Band field strength was performed. The determined value is used as reference value.
- 2. Step:** Second step consist of finding the relative attenuation between the fundamental emission and the maximum local out-of-band emission (within 2 MHz range around the band edge either on the band-edge directly or some modulation product if the level is greater than that on the band-edge) when measured with lower resolution bandwidth.
- 3. Step:** The delta value recorded in step 2 will be subtracted from value recorded in step 1. thus giving the required field strength at the band-edge. This value must fulfil the requirements for radiated spurious emissions in restricted bands in FCC §15.205 or RSS-Gen. Issue 4. Chapter 8.10. Table 6 with the general limits of FCC §15.209 or RSS-Gen. Issue 4 Chapter 8.9. Table 4.

5.7.5. EUT settings

The EUT was set in Hopping OFF as well as in Hopping ON modes with 20dBm at Low and Mid frequency and at <0dBm at High frequency according to applicants instructions. The duty cycle for band edge measurements was set to 100%.

5.7.6. Results: for non-restricted bands near-by

5.7.6.1. Non-restricted bands near-by - limits according FCC §15.247 and RSS-247. Issue 1. Chapter 5.5

Set-up No.:	2
Op. Mode:	1 + 2

Diagramm no.	Channel no.	Restricted band ?	Fundamental Value [dBuV/m]		Peak-Value at Band-Edge [dBuV/m]	Difference [dB]	Limit [dBc]	Margin [dB]	Verdict	Remark:
			Peak-Value	Average-Value						
9.01a	Low	no	102,67	95,5	53,69	48,98	20	28,98	PASS	PWR-VALUE=20dBm used
9.02a	hop	no	103,901	93,57	61,482	42,419	20	22,419	PASS	PWR-VALUE=20dBm used

Remark 1: For further details please refer → Annex 1: Test results - CETECOM_TR18-1-0210201T03a-A1

Remark 2: No Duty-cycle correction factors are necessary

5.7.6.2. Restricted bands near-by

(§15.205 with limits accord. FCC §15.209) and (RSS-Gen. Issue4. Chapter 8.10)

Set-up No.:	2
Op. Mode:	1 + 2

Diagramm no.	Channel no.	Restricted band ?	Fundamental Value [dBuV/m]		Value at Band-Edge [dBuV/m]		Limits [dBuV/m]		Duty-Cycle Correction for AV-detector [dB]	Margin [dB]		Verdict	Remark:
			Peak-Value	Average-Value	Peak-Value	Average-Value	Peak-Value	Average-Value		Peak	Average		
9.01b	high	yes	95,75	95,75	59,8	48,64	74	54	0	14,2	5,36	PASS	PWR-VALUE=0dBm used
9.02b	hop	yes	102,29	90	67,94	48,55	74	54	0	6,06	5,45	PASS	PWR-VALUE=0dBm used

Remark 1: For further details please refer → Annex 1: Test results - CETECOM_TR18-1-0210201T03a-A1

Remark 2: No Duty-cycle correction factors are necessary

5.8. Measurement uncertainties

The reported uncertainties are calculated based on the standard uncertainty multiplied with the appropriate coverage factor **k**, such that a confidence level of approximately 95% is achieved.

For uncertainty determination, each component used in the concrete measurement set-up was taken in account and its contribution to the overall uncertainty according to its statistical distribution calculated.

Following table shows expectable uncertainties for each measurement type performed.

RF-Measurement	Reference	Frequency range	Calculated uncertainty based on a confidence level of 95%						Remarks
Conducted emissions (U _{CISPR})	CISPR 16-2-1	9 kHz - 150 kHz	4.0 dB						-
		150 kHz - 30 MHz	3.6 dB						
Radiated emissions Enclosure	CISPR 16-2-3	30 MHz - 1 GHz	4.2 dB						E-Field
		1 GHz - 18 GHz	5.1 dB						
Disturbance power	CISPR 16-2-2	30 MHz - 300 MHz	-						-
Power Output radiated	-	30 MHz - 4 GHz	3.17 dB						Substitution method
Power Output conducted	-	Set-up No.	Cel-C1	Cel-C2	BT1	W1	W2	--	-
		9 kHz - 12.75 GHz	N/A	0.60	0.7	0.25	N/A	--	
		12.75 - 26.5GHz	N/A	0.82	--	N/A	N/A	--	
Conducted emissions on RF-port	-	9 kHz - 2.8 GHz	0.70	N/A	0.70	N/A	0.69	--	N/A - not applicable
		2.8 GHz - 12.75GHz	1.48	N/A	1.51	N/A	1.43	--	
		12.75 GHz - 18GHz	1.81	N/A	1.83	N/A	1.77	--	
		18 GHz - 26.5GHz	1.83	N/A	1.85	N/A	1.79	--	
Occupied bandwidth	-	9 kHz - 4 GHz	0.1272 ppm (Delta Marker)						Frequency error
			1.0 dB						Power
Emission bandwidth	-	9 kHz - 4 GHz	0.1272 ppm (Delta Marker)						Frequency error
			See above: 0.70 dB						Power
Frequency stability	-	9 kHz - 20 GHz	0.0636 ppm						-
Radiated emissions Enclosure	-	150 kHz - 30 MHz	5.0 dB						Magnetic field E-field Substitution
		30 MHz - 1 GHz	4.2 dB						
		1 GHz - 20 GHz	3.17 dB						

Table: measurement uncertainties, valid for conducted/radiated measurements

6. Abbreviations used in this report

The abbreviations	
ANSI	American National Standards Institute
AV . AVG. CAV	Average detector
EIRP	Equivalent isotropically radiated power. determined within a separate measurement
EGPRS	Enhanced General Packet Radio Service
EUT	Equipment Under Test
FCC	Federal Communications Commission. USA
IC	Industry Canada
n.a.	not applicable
Op-Mode	Operating mode of the equipment
PK	Peak
RBW	resolution bandwidth
RF	Radio frequency
RSS	Radio Standards Specification. Dokuments from Industry Canada
Rx	Receiver
TCH	Traffic channel
Tx	Transmitter
QP	Quasi peak detector
VBW	Video bandwidth
ERP	Effective radiated power

7. Accreditation details of CETECOM's laboratories and test sites

Ref.-No.	Accreditation Certificate	Valid for laboratory area or test site	Accreditation Body
-	D-PL-12047-01-01	All laboratories and test sites of CETECOM GmbH. Essen	DAkKS. Deutsche Akkreditierungsstelle GmbH
337 487 558 348 348	(MRA US-EU 0003)	Radiated Measurements 30 MHz to 1 GHz. 3 m / 10 m (OATS) Radiated Measurements 30 MHz to 1 GHz. 3 m (SAR) Radiated Measurements above 1 GHz. 3 m (FAR) Mains Ports Conducted Interference Measurements Telecommunication Ports Conducted Interference Measurment.	FCC. Federal Communications Commission Laboratory Division. USA
337 487 550 558	3462D-1 3462D-2 3462D-2 3462D-3	Radiated Measurements 30 MHz to 1 GHz. 3 m / 10 m (OATS) Radiated Measurements 30 MHz to 1 GHz. 3 m (SAR) Radiated Measurements 1 GHz to 6 GHz. 3 m (SAR) Radiated Measurements above 1 GHz. 3 m (FAR)	IC. Industry Canada Certification and Engineering Bureau
487 550 348 348	R-2666 G-301 C-2914 T-1967	Radiated Measurements 30 MHz to 1 GHz. 3 m (SAR) Radiated Measurements 1 GHz to 6 GHz. 3 m (SAR) Mains Ports Conducted Interference Measurements Telecommunication Ports Conducted Interference Measurment.	VCCI. Voluntary Control Council for Interference by Information Technology Equipment. Japan

OATS = Open Area Test Site. SAR = Semi Anechoic Room. FAR = Fully Anechoic Room

8. Instruments and Ancillary

The “Ref.-No” in the left column of the following tables allows the clear identification of the laboratory equipment.

8.1. Test software and firmware of equipment

Ref.-No.	Equipment	Type	Serial-No.	Version of Firmware or Software during the test
25358	Semi Anechoic Chamber	Albatross	No. 5	- -
25348	EMI Test Receiver	ESR 7	825132/017	Firm.= 1.21 , OTP=2.0, GRA=2.0
25370	EMI Test Receiver	ESR 7	101715	-
25235	EMI Test Receiver	ESCS 30	100160	Firm.= 2.30, OTP= 02.01, GRA= 02.36
25311	EMI Test Receiver	ESU40	1000-30	Firmware=4.43 SP3, Bios=V5.1-16-3, Spec. =01.00
25403	Ultra-Broadband Antenna	HL562E	100824	- -
25364	Double Rigid Horn Antenna	HF907	102488	- -
25352	Continuous switch Unit	OSP	100123	Firmware=06.06
000	EMI Test Software	EMC 32	-	EMC 32 Version 10
25261	Line Impedance Stabilization Network [2]	ESH2-Z5	871777/041	CISPR 16 compliant
25316	Multifunction AC/DC power Source	Netwave 20	V1227113059	Firmware= 5.03.03
25360	Antenna Tower	BAM 4.5-P	091/17791115	- -
25361	Controller TT & Tower	NCD	202/17791115	Firmware= 0.4.03
25363	Turn Table	TT 4.0-4t	553/17791115	- -
25362	Measurement table	PTT 1.5 x1x0.8	127	- -

8.2. Single instruments and test systems

Ref.-No.	Equipment	Type	Serial-No.	Manufacturer	Interval of calibration	Remark	Cal due
25358	Semi Anechoic Chamber	SAC	No. 5	Albatross	10 Y	-	05 / 2026
25348	EMI Test Receiver	ESR 7	825132/017	Rohde & Schwarz	24 M	-	04 / 2019
25370	EMI Test Receiver	ESR 7	101715	Rohde & Schwarz	24 M	-	06 / 2020
25311	EMI Test Receiver	ESU40	1000-30	Rohde & Schwarz	24 M	-	05 / 2019
25387	Spectrum Analyzer	FSU26	200413	Rohde & Schwarz	12 M	-	04 / 2020
25403	Ultra-Broadband Antenna	HL562E	101021	Rohde & Schwarz	36 M	-	06 / 2021
25364	Double Rigid Horn Antenna	HL562E	102488	Rohde & Schwarz	36 M	-	06 / 2019
25352	Continuous switch Unit	OSP	100123	Rohde & Schwarz	- -	-	- -
000	EMI Test Software	EMC 32	-	Rohde & Schwarz	- -	-	- -
25261	Line Impedance Stabilization Network [1]	ESH2-Z5	871777/041	Rohde & Schwarz	24 M	3	06 / 2020
25316	Multifunction AC/DC power Source	Netwave 20	V1227113059	EM-Test	36 M	1g	06 / 2021
25360	Antenna Tower	BAM 4.5-P	872460/004	Maturo	- .-	-	- -
25361	Controller TT & Tower	NCD	871777/041	Maturo	- .-	-	- -
25363	Turn Table	TT 4.0-4t	V1227113059	Maturo	- .-	-	- -
25362	Measurement table	PTT 1.5 x1x0.8	127	Maturo	- .-	-	- -
714	Signal Analyzer 67GHz	FSW67	104023	Rohde & Schwarz	24 M	-	28.02.2020
683	Spectrum Analyzer	FSU 26	200571	Rohde & Schwarz	12 M	-	30.05.2019
613	Attenuator	R416120000 20dB 10W	Lot. 9828	Radiall	pre-m	2	
347	laboratory site	radio lab.	-	-	-	5	
302	horn antenna 40 GHz (Meas 1)	BBHA9170	155	Schwarzbeck	36 M	-	14.03.2020

8.3. Legend

Note / remarks		Calibrated during system calibration:
	1a	System CTC-SAR-EMS (Ref.-No. 442)
	1b	System-CTC-EMS-Conducted (Ref.-No. 335)
	1c	System CTC-FAR-EMI-RSE (Ref.-No . 443)
	1d	System CTC-SAR-EMI (Ref.-No . 441)
	1e	System CTC-OATS (EMI radiated) (Ref.-No. 337)
	1 f	System CTC-CTIA-OTA (Ref.-No . 420)
	1 g	System CTC-FAR-EMS (Ref.-No . 444)
	2	Calibration or equipment check immediately before measurement
	3	Regulatory maintained equipment for functional check or support purpose
	4	Ancillary equipment without calibration e.g. mechanical equipment or monitoring equipment
	5	Test System

Interval of calibration	12 M	12 month
	24 M	24 month
	36 M	36 month
	24/12 M	Calibration every 24 months, between this every 12 months internal validation
	36/12 M	Calibration every 36 months, between this every 12 months internal validation
	Pre-m	Check before starting the measurement
	-	Without calibration

9. Versions of test reports (change history)

Version	Applied changes	Date of release
--	Initial release	2019-02-20
--	--	--
--	--	--

END OF TEST REPORT