



RF TEST REPORT

Applicant Quectel Wireless Solutions Co., Ltd
FCC ID XMR201808EC25AF
Product LTE Module
Brand Quectel
Model EC25-AF; EC25-AF MINIPCIE
Report No. R1806A0301-R4V1
Issue Date July 31, 2018

TA Technology (Shanghai) Co., Ltd. tested the above equipment in accordance with the requirements in **FCC CFR47 Part 2 (2017)/ FCC CFR 47 Part 90R (2017)**. The test results show that the equipment tested is capable of demonstrating compliance with the requirements as documented in this report.

Xianqing Li

Performed by: Xianqing Li

Kai Xu

Approved by: Kai Xu

TA Technology (Shanghai) Co., Ltd.

No.145, Jintang Rd, Tangzhen Industry Park, Pudong Shanghai, China

TEL: +86-021-50791141/2/3

FAX: +86-021-50791141/2/3-8000



TABLE OF CONTENT

1. Test Laboratory	4
1.1. Notes of the Test Report	4
1.2. Test facility	4
1.3. Testing Location	5
2. General Description of Equipment under Test.....	6
3. Applied Standards	8
4. Test Configuration	9
5. Test Case Results	10
5.1. RF Power Output	10
5.2. Effective Radiated Power	12
5.3. Occupied Bandwidth	15
5.4. Emission Mask	19
5.5. Band Edge Compliance	22
5.6. Peak-to-Average Power Ratio (PAPR)	28
5.7. Frequency Stability	30
5.8. Spurious Emissions at Antenna Terminals	34
5.9. Radiates Spurious Emission	38
6. Main Test Instruments.....	44
ANNEX A: EUT Appearance and Test Setup	45
A.1 EUT Appearance.....	45
A.2 Test Setup.....	49



Summary of measurement results

No.	Test Type	Clause in FCC rules	Verdict
1	RF power output	2.1046/90.635 (b)	PASS
2	Effective Radiated Power	90.542	PASS
3	Occupied Bandwidth	2.1049/ 90.209	PASS
4	Emission Masks	90.210(b)	PASS
5	Band Edges Compliance	2.1051 / 90.543	PASS
6	Peak-to-Average Power Ratio	KDB 971168 D01(5.7)	PASS
7	Frequency Stability	90.539 (c)	PASS
8	Spurious Emissions at Antenna Terminals	90.543 (e)	PASS
9	Radiates Spurious Emission	90.543 (e)	PASS
Date of Testing: June 29, 2018~ July 16, 2018 and July 26, 2018			
Note: PASS: The EUT complies with the essential requirements in the standard. FAIL: The EUT does not comply with the essential requirements in the standard.			



1. Test Laboratory

1.1. Notes of the Test Report

This report shall not be reproduced in full or partial, without the written approval of **TA technology (shanghai) co., Ltd.** The results documented in this report apply only to the tested sample, under the conditions and modes of operation as described herein. Measurement Uncertainties were not taken into account and are published for informational purposes only. This report is written to support regulatory compliance of the applicable standards stated above.

1.2. Test facility

CNAS (accreditation number:L2264)

TA Technology (Shanghai) Co., Ltd. has obtained the accreditation of China National Accreditation Service for Conformity Assessment (CNAS).

FCC (Designation number: CN1179, Test Firm Registration Number: 446626)

TA Technology (Shanghai) Co., Ltd. has been listed on the US Federal Communications Commission list of test facilities recognized to perform electromagnetic emissions measurements.

IC (recognition number is 8510A)

TA Technology (Shanghai) Co., Ltd. has been listed by industry Canada to perform electromagnetic emission measurement.

VCCI (recognition number is C-4595, T-2154, R-4113, G-10766)

TA Technology (Shanghai) Co., Ltd. has been listed by industry Japan to perform electromagnetic emission measurement.

A2LA (Certificate Number: 3857.01)

TA Technology (Shanghai) Co., Ltd. has been listed by American Association for Laboratory Accreditation to perform electromagnetic emission measurement.



1.3. Testing Location

Company: TA Technology (Shanghai) Co., Ltd.
Address: No.145, Jintang Rd, Tangzhen Industry Park, Pudong
City: Shanghai
Post code: 201201
Country: P. R. China
Contact: Xu Kai
Telephone: +86-021-50791141/2/3
Fax: +86-021-50791141/2/3-8000
Website: <http://www.ta-shanghai.com>
E-mail: xukai@ta-shanghai.com

2. General Description of Equipment under Test

Client Information

Applicant	Quectel Wireless Solutions Co., Ltd
Applicant address	7th Floor, Hongye Building, No.1801 Hongmei Road, Xuhui District, Shanghai 200233, China
Manufacturer	Quectel Wireless Solutions Co., Ltd
Manufacturer address	7th Floor, Hongye Building, No.1801 Hongmei Road, Xuhui District, Shanghai 200233, China

General Information

EUT Description			
Model	EC25-AF; EC25-AF MINIPCIE		
Product IMEI	866834040000767		
Hardware Version	R1.0		
Software Version	EC25AFFAR07A02M4G		
Power Supply	External Power Supply		
Antenna Type	The EUT don't have standard Antenna, The Antenna used for testing in this report is the after-market accessory (Dipole Antenna)		
Antenna Gain	4dBi		
Test Mode(s)	LTE Band 14;		
Test Modulation	QPSK 16QAM;		
LTE Category	4		
Maximum E.R.P.	LTE Band 14:	23.48dBm	
Rated Power Supply Voltage	3.8V		
Extreme Voltage	Minimum: 3.3V Maximum: 4.3V		
Extreme Temperature	Lowest: -40°C Highest: +85°C		
Operating Frequency Range(s)	Band	Tx (MHz)	Rx (MHz)
	LTE Band 14	788 ~ 798	758 ~ 768
Note: The information of the EUT is declared by the manufacturer.			

Accessory equipment	
Evaluation Board	RF Cable
RS232-to-USB Cable	Antenna: Dipole Antenna
Headset	DC 5V Adaptor



EC25-AF and EC25-AF MINIPCIE are all LTE modules. They support the same frequency bands, use the same chipset and share the same software & hardware design. The main difference is on the carrier board.

EC25-AF MINIPCIE makes up of EC25-AF module and PCIe transferred board.

The transferred board switches EC25-AF module to follow PCI Express Mini Card 1.2 standard connector protocol. No any other internal changes in EC25-AF module.

Two models are identical in interior structure and components, and just connector interface is different for the marketing requirement.



3. Applied Standards

According to the specifications of the manufacturer, it must comply with the requirements of the following standards:

FCC CFR47 Part 2 (2017)

FCC CFR 47 Part 90R (2017)

ANSI/TIA-603-E (2016)

KDB 971168 D01 Power Meas License Digital Systems v03r01

4. Test Configuration

Radiated measurements are performed by rotating the EUT in three different orthogonal test planes. EUT stand-up position (Z axis), lie-down position (X, Y axis). Receiver antenna polarization (horizontal and vertical), the worst emission was found in position (X axis, horizontal polarization) and the worst case was recorded.

All mode and data rates and positions were investigated.

The following testing in LTE is set based on the maximum RF Output Power.

Test modes are chosen as the worst case configuration below for LTE Band 14

Test items	Bandwidth (MHz)		Modulation		RB			Test Channel		
	5	10	QPSK	16QAM	1	50%	100%	L	M	H
RF power output	O	O	O	O	O	O	O	O	O	O
Effective Isotropic Radiated power	O	O	O	O	O	O	O	O	O	O
Occupied Bandwidth	O	O	O	O	-	-	O	O	O	O
Emission Mask	O	O	O	O	O	-	O	O	-	O
Band Edge Compliance	O	O	O	O	O	-	O	O	-	O
Peak-to-Average Power Ratio	O	O	O	O	-	-	O	O	O	O
Frequency Stability	O	O	O	O	-	-	O	O	-	O
Spurious Emissions at Antenna Terminals	O	O	O	-	O	-	-	O	O	O
Radiates Spurious Emission	O	O	O	-	O	-	-	O	O	O
Note	1. The mark "O" means that this configuration is chosen for testing. 2. The mark "-" means that this configuration is not testing.									

5. Test Case Results

5.1. RF Power Output

Ambient condition

Temperature	Relative humidity	Pressure
23°C ~25°C	45%~50%	101.5kPa

Methods of Measurement

During the process of the testing, The EUT is controlled by the Base Station Simulator to ensure max power transmission and proper modulation.

Test Setup

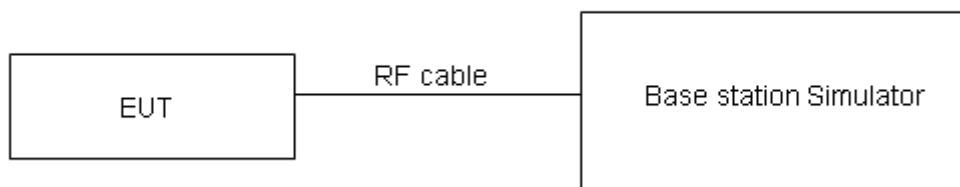

The loss between RF output port of the EUT and the input port of the tester has been taken into consideration.

Limits

Part 90.635 (b) the maximum output power of the transmitter for mobile stations is 100 watts.

Measurement Uncertainty

The assessed measurement uncertainty to ensure 95% confidence level for the normal distribution is with the coverage factor $k = 2$, $U = 0.4$ dB.

Test Results

LTE Band 14				Conducted Power(dBm)		
Bandwidth	Modulation	RB size	RB offset	Channel/Frequency (MHz)		
				23305/790.5	23330/793	23355/795.5
5MHz	QPSK	1	0	23.81	23.59	23.59
		1	13	23.64	23.84	23.75
		1	24	23.68	23.88	23.90
		12	0	22.83	22.83	22.75
		12	6	22.77	22.80	22.71
		12	13	22.82	22.85	22.77
	16QAM	25	0	22.89	22.76	22.73
		1	0	22.50	22.47	22.42
		1	13	22.38	22.61	22.54
		1	24	22.21	22.57	22.22
		12	0	21.65	21.68	21.74
		12	6	21.84	21.59	21.85
		12	13	21.67	21.50	21.65
		25	0	21.77	21.73	21.69
Bandwidth	Modulation	RB size	RB offset	Channel/Frequency (MHz)		
				/	23330/793	/
10MHz	QPSK	1	0	/	23.73	/
		1	25	/	23.85	/
		1	49	/	23.53	/
		25	0	/	22.84	/
		25	13	/	22.78	/
		25	25	/	22.82	/
		50	0	/	22.83	/
	16QAM	1	0	/	22.70	/
		1	25	/	23.38	/
		1	49	/	22.85	/
		25	0	/	21.64	/
		25	13	/	21.80	/
		25	25	/	21.76	/
		50	0	/	21.77	/

5.2. Effective Radiated Power

Ambient condition

Temperature	Relative humidity	Pressure
23°C ~25°C	45%~50%	101.5kPa

Methods of Measurement

The testing follows FCC KDB 971168 v03r01 Section 5.8 and ANSI/TIA-603-E (2016).

- Connect the equipment as illustrated. Mount the equipment with the manufacturer specified antenna in a vertical orientation on a manufacturer specified mounting surface located on a non-conducting rotating platform of a RF anechoic chamber (preferred) or a standard radiation site.
- Key the transmitter, then rotate the EUT 360° azimuthally and record spectrum analyzer power level (LVL) measurements at angular increments that are sufficiently small to permit resolution of all peaks. If a standard radiation test site is used, raise and lower the test antenna to obtain a maximum reading at each angular increment. (Note: several batteries may be needed to offset the effect of battery voltage droop, which should not exceed 5% of the manufactured specified battery voltage during transmission).
- Replace the transmitter under test with a vertically polarized half-wave dipole (or an antenna whose gain is known relative to an ideal half-wave dipole). The center of the antenna should be at the same location as the center of the antenna under test.
- Connect the antenna to a signal generator with a known output power and record the path loss (in dB) as LOSS. If a standard radiation test site is used, raise and lower the test antenna to obtain a maximum reading. $LOSS = \text{Generator Output Power (dBm)} - \text{Analyzer reading (dBm)}$
- Determine the effective radiated output power at each angular position from the readings in steps b) and d) using the following equation: $ERP \text{ (dBm)} = \text{LVL (dBm)} + \text{LOSS (dB)}$
- The maximum ERP is the maximum value determined in the preceding step.
- When calculating ERP, in addition to knowing the antenna radiation and matching characteristics, it is necessary to know the loss values of all elements (e.g. transmission line attenuation, mismatches, filters, combiners) interposed between the point where transmitter output power is measured, and the point where power is applied to the antenna. ERP can then be calculated as follows:
 $EIRP \text{ (dBm)} = \text{Output Power (dBm)} - \text{Losses (dB)} + \text{Antenna Gain (dBd)}$
where: dBd refers to gain relative to an ideal dipole.
 $EIRP \text{ (dBm)} = ERP \text{ (dBm)} + 2.15 \text{ (dB.)}$

The RB allocation refers to section 5.1, using the maximum output power configuration.

Test setup

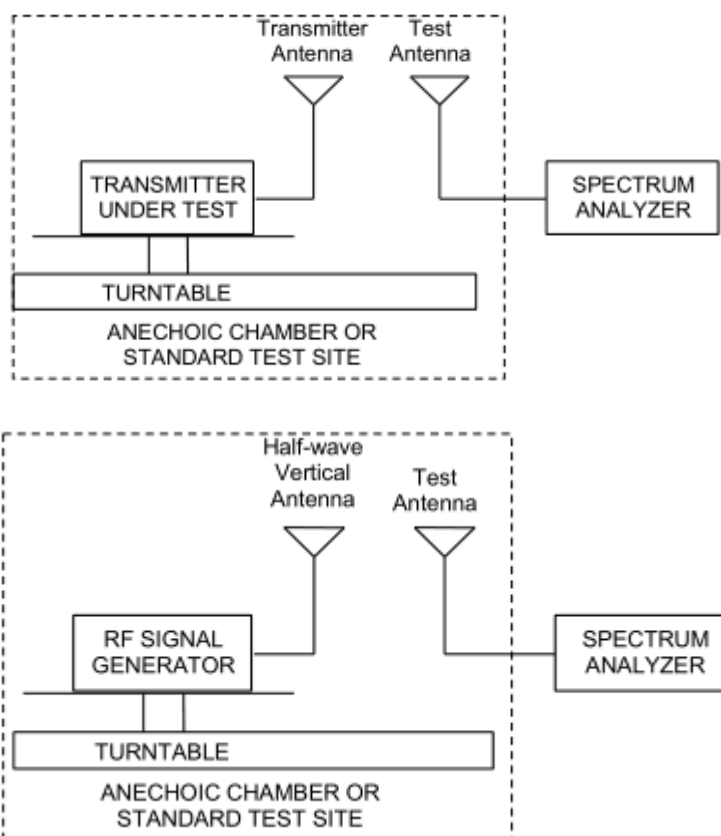

Note: Area side:2.4mX3.6m

The radiated emission was measured in the following position: EUT stand-up position (Z axis), lie-down position (X, Y axis). The worst emission was found in stand-up position (Z axis) and the worst case was recorded.

Limits

90.542(7) Portable stations (hand-held devices) transmitting in the 758-768 MHz band and the 788-798 MHz band are limited to 3 watts ERP.

Measurement Uncertainty

The assessed measurement uncertainty to ensure 95% confidence level for the normal distribution is with the coverage factor $k = 2$, $U = 1.19$ dB

**Test Results:**

The measurement is performed for both of horizontal and vertical antenna Polarization, and only the data of worst mode is recorded in this report.

LTE Band 14						
Bandwidth	Channel	Frequency (MHz)	Polarization	ERP (dBm)	Limit (dBm)	Conclusion
5MHz (QPSK)	Low	790.5	Horizontal	23.23	34.77	Pass
	Mid	793	Horizontal	23.06	34.77	Pass
	High	795.5	Horizontal	23.29	34.77	Pass
10MHz (QPSK)	Mid	793	Horizontal	23.48	34.77	Pass
5MHz (16QAM)	Low	790.5	Horizontal	22.51	34.77	Pass
	Mid	793	Horizontal	22.53	34.77	Pass
	High	795.5	Horizontal	22.61	34.77	Pass
10MHz (16QAM)	Mid	793	Horizontal	23.04	34.77	Pass

Note: 1. EIRP= E.R.P+2.15

5.3. Occupied Bandwidth

Ambient condition

Temperature	Relative humidity	Pressure
23°C ~25°C	45%~50%	101.5kPa

Method of Measurement

The EUT was connected to Spectrum Analyzer and Base Station Simulator via power Splitter. The occupied bandwidth is measured using spectrum analyzer.

RBW is set to 100 kHz, VBW is set to 300 kHz for LTE Band 14 (5MHz).

RBW is set to 300 kHz, VBW is set to 1MHz for LTE Band 14 (10MHz).

99% power and -26dBc occupied bandwidths are recorded. Spectrum analyzer plots are included on the following pages.

Test Setup

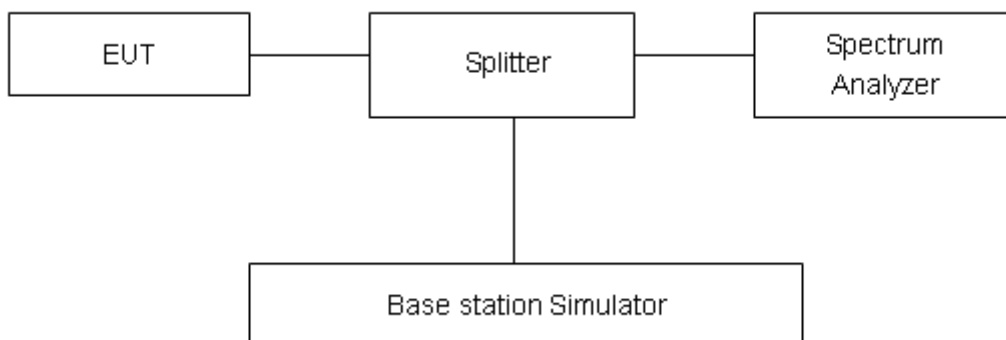

Limits

No specific occupied bandwidth requirements in part 2.1049.

Part 90.209 (a) Each authorization issued to a station licensed under this part will show an emission designator representing the class of emission authorized. The designator will be prefixed by a specified necessary bandwidth. This number does not necessarily indicate the bandwidth occupied by the emission at any instant. In those cases where part 2.202 of this chapter does not provide a formula for the computation of necessary bandwidth, the occupied bandwidth, as defined in part 2 of this chapter, may be used in lieu of the necessary bandwidth.

Measurement Uncertainty

The assessed measurement uncertainty to ensure 95% confidence level for the normal distribution is with the coverage factor $k = 2$, $U = 624\text{Hz}$.



Test Result

LTE Band 14						
RB	Modulation	Bandwidth (MHz)	Channel	Frequency (MHz)	99% Power Bandwidth(MHz)	-26dBc Bandwidth(MHz)
100%	QPSK	5	23305	790.5	4.5134	5.042
			23330	793	4.5283	5.041
			23355	795.5	4.5084	5.030
		10	23330	793	9.0203	10.150
	16QAM	5	23305	790.5	4.5379	5.039
			23330	793	4.5042	5.004
			23355	795.5	4.5339	5.041
		10	23330	793	9.0272	9.992



LTE Band 14 QPSK 5MHz CH-Low



LTE Band 14 16QAM 5MHz CH-Low



LTE Band 14 QPSK 5MHz CH-Middle

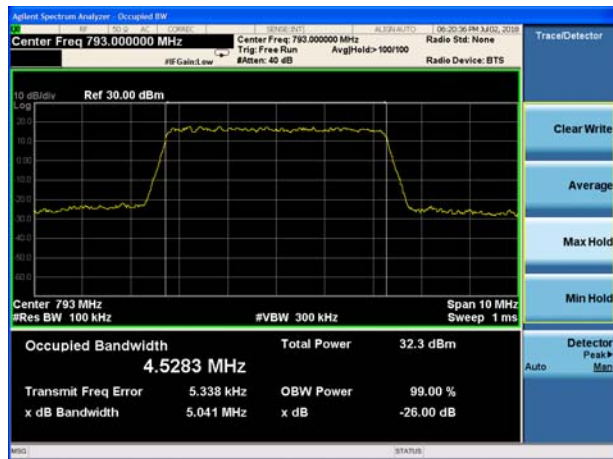

LTE Band 14 16QAM 5MHz CH-Middle

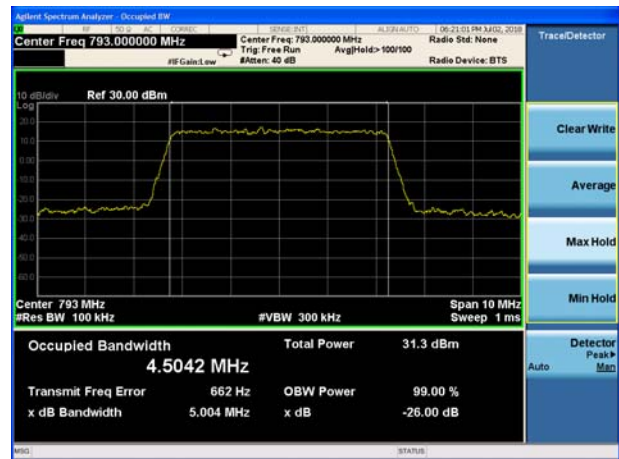

LTE Band 14 QPSK 5MHz CH-High



LTE Band 14 16QAM 5MHz CH-High

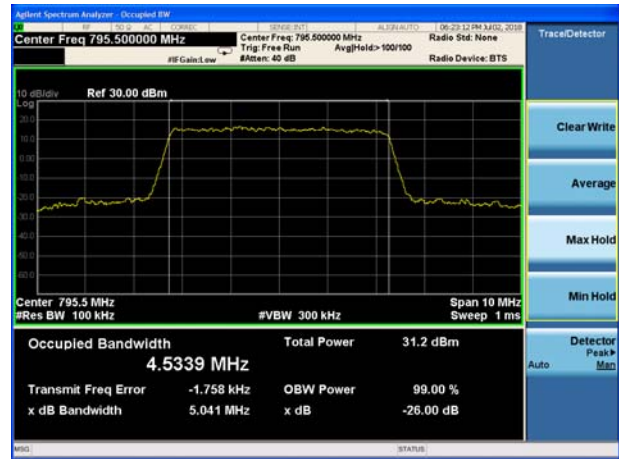

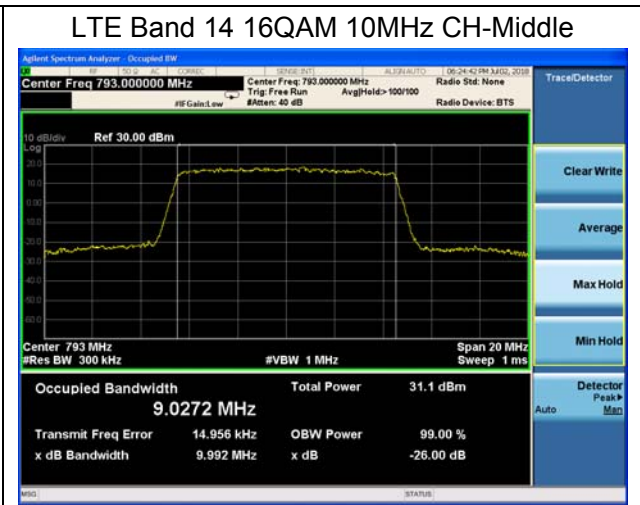
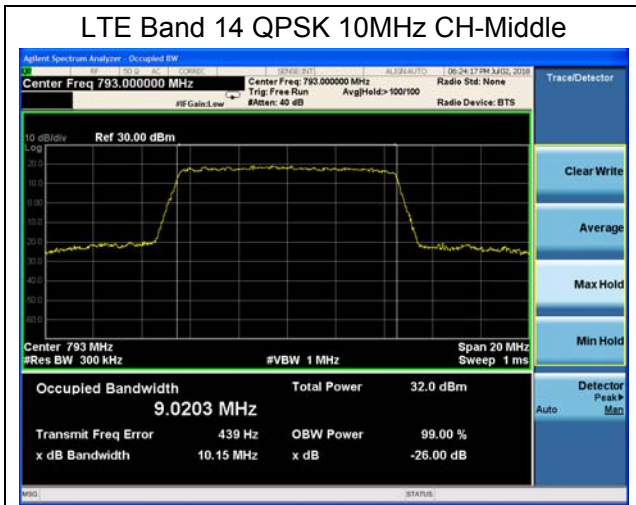

5.4. Emission Mask

Ambient condition

Temperature	Relative humidity
21°C ~25°C	40%~60%

Method of Measurement

The EUT was connected to Spectrum Analyzer and Base Station Simulator via power Splitter. The band edge of the lowest and highest channels were measured. The average detector is used. RBW is set to 51kHz, VBW is set to 160kHz for 5MHz, . RBW is set to 100kHz, VBW is set to 300kHz for 10MHz, Spectrum analyzer plots are included on the following pages.

Test Setup

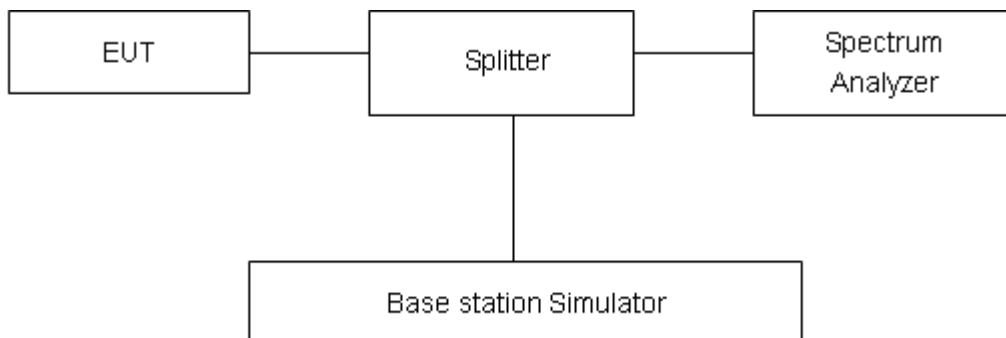

Limits

Rule Part 90.210(b) For transmitters that are equipped with an audio low-pass filter, the power of any emission must be attenuated below the unmodulated carrier power (P) as follows:

- (1) On any frequency removed from the assigned frequency by more than 50 percent, but not more than 100 percent of the authorized bandwidth: At least 25 dB.
- (2) On any frequency removed from the assigned frequency by more than 100 percent, but not more than 250 percent of the authorized bandwidth: At least 35 dB.
- (3) On any frequency removed from the assigned frequency by more than 250 percent of the authorized bandwidth: At least $43 + 10 \log (P)$ dB.

Rule Part 90.1323(a) The power of any emission outside a licensee's frequency band(s) of operation shall be attenuated below the transmitter power (P) within the licensed band(s) of operation, measured in watts, by at least $43 + 10 \log (P)$ dB.

Measurement Uncertainty

The assessed measurement uncertainty to ensure 95% confidence level for the normal distribution is with the coverage factor $k = 1.96$, $U=0.684$ dB.



Test Result:

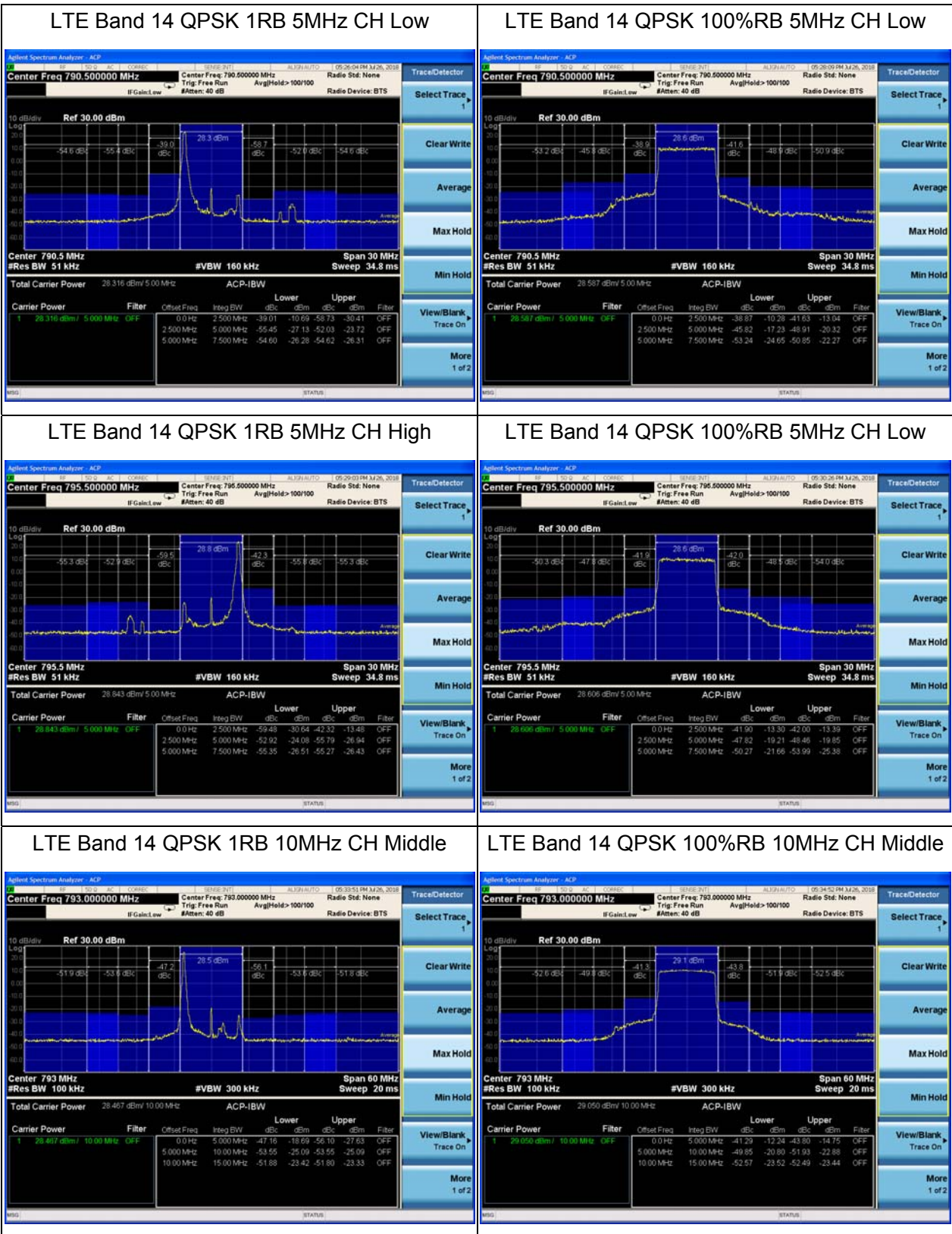

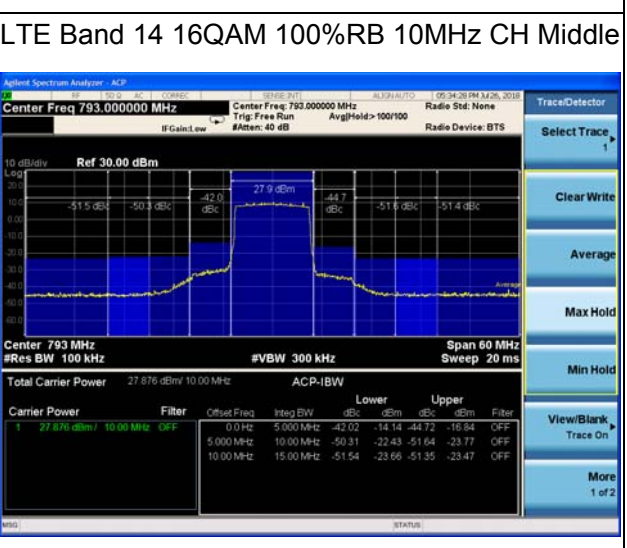
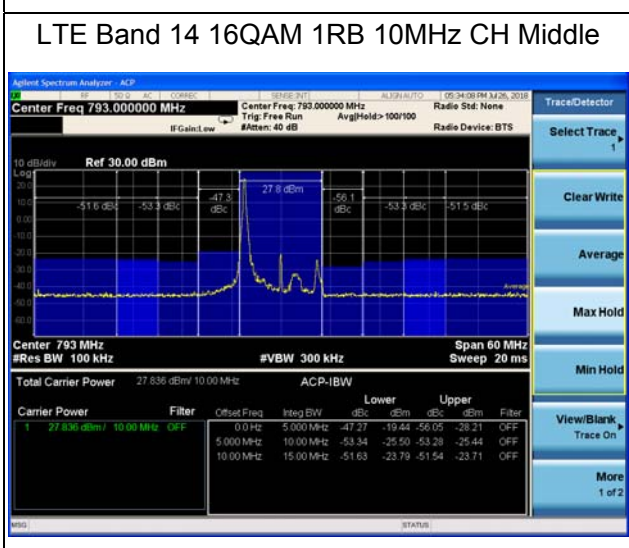
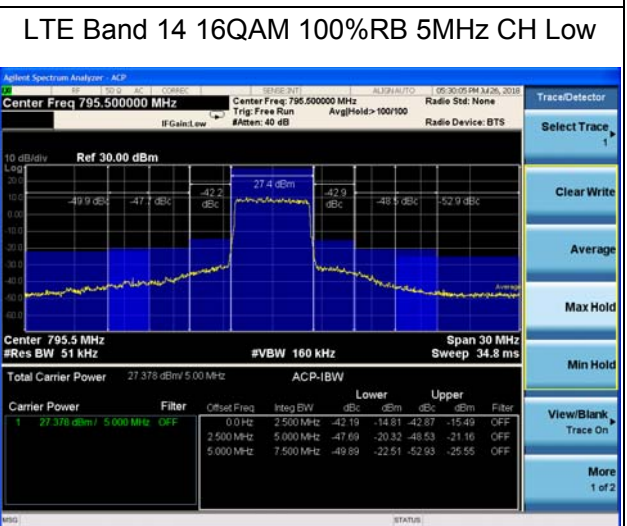
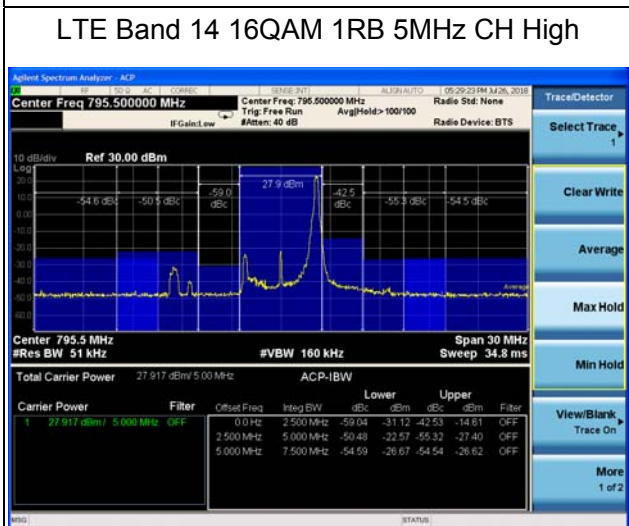
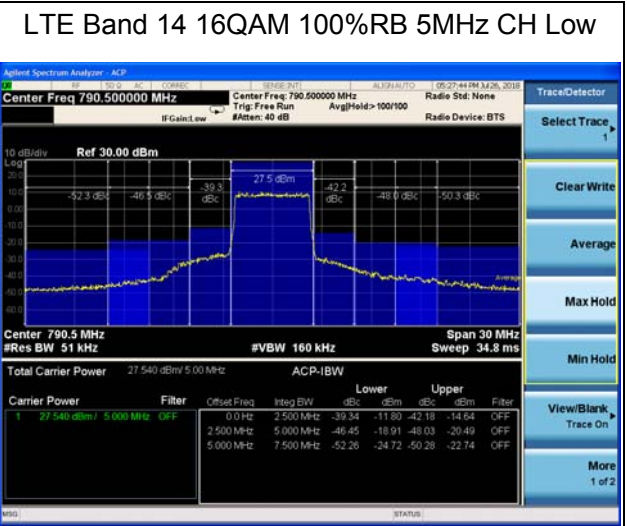
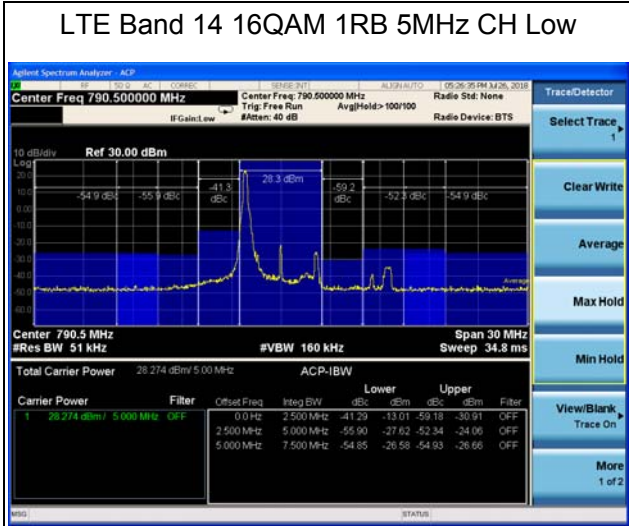

5.5. Band Edge Compliance

Ambient condition

Temperature	Relative humidity	Pressure
23°C ~25°C	45%~50%	101.5kPa

Method of Measurement

The EUT was connected to Spectrum Analyzer and Base Station Simulator via power Splitter. The band edge of the lowest and highest channels were measured.

The testing follows KDB 971168 v03 Section 6.0

1. The EUT was connected to spectrum analyzer and system simulator via a power divider.
2. The band edges of low and high channels for the highest RF powers were measured.
 RBW is set to 10kHz, VBW is set to 30 kHz for LTE Band 14 (769MHz~775MHz).
 RBW is set to 100 kHz, VBW is set to 300kHz for LTE Band14 (775MHz~788MHz).
 RBW is set to 10kHz, VBW is set to 30 kHz for LTE Band 14 (799MHz~805MHz).
3. Set spectrum analyzer with RMS detector.
4. The RF fundamental frequency should be excluded against the limit line in the operating frequency band.
5. Checked that all the results comply with the emission limit line.

Test Setup

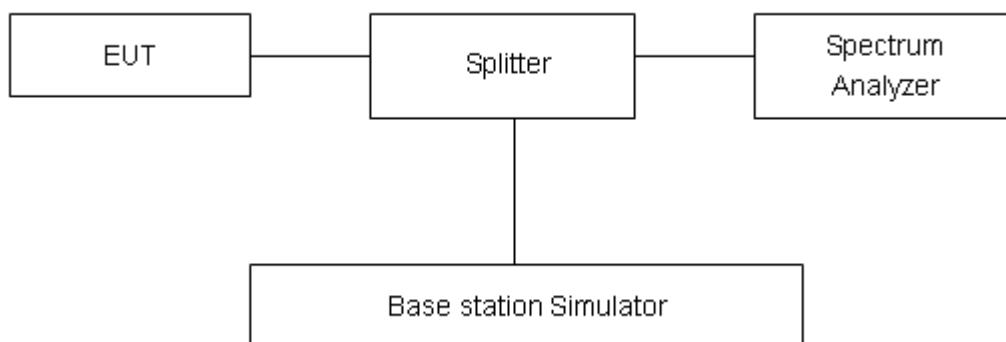

Limits

90.543 Emission limitations (e) For operations in the 758-768 MHz and the 788-798 MHz bands, the power of any emission outside the licensee's frequency band(s) of operation shall be attenuated below the transmitter power (P) within the licensed band(s) of operation, measured in watts, in accordance with the following:

- (1) On all frequencies between 769-775 MHz and 799-805 MHz, by a factor not less than $76 + 10 \log(P)$ dB in a 6.25 kHz band segment, for base and fixed stations.



(2) On all frequencies between 769-775 MHz and 799-805 MHz, by a factor not less than $65 + 10 \log(P)$ dB in a 6.25 kHz band segment, for mobile and portable stations.

(3) On any frequency between 775-788 MHz, above 805 MHz, and below 758 MHz, by at least $43 + 10 \log(P)$ dB.

(4) Compliance with the provisions of paragraphs (e)(1) and (2) of this section is based on the use of measurement instrumentation such that the reading taken with any resolution bandwidth setting should be adjusted to indicate spectral energy in a 6.25 kHz segment.

(5) Compliance with the provisions of paragraph (e)(3) of this section is based on the use of measurement instrumentation employing a resolution bandwidth of 100 kHz or greater. However, in the 100 kHz bands immediately outside and adjacent to the frequency block, a resolution bandwidth of 30 kHz may be employed.

(f) For operations in the 758-775 MHz and 788-805 MHz bands, all emissions including harmonics in the band 1559-1610 MHz shall be limited to -70 dBW/MHz equivalent isotropically radiated power (EIRP) for wideband signals, and -80 dBW EIRP for discrete emissions of less than 700 Hz bandwidth. For the purpose of equipment authorization, a transmitter shall be tested with an antenna that is representative of the type that will be used with the equipment in normal operation.

Measurement Uncertainty

The assessed measurement uncertainty to ensure 95% confidence level for the normal distribution is with the coverage factor $k = 1.96$, $U=0.684$ dB.



Test Result:

LTE Band 14 QPSK 5MHz 1 RB (769MHz ~775MHz)

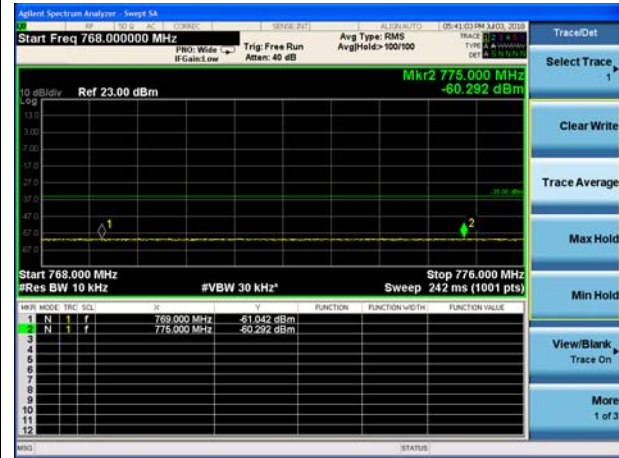

LTE Band 14 QPSK 10MHz 1 RB (769MHz ~775MHz)

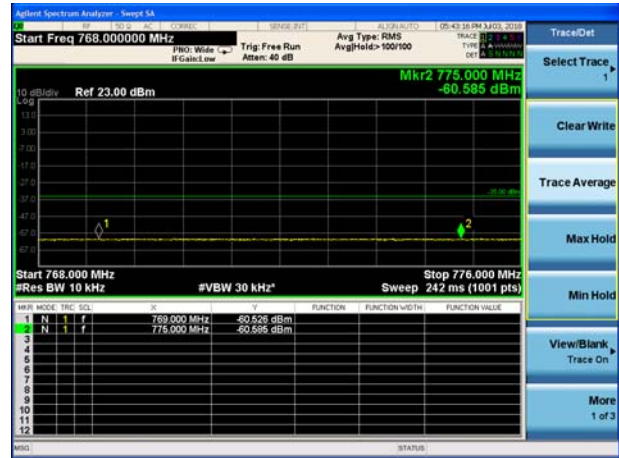

LTE Band 14 QPSK 5MHz 1 RB (775MHz ~788MHz)

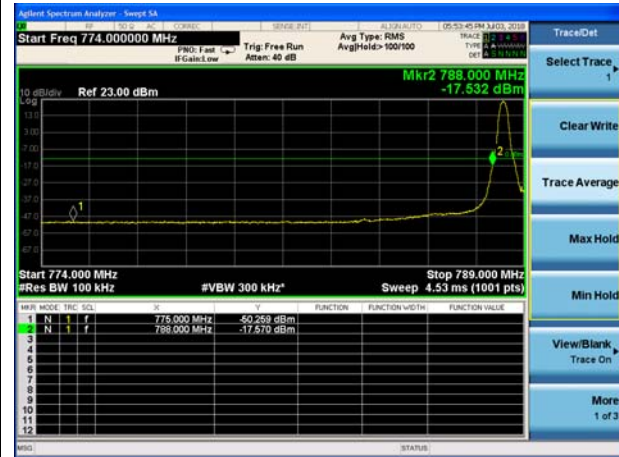

LTE Band 14 QPSK 10MHz 1 RB (775MHz ~788MHz)

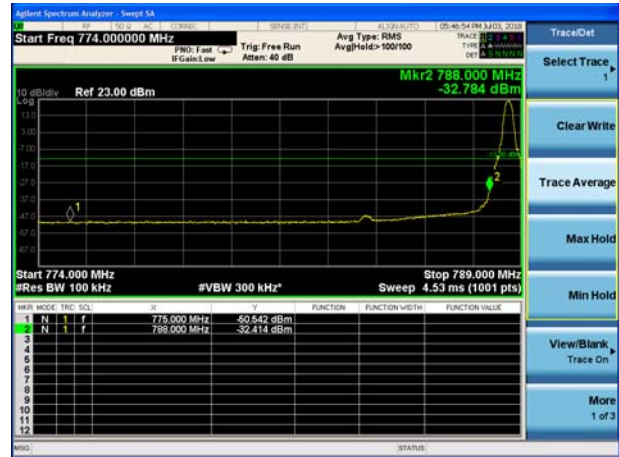

LTE Band 14 QPSK 5MHz 1 RB (799MHz ~805MHz)



LTE Band 14 QPSK 10MHz 1 RB (799MHz ~805MHz)





LTE Band 14 QPSK 5MHz 100%RB (769MHz ~775MHz)



LTE Band 14 QPSK 10MHz 100%RB (769MHz ~775MHz)



LTE Band 14 QPSK 5MHz 100%RB (775MHz ~788MHz)



LTE Band 14 QPSK 10MHz 100%RB (775MHz ~788MHz)



LTE Band 14 QPSK 5MHz 100%RB (799MHz ~805MHz)

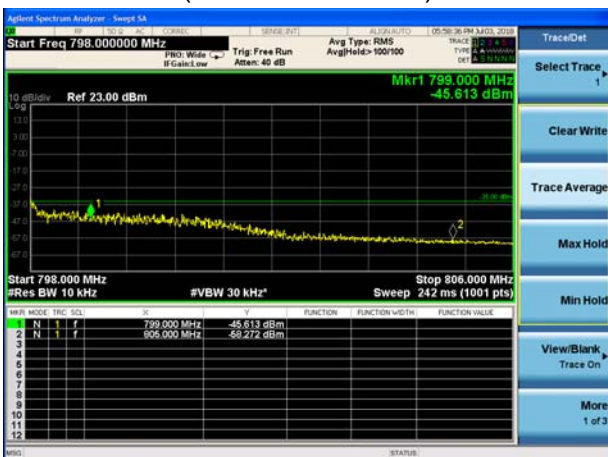

LTE Band 14 QPSK 10MHz 100%RB (799MHz ~805MHz)

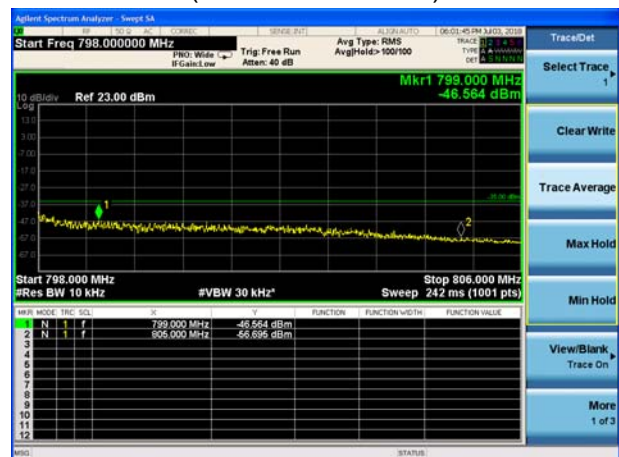



LTE Band 14 16QAM 5MHz 1 RB (769MHz ~775MHz)



LTE Band 14 16QAM 10MHz 1 RB (769MHz ~775MHz)



LTE Band 14 16QAM 5MHz 1 RB (775MHz ~788MHz)

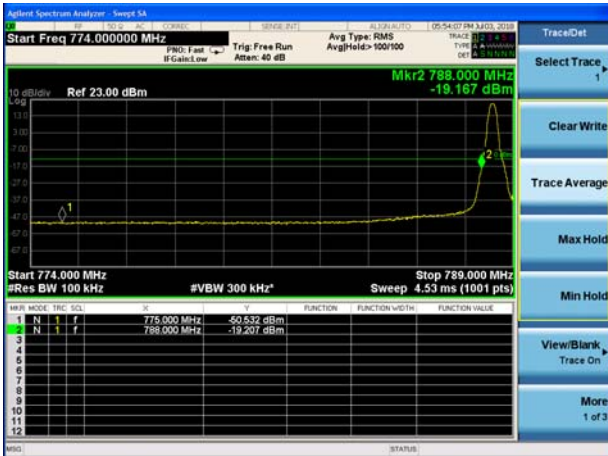

LTE Band 14 16QAM 10MHz 1 RB (775MHz ~788MHz)



LTE Band 14 16QAM 5MHz 1 RB (799MHz ~805MHz)



LTE Band 14 16QAM 10MHz 1 RB (799MHz ~805MHz)





LTE Band 14 16QAM 5MHz 100%RB
(769MHz ~775MHz)



LTE Band 14 16QAM 10MHz 100%RB
(769MHz ~775MHz)



LTE Band 14 16QAM 5MHz 100%RB
(775MHz ~788MHz)



LTE Band 14 16QAM 10MHz 100%RB
(775MHz ~788MHz)



LTE Band 14 16QAM 5MHz 100%RB
(799MHz ~805MHz)

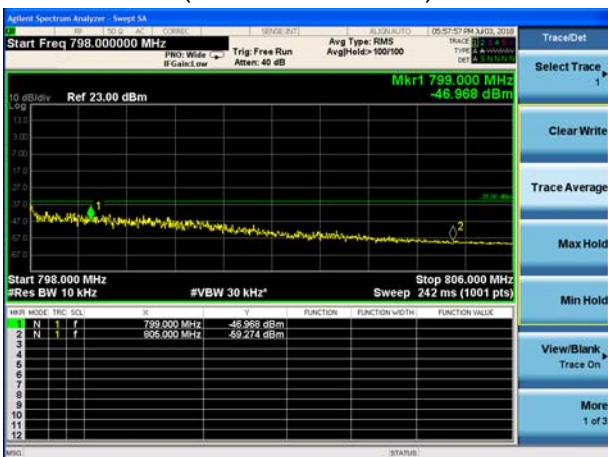

LTE Band 14 16QAM 10MHz 100%RB
(799MHz ~805MHz)

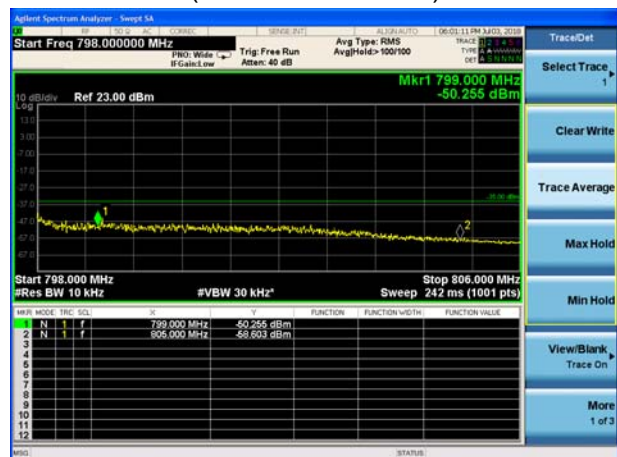

5.6. Peak-to-Average Power Ratio (PAPR)

Ambient condition

Temperature	Relative humidity	Pressure
23°C ~25°C	45%~50%	101.5kPa

Methods of Measurement

Measure the total peak power and record as PPK. And measure the total average power and record as PAvg. Both the peak and average power levels must be expressed in the same logarithmic units (e.g., dBm). Determine the PAPR from:

$$\text{PAPR (dB)} = \text{PPk (dBm)} - \text{PAvg (dBm)}.$$

Test Setup

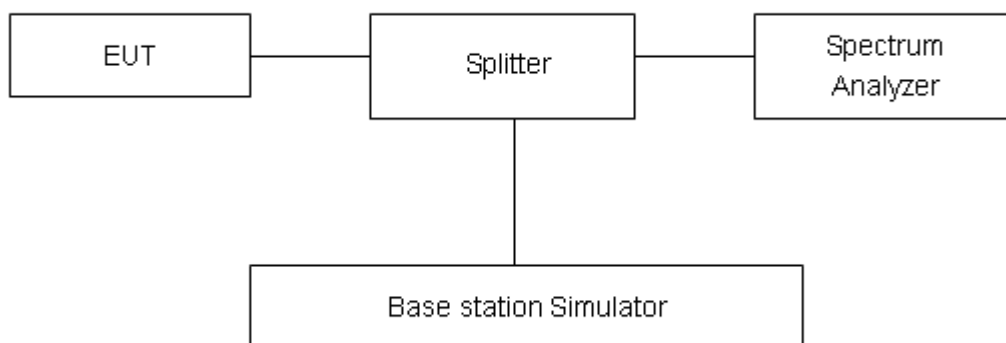

Limits

In measuring transmissions in this band using an average power technique, the peak-to-average ratio (PAR) of the transmission may not exceed 13 dB in 24.232(d).

Measurement Uncertainty

The assessed measurement uncertainty to ensure 95% confidence level for the normal distribution is with the coverage factor $k = 2$, $U = 0.4$ dB.

**Test Results**

LTE Band 14								
Modulation	Bandwidth (MHz)	Channel	Frequency (MHz)	Peak (dBm)	Avg (dBm)	PAPR (dB)	Limit (dB)	Conclusion
QPSK	5	23305	790.5	28.02	22.89	5.13	≤13	PASS
		23330	793	27.70	22.76	4.94	≤13	PASS
		23355	795.5	27.46	22.73	4.73	≤13	PASS
	10	23330	793	27.69	22.83	4.86	≤13	PASS
16QAM	5	23305	790.5	27.73	21.77	5.96	≤13	PASS
		23330	793	27.48	21.73	5.75	≤13	PASS
		23355	795.5	27.23	21.69	5.54	≤13	PASS
	10	23330	793	27.45	21.77	5.68	≤13	PASS

5.7. Frequency Stability

Ambient condition

Temperature	Relative humidity	Pressure
23°C ~25°C	45%~50%	101.5kPa

Method of Measurement

1. Frequency Stability (Temperature Variation)

The temperature inside the climate chamber is varied from -40°C to +85°C in 10°C step size,

(1) With all power removed, the temperature was decreased to 0°C and permitted to stabilize for three hours.

(2) Measure the carrier frequency with the test equipment in a “call mode”. These measurements should be made within 1 minute of powering up the mobile station, to prevent significant self warming.

(3) Repeat the above measurements at 10°C increments from -40°C to +85°C. Allow at least 1.5 hours at each temperature, un-powered, before making measurements.

2. Frequency Stability (Voltage Variation)

The frequency stability shall be measured with variation of primary supply voltage as follows:

(1) Vary primary supply voltage from 85 to 115 percent of the nominal value for other than hand carried battery equipment.

(2) For hand carried, battery powered equipment, reduce primary supply voltage to the battery-operating end point which shall be specified by the manufacturer.

This transceiver is specified to operate with an input voltage of between 3.3 V and 4.3 V, with a nominal voltage of 3.8V.

Test setup

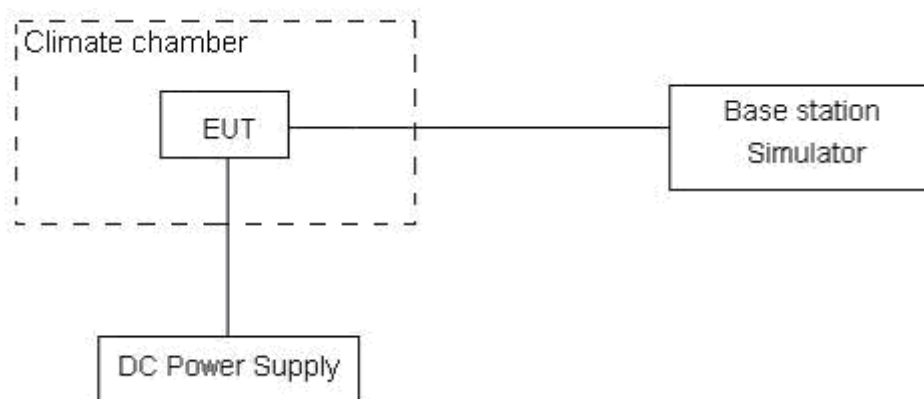

**Limits**

90.539 (c) The frequency stability of mobile, portable, and control transmitters operating in the narrowband segment must be 400 parts per billion or better when AFC is locked to the base station. When AFC is not locked to the base station, the frequency stability must be at least 1.0 ppm for 6.25 kHz, 1.5 ppm for 12.5 kHz (2 channel aggregate), and 2.5 ppm for 25 kHz (4 channel aggregate).

Measurement Uncertainty

The assessed measurement uncertainty to ensure 99.75% confidence level for the normal distribution is with the coverage factor $k = 3$, $U = 0.01\text{ppm}$.



Test Result

LTE Band 14					
(QPSK, 10MHz BANDWIDTH)					
Condition		788	798	Delta (Hz)	Frequency Stability(ppm)
Temperature	Voltage	F low@-13dBm(MHz)	F high@-13dBm(MHz)		
Normal (25°C)	Normal	788.4918	797.5101	-2.28	-0.00322
Extreme (85°C)		788.4919	797.5131	-3.34	-0.00472
Extreme (80°C)		788.4928	797.5087	0.28	0.00040
Extreme (70°C)		788.4905	797.5102	3.65	0.00516
Extreme (60°C)		788.4905	797.5108	2.28	0.00322
Extreme (50°C)		788.4915	797.5104	-1.03	-0.00146
Extreme (40°C)		788.4930	797.5089	-3.51	-0.00496
Extreme (30°C)		788.4911	797.5108	-3.99	-0.00564
Extreme (20°C)		788.4908	797.5111	-4.47	-0.00632
Extreme (10C)		788.4923	797.5096	-6.77	-0.00957
Extreme (0°C)		788.4912	797.5107	3.04	0.00430
Extreme (-10°C)		788.4909	797.5116	0.71	0.00100
Extreme (-20°C)		788.4925	797.5094	-0.70	-0.00099
Extreme (-30°C)		788.4915	797.5104	-1.85	-0.00261
Extreme (-40°C)		788.4916	797.5103	-1.97	-0.00278
25°C	LV	788.4911	797.5108	-2.98	-0.00421
	HV	788.4917	797.5102	-6.40	-0.00905
(16QAM, 10MHz BANDWIDTH)					
Condition		788	798	Delta (Hz)	Frequency Stability(ppm)
Temperature	Voltage	F low@-13dBm(MHz)	F high@-13dBm(MHz)		
Normal (25°C)	Normal	788.4932	797.5057	2.17	0.00307
Extreme (85°C)		788.4931	797.5056	1.02	0.00144
Extreme (80°C)		788.4926	797.5051	0.90	0.00127
Extreme (70°C)		788.4942	797.5067	-0.11	-0.00016
Extreme (60°C)		788.4947	797.5072	-3.53	-0.00499
Extreme (50°C)		788.4935	797.5062	-1.55	-0.00219
Extreme (40°C)		788.4920	797.5045	2.95	0.00417
Extreme (30°C)		788.4939	797.5064	2.20	0.00311
Extreme (20°C)		788.4942	797.5067	-5.42	-0.00766
Extreme (10C)		788.4927	797.5052	1.84	0.00260
Extreme (0°C)		788.4938	797.5063	3.15	0.00445
Extreme (-10°C)		788.4941	797.5066	-1.47	-0.00208
Extreme (-20°C)		788.4925	797.5051	0.23	0.00033



Extreme (-30°C)		788.4935	797.5062	0.02	0.00003
Extreme (-40°C)		788.4934	797.5059	-3.47	-0.00490
25°C	LV	788.4939	797.5064	0.81	0.00114
	HV	788.4933	797.5058	-2.42	-0.00342

5.8. Spurious Emissions at Antenna Terminals

Ambient condition

Temperature	Relative humidity	Pressure
23°C ~25°C	45%~50%	101.5kPa

Method of Measurement

The EUT was connected to Spectrum Analyzer and Base Station Simulator via power Splitter. The measurement is carried out using a spectrum analyzer. The spectrum analyzer scans from 9kHz to the 10th harmonic of the carrier. The peak detector is used.

RBW is set to 100kHz, VBW is set to 300kHz for 30MHz~1GHz

RBW is set to 1MHz, VBW is set to 3MHz for above 1GHz, Sweep is set to ATUO.

The modulation mode and RB allocation refer to section 5.1, using the maximum output power configuration.

Test setup

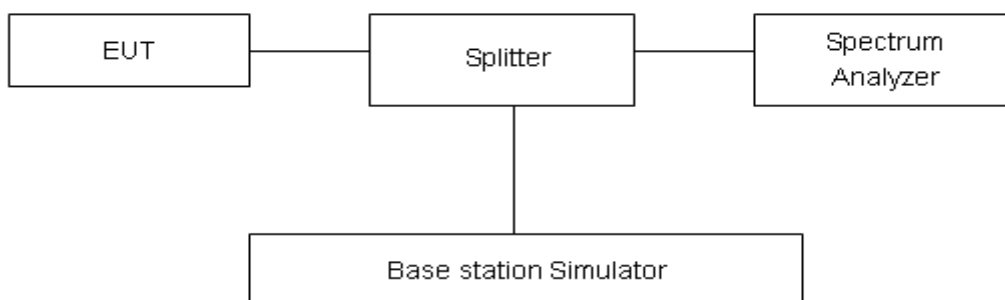

Limits

90.543 Emission limitations (e) For operations in the 758-768 MHz and the 788-798 MHz bands, the power of any emission outside the licensee's frequency band(s) of operation shall be attenuated below the transmitter power (P) within the licensed band(s) of operation, measured in watts, in accordance with the following:

- (1) On all frequencies between 769-775 MHz and 799-805 MHz, by a factor not less than $76 + 10 \log(P)$ dB in a 6.25 kHz band segment, for base and fixed stations.
- (2) On all frequencies between 769-775 MHz and 799-805 MHz, by a factor not less than $65 + 10 \log(P)$ dB in a 6.25 kHz band segment, for mobile and portable stations.
- (3) On any frequency between 775-788 MHz, above 805 MHz, and below 758 MHz, by at least $43 + 10 \log(P)$ dB.



(4) Compliance with the provisions of paragraphs (e)(1) and (2) of this section is based on the use of measurement instrumentation such that the reading taken with any resolution bandwidth setting should be adjusted to indicate spectral energy in a 6.25 kHz segment.

(5) Compliance with the provisions of paragraph (e)(3) of this section is based on the use of measurement instrumentation employing a resolution bandwidth of 100 kHz or greater. However, in the 100 kHz bands immediately outside and adjacent to the frequency block, a resolution bandwidth of 30 kHz may be employed.

(f) For operations in the 758-775 MHz and 788-805 MHz bands, all emissions including harmonics in the band 1559-1610 MHz shall be limited to -70 dBW/MHz equivalent isotropically radiated power (EIRP) for wideband signals, and -80 dBW EIRP for discrete emissions of less than 700 Hz bandwidth. For the purpose of equipment authorization, a transmitter shall be tested with an antenna that is representative of the type that will be used with the equipment in normal operation.

Measurement Uncertainty

The assessed measurement uncertainty to ensure 99.75% confidence level for the normal distribution is with the coverage factor $k = 1.96$.

Frequency	Uncertainty
9kHz-1GHz	0.684 dB
1GHz-10GHz	1.407 dB



Test Result

If disturbances were found more than 20dB below limit line, the mark is not required for the EUT.
The signal beyond the limit is carrier.

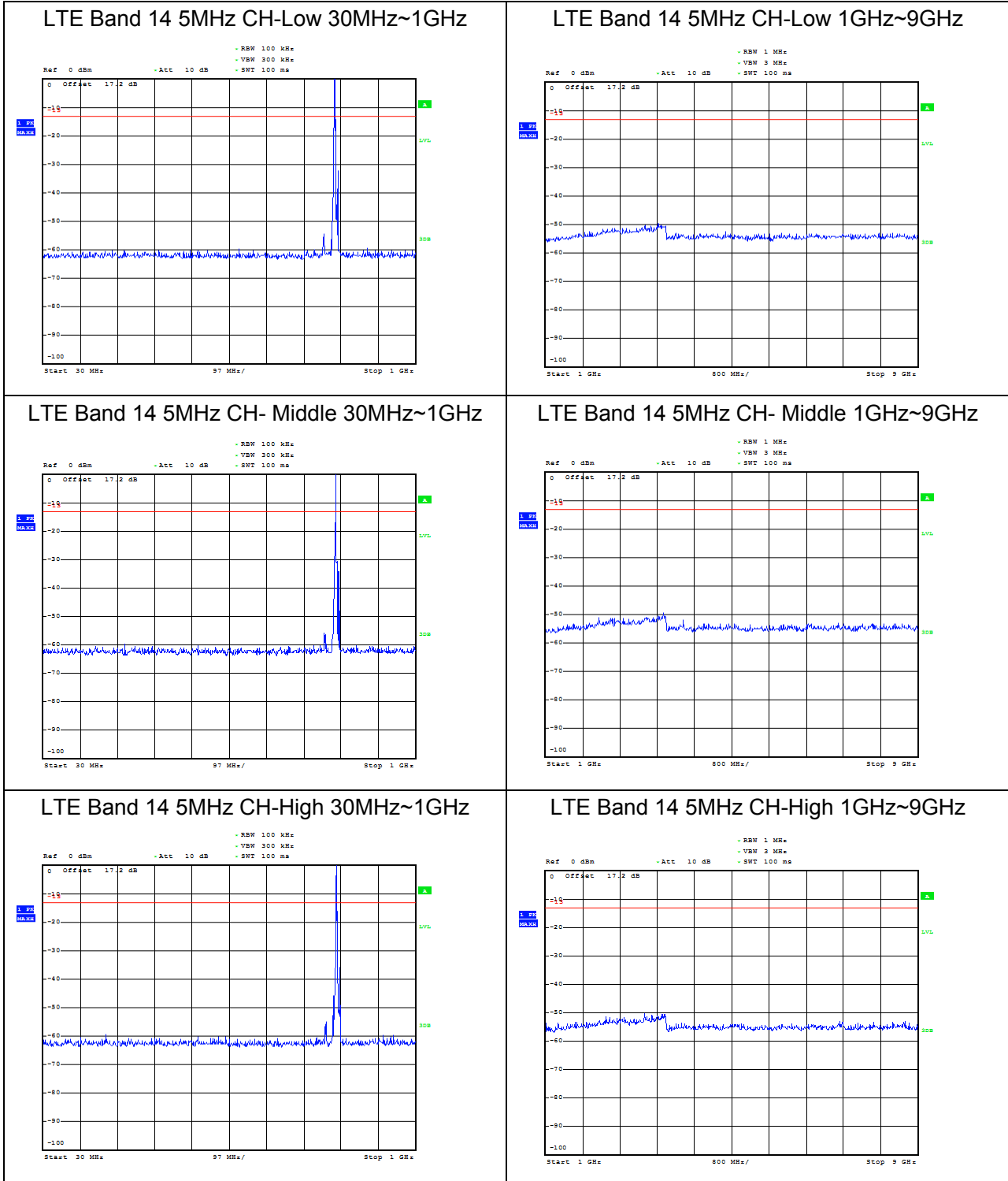



LTE Band 14 10MHz CH- Middle 30MHz~1GHz

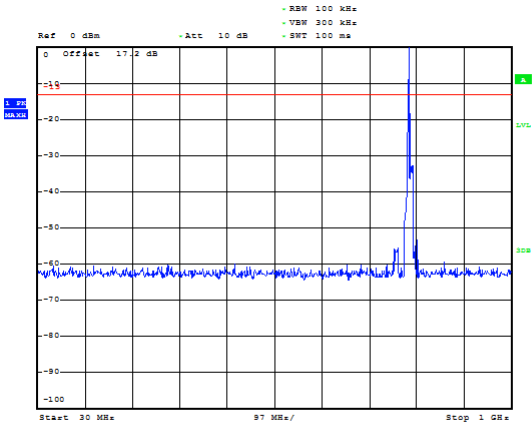

LTE Band 14 10MHz CH- Middle 1GHz~9GHz

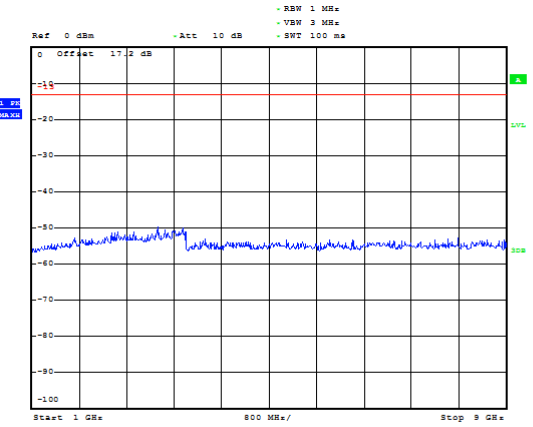

5.9. Radiates Spurious Emission

Ambient condition

Temperature	Relative humidity	Pressure
23°C ~25°C	45%~50%	101.5kPa

Method of Measurement

1. The testing follows FCC KDB 971168 v03r01 Section 5.8 and ANSI/TIA-603-E (2016).
 2. The EUT is placed on a turntable 0.8 meters above the ground in the chamber, 3 meter away from the antenna. The maximal emission value is acquired by adjusting the antenna height, polarisation and turntable azimuth. Normally, the height range of antenna is 1 m to 4 m, the azimuth range of turntable is 0° to 360°, and the receive antenna has two polarizations Vertical (V) and Horizontal (H).
 3. A log-periodic antenna or double-ridged waveguide horn antenna shall be substituted in place of the EUT. The log-periodic antenna will be driven by a signal generator and the level will be adjusted till the same power value on the spectrum analyzer or receiver. The level of the spurious emissions can be calculated through the level of the signal generator, cable loss, the gain of the substitution antenna and the reading of the spectrum analyzer or receiver.
 4. The EUT is then put into continuously transmitting mode at its maximum power level during the test. Set Test Receiver or Spectrum RBW=1MHz, VBW=3MHz, And the maximum value of the receiver should be recorded as (Pr).
 5. The EUT shall be replaced by a substitution antenna. In the chamber, an substitution antenna for the frequency band of interest is placed at the reference point of the chamber. An RF Signal source for the frequency band of interest is connected to the substitution antenna with a cable that has been constructed to not interfere with the radiation pattern of the antenna. A power (PMea) is applied to the input of the substitution antenna, and adjust the level of the signal generator output until the value of the receiver reach the previously recorded (Pr). The power of signal source (PMea) is recorded. The test should be performed by rotating the test item and adjusting the receiving antenna polarization.
 6. A amplifier should be connected to the Signal Source output port. And the cable should be connect between the Amplifier and the Substitution Antenna. The cable loss (Pcl) ,the Substitution Antenna Gain (Ga) and the Amplifier Gain (PAg) should be recorded after test.
 7. The measurement results are obtained as described below:
$$\text{Power(EIRP)} = \text{PMea} - \text{PAg} - \text{Pcl} + \text{Ga}$$

The measurement results are amend as described below:
$$\text{Power(EIRP)} = \text{PMea} - \text{Pcl} + \text{Ga}$$
 8. This value is EIRP since the measurement is calibrated using an antenna of known gain (2.15 dBi) and known input power. ERP can be calculated from EIRP by subtracting the gain of the dipole, $\text{ERP} = \text{EIRP} - 2.15\text{dBi}$.
- The modulation mode and RB allocation refer to section 5.1, using the maximum output power configuration.

Test setup

30MHz~~~ 1GHz

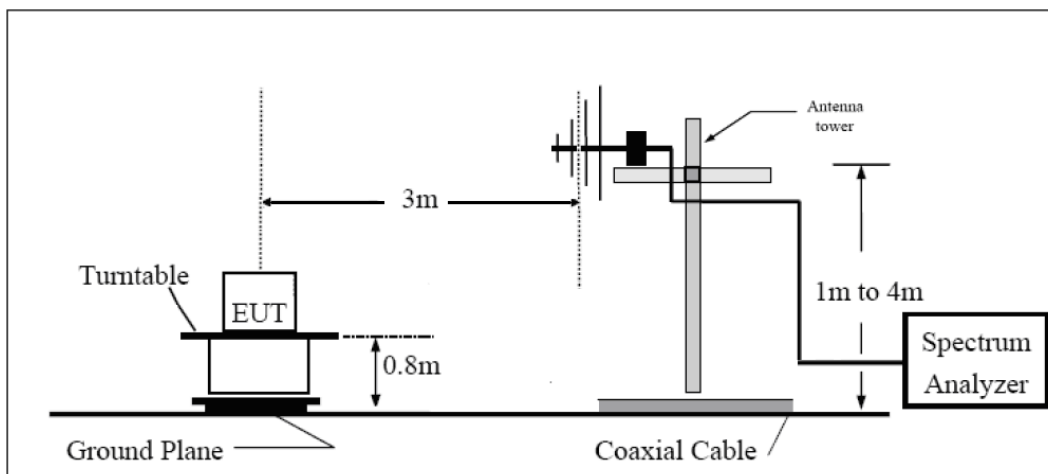

Above 1GHz

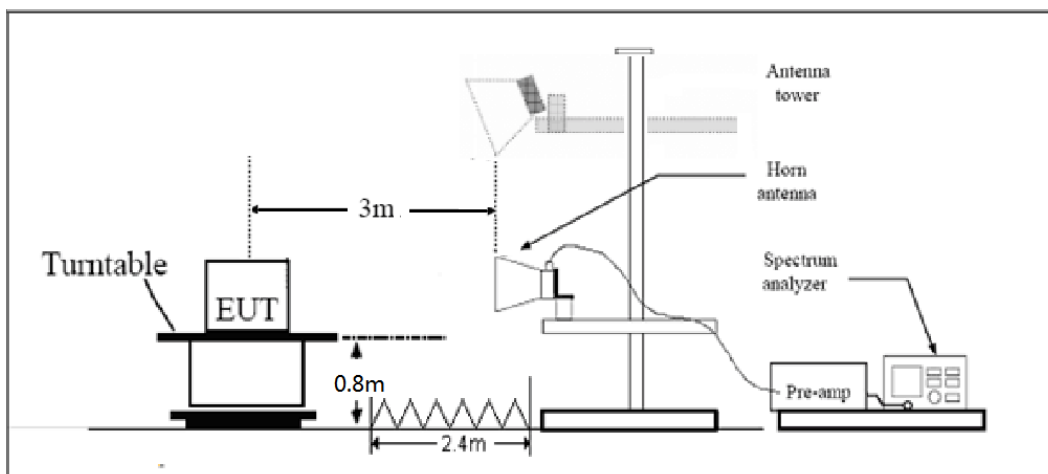

Note: Area side:2.4mX3.6m

The radiated emission was measured in the following position: EUT stand-up position (Z axis), lie-down position (X, Y axis). The worst emission was found in stand-up position (Z axis) and the worst case was recorded.

Limits

90.543 Emission limitations (e) For operations in the 758-768 MHz and the 788-798 MHz bands, the power of any emission outside the licensee's frequency band(s) of operation shall be attenuated below the transmitter power (P) within the licensed band(s) of operation, measured in watts, in accordance with the following:

- (1) On all frequencies between 769-775 MHz and 799-805 MHz, by a factor not less than $76 + 10 \log (P)$ dB in a 6.25 kHz band segment, for base and fixed stations.



(2) On all frequencies between 769-775 MHz and 799-805 MHz, by a factor not less than $65 + 10 \log (P)$ dB in a 6.25 kHz band segment, for mobile and portable stations.

(3) On any frequency between 775-788 MHz, above 805 MHz, and below 758 MHz, by at least $43 + 10 \log (P)$ dB.

(4) Compliance with the provisions of paragraphs (e)(1) and (2) of this section is based on the use of measurement instrumentation such that the reading taken with any resolution bandwidth setting should be adjusted to indicate spectral energy in a 6.25 kHz segment.

(5) Compliance with the provisions of paragraph (e)(3) of this section is based on the use of measurement instrumentation employing a resolution bandwidth of 100 kHz or greater. However, in the 100 kHz bands immediately outside and adjacent to the frequency block, a resolution bandwidth of 30 kHz may be employed.

(f) For operations in the 758-775 MHz and 788-805 MHz bands, all emissions including harmonics in the band 1559-1610 MHz shall be limited to -70 dBW/MHz equivalent isotropically radiated power (EIRP) for wideband signals, and -80 dBW EIRP for discrete emissions of less than 700 Hz bandwidth. For the purpose of equipment authorization, a transmitter shall be tested with an antenna that is representative of the type that will be used with the equipment in normal operation.

Measurement Uncertainty

The assessed measurement uncertainty to ensure 95% confidence level for the normal distribution is with the coverage factor $k = 1.96$, $U = 3.55$ dB.

Test Result

Sweep the whole frequency band through the range from 30MHz to the 10th harmonic of the carrier, the emissions below the noise floor will not be recorded in the report.

LTE Band 14 QPSK 5MHz CH-Low, RB 1

Harmonic	Frequency (MHz)	SG (dBm)	Cable Loss (dB)	Gain (dBi)	Antenna Polarization	ERP Level (dBm)	Limit (dBm)	Margin (dB)	Azimuth (deg)
2	1576.5	-66.10	2.00	10.15	Horizontal	-60.10	-40.00	20.10	315
3	2371.5	-60.60	2.50	11.35	Horizontal	-53.90	-13.00	40.90	45
4	3162	-59.28	4.20	10.85	Horizontal	-54.78	-13.00	41.78	315
5	3952.5	-53.80	5.20	11.35	Horizontal	-49.80	-13.00	36.80	90
6	4743	-57.70	5.50	11.95	Horizontal	-53.40	-13.00	40.40	135
7	5533.5	-54.60	5.70	13.55	Horizontal	-48.90	-13.00	35.90	135
8	6324	-55.80	6.30	13.75	Horizontal	-50.50	-13.00	37.50	315
9	7114.5	-51.00	6.80	13.85	Horizontal	-46.10	-13.00	33.10	225
10	7905	-52.50	6.90	14.25	Horizontal	-47.30	-13.00	34.30	270

Note: 1.The other Spurious RF Radiated emissions level is no more than noise floor.
 2. The worst emission was found in the antenna is Horizontal position.

LTE Band 14 QPSK 5MHz CH-Middle, RB 1

Harmonic	Frequency (MHz)	SG (dBm)	Cable Loss (dB)	Gain (dBi)	Antenna Polarization	ERP Level (dBm)	Limit (dBm)	Margin (dB)	Azimuth (deg)
2	1581.6	-65.60	2.00	10.75	Horizontal	-59.00	-40.00	19.00	315
3	2379	-59.49	2.51	11.05	Horizontal	-53.10	-13.00	40.10	225
4	3172	-57.50	4.20	11.15	Horizontal	-52.70	-13.00	39.70	0
5	3965	-52.50	5.20	11.15	Horizontal	-48.70	-13.00	35.70	90
6	4758	-57.80	5.50	11.95	Horizontal	-53.50	-13.00	40.50	90
7	5551	-54.80	5.70	13.55	Horizontal	-49.10	-13.00	36.10	225
8	6344	-55.27	6.30	13.75	Horizontal	-49.97	-13.00	36.97	0
9	7137	-50.10	6.80	13.85	Horizontal	-45.20	-13.00	32.20	90
10	7930	-52.20	6.90	14.25	Horizontal	-47.00	-13.00	34.00	270

Note: 1.The other Spurious RF Radiated emissions level is no more than noise floor.
 2. The worst emission was found in the antenna is Horizontal position.



LTE Band 14 QPSK 5MHz CH-High, RB 1

Harmonic	Frequency (MHz)	SG (dBm)	Cable Loss (dB)	Gain (dBi)	Antenna Polarization	ERP Level (dBm)	Limit (dBm)	Margin (dB)	Azimuth (deg)
2	1586.4	-64.66	2.00	10.15	Horizontal	-58.66	-40.00	18.66	90
3	2386.5	-59.09	2.51	11.05	Horizontal	-52.70	-13.00	39.70	270
4	3182	-57.40	4.20	11.15	Horizontal	-52.60	-13.00	39.60	45
5	3977.5	-52.57	5.20	11.15	Horizontal	-48.77	-13.00	35.77	0
6	4773	-58.00	5.50	11.95	Horizontal	-53.70	-13.00	40.70	90
7	5568.5	-54.60	5.70	13.55	Horizontal	-48.90	-13.00	35.90	270
8	6364	-54.40	6.30	13.75	Horizontal	-49.10	-13.00	36.10	45
9	7159.5	-48.60	6.80	13.85	Horizontal	-43.70	-13.00	30.70	315
10	7955	-52.50	6.90	14.25	Horizontal	-47.30	-13.00	34.30	45

Note: 1.The other Spurious RF Radiated emissions level is no more than noise floor.

2. The worst emission was found in the antenna is Horizontal position.

LTE Band 14 QPSK 10MHz CH-Low, RB 1

Harmonic	Frequency (MHz)	SG (dBm)	Cable Loss (dB)	Gain (dBi)	Antenna Polarization	ERP Level (dBm)	Limit (dBm)	Margin (dB)	Azimuth (deg)
2	1576.9	-65.60	2.00	10.15	Horizontal	-59.60	-40.00	19.60	270
3	2379	-60.49	2.51	11.35	Horizontal	-53.80	-13.00	40.80	45
4	3172	-59.10	4.20	10.85	Horizontal	-54.60	-13.00	41.60	315
5	3965	-54.10	5.20	11.35	Horizontal	-50.10	-13.00	37.10	45
6	4758	-57.50	5.50	11.95	Horizontal	-53.20	-13.00	40.20	315
7	5551	-55.50	5.70	13.55	Horizontal	-49.80	-13.00	36.80	90
8	6344	-55.60	6.30	13.75	Horizontal	-50.30	-13.00	37.30	135
9	7137	-51.10	6.80	13.85	Horizontal	-46.20	-13.00	33.20	135
10	7930	-53.00	6.90	14.25	Horizontal	-47.80	-13.00	34.80	315

Note: 1.The other Spurious RF Radiated emissions level is no more than noise floor.

2. The worst emission was found in the antenna is Horizontal position.



LTE Band 14 QPSK 10MHz CH-Middle, RB 1

Harmonic	Frequency (MHz)	SG (dBm)	Cable Loss (dB)	Gain (dBi)	Antenna Polarization	ERP Level (dBm)	Limit (dBm)	Margin (dB)	Azimuth (deg)
2	1577.1	-66.20	2.00	10.75	Horizontal	-59.60	-40.00	19.60	225
3	2378.4	-59.49	2.51	11.05	Horizontal	-53.10	-13.00	40.10	0
4	3172	-59.10	4.20	11.15	Horizontal	-54.30	-13.00	41.30	90
5	3965	-53.60	5.20	11.15	Horizontal	-49.80	-13.00	36.80	270
6	4758	-57.50	5.50	11.95	Horizontal	-53.20	-13.00	40.20	45
7	5551	-55.20	5.70	13.55	Horizontal	-49.50	-13.00	36.50	0
8	6344	-55.40	6.30	13.75	Horizontal	-50.10	-13.00	37.10	90
9	7137	-51.00	6.80	13.85	Horizontal	-46.10	-13.00	33.10	270
10	7930	-52.70	6.90	14.25	Horizontal	-47.50	-13.00	34.50	45

Note: 1.The other Spurious RF Radiated emissions level is no more than noise floor.
2. The worst emission was found in the antenna is Horizontal position.

LTE Band 14 QPSK 10MHz CH-High, RB 1

Harmonic	Frequency (MHz)	SG (dBm)	Cable Loss (dB)	Gain (dBi)	Antenna Polarization	ERP Level (dBm)	Limit (dBm)	Margin (dB)	Azimuth (deg)
2	1577.3	-65.70	2.00	10.15	Horizontal	-59.70	-40.00	19.70	90
3	2375.6	-59.99	2.51	11.05	Horizontal	-53.60	-13.00	40.60	270
4	3172	-59.40	4.20	11.15	Horizontal	-54.60	-13.00	41.60	45
5	3965	-53.80	5.20	11.15	Horizontal	-50.00	-13.00	37.00	315
6	4758	-57.20	5.50	11.95	Horizontal	-52.90	-13.00	39.90	45
7	5551	-54.70	5.70	13.55	Horizontal	-49.00	-13.00	36.00	315
8	6344	-54.28	6.30	13.75	Horizontal	-48.98	-13.00	35.98	90
9	7137	-52.60	6.80	13.85	Horizontal	-47.70	-13.00	34.70	135
10	7930	-51.60	6.90	14.25	Horizontal	-46.40	-13.00	33.40	135

Note: 1.The other Spurious RF Radiated emissions level is no more than noise floor.
2. The worst emission was found in the antenna is Horizontal position.



6. Main Test Instruments

Name	Manufacturer	Type	Serial Number	Calibration Date	Expiration Date
Base Station Simulator	R&S	CMW500	113824	2018-05-20	2019-05-19
Power Splitter	Hua Xiang	SHX-GF2-2-13	10120101	/	/
Spectrum Analyzer	Agilent	N9010A	MY47191109	2018-05-20	2019-05-19
Universal Radio Communication Tester	Agilent	E5515C	MY48367192	2018-05-20	2019-05-19
Signal Analyzer	R&S	FSV30	100815	2017-12-17	2018-12-16
EMI Test Receiver	R&S	ESCI	100948	2018-05-20	2019-05-19
Signal generator	R&S	SMB 100A	102594	2018-05-13	2019-05-12
Loop Antenna	SCHWARZBECK	FMZB1519	1519-047	2014-12-06	2019-12-05
Trilog Antenna	SCHWARZBECK	VUBL 9163	9163-201	2017-11-18	2020-11-17
Horn Antenna	R&S	HF907	100126	2014-12-06	2019-12-05
Horn Antenna	ETS-Lindgren	3160-09	00102644	2015-01-30	2020-01-29
Climatic Chamber	ESPEC	SU-242	93000506	2017-12-17	2020-12-16
RF Cable	Agilent	SMA 15cm	0001	2018-02-03	2018-08-02
Preamplifier	R&S	SCU18	102327	2018-05-20	2019-05-19
Software	R&S	EMC32	V9.26.0	/	/
MOB COMMS DC SUPPLY	Keysight	66319D	MY43004105	2018-05-07	2019-05-06

*****END OF REPORT *****

ANNEX A: EUT Appearance and Test Setup

A.1 EUT Appearance

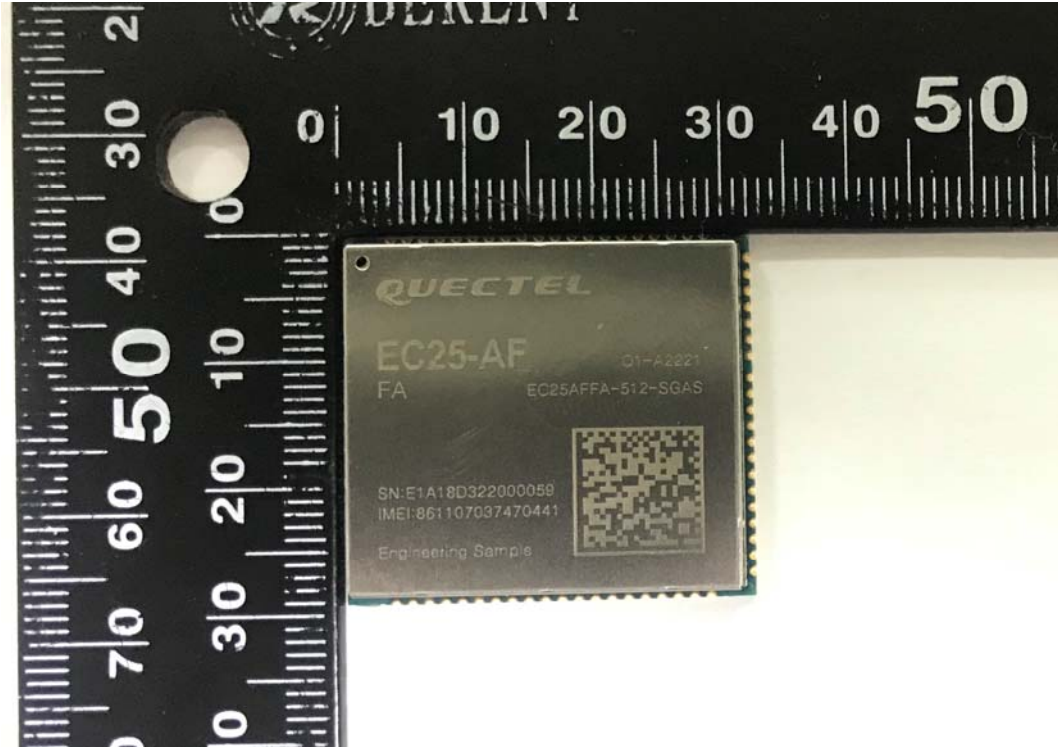

shielding

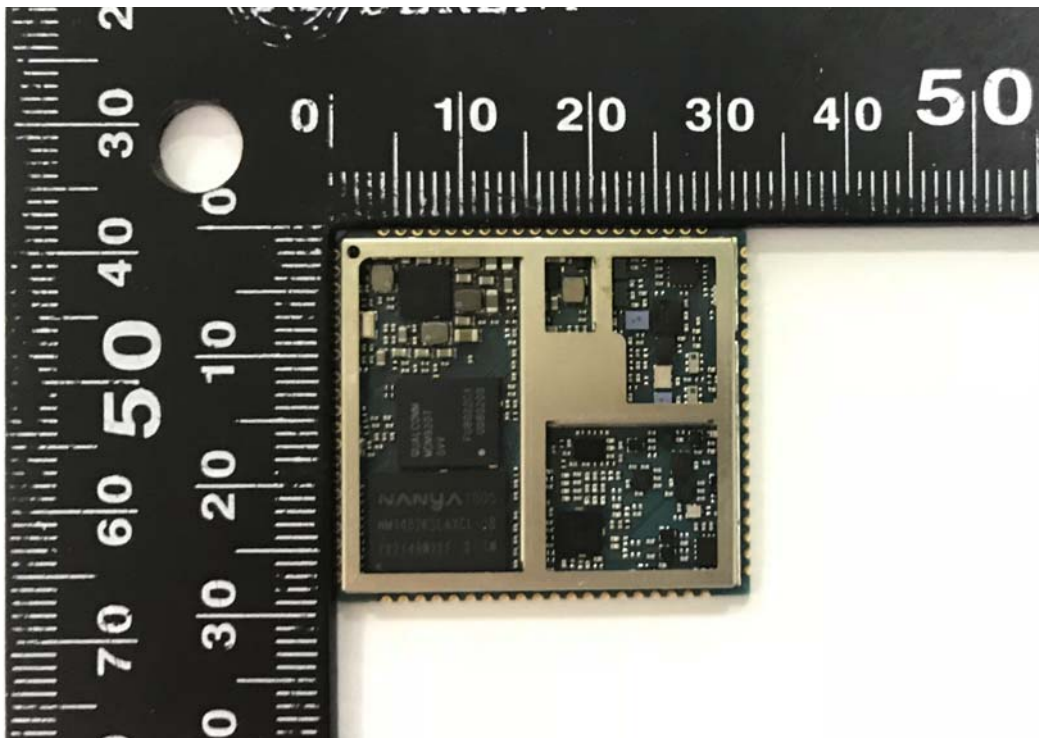

No shielding
Front Side

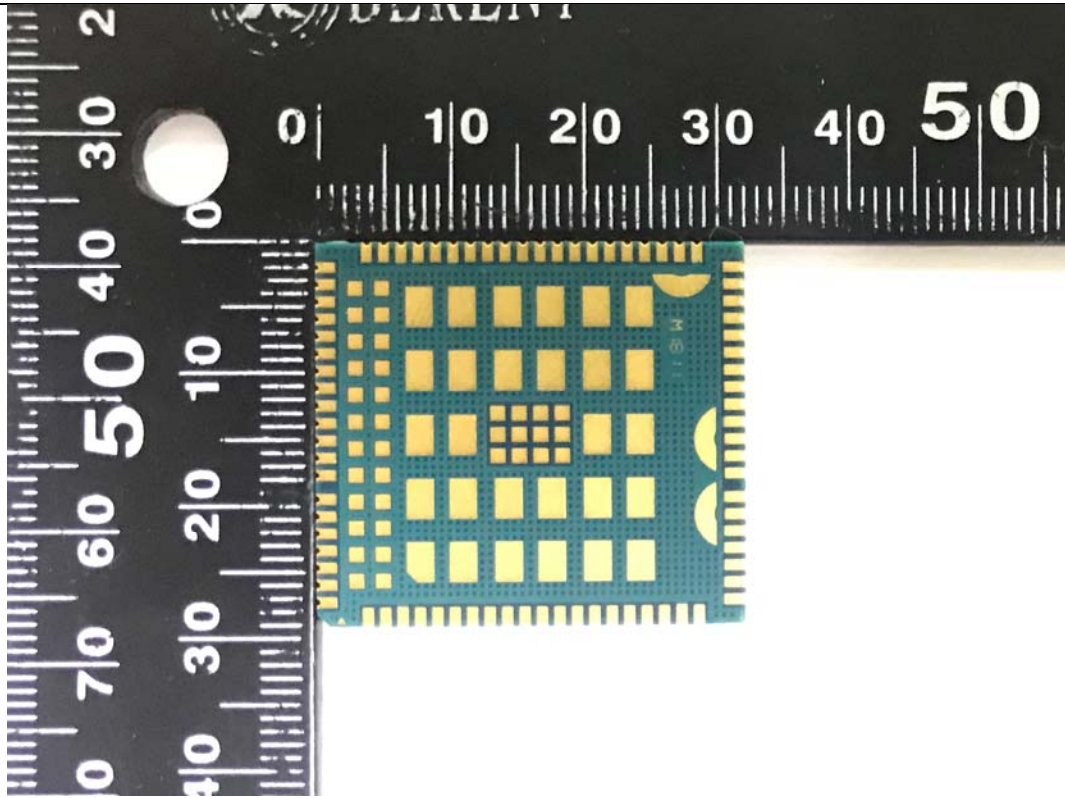

Back Side
EC25-AF



shielding

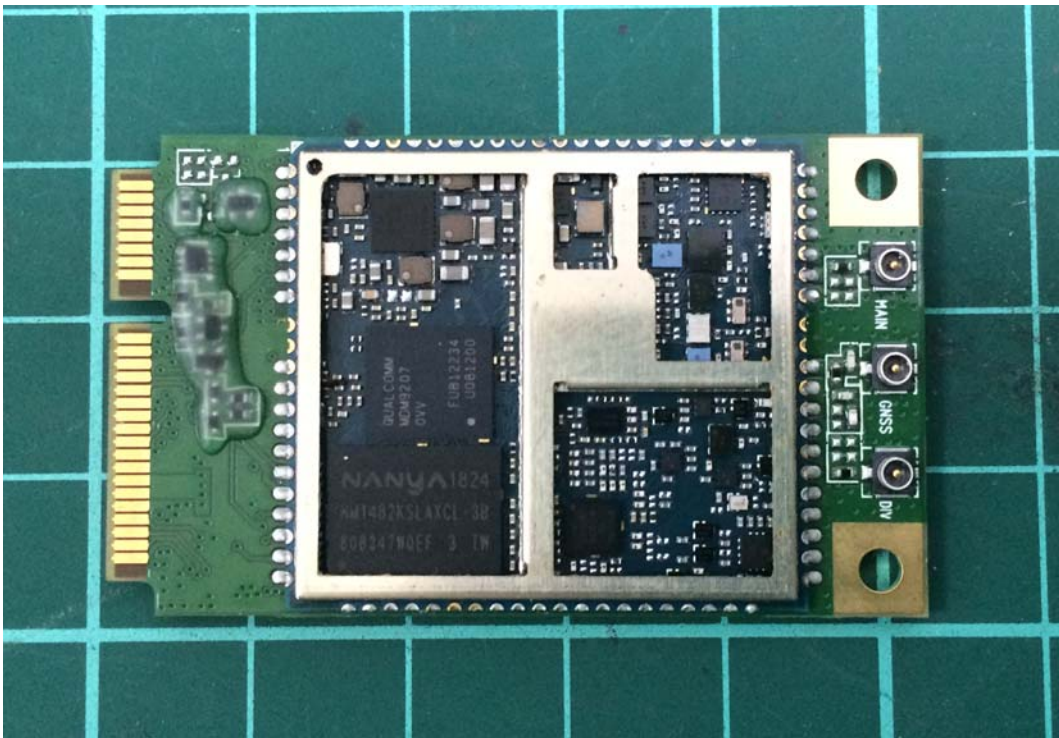

No shielding
Front Side



shielding

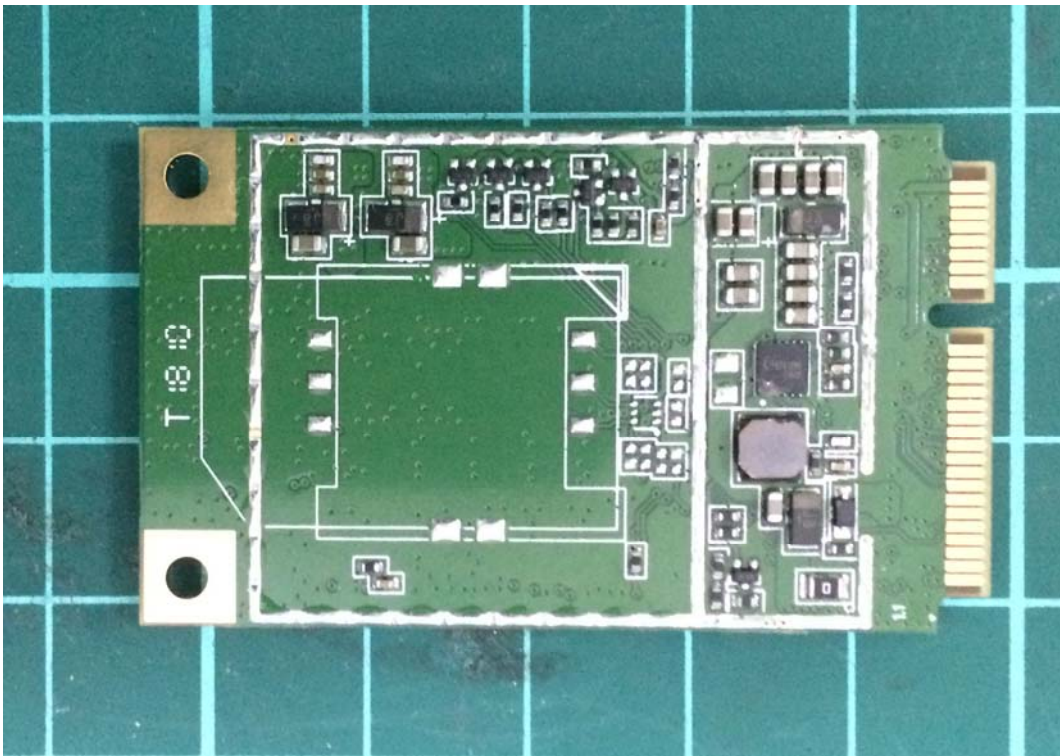

No shielding
Back Side

EC25-AF MINIPCI-E
Picture 1 EUT and Accessory

A.2 Test Setup

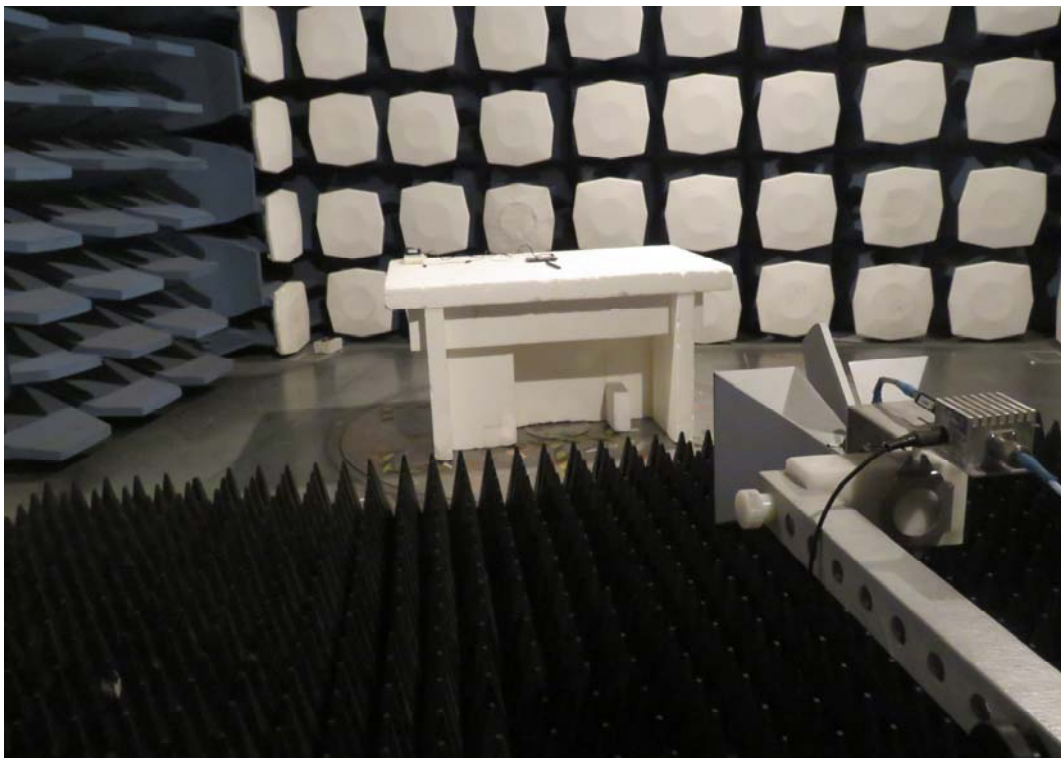

Picture 2: Radiated Spurious Emissions Test setup