

ELECTROMAGNETIC EMISSION COMPLIANCE REPORT FOR LOW-POWER, NON-LICENSED TRANSMITTER

Test Report No. : W164R-D022
AGR No. : A161A-258
Applicant : BLUEBIRD INC.
Address : (Dogok-dong, SEI Tower13,14)39, Eonjuro30-gil, Gangnam-gu, Seoul, South Korea
Manufacturer : BLUEBIRD INC.
Address : (Dogok-dong, SEI Tower13,14)39, Eonjuro30-gil, Gangnam-gu, Seoul, South Korea
Type of Equipment : Premium Tablet
FCC ID. : SS4ST100
Model Name : ST100
Serial number : N/A
Total page of Report : 122 pages (including this page)
Date of Incoming : February 01, 2016
Date of issue : April 06, 2016

SUMMARY

The equipment complies with the regulation; *FCC PART 15 SUBPART E Section 15.407*

This test report only contains the result of a single test of the sample supplied for the examination.

It is not a generally valid assessment of the features of the respective products of the mass-production.

Reviewed by: 

Jae-Ho, Lee / Chief Engineer
ONETECH Corp.

Approved by: 

Sung-Ik, Han / Managing Director
ONETECH Corp.

CONTENTS

	PAGE
1. VERIFICATION OF COMPLIANCE	7
2. TEST SUMMARY.....	8
2.1 TEST ITEMS AND RESULTS	8
2.2 ADDITIONS, DEVIATIONS, EXCLUSIONS FROM STANDARDS.....	8
2.3 RELATED SUBMITTAL(S) / GRANT(S)	8
2.4 PURPOSE OF THE TEST	8
2.5 TEST METHODOLOGY.....	8
2.6 TEST FACILITY.....	8
3. GENERAL INFORMATION.....	9
3.1 PRODUCT DESCRIPTION.....	9
3.2 ALTERNATIVE TYPE(S)/MODEL(S); ALSO COVERED BY THIS TEST REPORT.....	10
4. EUT MODIFICATIONS.....	10
5. SYSTEM TEST CONFIGURATION	11
5.1 JUSTIFICATION.....	11
5.3 MODE OF OPERATION DURING THE TEST	12
5.4 CONFIGURATION OF TEST SYSTEM.....	16
5.5 ANTENNA REQUIREMENT	16
6. PRELIMINARY TEST	17
6.1 AC POWER LINE CONDUCTED EMISSIONS TESTS.....	17
6.2 GENERAL RADIATED EMISSIONS TESTS	17
7. MIMIMUM 26 DB BANDWIDTH	18
7.1 OPERATING ENVIRONMENT	18
7.2 TEST SET-UP	18
7.3 TEST EQUIPMENT USED.....	18
7.4.1 Test data for 802.11a RLAN Mode	19
7.4.2 Test data for 802.11n_HT20 RLAN Mode.....	28
8. MAXIMUM PEAK OUTPUT POWER.....	37
8.1 OPERATING ENVIRONMENT	37
8.2 TEST SET-UP	37
8.3 TEST EQUIPMENT USED.....	37
8.4 TEST DATA FOR 802.11A RLAN MODE.....	38
8.5 TEST DATA FOR 802.11N_HT20 RLAN MODE.....	47
9. PEAK POWER SPECTRUL DENSITY	56

9.1 OPERATING ENVIRONMENT	56
9.2 TEST SET-UP	56
9.3 TEST EQUIPMENT USED.....	56
9.4 TEST DATA FOR 802.11A RLAN MODE.....	57
9.5 TEST DATA FOR 802.11N_HT20 RLAN MODE.....	66
10. FREQUENCY STABILITY WITH TEMPERATURE VARIATION.....	75
10.1 OPERATING ENVIRONMENT	75
10.2 TEST SET-UP	75
10.3 TEST EQUIPMENT USED.....	75
10.4 TEST DATA FOR 5 150 MHz ~ 5 250 MHz BAND.....	76
10.5 TEST DATA FOR 5 250 MHz ~ 5 350 MHz BAND.....	77
10.6 TEST DATA FOR 5 470 MHz ~ 5 725 MHz BAND.....	78
10.7 TEST DATA FOR 5 725 MHz ~ 5 850 MHz BAND.....	79
11. FREQUENCY STABILITY WITH VOLTAGE VARIATION.....	80
11.1 OPERATING ENVIRONMENT	80
11.2 TEST SET-UP	80
11.3 TEST EQUIPMENT USED.....	80
11.4 TEST DATA FOR 5 150 MHz ~ 5 250 MHz BAND.....	81
11.5 TEST DATA FOR 5 250 MHz ~ 5 350 MHz BAND.....	81
11.6 TEST DATA FOR 5 470 MHz ~ 5 725 MHz BAND.....	82
11.7 TEST DATA FOR 5 725 MHz ~ 5 850 MHz BAND.....	82
12. RADIATED SPURIOUS EMISSIONS	83
12.1 OPERATING ENVIRONMENT	83
12.2 TEST SET-UP FOR CONDUCTED MEASUREMENT	83
12.3 TEST EQUIPMENT USED.....	83
12.4 TEST DATA FOR 5 150 MHz ~ 5 250 MHz BAND	84
12.4.1 Test data for 30 MHz ~ 1 000 MHz.....	84
12.4.2 Test data for Below 30 MHz.....	85
12.4.3 Test data for above 1 GHz	86
12.5 TEST DATA FOR 5 250 MHz ~ 5 350 MHz BAND	87
12.5.1 Test data for 30 MHz ~ 1 000 MHz.....	87
12.5.2 Test data for Below 30 MHz.....	88
12.5.3 Test data for above 1 GHz	89
12.6 TEST DATA FOR 5 470 MHz ~ 5 725 MHz BAND	90
12.6.1 Test data for 30 MHz ~ 1 000 MHz.....	90
12.6.2 Test data for Below 30 MHz.....	91
12.6.3 Test data for above 1 GHz	92

12.7 TEST DATA FOR 5 725 MHz ~ 5 850 MHz BAND	93
<i>12.7.1 Test data for 30 MHz ~ 1 000 MHz.....</i>	<i>93</i>
<i>12.7.2 Test data for Below 30 MHz.....</i>	<i>94</i>
<i>12.7.3 Test data for above 1 GHz</i>	<i>95</i>
13. RADIATED RESTRICTED BAND EDGE MEASUREMENTS	96
13.1 OPERATING ENVIRONMENT	96
13.2 TEST SET-UP FOR CONDUCTED MEASUREMENT	96
13.3 TEST EQUIPMENT USED	96
13.4 TEST DATA FOR 5 150 MHz ~ 5 250 MHz BAND	97
<i>13.4.1 Test data for 802.11a RLAN Mode</i>	<i>97</i>
<i>13.4.2 Test data for 802.11n_HT20 RLAN Mode.....</i>	<i>98</i>
13.5 TEST DATA FOR 5 250 MHz ~ 5 350 MHz BAND	99
<i>13.5.1 Test data for 802.11a RLAN Mode</i>	<i>99</i>
<i>13.5.2 Test data for 802.11n_HT20 RLAN Mode.....</i>	<i>100</i>
13.6 TEST DATA FOR 5 725 MHz ~ 5 850 MHz BAND	101
<i>13.6.1 Test data for 802.11a RLAN Mode</i>	<i>101</i>
<i>15.6.2 Test data for 802.11n_HT20 RLAN Mode.....</i>	<i>102</i>
14. CONDUCTED EMISSION TEST	103
14.1 OPERATING ENVIRONMENT	103
14.2 TEST SET-UP	103
14.3 TEST EQUIPMENT USED	103
14.4 TEST DATA	104
<i>14.4.1 Test data for 5 150 MHz ~ 5 250 MHz Band</i>	<i>104</i>
<i>14.4.2 Test data for 5 250 MHz ~ 5 350 MHz Band</i>	<i>106</i>
<i>14.4.3 Test data for 5 470 MHz ~ 5 725 MHz Band</i>	<i>108</i>
<i>14.4.4 Test data for 5 725 MHz ~ 5 850 MHz Band</i>	<i>110</i>
15 DYNAMIC FREQUENCY SELECTION (DFS)	112
15.1 OPERATING ENVIRONMENT	112
15.2 TEST SET-UPS	112
15.3 DFS TEST SIGNALS	113
15.4 TECHNICAL REQUIREMENT SPECIFICATION	114
15.5 TEST EQUIPMENT USED	114
15.6 TEST DATA FOR 5 250 MHz ~ 5 350 MHz BAND	115
<i>15.6.1 Plot of Radar waveform type1</i>	<i>115</i>
<i>15.6.2 No traffic signal(master signal).....</i>	<i>116</i>
<i>15.6.3 Client(EUT) Data Traifc Signal.....</i>	<i>117</i>
<i>15.6.4 Channel move and Channel Closing transmission time.....</i>	<i>118</i>

15.7 TEST DATA FOR 5 470 MHz ~ 5 725 MHz BAND 119

15.7.1 Plot of Radar waveform type1 119

15.7.2 No traffic signal(master signal)..... 120

15.7.3 Client(EUT) Data Traiifc Signal..... 121

15.7.4 Channel move and Channel Closing transmission time..... 122

Revision History

Issued Report No.	Issued Date	Revisions	Effect Section
W164R-D022	April 06, 2016	Initial Issue	All

1. VERIFICATION OF COMPLIANCE

Applicant : BLUEBIRD INC.
 Address : (Dogok-dong, SEI Tower13,14)39, Eonjuro30-gil, Gangnam-gu, Seoul, South Korea
 Contact Person : Jae-ho, Lee / Assistant Manager
 Telephone No. : +82-70-7730-8210
 FCC ID : SS4ST100
 Model Name : ST100
 Serial Number : N/A
 Date : April 06, 2016

EQUIPMENT CLASS	Unlicensed National Information infrastructure(UNII)
E.U.T. DESCRIPTION	Premium Tablet
THIS REPORT CONCERNS	Original Grant
MEASUREMENT PROCEDURES	ANSI C63.10: 2013
TYPE OF EQUIPMENT TESTED	Pre-Production
KIND OF EQUIPMENT AUTHORIZATION REQUESTED	Certification
EQUIPMENT WILL BE OPERATED UNDER FCC RULES PART(S)	FCC PART 15 SUBPART E Section 15.407
Modifications on the Equipment to Achieve Compliance	None
Final Test was Conducted On	3 m, Semi Anechoic Chamber

-. The above equipment was tested by ONETECH Corp. for compliance with the requirement set forth in the FCC Rules and Regulations. This said equipment in the configuration described in this report, shows the maximum emission levels emanating from equipment are within the compliance requirements.

2. TEST SUMMARY

2.1 Test items and results

SECTION	TEST ITEMS	RESULTS
15.407(a)	26 dB Bandwidth	PASS
15.407(a)	Maximum Conducted Output Power	Met the Limit / PASS
15.407(a)	Peak Power Spectral Density	Met the Limit / PASS
15.407(a)	Peak Excursion	Met the Limit / PASS
15.407(g)	Frequency Stability	Met the Limit / PASS
15.407(b)	Undesirable Emissions	Met the Limit / PASS
15.205, 15.407(b)	General Field Strength Limits (Restricted Bands and Radiated Emission Limits)	Met the Limit / PASS
15.207	AC Conducted Emissions 150 kHz-30 MHz	Met the Limit / PASS
15.407(h)	Dynamic frequency Selection	Met the Limit / PASS

2.2 Additions, deviations, exclusions from standards

No additions, deviations or exclusions have been made from standard.

2.3 Related Submittal(s) / Grant(s)

Original submittal only

2.4 Purpose of the test

To determine whether the equipment under test fulfills the requirements of the regulation stated in FCC PART 15 SUBPART E Section 15.407

2.5 Test Methodology

Both conducted and radiated testing was performed according to the procedures in ANSI C63.10: 2013. Radiated testing was performed at a distance of 3 m from EUT to the antenna.

2.6 Test Facility

The Onetech Corp. has been designated to perform equipment testing in compliance with ISO/IEC 17025.

The Electromagnetic compatibility measurement facilities are located at 301-14, Daessangnyeong-ri, Chowol-eup, Gwangju-si, Gyeonggi-do, 464-862 Korea.

-. Site Filing:

VCCI (Voluntary Control Council for Interference) – Registration No. R-4112/ C-4617/ G-666/ T-1842

IC (Industry Canada) – Registration No. Site# 3736A-3

-. Site Accreditation:

KOLAS (Korea Laboratory Accreditation Scheme) - Accreditation NO. KT085

FCC (Federal Communications Commission) - Accreditation No. KR0013

RRA (Radio Research Agency) – Designation No. KR0013

3. GENERAL INFORMATION

3.1 Product Description

The BLUEBIRD INC., Model ST100 (referred to as the EUT in this report) is a Premium Tablet. Product specification information described herein was obtained from product data sheet or user’s manual.

DEVICE TYPE	Premium Tablet	
FREQUENCY RANGE	5 150 MHz ~ 5 250 MHz Band	802.11a/n(HT20): 5 180 MHz ~ 5 240 MHz
	5 250 MHz ~ 5 350 MHz Band	802.11a/n(HT20): 5 260 MHz ~ 5 320 MHz
	5 470 MHz ~ 5 725 MHz Band	802.11a/n(HT20): 5 500 MHz ~ 5 700 MHz
	5 725 MHz ~ 5 850 MHz Band	802.11a/n(HT20): 5 745 MHz ~ 5 825 MHz
MAX. RF OUTPUT POWER	5 150 MHz ~ 5 250 MHz Band	Wi-Fi 802.11a (11.88 dBm) Wi-Fi 802.11n_20 MHz (11.88 dBm)
	5 250 MHz ~ 5 350 MHz Band	Wi-Fi 802.11a (11.50 dBm) Wi-Fi 802.11n_20 MHz (11.50 dBm)
	5 470 MHz ~ 5 725 MHz Band	Wi-Fi 802.11a (12.08 dBm) Wi-Fi 802.11n_20 MHz (12.14 dBm)
	5 725 MHz ~ 5 850 MHz Band	Wi-Fi 802.11a (11.55 dBm) Wi-Fi 802.11n_20 MHz (11.60 dBm)
MODULATION TYPE	OFDM Modulation(BPSK/QPSK/16QAM/64QAM)	
Antenna Gain	5 150 MHz ~ 5 250 MHz Band	0.65 dBi
	5 250 MHz ~ 5 350 MHz Band	0.66 dBi
	5 470 MHz ~ 5 725 MHz Band	0.54 dBi
	5 725 MHz ~ 5 850 MHz Band	-0.63 dBi
List of each Osc. or crystal Freq.(Freq. >= 1 MHz)	26 MHz	

3.2 Alternative type(s)/model(s); also covered by this test report.

-. None

4. EUT MODIFICATIONS

-. None

5. SYSTEM TEST CONFIGURATION

5.1 Justification

This device was configured for testing in a typical way as a normal customer is supposed to be used. During the test, the following components were installed inside of the EUT.

DEVICE TYPE	MANUFACTURER	MODEL/PART NUMBER	FCC ID
Display Controller Board	Kingdisplay	KD101N37-40NA-A1-REVB	
Display Panel	N/A	N/A	
Main Board	N/A	N/A	
Battery	Guandong TeamGiant New Energy Tech.Limited Liability Co.,LTD	BAT-ST100	
SUB Board	N/A	TVE1015IST-SUB-V1.1	
Sensor	N/A	CMK-TVE1013-B-V5B1.0	
Antenna	N/A	MICRO RF Rev 3.0	
Camera module	N/A	CMK-TVE1010I-F-V2B2.0	
Touch sensor controller Board	N/A	101332C-Q-00	
Wireless Module	HUAWEI TECHNOLOGIES CO.,LTD.	MU739	QISMU739

5.2 Peripheral equipment

Defined as equipment needed for correct operation of the EUT, but not considered as tested:

Model	Manufacturer	Description	Connected to
N/A	N/A	N/A	N/A

5.3 Mode of operation during the test

For the testing, software used to control the EUT for staying in continuous transmitting mode is programmed.

5 150 MHz ~ 5 250 MHz Band

Modulation & Channel selected	DATA RATE	OUTPUT POWER
802.11a (High Channel)	6 Mbps	11.88
	9 Mbps	11.86
	12 Mbps	11.82
	18 Mbps	11.77
	24 Mbps	11.72
	36 Mbps	11.68
	48 Mbps	11.64
	54 Mbps	11.54
802.11n(HT20) (High Channel)	6.5 Mbps	11.88
	13 Mbps	11.84
	19.5 Mbps	11.81
	26 Mbps	11.76
	39 Mbps	11.69
	52 Mbps	11.64
	58.5 Mbps	11.64
	65 Mbps	11.56

The worse case data rate for each modulation is determined 6 Mbps for IEEE 802.11a and 6.5 Mbps for IEEE 802.11n(HT20).

- To get a maximum emission levels from the EUT, the EUT was moved throughout the XY, XZ, and YZ planes and the worst case is “XY” axis.

5 250 MHz ~ 5 350 MHz Band

Modulation & Channel selected	DATA RATE	OUTPUT POWER
802.11a (Middle Channel)	6 Mbps	11.50
	9 Mbps	11.41
	12 Mbps	11.41
	18 Mbps	11.40
	24 Mbps	11.33
	36 Mbps	11.28
	48 Mbps	11.20
	54 Mbps	11.14
802.11n(HT20) (Middle Channel)	6.5 Mbps	11.50
	13 Mbps	11.43
	19.5 Mbps	11.39
	26 Mbps	11.34
	39 Mbps	11.28
	52 Mbps	11.26
	58.5 Mbps	11.19
	65 Mbps	11.15

The worse case data rate for each modulation is determined 6 Mbps for IEEE 802.11a and 6.5 Mbps for IEEE 802.11n(HT20).

- To get a maximum emission levels from the EUT, the EUT was moved throughout the XY, XZ, and YZ planes and the worst case is “XY” axis.

5 470 MHz ~ 5 725 MHz Band

Modulation & Channel selected	DATA RATE	OUTPUT POWER
802.11a (Low Channel)	6 Mbps	12.08
	9 Mbps	12.02
	12 Mbps	12.00
	18 Mbps	11.94
	24 Mbps	11.88
	36 Mbps	11.84
	48 Mbps	11.79
	54 Mbps	11.76
802.11n(HT20) (Low Channel)	6.5 Mbps	12.14
	13 Mbps	12.06
	19.5 Mbps	12.05
	26 Mbps	11.94
	39 Mbps	11.90
	52 Mbps	11.87
	58.5 Mbps	11.80
	65 Mbps	11.74

The worse case data rate for each modulation is determined 6 Mbps for IEEE 802.11a and 6.5 Mbps for IEEE 802.11n(HT20).

- To get a maximum emission levels from the EUT, the EUT was moved throughout the XY, XZ, and YZ planes and the worst case is “XY” axis.

5 725 MHz ~ 5 850 MHz Band

Modulation & Channel selected	DATA RATE	OUTPUT POWER
802.11a (Low Channel)	6 Mbps	11.55
	9 Mbps	11.52
	12 Mbps	11.49
	18 Mbps	11.50
	24 Mbps	11.47
	36 Mbps	11.44
	48 Mbps	11.43
	54 Mbps	11.42
802.11n(HT20) (Low Channel)	6.5 Mbps	11.60
	13 Mbps	11.57
	19.5 Mbps	11.56
	26 Mbps	11.53
	39 Mbps	11.52
	52 Mbps	11.50
	58.5 Mbps	11.51
	65 Mbps	11.48

The worse case data rate for each modulation is determined 6 Mbps for IEEE 802.11a and 6.5 Mbps for IEEE 802.11n(HT20).

- To get a maximum emission levels from the EUT, the EUT was moved throughout the XY, XZ, and YZ planes and the worst case is “XY” axis.

5.4 Configuration of Test System

Line Conducted Test: The EUT was tested in a Transmitting mode. The EUT was connected to USB and the power of USB was connected to Adapter. All supporting equipments were connected to another LISN. Preliminary Power line Conducted Emission test was performed by using the procedure in ANSI C63.10: 2013 to determine the worse operating conditions.

Radiated Emission Test: Preliminary radiated emissions test were conducted using the procedure in ANSI C63.10: 2013 to determine the worse operating conditions. Final radiated emission tests were conducted at 3 meter open area test site.

The turntable was rotated through 360 degrees and the EUT was tested by positioned three orthogonal planes to obtain the highest reading on the field strength meter. Once maximum reading was determined, the search antenna was raised and lowered in both vertical and horizontal polarization.

5.5 Antenna Requirement

For intentional device, according to section 15.203, an intentional radiator shall be designed to ensure that no antenna other than that furnished by the responsible party shall be used with the device.

Antenna Construction:

The antenna of the EUT is a PIFA Antenna on the main board in the EUT, so no consideration of replacement by the user.

6. PRELIMINARY TEST

6.1 AC Power line Conducted Emissions Tests

During Preliminary Test, the following operating mode was investigated.

Operation Mode	The Worse operating condition (Please check one only)
Transmitting Mode	X

6.2 General Radiated Emissions Tests

During Preliminary Test, the following operating mode was investigated.

Operation Mode	The Worse operating condition (Please check one only)
Transmitting Mode	X

7. MIMIMUM 26 dB BANDWIDTH

7.1 Operating environment

Temperature : 23 °C

Relative humidity : 47 % R.H.

7.2 Test set-up

The antenna output of the EUT was connected to the spectrum analyzer. The resolution bandwidth is set to 100 kHz, and peak detection was used. The 26 dB bandwidth is defined as the total spectrum over which the power is higher than the peak power minus 26 dB.

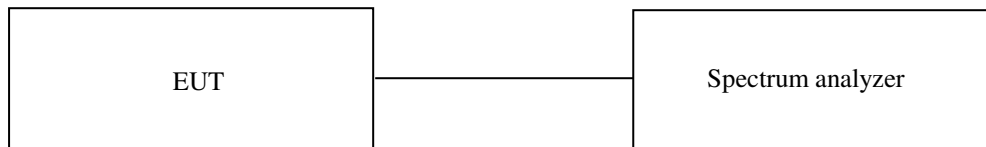

7.3 Test equipment used

Model Number	Manufacturer	Description	Serial Number	Last Cal.
■ - FSV40	Rohde & Schwarz	Signal Analyzer	101009	Jul. 22, 2015 (1Y)

All test equipment used is calibrated on a regular basis.

7.4.1 Test data for 802.11a RLAN Mode

- Test Date : March 10, 2016

- Test Result : Pass

FREQUENCY RANGE (MHz)	CHANNEL	FREQUENCY (MHz)	26 dB Bandwidth (MHz)
5 150 ~ 5 250	Low	5 180	18.38
	Middle	5 200	18.38
	High	5 240	18.38
5 250 ~ 5 350	Low	5 260	18.38
	Middle	5 300	18.38
	High	5 320	18.38
5 470 ~ 5 725	Low	5 500	18.38
	Middle	5 600	18.38
	High	5 700	18.38
5 725 ~ 5 850	Low	5 745	18.38
	Middle	5 785	18.38
	High	5 825	18.38



Tested by: Jun-Hui, Lee / Senior Engineer

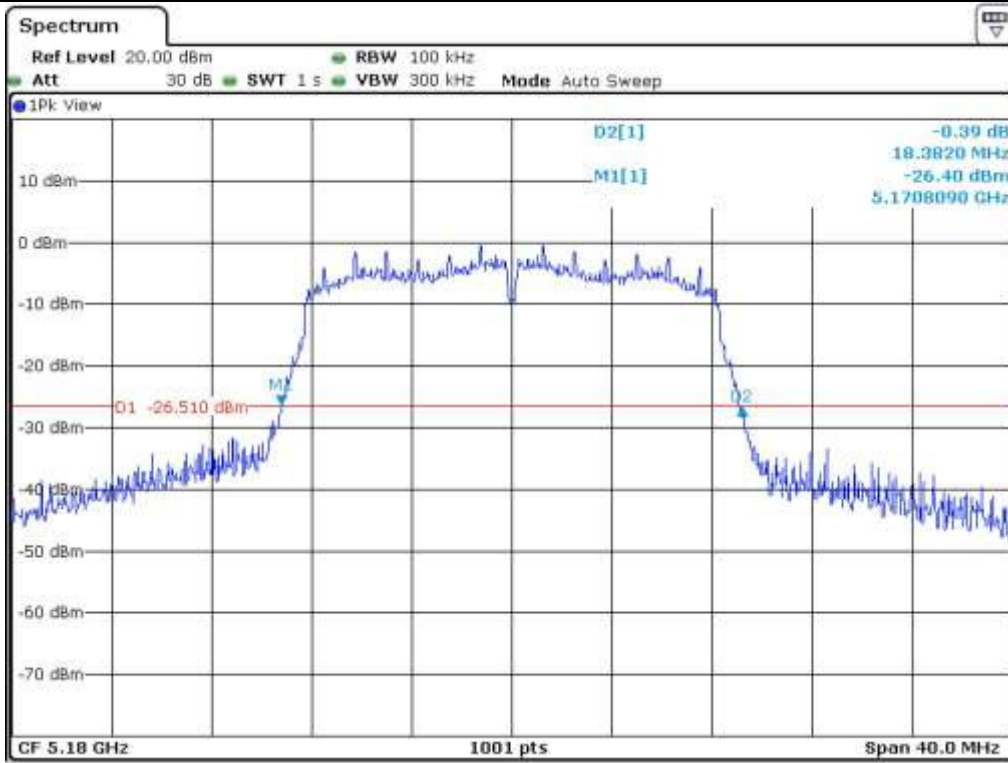

Low Channel (5 180 MHz)

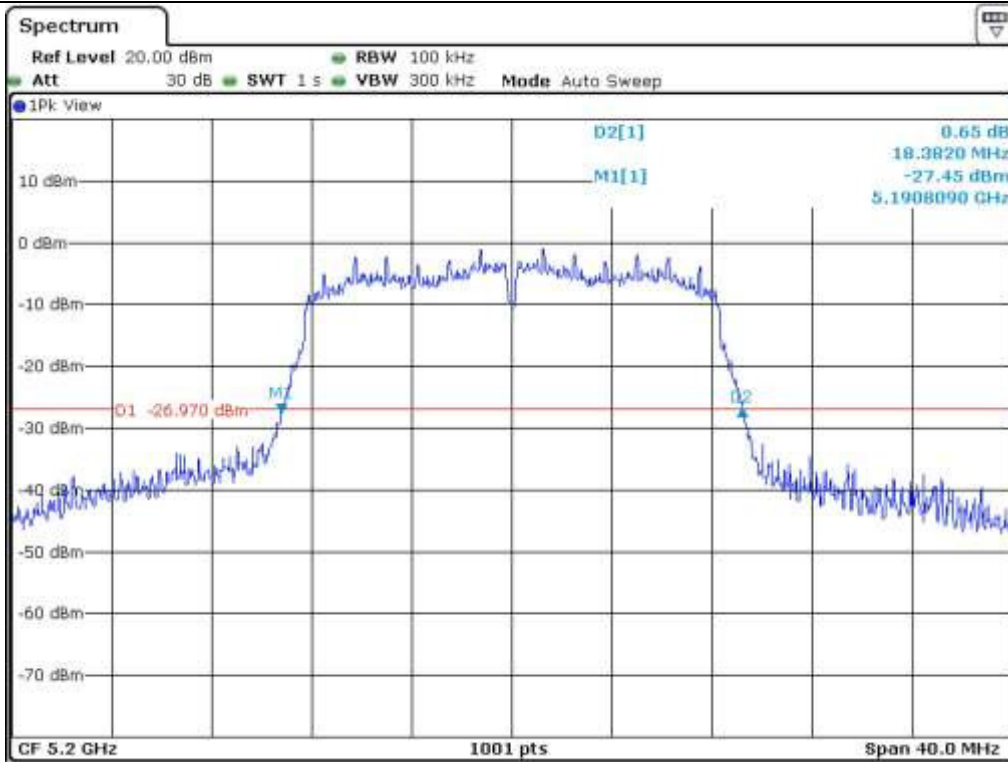

Middle Channel (5 200 MHz)

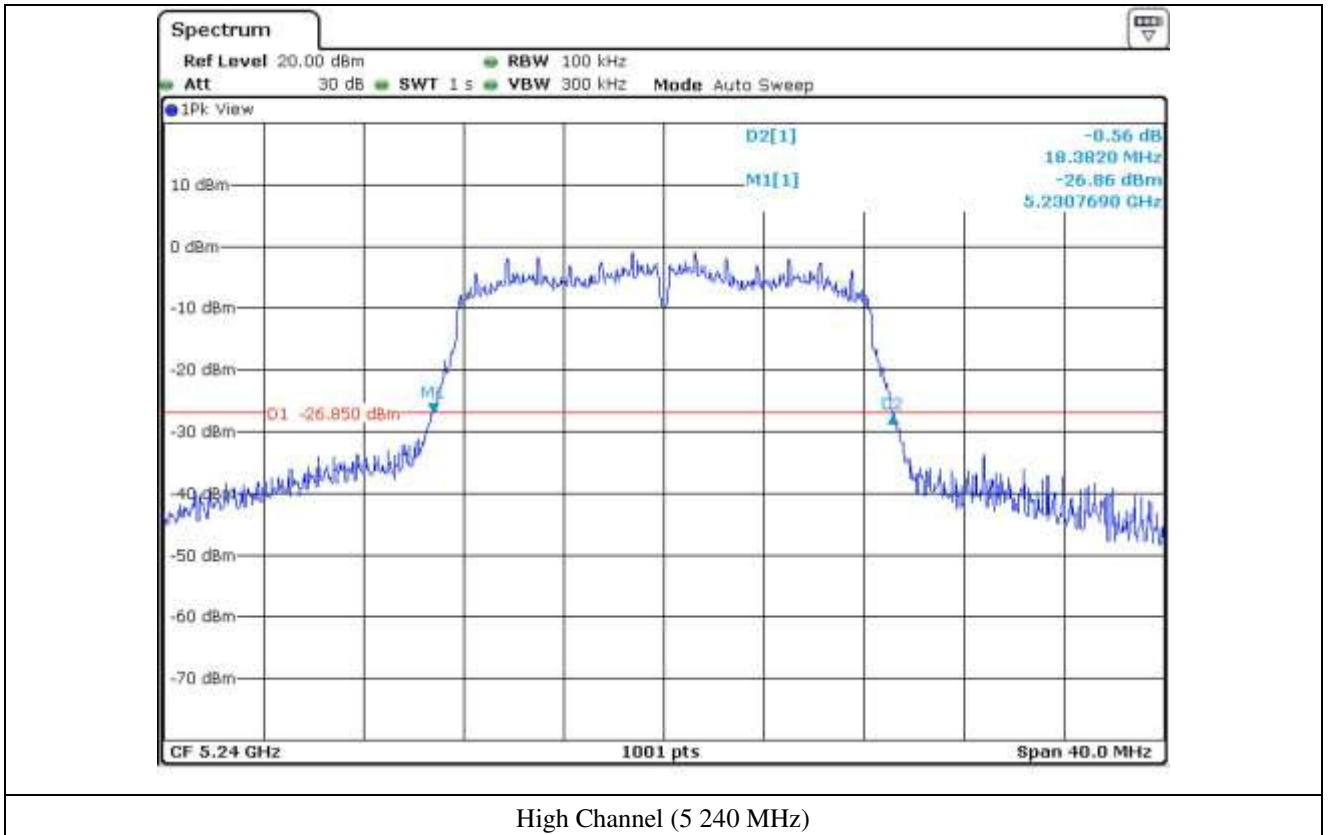

High Channel (5 240 MHz)

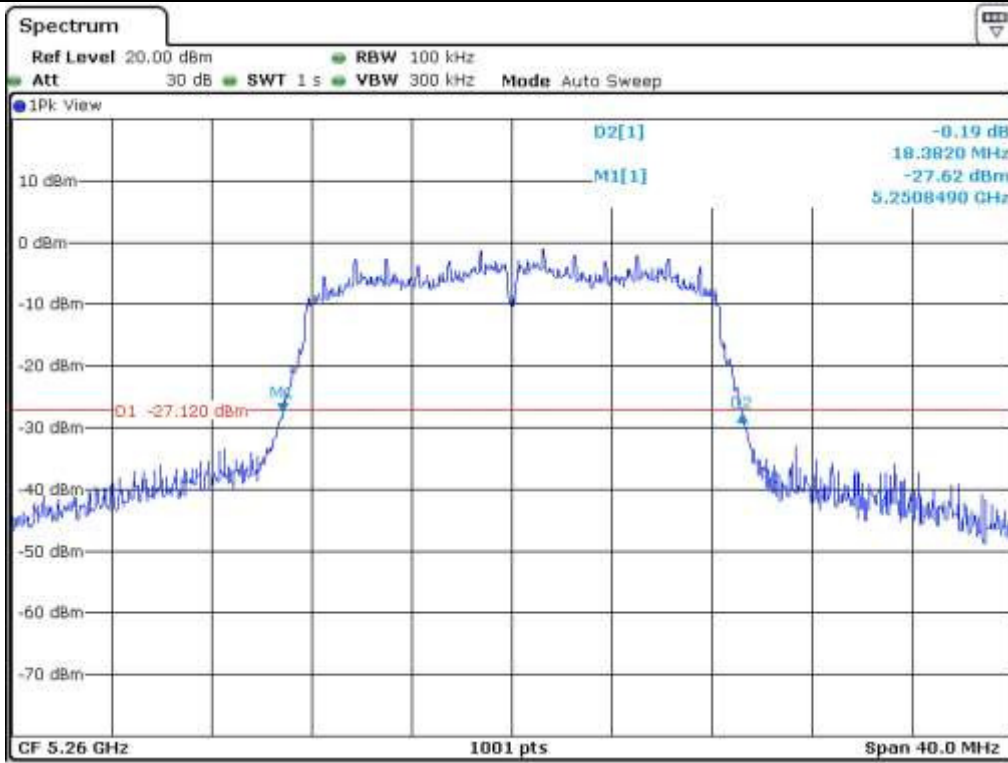

Low Channel (5 260 MHz)

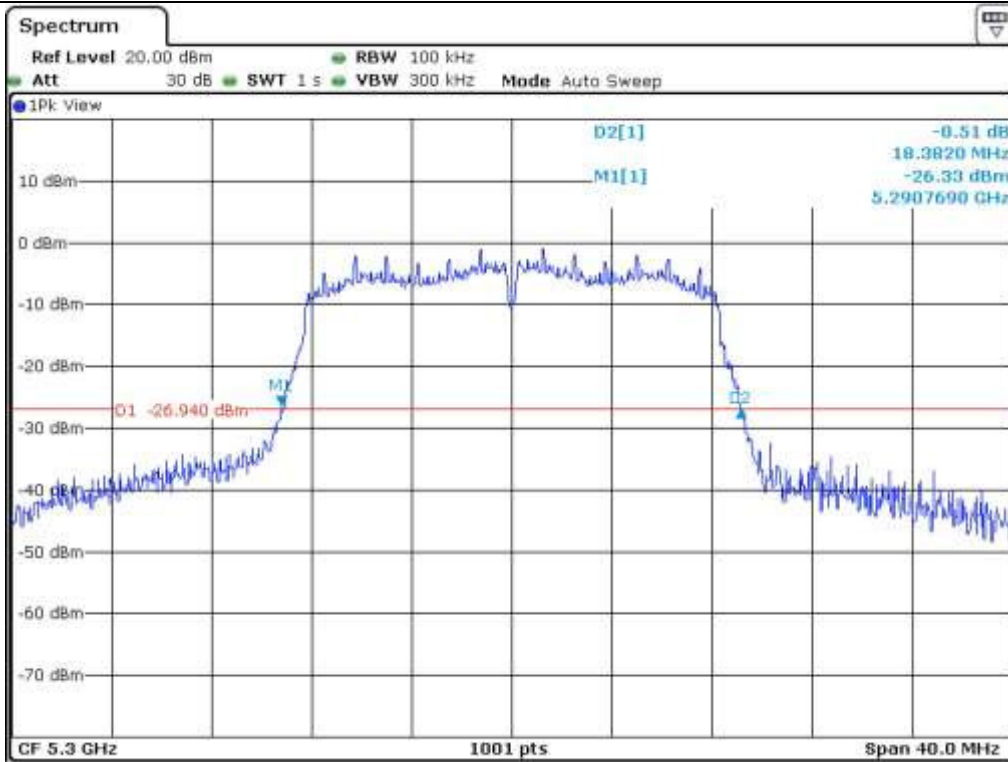

Middle Channel (5 300 MHz)

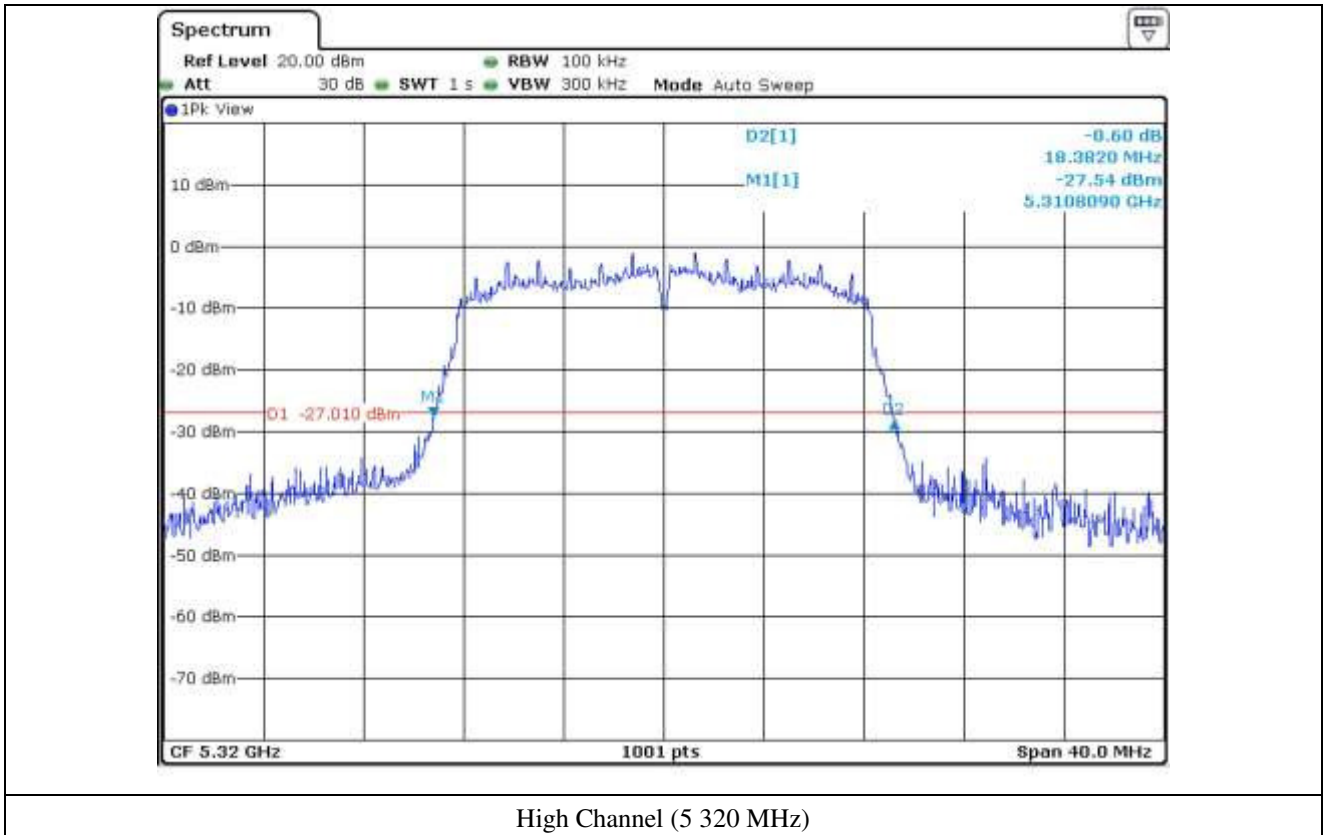

High Channel (5 320 MHz)

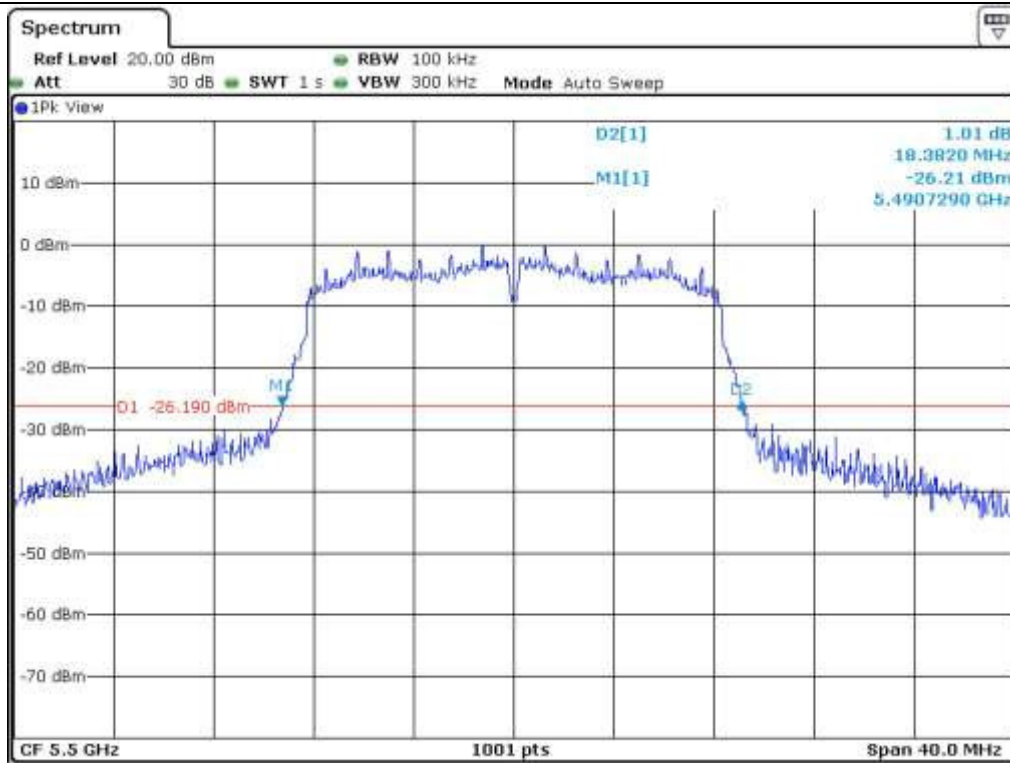

Low Channel (5 500 MHz)

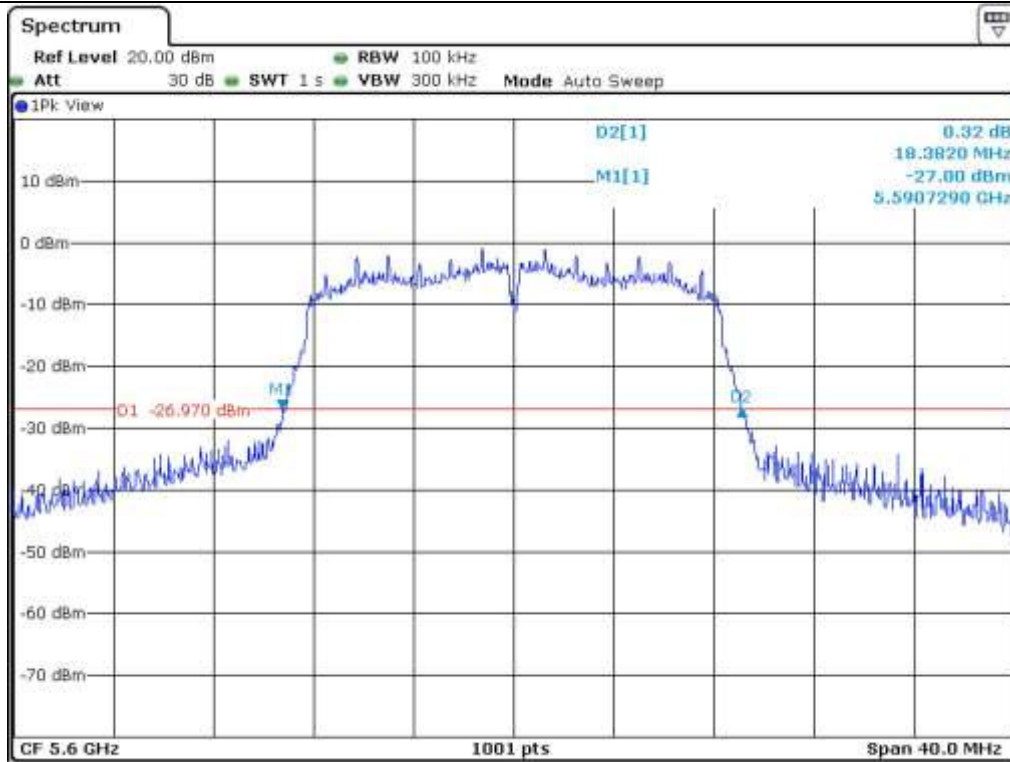

Middle Channel (5 600 MHz)

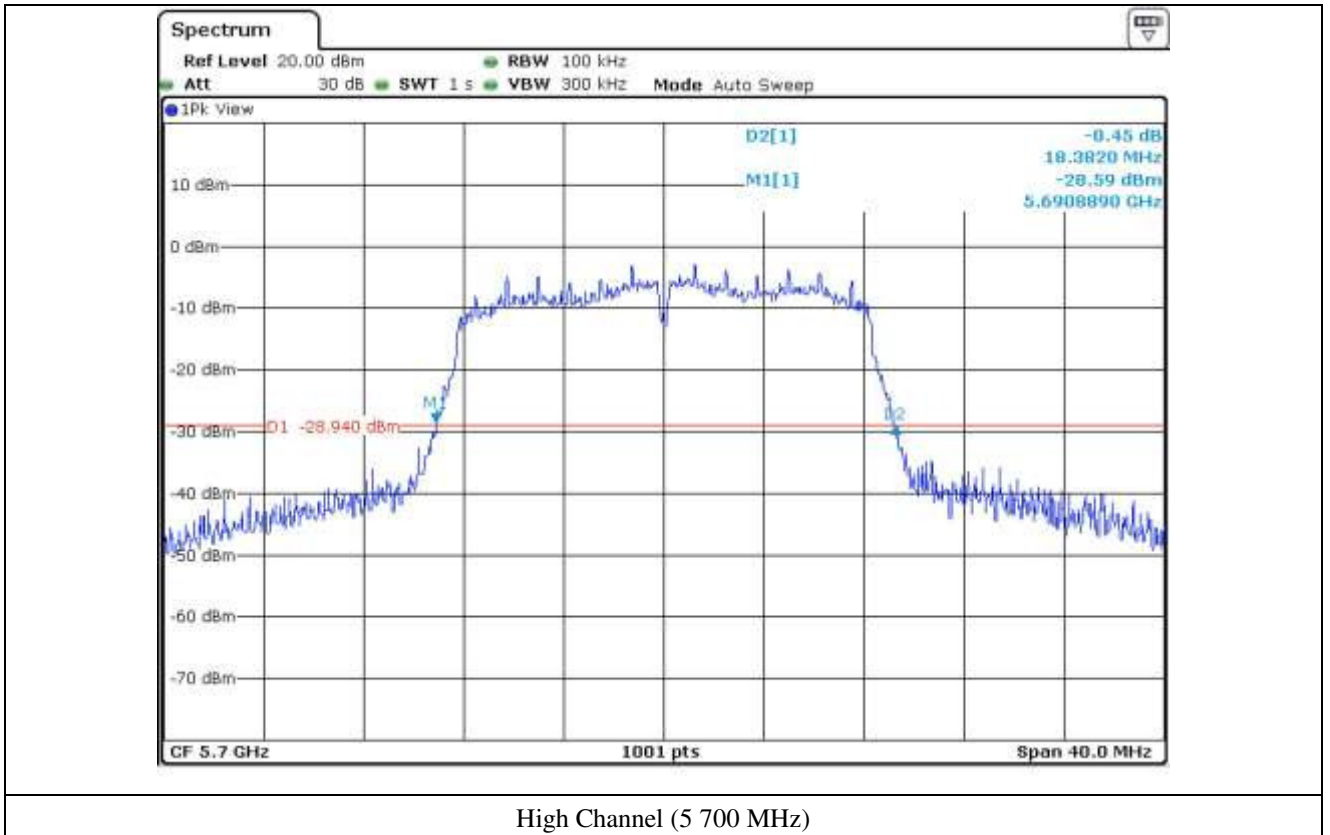

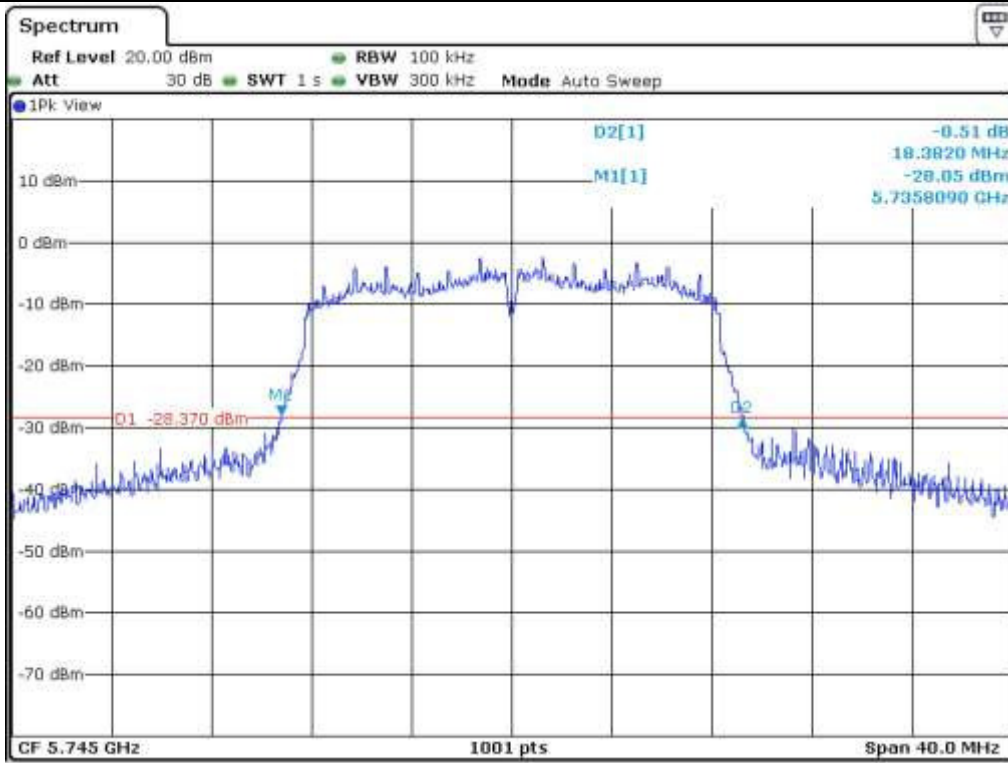

Low Channel (5.745 MHz)

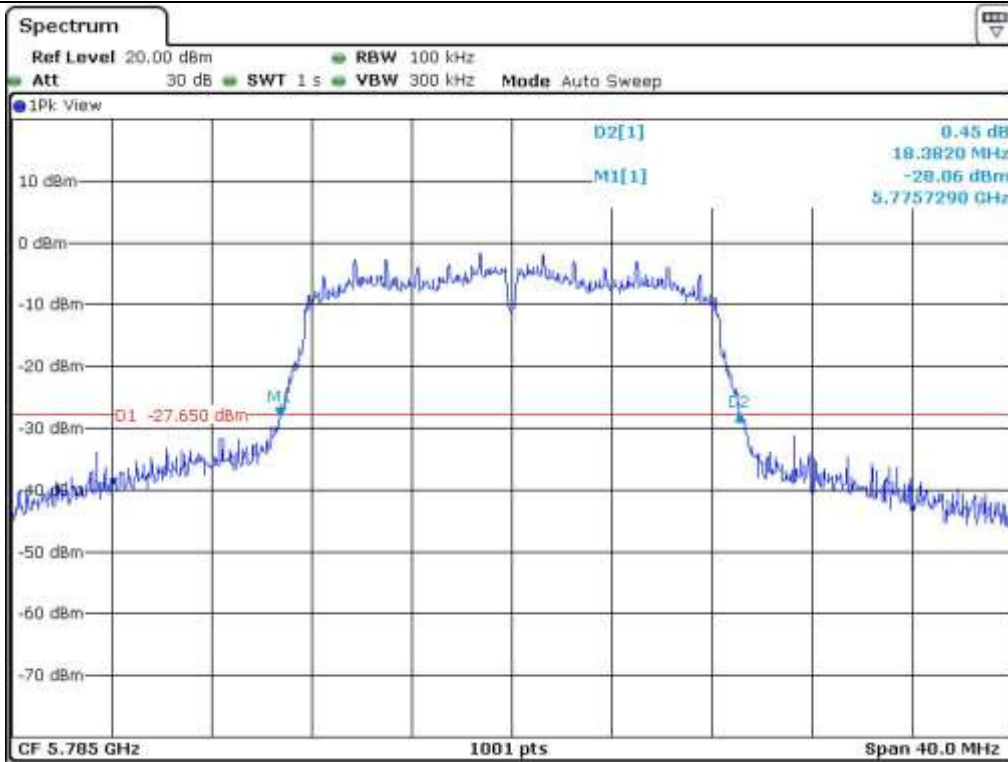

Middle Channel (5.785 MHz)

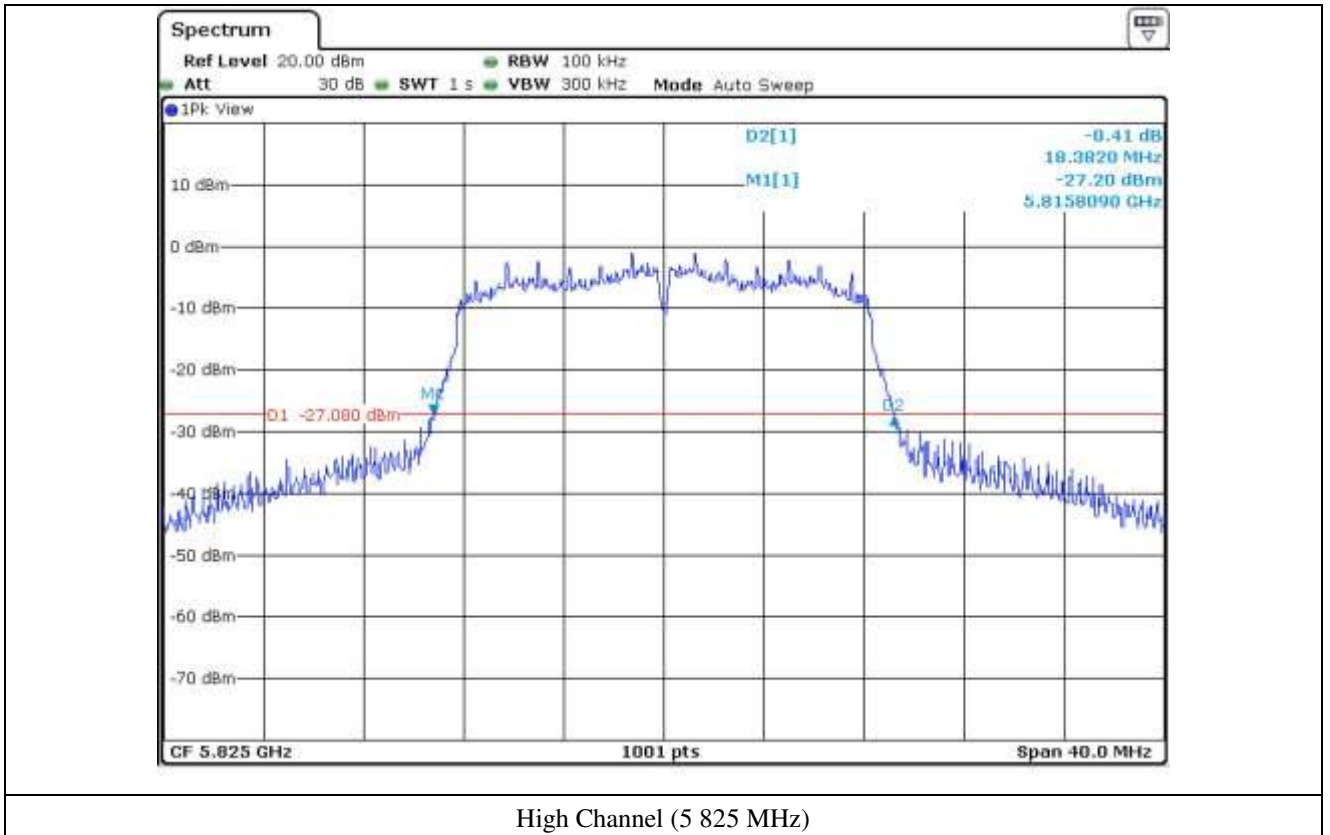

7.4.2 Test data for 802.11n_HT20 RLAN Mode

- Test Date : March 10, 2016

- Test Result : Pass

FREQUENCY RANGE (MHz)	CHANNEL	FREQUENCY (MHz)	26 dB Bandwidth (MHz)
5 150 ~ 5 250	Low	5 180	18.74
	Middle	5 200	18.74
	High	5 240	18.74
5 250 ~ 5 350	Low	5 260	18.74
	Middle	5 300	18.74
	High	5 320	18.74
5 470 ~ 5 725	Low	5 500	18.74
	Middle	5 600	18.74
	High	5 700	18.74
5 725 ~ 5 850	Low	5 745	18.74
	Middle	5 785	18.74
	High	5 825	18.74



Tested by: Jun-Hui, Lee / Senior Engineer

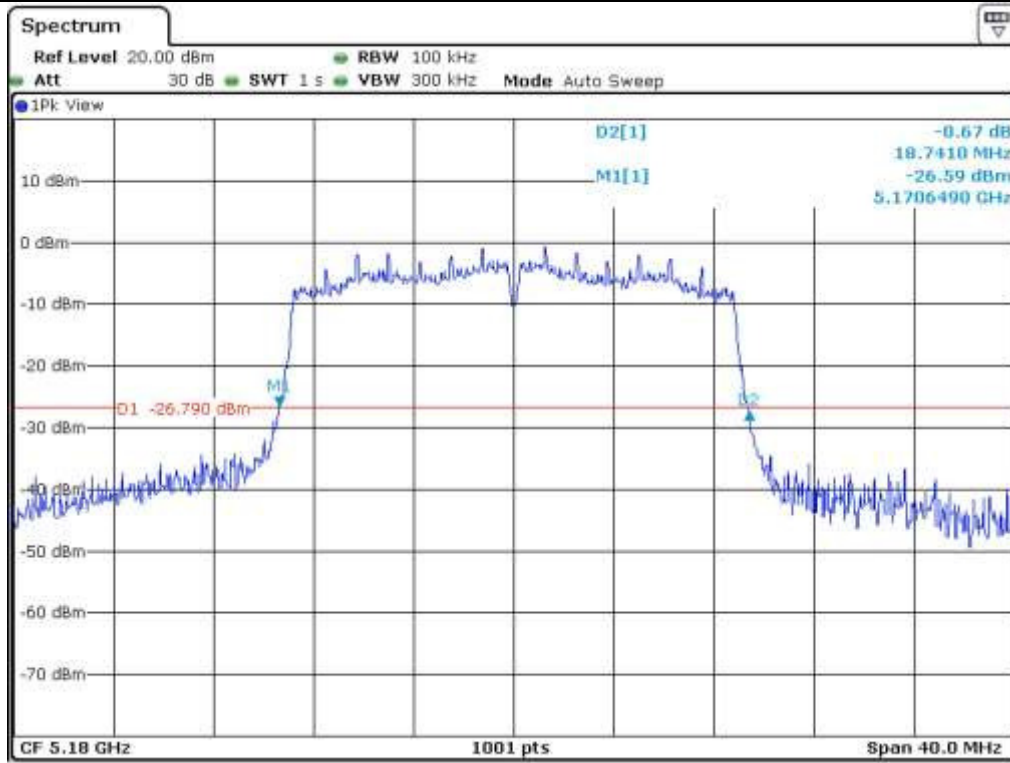

Low Channel (5 180 MHz)

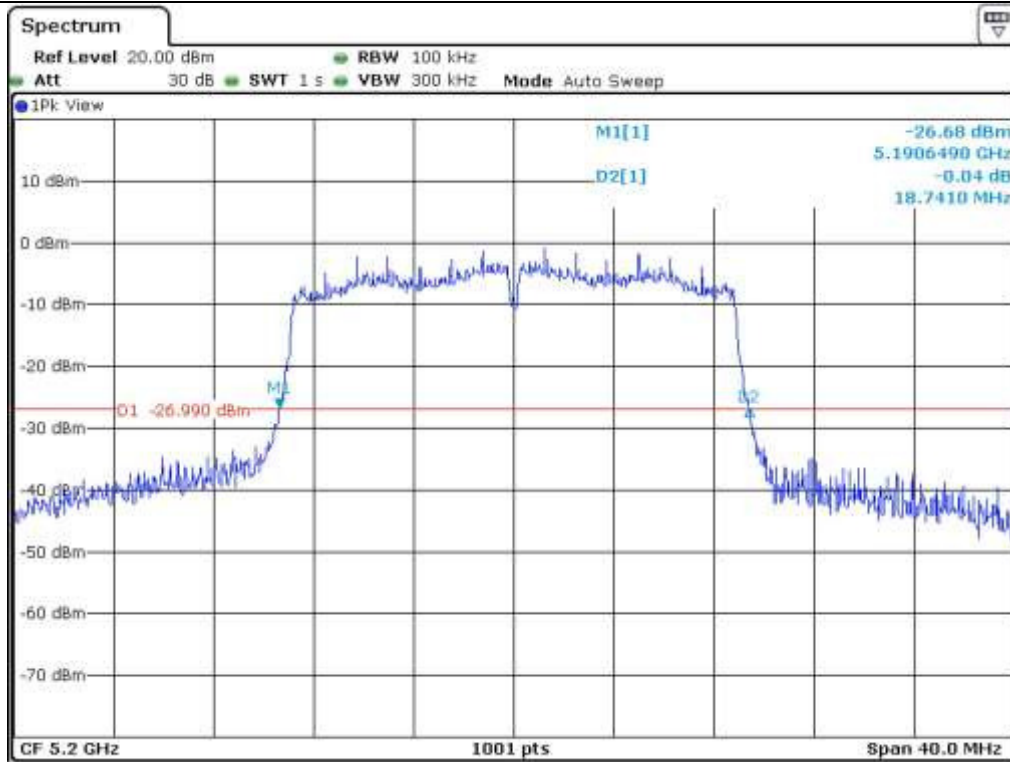

Middle Channel (5 200 MHz)

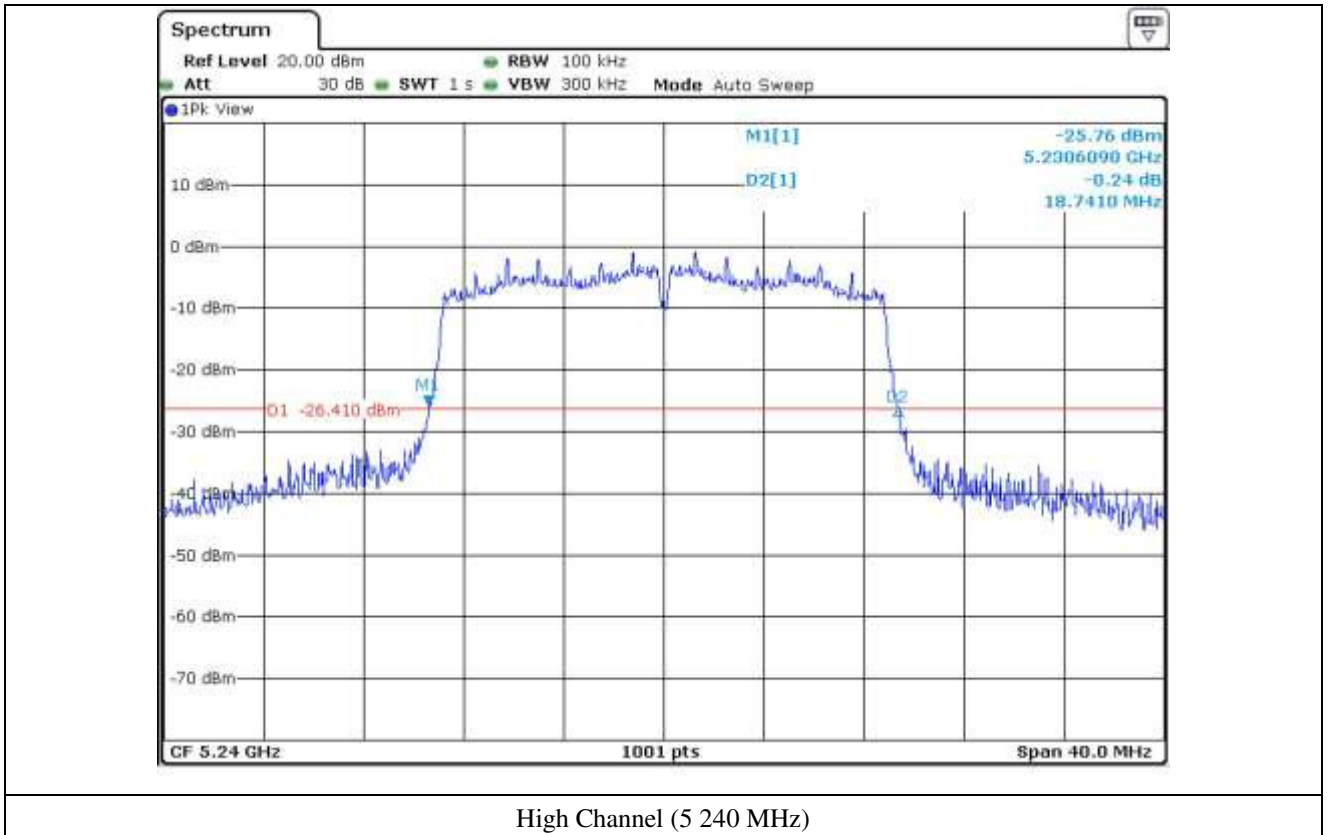

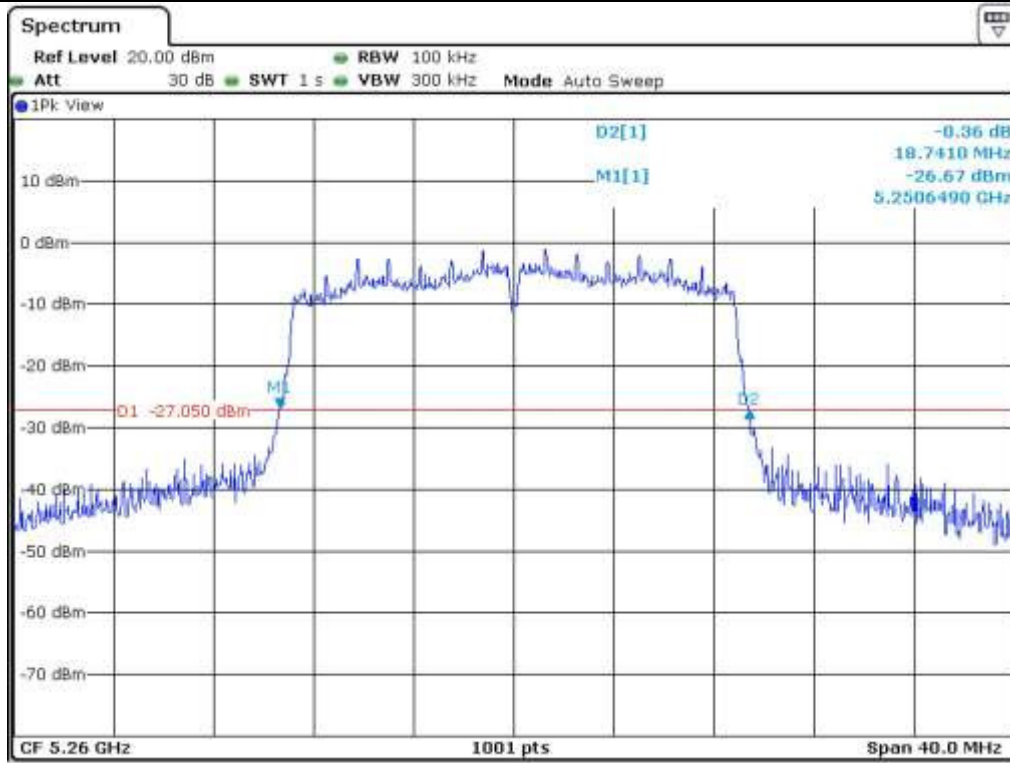

Low Channel (5 260 MHz)

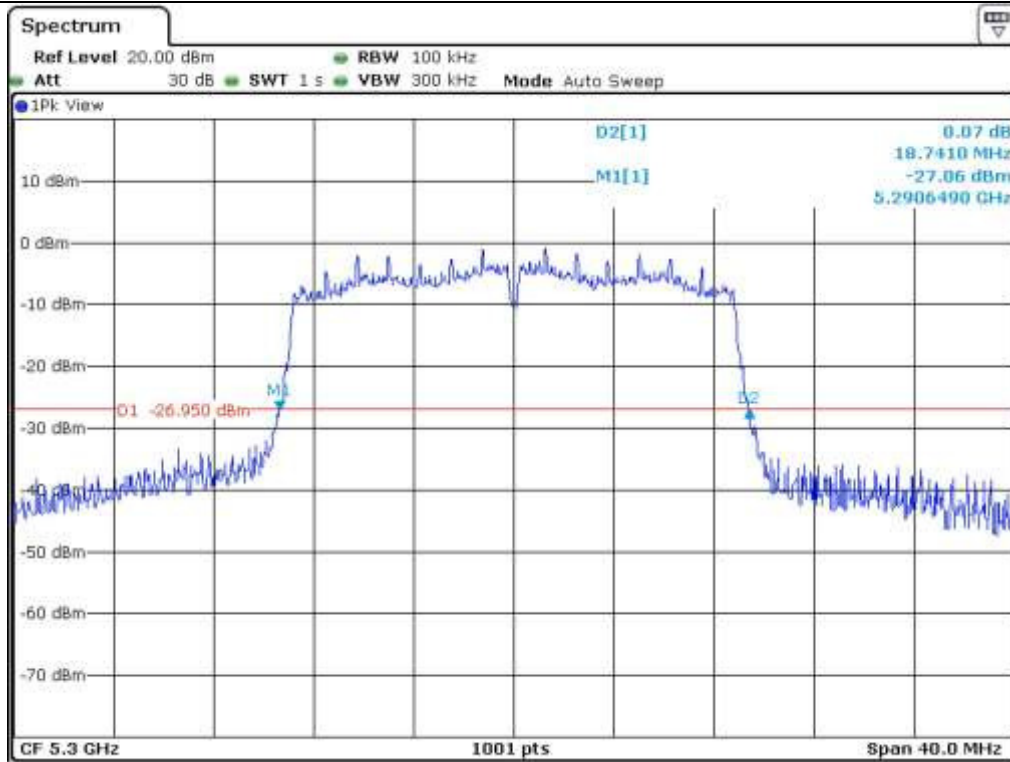

Middle Channel (5 300 MHz)

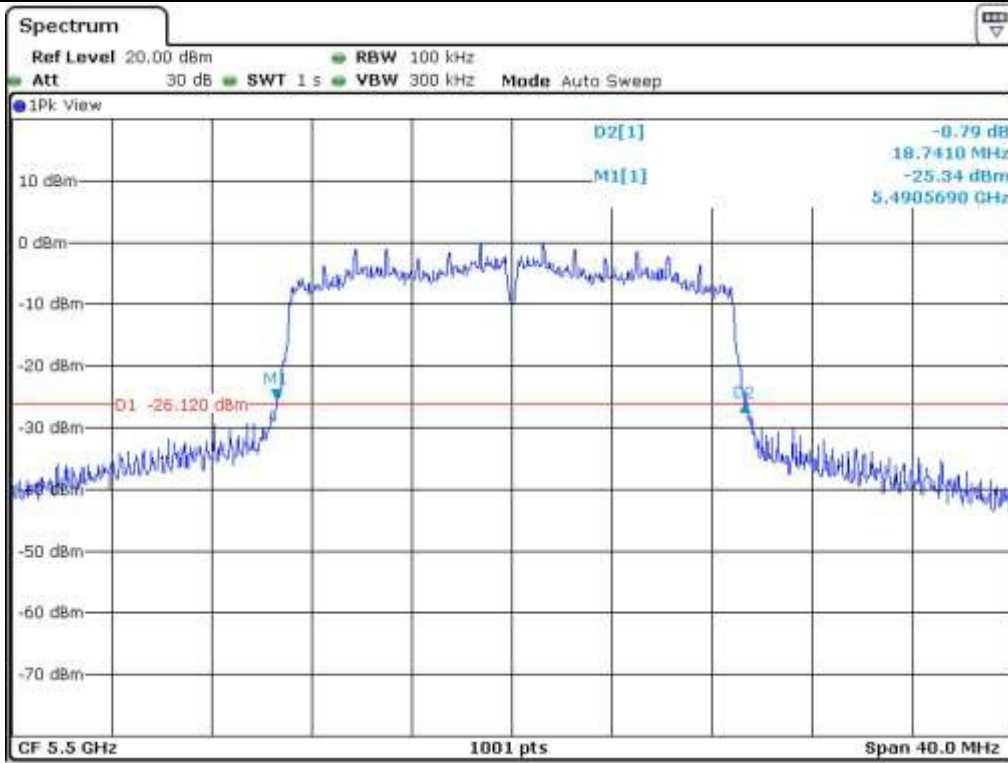

Low Channel (5 500 MHz)

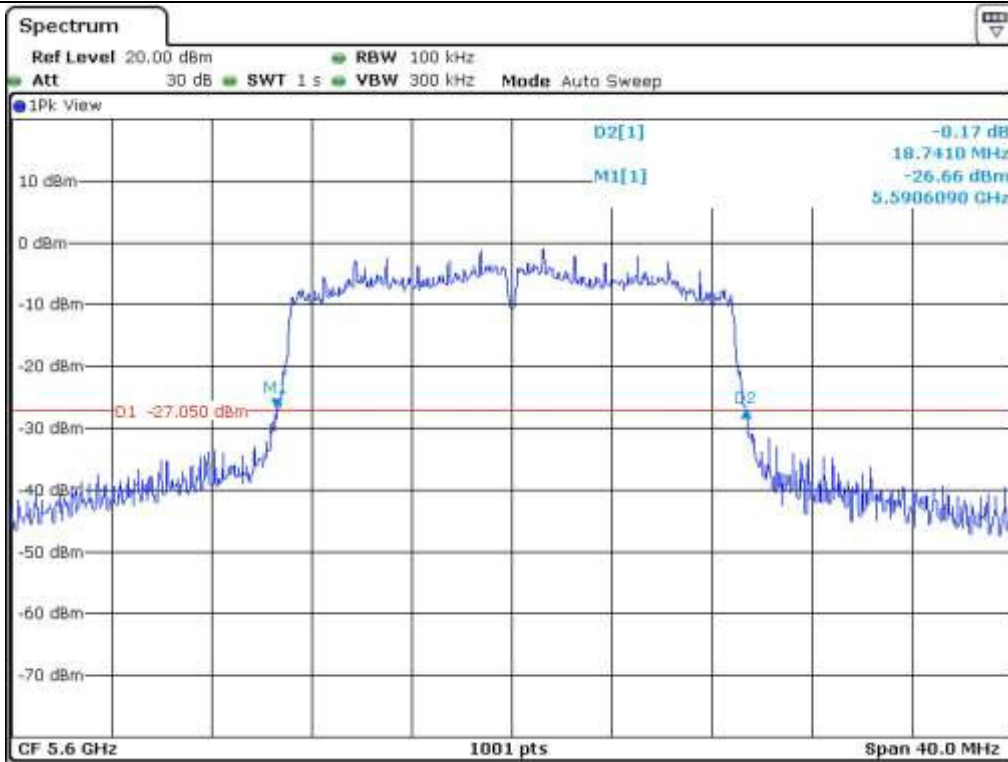

Middle Channel (5 600 MHz)

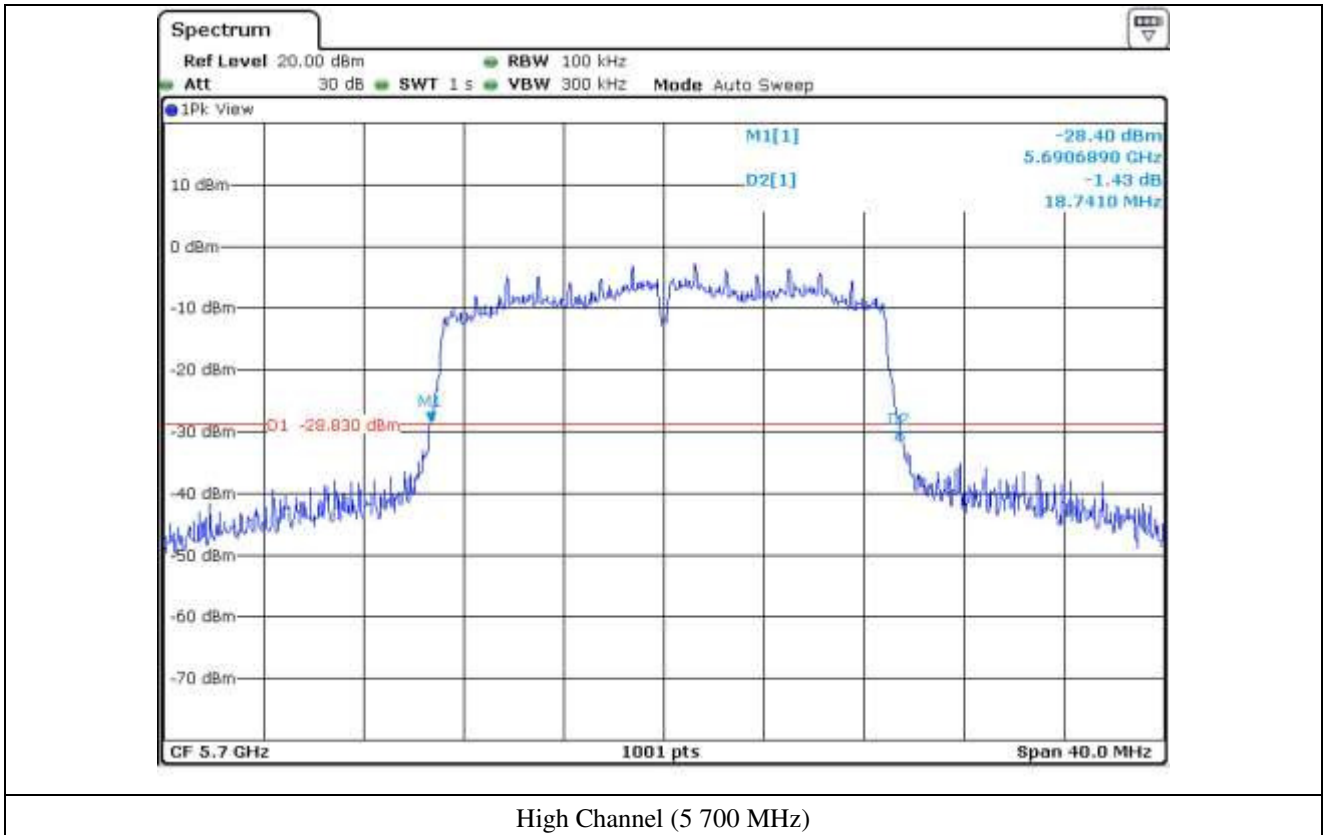

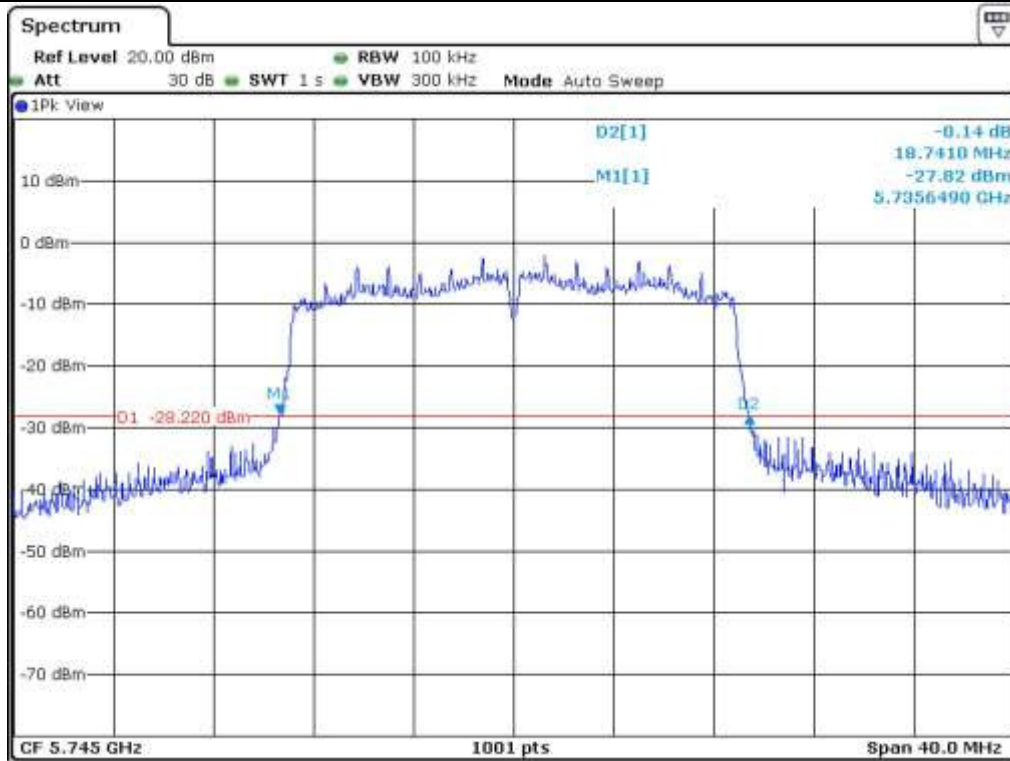

Low Channel (5.745 MHz)

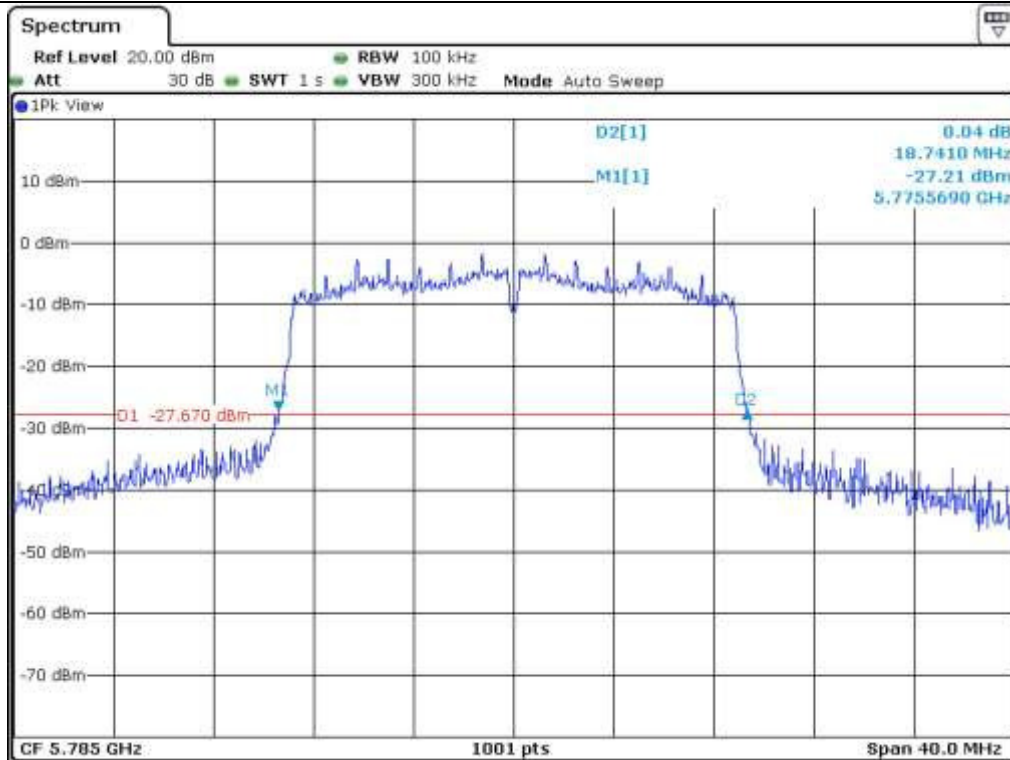

Middle Channel (5.785 MHz)

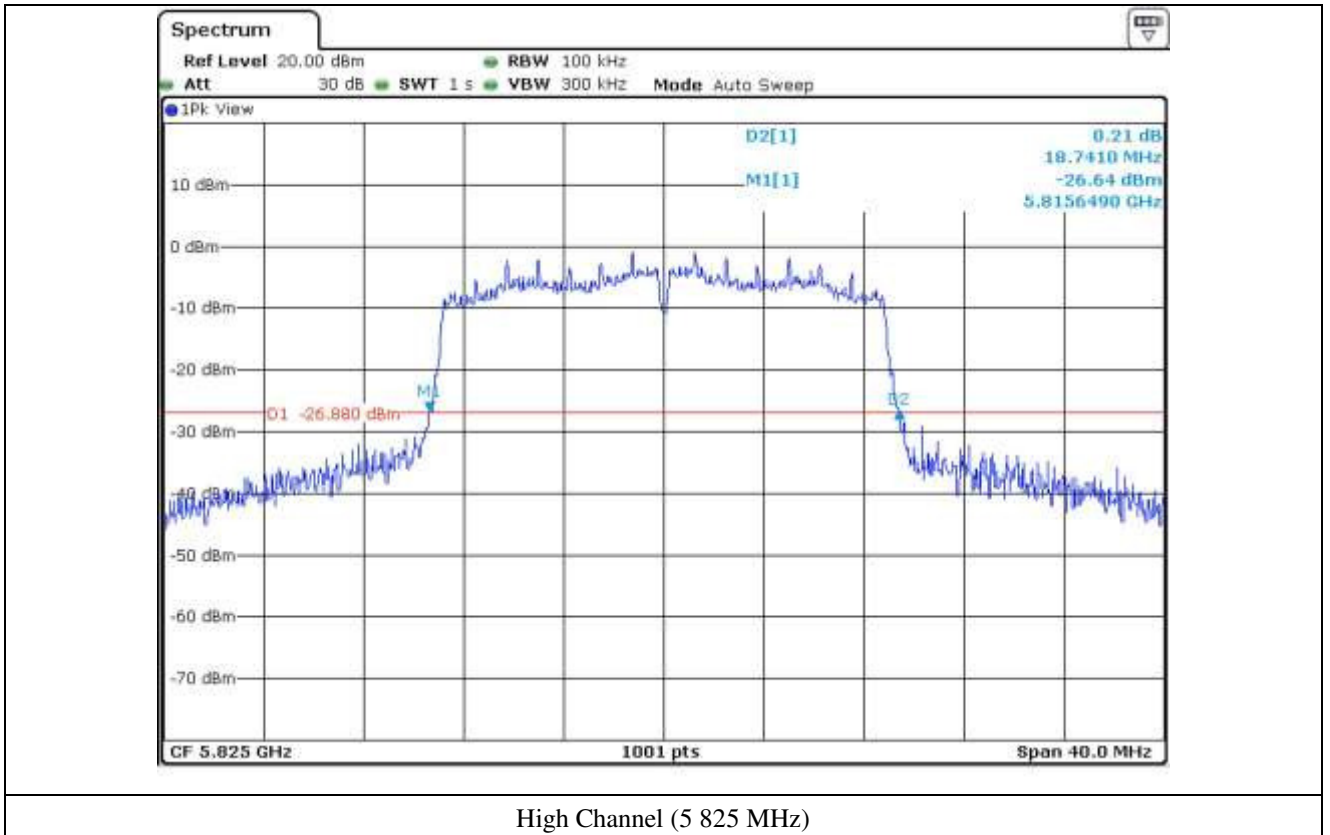

High Channel (5 825 MHz)

8. MAXIMUM PEAK OUTPUT POWER

8.1 Operating environment

Temperature : 23 °C
 Relative humidity : 47 % R.H.

8.2 Test set-up

The maximum peak output power was measured with the spectrum analyzer connected to the antenna output of the EUT. The spectrum analyzer's internal channel power integration function is used to integrate the power over a bandwidth greater than or equal to the 99 % bandwidth. The EUT was operating in transmit mode at the appropriate center frequency.

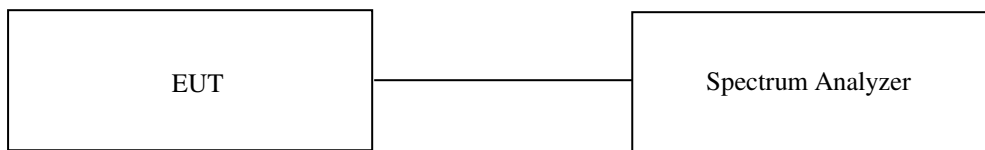

8.3 Test equipment used

Model Number	Manufacturer	Description	Serial Number	Last Cal.
■ - FSV40	Rohde & Schwarz	Signal Analyzer	101009	Jul. 22, 2015 (1Y)

All test equipment used is calibrated on a regular basis.

8.4 Test data for 802.11a RLAN Mode

- Test Date : March 10, 2016

- Test Result : Pass

FREQUENCY RANGE (MHz)	CHANNEL	FREQUENCY (MHz)	26 dB Bandwidth (MHz)	MEASURED VLAUE (dBm)	LIMIT (dBm)	MARGIN (dB)
5 150 ~ 5 250	Low	5 180	18.38	11.88	23.98	12.10
	Middle	5 200	18.38	11.67	23.98	12.31
	High	5 240	18.38	11.82	23.98	12.16
5 250 ~ 5 350	Low	5 260	18.38	11.27	23.98	12.71
	Middle	5 300	18.38	11.50	23.98	12.48
	High	5 320	18.38	11.27	23.98	12.71
5 470 ~ 5 725	Low	5 500	18.38	12.08	23.98	11.90
	Middle	5 600	18.38	11.27	23.98	12.71
	High	5 700	18.38	9.15	23.98	14.83
5 725 ~ 5 850	Low	5 745	18.38	10.56	30.00	19.44
	Middle	5 785	18.38	11.03	30.00	18.97
	High	5 825	18.38	11.55	30.00	18.45

Remark: See next page for measurement data.



Tested by: Jun-Hui, Lee / Senior Engineer



Low Channel @ 5 180 MHz (26 dB Bandwidth)

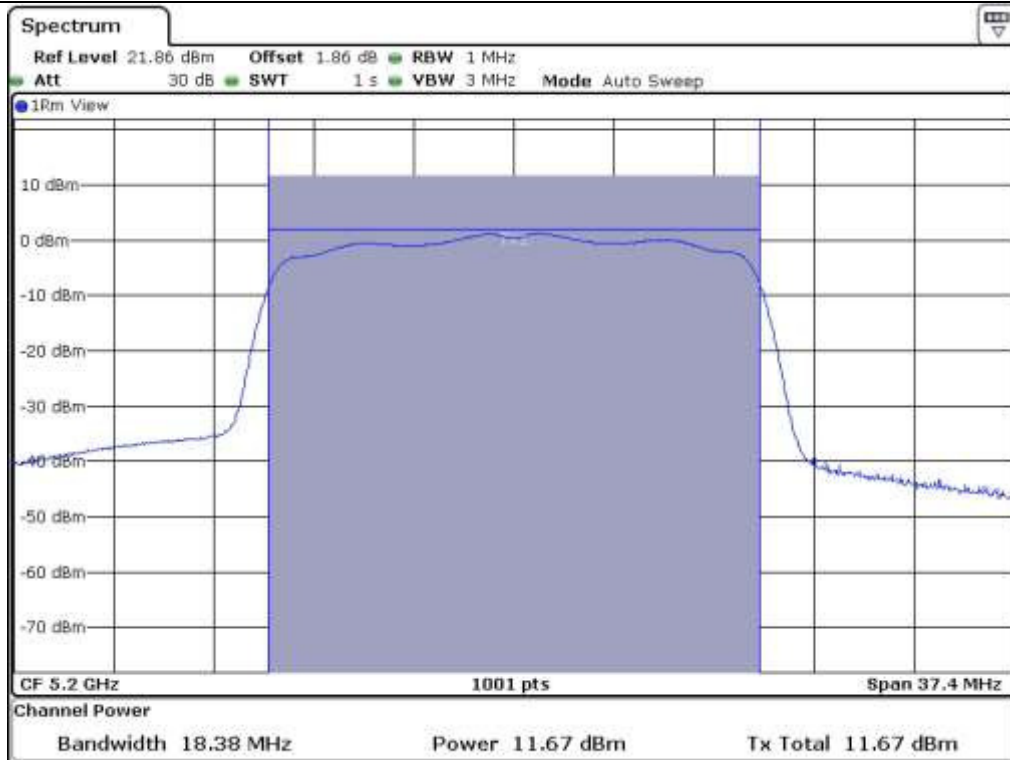

Middle Channel @ 5 200 MHz (26 dB Bandwidth)

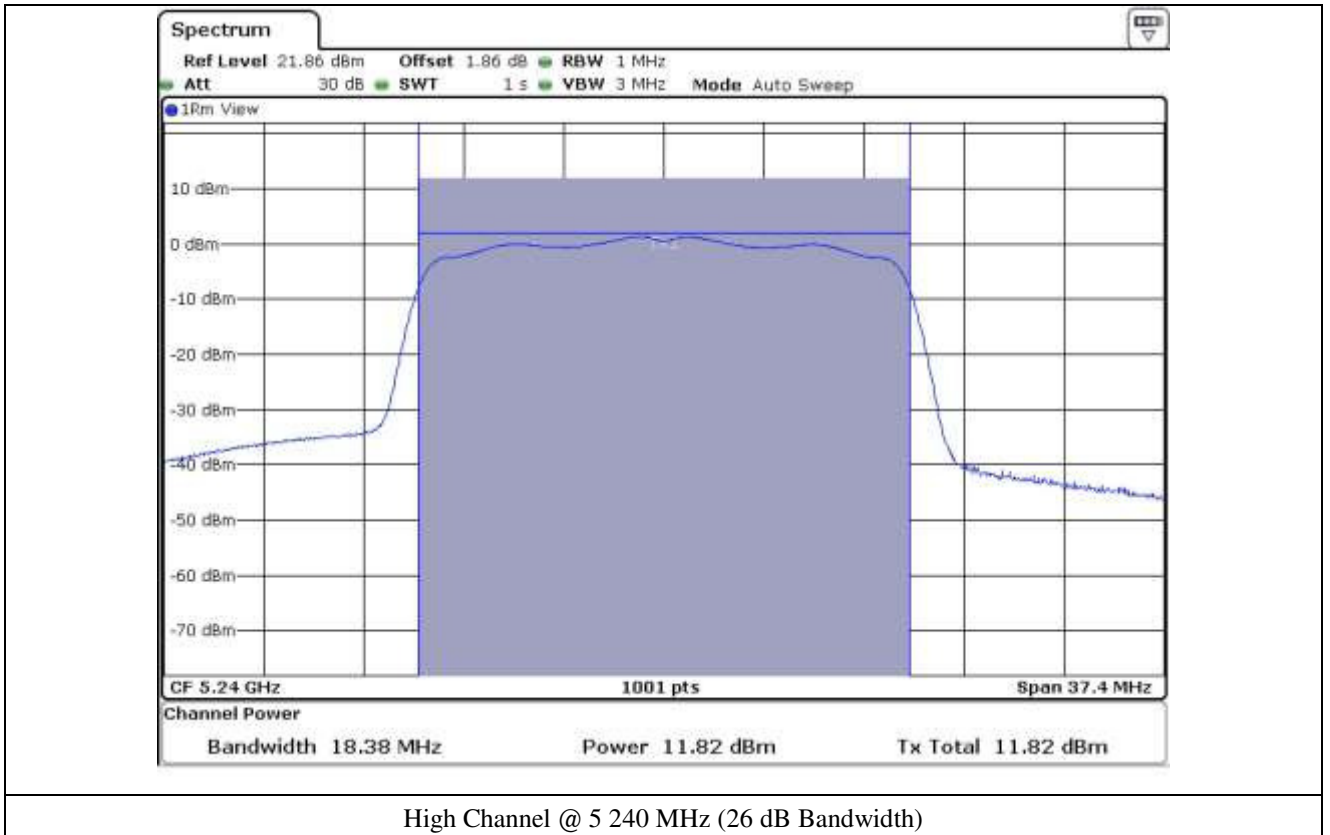

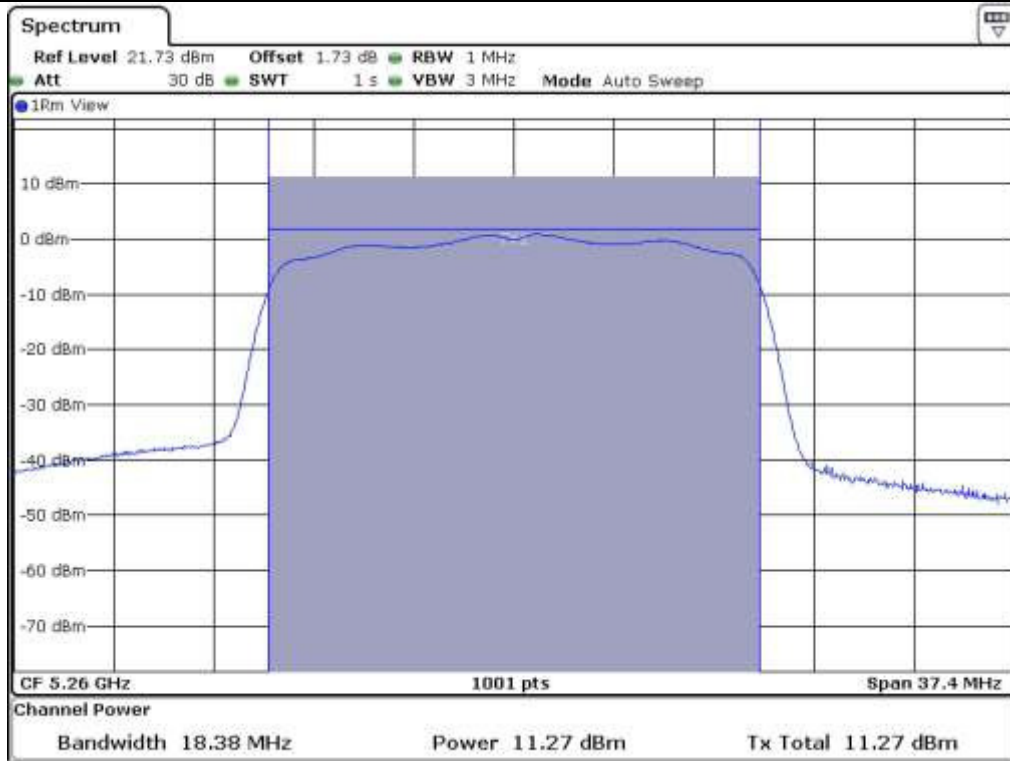

Low Channel @ 5 260 MHz (26 dB Bandwidth)



Middle Channel @ 5 300 MHz (26 dB Bandwidth)

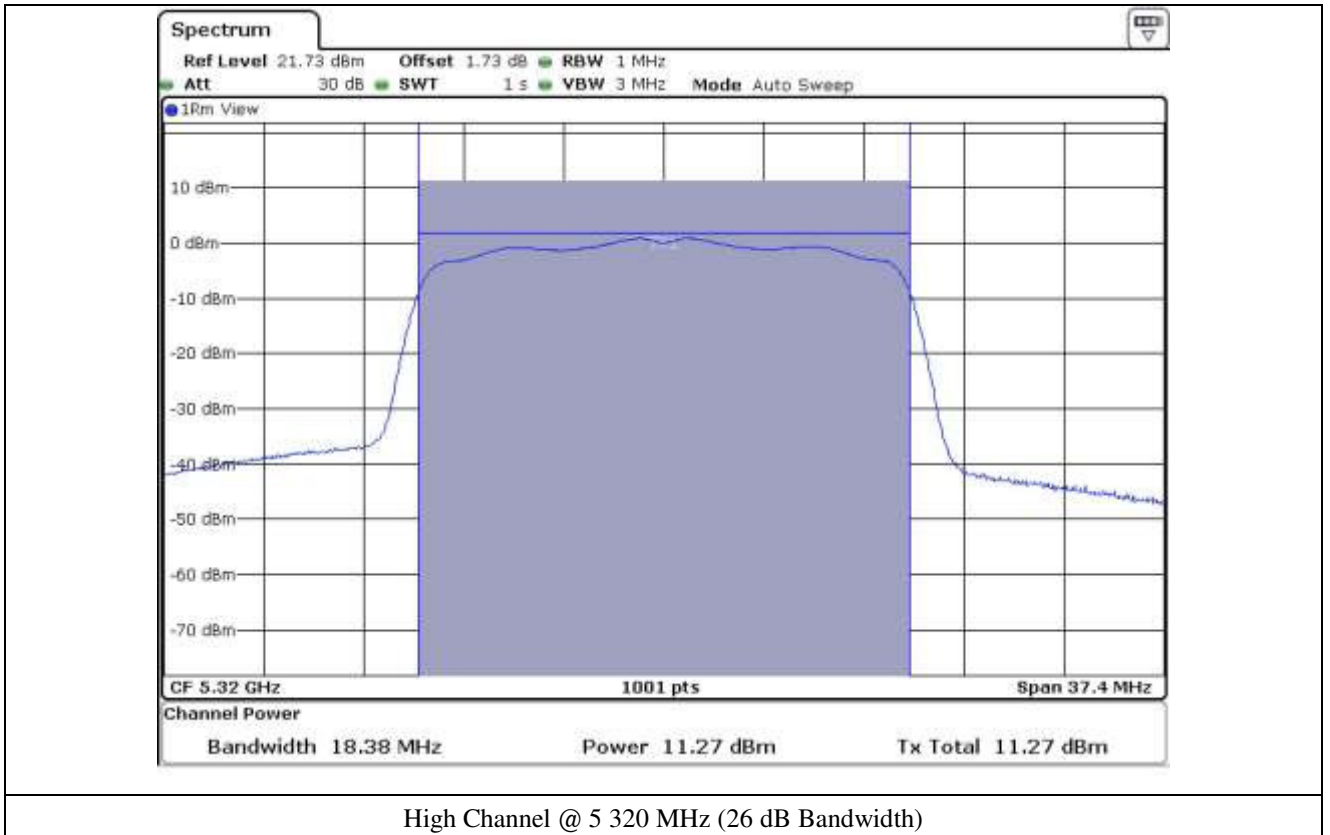

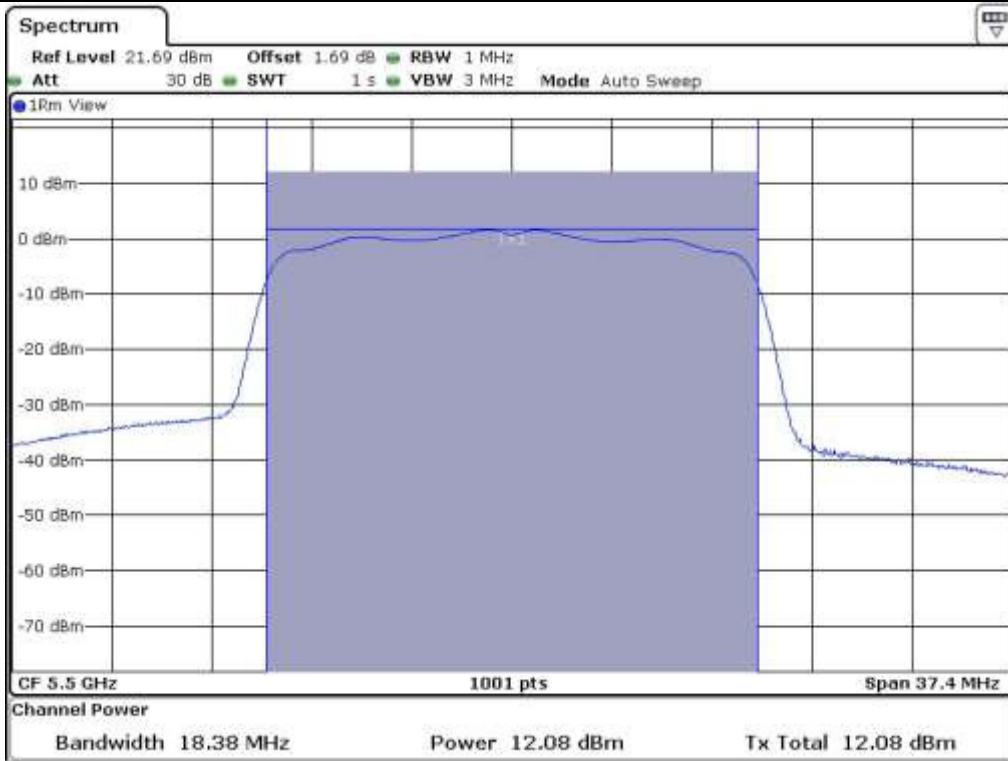

Low Channel @ 5 500 MHz (26 dB Bandwidth)

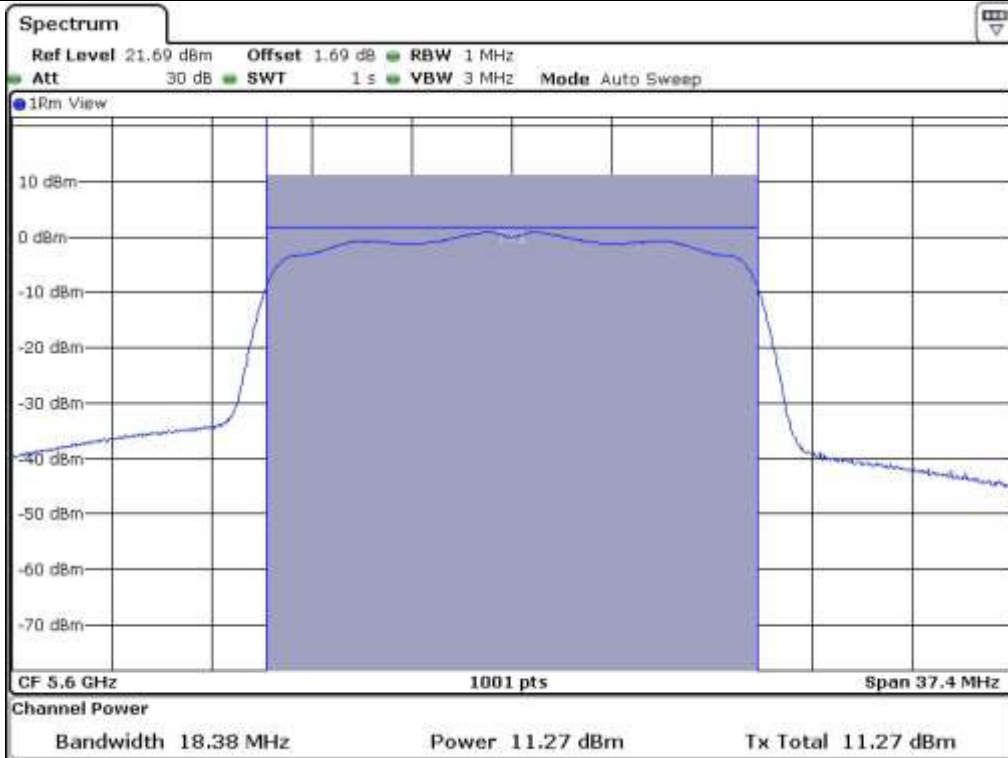

Middle Channel @ 5 600 MHz (26 dB Bandwidth)

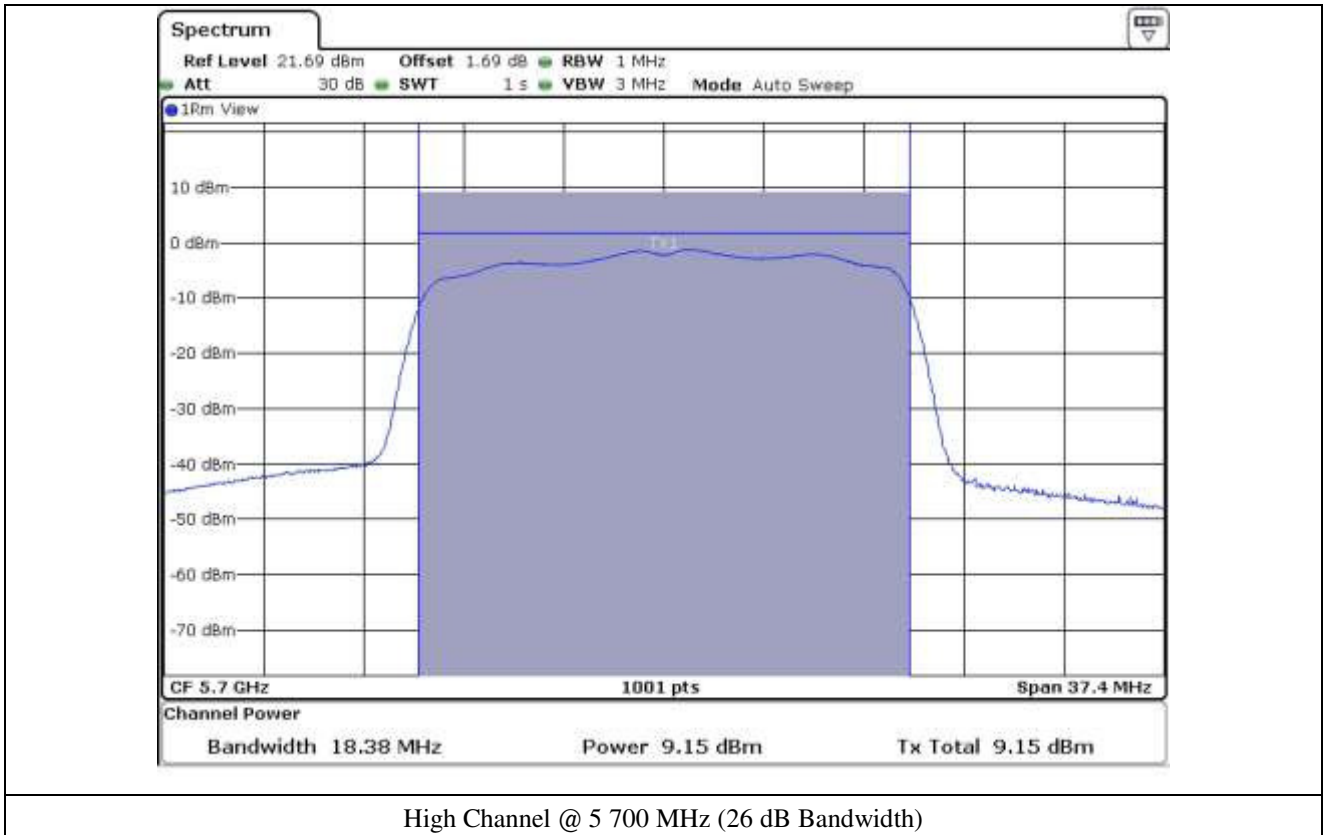

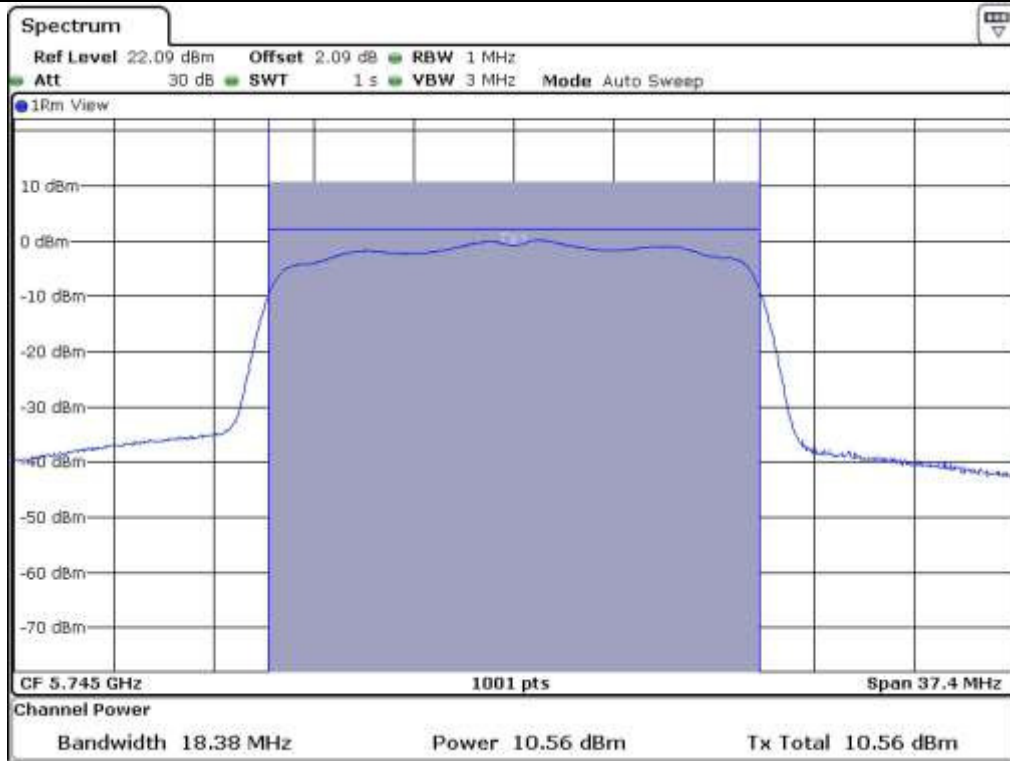

Low Channel @ 5 745 MHz (26 dB Bandwidth)

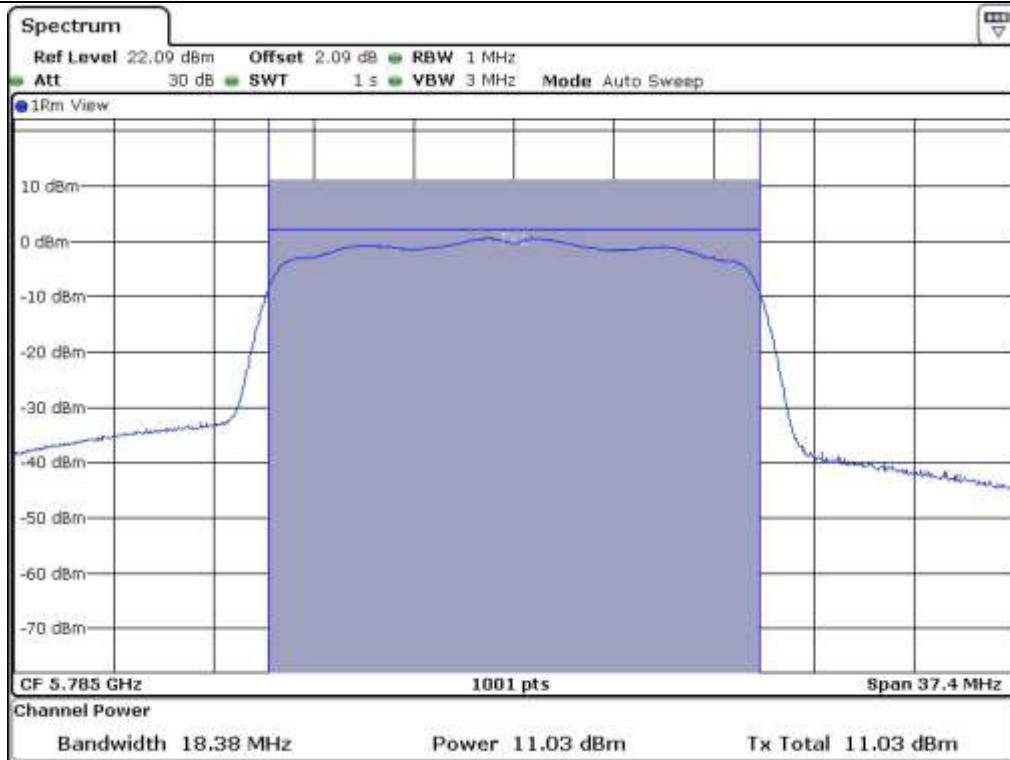

Middle Channel @ 5 785 MHz (26 dB Bandwidth)

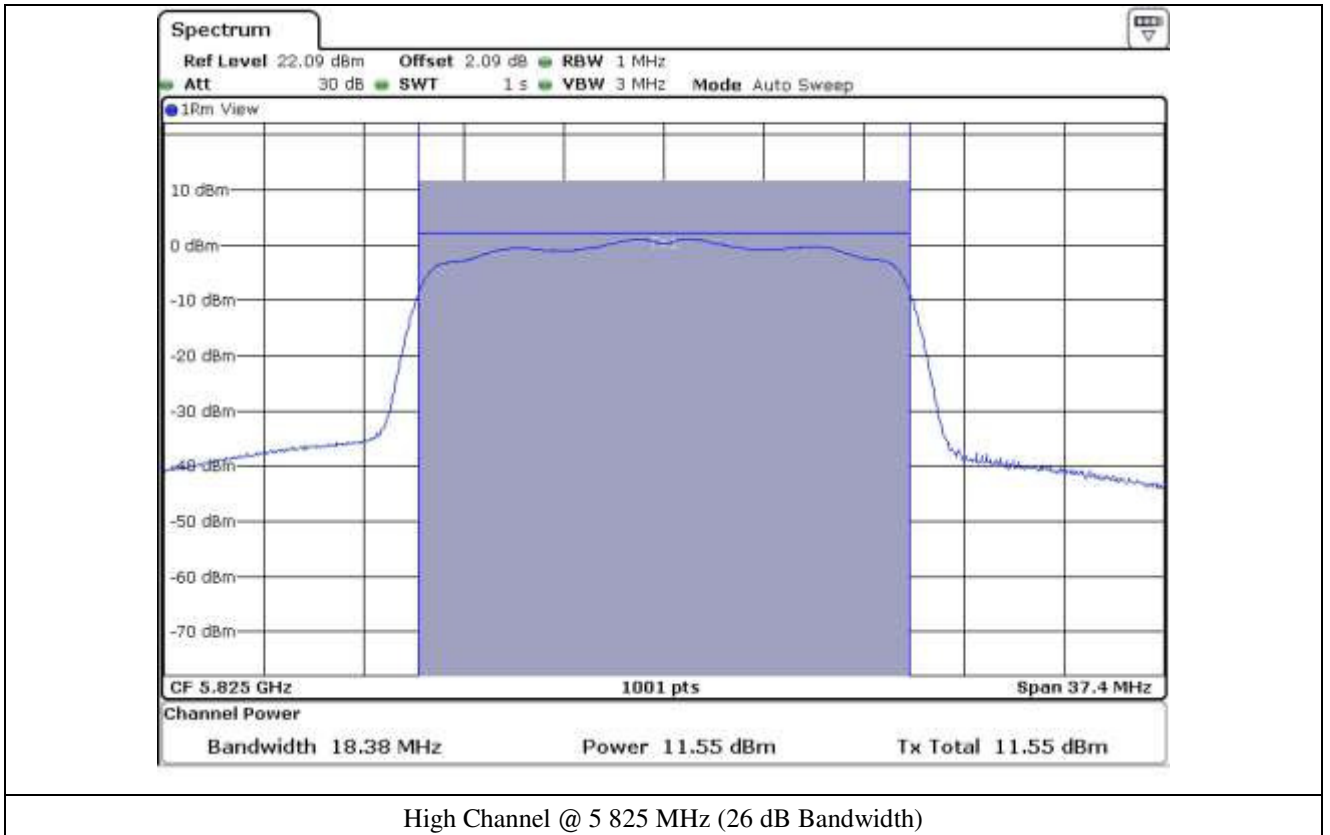

8.5 Test data for 802.11n_HT20 RLAN Mode

- Test Date : March 10, 2016

- Test Result : Pass

FREQUENCY RANGE (MHz)	CHANNEL	FREQUENCY (MHz)	26 dB Bandwidth (MHz)	MEASURED VLAUE (dBm)	LIMIT (dBm)	MARGIN (dB)
5 150 ~ 5 250	Low	5 180	18.74	11.88	23.98	12.10
	Middle	5 200	18.74	11.64	23.98	12.34
	High	5 240	18.74	11.69	23.98	12.29
5 250 ~ 5 350	Low	5 260	18.74	11.36	23.98	12.62
	Middle	5 300	18.74	11.50	23.98	12.48
	High	5 320	18.74	11.30	23.98	12.68
5 470 ~ 5 725	Low	5 500	18.74	12.14	23.98	11.84
	Middle	5 600	18.74	11.21	23.98	12.77
	High	5 700	18.74	9.21	23.98	14.77
5 725 ~ 5 850	Low	5 745	18.74	10.59	30.00	19.41
	Middle	5 785	18.74	11.31	30.00	18.69
	High	5 825	18.74	11.60	30.00	18.40

Remark: See next page for measurement data.



Tested by: Jun-Hui, Lee / Senior Engineer

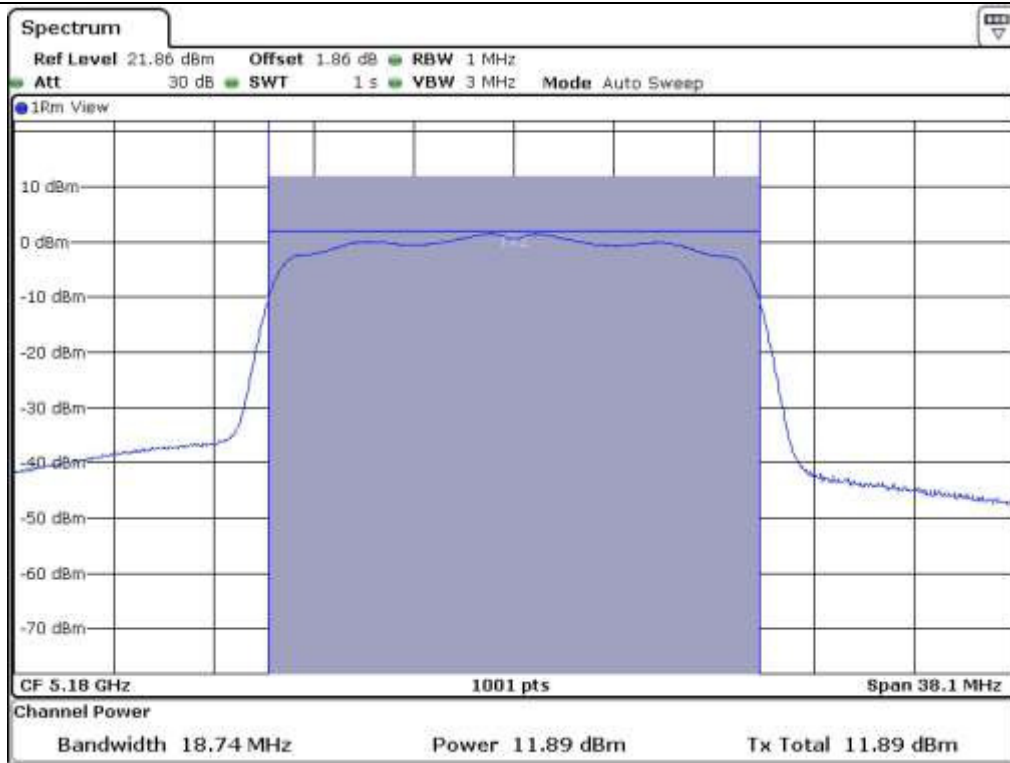

Low Channel @ 5 180 MHz (26 dB Bandwidth)



Middle Channel @ 5 200 MHz (26 dB Bandwidth)

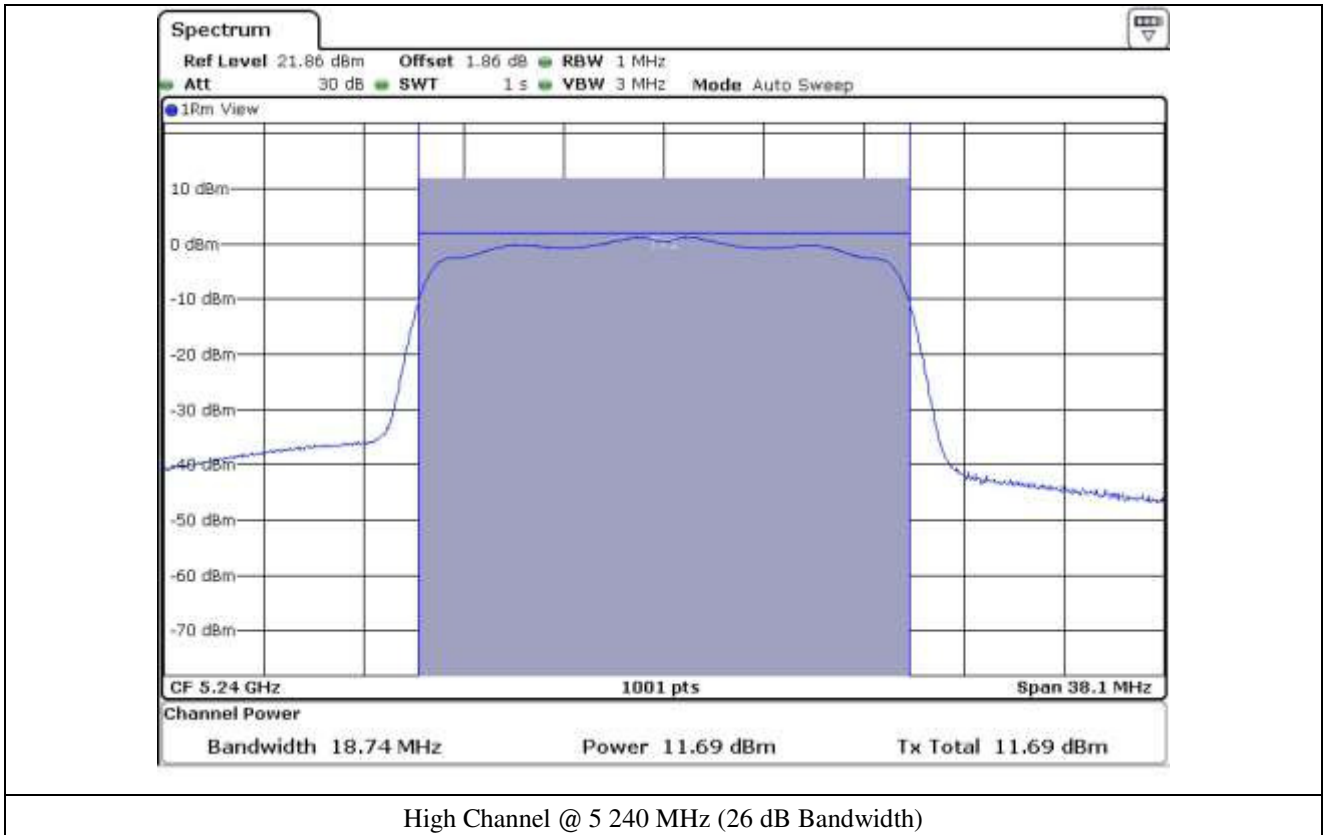



Low Channel @ 5 260 MHz (26 dB Bandwidth)

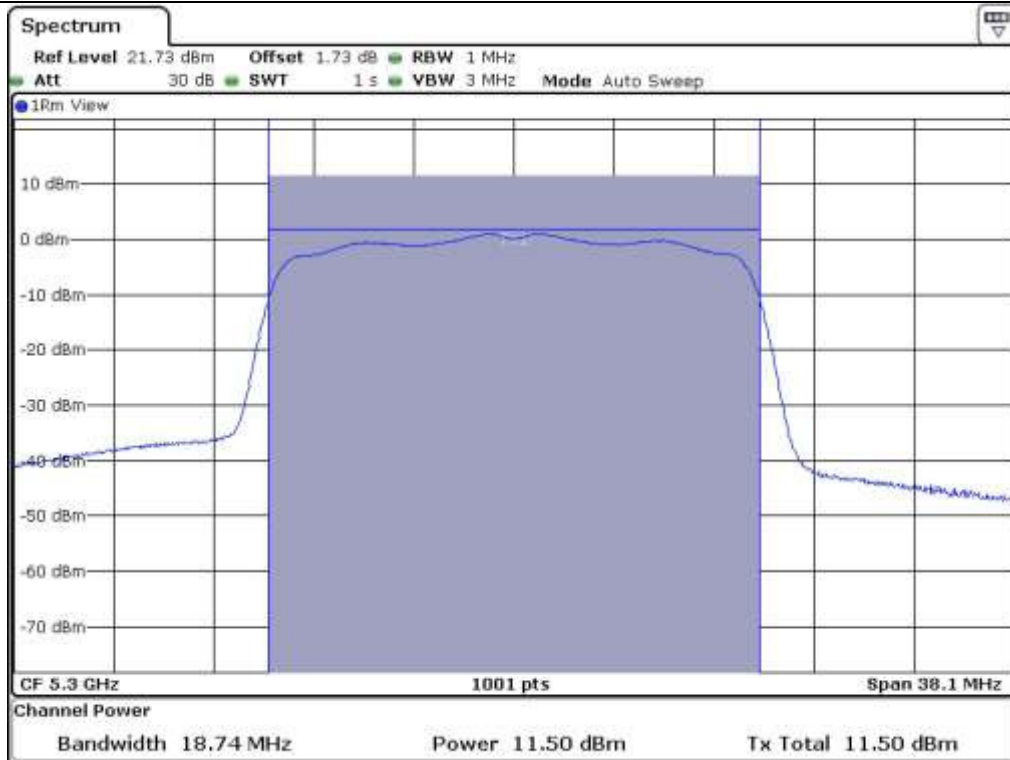

Middle Channel @ 5 300 MHz (26 dB Bandwidth)

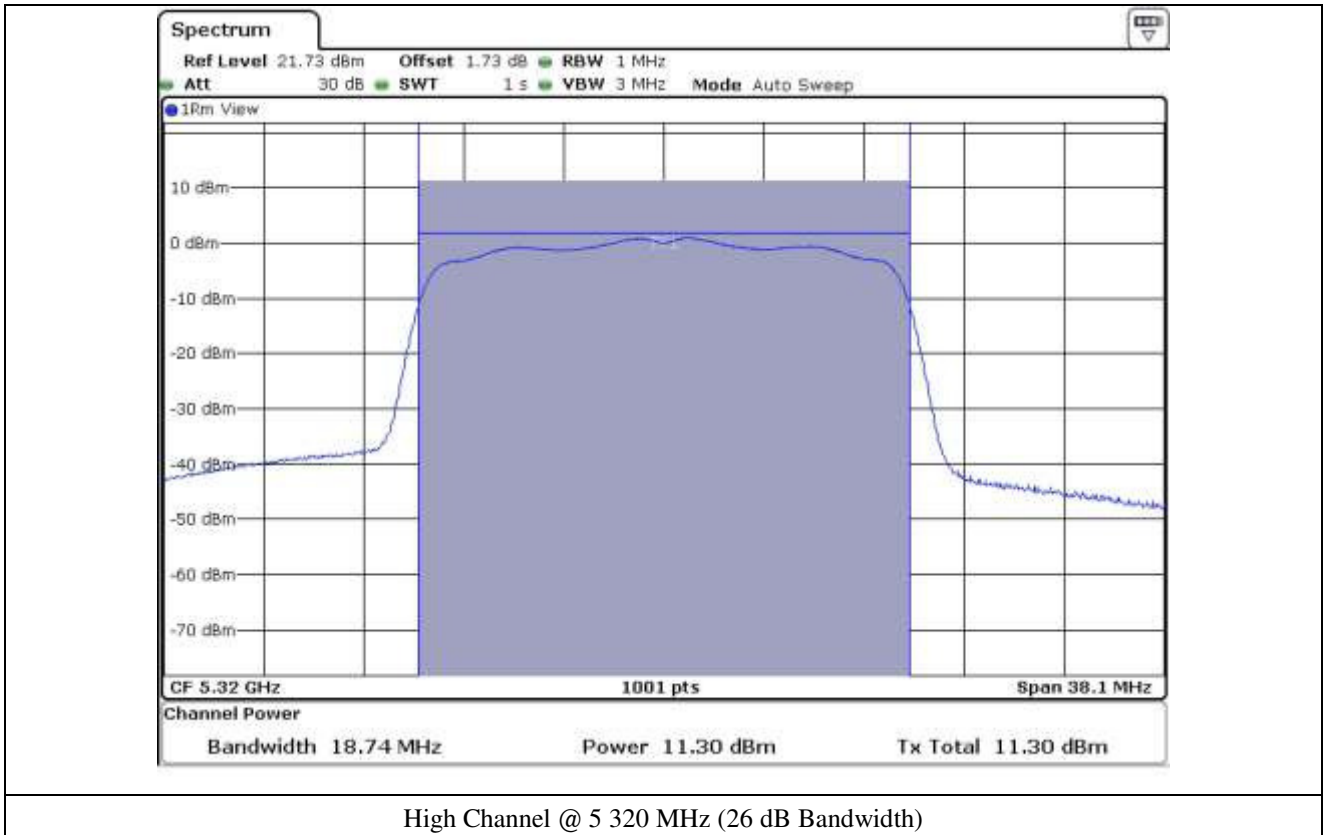



Low Channel @ 5 500 MHz (26 dB Bandwidth)

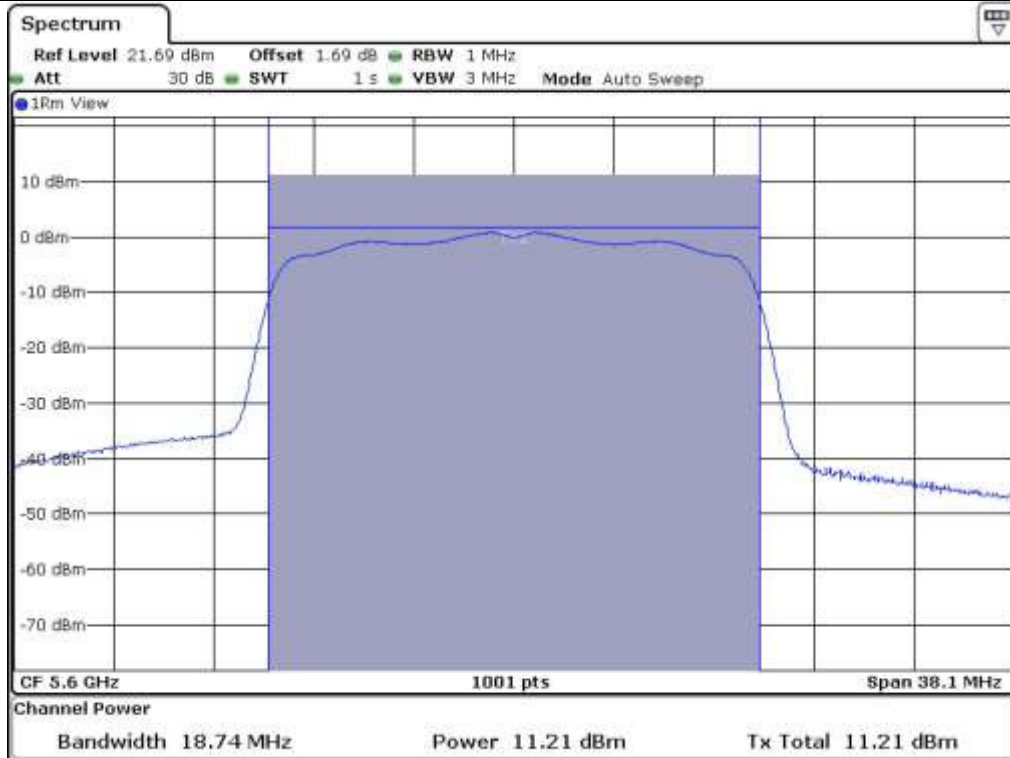

Middle Channel @ 5 600 MHz (26 dB Bandwidth)

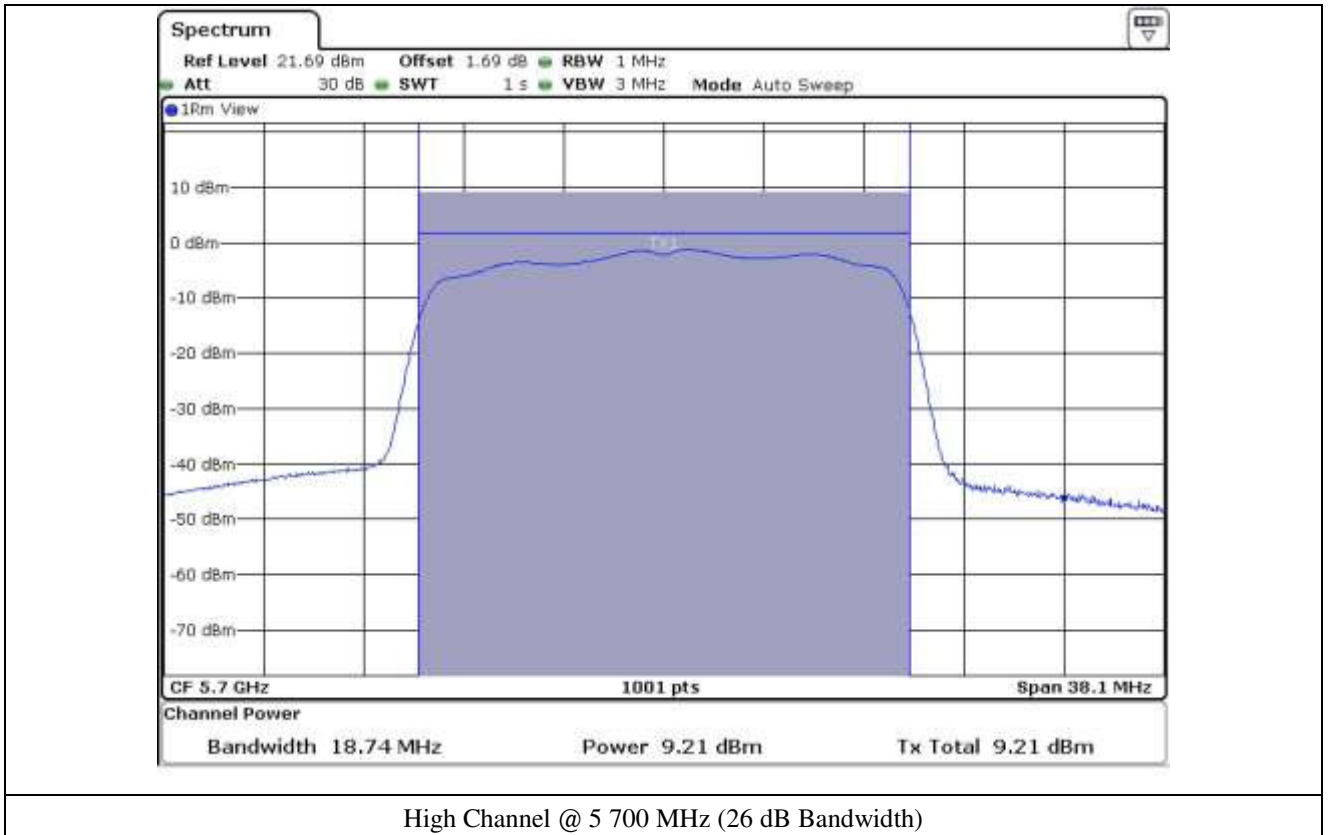

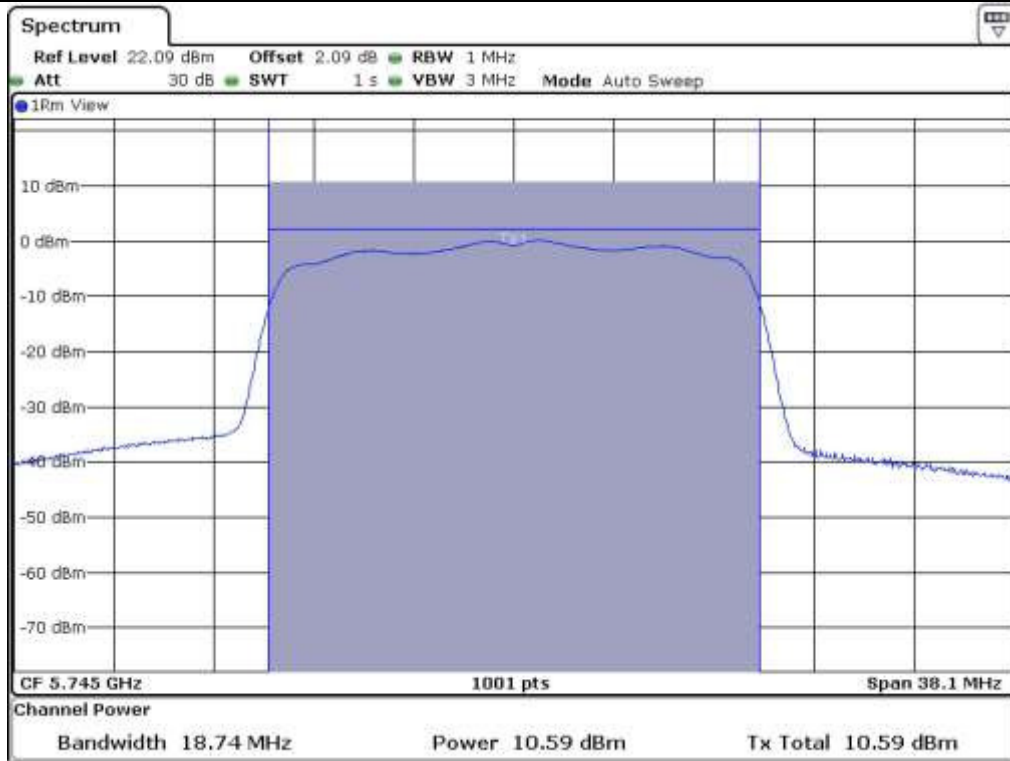

Low Channel @ 5 745 MHz (26 dB Bandwidth)

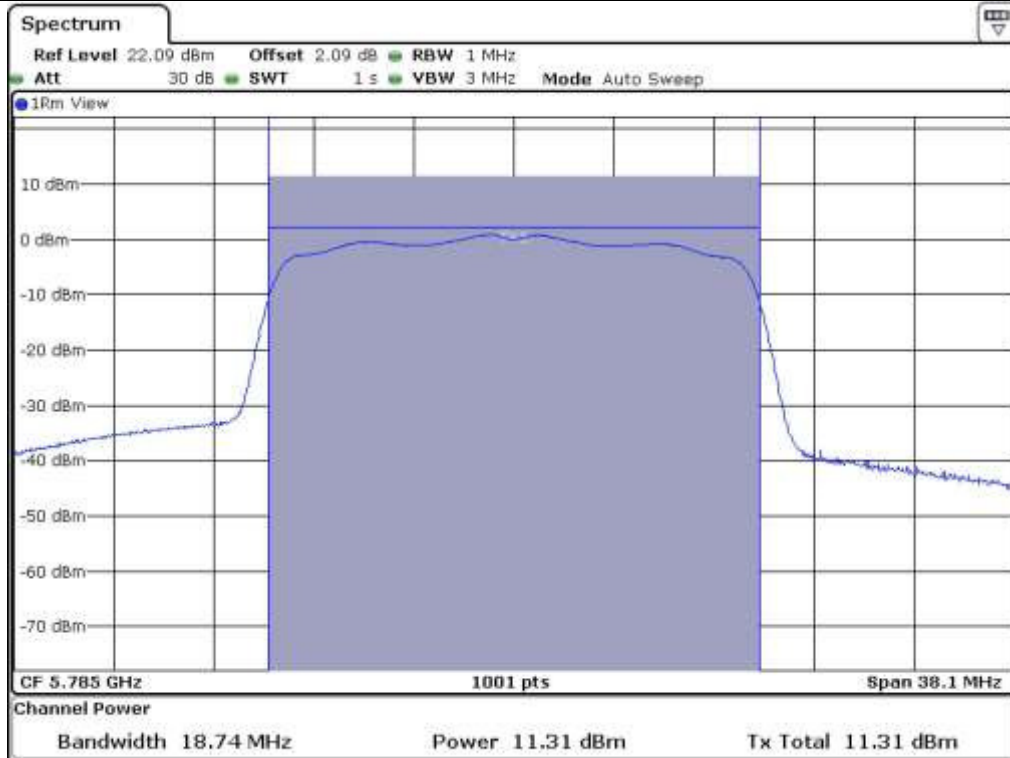

Middle Channel @ 5 785 MHz (26 dB Bandwidth)

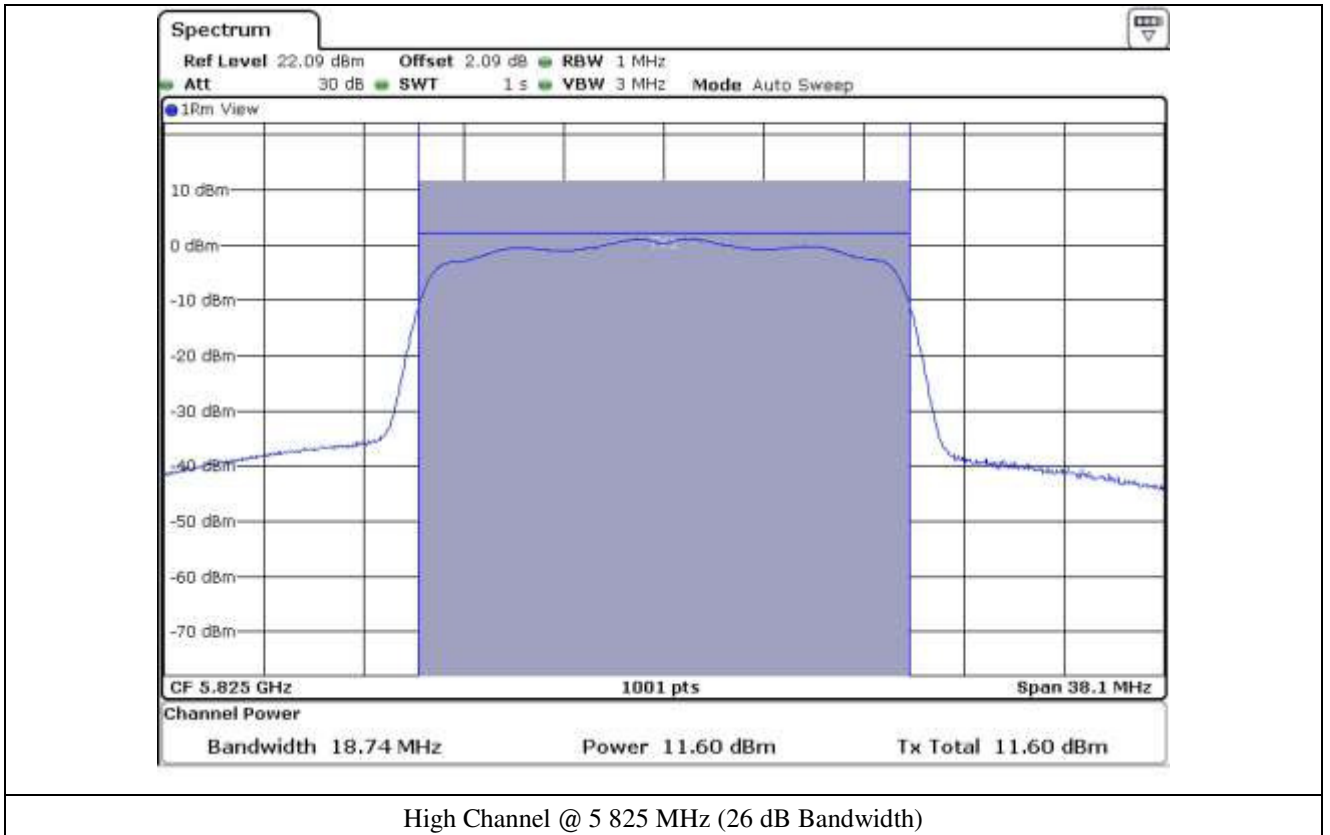

High Channel @ 5 825 MHz (26 dB Bandwidth)

9. PEAK POWER SPECTRUL DENSITY

9.1 Operating environment

Temperature : 23 °C
 Relative humidity : 47 % R.H.

9.2 Test set-up

The antenna output of the EUT was connected to the spectrum analyzer. The resolution bandwidth is set to 1 MHz, the video bandwidth is set to 3 times the resolution bandwidth. The maximum level form the EUT in 1 MHz bandwidth was measured with above condition.

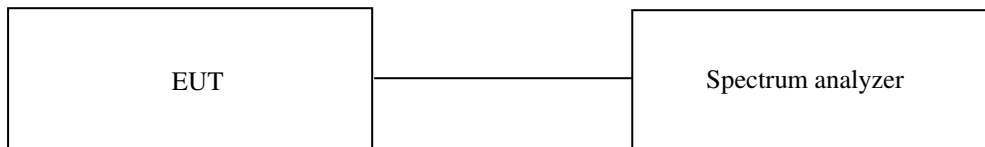

9.3 Test equipment used

Model Number	Manufacturer	Description	Serial Number	Last Cal.
■ - FSV40	Rohde & Schwarz	Signal Analyzer	101009	Jul. 22, 2015 (1Y)

All test equipment used is calibrated on a regular basis.

9.4 Test data for 802.11a RLAN Mode

- Test Date : March 10, 2016
- Operating condition : Highest Output Power Transmitting Mode
- Test Result : Pass

FREQUENCY RANGE (MHz)	CHANNEL	FREQUENCY (MHz)	MEASURED VLAUE (dBm)	LIMIT (dBm)	MARGIN (dB)
5 150 ~ 5 250	Low	5 180	1.59	11.00	9.41
	Middle	5 200	1.38	11.00	9.62
	High	5 240	1.34	11.00	9.66
5 250 ~ 5 350	Low	5 260	0.93	11.00	10.07
	Middle	5 300	1.00	11.00	10.00
	High	5 320	0.90	11.00	10.10
5 470 ~ 5 725	Low	5 500	1.85	11.00	9.15
	Middle	5 600	1.01	11.00	9.99
	High	5 700	-0.93	11.00	11.93
5 725 ~ 5 850	Low	5 745	0.05	30.00	29.95
	Middle	5 785	0.94	30.00	29.06
	High	5 825	1.24	30.00	28.76

Remark: See next page for measurement data.



Tested by: Jun-Hui, Lee / Senior Engineer



Low Channel (5 180 MHz)



Middle Channel (5 200 MHz)

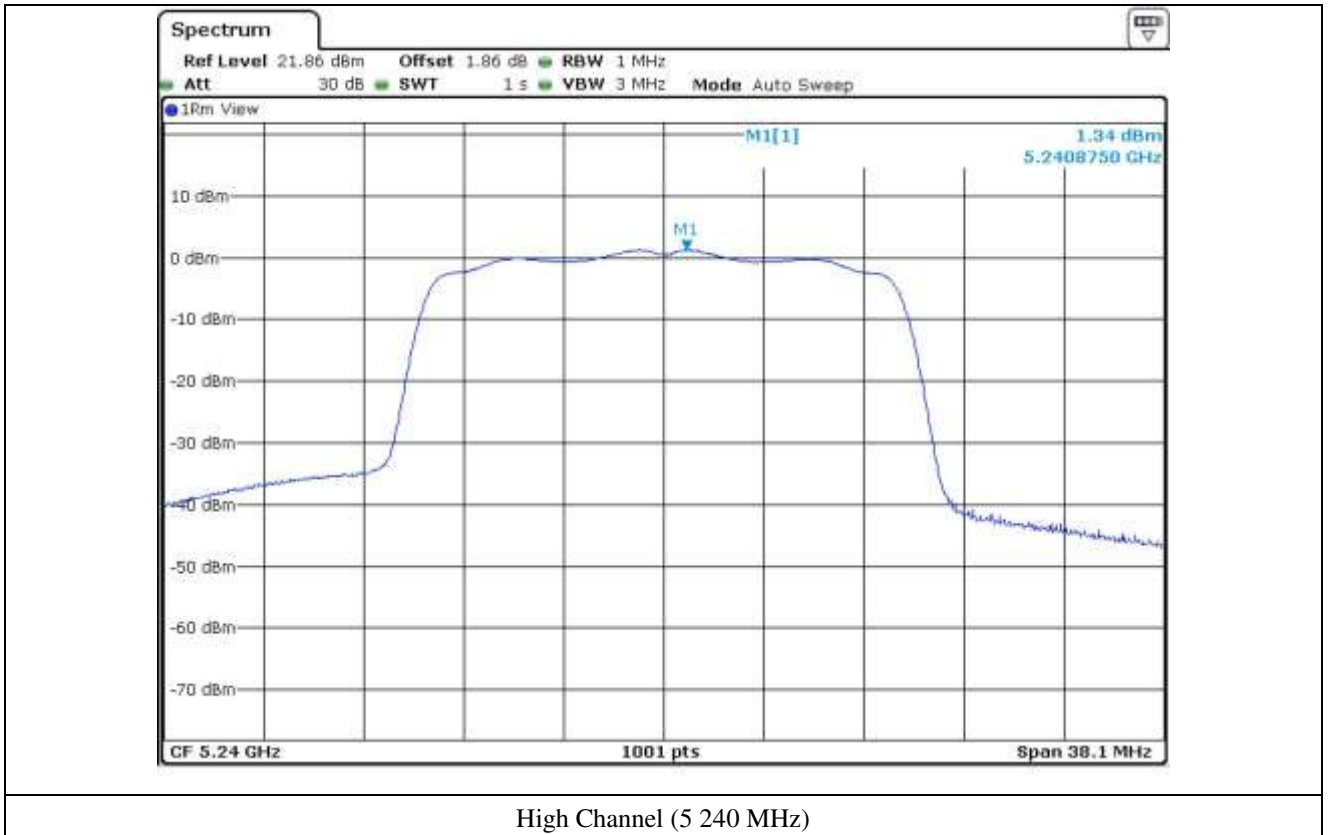



Low Channel (5 260 MHz)



Middle Channel (5 300 MHz)

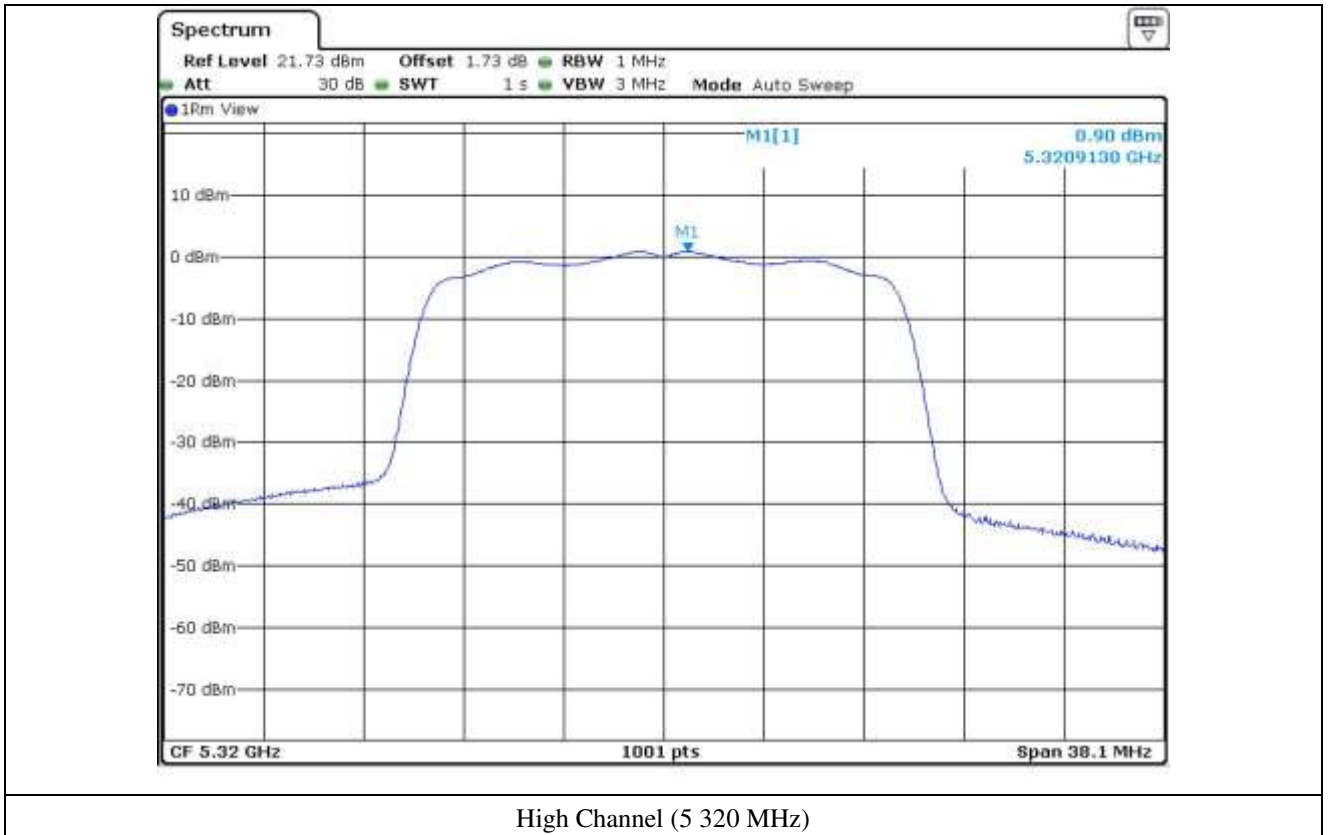



Low Channel (5 500 MHz)



Middle Channel (5 600 MHz)





Low Channel (5.745 MHz)



Middle Channel (5.785 MHz)

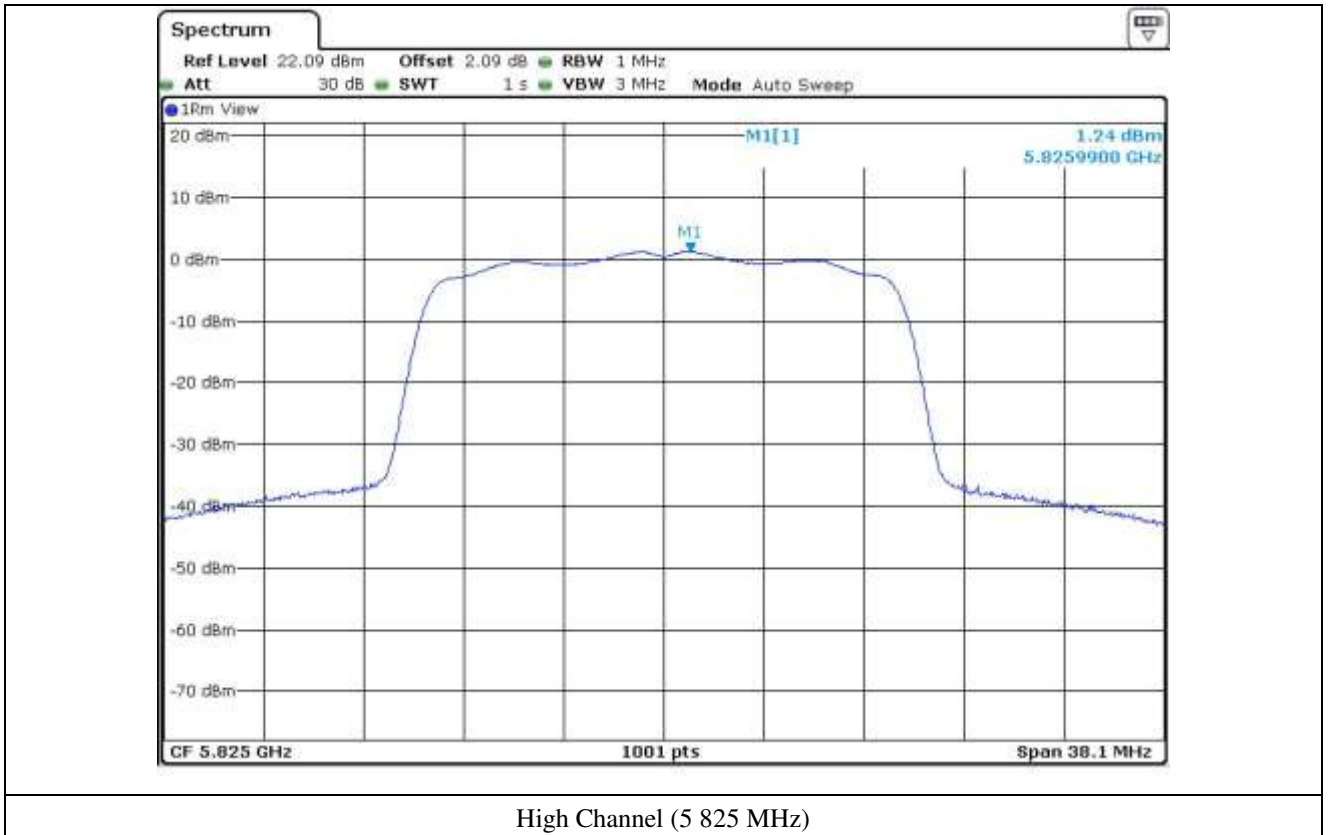

9.5 Test data for 802.11n_HT20 RLAN Mode

- Test Date : March 10, 2016
- Operating condition : Highest Output Power Transmitting Mode
- Test Result : Pass

FREQUENCY RANGE (MHz)	CHANNEL	FREQUENCY (MHz)	MEASURED VLAUE (dBm)	LIMIT (dBm)	MARGIN (dB)
5 150 ~ 5 250	Low	5 180	1.42	11.00	9.58
	Middle	5 200	1.13	11.00	9.87
	High	5 240	1.24	11.00	9.76
5 250 ~ 5 350	Low	5 260	0.81	11.00	10.19
	Middle	5 300	0.98	11.00	10.02
	High	5 320	1.00	11.00	10.00
5 470 ~ 5 725	Low	5 500	1.70	11.00	9.30
	Middle	5 600	0.79	11.00	10.21
	High	5 700	-1.16	11.00	12.16
5 725 ~ 5 850	Low	5 745	0.14	30.00	29.86
	Middle	5 785	0.60	30.00	29.40
	High	5 825	1.29	30.00	28.71

Remark: See next page for measurement data.



Tested by: Jun-Hui, Lee / Senior Engineer



Low Channel (5 180 MHz)



Middle Channel (5 200 MHz)





Low Channel (5 260 MHz)



Middle Channel (5 300 MHz)

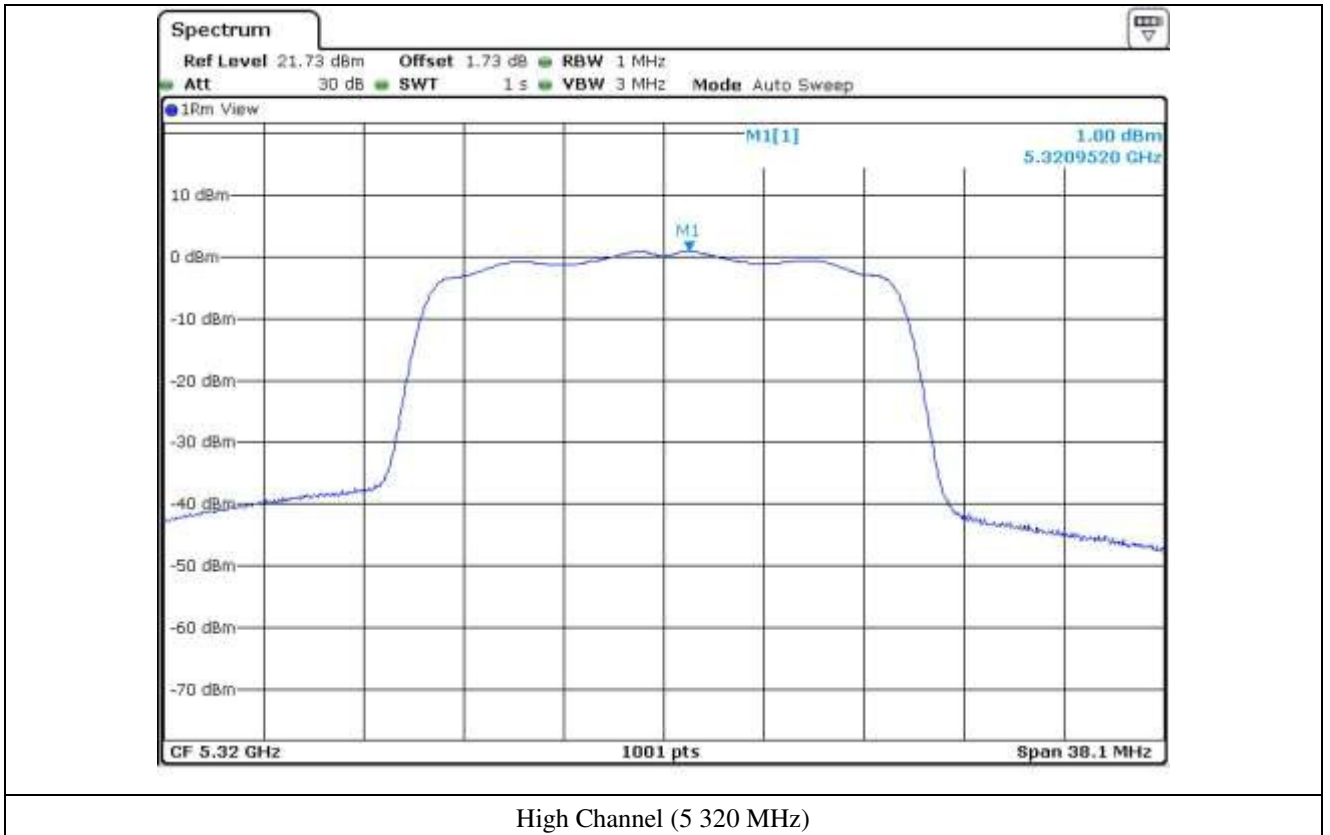



Low Channel (5 500 MHz)



Middle Channel (5 600 MHz)



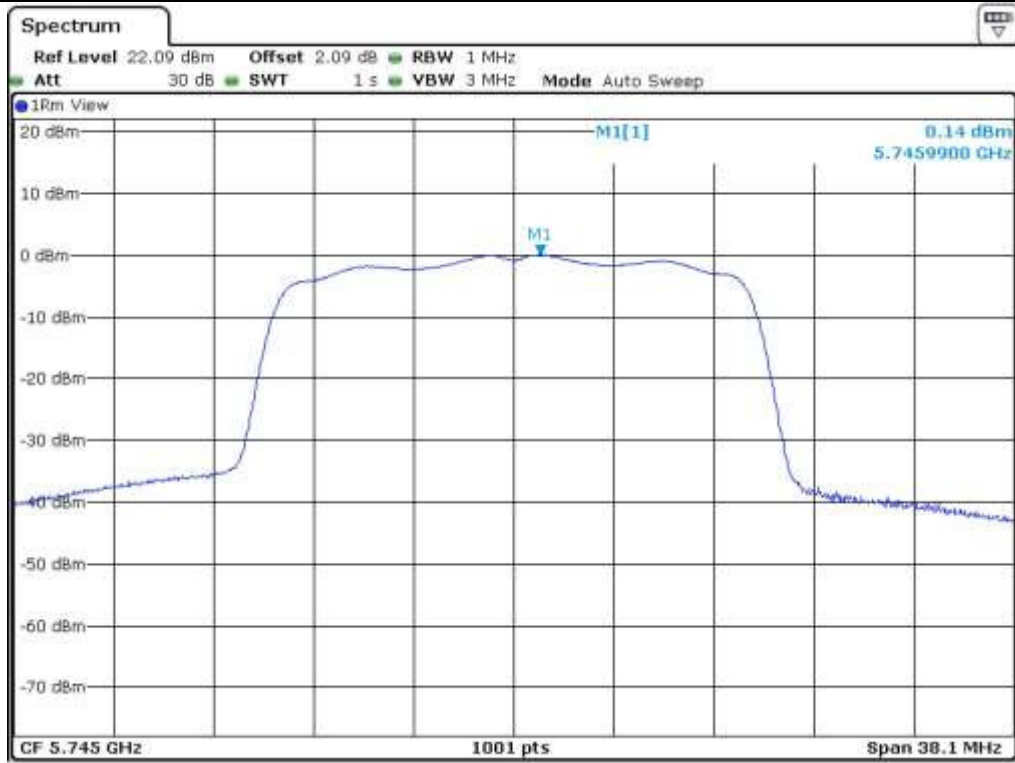

Low Channel (5.745 MHz)



Middle Channel (5.785 MHz)

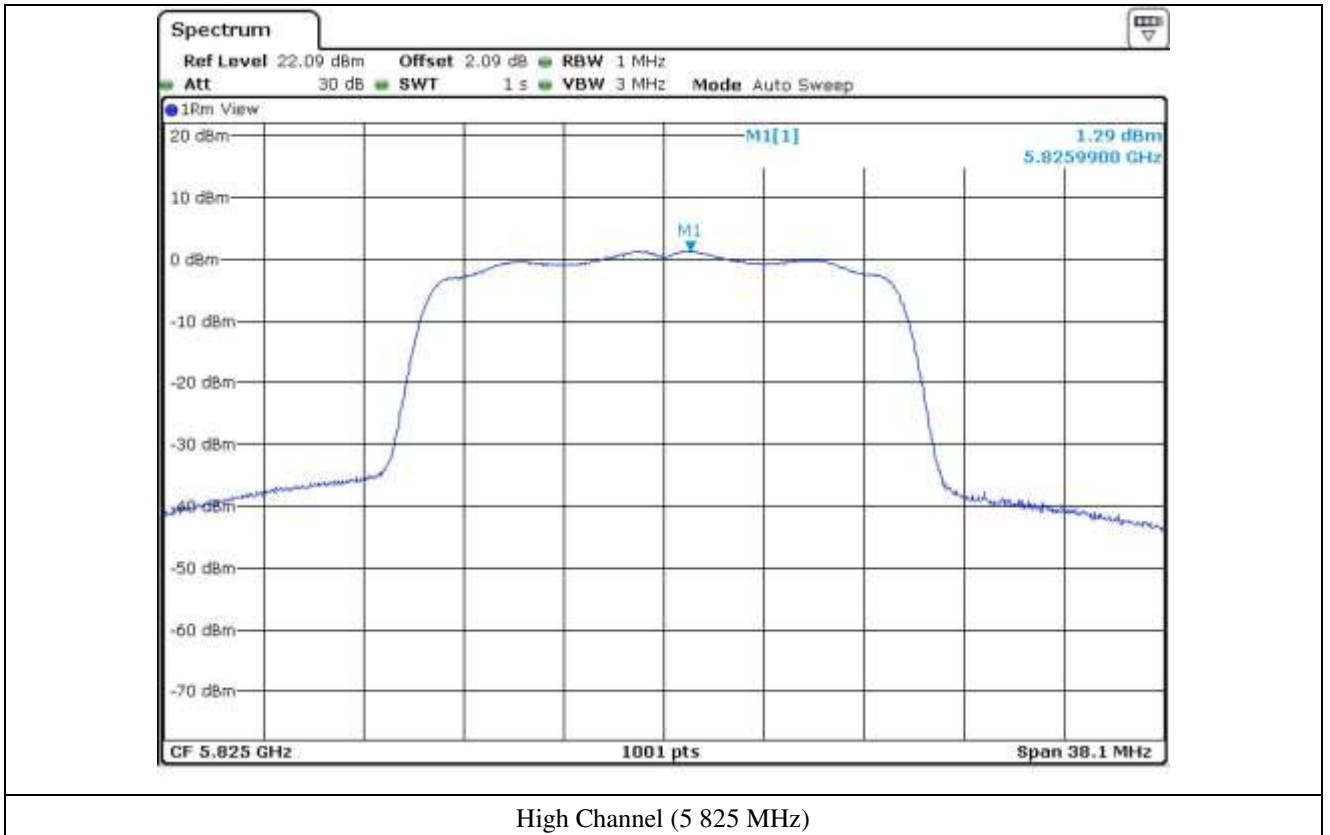

10. FREQUENCY STABILITY WITH TEMPERATURE VARIATION

10.1 Operating environment

Temperature : 23 °C
 Relative humidity : 47 % R.H.

10.2 Test set-up

Turn EUT off and set chamber temperature to -30 °C and then allow sufficient time (approximately 20 min to 30 min after chamber reach the assigned temperature) for EUT to stabilize. Turn on the EUT and measure the EUT operating frequency and then turn off the EUT after the measurement. The temperature in the chamber was raised 10 °C step from 0 °C to +65 °C. Repeat above method for frequency measurements every 10 °C step and then record all measured frequencies on each temperature step.

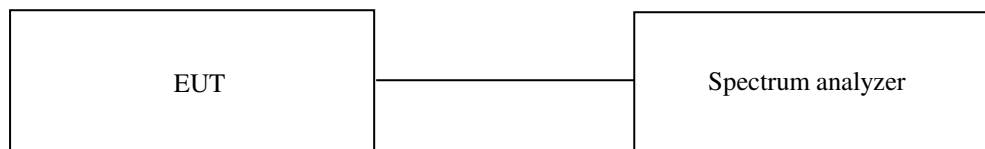

10.3 Test equipment used

Model Number	Manufacturer	Description	Serial Number	Last Cal.(Interval)
■ - FSV40	Rohde & Schwarz	Signal Analyzer	101009	Jul. 22, 2015 (1Y)
■ - SSE-43CI-A	Samkun Tech	Humidity Chamber	060712	May 15, 2015 (1Y)
■ - DRP-305DN	DIGITAL Elec.	DC Power supply	4030195	Sep. 03, 2015 (1Y)

All test equipment used is calibrated on a regular basis.

10.4 Test Data for 5 150 MHz ~ 5 250 MHz Band

-. Test Date : March 10, 2016

-. Result : Pass

Temperature (°C)	Carrier Freq. (Hz)	Measured Freq. (Hz)	Freequency Error (kHz)
0	5 180 000 000	5 180 025 648	25.648
10		5 180 024 098	24.098
20		5 180 023 057	23.057
30		5 180 022 100	22.100
40		5 180 021 128	21.128
50		5 180 020 530	20.530
60		5 180 019 892	19.892
65		5 200 027 251	27.251
0		5 200 000 000	5 200 025 816
10	5 200 024 570		24.570
20	5 200 023 902		23.902
30	5 200 023 001		23.001
40	5 200 022 119		22.119
50	5 200 021 369		21.369
60	5 200 020 678		20.678
65	5 240 028 270		28.270
0	5 240 000 000		5 240 026 700
10		5 240 025 312	25.312
20		5 240 024 439	24.439
30		5 240 023 378	23.378
40		5 240 022 574	22.574
50		5 240 022 053	22.053
60		5 240 020 861	20.861
65		5 180 025 648	25.648



Tested by: Jun-Hui, Lee / Senior Engineer

10.5 Test Data for 5 250 MHz ~ 5 350 MHz Band

-. Test Date : March 10, 2016

-. Result : Pass

Temperature (°C)	Carrier Freq. (Hz)	Measured Freq. (Hz)	Freequency Error (kHz)
0	5 260 000 000	5 260 028 657	28.657
10		5 260 027 302	27.302
20		5 260 025 813	25.813
30		5 260 024 768	24.768
40		5 260 023 818	23.818
50		5 260 022 742	22.742
60		5 260 021 817	21.817
65		5 260 021 052	21.052
0		5 300 000 000	5 300 029 154
10	5 300 027 772		27.772
20	5 300 026 243		26.243
30	5 300 025 328		25.328
40	5 300 024 543		24.543
50	5 300 023 444		23.444
60	5 300 022 860		22.860
65	5 300 021 604		21.604
0	5 320 000 000		5 320 029 600
10		5 320 027 939	27.939
20		5 320 026 764	26.764
30		5 320 025 940	25.940
40		5 320 025 059	25.059
50		5 320 024 088	24.088
60		5 320 023 307	23.307
65		5 320 022 242	22.242



Tested by: Jun-Hui, Lee / Senior Engineer

10.6 Test Data for 5 470 MHz ~ 5 725 MHz Band

-. Test Date : March 10, 2016

-. Result : Pass

Temperature (°C)	Carrier Freq. (Hz)	Measured Freq. (Hz)	Freequency Error (kHz)
0	5 500 000 000	5 500 036 153	36.153
10		5 500 034 849	34.849
20		5 500 033 250	33.250
30		5 500 032 426	32.426
40		5 500 031 337	31.337
50		5 500 030 204	30.204
60		5 500 029 441	29.441
65		5 500 028 490	28.490
0		5 600 000 000	5 600 036 926
10	5 600 035 451		35.451
20	5 600 034 154		34.154
30	5 600 033 219		33.219
40	5 600 032 459		32.459
50	5 600 031 316		31.316
60	5 600 030 217		30.217
65	5 600 029 461		29.461
0	5 700 000 000		5 700 038 115
10		5 700 036 506	36.506
20		5 700 035 031	35.031
30		5 700 034 170	34.170
40		5 700 033 178	33.178
50		5 700 032 473	32.473
60		5 700 031 104	31.104
65		5 700 030 318	30.318



Tested by: Jun-Hui, Lee / Senior Engineer

10.7 Test Data for 5 725 MHz ~ 5 850 MHz Band

-. Test Date : March 10, 2016

-. Result : Pass

Temperature (°C)	Carrier Freq. (Hz)	Measured Freq. (Hz)	Freequency Error (kHz)
0	5 745 000 000	5 745 038 274	38.274
10		5 745 036 853	36.853
20		5 745 035 418	35.418
30		5 745 034 190	34.190
40		5 745 033 502	33.502
50		5 745 032 360	32.360
60		5 745 031 419	31.419
65		5 745 030 459	30.459
0	5 785 000 000	5 785 038 714	38.714
10		5 785 037 185	37.185
20		5 785 035 916	35.916
30		5 785 035 093	35.093
40		5 785 034 103	34.103
50		5 785 033 307	33.307
60		5 785 032 275	32.275
65		5 785 031 715	31.715
0	5 825 000 000	5 825 039 206	39.206
10		5 825 038 072	38.072
20		5 825 036 365	36.365
30		5 825 035 236	35.236
40		5 825 034 278	34.278
50		5 825 033 491	33.491
60		5 825 032 274	32.274
65		5 825 031 414	31.414

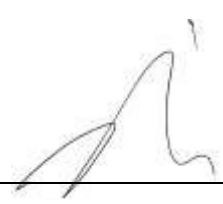

Tested by: Jun-Hui, Lee / Senior Engineer

11. FREQUENCY STABILITY WITH VOLTAGE VARIATION

11.1 Operating environment

Temperature : 23 °C
 Relative humidity : 47 % R.H.

11.2 Test set-up

An external DC power supply was connected to the input of the EUT. The voltage of EUT set to 115 % of the nominal value and then was reduced to 85 % of nominal voltage. The output frequency was recorded at each step.

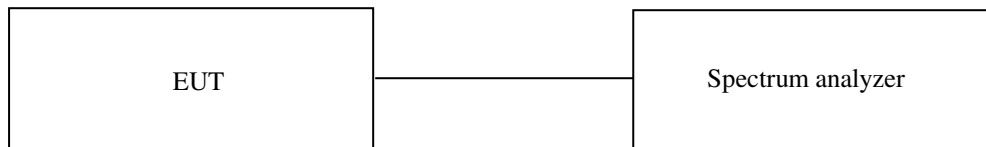

11.3 Test equipment used

Model Number	Manufacturer	Description	Serial Number	Last Cal.(Interval)
■ - FSV40	Rohde & Schwarz	Signal Analyzer	101009	Jul 22, 2015 (1Y)
■ - DRP-305DN	DIGITAL Elec.	DC Power supply	4030195	Sep. 03, 2015 (1Y)

All test equipment used is calibrated on a regular basis.

11.4 Test Data for 5 150 MHz ~ 5 250 MHz Band

-. Test Date : March 10, 2016

-. Result : Pass

Voltage (Vdc)	Carrier Freq. (Hz)	Measured Freq. (Hz)	Freequency Error (kHz)
4.37	5 180 000 000	5 180 024 280	24.280
3.80		5 180 024 236	24.236
3.23		5 180 024 214	24.214
4.37	5 200 000 000	5 200 024 730	24.730
3.80		5 200 024 692	24.692
3.23		5 200 024 651	24.651
4.37	5 240 000 000	5 240 025 541	25.541
3.80		5 240 025 495	25.495
3.23		5 240 025 460	25.460

11.5 Test Data for 5 250 MHz ~ 5 350 MHz Band

-. Test Date : March 10, 2016

-. Result : Pass

Voltage (Vdc)	Carrier Freq. (Hz)	Measured Freq. (Hz)	Freequency Error (kHz)
4.37	5 260 000 000	5 260 025 987	25.987
3.80		5 260 025 954	25.954
3.23		5 260 025 920	25.92
4.37	5 300 000 000	5 300 026 474	26.474
3.80		5 300 026 429	26.429
3.23		5 300 026 383	26.383
4.37	5 320 000 000	5 320 026 944	26.944
3.80		5 320 026 896	26.896
3.23		5 320 026 865	26.865

11.6 Test Data for 5 470 MHz ~ 5 725 MHz Band

-. Test Date : March 10, 2016

-. Result : Pass

Voltage (Vdc)	Carrier Freq. (Hz)	Measured Freq. (Hz)	Freequency Error (kHz)
4.37	5 500 000 000	5 500 033 426	33.426
3.80		5 500 033 391	33.391
3.23		5 500 033 349	33.349
4.37	5 600 000 000	5 600 034 352	34.352
3.80		5 600 034 312	34.312
3.23		5 600 034 286	34.286
4.37	5 700 000 000	5 700 035 176	35.176
3.80		5 700 035 152	35.152
3.23		5 700 035 128	35.128

11.7 Test Data for 5 725 MHz ~ 5 850 MHz Band

-. Test Date : March 10, 2016

-. Result : Pass

Voltage (Vdc)	Carrier Freq. (Hz)	Measured Freq. (Hz)	Freequency Error (kHz)
4.37	5 745 000 000	5 745 035 608	35.608
3.80		5 745 035 567	35.567
3.23		5 745 035 523	35.523
4.37	5 785 000 000	5 785 036 068	36.068
3.80		5 785 036 031	36.031
3.23		5 785 035 996	35.996
4.37	5 825 000 000	5 825 036 519	36.519
3.80		5 825 036 470	36.470
3.23		5 825 036 450	36.450



Tested by: Jun-Hui, Lee / Senior Engineer

12. RADIATED SPURIOUS EMISSIONS

12.1 Operating environment

Temperature : (23 ~ 24) °C
 Relative humidity : (43 ~ 44) % R.H.

12.2 Test set-up for conducted measurement

The radiated emissions measurements were performed on the 3 m, open-field test site. The EUT was placed on a non-conductive turntable above the ground plane.

The frequency spectrum from 30 MHz to 40 GHz was scanned and maximum emission levels at each frequency recorded. The system was rotated 360°, and the antenna was varied in the height between 1.0 m and 4.0 m in order to determine the maximum emission levels. This procedure was performed for horizontal and vertical polarization of the receiving antenna.

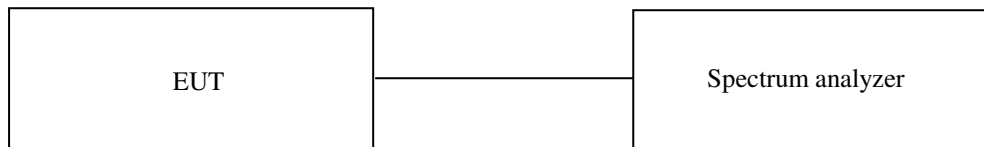

12.3 Test equipment used

Model Number	Manufacturer	Description	Serial Number	Last Cal.(Interval)
■ - FSV40	Rohde & Schwarz	Signal Analyzer	101009	Jul. 22, 2015 (1Y)
■ - ESCI	Rohde & Schwarz	Test Receiver	101012	Nov. 02, 2015 (1Y)
■ - 310N	Sonoma Instrument	Pre-Amplifier	312544	Apr. 29, 2015 (1Y)
■ - SCU-18	Rohde & Schwarz	Pre-Amplifier	10041	Nov. 23, 2015 (1Y)
■ - SCU40A	Rohde & Schwarz	Pre-Amplifier	100436	Jun. 04, 2015 (1Y)
■ - DT3000	Innco System	Turn Table	930611	N/A
■ - MA4000-EP	Innco System	Antenna Master	3320611	N/A
■ - VULB9163	Schwarzbeck	TRILOG Broadband Antenna	9163-421	Jul. 10, 2014 (2Y)
■ - BBHA9120D	Schwarzbeck	Horn Antenna	BBHA9120D295	Aug. 31, 2015 (2Y)
■ - BBHA9170	Schwarzbeck	Horn Antenna	BBHA9170178	Apr. 30, 2015 (2Y)

All test equipment used is calibrated on a regular basis.

12.4 Test data for 5 150 MHz ~ 5 250 MHz Band

12.4.1 Test data for 30 MHz ~ 1 000 MHz

Humidity Level : (43 ~ 44) % R.H. Temperature: (23 ~ 24) °C

Limits apply to : FCC CFR 47, PART 15, SUBPART C, SECTION 15.247

Result : PASSED

EUT : Premium Tablet Date: March 09, 2016

Detector : CISPR Quasi-Peak (6 dB Bandwidth: 120 kHz)

-. Low, Middle and High Channels were tested, but the worst data were recorded.

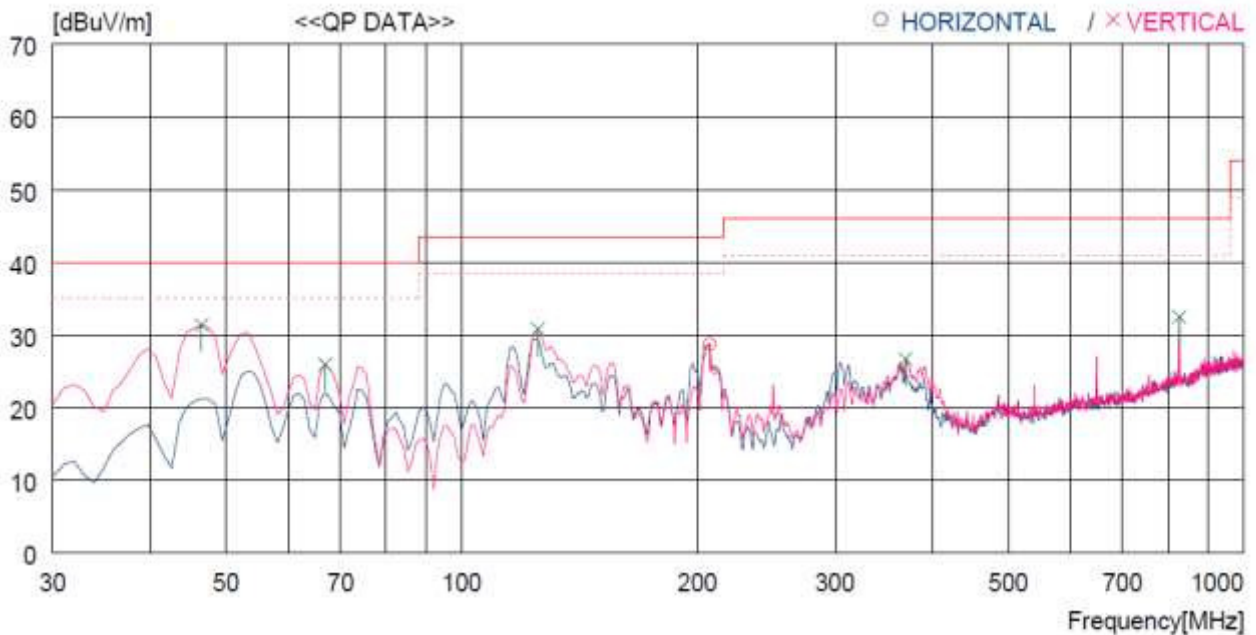

No.	FREQ [MHz]	READING QP [dBuV]	ANT FACTOR [dB]	LOSS [dB]	GAIN [dB]	RESULT [dBuV/m]	LIMIT [dBuV/m]	MARGIN [dB]	ANTENNA [cm]	TABLE [DEG]
----- Horizontal -----										
1	207.510	46.8	11.0	3.8	32.8	28.8	43.5	14.7	100	19
----- Vertical -----										
2	46.490	48.5	13.9	1.9	32.9	31.4	40.0	8.6	100	270
3	66.860	45.9	10.9	2.3	33.1	26.0	40.0	14.0	100	0
4	125.060	51.0	9.7	3.3	33.2	30.8	43.5	12.7	100	0
5	369.500	39.0	15.2	5.1	32.6	26.7	46.0	19.3	100	102
6	827.331	36.7	21.2	8.0	33.4	32.5	46.0	13.5	100	75

12.4.2 Test data for Below 30 MHz

- Test Date : March 09, 2016
- Resolution bandwidth : 200 Hz (from 9 kHz to 0.15 MHz), 9 kHz (from 0.15 MHz to 30 MHz)
- Frequency range : 9 kHz ~ 30 MHz
- Measurement distance : 3 m
- Operating mode : Transmitting mode

Frequency (MHz)	Reading (dBμV)	Ant. Pol. (H/V)	Ant. Height (m)	Angle (°)	Ant. Factor (dB/m)	Cable Loss	Emission Level(dBμV/m)	Limits (dBμV/m)	Margin (dB)
Any emissions were not observed from the EUT.									

12.4.3 Test data for above 1 GHz

- Test Date : March 09, 2016
- Resolution bandwidth : 1 MHz for Peak and Average Mode
- Video bandwidth : 1 MHz for Peak Mode, 10 Hz for Average Mode
- Frequency range : 1 GHz ~ 40 GHz
- Measurement distance : 3 m
- Operating mode : Transmitting mode

Frequency (MHz)	Reading (dBμV)	Detector Mode	Ant. Pol. (H/V)	Ant. Factor	Cable Loss	Amp Gain	Total (dBμV/m)	Limits (dBμV/m)	Margin (dB)
Low Channel									
10 360.00	54.96	Peak	H	38.60	16.30	42.50	67.36	73.98	6.62
	37.32	Average	H				49.72	53.98	4.26
	54.53	Peak	V				66.93	73.98	7.05
	36.65	Average	V				49.05	53.98	4.93
Middle Channel									
10 400.00	54.11	Peak	H	38.60	16.30	42.50	66.51	73.98	7.47
	37.00	Average	H				49.40	53.98	4.58
	54.24	Peak	V				66.64	73.98	7.34
	36.26	Average	V				48.66	53.98	5.32
High Channel									
10 480.00	55.08	Peak	H	38.60	16.30	42.50	67.48	73.98	6.50
	36.87	Average	H				49.27	53.98	4.71
	54.74	Peak	V				67.14	73.98	6.84
	36.29	Average	V				48.69	53.98	5.29

Tabulated test data for Restricted Band

Remark - “H”: Horizontal, “V”: Vertical

Margin (dB) = Limits (dBμV/m) - Emission Level (dBμV/m)



Tested by: Jun-Hui, Lee / Senior Engineer

12.5 Test data for 5 250 MHz ~ 5 350 MHz Band

12.5.1 Test data for 30 MHz ~ 1 000 MHz

Humidity Level : (43 ~ 44) % R.H. Temperature: (23 ~ 24) °C

Limits apply to : FCC CFR 47, PART 15, SUBPART C, SECTION 15.247

Result : PASSED

EUT : Premium Tablet

Date: March 09, 2016

Detector : CISPR Quasi-Peak (6 dB Bandwidth: 120 kHz)

-. Low, Middle and High Channels were tested, but the worst data were recorded.

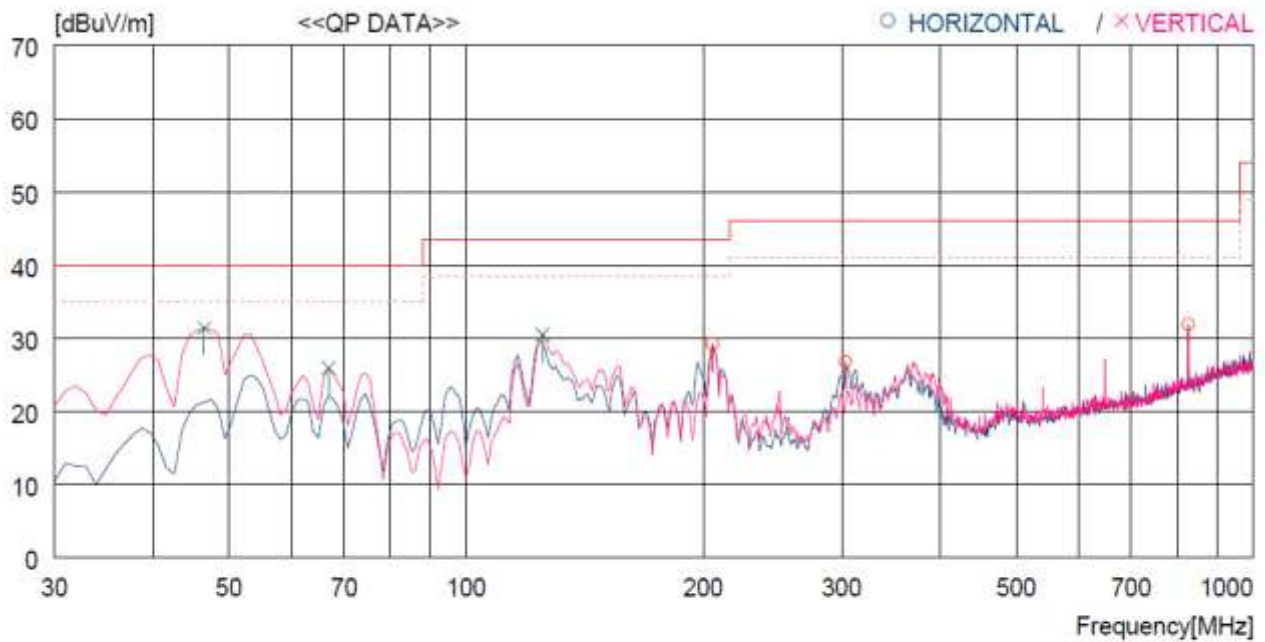

No.	FREQ [MHz]	READING QP [dBuV]	ANT FACTOR [dB]	LOSS [dB]	GAIN [dB]	RESULT [dBuV/m]	LIMIT [dBuV/m]	MARGIN [dB]	ANTENNA [cm]	TABLE [DEG]
---- Horizontal ----										
1	205.570	47.3	10.9	3.8	32.8	29.2	43.5	14.3	100	19
2	303.540	41.2	13.7	4.6	32.7	26.8	46.0	19.2	100	359
3	827.331	36.1	21.2	8.0	33.4	31.9	46.0	14.1	100	359
---- Vertical ----										
4	46.490	48.5	13.9	1.9	32.9	31.4	40.0	8.6	100	0
5	66.860	45.9	10.9	2.3	33.1	26.0	40.0	14.0	100	0
6	125.060	50.7	9.7	3.3	33.2	30.5	43.5	13.0	100	0

12.5.2 Test data for Below 30 MHz

- Test Date : March 09, 2016
- Resolution bandwidth : 200 Hz (from 9 kHz to 0.15 MHz), 9 kHz (from 0.15 MHz to 30 MHz)
- Frequency range : 9 kHz ~ 30 MHz
- Measurement distance : 3 m
- Operating mode : Transmitting mode

Frequency (MHz)	Reading (dBμV)	Ant. Pol. (H/V)	Ant. Height (m)	Angle (°)	Ant. Factor (dB/m)	Cable Loss	Emission Level(dBμV/m)	Limits (dBμV/m)	Margin (dB)
Any emissions were not observed from the EUT.									

12.5.3 Test data for above 1 GHz

- Test Date : March 09, 2016
- Resolution bandwidth : 1 MHz for Peak and Average Mode
- Video bandwidth : 1 MHz for Peak Mode, 10 Hz for Average Mode
- Frequency range : 1 GHz ~ 40 GHz
- Measurement distance : 3 m
- Operating mode : Transmitting mode

Frequency (MHz)	Reading (dBμV)	Detector Mode	Ant. Pol. (H/V)	Ant. Factor	Cable Loss	Amp Gain	Total (dBμV/m)	Limits (dBμV/m)	Margin (dB)
Low Channel									
10 520.00	54.58	Peak	H	38.80	16.50	42.50	67.38	73.98	6.60
	36.15	Average	H				48.95	53.98	5.03
	54.86	Peak	V				67.66	73.98	6.32
	36.59	Average	V				49.39	53.98	4.59
Middle Channel									
10 600.00	55.12	Peak	H	38.80	16.50	42.50	67.92	73.98	6.06
	37.01	Average	H				49.81	53.98	4.17
	54.87	Peak	V				67.67	73.98	6.31
	36.64	Average	V				49.44	53.98	4.54
High Channel									
10 640.00	54.77	Peak	H	38.80	16.50	42.50	67.57	73.98	6.41
	36.81	Average	H				49.61	53.98	4.37
	54.85	Peak	V				67.65	73.98	6.33
	36.47	Average	V				49.27	53.98	4.71

Tabulated test data for Restricted Band

Remark - "H": Horizontal, "V": Vertical

Margin (dB) = Limits (dBμV/m) - Emission Level (dBμV/m)



Tested by: Jun-Hui, Lee / Senior Engineer

12.6 Test data for 5 470 MHz ~ 5 725 MHz Band

12.6.1 Test data for 30 MHz ~ 1 000 MHz

Humidity Level : (43 ~ 44) % R.H. Temperature: (23 ~ 24) °C

Limits apply to : FCC CFR 47, PART 15, SUBPART C, SECTION 15.247

Result : PASSED

EUT : Premium Tablet Date: March 09, 2016

Detector : CISPR Quasi-Peak (6 dB Bandwidth: 120 kHz)

-. Low, Middle and High Channels were tested, but the worst data were recorded.

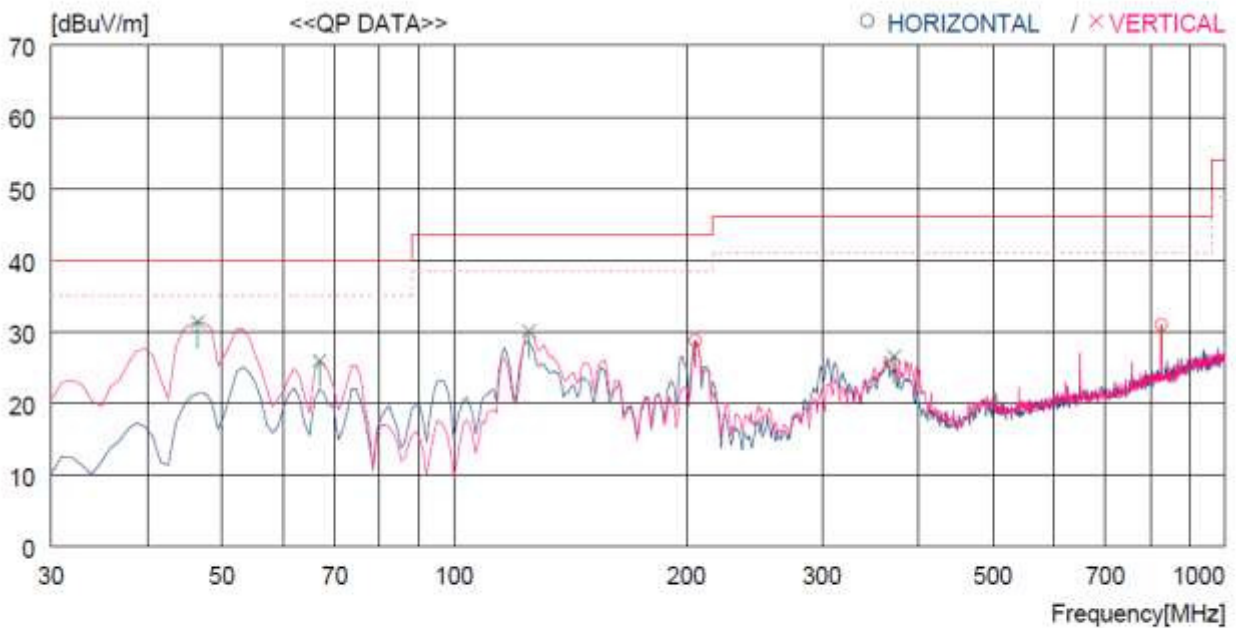

No.	FREQ [MHz]	READING QP [dBuV]	ANT FACTOR [dB]	LOSS [dB]	GAIN [dB]	RESULT [dBuV/m]	LIMIT [dBuV/m]	MARGIN [dB]	ANTENNA [cm]	TABLE [DEG]
---- Horizontal ----										
1	205.570	46.7	10.9	4.1	32.9	28.8	43.5	14.7	200	0
2	827.331	33.8	21.2	8.8	32.8	31.0	46.0	15.0	100	359
---- Vertical ----										
3	46.490	48.5	13.9	2.0	33.0	31.4	40.0	8.6	100	0
4	66.860	45.7	10.9	2.4	33.0	26.0	40.0	14.0	100	130
5	125.060	50.2	9.7	3.2	33.0	30.1	43.5	13.4	100	0
6	372.410	38.6	15.3	5.7	33.0	26.6	46.0	19.4	100	102

12.6.2 Test data for Below 30 MHz

- Test Date : March 09, 2016
- Resolution bandwidth : 200 Hz (from 9 kHz to 0.15 MHz), 9 kHz (from 0.15 MHz to 30 MHz)
- Frequency range : 9 kHz ~ 30 MHz
- Measurement distance : 3 m
- Operating mode : Transmitting mode

Frequency (MHz)	Reading (dBµV)	Ant. Pol. (H/V)	Ant. Height (m)	Angle (°)	Ant. Factor (dB/m)	Cable Loss	Emission Level(dBµV/m)	Limits (dBµV/m)	Margin (dB)
Any emissions were not observed from the EUT.									

12.6.3 Test data for above 1 GHz

- . Test Date : March 09, 2016
- . Resolution bandwidth : 1 MHz for Peak and Average Mode
- . Video bandwidth : 1 MHz for Peak Mode, 10 Hz for Average Mode
- . Frequency range : 1 GHz ~ 40 GHz
- . Measurement distance : 3 m
- . Operating mode : Transmitting mode

Frequency (MHz)	Reading (dBμV)	Detector Mode	Ant. Pol. (H/V)	Ant. Factor	Cable Loss	Amp Gain	Total (dBμV/m)	Limits (dBμV/m)	Margin (dB)
Low Channel									
11 000.00	55.18	Peak	H	39.40	17.30	42.60	69.28	73.98	4.70
	36.84	Average	H				50.94	53.98	3.04
	54.26	Peak	V				68.36	73.98	5.62
	36.34	Average	V				50.44	53.98	3.54
Middle Channel									
11 200.00	54.62	Peak	H	39.40	17.30	42.60	68.72	73.98	5.26
	36.75	Average	H				50.85	53.98	3.13
	54.79	Peak	V				68.89	73.98	5.09
	37.04	Average	V				51.14	53.98	2.84
High Channel									
11 400.00	54.81	Peak	H	39.40	17.30	42.60	68.91	73.98	5.07
	36.32	Average	H				50.42	53.98	3.56
	55.17	Peak	V				69.27	73.98	4.71
	54.81	Peak	H				50.58	53.98	3.40

Tabulated test data for Restricted Band

Remark - “H”: Horizontal, “V”: Vertical

Margin (dB) = Limits (dBμV/m) - Emission Level (dBμV/m)



Tested by: Jun-Hui, Lee / Senior Engineer

12.7 Test data for 5 725 MHz ~ 5 850 MHz Band

12.7.1 Test data for 30 MHz ~ 1 000 MHz

Humidity Level : (43 ~ 44) % R.H. Temperature: (23 ~ 24) °C

Limits apply to : FCC CFR 47, PART 15, SUBPART C, SECTION 15.247

Result : PASSED

EUT : Premium Tablet Date: March 09, 2016

Detector : CISPR Quasi-Peak (6 dB Bandwidth: 120 kHz)

-. Low, Middle and High Channels were tested, but the worst data were recorded.

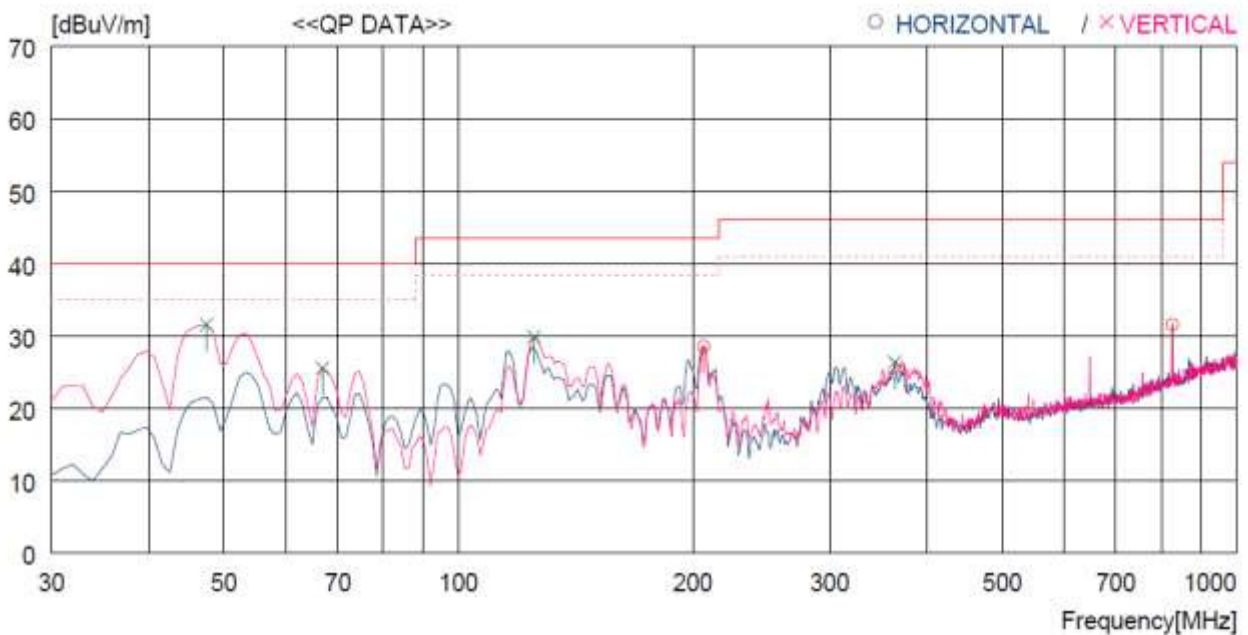

No.	FREQ [MHz]	READING QP [dBuV]	ANT FACTOR [dB]	LOSS [dB]	GAIN [dB]	RESULT [dBuV/m]	LIMIT [dBuV/m]	MARGIN [dB]	ANTENNA [cm]	TABLE [DEG]
----- Horizontal -----										
1	206.540	46.6	11.0	3.8	32.8	28.6	43.5	14.9	100	359
2	827.331	35.8	21.2	8.0	33.4	31.6	46.0	14.4	100	359
----- Vertical -----										
3	47.460	48.7	13.8	2.0	32.9	31.6	40.0	8.4	100	292
4	66.860	45.5	10.9	2.3	33.1	25.6	40.0	14.4	100	130
5	125.060	50.1	9.7	3.3	33.2	29.9	43.5	13.6	100	0
6	363.680	38.8	15.1	5.1	32.6	26.4	46.0	19.6	100	123

12.7.2 Test data for Below 30 MHz

- Test Date : March 09, 2016
- Resolution bandwidth : 200 Hz (from 9 kHz to 0.15 MHz), 9 kHz (from 0.15 MHz to 30 MHz)
- Frequency range : 9 kHz ~ 30 MHz
- Measurement distance : 3 m
- Operating mode : Transmitting mode

Frequency (MHz)	Reading (dBμV)	Ant. Pol. (H/V)	Ant. Height (m)	Angle (°)	Ant. Factor (dB/m)	Cable Loss	Emission Level(dBμV/m)	Limits (dBμV/m)	Margin (dB)
Any emissions were not observed from the EUT.									

12.7.3 Test data for above 1 GHz

- . Test Date : March 09, 2016
- . Resolution bandwidth : 1 MHz for Peak and Average Mode
- . Video bandwidth : 1 MHz for Peak Mode, 10 Hz for Average Mode
- . Frequency range : 1 GHz ~ 40 GHz
- . Measurement distance : 3 m
- . Operating mode : Transmitting mode

Frequency (MHz)	Reading (dBμV)	Detector Mode	Ant. Pol. (H/V)	Ant. Factor	Cable Loss	Amp Gain	Total (dBμV/m)	Limits (dBμV/m)	Margin (dB)
Low Channel									
11 490.00	48.65	Peak	H	39.50	17.50	42.70	62.95	73.98	11.03
	32.89	Average	H				47.19	53.98	6.79
	45.53	Peak	V				59.83	73.98	14.15
	30.72	Average	V				45.02	53.98	8.96
Middle Channel									
11 570.00	48.88	Peak	H	39.50	17.50	42.70	63.18	73.98	10.80
	33.10	Average	H				47.40	53.98	6.58
	45.42	Peak	V				59.72	73.98	14.26
	32.19	Average	V				46.49	53.98	7.49
High Channel									
11 650.00	48.40	Peak	H	39.50	17.50	42.70	62.70	73.98	11.28
	33.03	Average	H				47.33	53.98	6.65
	45.37	Peak	V				59.67	73.98	14.31
	31.77	Average	V				46.07	53.98	7.91

Tabulated test data for Restricted Band

Remark - "H": Horizontal, "V": Vertical

Margin (dB) = Limits (dBμV/m) - Emission Level (dBμV/m)



Tested by: Jun-Hui, Lee / Senior Engineer

13. RADIATED RESTRICTED BAND EDGE MEASUREMENTS

13.1 Operating environment

Temperature : 23 °C
 Relative humidity : 50 % R.H.

13.2 Test set-up for conducted measurement

The radiated emissions measurements were performed on the 3 m, open-field test site. The EUT was placed on a non-conductive turntable above the ground plane.

The system was rotated 360°, and the antenna was varied in the height between 1.0 m and 4.0 m in order to determine the maximum emission levels. This procedure was performed for horizontal and vertical polarization of the receiving antenna.

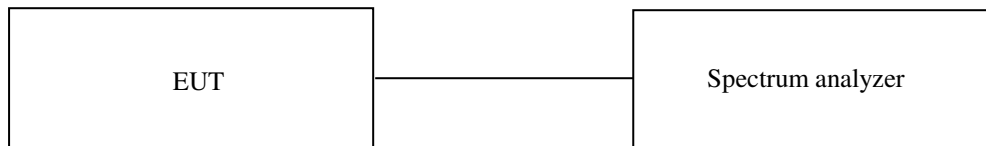

13.3 Test equipment used

Model Number	Manufacturer	Description	Serial Number	Last Cal.(Interval)
■ - FSV40	Rohde & Schwarz	Signal Analyzer	101009	Jul. 22, 2015 (1Y)
■ - ESCI	Rohde & Schwarz	Test Receiver	101012	Nov. 02, 2015 (1Y)
■ - 310N	Sonoma Instrument	Pre-Amplifier	312544	Apr. 29, 2015 (1Y)
■ - SCU-18	Rohde & Schwarz	Pre-Amplifier	10041	Nov. 23, 2015 (1Y)
■ - DT3000	Innco System	Turn Table	930611	N/A
■ - MA4000-EP	Innco System	Antenna Master	3320611	N/A
■ - VULB9163	Schwarzbeck	TRILOG Broadband Antenna	9163-421	Jul. 10, 2014 (2Y)
■ - BBHA9120D	Schwarzbeck	Horn Antenna	BBHA9120D295	Aug. 31, 2015 (2Y)
■ - BBHA9170	Schwarzbeck	Horn Antenna	BBHA9170178	Apr. 30, 2015 (2Y)

All test equipment used is calibrated on a regular basis.

13.4 Test data for 5 150 MHz ~ 5 250 MHz Band

13.4.1 Test data for 802.11a RLAN Mode

- Test Date : March 06, 2016
- Resolution bandwidth : 1 MHz for Peak and Average Mode for the emissions fall in restricted band,
100 kHz for Peak Mode for the emissions outside restricted band
- Video bandwidth : 1 MHz for Peak Mode, 10 Hz for Average Mode
- Measurement distance : 3 m
- Result : Pass

Frequency (MHz)	Reading (dBμV)	Detector Mode	Ant. Pol. (H/V)	Ant. Factor	Cable Loss	Amp Gain	Total (dBμV/m)	Limits (dBμV/m)	Margin (dB)
5 150.00	67.68	Peak	H	31.00	11.50	42.20	67.98	74.00	6.02
	42.66	Average	H				42.96	54.00	11.04
	67.23	Peak	V				67.53	74.00	6.47
	42.40	Average	V				42.70	54.00	11.30

Tabulated test data for Restricted Band

Remark - “H”: Horizontal, “V”: Vertical

Margin (dB) = Limits (dBμV/m) - Emission Level (dBμV/m)



Tested by: Jun-Hui, Lee / Senior Engineer

13.4.2 Test data for 802.11n_HT20 RLAN Mode

- Test Date : March 06, 2016
- Resolution bandwidth : 1 MHz for Peak and Average Mode for the emissions fall in restricted band,
100 kHz for Peak Mode for the emissions outside restricted band
- Video bandwidth : 1 MHz for Peak Mode, 10 Hz for Average Mode
- Measurement distance : 3 m
- Result : Pass

Frequency (MHz)	Reading (dBμV)	Detector Mode	Ant. Pol. (H/V)	Ant. Factor	Cable Loss	Amp Gain	Total (dBμV/m)	Limits (dBμV/m)	Margin (dB)
5 150.00	54.55	Peak	H	31.00	11.50	42.20	54.85	74.00	19.15
	32.72	Average	H				33.02	54.00	20.98
	52.91	Peak	V				53.21	74.00	20.79
	32.37	Average	V				32.67	54.00	21.33

Tabulated test data for Restricted Band

Remark - "H": Horizontal, "V": Vertical

$$\text{Margin (dB)} = \text{Limits (dB}\mu\text{V/m)} - \text{Emission Level (dB}\mu\text{V/m)}$$



Tested by: Jun-Hui, Lee / Senior Engineer

13.5 Test data for 5 250 MHz ~ 5 350 MHz Band

13.5.1 Test data for 802.11a RLAN Mode

- Test Date : March 06, 2016
- Resolution bandwidth : 1 MHz for Peak and Average Mode for the emissions fall in restricted band,
100 kHz for Peak Mode for the emissions outside restricted band
- Video bandwidth : 1 MHz for Peak Mode, 10 Hz for Average Mode
- Measurement distance : 3 m
- Result : Pass

Frequency (MHz)	Reading (dBµV)	Detector Mode	Ant. Pol. (H/V)	Ant. Factor	Cable Loss	Amp Gain	Total (dBµV/m)	Limits (dBµV/m)	Margin (dB)
5 350.00	49.58	Peak	H	31.30	11.70	42.20	50.38	74.00	23.62
	32.04	Average	H				32.84	54.00	21.16
	50.00	Peak	V				50.80	74.00	23.20
	31.57	Average	V				32.37	54.00	21.63

Tabulated test data for Restricted Band

Remark - “H”: Horizontal, “V”: Vertical

Margin (dB) = Limits (dBµV/m) - Emission Level (dBµV/m)



Tested by: Jun-Hui, Lee / Senior Engineer

13.5.2 Test data for 802.11n_HT20 RLAN Mode

- Test Date : March 06, 2016
- Resolution bandwidth : 1 MHz for Peak and Average Mode for the emissions fall in restricted band,
100 kHz for Peak Mode for the emissions outside restricted band
- Video bandwidth : 1 MHz for Peak Mode, 10 Hz for Average Mode
- Measurement distance : 3 m
- Result : Pass

Frequency (MHz)	Reading (dBμV)	Detector Mode	Ant. Pol. (H/V)	Ant. Factor	Cable Loss	Amp Gain	Total (dBμV/m)	Limits (dBμV/m)	Margin (dB)
5 350.00	52.51	Peak	H	31.30	11.70	42.20	53.31	74.00	20.69
	33.38	Average	H				34.18	54.00	19.82
	51.72	Peak	V				52.52	74.00	21.48
	33.36	Average	V				34.16	54.00	19.84

Tabulated test data for Restricted Band

Remark - "H": Horizontal, "V": Vertical

$$\text{Margin (dB)} = \text{Limits (dB}\mu\text{V/m)} - \text{Emission Level (dB}\mu\text{V/m)}$$



Tested by: Jun-Hui, Lee / Senior Engineer

13.6 Test data for 5 725 MHz ~ 5 850 MHz Band

13.6.1 Test data for 802.11a RLAN Mode

- Test Date : March 06, 2016
- Resolution bandwidth : 1 MHz for Peak and Average Mode for the emissions fall in restricted band,
100 kHz for Peak Mode for the emissions outside restricted band
- Video bandwidth : 1 MHz for Peak Mode, 10 Hz for Average Mode
- Measurement distance : 3 m
- Result : Pass

Frequency (MHz)	Reading (dBμV)	Detector Mode	Ant. Pol. (H/V)	Ant. Factor	Cable Loss	Amp Gain	Total (dBμV/m)	Limits (dBμV/m)	Margin (dB)
Low Channel									
5 725.00	63.20	Peak	H	31.90	12.10	42.20	65.00	74.00	9.00
	43.29	Average	H				45.09	54.00	8.91
	60.54	Peak	V				62.34	74.00	11.66
	41.42	Average	V				43.22	54.00	10.78
High Channel									
5 850.00	51.15	Peak	H	32.10	12.20	42.20	53.25	74.00	20.75
	33.48	Average	H				35.58	54.00	18.42
	47.81	Peak	V				49.91	74.00	24.09
	31.96	Average	V				34.06	54.00	19.94

Tabulated test data for Restricted Band

Remark - “H”: Horizontal, “V”: Vertical

Margin (dB) = Limits (dBμV/m) - Emission Level (dBμV/m)



Tested by: Jun-Hui, Lee / Senior Engineer

15.6.2 Test data for 802.11n_HT20 RLAN Mode

- Test Date : March 06, 2016
- Resolution bandwidth : 1 MHz for Peak and Average Mode for the emissions fall in restricted band,
100 kHz for Peak Mode for the emissions outside restricted band
- Video bandwidth : 1 MHz for Peak Mode, 10 Hz for Average Mode
- Measurement distance : 3 m
- Result : Pass

Frequency (MHz)	Reading (dBµV)	Detector Mode	Ant. Pol. (H/V)	Ant. Factor	Cable Loss	Amp Gain	Total (dBµV/m)	Limits (dBµV/m)	Margin (dB)
Low Channel									
5 725.00	64.22	Peak	H	31.90	12.10	42.20	66.02	74.00	7.98
	43.06	Average	H				44.86	54.00	9.14
	60.22	Peak	V				62.02	74.00	11.98
	40.20	Average	V				42.00	54.00	12.00
High Channel									
5 850.00	50.54	Peak	H	32.10	12.20	42.20	52.64	74.00	21.36
	33.64	Average	H				35.74	54.00	18.26
	47.04	Peak	V				49.14	74.00	24.86
	32.06	Average	V				34.16	54.00	19.84

Tabulated test data for Restricted Band

Remark - “H”: Horizontal, “V”: Vertical

$$\text{Margin (dB)} = \text{Limits (dBµV/m)} - \text{Emission Level (dBµV/m)}$$



Tested by: Jun-Hui, Lee / Senior Engineer

14. CONDUCTED EMISSION TEST

14.1 Operating environment

Temperature : (23 ~ 24) °C
 Relative humidity : (46 ~ 49) % R.H.

14.2 Test set-up

The EUT was placed on a wooden table, 0.8 m height above the floor. Power was fed to the EUT through a 50 Ω / 50 μH + 5 Ω Artificial Mains Network (AMN). The ground plane was electrically bonded to the reference ground system and all power lines were filtered from ambient.

14.3 Test equipment used

Model Number	Manufacturer	Description	Serial Number	Last Cal. (Interval)
■ - ESPI	Rohde & Schwarz	Test Receiver	101012	Nov. 02, 2015 (1Y)
□ - ESHS10	Rohde & Schwarz	Test Receiver	834467/007	Apr. 29, 2015 (1Y)
□ - NSLK8128	Schwarzbeck	AMN	8128-216	Apr. 06, 2015 (1Y)
■ - NSLK8126	Schwarzbeck	AMN	8126-404	Apr. 29, 2015 (1Y)
□ - 3825/2	EMCO	AMN	9109-1869	Apr. 29, 2015 (1Y)
■ - 3825/2	EMCO	AMN	9109-1867	Apr. 29, 2015 (1Y)

All test equipment used is calibrated on a regular basis.

14.4 Test data

14.4.1 Test data for 5 150 MHz ~ 5 250 MHz Band

- Test Date : March 08, 2016
- Resolution bandwidth : 9 kHz
- Frequency range : 0.15 MHz ~ 30 MHz
- Tested Line : HOT LINE

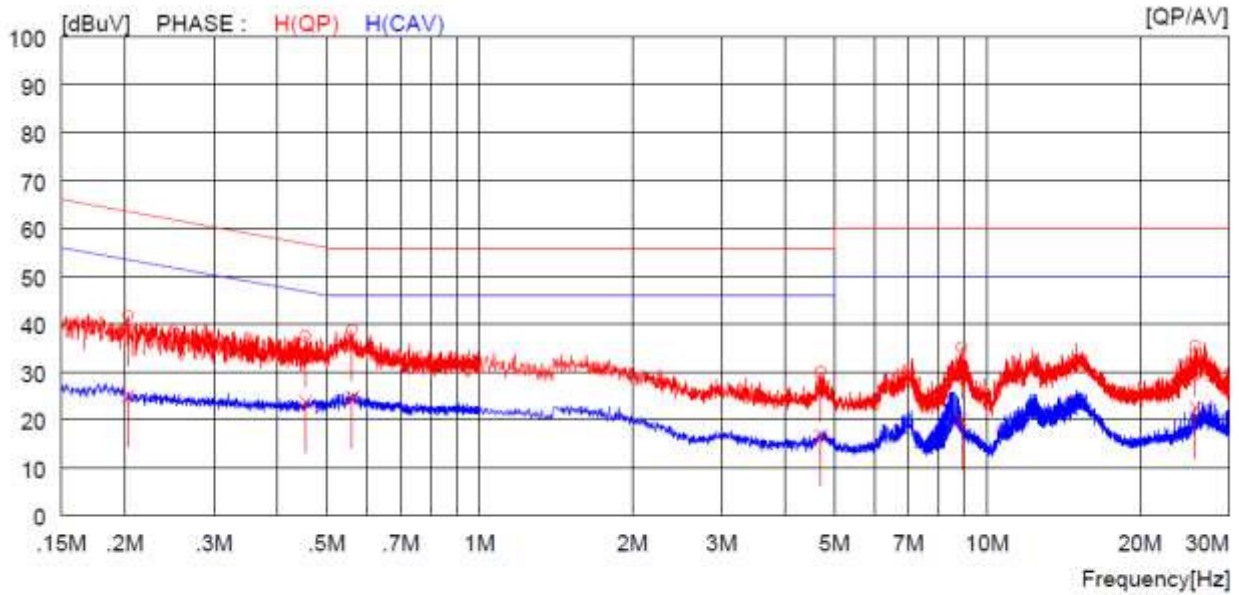

NO	FREQ [MHz]	READING		C.FACTOR		RESULT		LIMIT	MARGIN	PHASE	
		QP	AV	QP	AV	QP	AV				
		[dBuV]	[dBuV]	[dB]	[dBuV]	[dBuV]	[dBuV]	[dBuV]	[dBuV]	[dBuV]	
1	0.20300	31.9	---	9.9	41.8	---	63.5	---	21.7	---	H(QP)
2	0.45400	27.6	---	9.9	37.5	---	56.8	---	19.3	---	H(QP)
3	0.56100	28.7	---	10.0	38.7	---	56.0	---	17.3	---	H(QP)
4	4.69600	20.0	---	10.1	30.1	---	56.0	---	25.9	---	H(QP)
5	8.90000	24.8	---	10.3	35.1	---	60.0	---	24.9	---	H(QP)
6	25.72000	25.0	---	10.5	35.5	---	60.0	---	24.5	---	H(QP)
7	0.20300	---	15.2	9.9	---	25.1	---	53.5	---	28.4	H(CAV)
8	0.45400	---	13.8	9.9	---	23.7	---	46.8	---	23.1	H(CAV)
9	0.56100	---	14.7	10.0	---	24.7	---	46.0	---	21.3	H(CAV)
10	4.69600	---	6.6	10.1	---	16.7	---	46.0	---	29.3	H(CAV)
11	8.90000	---	9.7	10.3	---	20.0	---	50.0	---	30.0	H(CAV)
12	25.72000	---	12.0	10.5	---	22.5	---	50.0	---	27.5	H(CAV)

-. Tested Line : NEUTRAL LINE

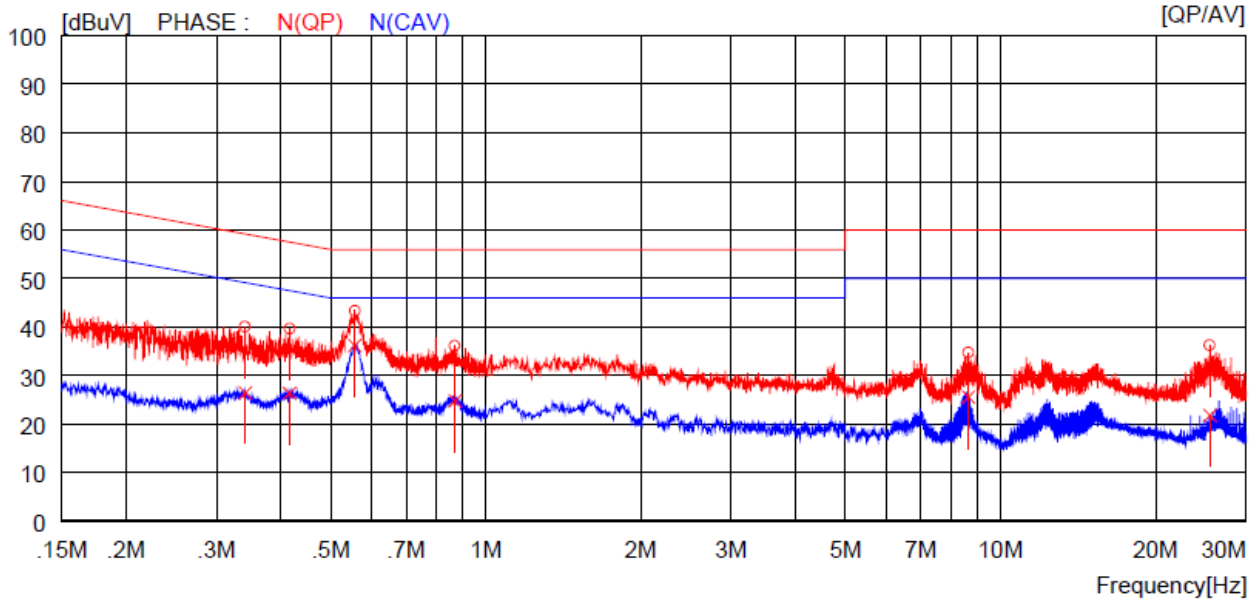

NO	FREQ		READING		C.FACTOR	RESULT		LIMIT		MARGIN	PHASE
	QP	AV	QP	AV		QP	AV	QP	AV		
	[MHz]	[dBuV]	[dBuV]	[dB]		[dBuV]	[dBuV]	[dBuV]	[dBuV]	[dBuV]	
1	0.34100	30.1	---	9.9		40.0	---	59.2	---	19.2	N(QP)
2	0.41600	29.8	---	9.9		39.7	---	57.5	---	17.8	N(QP)
3	0.55700	33.3	---	10.0		43.3	---	56.0	---	12.7	N(QP)
4	0.87100	26.1	---	10.0		36.1	---	56.0	---	19.9	N(QP)
5	8.67000	24.5	---	10.3		34.8	---	60.0	---	25.2	N(QP)
6	25.53000	25.8	---	10.5		36.3	---	60.0	---	23.7	N(QP)
7	0.34100	---	16.6	9.9		---	26.5	---	49.2	22.7	N(CAV)
8	0.41600	---	16.5	9.9		---	26.4	---	47.5	21.1	N(CAV)
9	0.55700	---	26.2	10.0		---	36.2	---	46.0	9.8	N(CAV)
10	0.87100	---	14.8	10.0		---	24.8	---	46.0	21.2	N(CAV)
11	8.67000	---	15.3	10.3		---	25.6	---	50.0	24.4	N(CAV)
12	25.53000	---	11.3	10.5		---	21.8	---	50.0	28.2	N(CAV)

Remark: Margin (dB) = Limit – Level (Result)

The emission level in above table is included the transducer factor that means insertion loss (LISN), cable loss and attenuator.

Tested by: Jun-Hui, Lee / Senior Engineer

14.4.2 Test data for 5 250 MHz ~ 5 350 MHz Band

- Test Date : March 08, 2016
- Resolution bandwidth : 9 kHz
- Frequency range : 0.15 MHz ~ 30 MHz
- Tested Line : HOT LINE

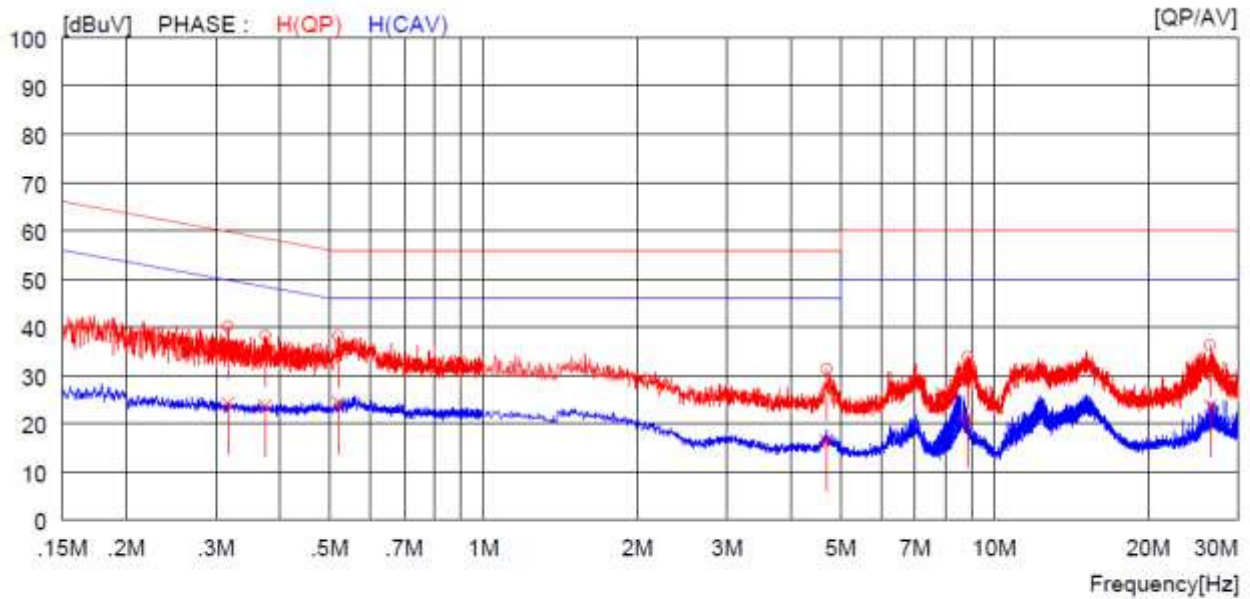

NO	FREQ		READING		C.FACTOR		RESULT		LIMIT		MARGIN	PHASE
	QP	AV	QP	AV	QP	AV	QP	AV	QP	AV		
	[MHz]	[dBuV]	[dBuV]	[dB]	[dBuV]	[dBuV]	[dBuV]	[dBuV]	[dBuV]	[dBuV]		
1	0.31600	30.2	---	9.9	40.1	---	59.8	---	19.7	---	H(QP)	
2	0.37400	28.3	---	9.9	38.2	---	58.4	---	20.2	---	H(QP)	
3	0.52000	28.1	---	10.0	38.1	---	56.0	---	17.9	---	H(QP)	
4	4.69200	21.2	---	10.1	31.3	---	56.0	---	24.7	---	H(QP)	
5	8.85500	23.5	---	10.3	33.8	---	60.0	---	26.2	---	H(QP)	
6	26.44000	25.8	---	10.5	36.3	---	60.0	---	23.7	---	H(QP)	
7	0.31600	---	14.3	9.9	---	24.2	---	49.8	---	25.6	H(CAV)	
8	0.37400	---	13.8	9.9	---	23.7	---	48.4	---	24.7	H(CAV)	
9	0.52000	---	14.3	10.0	---	24.3	---	46.0	---	21.7	H(CAV)	
10	4.69200	---	6.4	10.1	---	16.5	---	46.0	---	29.5	H(CAV)	
11	8.85500	---	11.1	10.3	---	21.4	---	50.0	---	28.6	H(CAV)	
12	26.44000	---	13.1	10.5	---	23.6	---	50.0	---	26.4	H(CAV)	

-. Tested Line : NEUTRAL LINE

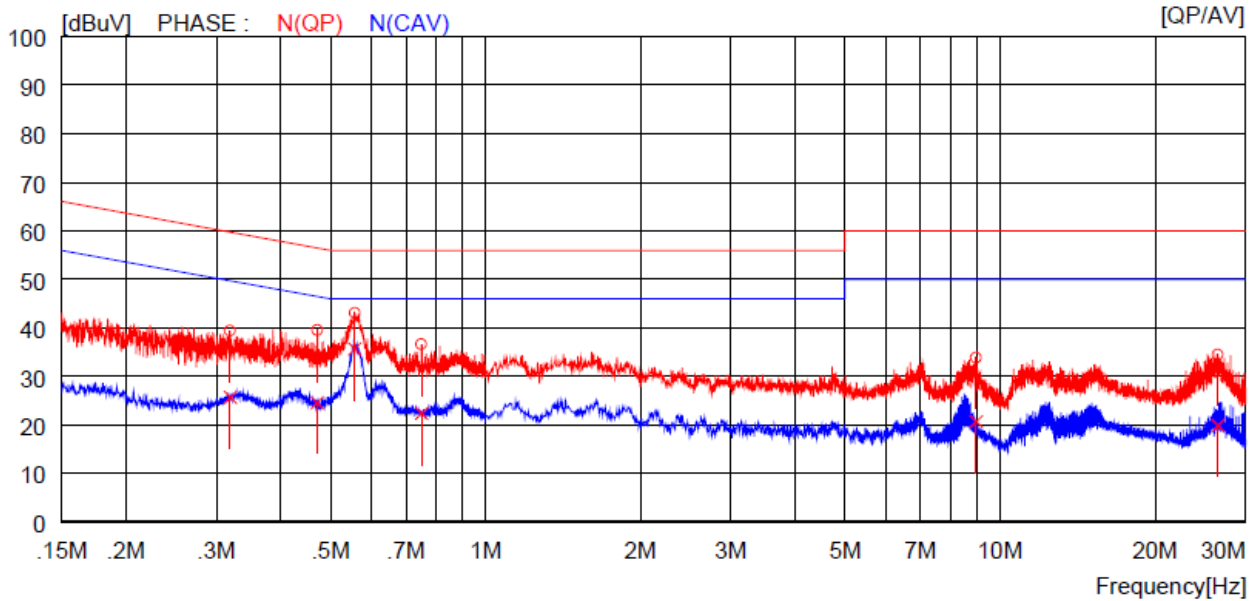

NO	FREQ [MHz]	READING		C.FACTOR [dB]	RESULT		LIMIT		MARGIN		PHASE
		QP	AV		QP	AV	QP	AV	QP	AV	
1	0.31900	29.5	---	9.9	39.4	---	59.7	---	20.3	---	N(QP)
2	0.47100	29.6	---	9.9	39.5	---	56.5	---	17.0	---	N(QP)
3	0.55700	33.1	---	10.0	43.1	---	56.0	---	12.9	---	N(QP)
4	0.75100	26.6	---	10.0	36.6	---	56.0	---	19.4	---	N(QP)
5	8.99500	23.6	---	10.3	33.9	---	60.0	---	26.1	---	N(QP)
6	26.54000	24.0	---	10.5	34.5	---	60.0	---	25.5	---	N(QP)
7	0.31900	---	15.8	9.9	---	25.7	---	49.7	---	24.0	N(CAV)
8	0.47100	---	14.7	9.9	---	24.6	---	46.5	---	21.9	N(CAV)
9	0.55700	---	25.7	10.0	---	35.7	---	46.0	---	10.3	N(CAV)
10	0.75100	---	12.4	10.0	---	22.4	---	46.0	---	23.6	N(CAV)
11	8.99500	---	10.4	10.3	---	20.7	---	50.0	---	29.3	N(CAV)
12	26.54000	---	9.4	10.5	---	19.9	---	50.0	---	30.1	N(CAV)

Remark: Margin (dB) = Limit – Level (Result)

The emission level in above table is included the transducer factor that means insertion loss (LISN), cable loss and attenuator.

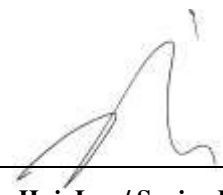

 Tested by: Jun-Hui, Lee / Senior Engineer

14.4.3 Test data for 5 470 MHz ~ 5 725 MHz Band

- Test Date : March 08, 2016
- Resolution bandwidth : 9 kHz
- Frequency range : 0.15 MHz ~ 30 MHz
- Tested Line : HOT LINE

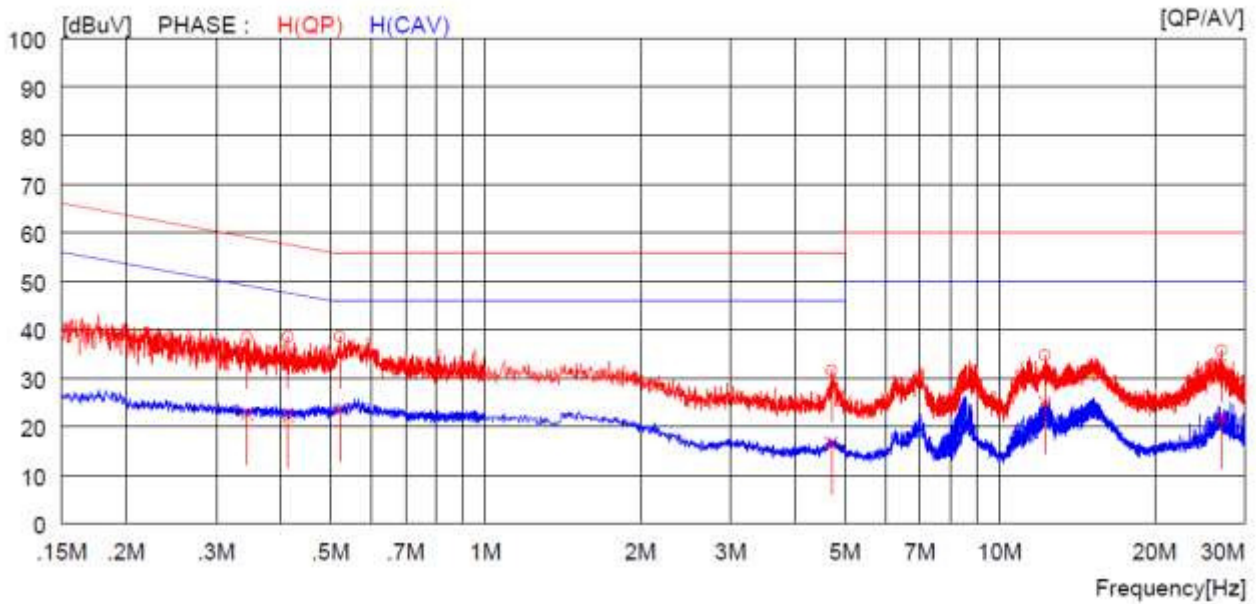

NO	FREQ [MHz]	READING		C.FACTOR		RESULT		LIMIT	MARGIN	PHASE		
		QP	AV	QP	AV	QP	AV					QP
		[dBuV]	[dBuV]	[dB]	[dBuV]	[dBuV]	[dBuV]	[dBuV]	[dBuV]	[dBuV]		
1	0.34400	28.5	---	---	9.9	38.4	---	59.1	---	20.7	---	H(QP)
2	0.41300	28.6	---	---	9.9	38.5	---	57.6	---	19.1	---	H(QP)
3	0.52000	28.5	---	---	10.0	38.5	---	56.0	---	17.5	---	H(QP)
4	4.70400	21.5	---	---	10.1	31.6	---	56.0	---	24.4	---	H(QP)
5	12.23000	24.3	---	---	10.4	34.7	---	60.0	---	25.3	---	H(QP)
6	26.99000	25.2	---	---	10.5	35.7	---	60.0	---	24.3	---	H(QP)
7	0.34400	---	---	12.7	9.9	---	22.6	---	49.1	---	26.5	H(CAV)
8	0.41300	---	---	12.3	9.9	---	22.2	---	47.6	---	25.4	H(CAV)
9	0.52000	---	---	13.4	10.0	---	23.4	---	46.0	---	22.6	H(CAV)
10	4.70400	---	---	6.5	10.1	---	16.6	---	46.0	---	29.4	H(CAV)
11	12.23000	---	---	14.6	10.4	---	25.0	---	50.0	---	25.0	H(CAV)
12	26.99000	---	---	11.4	10.5	---	21.9	---	50.0	---	28.1	H(CAV)

- Test Line : NEUTRAL LINE

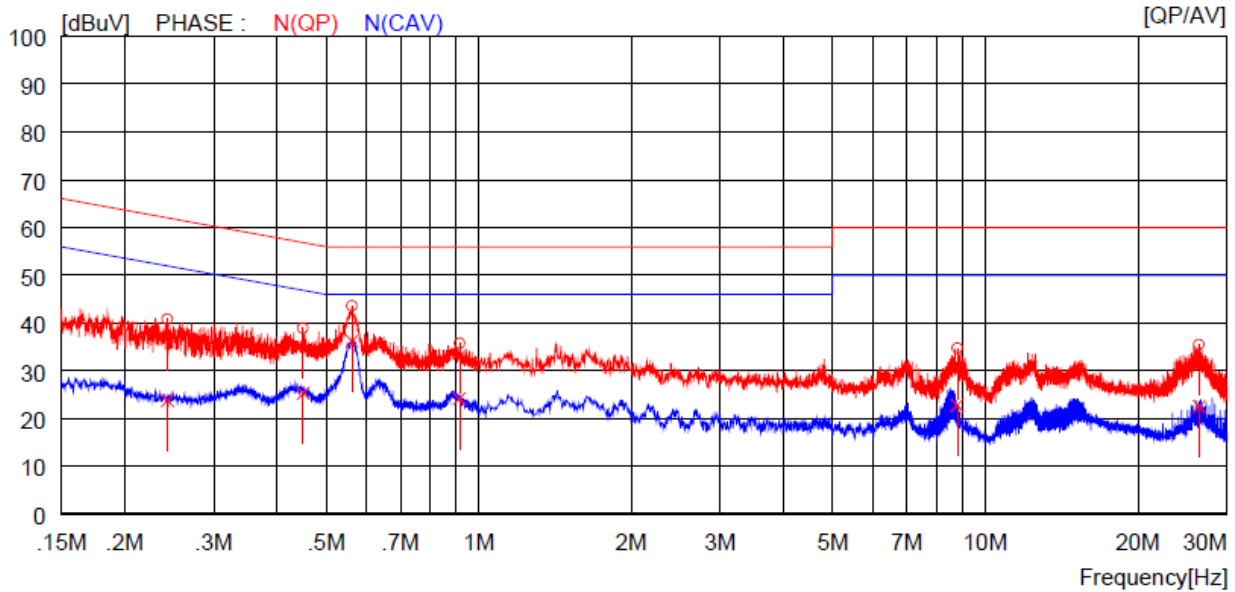

NO	FREQ [MHz]	READING		C.FACTOR [dB]	RESULT		LIMIT	MARGIN	PHASE			
		QP [dBuV]	AV [dBuV]		QP [dBuV]	AV [dBuV]						
1	0.24300	30.9	---	---	9.9	40.8	---	62.0	---	21.2	---	N(QP)
2	0.45000	29.0	---	---	9.9	38.9	---	56.9	---	18.0	---	N(QP)
3	0.56200	33.6	---	---	10.0	43.6	---	56.0	---	12.4	---	N(QP)
4	0.91700	25.8	---	---	10.0	35.8	---	56.0	---	20.2	---	N(QP)
5	8.81000	24.4	---	---	10.3	34.7	---	60.0	---	25.3	---	N(QP)
6	26.43000	25.0	---	---	10.5	35.5	---	60.0	---	24.5	---	N(QP)
7	0.24300	---	---	13.9	9.9	---	23.8	---	52.0	---	28.2	N(CAV)
8	0.45000	---	---	15.4	9.9	---	25.3	---	46.9	---	21.6	N(CAV)
9	0.56200	---	---	26.2	10.0	---	36.2	---	46.0	---	9.8	N(CAV)
10	0.91700	---	---	14.2	10.0	---	24.2	---	46.0	---	21.8	N(CAV)
11	8.81000	---	---	12.5	10.3	---	22.8	---	50.0	---	27.2	N(CAV)
12	26.43000	---	---	12.0	10.5	---	22.5	---	50.0	---	27.5	N(CAV)

Remark: Margin (dB) = Limit – Level (Result)

The emission level in above table is included the transducer factor that means insertion loss (LISN), cable loss and attenuator.



Tested by: Jun-Hui, Lee / Senior Engineer

14.4.4 Test data for 5 725 MHz ~ 5 850 MHz Band

- Test Date : March 08, 2016
- Resolution bandwidth : 9 kHz
- Frequency range : 0.15 MHz ~ 30 MHz
- Tested Line : HOT LINE

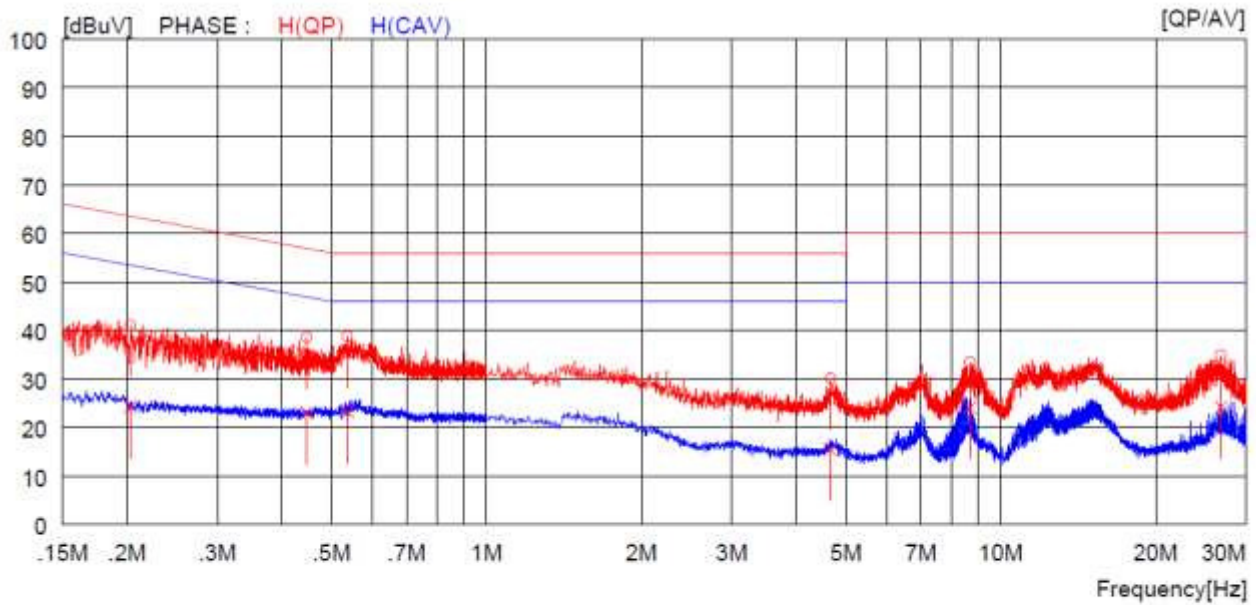

NO	FREQ		READING		C.FACTOR		RESULT		LIMIT		MARGIN	PHASE
	QP	AV	QP	AV	QP	AV	QP	AV	QP	AV		
	[MHz]	[dBuV]	[dBuV]	[dB]	[dBuV]	[dBuV]	[dBuV]	[dBuV]	[dBuV]	[dBuV]		
1	0.20300	31.2	---	9.9	41.1	---	63.5	---	22.4	---	H(QP)	
2	0.44700	28.6	---	9.9	38.5	---	56.9	---	18.4	---	H(QP)	
3	0.53700	28.8	---	10.0	38.8	---	56.0	---	17.2	---	H(QP)	
4	4.86400	20.0	---	10.1	30.1	---	56.0	---	25.9	---	H(QP)	
5	8.71500	23.2	---	10.3	33.5	---	60.0	---	26.5	---	H(QP)	
6	26.81000	24.4	---	10.5	34.9	---	60.0	---	25.1	---	H(QP)	
7	0.20300	---	14.4	9.9	---	24.3	---	53.5	---	29.2	H(CAV)	
8	0.44700	---	13.1	9.9	---	23.0	---	46.9	---	23.9	H(CAV)	
9	0.53700	---	13.2	10.0	---	23.2	---	46.0	---	22.8	H(CAV)	
10	4.86400	---	5.4	10.1	---	15.5	---	46.0	---	30.5	H(CAV)	
11	8.71500	---	13.8	10.3	---	24.1	---	50.0	---	25.9	H(CAV)	
12	26.81000	---	13.7	10.5	---	24.2	---	50.0	---	25.8	H(CAV)	

- Test Line : NEUTRAL LINE

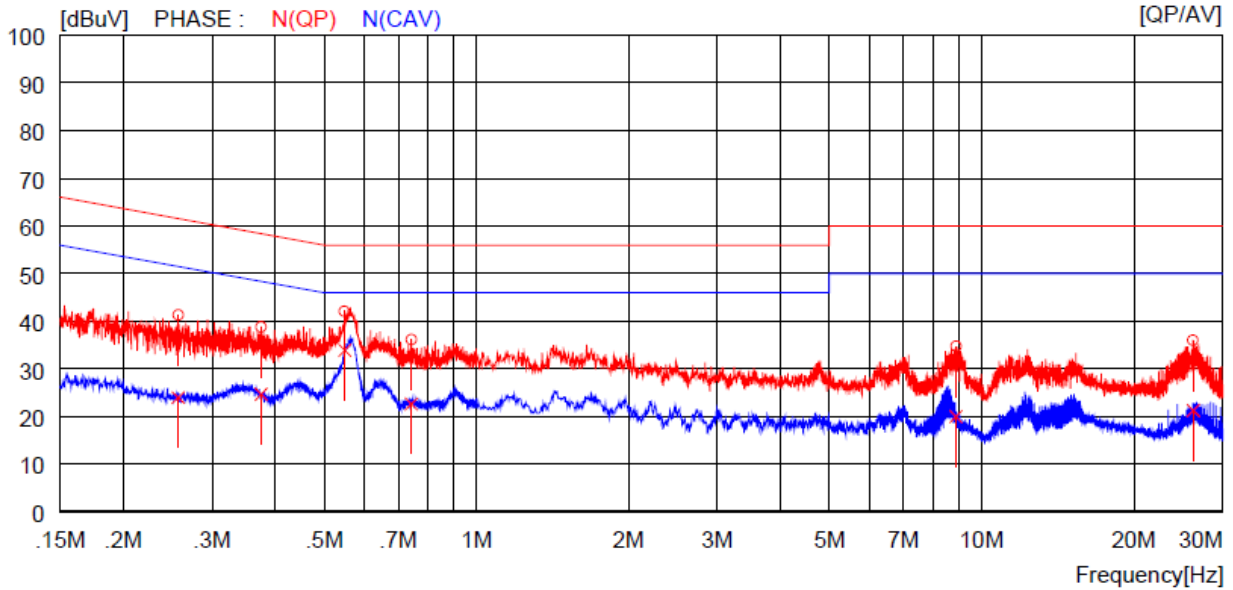

NO	FREQ [MHz]	READING		C.FACTOR	RESULT		LIMIT		MARGIN		PHASE	
		QP	AV		QP	AV	QP	AV	QP	AV		
		[dBuV]	[dBuV]	[dB]	[dBuV]	[dBuV]	[dBuV]	[dBuV]	[dBuV]	[dBuV]		
1	0.25700	31.4	---	---	9.9	41.3	---	61.5	---	20.2	---	N(QP)
2	0.37500	28.9	---	---	9.9	38.8	---	58.4	---	19.6	---	N(QP)
3	0.54900	32.0	---	---	10.0	42.0	---	56.0	---	14.0	---	N(QP)
4	0.74400	26.1	---	---	10.0	36.1	---	56.0	---	19.9	---	N(QP)
5	8.90500	24.4	---	---	10.3	34.7	---	60.0	---	25.3	---	N(QP)
6	26.24000	25.5	---	---	10.5	36.0	---	60.0	---	24.0	---	N(QP)
7	0.25700	---	---	14.1	9.9	---	24.0	---	51.5	---	27.5	N(CAV)
8	0.37500	---	---	14.8	9.9	---	24.7	---	48.4	---	23.7	N(CAV)
9	0.54900	---	---	23.9	10.0	---	33.9	---	46.0	---	12.1	N(CAV)
10	0.74400	---	---	12.7	10.0	---	22.7	---	46.0	---	23.3	N(CAV)
11	8.90500	---	---	9.7	10.3	---	20.0	---	50.0	---	30.0	N(CAV)
12	26.24000	---	---	10.8	10.5	---	21.3	---	50.0	---	28.7	N(CAV)

Remark: Margin (dB) = Limit – Level (Result)

The emission level in above table is included the transducer factor that means insertion loss (LISN), cable loss and attenuator.

Tested by: Jun-Hui, Lee / Senior Engineer

15 DYNAMIC FREQUENCY SELECTION (DFS)

15.1 Operating environment

Temperature : 23 °C
 Relative humidity : 47 % R.H.

15.2 Test set-ups

The FCC 06-96 and RSS-210 A9.3 describes a conducted test setup. A conducted test setup was user this testing. Figure 1 shows the typical test setup. Each one channel selected between 5 250 MHz and 5 350 MHz, 5 470 MHz and 5 725 MHz is chosen for the testing.

Figure 1. Setup for Client with injection at the Master

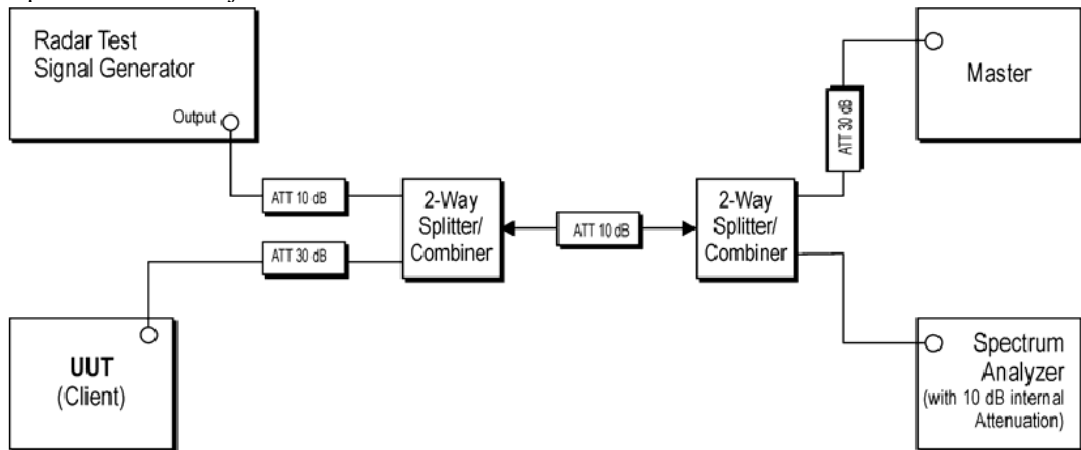

15.3 DFS Test Signals

Table 5 – Short Pulse Radar Test Waveforms

Radar Type	Pulse Width (μsec)	PRI (μsec)	Number of Pulses	Minimum Percentage of Successful Detection	Minimum Number of Trials
0	1	1428	18	See Note 1	See Note 1
1	1	Test A: 15 unique PRI values randomly selected from the list of 23 PRI values in Table 5a	Roundup $\left\{ \left(\frac{1}{360} \right) \cdot \left(\frac{19 \cdot 10^6}{PRI_{\mu sec}} \right) \right\}$	60%	30
		Test B: 15 unique PRI values randomly selected within the range of 518-3066 μ sec, with a minimum increment of 1 μ sec, excluding PRI values selected in Test A			
2	1-5	150-230	23-29	60%	30
3	6-10	200-500	16-18	60%	30
4	11-20	200-500	12-16	60%	30
Aggregate (Radar Types 1-4)				80%	120

Table 6 – Long Pulse Radar Test Waveform

Radar Type	Pulse Width (μsec)	Chirp Width (MHz)	PRI (μsec)	Number of Pulses per Burst	Number of Bursts	Minimum Percentage of Successful Detection	Minimum Number of Trials
5	50-100	5-20	1000-2000	1-3	8-20	80%	30

15.4 Technical Requirement Specification

Table 1: Applicability of DFS Requirements Prior to Use of a Channel

Requirement	Operational Mode		
	Master	Client (without DFS)	Client (with DFS)
<i>Non-Occupancy Period</i>	Yes	Not required	Yes
<i>DFS Detection Threshold</i>	Yes	Not required	Yes
<i>Channel Availability Check Time</i>	Yes	Not required	Not required
<i>Uniform Spreading</i>	Yes	Not required	Not required
<i>U-NII Detection Bandwidth</i>	Yes	Not required	Yes

Table 2: Applicability of DFS requirements during normal operation

Requirement	Operational Mode		
	Master	Client (without DFS)	Client (with DFS)
<i>DFS Detection Threshold</i>	Yes	Not required	Yes
<i>Channel Closing Transmission Time</i>	Yes	Yes	Yes
<i>Channel Move Time</i>	Yes	Yes	Yes
<i>U-NII Detection Bandwidth</i>	Yes	Not required	Yes

15.5 Test equipment used

Model Number	Manufacturer	Description	Serial Number	Last Cal. (Interval)
■ - FSV40	Rohde & Schwarz	Signal Analyzer	101009	Jul. 30, 2014 (1Y)
■ - D-05180-2	RLC Electronis Inc.	Combiner	0813	Apr. 29, 2014 (1Y)
■ - 11636B	Hewlett Packard	Combiner	12268	Nov. 08, 2014 (1Y)
■ - SMJ100A	R/S	Signal Generator	101038	Nov. 08, 2014 (1Y)
■ - DRP-305DN	DIGITAL Elec.	DC Power supply	4030195	Sep. 03, 2014 (1Y)
■ AIR-AP1252AG-K-K9	CISCO	AP	FGL1439Z0KE	N/A

All test equipment used is calibrated on a regular basis.

15.6 Test data for 5 250 MHz ~ 5 350 MHz Band

-. Test Date : March 10, 2015

Frequency (MHz)	Channel move time(s)		Channel closing transmission time(ms)	
	Measured	Limit	Measured	Limit
5 300	0.152	10	0	60

15.6.1 Plot of Radar waveform type1

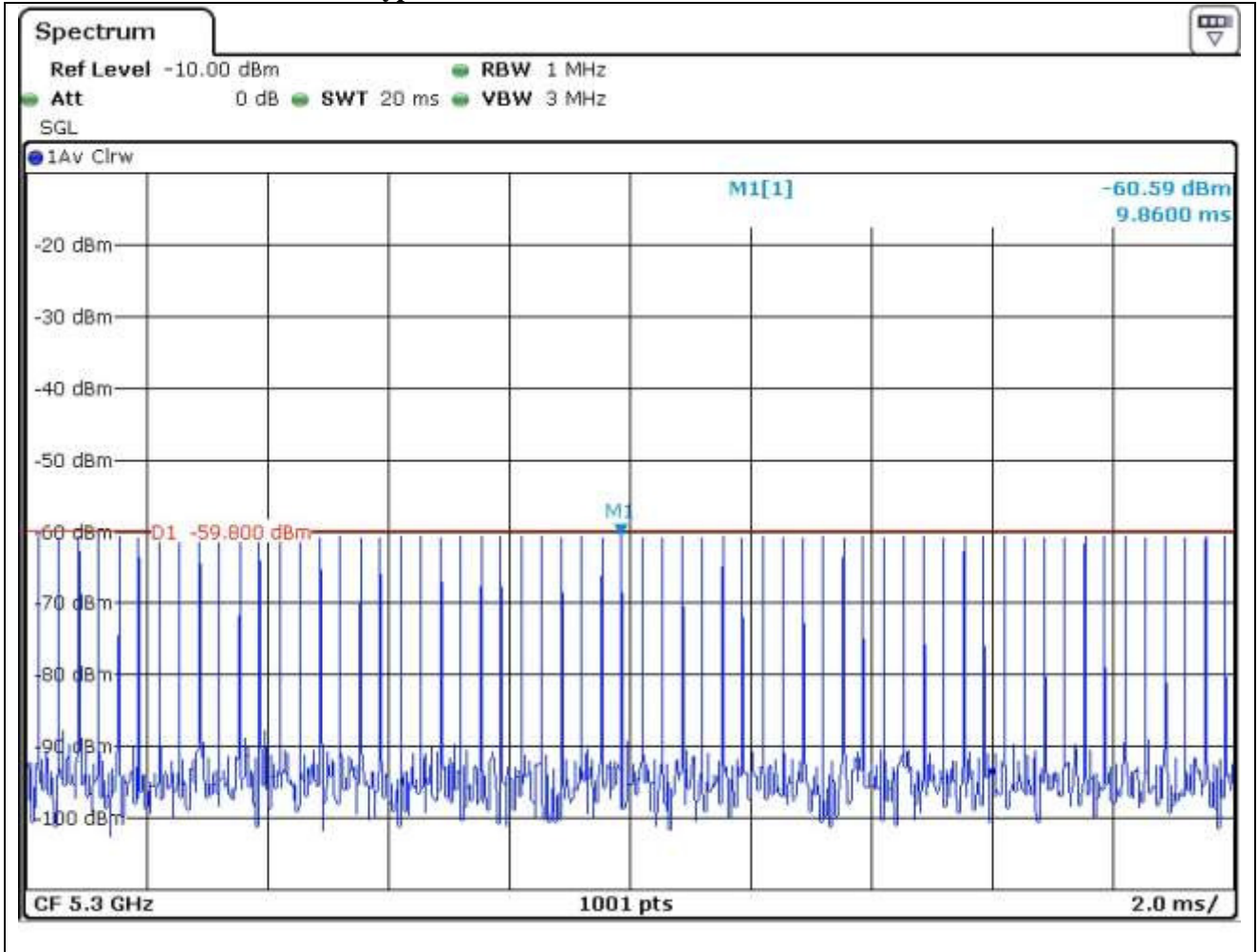

Note: The calibrated conducted DFS detection threshold level is set to -59.5 dBm (-62+1+1.00=-60.00)

15.6.3 Client(EUT) Data Traiifc Signal

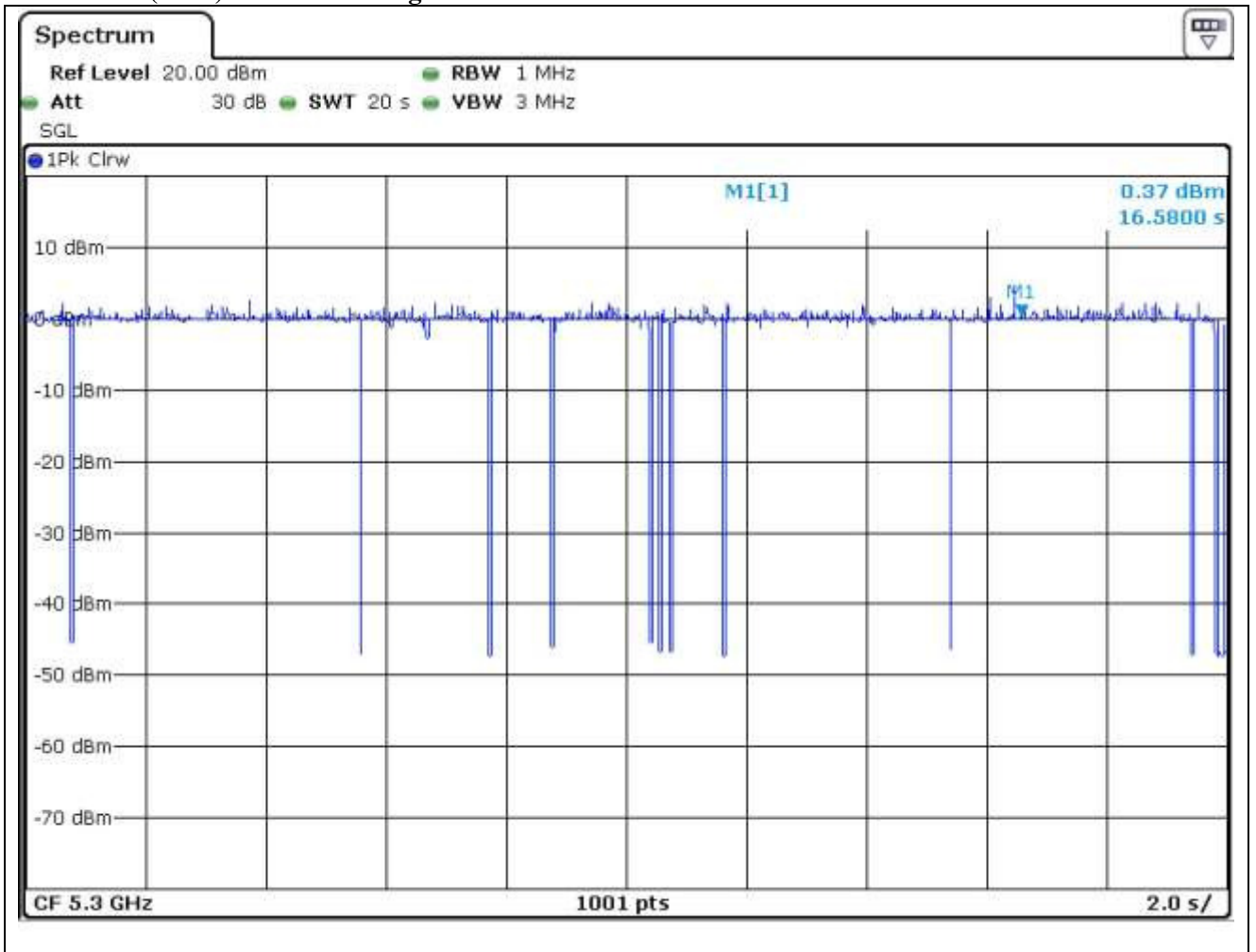

15.6.4 Channel move and Channel Closing transmission time

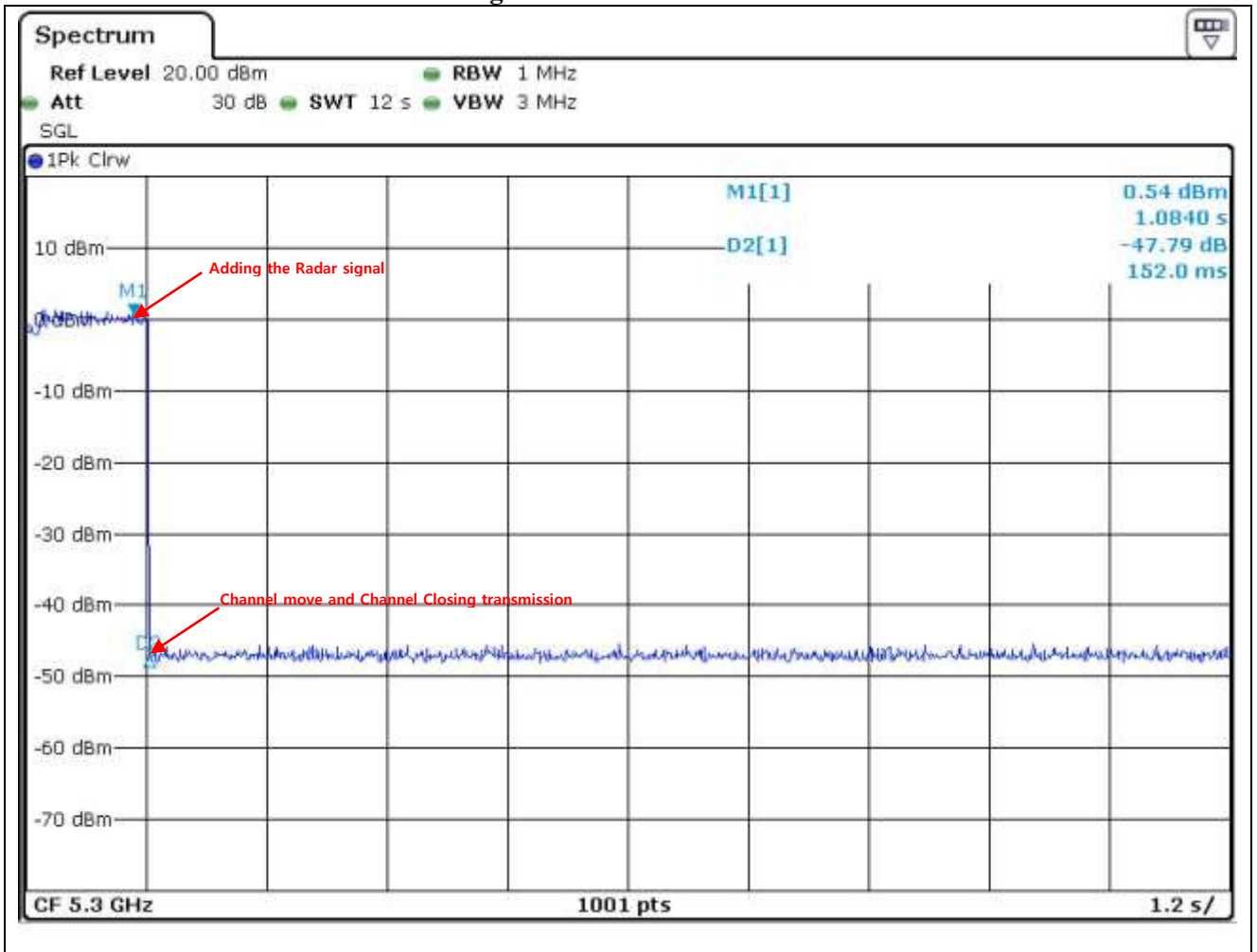

15.7 Test data for 5 470 MHz ~ 5 725 MHz Band

-. Test Date : March 11, 2015

Frequency (MHz)	Channel move time(s)		Channel closing transmission time(ms)	
	Measured	Limit	Measured	Limit
5 600	0.152	10	0	60

15.7.1 Plot of Radar waveform type1

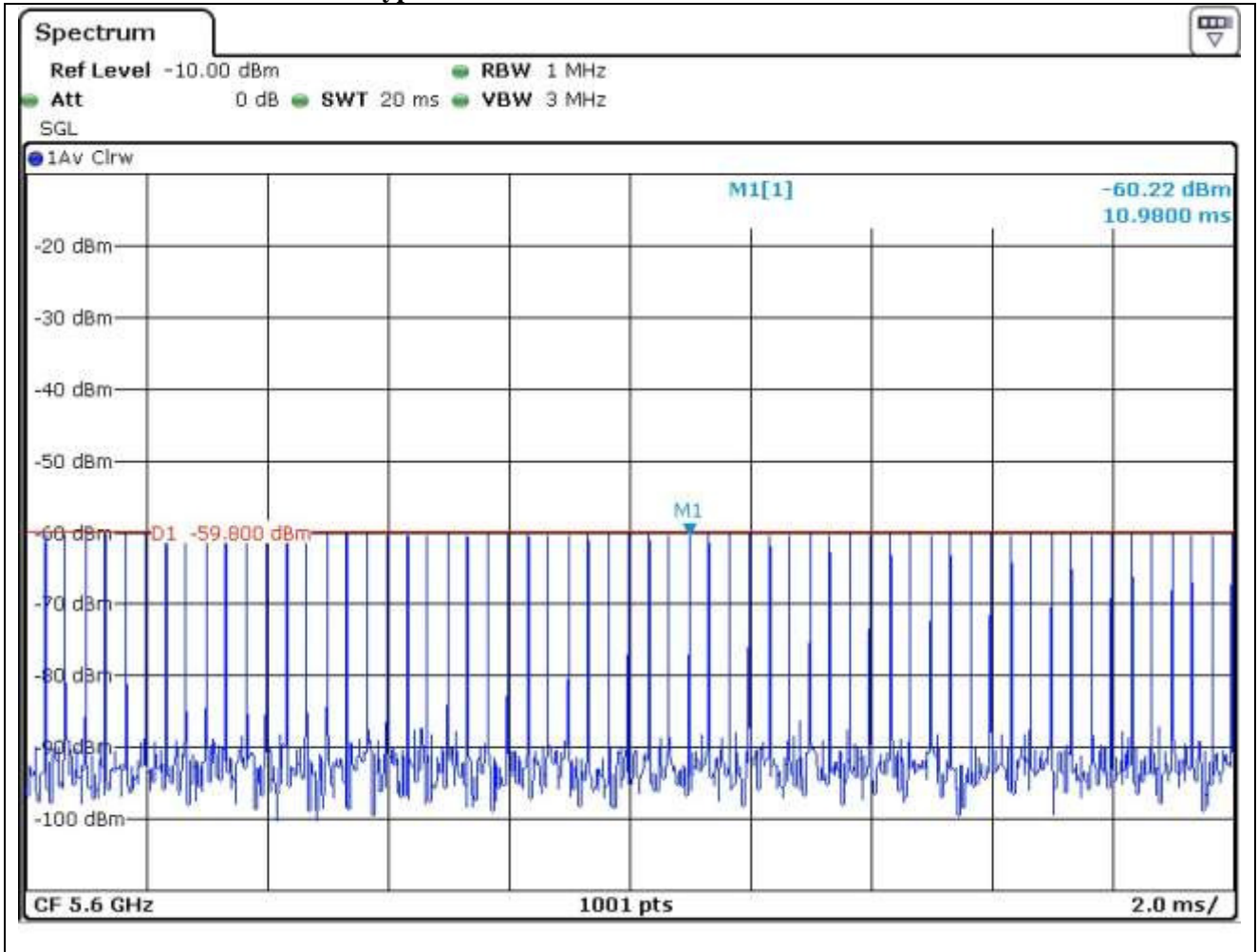

Note: The calibrated conducted DFS detection threshold level is set to -59.5 dBm (-62+1+1.01=-59.99)

15.7.2 No traffic signal(master signal)

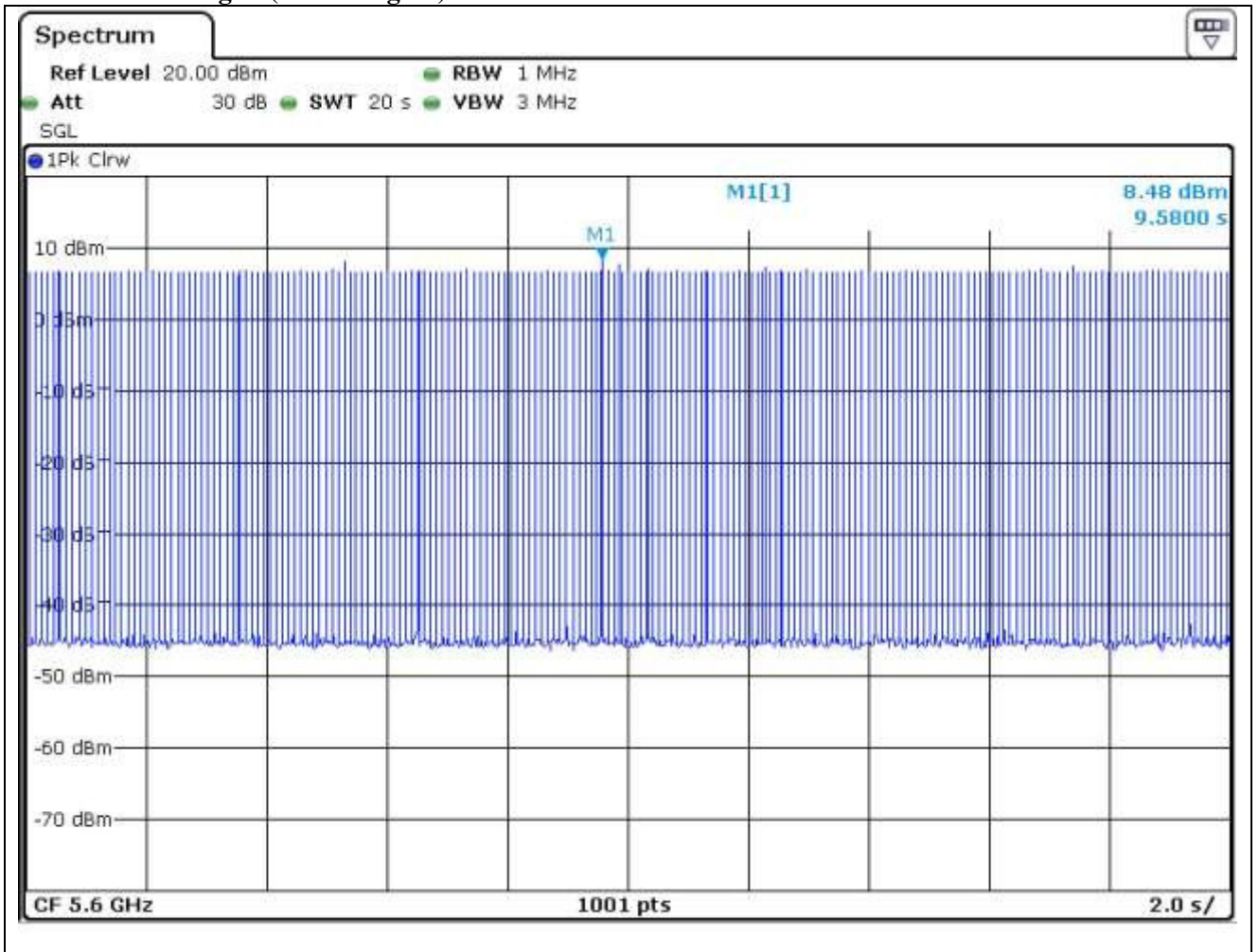

15.7.3 Client(EUT) Data Traiifc Signal

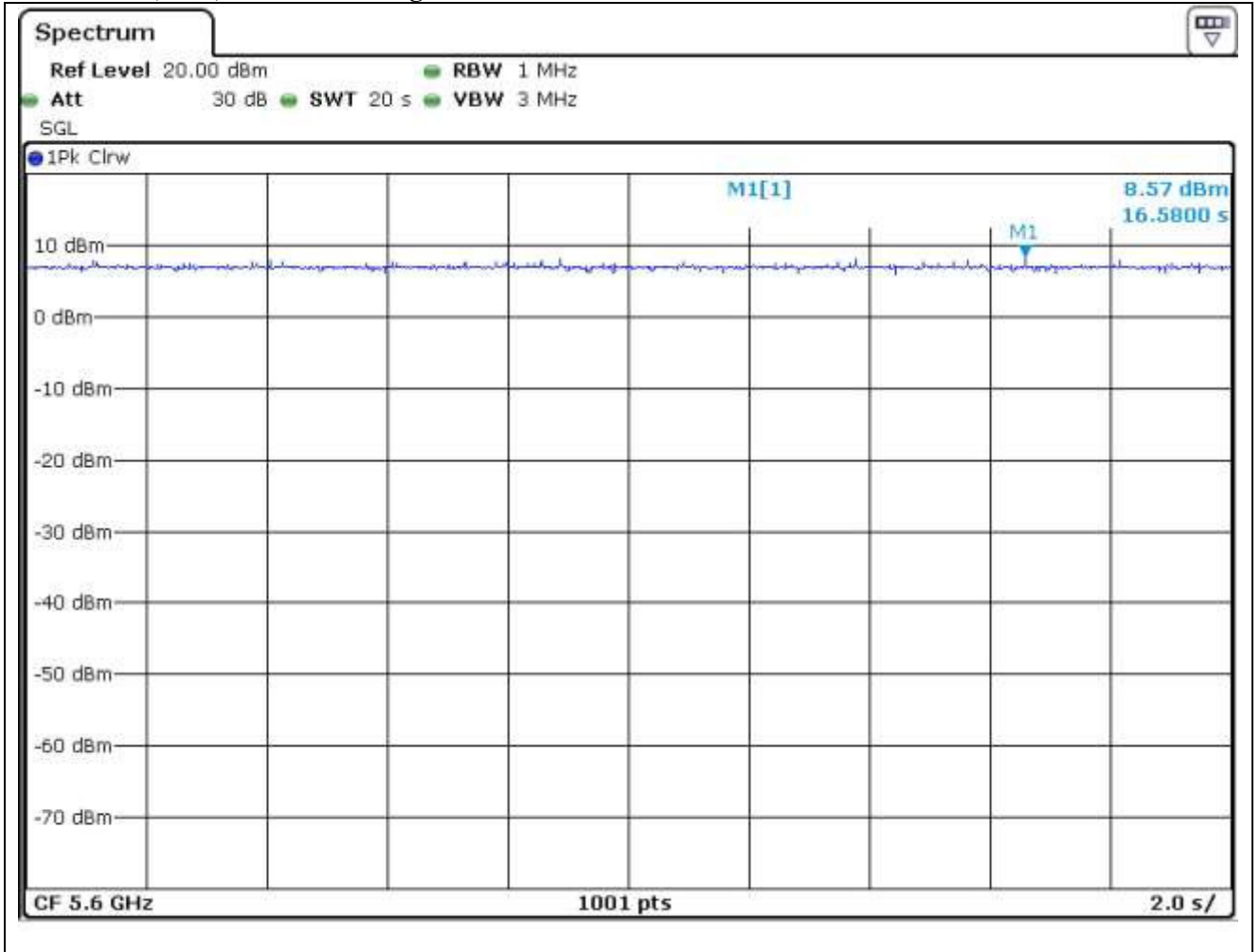

15.7.4 Channel move and Channel Closing transmission time

