

# SAR EVALUATION REPORT

<b>Test Report No.</b>	<b>W164R-D029</b>		
<b>Applicant</b>	<b>Bluebird Inc.</b> <b>(Dogok-dong, SEI Tower 13,14)39, Eonjuro30-gil, Gangnam-gu, Seoul, South Korea</b>		
<b>Model Name</b>	<b>RT100</b>		
<b>DUT Type</b>	<b>Premium Tablet</b>		
<b>Application Type</b>	<b>Certification</b>		
<b>FCC ID</b>	<b>SS4RT100</b>		
<b>Date of Report</b>	<b>Apr 14, 2016</b>		
<b>Date of Test</b>	<b>Mar 29, 2016 ~ Apr 12, 2016</b>		
<b>Test Laboratory</b>	<b>ONETECH</b> <b>301-14 Daessangnyeong-ri, Chowol-eup, Gwangju-si, Gyeonggi-do 464-862, Korea</b>		
<b>Procedures</b>	<b>KDB 865664</b> <b>IEEE 1528-2003</b> <b>ANSI/IEEE C95.1, C95.3</b> <b>FCC CFR §2.1093</b> <b>RSS-102 Issue 4</b>		
<b>Max SAR(1g)</b>	<b>1.363 W/kg</b>		
<b>Test Opinion</b>	<b>Satisfied to FCC requirements</b>		
<b>Report Author</b>	<b>Jungwook Kim</b>	 _____	<b>Apr 14, 2016</b>
<b>Test Engineer</b>	<b>Youngyong Kim</b>	 _____	<b>Apr 14, 2016</b>

This report details the results of the testing carried out on one sample, the results contained in this test report do not relate to other samples of the same product. The manufacturer should ensure that all products in series production are in conformity with the product sample detailed in this report.

This report may only be reproduced and distribute in full. If the product in this report is used in any configuration other than that detailed in the report, the manufacturer must ensure the new system complies with all relevant standards. Any mention of ONETECH Corp. or testing done by ONETECH Corp. In connection with distribution or use of the product described in this report must be approved by ONETECH Corp. in writing.

# TABLE OF CONTENTS

1. DUT INFORMATION .....	3
2. INTRODUCTION .....	5
3. SAR MEASUREMENT SETUP .....	6
4. MEASUREMENT UNCERTAINTY .....	10
5. ANSI/IEEE C95.1-2005 RF EXPOSURE LIMIT .....	12
6. SYSTEM AND LIQUID VERIFICATION .....	13
7. SAR MEASUREMENT PROCEDURES .....	17
8. TEST EQUIPMENT LIST .....	19
9. RF CONDUCTED POWER .....	21
10. SAR TEST RESULTS .....	28
ANNEX A. SYSTEM VERIFICATION PLOTS .....	30
ANNEX B. SAR TEST PLOTS .....	36
ANNEX C. PHOTOGRAPHS .....	50
ANNEX D. ANTENNA INFORMATION .....	61
ANNEX E. PROBE AND DIPOLE CALIBRATION CERTIFICATES .....	64

## 1. DUT INFORMATION

DUT Description	Premium Tablet
Model Name	RT100
Serial Number	Identical Prototype
Module Model Name	MU739
WWAN Module FCC ID	QISMU739
Mode of Operation	GSM 850, GSM 1900, WCDMA Band II, WCDMA Band V, WLAN, Bluetooth
TX Frequency Range	<p>824.2 MHz ~ 848.8 MHz (GSM 850)</p> <p>1 850.2 MHz ~ 1 909.8 MHz (GSM 1900)</p> <p>1 852.4 MHz ~ 1 907.6 MHz (WCDMA Band II)</p> <p>826.4 MHz ~ 846.6 MHz (WCDMA Band V)</p> <p>2 412 MHz ~ 2 462 MHz (802.11b/g/n_HT20)</p> <p>5 180 MHz ~ 5 240 MHz (802.11a/n_HT20)</p> <p>5 260 MHz ~ 5 320 MHz (802.11a/n_HT20)</p> <p>5 500 MHz ~ 5 700 MHz (802.11a/n_HT20)</p> <p>5 745 MHz ~ 5 825 MHz (802.11a/n_HT20)</p> <p>2 402 MHz ~ 2 480 MHz (Bluetooth)</p>
Maximum Average Conducted Power	<p>GSM 850 : 33.45 dBm (ch 190)</p> <p>GSM 1900 : 30.39 dBm (ch 512)</p> <p>WCDMA Band II : 24.36 dBm (ch 9400)</p> <p>WCDMA Band V : 24.42 dBm (ch 4183)</p> <p>802.11b : 15.94 dBm (ch 1)</p> <p>802.11a U-NII 1 : 13.31 dBm (ch 40)</p> <p>802.11a U-NII 2A : 13.46 dBm (ch 60)</p> <p>802.11a U-NII 2C : 13.35 dBm (ch 112)</p> <p>802.11a U-NII 3 : 14.42 dBm (ch 149)</p> <p>Bluetooth : 7.98 dBm (ch 39)</p>

Summery of peak SAR	<p>GSM 850 : 0.096 W/kg          GSM 1900 : 0.461 W/kg  <b>WCDMA Band II : 1.363 W/kg</b>          WCDMA Band V : 0.123 W/kg          802.11b : 0.939 W/kg          802.11a U-NII 2A : 0.866 W/kg          802.11a U-NII 2C : 0.793 W/kg          802.11a U-NII 3 : 0.791 W/kg</p>
Body Worn Accessory	N/A
Antenna Type & Gain	<p>WWAN Antenna Type : PIFA          WLAN Antenna Type : PIFA          824 MHz : 0.288 dBi / 850 MHz : 1.747 dBi / 880 MHz : 2.812 dBi          894 MHz : 1.837 dBi / 917 MHz : 2.393 dBi / 940 MHz : 2.138 dBi          1 710 MHz : 0.473 dBi / 1 780 MHz : 2.339 dBi / 1 850 MHz : 2.561 dBi          1 880 MHz : 2.187 dBi / 1 920 MHz : 1.540 dBi / 1 990 MHz : 2.435 dBi          2 400 MHz : 0.527 dBi / 2 420 MHz : 0.519 dBi / 2 440 MHz : 0.966 dBi          2 460 MHz : 1.018 dBi / 2 480 MHz : 0.983 dBi / 2 500 MHz : 0.673 dBi          5 150 MHz : 0.275 dBi / 5 250 MHz : 0.556 dBi / 5 350 MHz : 0.996 dBi          5 450 MHz : 1.029 dBi / 5 550 MHz : 1.057 dBi / 5 650 MHz : 1.364 dBi          5 750 MHz : 1.308 dBi / 5 875 MHz : 0.852 dBi</p>
Antenna Operation	1 Antenna Transmit only (not support simultaneous transmit)
Battery	DC 3.8 V, 6000 mAh

## 2. INTRODUCTION

The FCC and Industry Canada have adopted the guidelines for evaluating the environmental effects of radio frequency (RF) radiation in ET Docket 93-62 on Aug. 6, 1996 and Health Canada Safety Code 6 to protect the public and workers from the potential hazards of RF emissions due to FCC-regulated portable devices.

The safety limits used for the environmental evaluation measurements are based on the criteria published by the American National Standards Institute (ANSI) for localized specific absorption rate (SAR) in IEEE/ANSI C95.1-1992 Standard for Safety Levels with Respect to Human Exposure to Radio Frequency Electromagnetic Fields, 3 kHz to 300 GHz and Health Canada RF Exposure Guidelines Safety Code 6. The measurement procedure described in IEEE/ANSI C95.3-2002 Recommended Practice for the Measurement of Potentially Hazardous Electromagnetic Fields - RF and Microwave is used for guidance in measuring the Specific Absorption Rate (SAR) due to the RF radiation exposure from the Equipment Under Test (EUT). These criteria for SAR evaluation are similar to those recommended by the International Committee for Non-Ionizing Radiation Protection (ICNIRP) in Biological Effects and Exposure Criteria for Radiofrequency Electromagnetic Fields," Report No. Vol 74. SAR is a measure of the rate of energy absorption due to exposure to an RF transmitting source. SAR values have been related to threshold levels for potential biological hazards.

### 2.1 SAR Definition

Specific Absorption Rate is defined as the time derivative (rate) of the incremental energy (dU) absorbed by (dissipated in) an incremental mass (dm) contained in a volume element (dV) of a given density (ρ).

$$SAR = \frac{d}{dt} \left( \frac{dW}{dm} \right) = \frac{d}{dt} \left( \frac{dW}{\rho dV} \right)$$

SAR is expressed in units of watts per kilogram (W/kg). SAR can be related to the electric field at a point by

$$SAR = \frac{\sigma |E|^2}{\rho}$$

where:

- σ = conductivity of the tissue (S/m)
- ρ = mass density of the tissue (kg/m<sup>3</sup>)
- E = rms electric field strength (V/m)

### 3. SAR MEASUREMENT SETUP

- A standard high precision 6-axis robot with controller, teach pendant and software. An arm extension for accommodating the data acquisition electronics (DAE).
- An isotropic Field probe optimized and calibrated for the targeted measurement.
- Data acquisition electronics (DAE) which performs the signal amplification, signal multiplexing,
- AD-conversion, offset measurements, mechanical surface detection, collision detection, etc. The unit is battery powered with standard or rechargeable batteries. The signal is optically transmitted to the EOC.
- The Electro-optical converter (EOC) performs the conversion from optical to electrical signals for the digital communication to the DAE. To use optical surface detection, a special version of the EOC is required. The EOC signal is transmitted to the measurement server.
- The function of the measurement server is to perform the time critical tasks such as signal filtering, control of the robot operation and fast movement interrupts.
- The Light Beam used is for probe alignment. This improves the (absolute) accuracy of the probe positioning.
- A computer running WinXP or Win7 and the DASY5 software.
- Remote control and teach pendant as well as additional circuitry for robot safety such as warning lamps, etc.
- The phantom, the device holder and other accessories according to the targeted measurement.

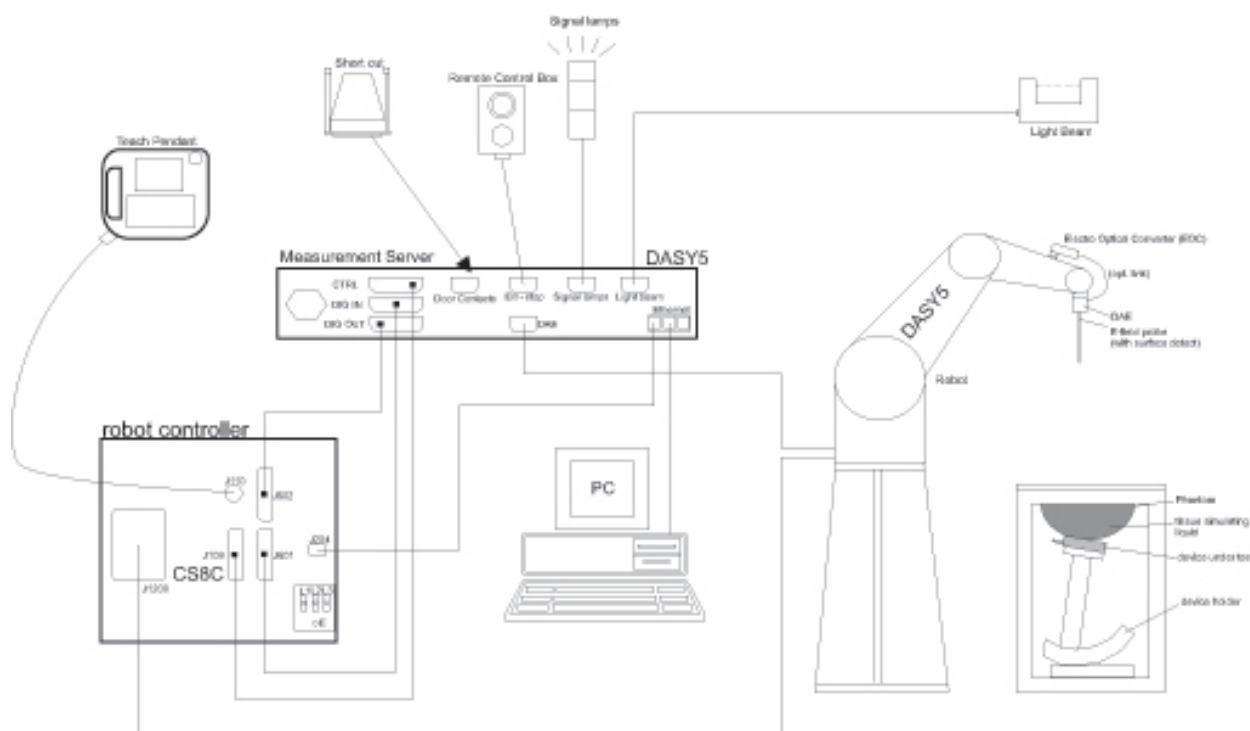

### 3.1 Dasy 5 system

DASY52 SAR	
	<p>DASY52 SAR is a cost-effective package for demonstration of compliance of mobile phones with specific absorption rate (SAR) limits. The fastest and most accurate scanner on the market, it is fully compatible with all worldwide standards for transmitters operating at the ear or near the body (&lt;200 mm from the skin).</p>
<p><b>Components</b> (typical configuration)</p>	<ul style="list-style-type: none"> <li>1 <b>TX90XL</b> Stäubli Robot and Controller CS8c incl. Cabinet</li> <li>1 <b>EOCx</b> Electro Optical Converter (mounted on robot arm)</li> <li>1 Robot Stand for TX90XL</li> <li>1 Robot Arm Extension and Adaptors</li> <li>1 Robot Remote Control</li> <li>1 <b>LB5</b> Light Beam Switch for Probe Tooling (incl. LB Adaptor)</li> <li>1 Light Beam Mounting Plate</li> <li>1 DASY5 Measurement Server</li> <li>1 PC Intel Core 2 Dual / 3.16 GHz (or higher) incl. Color-Monitor 23" - 4 GB RAM, 220 GB HD (or larger) / Win7</li> <li>1 <b>SAM Twin</b> Phantom V5.0 incl. Support DASY5</li> <li>1 <b>MD4HHTV5</b> Mounting Device for Hand-Held Transmitters</li> <li>1 <b>DAEx</b> Data Acquisition Electronics</li> <li>1 <b>ES3DVx</b> SAR Probe (incl. ConvF for HSL at 900 and 1750 MHz)</li> </ul>

### 3.2 E-Field Probe (EX3DV4)

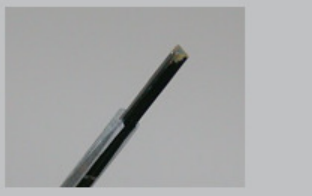
EX3DV4 Smallest Isotropic E-Field Probe for Dosimetric Measurements (Preliminary Specifications)	
	<p>Symmetrical design with triangular core Built-in shielding against static charges PEEK enclosure material (resistant to organic solvents, e.g., DGBE)</p>
<p><b>Calibration</b></p>	<p>ISO/IEC 17025 <a href="#">calibration service</a> available.</p>
<p><b>Frequency</b></p>	<p>10 MHz to &gt; 6 GHz Linearity: ± 0.2 dB (30 MHz to 6 GHz)</p>
<p><b>Directivity</b></p>	<p>± 0.3 dB in TSL (rotation around probe axis) ± 0.5 dB in TSL (rotation normal to probe axis)</p>
<p><b>Dynamic Range</b></p>	<p>10 µW/g to &gt; 100 mW/g Linearity: ± 0.2 dB (noise: typically &lt; 1 µW/g)</p>
<p><b>Dimensions</b></p>	<p>Overall length: 337 mm (Tip: 20 mm) Tip diameter: 2.5 mm (Body: 12 mm) Typical distance from probe tip to dipole centers: 1 mm</p>
<p><b>Application</b></p>	<p>High precision dosimetric measurements in any exposure scenario (e.g., very strong gradient fields); the only probe that enables compliance testing for frequencies up to 6 GHz with precision of better 30%.</p>

### 3.3 E-Field Probe(ES3DV3)

<b>ES3DV3</b> <b>Isotropic E-Field Probe for Dosimetric Measurements</b>	
	Symmetrical design with triangular core Interleaved sensors Built-in shielding against static charges PEEK enclosure material (resistant to organic solvents, e.g., DGBE)
<b>Calibration</b>	ISO/IEC 17025 <a href="#">calibration service</a> available.
<b>Frequency</b>	10 MHz to 4 GHz; Linearity: $\pm 0.2$ dB (30 MHz to 4 GHz)
<b>Directivity</b>	$\pm 0.2$ dB in TSL (rotation around probe axis) $\pm 0.3$ dB in TSL (rotation normal to probe axis)
<b>Dynamic Range</b>	5 $\mu$ W/g to > 100 mW/g; Linearity: $\pm 0.2$ dB
<b>Dimensions</b>	Overall length: 337 mm (Tip: 20 mm) Tip diameter: 3.9 mm (Body: 12 mm) Distance from probe tip to dipole centers: 2.0 mm
<b>Application</b>	General dosimetry up to 4 GHz Dosimetry in strong gradient fields Compliance tests of mobile phones
<b>Compatibility</b>	DASY3, DASY4, DASY52 SAR and higher, EASY4/MRI

### 3.4 ELI Phantom

<b>ELI</b>	
	Phantom for compliance testing of handheld and body-mounted wireless devices in the frequency range of 30 MHz to 6 GHz. ELI is fully compatible with the IEC 62209-2 standard and all known tissue simulating liquids. ELI has been optimized regarding its performance and can be integrated into our standard phantom tables. A cover prevents evaporation of the liquid. Reference markings on the phantom allow installation of the complete setup, including all predefined phantom positions and measurement grids, by teaching three points. The phantom is compatible with all SPEAG dosimetric probes and dipoles.  ELI V5.0 has the same shell geometry and is manufactured from the same material as ELI4, but has reinforced top structure.
<b>Material</b>	Vinylester, glass fiber reinforced (VE-GF)
<b>Liquid Compatibility</b>	Compatible with all SPEAG tissue simulating liquids (incl. DGBE type)
<b>Shell Thickness</b>	2.0 $\pm$ 0.2 mm (bottom plate)
<b>Dimensions</b>	Major axis: 600 mm Minor axis: 400 mm
<b>Filling Volume</b>	approx. 30 liters
<b>Wooden Support</b>	SPEAG standard phantom table



### 3.5 Mounting Device



Mounting Device for Laptops

**MD4LAPV5 - Mounting Device for Laptops and other Body-Worn Transmitters**

In combination with the Twin SAM V5.0/V5.0c or ELI Phantoms, the Mounting Device (Body-Worn) enables testing of transmitter devices according to IEC 62209-2 specifications. The device holder can be locked for positioning at flat phantom section.

**Material:** Polyoxymethylene (POM), PET-G, Foam

## 4. MEASUREMENT UNCERTAINTY

### Uncertainty of SAR equipment for measurement Body 0.3 GHz to 3 GHz

No.		Error Description	Uncertainty Value (1 g) (%)	Uncertainty Value (10 g) (%)	Probe Dist.	Div.	$C_i$ (1 g)	$C_i$ (10 g)	$U_i(t)$ (1 g)	$U_i(t)$ (10 g)	$V_i$ or $V_{eff}$
1	$U_{PR-cal}$	Probe Calibration	6.30	6.30	N	1.00	1.00	1.00	6.30	6.30	$\infty$
2	$U_{PR-is}$	Isotropy	1.87	1.87	R	$\sqrt{3}$	1.00	1.00	1.08	1.08	$\infty$
3	$U_L$	Linearity	0.60	0.60	R	$\sqrt{3}$	1.00	1.00	0.35	0.35	$\infty$
4	$U_{PR-mod}$	Probe modulation response	2.40	2.40	R	$\sqrt{3}$	1.00	1.00	1.39	1.39	$\infty$
6	$U_{DL}$	Detection Limits	1.00	1.00	R	$\sqrt{3}$	1.00	1.00	0.58	0.58	$\infty$
5	$U_{BE}$	Boundary effect	1.00	1.00	R	$\sqrt{3}$	1.00	1.00	0.58	0.58	$\infty$
7	$U_{RE}$	Readout Electronics	0.30	0.30	N	1.00	1.00	1.00	0.30	0.30	$\infty$
8	$U_{T-res}$	Response Time	0.80	0.80	R	$\sqrt{3}$	1.00	1.00	0.46	0.46	$\infty$
9	$U_{T-int}$	Integration Time	2.60	2.60	R	$\sqrt{3}$	1.00	1.00	1.50	1.50	$\infty$
10	$U_{A-no}$	RF ambient conditions-noise	3.00	3.00	R	$\sqrt{3}$	1.00	1.00	1.73	1.73	$\infty$
11	$U_{A-ref}$	RF ambient conditions-reflections	3.00	3.00	R	$\sqrt{3}$	1.00	1.00	1.73	1.73	$\infty$
12	$U_{PR-pos}$	Probe positioner mech. Restrictions	0.40	0.40	R	$\sqrt{3}$	1.00	1.00	0.23	0.23	$\infty$
13	$U_{PR-pos}$	Probe positioning with respect to phantom shell	2.90	2.90	R	$\sqrt{3}$	1.00	1.00	1.67	1.67	$\infty$
14	$U_{PP-max}$	Post-processing(for max. SAR evaluation)	2.00	2.00	R	$\sqrt{3}$	1.00	1.00	1.15	1.15	$\infty$
15	$U_{DH}$	Device Holder Uncertainty	3.60	3.60	N	1.00	1.00	1.00	3.60	3.60	5.00
16	$U_{PO-pos}$	Test sample positioning	3.72	2.85	N	1.00	1.00	1.00	3.72	2.85	9.00
17	$U_{PS}$	Power scaling	0.00	0.00	R	$\sqrt{3}$	1.00	1.00	0.00	0.00	$\infty$
18	$U_{PD}$	Drift of output power(measured SAR drift)	5.00	5.00	R	$\sqrt{3}$	1.00	1.00	2.89	2.89	$\infty$
19	$U_{PU}$	Phantom Uncertainty	6.10	6.10	R	$\sqrt{3}$	1.00	1.00	3.52	3.52	$\infty$
20	$U_{CS-cor}$	Algorithm for correcting SAR for deviations in permittivity and conductivity	1.90	1.90	N	1.00	1.00	0.84	1.90	1.60	$\infty$
21	$U_{EC-\sigma$	Liquid Conductivity (meas.)	2.42	2.42	N	1.00	0.78	0.71	1.89	1.72	5.00
22	$U_{EP-\epsilon$	Liquid Permittivity (meas.)	2.60	2.60	N	1.00	0.23	0.26	0.60	0.68	5.00
23	$U_{EC-\sigma$	Liquid conductivity(temperature uncertainty)	4.16	4.16	R	$\sqrt{3}$	0.78	0.71	1.87	1.71	$\infty$
24	$U_{EP-\epsilon$	Liquid permittivity(temperature uncertainty)	0.84	0.84	R	$\sqrt{3}$	0.23	0.26	0.11	0.13	$\infty$
<b><math>U_c(sar)</math> Combined standard uncertainty (%)</b>									<b>10.72</b>	<b>10.34</b>	<b>237</b>
<b>Extended uncertainty <math>U</math>(%)</b>									<b>21.44</b>	<b>20.69</b>	

### Uncertainty of SAR equipment for measurement Body 3 GHz to 6 GHz

No.		Error Description	Uncertainty Value (1 g) (%)	Uncertainty Value (10 g) (%)	Probe Dist.	Div.	C <sub>i</sub> (1 g)	C <sub>i</sub> (10 g)	U <sub>i</sub> (1g)	U <sub>i</sub> (10g)	V <sub>i</sub> or V <sub>eff</sub>
1	U(PR <sub>c</sub> )	Probe Calibration	6.30	6.30	N	1.00	1.00	1.00	6.30	6.30	∞
2	U(PR <sub>i</sub> )	Isotropy	1.87	1.87	R	√3	1.00	1.00	1.08	1.08	∞
3	U(L)	Linearity	0.60	0.60	R	√3	1.00	1.00	0.35	0.35	∞
4	U(PR <sub>mr</sub> )	Probe modulation response	2.40	2.40	R	√3	1.00	1.00	1.39	1.39	∞
6	U(DL)	Detection Limits	1.00	1.00	R	√3	1.00	1.00	0.58	0.58	∞
5	U(BE)	Boundary effect	2.00	2.00	R	√3	1.00	1.00	1.15	1.15	∞
7	U(RE)	Readout Electronics	0.30	0.30	N	1.00	1.00	1.00	0.30	0.30	∞
8	U(T <sub>sr</sub> )	Response Time	0.80	0.80	R	√3	1.00	1.00	0.46	0.46	∞
9	U(T <sub>in</sub> )	Integration Time	2.60	2.60	R	√3	1.00	1.00	1.50	1.50	∞
10	U(A <sub>nr</sub> )	RF ambient conditions-noise	3.00	3.00	R	√3	1.00	1.00	1.73	1.73	∞
11	U(A <sub>rr</sub> )	RF ambient conditions-reflections	3.00	3.00	R	√3	1.00	1.00	1.73	1.73	∞
12	U(PR <sub>rr</sub> )	Probe positioner mech. Restrictions	0.80	0.80	R	√3	1.00	1.00	0.46	0.46	∞
13	U(PR <sub>rr</sub> )	Probe positioning with respect to phantom shell	6.70	6.70	R	√3	1.00	1.00	3.87	3.87	∞
14	U(PP <sub>arr</sub> )	Post-processing(for max. SAR evaluation)	4.00	4.00	R	√3	1.00	1.00	2.31	2.31	∞
15	U(DU)	Device Holder Uncertainty	3.60	3.60	N	1.00	1.00	1.00	3.60	3.60	5.00
16	U(PO <sub>arr</sub> )	Test sample positioning	3.47	2.70	N	1.00	1.00	1.00	3.47	2.70	9.00
17	U(PS)	Power scaling	0.00	0.00	R	√3	1.00	1.00	0.00	0.00	∞
18	U(PD)	Drift of output power(measured SAR drift)	5.00	5.00	R	√3	1.00	1.00	2.89	2.89	∞
19	U(PL)	Phantom Uncertainty	6.60	6.60	R	√3	1.00	1.00	3.81	3.81	∞
20	U(CS <sub>arr</sub> )	Algorithm for correcting SAR for deviations in permittivity and conductivity	1.90	1.90	N	1.00	1.00	0.84	1.90	1.60	∞
21	U(C <sub>lc</sub> )	Liquid Conductivity (meas.)	1.58	1.58	N	1.00	0.78	0.71	1.23	1.12	5.00
22	U(C <sub>lp</sub> )	Liquid Permittivity (meas.)	1.64	1.64	N	1.00	0.23	0.26	0.38	0.43	5.00
23	U(C <sub>tr</sub> )	Liquid conductivity(temperature uncertainty)	2.12	2.12	R	√3	0.78	0.71	0.95	0.87	∞
24	U(L <sub>tr</sub> )	Liquid permittivity(temperature uncertainty)	0.40	0.40	R	√3	0.23	0.26	0.05	0.06	∞
U <sub>c</sub> (sar) Combined standard uncertainty (%)									11.30	11.02	327
Extended uncertainty U(%)									22.60	22.04	

## 5. ANSI/IEEE C95.1-2005 RF EXPOSURE LIMIT

In order for users to be aware of the body-worn operating requirements for meeting RF exposure compliance, operating instructions and cautions statements are included in the user's manual.

### 5.1 Uncontrolled Environment

Uncontrolled Environments are defined as locations where there is the exposure of individuals who have no knowledge or control of their exposure. The general population/uncontrolled exposure limits are applicable to situations in which the general public may be exposed or in which persons who are exposed as a consequence of their employment may not be made fully aware of the potential for exposure or cannot exercise control over their exposure. Members of the general public would come under this category when exposure is not employment-related; for example, in the case of a wireless transmitter that exposes persons in its vicinity.

### 5.2 Controlled Environment

Controlled Environments are defined as locations where there is exposure that may be incurred by persons who are aware of the potential for exposure, (i.e. as a result of employment or occupation). In general, occupational/controlled exposure limits are applicable to situations in which persons are exposed as a consequence of their employment, who have been made fully aware of the potential for exposure and can exercise control over their exposure. This exposure category is also applicable when the exposure is of a transient nature due to incidental passage through a location where the exposure levels may be higher than the general population/uncontrolled limits, but the exposed person is fully aware of the potential for exposure and can exercise control over his or her exposure by leaving the area or by some other appropriate means.

**Human Exposure Limits**

	UNCONTROLLED ENVIRONMENT General Population (W/kg) or (mW/g)	CONTROLLED ENVIROMENT Professional Population (W/kg) or (mW/g)
SPATIAL PEAK SAR <sup>1</sup> Brain	1.60	8.00
SPATIAL AVERAGE SAR <sup>2</sup> Whole Body	0.08	0.40
SPATIAL PEAK SAR <sup>3</sup> Hands, Feet, Ankles, Wrists	4.00	20.00

<sup>1</sup> The Spatial Peak value of the SAR averaged over any 1 gram of tissue (defined as a tissue volume in the shape of a cube) and over the appropriate averaging time.  
<sup>2</sup> The Spatial Average value of the SAR averaged over the whole body.  
<sup>3</sup> The Spatial Peak value of the SAR averaged over any 10 grams of tissue (defined as a tissue volume in the shape of a cube) and over the appropriate averaging time.

## 6. SYSTEM AND LIQUID VERIFICATION

### 6.1 System Verification setup

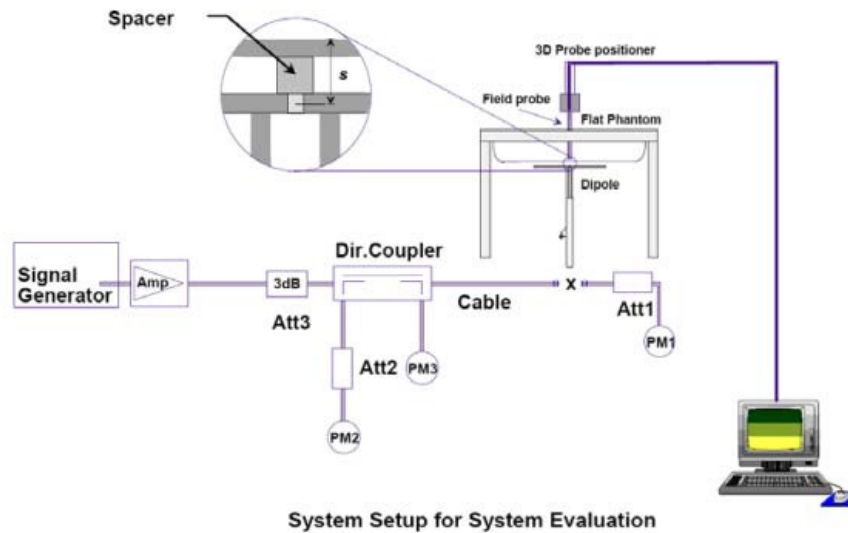

The system performance check verifies that the system operates within its specifications. System and operator errors can be detected and corrected. It is recommended that the system performance check be performed prior to any usage of the system in order to guarantee reproducible results. The system performance check uses normal SAR measurements in a simplified setup with a well characterized source. This setup was selected to give a high sensitivity to all parameters that might fail or vary over time. The system check does not intend to replace the calibration of the components, but indicates situations where the system uncertainty is exceeded due to drift or failure.

In the simplified setup for system evaluation, the DUT is replaced by a calibrated dipole and the power source is replaced by a continuous wave that comes from a signal generator. The calibrated dipole must be placed beneath the flat phantom section of the SAM twin phantom with the correct distance holder. The distance holder should touch the phantom surface with a light pressure at the reference marking and be oriented parallel to the long side of the phantom. The equipment setup is shown below:

1. Signal Generator
2. Amplifier
3. Directional Coupler
4. Power Meter
5. Calibrated Dipole

The output power on dipole port must be calibrated to 30 dBm (1000 mW) before dipole is connected.

**Numerical reference SAR values (W/kg) for reference dipole and flat phantom**

1	2	3	4	5	6
Frequency MHz	Phantom shell thickness mm	1 g SAR W/kg	10 g SAR W/kg	Local SAR at surface (above feedpoint) W/kg	Local SAR at surface (y = 2 cm offset from feedpoint) W/kg
300	6.3	3.02	2.04	4.40	2.10
300	2.0	2.85	1.94	4.14	2.00
450	6.3	4.92	3.28	7.20	3.20
450	2.0	4.58	3.05	6.75	2.98
750	2.0	8.49	5.85	12.6	4.59
835	2.0	9.56	6.22	14.1	4.90
900	2.0	10.9	6.99	16.4	5.40
1 450	2.0	29.0	16.0	50.2	6.90
1 800	2.0	38.4	20.1	69.5	6.80
1 900	2.0	39.7	20.5	72.1	6.60
1 950	2.0	40.5	20.9	72.7	6.60
2 000	2.0	41.1	21.1	74.6	6.50
2 450	2.0	52.4	24.0	104	7.70
2 585	2.0	55.9	24.4	119	7.90
2 600	2.0	55.3	24.6	113	8.29
3 000	2.0	63.8	25.7	140	9.50
3 500	2.0	67.1	25.0	169	12.1
3 700	2.0	67.4	24.2	178	12.7
5 000	2.0	77.9	22.1	305	15.1
5 200	2.0	76.5	21.6	310	15.9
5 500	2.0	83.3	23.4	349	18.1
5 800	2.0	78.0	21.9	341	20.3

## 6.2 Liquid Validation

The dielectric parameters were checked prior to assessment using the DAK dielectric probe kit. The dielectric parameters measured are reported in each correspondent section.

## 6.3 Recommended Tissue Dielectric Parameters

The head and body tissue dielectric parameters recommended by KDB865664 have been incorporated in the following table.

Target Frequency (MHz)	Head		Body	
	$\epsilon_r$	$\sigma$ (S/m)	$\epsilon_r$	$\sigma$ (S/m)
150	52.3	0.76	61.9	0.80
300	45.3	0.87	58.2	0.92
450	43.5	0.87	56.7	0.94
835	41.5	0.90	55.2	0.97
900	41.5	0.97	55.0	1.05
915	41.5	0.98	55.0	1.06
1450	40.5	1.20	54.0	1.30
1610	40.3	1.29	53.8	1.40
1800 – 2000	40.0	1.40	53.3	1.52
2450	39.2	1.80	52.7	1.95
3000	38.5	2.40	52.0	2.73
5800	35.3	5.27	48.2	6.00

( $\epsilon_r$  = relative permittivity,  $\sigma$  = conductivity and  $\rho = 1000 \text{ kg/m}^3$ )

## 6.4 Liquid Confirmation Results

### 6.4.1 System Verification

Frequency (MHz)	Tissue Type	Liquid Temp.(°C)	Parameter	Target Value	Measured Value	Deviation	Limit (%)	Date
835	Body	22.0	Permittivity	55.20	55.70	0.91%	± 5	03/30/2016
			Conductivity	0.97	0.95	-1.96%	± 5	
1 950	Body	20.8	Permittivity	53.32	53.70	0.70%	± 5	03/29/2016
			Conductivity	1.51	1.58	4.61%	± 5	
2 450	Body	21.5	Permittivity	52.70	53.10	0.76%	± 5	03/31/2016
			Conductivity	1.95	1.97	1.03%	± 5	
5 300	Body	21.0	Permittivity	48.90	47.20	-3.47%	± 5	04/11/2016
			Conductivity	5.46	5.41	-1.00%	± 5	
5 600	Body	21.0	Permittivity	48.48	46.40	-4.29%	± 5	04/11/2016
			Conductivity	5.79	5.87	1.40%	± 5	
5 800	Body	21.4	Permittivity	48.20	45.90	-4.77%	± 5	04/12/2016
			Conductivity	6.00	6.23	3.83%	± 5	

## 6.5 System Verification Results

Freq. (MHz)	Tissue Type	Amb. Temp (°C)	Liquid Temp (°C)	Input Power (mW)	Dipole S/N	Probe S/N	Measured SAR 1g	1W Normalized SAR 1g	1W Target SAR 1g	Deviation	Date
835	Body	22.4	22.0	250	4d172	3171	2.48	9.9	9.58	3.55%	03/30/2016
1 950	Body	21.1	20.8	250	1156	3171	9.87	39.5	39.1	0.97%	03/29/2016
2 450	Body	21.8	21.5	250	1094	3666	13.5	54.0	52.3	3.25%	03/31/2016
5 300	Body	21.4	21.0	250	1094	3666	18.3	73.2	76.0	-3.68%	04/11/2016
5 600	Body	21.4	21.0	250	1094	3666	21.0	84.0	81.2	3.45%	04/11/2016
5 800	Body	21.8	21.4	250	1094	3666	19.2	76.8	77.5	-0.90%	04/12/2016



## 7. SAR MEASUREMENT PROCEDURES

### Step 1: Power Reference Measurement

The Power Reference Measurement and Power Drift Measurements are for monitoring the power drift of the device under test in the batch process. The Minimum distance of probe sensors to surface determines the closest measurement point to phantom surface. The minimum distance of probe sensors to surface is 2 mm. This distance cannot be smaller than the Distance of sensor calibration points to probe tip as defined in the probe properties.

### Step 2: Area Scan

The Area Scan is used as a fast scan in two dimensions to find the area of high field values, before doing a fine measurement around the hot spot. The sophisticated interpolation routines implemented in DASYS software can find the maximum locations even in relatively coarse grids. When an Area Scan has measured all reachable points, it computes the field maximal found in the scanned area, within a range of the global maximum. The range (in dB) is specified in the standards for compliance testing.

For example, a 2 dB range is required in IEEE Standard 1528 and IEC 62209 standards, whereby 3 dB is a requirement when compliance is assessed in accordance with the ARIB standard (Japan). If only one Zoom Scan follows the Area Scan, then only the absolute maximum will be taken as reference. For cases where multiple maximums are detected, the number of Zoom Scans has to be increased accordingly.

### Step 3: Zoom Scan

Zoom Scans are used to assess the peak spatial SAR values within a cubic averaging volume containing 1 g and 10 g of simulated tissue. The Zoom Scan measures 5x5x7 points within a cube whose base faces are centered on the maxima found in a preceding area scan job within the same procedure. When the measurement is done, the Zoom Scan evaluates the averaged SAR for 1 g and 10 g and displays these values next to the job's label.

### Step 4: Power drift measurement

The Power Drift Measurement measures the field at the same location as the most recent power reference measurement within the same procedure, and with the same settings. The Power Drift Measurement gives the field difference in dB from the reading conducted within the last Power Reference Measurement. This allows a user to monitor the power drift of the device under test within a batch process. The measurement procedure is the same as Step 1.

### Step 5: Z-Scan

The Z Scan measures points along a vertical straight line. The line runs along the Z-axis of a one dimensional grid. In order to get a reasonable extrapolation, the extrapolated distance should not be larger than the step size in Z-direction.

\* Z Scan Report on Liquid Measure the height ANNEX C. Liquid Depth photo to replace

		$\leq 3$ GHz	$> 3$ GHz
Maximum distance from closest measurement point (geometric center of probe sensors) to phantom surface		$5 \pm 1$ mm	$\frac{1}{2} \cdot \delta \cdot \ln(2) \pm 0.5$ mm
Maximum probe angle from probe axis to phantom surface normal at the measurement location		$30^\circ \pm 1^\circ$	$20^\circ \pm 1^\circ$
Maximum area scan spatial resolution: $\Delta x_{Area}, \Delta y_{Area}$		$\leq 2$ GHz: $\leq 15$ mm 2 – 3 GHz: $\leq 12$ mm	3 – 4 GHz: $\leq 12$ mm 4 – 6 GHz: $\leq 10$ mm
		When the x or y dimension of the test device, in the measurement plane orientation, is smaller than the above, the measurement resolution must be $\leq$ the corresponding x or y dimension of the test device with at least one measurement point on the test device.	
Maximum zoom scan spatial resolution: $\Delta x_{Zoom}, \Delta y_{Zoom}$		$\leq 2$ GHz: $\leq 8$ mm 2 – 3 GHz: $\leq 5$ mm*	3 – 4 GHz: $\leq 5$ mm* 4 – 6 GHz: $\leq 4$ mm*
Maximum zoom scan spatial resolution, normal to phantom surface	uniform grid: $\Delta z_{Zoom}(n)$	$\leq 5$ mm	3 – 4 GHz: $\leq 4$ mm 4 – 5 GHz: $\leq 3$ mm 5 – 6 GHz: $\leq 2$ mm
	graded grid	$\Delta z_{Zoom}(1)$ : between 1 <sup>st</sup> two points closest to phantom surface	$\leq 4$ mm
		$\Delta z_{Zoom}(n>1)$ : between subsequent points	$\leq 1.5 \cdot \Delta z_{Zoom}(n-1)$
Minimum zoom scan volume	x, y, z	$\geq 30$ mm	3 – 4 GHz: $\geq 28$ mm 4 – 5 GHz: $\geq 25$ mm 5 – 6 GHz: $\geq 22$ mm
<p>Note: <math>\delta</math> is the penetration depth of a plane-wave at normal incidence to the tissue medium; see draft standard IEEE P1528-2011 for details.</p> <p>* When zoom scan is required and the <i>reported</i> SAR from the area scan based <i>I-g SAR estimation</i> procedures of KDB 447498 is <math>\leq 1.4</math> W/kg, <math>\leq 8</math> mm, <math>\leq 7</math> mm and <math>\leq 5</math> mm zoom scan resolution may be applied, respectively, for 2 GHz to 3 GHz, 3 GHz to 4 GHz and 4 GHz to 6 GHz.</p>			

## 8. TEST EQUIPMENT LIST

Manufacturer	Model	Serial No.	CaL.Due	Used
STAUBLI	RX90XL	F07/56X0A1/A/01	N/A	V
STAUBLI	CS8C Speag TX90XL	F07/56X0A1/C/01	N/A	V
SPEAG	SE UMS 011 AA	1019	N/A	V
STAUBLI	RX90BL	F01/5J92A1/A/01	N/A	
STAUBLI	CS7MBsp RX90BL	F01/5J92A1/C/01	N/A	
SPEAG	SE UMS 001 BC	1164	N/A	
STAUBLI	SP1	D 211 421 02	N/A	V
STAUBLI	Manual Control III Operator	D 221 340 01	N/A	
Di-Soric	LB5	80	N/A	V
Di-Soric	LB2	270	N/A	
SPEAG	Twin Phantom	TP-1069	N/A	
SPEAG	Twin Phantom	TP-1086	N/A	
SPEAG	Twin Phantom	TP-1112	N/A	
SPEAG	Twin Phantom	TP-1155	N/A	
SPEAG	ELI4 Phantom	S 000 T01 DA	N/A	V
SPEAG	Triple Phantom	QD 000 P51 CA	N/A	
SPEAG	Mounting Device	N/A	N/A	V
SPEAG	Mounting Device	SM LH1 001 AC	N/A	
Agilent	85033E	N/A	N/A	V
SPEAG	DAE4	444	11/22/2016	V
SPEAG	DAE3	383	03/16/2017	
SPEAG	EX3DV4	3666	05/25/2016	V
SPEAG	ES3DV3	3171	07/20/2016	V
SPEAG	EX3DV4	3716	11/23/2016	
SPEAG	D2450V2	923	11/17/2017	V
SPEAG	D5GHzV2	1094	11/19/2017	V
SPEAG	D835V2	4d172	07/09/2016	V
SPEAG	D1750V2	1122	07/09/2016	
SPEAG	D1950V3	1156	07/10/2016	V
SPEAG	DAK-3.5	1140	11/18/2016	V
HP	8665B	3744A01333	10/07/2016	V
EMPOWER	BBS3Q7ELU-2001	1009D/C0105	10/05/2016	V
VARIAN	VZC6961K11212	6673	10/07/2016	V
HP	778D	12679	10/06/2016	V
Agilent	772D	2839A01119	10/07/2016	V
Agilent	E4419B	MY41291366	10/07/2016	V
HP	437B	3125U25121	04/13/2017	V
HP	8481H	3318A18722	10/06/2016	V
HP	8481H	3318A17600	10/06/2016	V
HP	8481A	1550A14928	10/06/2016	V
WAAINWRIGHT	WLJS1500-6EF	1	10/06/2016	
WAAINWRIGHT	WLJS3000-6EF	1	10/06/2016	
Agilent	E8357A	US41070399	10/07/2016	V
LKM Electronic Gmbh	DTM3000-spezial	3247	10/07/2016	V

EMC-003 (Rev.2)

CAS	TE-201	14011777-2	10/09/2016	
CAS	TE-201	14011777-1	10/07/2016	V
Bird	50-6A-MFN-30	14100882-1	10/06/2016	V
Bird	50-6A-MFN-30	14100882-2	10/06/2016	
ANRITSU	MT8820A	6200270787	08/21/2016	
Agilent	E5515C	GB41450265	10/06/2016	V
Agilent	E5515C	GB44350208	10/06/2016	

## 9. RF CONDUCTED POWER

### 9.1 GSM 850 (Burst-Average)

Mode	TX Channel	128	190	251	Tolerance (dBm)
	Freq. (MHz)	824.2	836.6	848.8	
GPRS	1 Tx	33.45	<b>33.45</b>	33.40	33.0 -1/+0.5
	2 Tx	31.10	31.09	30.97	31.0 -1/+0.5
	3 Tx	29.61	29.58	29.49	30.0 -1/+0.5
	4 Tx	28.18	28.14	28.04	28.0 -1/+0.5

Mode	TX Channel	128	190	251	Tolerance (dBm)
	Freq. (MHz)	824.2	836.6	848.8	
EGPRS	1 Tx	<b>33.40</b>	33.36	33.29	33.0 -1/+0.5
	2 Tx	31.00	31.05	30.88	31.0 -1/+0.5
	3 Tx	29.54	29.52	29.41	30.0 -1/+0.5
	4 Tx	28.08	28.10	28.00	28.0 -1/+0.5

### 9.2 GSM 850 (Frame-Average)

Mode	TX Channel	128	190	251	Tolerance (dBm)
	Freq. (MHz)	824.2	836.6	848.8	
GPRS	1 Tx	24.45	24.45	24.40	24.0 -1/+0.5
	2 Tx	25.10	25.09	24.97	25.0 -1/+0.5
	3 Tx	<b>25.36</b>	25.33	25.24	25.0 -1/+0.5
	4 Tx	25.18	25.14	25.04	25.0 -1/+0.5

Mode	TX Channel	128	190	251	Tolerance (dBm)
	Freq. (MHz)	824.2	836.6	848.8	
EGPRS	1 Tx	24.40	24.36	24.29	24.0 -1/+0.5
	2 Tx	25.00	25.05	24.88	25.0 -1/+0.5
	3 Tx	<b>25.29</b>	25.27	25.16	25.0 -1/+0.5
	4 Tx	25.08	25.10	25.00	25.0 -1/+0.5

### 9.3 GSM 1900 (Burst-Average)

Mode	TX Channel	512	661	810	Tolerance (dBm)
	Freq. (MHz)	1 850.2	1 880.0	1 909.8	
GPRS	1 Tx	30.39	30.28	30.19	30.0 -1/+0.5
	2 Tx	26.90	27.09	27.04	27.0 -1/+0.5
	3 Tx	25.41	25.58	25.48	25.0 -1/+0.5
	4 Tx	23.98	24.15	24.10	24.0 -1/+0.5

Mode	TX Channel	512	661	810	Tolerance (dBm)
	Freq. (MHz)	1 850.2	1 880.0	1 909.8	
EGPRS	1 Tx	30.34	30.25	30.11	30.0 -1/+0.5
	2 Tx	26.82	27.01	27.00	27.0 -1/+0.5
	3 Tx	25.37	25.52	25.41	25.0 -1/+0.5
	4 Tx	23.94	24.11	24.05	24.0 -1/+0.5

### 9.4 GSM 1900 (Frame-Average)

Mode	TX Channel	512	661	810	Tolerance (dBm)
	Freq. (MHz)	1 850.2	1 880.0	1 909.8	
GPRS	1 Tx	21.39	21.28	21.19	21.0 -1/+0.5
	2 Tx	20.90	21.09	21.04	21.0 -1/+0.5
	3 Tx	21.16	21.33	21.23	21.0 -1/+0.5
	4 Tx	20.98	21.15	21.10	21.0 -1/+0.5

Mode	TX Channel	512	661	810	Tolerance (dBm)
	Freq. (MHz)	1 850.2	1 880.0	1 909.8	
EGPRS	1 Tx	21.34	21.25	21.11	21.0 -1/+0.5
	2 Tx	20.82	21.01	21.00	21.0 -1/+0.5
	3 Tx	21.12	21.27	21.16	21.0 -1/+0.5
	4 Tx	20.94	21.11	21.05	21.0 -1/+0.5

### 9.5 WCDMA Band II

Mode	TX Channel	9262	9400	9538	Tolerance (dBm)
	Freq. (MHz)	1 852.4	1 880.0	1 907.6	
WCDMA Band II	RMC	24.33	<b>24.36</b>	24.24	24.0 -1/+0.5
	HSPA	24.30	24.31	24.22	24.0 -1/+0.5

### 9.6 WCDMA Band V

Mode	TX Channel	4132	4183	4233	Tolerance (dBm)
	Freq. (MHz)	826.4	836.6	846.6	
WCDMA Band V	RMC	24.22	<b>24.42</b>	24.28	24.0 -1/+0.5
	HSPA	24.16	24.37	24.23	24.0 -1/+0.5

### 9.7 802.11b

Mode	Freq. (MHz)	CH	Conducted Power (dBm)				Tolerance (dBm)
			Data Rate (Mbps)				
			1	2	5.5	11	
802.11b	2 412	1	<b>15.94</b>	15.92	15.90	15.90	14.0 ± 2
	2 437	6	15.87	15.85	15.82	15.84	
	2 462	11	15.87	15.83	15.80	15.80	

### 9.8 802.11g

Mode	Freq. (MHz)	CH	Conducted Power (dBm)								Tolerance (dBm)
			Data Rate (Mbps)								
			6	9	12	18	24	36	48	54	
802.11g	2 412	1	<b>13.76</b>	13.70	13.72	13.68	13.65	13.60	13.55	13.54	12.0 ± 2
	2 437	6	13.73	13.66	13.62	13.60	13.58	13.53	13.51	13.48	
	2 462	11	13.70	13.64	13.58	13.54	13.51	13.46	13.44	13.38	

### 9.9 802.11n HT20

Mode	Freq. (MHz)	CH	Conducted Power (dBm)								Tolerance (dBm)
			Data Rate (Mbps)								
			MCS0	MCS1	MCS2	MCS3	MCS4	MCS5	MCS6	MCS7	
802.11n HT20	2 412	1	<b>12.77</b>	12.71	12.70	12.70	12.66	12.65	12.61	12.58	11.0 ± 2
	2 437	6	12.70	12.65	12.60	12.58	12.55	12.52	12.47	12.42	
	2 462	11	12.73	12.70	12.64	12.62	12.57	12.55	12.50	12.46	

9.10 802.11a

Mode	Freq. (MHz)	CH	Conducted Power (dBm)								Tolerance (dBm)
			Data Rate (Mbps)								
			6	9	12	18	24	36	48	54	
U-NII 1	5 180	36	13.27	13.20	13.19	13.16	13.14	13.11	13.11	13.08	11.5 ± 2
	5 200	40	13.31	13.28	13.25	13.25	13.22	13.20	13.17	13.13	
	5 220	44	13.29	13.28	13.24	13.23	13.20	13.18	13.13	13.10	
	5 240	48	13.21	13.20	13.14	13.11	13.06	13.06	13.05	13.00	
U-NII 2A	5 260	52	13.33	13.29	13.26	13.25	13.24	13.20	13.18	13.14	
	5 280	56	13.30	13.27	13.24	13.20	13.21	13.18	13.15	13.14	
	5 300	60	13.46	13.44	13.42	13.43	13.38	13.35	13.33	13.30	
	5 320	64	13.41	13.37	13.35	13.30	13.27	13.25	13.22	13.21	
U-NII 2C	5 500	100	13.26	13.24	13.25	13.23	13.22	13.21	13.19	13.17	
	5 520	104	13.23	13.20	13.17	13.15	13.11	13.09	13.05	13.00	
	5 540	108	13.28	13.25	13.21	13.20	13.17	13.15	13.11	13.10	
	5 560	112	13.35	13.33	13.31	13.30	13.28	13.27	13.24	13.20	
	5 580	116	13.21	13.20	13.17	13.16	13.14	13.11	13.10	13.07	
	5 600	120	13.23	13.21	13.17	13.16	13.17	13.13	13.10	13.05	
	5 620	124	13.16	13.11	13.12	13.09	13.08	13.04	13.03	13.00	
	5 640	128	13.10	13.08	13.04	13.03	13.00	12.99	12.97	12.92	
	5 660	132	13.08	13.05	13.01	13.00	12.97	12.94	12.90	12.88	
	5 680	136	13.00	12.96	12.95	12.91	12.90	12.86	12.84	12.82	
5 700	140	12.99	12.97	12.93	12.90	12.89	12.85	12.82	12.81		
U-NII 3	5 745	149	14.42	14.35	14.35	14.33	14.32	14.30	14.28	14.26	12.5 ± 2
	5 765	153	14.35	14.31	14.31	14.28	14.26	14.22	14.21	14.18	
	5 785	157	14.36	14.35	14.32	14.29	14.28	14.29	14.25	14.22	
	5 805	161	14.31	14.30	14.27	14.27	14.25	14.21	14.18	14.17	
	5 825	165	14.39	14.37	14.33	14.31	14.30	14.28	14.26	14.22	



**9.11 802.11a HT20**

Mode	Freq. (MHz)	CH	Conducted Power (dBm)								Tolerance (dBm)
			Data Rate (Mbps)								
			MCS0	MCS1	MCS2	MCS3	MCS4	MCS5	MCS6	MCS7	
U-NII 1	5 180	36	13.20	13.11	12.96	12.76	12.50	12.16	12.00	11.85	11.5 ± 2
	5 200	40	13.25	13.20	13.08	12.82	12.56	12.23	12.07	11.90	
	5 220	44	13.21	13.14	13.10	12.88	12.52	12.16	12.05	11.88	
	5 240	48	13.15	13.07	13.00	12.81	12.42	12.07	11.99	11.77	
U-NII 2A	5 260	52	13.12	13.01	12.91	12.74	12.33	12.03	11.89	11.74	
	5 280	56	12.93	12.80	12.72	12.66	12.25	11.95	11.82	11.69	
	5 300	60	12.78	12.66	12.58	12.46	12.08	11.79	11.68	11.50	
	5 320	64	12.72	12.60	12.52	12.39	11.89	11.69	11.55	11.37	
U-NII 2C	5 500	100	13.33	13.20	13.08	12.80	12.59	12.28	12.06	12.02	
	5 520	104	13.31	13.15	13.03	12.77	12.59	12.22	12.02	11.99	
	5 540	108	13.30	13.11	13.05	12.77	12.55	12.20	12.00	11.95	
	5 560	112	13.32	13.14	13.05	12.74	12.52	12.23	11.99	11.92	
	5 580	116	13.28	13.10	13.02	12.70	12.46	12.19	11.94	11.85	
	5 600	120	13.22	13.05	12.97	12.67	12.41	12.11	11.89	11.79	
	5 620	124	13.20	13.01	12.92	12.65	12.40	12.07	11.84	11.77	
	5 640	128	13.16	12.99	12.89	12.60	12.42	12.05	11.82	11.73	
	5 660	132	13.07	12.90	12.78	12.55	12.34	11.97	11.74	11.66	
	5 680	136	12.99	12.81	12.72	12.49	12.25	11.87	11.70	11.58	
U-NII 3	5 700	140	12.95	12.77	12.65	12.42	12.20	11.80	11.76	11.54	
	5 745	149	14.40	14.29	14.08	13.91	13.58	13.37	13.20	13.10	
	5 765	153	14.38	14.30	14.04	13.93	13.55	13.31	13.18	13.11	
	5 785	157	14.36	14.25	14.02	13.88	13.50	13.27	13.13	13.05	
	5 805	161	14.34	14.24	14.02	13.85	13.47	13.25	13.08	13.00	
	5 825	165	14.33	14.21	13.99	13.81	13.45	13.22	13.04	12.97	12.5 ± 2

**Note :**

- Per KDB 248227 D01v02r02, SAR test reduction is determined according to 802.11 transmission mode configuration and certain exposure conditions with multiple test positions. In the 2.4 GHz band, separate SAR procedures are applied to DSS and OFDM configurations to simplify DSSS test requirements. For OFDM, in both 2.4 and 5 GHz bands, an initial test configuration must be determined for each standalone and aggregated frequency band, according to the transmission mode configuration with the highest maximum output power specified for production units to perform SAR measurements.

If the same highest maximum output power applies to different combinations of channel bandwidths, modulations and data rates, additional procedures are applied to determine which test configurations require SAR measurement. When applicable, an initial test position may be applied to reduce the number of SAR measurements required for next to the ear, UMPC mini-tablet or hotspot mode configurations with multiple test positions.

2. For 2.4 GHz 802.11b DSSS, either the initial test position procedure for multiple exposure test positions or the DSSS procedure for fixed exposure position is applied; these are mutually exclusive. For 2.4 GHz and 5 GHz OFDM configurations, the initial test configuration is applied to measure SAR using either the initial test position procedure for multiple exposure test position configurations or the initial test configuration procedures for fixed exposure test conditions. Based on the reported SAR of the measured configurations and maximum output power of the transmission mode configurations that are not included in the initial test configuration, the subsequent test configuration and initial test position procedures are applied to determine if SASR measurements are required for the remaining OFDM transmission configurations. In general, the number of test channels that require SAR measurement is minimized based on maximum output power measured for the test sample(s).
3. For OFDM transmission configurations in the 2.4 GHz and 5 GHz bands, When the same maximum power is specified for multiple transmission mode in a frequency band, the largest channel bandwidth, lowest order modulation, lowest data rate and lowest order 802.11a/g/n/ac mode is used for SAR measurement, on the highest measured output power channel for each frequency band.
4. DSS and OFDM configurations are considered separately according to the required SAR procedures. SAR is measured in the initial test position using the 802.11 transmission mode configuration required by the DSSS procedure or initial test configuration and subsequent test configuration(s) according to the OFDM procedures.

The initial test position procedure is described in the following:

- a. When the reported SAR of the initial test position is  $\leq 0.4$  W/kg, further SAR measurement is not required for the other test positions in that exposure configuration and 802.11 transmission mode combinations within the frequency band or aggregated band.
- b. When the reported SAR of the test position is  $> 0.4$  W/kg, SAR is repeated for the 802.11 transmission mode configuration test in the initial test position to measure the subsequent next closet/smallest test separation distance and maximum coupling test position on the highest maximum output power channel, until the report SAR is  $\leq 0.8$  W/kg or all required test position are tested.
- c. For all positions/configurations, when the reported SAR is  $>0.8$ , SAR is measured for these test positions/configurations on the subsequent next highest measured output power channel(s) until the reported SAR is  $\leq 1.2$  W/kg or all channels are tested.

### 9.13 Bluetooth

#### BDR

Mode	Freq. (MHz)	CH	DH1	DH3	DH5
BDR (1M)	2402	0	-3.22	-1.23	-0.95
	2441	39	-2.46	-0.67	<b>-0.41</b>
	2480	78	-2.37	-0.66	-0.42

#### EDR

Mode	Freq. (MHz)	CH	DH1	DH3	DH5
EDR (2M)	2402	0	-5.12	-3.25	-1.23
	2441	39	-4.38	-2.77	-0.88
	2480	78	-4.27	-2.74	<b>-0.87</b>
EDR (3M)	2402	0	-4.15	-2.97	-0.89
	2441	39	-3.56	-2.24	-0.48
	2480	78	-3.43	-2.21	<b>-0.44</b>

#### BLE

Mode	Freq. (MHz)	CH	DH1	DH3	DH5
BLE	2402	0	3.98	5.87	7.41
	2441	39	4.35	6.21	<b>7.98</b>
	2480	78	4.12	6.11	7.85

## 10.SAR TEST RESULTS

### < GSM 850 Body SAR >

Mode	Position	Freq. (MHz)	CH	Conducted Power (dBm)	Max Allowed Power (dBm)	Scaling Factor	Measured 1g SAR (W/kg)	Reported SAR (W/kg)
GPRS	Back	824.2	128	33.45	33.50	1.01	0.095	<b>0.096</b>
		836.6	190	33.45	33.50	1.01	0.090	0.091
		848.8	251	33.40	33.50	1.02	0.084	0.086
	Front	836.6	190	33.45	33.50	1.01	0.049	0.050
	Top	836.6	190	33.45	33.50	1.01	0.025	0.025
	Right	836.6	190	33.45	33.50	1.01	0.003	0.003

### < GSM 1900 Body SAR >

Mode	Position	Freq. (MHz)	CH	Conducted Power (dBm)	Max Allowed Power (dBm)	Scaling Factor	Measured 1g SAR (W/kg)	Reported SAR (W/kg)
GPRS	Back	1 850.2	512	30.39	30.50	1.03	0.362	0.371
		1 880.0	661	30.28	30.50	1.05	0.401	0.422
		1 909.8	810	30.19	30.50	1.07	0.429	<b>0.461</b>
	Front	1 880.0	661	30.28	30.50	1.05	0.027	0.028
	Top	1 880.0	661	30.28	30.50	1.05	0.011	0.012
	Right	1 880.0	661	30.28	30.50	1.05	0.009	0.009

### < WCDMA Band II Body SAR >

Mode	Position	Freq. (MHz)	CH	Conducted Power (dBm)	Max Allowed Power (dBm)	Scaling Factor	Measured 1g SAR (W/kg)	Reported SAR (W/kg)
RMC	Back	1 852.4	9262	24.33	24.50	1.04	1.040	1.082
		1 880.0	9400	24.36	24.50	1.03	1.320	<b>1.363</b>
		1 907.6	9538	24.24	24.50	1.06	1.240	1.317
	Front	1 880.0	9400	24.36	24.50	1.03	0.086	0.089
	Top	1 880.0	9400	24.36	24.50	1.03	0.034	0.035
	Right	1 880.0	9400	24.36	24.50	1.03	0.041	0.042
Repeated	Back	1 880.0	9400	24.36	24.50	1.03	1.300	1.343

< WCDMA Band V Body SAR >

Mode	Position	Freq. (MHz)	CH	Conducted Power (dBm)	Max Allowed Power (dBm)	Scaling Factor	Measured 1g SAR (W/kg)	Reported SAR (W/kg)
RMC	Back	826.4	4132	24.22	24.50	1.07	0.115	<b>0.123</b>
		836.6	4183	24.42	24.50	1.02	0.098	0.100
		846.6	4233	24.28	24.50	1.05	0.088	0.093
	Front	836.6	4183	24.42	24.50	1.02	0.059	0.060
	Top	836.6	4183	24.42	24.50	1.02	0.028	0.029
	Right	836.6	4183	24.42	24.50	1.02	0.004	0.004

< 802.11b Body SAR >

Mode	Position	Freq. (MHz)	CH	Conducted Power (dBm)	Max Allowed Power (dBm)	Scaling Factor	Measured 1g SAR (W/kg)	Reported SAR (W/kg)
802.11b	Back	2 412	1	15.78	16.00	1.05	0.893	<b>0.939</b>
		2 437	6	15.87	16.00	1.03	0.838	0.863
		2 462	11	15.84	16.00	1.04	0.875	0.908
	Front	2 437	6	15.87	16.00	1.03	0.056	0.058
	Top	2 437	6	15.87	16.00	1.03	0.136	0.140
Repeated	Front	2 412	1	15.78	16.00	1.05	0.895	0.942

< 802.11a Body SAR >

Mode	Position	Freq. (MHz)	CH	Conducted Power (dBm)	Max Allowed Power (dBm)	Scaling Factor	Measured 1g SAR (W/kg)	Reported SAR (W/Kg)
U-NII 2A	Back	5 300	60	13.46	13.50	1.01	0.837	0.845
		5 320	64	13.38	13.50	1.03	0.795	0.817
	Front	5 300	60	13.46	13.50	1.01	0.215	0.217
	Top	5 300	60	13.46	13.50	1.01	0.187	0.189
Repeated	Back	5 300	60	13.46	13.50	1.01	0.858	<b>0.866</b>
U-NII 2C	Back	5 560	112	13.30	13.50	1.05	0.757	<b>0.793</b>
	Front	5 560	112	13.30	13.50	1.05	0.120	0.126
	Top	5 560	112	13.30	13.50	1.05	0.147	0.154
U-NII 3	Back	5 825	165	14.39	14.50	1.03	0.771	<b>0.791</b>
	Front	5 825	165	14.39	14.50	1.03	0.110	0.113
	Top	5 825	165	14.39	14.50	1.03	0.108	0.111

## ANNEX A. SYSTEM VERIFICATION PLOTS

< 835 MHz Body / Date : Mar 30, 2016 >

DUT: Dipole 835 MHz; Type: D835V2; Serial: D835V2 - SN:4d172

Communication System: CW; Frequency: 835 MHz; Duty Cycle: 1:1

Medium parameters used:  $f = 835 \text{ MHz}$ ;  $\sigma = 0.951 \text{ mho/m}$ ;  $\epsilon_r = 55.7$ ;  $\rho = 1000 \text{ kg/m}^3$

Phantom section: Flat Section

DASY5 Configuration:

- Probe: ES3DV3 - SN3171; ConvF(5.97, 5.97, 5.97); Calibrated: 2015-07-21
- Sensor-Surface: 3mm (Mechanical Surface Detection)
- Electronics: DAE4 Sn444; Calibrated: 2015-11-23
- Phantom: ELI 4.0; Type: QDOVA001BA; Serial: 1030
- Measurement SW: DASY5, V5.0 Build 125; SEMCAD X Version 13.4 Build 125

835 MHz SPC/Area Scan (71x101x1): Measurement grid:  $dx=12\text{mm}$ ,  $dy=12\text{mm}$

Maximum value of SAR (interpolated) = 2.86 mW/g

835 MHz SPC/Zoom Scan (7x7x7)/Cube 0: Measurement grid:  $dx=5\text{mm}$ ,  $dy=5\text{mm}$ ,  $dz=5\text{mm}$

Reference Value = 56.6 V/m; Power Drift = 0.018 dB

Peak SAR (extrapolated) = 3.6 W/kg

SAR(1 g) = 2.48 mW/g; SAR(10 g) = 1.66 mW/g

Maximum value of SAR (measured) = 2.88 mW/g

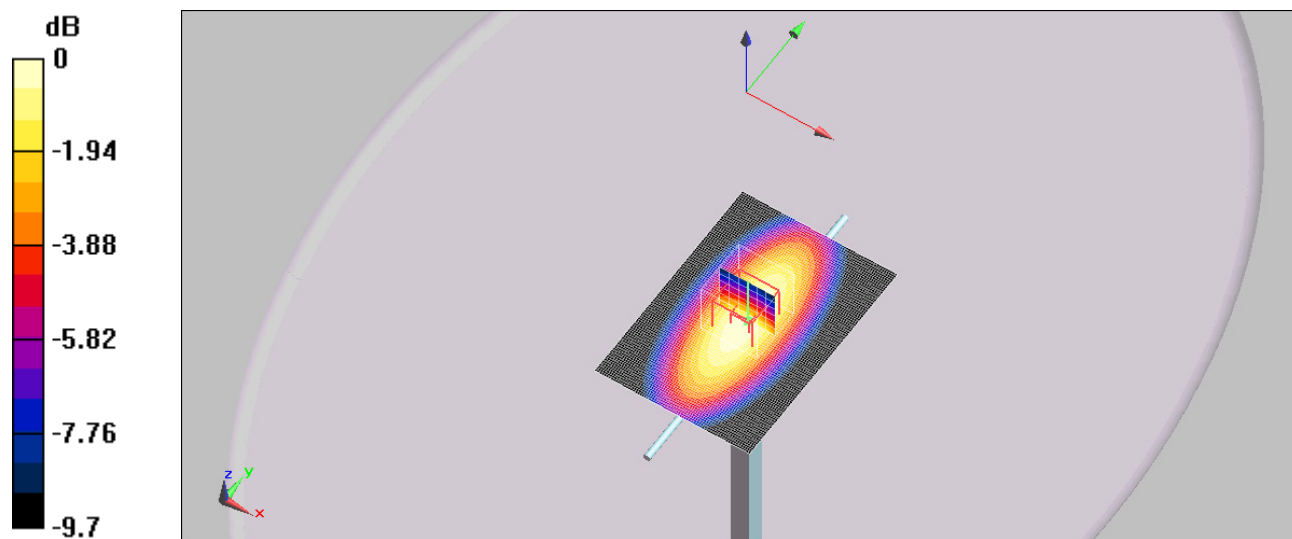

0 dB = 2.88mW/g

< 1 950 MHz Body / Date : Mar 29, 2016 >

DUT: Dipole 1950 MHz; Type: D1950V3; Serial: D1950V3 - SN:1156

Communication System: CW; Frequency: 1950 MHz; Duty Cycle: 1:1

Medium parameters used:  $f = 1950$  MHz;  $\sigma = 1.58$  mho/m;  $\epsilon_r = 53.7$ ;  $\rho = 1000$  kg/m<sup>3</sup>

Phantom section: Flat Section

**DASY5 Configuration:**

- Probe: ES3DV3 - SN3171; ConvF(4.84, 4.84, 4.84); Calibrated: 2015-07-21
- Sensor-Surface: 3mm (Mechanical Surface Detection)
- Electronics: DAE4 Sn444; Calibrated: 2015-11-23
- Phantom: ELI 4.0; Type: QDOVA001BA; Serial: 1030
- Measurement SW: DASY5, V5.0 Build 125; SEMCAD X Version 13.4 Build 125

1 950 MHz SPC/Area Scan (71x101x1): Measurement grid: dx=12mm, dy=12mm

Maximum value of SAR (interpolated) = 12.9 mW/g

1 950 MHz SPC/Zoom Scan (7x7x7)/Cube 0: Measurement grid: dx=5mm, dy=5mm, dz=5mm

Reference Value = 92.5 V/m; Power Drift = 0.036 dB

Peak SAR (extrapolated) = 17.7 W/kg

SAR(1 g) = 9.87 mW/g; SAR(10 g) = 5.17 mW/g

Maximum value of SAR (measured) = 12.5 mW/g

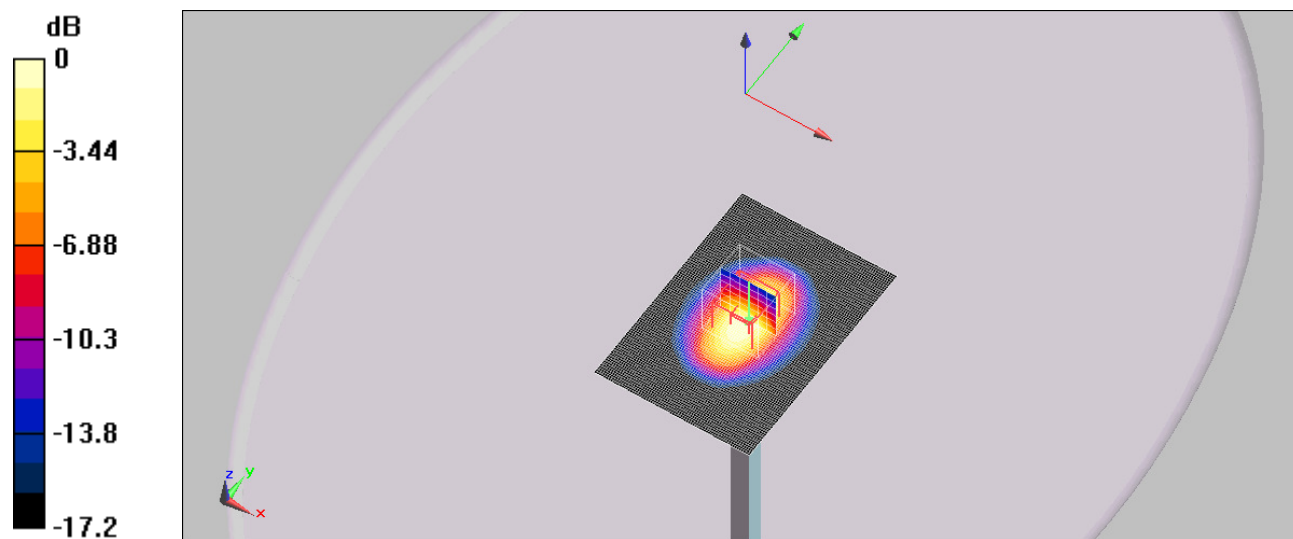

0 dB = 12.5mW/g

< 2 450 MHz Body / Date : Mar 31, 2016 >

DUT: Dipole 2450 MHz; Type: D2450V2; Serial: D2450V2 - SN:923

Communication System: CW; Frequency: 2450 MHz; Duty Cycle: 1:1

Medium parameters used:  $f = 2450$  MHz;  $\sigma = 1.97$  mho/m;  $\epsilon_r = 53.1$ ;  $\rho = 1000$  kg/m<sup>3</sup>

Phantom section: Flat Section

**DASY5 Configuration:**

- Probe: EX3DV4 - SN3666; ConvF(7.76, 7.76, 7.76); Calibrated: 2015-05-26
- Sensor-Surface: 2mm (Mechanical Surface Detection)
- Electronics: DAE4 Sn444; Calibrated: 2015-11-23
- Phantom: ELI 4.0; Type: QDOVA001BA; Serial: 1030
- Measurement SW: DASY5, V5.0 Build 125; SEMCAD X Version 13.4 Build 125

2 450 MHz SPC/Area Scan (71x101x1): Measurement grid: dx=12mm, dy=12mm

Maximum value of SAR (interpolated) = 20.6 mW/g

2 450 MHz SPC/Zoom Scan (7x7x7)/Cube 0: Measurement grid: dx=5mm, dy=5mm, dz=5mm

Reference Value = 99.7 V/m; Power Drift = 0.021 dB

Peak SAR (extrapolated) = 27.3 W/kg

SAR(1 g) = 13.5 mW/g; SAR(10 g) = 6.35 mW/g

Maximum value of SAR (measured) = 20.2 mW/g

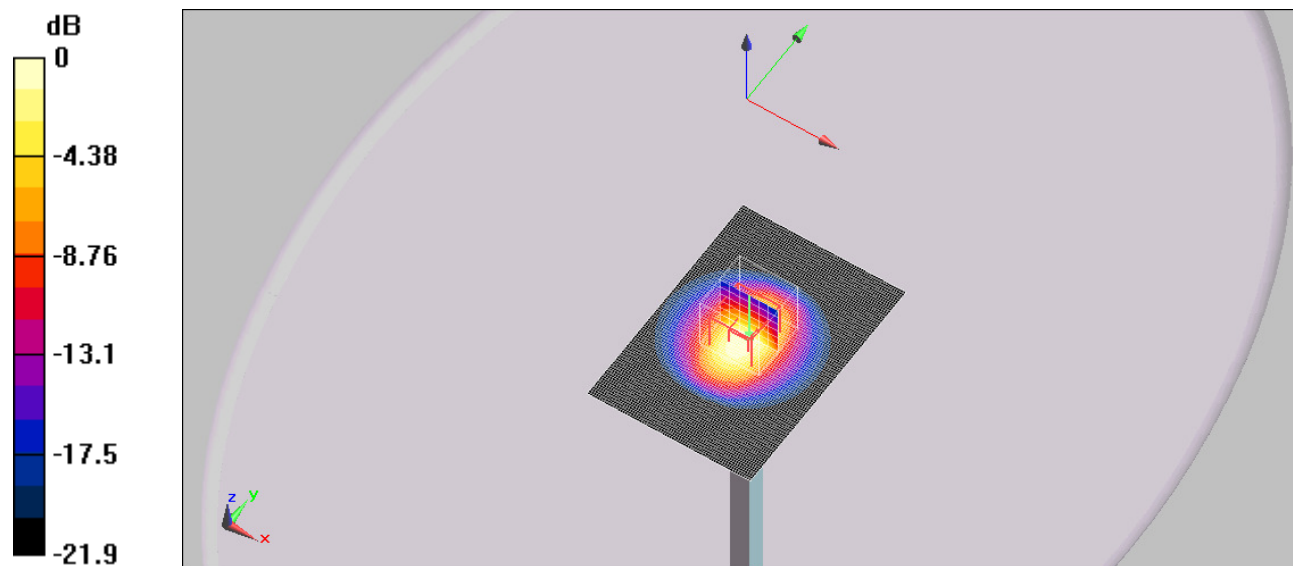

**0 dB = 20.2mW/g**



< 5 300 MHz Body / Date : Apr 11, 2016 >

DUT: Dipole 5GHz; Type: D5GHzV2; Serial: D5GHzV2 - SN:1094

Communication System: CW; Frequency: 5300 MHz; Duty Cycle: 1:1

Medium parameters used:  $f = 5300$  MHz;  $\sigma = 5.41$  mho/m;  $\epsilon_r = 47.2$ ;  $\rho = 1000$  kg/m<sup>3</sup>

Phantom section: Flat Section

**DASY5 Configuration:**

- Probe: EX3DV4 - SN3666; ConvF(4.73, 4.73, 4.73); Calibrated: 2015-05-26
- Sensor-Surface: 2mm (Mechanical Surface Detection)
- Electronics: DAE4 Sn444; Calibrated: 2015-11-23
- Phantom: ELI 4.0; Type: QDOVA001BA; Serial: 1030
- Measurement SW: DASY5, V5.0 Build 125; SEMCAD X Version 13.4 Build 125

5 300 MHz SPC/Area Scan (81x121x1): Measurement grid: dx=10mm, dy=10mm

Maximum value of SAR (interpolated) = 39.1 mW/g

5 300 MHz SPC/Zoom Scan (8x8x12)/Cube 0: Measurement grid: dx=4mm, dy=4mm, dz=2mm

Reference Value = 90.6 V/m; Power Drift = 0.064 dB

Peak SAR (extrapolated) = 78.6 W/kg

SAR(1 g) = 18.3 mW/g; SAR(10 g) = 5.15 mW/g

Maximum value of SAR (measured) = 35.4 mW/g

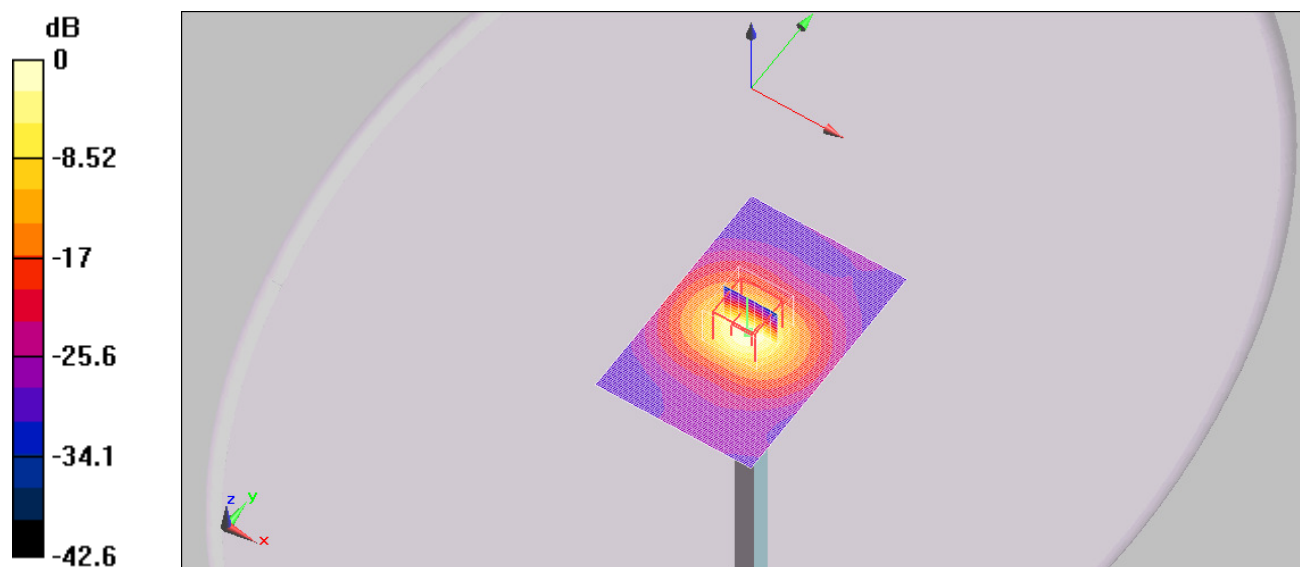

0 dB = 35.4mW/g

< 5 600 MHz Body / Date : Apr 11, 2016 >

DUT: Dipole 5GHz; Type: D5GHzV2; Serial: D5GHzV2 - SN:1094

Communication System: CW; Frequency: 5600 MHz; Duty Cycle: 1:1

Medium parameters used:  $f = 5600$  MHz;  $\sigma = 5.87$  mho/m;  $\epsilon_r = 46.4$ ;  $\rho = 1000$  kg/m<sup>3</sup>

Phantom section: Flat Section

**DASY5 Configuration:**

- Probe: EX3DV4 - SN3666; ConvF(4.25, 4.25, 4.25); Calibrated: 2015-05-26
- Sensor-Surface: 2mm (Mechanical Surface Detection)
- Electronics: DAE4 Sn444; Calibrated: 2015-11-23
- Phantom: ELI 4.0; Type: QDOVA001BA; Serial: 1030
- Measurement SW: DASY5, V5.0 Build 125; SEMCAD X Version 13.4 Build 125

5 600 MHz SPC/Area Scan (81x121x1): Measurement grid: dx=10mm, dy=10mm

Maximum value of SAR (interpolated) = 44.8 mW/g

5 600 MHz SPC/Zoom Scan (8x8x12)/Cube 0: Measurement grid: dx=4mm, dy=4mm, dz=2mm

Reference Value = 94.4 V/m; Power Drift = 0.087 dB

Peak SAR (extrapolated) = 95.6 W/kg

SAR(1 g) = 21 mW/g; SAR(10 g) = 5.83 mW/g

Maximum value of SAR (measured) = 41.5 mW/g

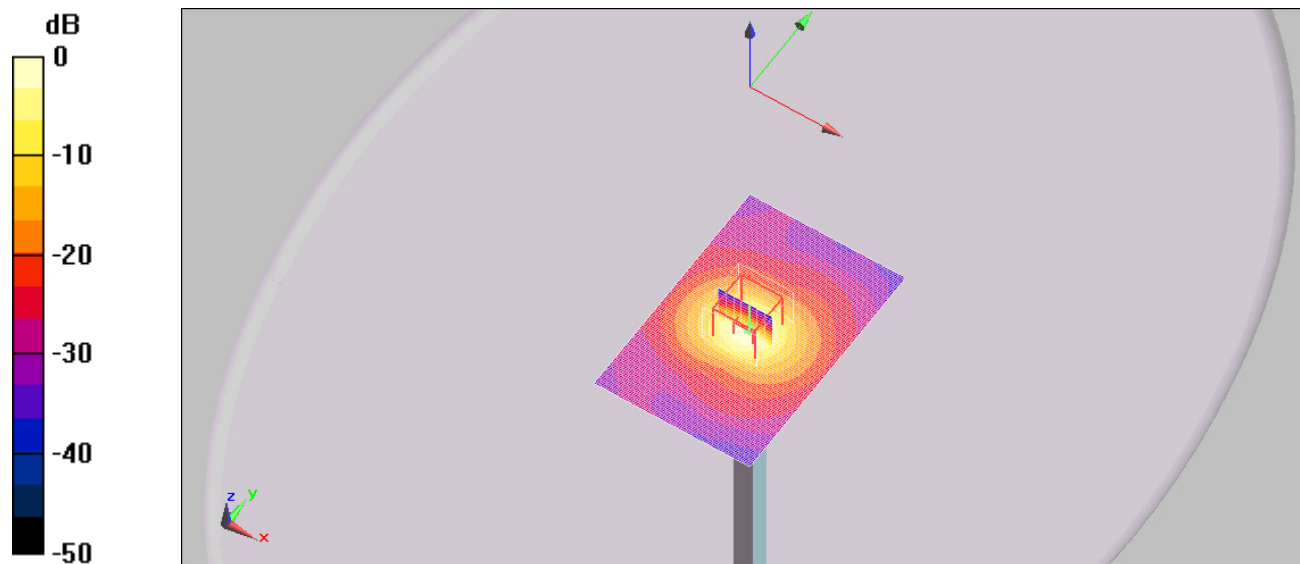

**0 dB = 41.5mW/g**

< 5 800 MHz Body / Date : Apr 12, 2016 >

DUT: Dipole 5GHz; Type: D5GHzV2; Serial: D5GHzV2 - SN:1094

Communication System: CW; Frequency: 5800 MHz; Duty Cycle: 1:1

Medium parameters used:  $f = 5800$  MHz;  $\sigma = 6.23$  mho/m;  $\epsilon_r = 45.9$ ;  $\rho = 1000$  kg/m<sup>3</sup>

Phantom section: Flat Section

**DASY5 Configuration:**

- Probe: EX3DV4 - SN3666; ConvF(4.73, 4.73, 4.73); Calibrated: 2015-05-26
- Sensor-Surface: 2mm (Mechanical Surface Detection)
- Electronics: DAE4 Sn444; Calibrated: 2015-11-23
- Phantom: ELI 4.0; Type: QDOVA001BA; Serial: 1030
- Measurement SW: DASY5, V5.0 Build 125; SEMCAD X Version 13.4 Build 125

5 800 MHz SPC/Area Scan (81x121x1): Measurement grid: dx=10mm, dy=10mm

Maximum value of SAR (interpolated) = 41.3 mW/g

5 800 MHz SPC/Zoom Scan (8x8x12)/Cube 0: Measurement grid: dx=4mm, dy=4mm, dz=2mm

Reference Value = 88.5 V/m; Power Drift = 0.050 dB

Peak SAR (extrapolated) = 90.4 W/kg

SAR(1 g) = 19.2 mW/g; SAR(10 g) = 5.31 mW/g

Maximum value of SAR (measured) = 37.9 mW/g

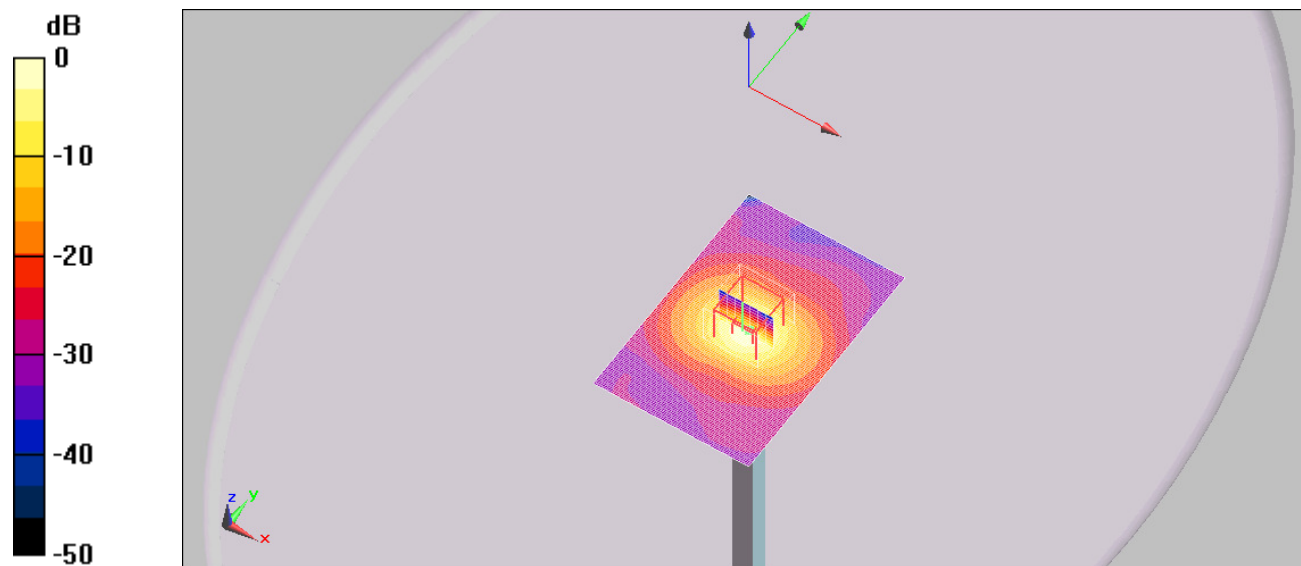

0 dB = 37.9mW/g

## ANNEX B. SAR TEST PLOTS

< GSM 850 CH128\_824.2 MHz Back Body / Date : Mar 30, 2016 >

DUT: RT100; Type: Sample; Serial: Not Specified

Communication System: GSM 850; Frequency: 824.2 MHz; Duty Cycle: 1:8.3

Medium parameters used:  $f = 825$  MHz;  $\sigma = 0.946$  mho/m;  $\epsilon_r = 55.8$ ;  $\rho = 1000$  kg/m<sup>3</sup>

Phantom section: Flat Section

DASY5 Configuration:

- Probe: ES3DV3 - SN3171; ConvF(5.97, 5.97, 5.97); Calibrated: 2015-07-21
- Sensor-Surface: 3mm (Mechanical Surface Detection)
- Electronics: DAE4 Sn444; Calibrated: 2015-11-23
- Phantom: ELI 4.0; Type: QDOVA001BA; Serial: 1030
- Measurement SW: DASY5, V5.0 Build 125; SEMCAD X Version 13.4 Build 125

GSM 850\_ch128\_824.2 MHz\_Back/Area Scan (61x61x1): Measurement grid: dx=12mm, dy=12mm

Maximum value of SAR (interpolated) = 0.116 mW/g

GSM 850\_ch128\_824.2 MHz\_Back/Zoom Scan (7x7x7)/Cube 0: Measurement grid: dx=5mm, dy=5mm, dz=5mm

Reference Value = 9.71 V/m; Power Drift = 0.015 dB

Peak SAR (extrapolated) = 0.179 W/kg

SAR(1 g) = 0.095 mW/g; SAR(10 g) = 0.055 mW/g

Maximum value of SAR (measured) = 0.120 mW/g

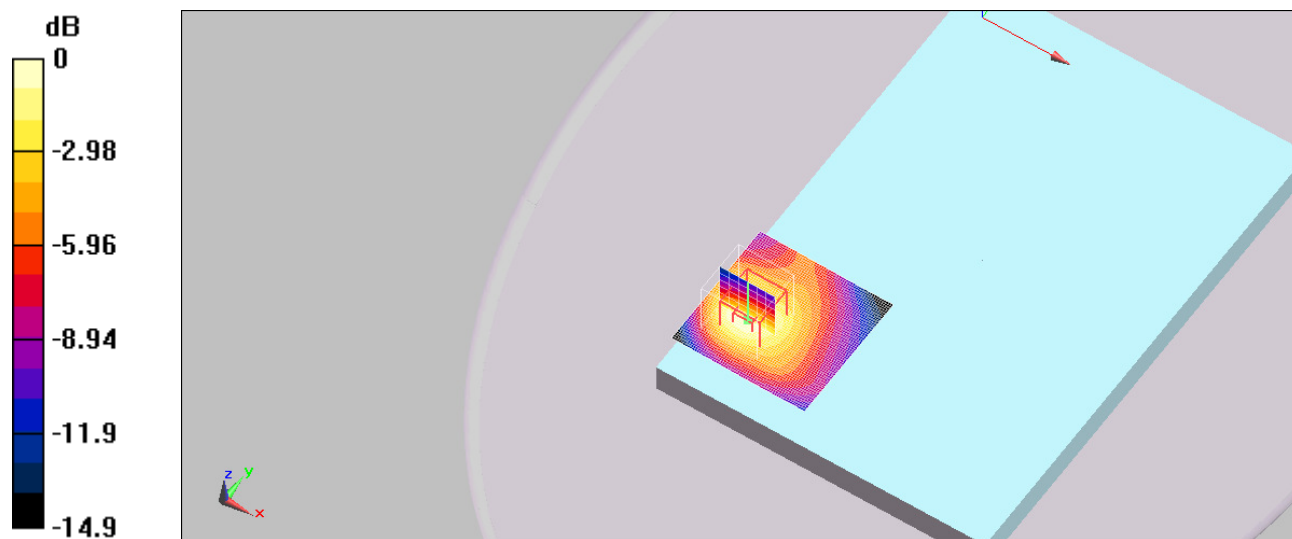

0 dB = 0.120mW/g

< GSM 1900 CH661\_1 880.0 MHz Back Body / Date : Mar 29, 2016 >

DUT: RT100; Type: Sample; Serial: Not Specified

Communication System: GSM 1900; Frequency: 1880 MHz; Duty Cycle: 1:8.3  
 Medium parameters used:  $f = 1880$  MHz;  $\sigma = 1.49$  mho/m;  $\epsilon_r = 53.8$ ;  $\rho = 1000$  kg/m<sup>3</sup>  
 Phantom section: Flat Section

**DASY5 Configuration:**

- Probe: ES3DV3 - SN3171; ConvF(4.84, 4.84, 4.84); Calibrated: 2015-07-21
- Sensor-Surface: 3mm (Mechanical Surface Detection)
- Electronics: DAE4 Sn444; Calibrated: 2015-11-23
- Phantom: ELI 4.0; Type: QDOVA001BA; Serial: 1030
- Measurement SW: DASY5, V5.0 Build 125; SEMCAD X Version 13.4 Build 125

GSM 1900\_ch661\_1 880.0 MHz\_Back/Area Scan (61x61x1): Measurement grid: dx=12mm, dy=12mm  
 Maximum value of SAR (interpolated) = 0.547 mW/g

GSM 1900\_ch661\_1 880.0 MHz\_Back/Zoom Scan (7x7x7)/Cube 0: Measurement grid: dx=5mm, dy=5mm, dz=5mm  
 Reference Value = 10.6 V/m; Power Drift = 0.150 dB  
 Peak SAR (extrapolated) = 0.840 W/kg  
 SAR(1 g) = 0.401 mW/g; SAR(10 g) = 0.187 mW/g  
 Maximum value of SAR (measured) = 0.530 mW/g

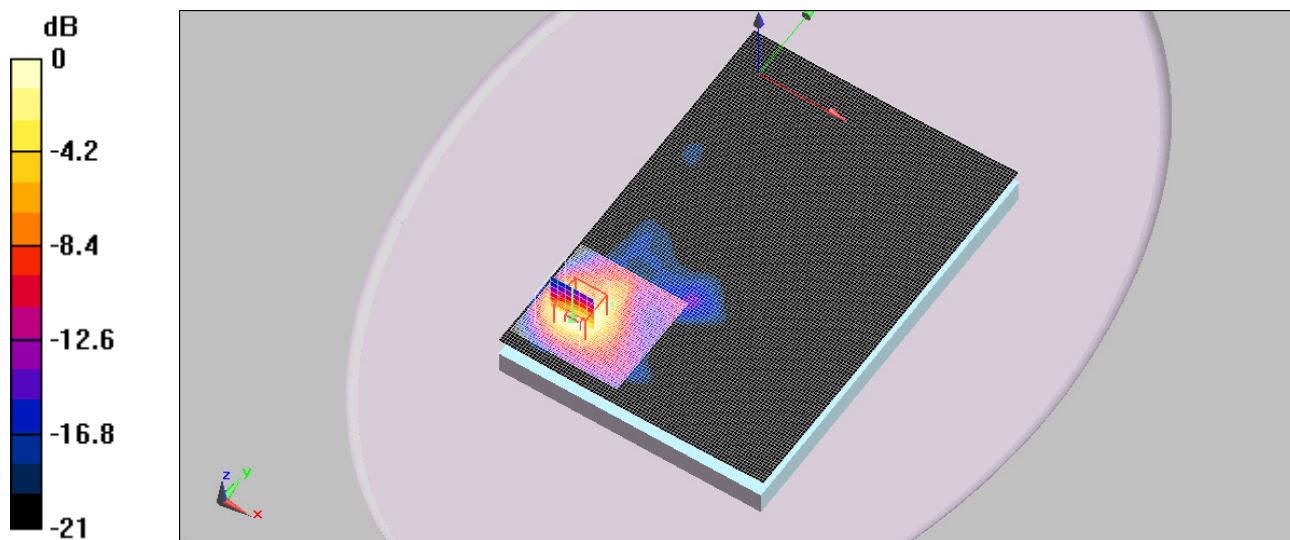

0 dB = 0.530mW/g

< WCDMA Band II CH9262\_1 852.4 MHz Back Body / Date : Mar 29, 2016 >

DUT: RT100; Type: Sample; Serial: Not Specified

Communication System: W-CDMA Band II; Frequency: 1852.4 MHz; Duty Cycle: 1:1

Medium parameters used :  $f = 1852.4 \text{ MHz}$ ;  $\sigma = 1.47 \text{ mho/m}$ ;  $\epsilon_r = 53.9$ ;  $\rho = 1000 \text{ kg/m}^3$

Phantom section: Flat Section

DASY5 Configuration:

- Probe: ES3DV3 - SN3171; ConvF(4.84, 4.84, 4.84); Calibrated: 2015-07-21
- Sensor-Surface: 3mm (Mechanical Surface Detection)
- Electronics: DAE4 Sn444; Calibrated: 2015-11-23
- Phantom: ELI 4.0; Type: QDOVA001BA; Serial: 1030
- Measurement SW: DASY5, V5.0 Build 125; SEMCAD X Version 13.4 Build 125

WCDMA Band II\_ch9262\_1 852.4 MHz\_Back/Area Scan (61x61x1): Measurement grid:  
 $dx=12\text{mm}$ ,  $dy=12\text{mm}$

Maximum value of SAR (interpolated) = 1.27 mW/g

WCDMA Band II\_ch9262\_1 852.4 MHz\_Back/Zoom Scan (7x7x7)/Cube 0: Measurement grid:  
 $dx=5\text{mm}$ ,  $dy=5\text{mm}$ ,  $dz=5\text{mm}$

Reference Value = 25.3 V/m; Power Drift = -0.156 dB

Peak SAR (extrapolated) = 2.12 W/kg

SAR(1 g) = 1.04 mW/g; SAR(10 g) = 0.490 mW/g

Maximum value of SAR (measured) = 1.36 mW/g

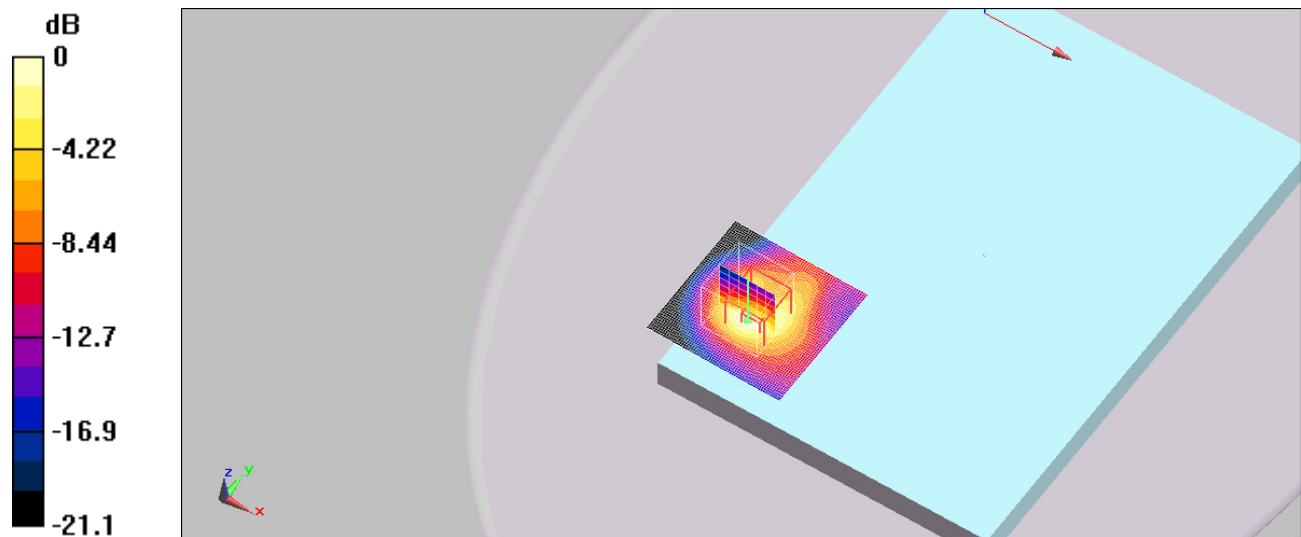

0 dB = 1.36mW/g

**< WCDMA Band II CH9400\_1 880.0 MHz Back Body / Date : Mar 29, 2016 >**

**DUT: RT100; Type: Sample; Serial: Not Specified**

**Communication System: W-CDMA Band II; Frequency: 1880 MHz;Duty Cycle: 1:1  
 Medium parameters used:  $f = 1880$  MHz;  $\sigma = 1.49$  mho/m;  $\epsilon_r = 53.8$ ;  $\rho = 1000$  kg/m<sup>3</sup>  
 Phantom section: Flat Section**

**DASY5 Configuration:**

- Probe: ES3DV3 - SN3171; ConvF(4.84, 4.84, 4.84); Calibrated: 2015-07-21
- Sensor-Surface: 3mm (Mechanical Surface Detection)
- Electronics: DAE4 Sn444; Calibrated: 2015-11-23
- Phantom: ELI 4.0; Type: QDOVA001BA; Serial: 1030
- Measurement SW: DASY5, V5.0 Build 125; SEMCAD X Version 13.4 Build 125

**WCDMA Band II\_ch9400\_1 880.0 MHz\_Back/Area Scan (61x61x1): Measurement grid:  
 dx=12mm, dy=12mm  
 Maximum value of SAR (interpolated) = 1.66 mW/g**

**WCDMA Band II\_ch9400\_1 880.0 MHz\_Back/Zoom Scan (7x7x7)/Cube 0: Measurement grid:  
 dx=5mm, dy=5mm, dz=5mm  
 Reference Value = 28.3 V/m; Power Drift = -0.149 dB  
 Peak SAR (extrapolated) = 2.72 W/kg  
 SAR(1 g) = 1.32 mW/g; SAR(10 g) = 0.618 mW/g  
 Maximum value of SAR (measured) = 1.71 mW/g**

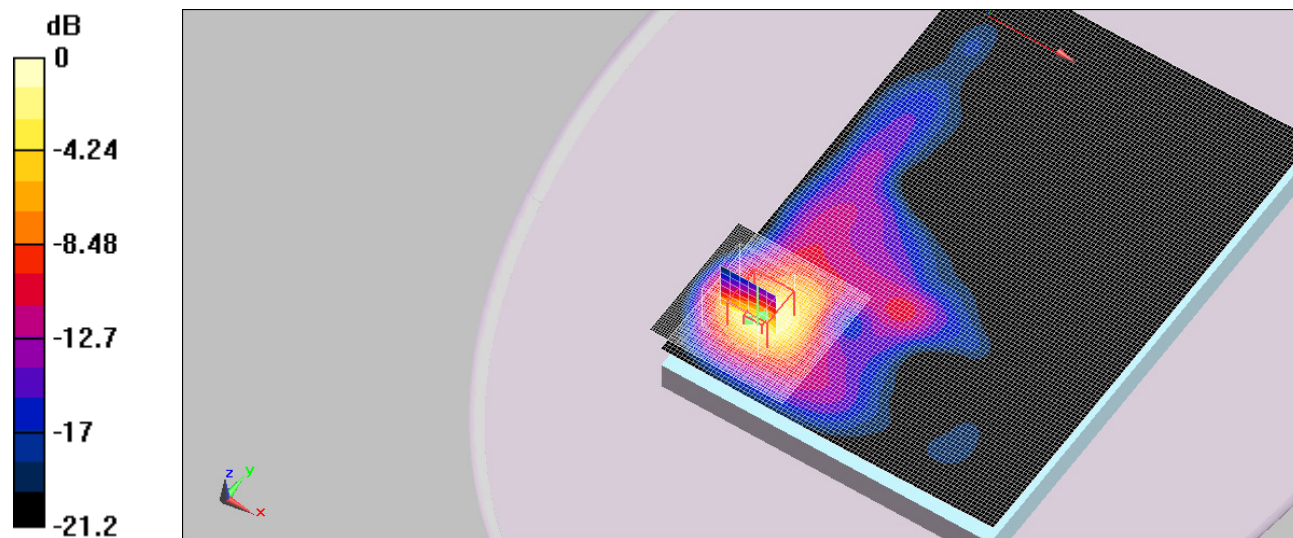

**0 dB = 1.71mW/g**

**< WCDMA Band II CH9538\_1 907.6 MHz Back Body / Date : Mar 29, 2016 >**

**DUT: RT100; Type: Sample; Serial: Not Specified**

**Communication System: W-CDMA Band II; Frequency: 1907.6 MHz; Duty Cycle: 1:1  
 Medium parameters used :  $f = 1907.6$  MHz;  $\sigma = 1.52$  mho/m;  $\epsilon_r = 53.7$ ;  $\rho = 1000$  kg/m<sup>3</sup>  
 Phantom section: Flat Section**

**DASY5 Configuration:**

- Probe: ES3DV3 - SN3171; ConvF(4.84, 4.84, 4.84); Calibrated: 2015-07-21
- Sensor-Surface: 3mm (Mechanical Surface Detection)
- Electronics: DAE4 Sn444; Calibrated: 2015-11-23
- Phantom: ELI 4.0; Type: QDOVA001BA; Serial: 1030
- Measurement SW: DASY5, V5.0 Build 125; SEMCAD X Version 13.4 Build 125

**WCDMA Band II\_ch9538\_1 907.6 MHz\_Back/Area Scan (61x61x1): Measurement grid:  
 dx=12mm, dy=12mm  
 Maximum value of SAR (interpolated) = 1.56 mW/g**

**WCDMA Band II\_ch9538\_1 907.6 MHz\_Back/Zoom Scan (7x7x7)/Cube 0: Measurement grid:  
 dx=5mm, dy=5mm, dz=5mm  
 Reference Value = 27.3 V/m; Power Drift = -0.173 dB  
 Peak SAR (extrapolated) = 2.57 W/kg  
 SAR(1 g) = 1.24 mW/g; SAR(10 g) = 0.577 mW/g  
 Maximum value of SAR (measured) = 1.62 mW/g**

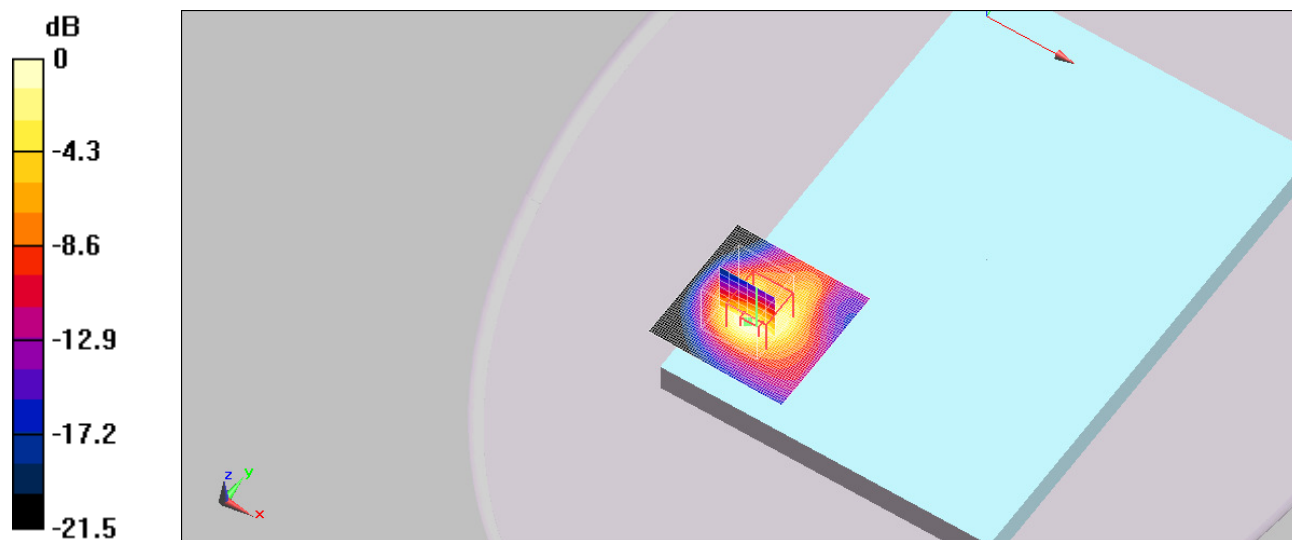

**0 dB = 1.62mW/g**



**< WCDMA Band II CH9400\_1 880.0 MHz Front Body / Date : Mar 29, 2016 >**

**DUT: RT100; Type: Sample; Serial: Not Specified**

**Communication System: W-CDMA Band II; Frequency: 1880 MHz; Duty Cycle: 1:1**  
**Medium parameters used: f = 1880 MHz;  $\sigma = 1.49$  mho/m;  $\epsilon_r = 53.8$ ;  $\rho = 1000$  kg/m<sup>3</sup>**  
**Phantom section: Flat Section**

**DASY5 Configuration:**

- Probe: ES3DV3 - SN3171; ConvF(4.84, 4.84, 4.84); Calibrated: 2015-07-21
- Sensor-Surface: 3mm (Mechanical Surface Detection)
- Electronics: DAE4 Sn444; Calibrated: 2015-11-23
- Phantom: ELI 4.0; Type: QDOVA001BA; Serial: 1030
- Measurement SW: DASY5, V5.0 Build 125; SEMCAD X Version 13.4 Build 125

**WCDMA Band II\_ch9400\_1 880.0 MHz\_Front/Area Scan (71x71x1): Measurement grid:**  
**dx=12mm, dy=12mm**

**Maximum value of SAR (interpolated) = 0.108 mW/g**

**WCDMA Band II\_ch9400\_1 880.0 MHz\_Front/Zoom Scan (7x7x7)/Cube 0: Measurement grid:**  
**dx=5mm, dy=5mm, dz=5mm**

**Reference Value = 8.26 V/m; Power Drift = 0.091 dB**

**Peak SAR (extrapolated) = 0.143 W/kg**

**SAR(1 g) = 0.086 mW/g; SAR(10 g) = 0.050 mW/g**

**Maximum value of SAR (measured) = 0.103 mW/g**

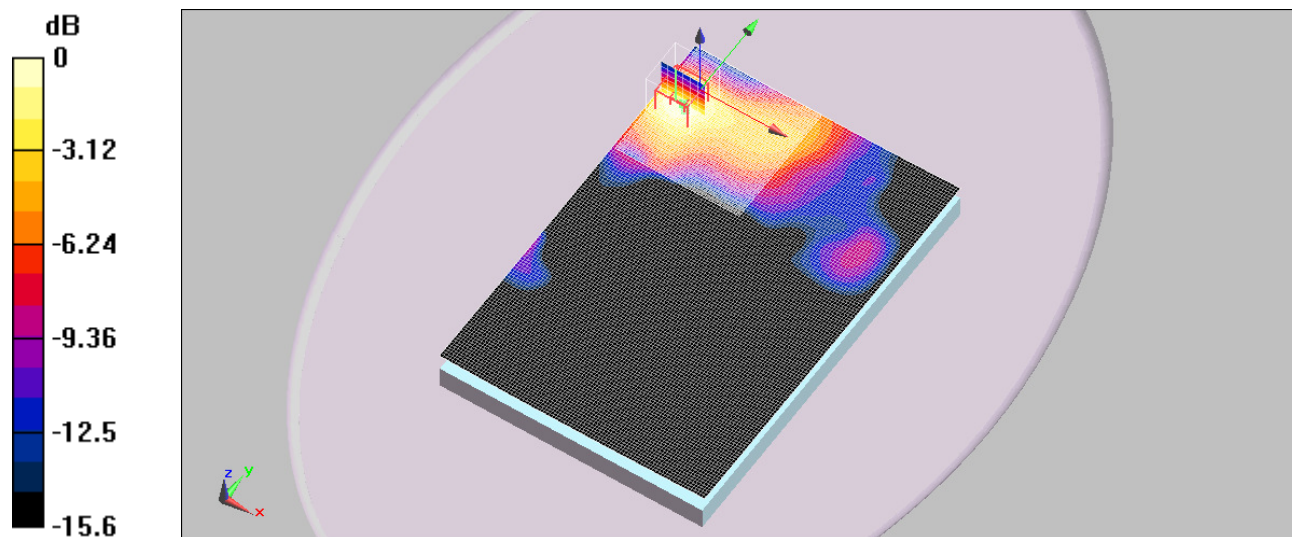

**0 dB = 0.103mW/g**

< WCDMA Band II CH9400\_1 880.0 MHz Top Body / Date : Mar 29, 2016 >

DUT: RT100; Type: Sample; Serial: Not Specified

Communication System: W-CDMA Band II; Frequency: 1880 MHz; Duty Cycle: 1:1  
 Medium parameters used:  $f = 1880$  MHz;  $\sigma = 1.49$  mho/m;  $\epsilon_r = 53.8$ ;  $\rho = 1000$  kg/m<sup>3</sup>  
 Phantom section: Flat Section

**DASY5 Configuration:**

- Probe: ES3DV3 - SN3171; ConvF(4.84, 4.84, 4.84); Calibrated: 2015-07-21
- Sensor-Surface: 3mm (Mechanical Surface Detection)
- Electronics: DAE4 Sn444; Calibrated: 2015-11-23
- Phantom: ELI 4.0; Type: QDOVA001BA; Serial: 1030
- Measurement SW: DASY5, V5.0 Build 125; SEMCAD X Version 13.4 Build 125

WCDMA Band II\_ch9400\_1 880.0 MHz\_Top/Area Scan (41x201x1): Measurement grid:  
 dx=12mm, dy=12mm  
 Maximum value of SAR (interpolated) = 0.042 mW/g

WCDMA Band II\_ch9400\_1 880.0 MHz\_Top/Zoom Scan (7x7x7)/Cube 0: Measurement grid:  
 dx=5mm, dy=5mm, dz=5mm  
 Reference Value = 5.28 V/m; Power Drift = 0.118 dB  
 Peak SAR (extrapolated) = 0.056 W/kg  
 SAR(1 g) = 0.034 mW/g; SAR(10 g) = 0.020 mW/g  
 Maximum value of SAR (measured) = 0.041 mW/g

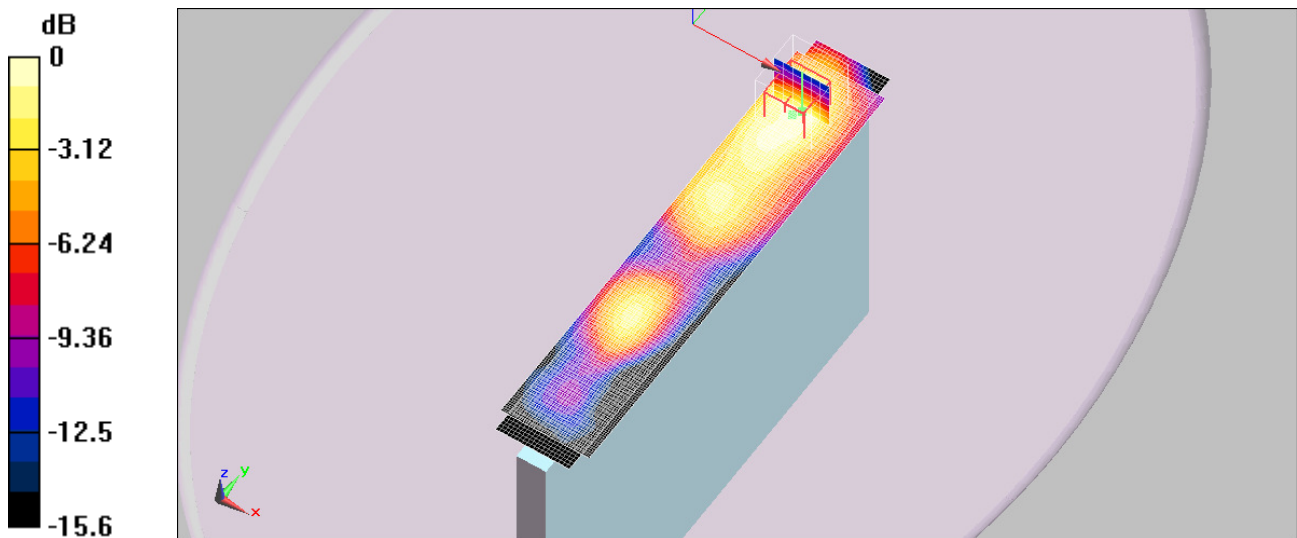

**0 dB = 0.041mW/g**

**< WCDMA Band II CH9400\_1 880.0 MHz Right Body / Date : Mar 29, 2016 >**

**DUT: RT100; Type: Sample; Serial: Not Specified**

**Communication System: W-CDMA Band II; Frequency: 1880 MHz; Duty Cycle: 1:1**  
**Medium parameters used:  $f = 1880$  MHz;  $\sigma = 1.49$  mho/m;  $\epsilon_r = 53.8$ ;  $\rho = 1000$  kg/m<sup>3</sup>**  
**Phantom section: Flat Section**

**DASY5 Configuration:**

- Probe: ES3DV3 - SN3171; ConvF(4.84, 4.84, 4.84); Calibrated: 2015-07-21
- Sensor-Surface: 3mm (Mechanical Surface Detection)
- Electronics: DAE4 Sn444; Calibrated: 2015-11-23
- Phantom: ELI 4.0; Type: QDOVA001BA; Serial: 1030
- Measurement SW: DASY5, V5.0 Build 125; SEMCAD X Version 13.4 Build 125

**WCDMA Band II\_ch9400\_1 880.0 MHz\_Right/Area Scan (41x81x1): Measurement grid:**  
**dx=12mm, dy=12mm**

**Maximum value of SAR (interpolated) = 0.051 mW/g**

**WCDMA Band II\_ch9400\_1 880.0 MHz\_Right/Zoom Scan (7x7x7)/Cube 0: Measurement grid:**  
**dx=5mm, dy=5mm, dz=5mm**

**Reference Value = 5.24 V/m; Power Drift = 0.033 dB**

**Peak SAR (extrapolated) = 0.064 W/kg**

**SAR(1 g) = 0.041 mW/g; SAR(10 g) = 0.024 mW/g**

**Maximum value of SAR (measured) = 0.048 mW/g**

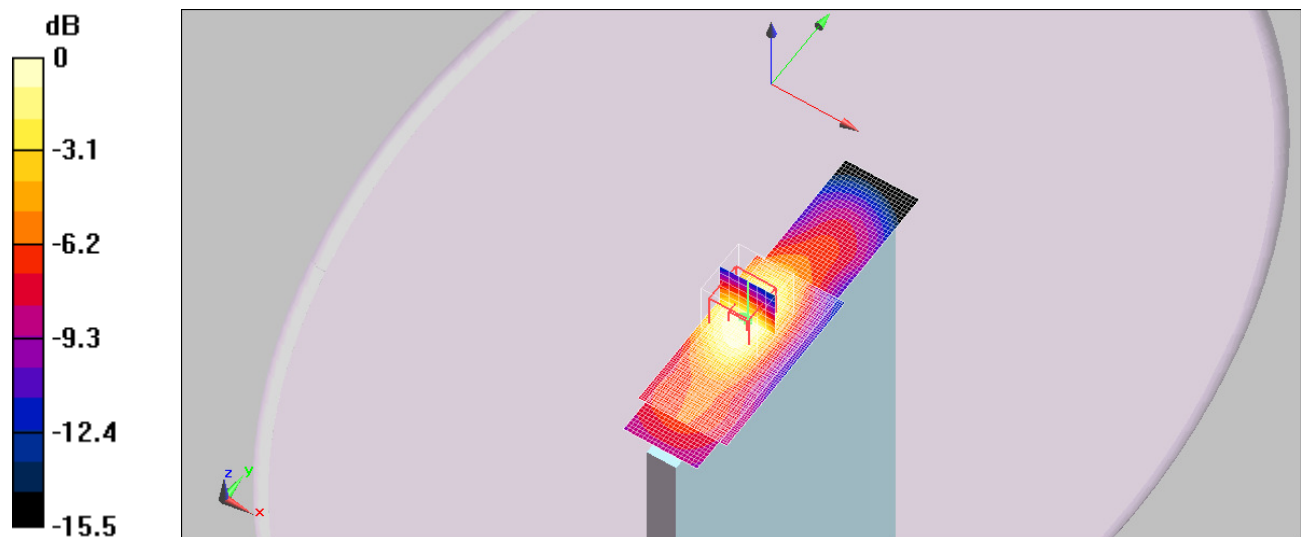

**0 dB = 0.048mW/g**

**< WCDMA Band II CH9400\_1 880.0 MHz Back Repeated Body / Date : Mar 29, 2016 >**

**DUT: RT100; Type: Sample; Serial: Not Specified**

**Communication System: W-CDMA Band II; Frequency: 1880 MHz; Duty Cycle: 1:1**  
**Medium parameters used: f = 1880 MHz;  $\sigma = 1.49$  mho/m;  $\epsilon_r = 53.8$ ;  $\rho = 1000$  kg/m<sup>3</sup>**  
**Phantom section: Flat Section**

**DASY5 Configuration:**

- Probe: ES3DV3 - SN3171; ConvF(4.84, 4.84, 4.84); Calibrated: 2015-07-21
- Sensor-Surface: 3mm (Mechanical Surface Detection)
- Electronics: DAE4 Sn444; Calibrated: 2015-11-23
- Phantom: ELI 4.0; Type: QDOVA001BA; Serial: 1030
- Measurement SW: DASY5, V5.0 Build 125; SEMCAD X Version 13.4 Build 125

**WCDMA Band II\_ch9400\_1 880.0 MHz\_Back/Area Scan (61x61x1): Measurement grid:**  
**dx=12mm, dy=12mm**

**Maximum value of SAR (interpolated) = 1.63 mW/g**

**WCDMA Band II\_ch9400\_1 880.0 MHz\_Back/Zoom Scan (7x7x7)/Cube 0: Measurement grid:**  
**dx=5mm, dy=5mm, dz=5mm**

**Reference Value = 28.2 V/m; Power Drift = -0.183 dB**

**Peak SAR (extrapolated) = 2.67 W/kg**

**SAR(1 g) = 1.3 mW/g; SAR(10 g) = 0.610 mW/g**

**Maximum value of SAR (measured) = 1.69 mW/g**

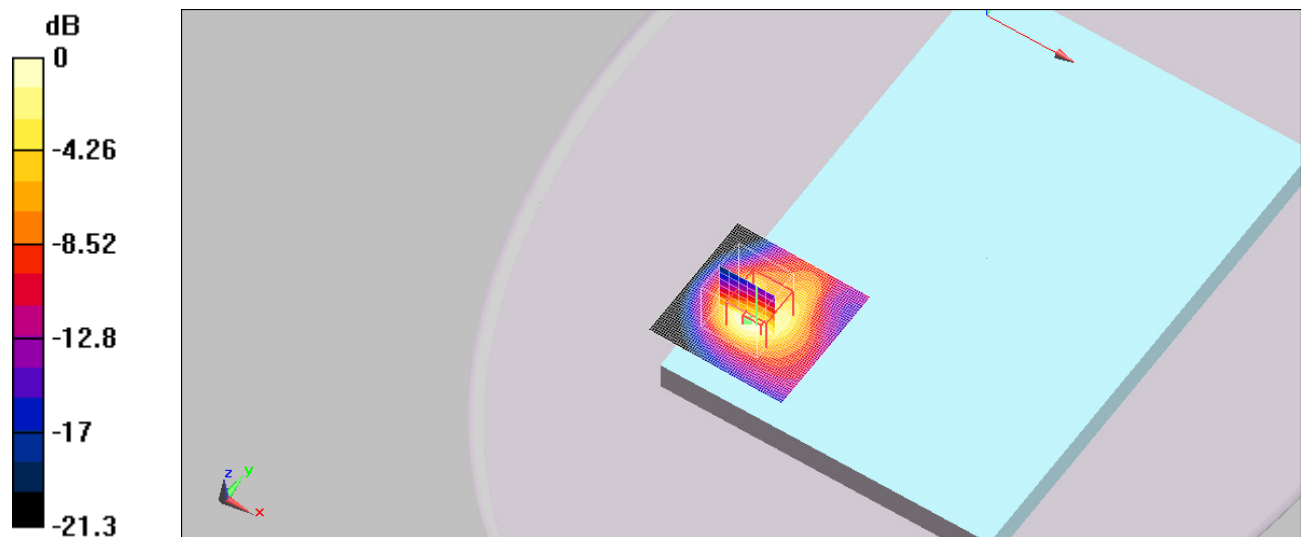

**0 dB = 1.69mW/g**

< WCDMA Band V CH4132\_826.4 MHz Back Body / Date : Mar 30, 2016 >

DUT: RT100; Type: Sample; Serial: Not Specified

Communication System: W-CDMA Band V; Frequency: 826.4 MHz; Duty Cycle: 1:1  
 Medium parameters used :  $f = 826.4$  MHz;  $\sigma = 0.947$  mho/m;  $\epsilon_r = 55.8$ ;  $\rho = 1000$  kg/m<sup>3</sup>  
 Phantom section: Flat Section

**DASY5 Configuration:**

- Probe: ES3DV3 - SN3171; ConvF(5.97, 5.97, 5.97); Calibrated: 2015-07-21
- Sensor-Surface: 3mm (Mechanical Surface Detection)
- Electronics: DAE4 Sn444; Calibrated: 2015-11-23
- Phantom: ELI 4.0; Type: QDOVA001BA; Serial: 1030
- Measurement SW: DASY5, V5.0 Build 125; SEMCAD X Version 13.4 Build 125

WCDMA Band V\_ch4132\_826.4 MHz\_Back/Area Scan (61x61x1): Measurement grid:  
 dx=12mm, dy=12mm  
 Maximum value of SAR (interpolated) = 0.138 mW/g

WCDMA Band V\_ch4132\_826.4 MHz\_Back/Zoom Scan (7x7x7)/Cube 0: Measurement grid:  
 dx=5mm, dy=5mm, dz=5mm  
 Reference Value = 12.1 V/m; Power Drift = 0.0024 dB  
 Peak SAR (extrapolated) = 0.221 W/kg  
 SAR(1 g) = 0.116 mW/g; SAR(10 g) = 0.067 mW/g  
 Maximum value of SAR (measured) = 0.147 mW/g

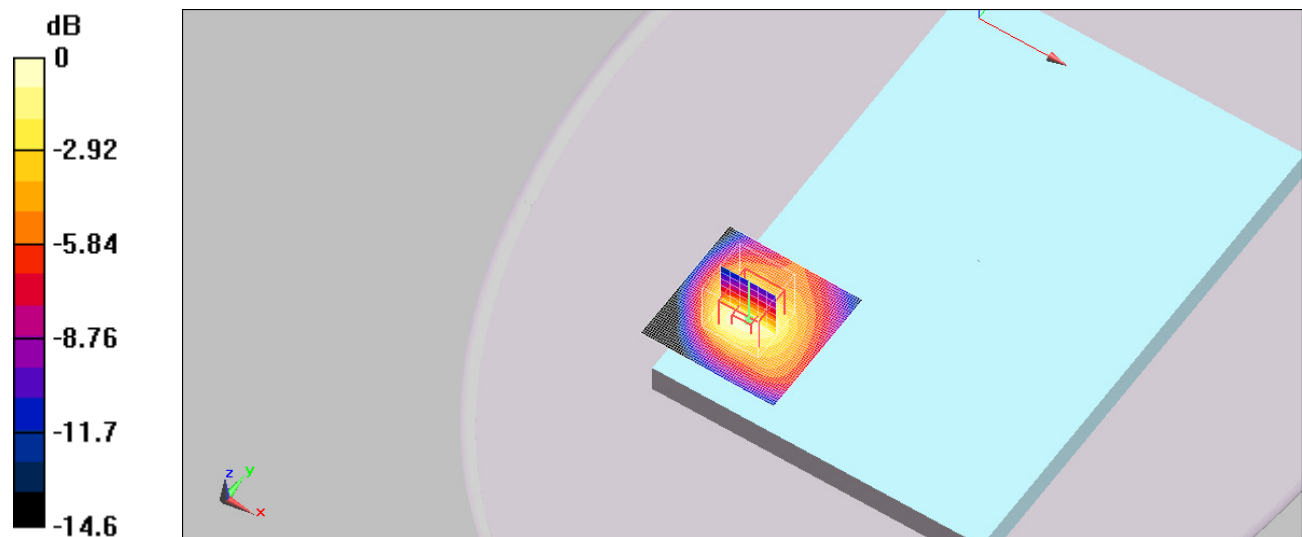

**0 dB = 0.147mW/g**

**< 802.11b CH1\_2 412 MHz 1 Mbps Back Repeated Body / Date : Mar 31, 2016 >**

**DUT: RT100; Type: Sample; Serial: Not Specified**

**Communication System: 802.11 b/g/n; Frequency: 2412 MHz;Duty Cycle: 1:1  
 Medium parameters used : f = 2412 MHz;  $\sigma = 1.92$  mho/m;  $\epsilon_r = 53.2$ ;  $\rho = 1000$  kg/m<sup>3</sup>  
 Phantom section: Flat Section**

**DASY5 Configuration:**

- Probe: EX3DV4 - SN3666; ConvF(7.76, 7.76, 7.76); Calibrated: 2015-05-26
- Sensor-Surface: 2mm (Mechanical Surface Detection)
- Electronics: DAE4 Sn444; Calibrated: 2015-11-23
- Phantom: ELI 4.0; Type: QDOVA001BA; Serial: 1030
- Measurement SW: DASY5, V5.0 Build 125; SEMCAD X Version 13.4 Build 125

**802.11b\_ch 1\_2 412 MHz\_1 Mbps\_Back/Area Scan (61x61x1): Measurement grid: dx=12mm, dy=12mm**

**Maximum value of SAR (interpolated) = 1.25 mW/g**

**802.11b\_ch 1\_2 412 MHz\_1 Mbps\_Back/Zoom Scan (7x7x7)/Cube 0: Measurement grid: dx=5mm, dy=5mm, dz=5mm**

**Reference Value = 21.1 V/m; Power Drift = -0.038 dB**

**Peak SAR (extrapolated) = 1.82 W/kg**

**SAR(1 g) = 0.895 mW/g; SAR(10 g) = 0.420 mW/g**

**Maximum value of SAR (measured) = 1.32 mW/g**

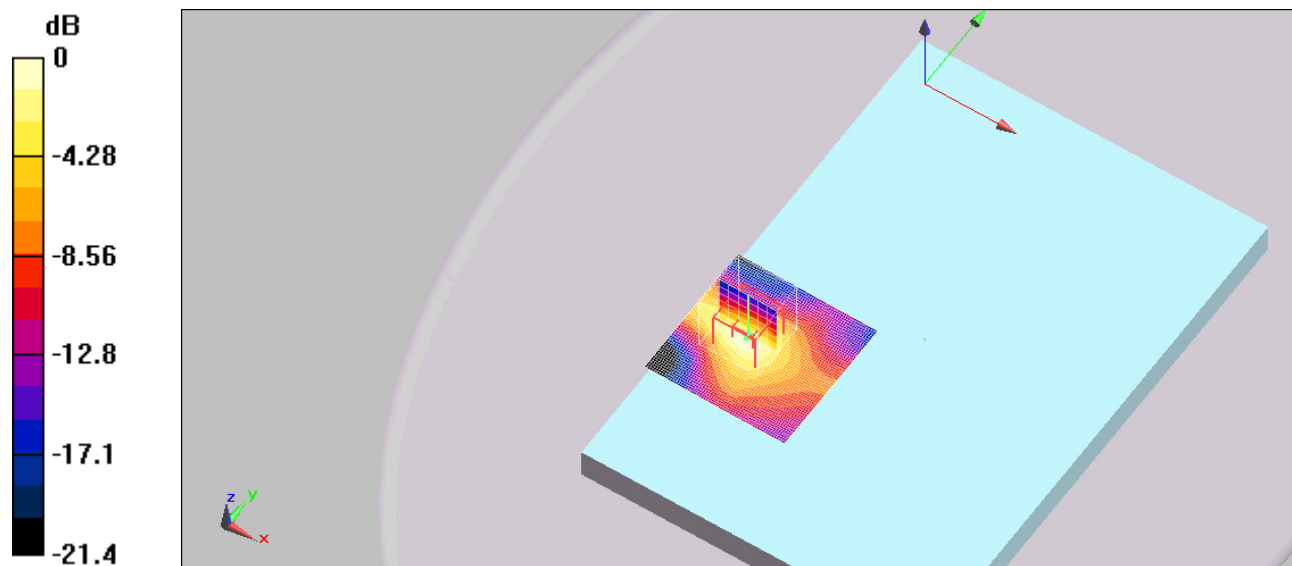

**0 dB = 1.32mW/g**

**< 802.11a CH60\_5 300 MHz 6 Mbps Back Repeated Body / Date : Apr 11, 2016 >**

**DUT: RT100; Type: Sample; Serial: Not Specified**

**Communication System: 802.11a; Frequency: 5300 MHz; Duty Cycle: 1:1**  
**Medium parameters used: f = 5300 MHz;  $\sigma = 5.41$  mho/m;  $\epsilon_r = 47.2$ ;  $\rho = 1000$  kg/m<sup>3</sup>**  
**Phantom section: Flat Section**

**DASY5 Configuration:**

- Probe: EX3DV4 - SN3666; ConvF(4.73, 4.73, 4.73); Calibrated: 2015-05-26
- Sensor-Surface: 2mm (Mechanical Surface Detection)
- Electronics: DAE4 Sn444; Calibrated: 2015-11-23
- Phantom: ELI 4.0; Type: QDOVA001BA; Serial: 1030
- Measurement SW: DASY5, V5.0 Build 125; SEMCAD X Version 13.4 Build 125

**802.11a\_ch60\_5 300 MHz\_6 Mbps\_Back/Area Scan (61x81x1): Measurement grid: dx=10mm, dy=10mm**

**Maximum value of SAR (interpolated) = 1.44 mW/g**

**802.11a\_ch60\_5 300 MHz\_6 Mbps\_Back/Zoom Scan (9x9x12)/Cube 0: Measurement grid: dx=4mm, dy=4mm, dz=2mm**

**Reference Value = 12.4 V/m; Power Drift = 0.028 dB**

**Peak SAR (extrapolated) = 5.04 W/kg**

**SAR(1 g) = 0.858 mW/g; SAR(10 g) = 0.191 mW/g**

**Maximum value of SAR (measured) = 2.11 mW/g**

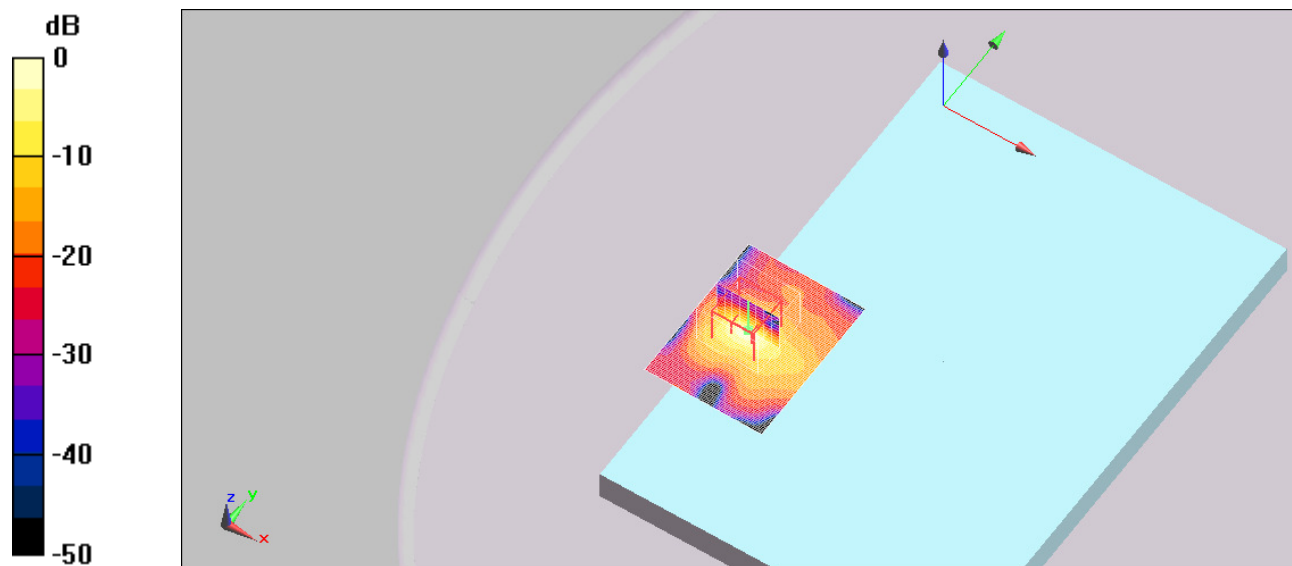

**0 dB = 2.11mW/g**

< 802.11a CH112\_5 560 MHz 6 Mbps Back Body / Date : Apr 11, 2016 >

DUT: RT100; Type: Sample; Serial: Not Specified

Communication System: 802.11a; Frequency: 5560 MHz; Duty Cycle: 1:1  
 Medium parameters used:  $f = 5560$  MHz;  $\sigma = 5.82$  mho/m;  $\epsilon_r = 46.4$ ;  $\rho = 1000$  kg/m<sup>3</sup>  
 Phantom section: Flat Section

DASY5 Configuration:

- Probe: EX3DV4 - SN3666; ConvF(4.25, 4.25, 4.25); Calibrated: 2015-05-26
- Sensor-Surface: 2mm (Mechanical Surface Detection)
- Electronics: DAE4 Sn444; Calibrated: 2015-11-23
- Phantom: ELI 4.0; Type: QDOVA001BA; Serial: 1030
- Measurement SW: DASY5, V5.0 Build 125; SEMCAD X Version 13.4 Build 125

802.11a\_ch112\_5 560 MHz\_6 Mbps\_Back/Area Scan (61x81x1): Measurement grid: dx=10mm, dy=10mm

Maximum value of SAR (interpolated) = 1.63 mW/g

802.11a\_ch112\_5 560 MHz\_6 Mbps\_Back/Zoom Scan (9x9x12)/Cube 0: Measurement grid: dx=4mm, dy=4mm, dz=2mm

Reference Value = 15.1 V/m; Power Drift = -0.128 dB

Peak SAR (extrapolated) = 3.78 W/kg

SAR(1 g) = 0.757 mW/g; SAR(10 g) = 0.181 mW/g

Maximum value of SAR (measured) = 1.66 mW/g

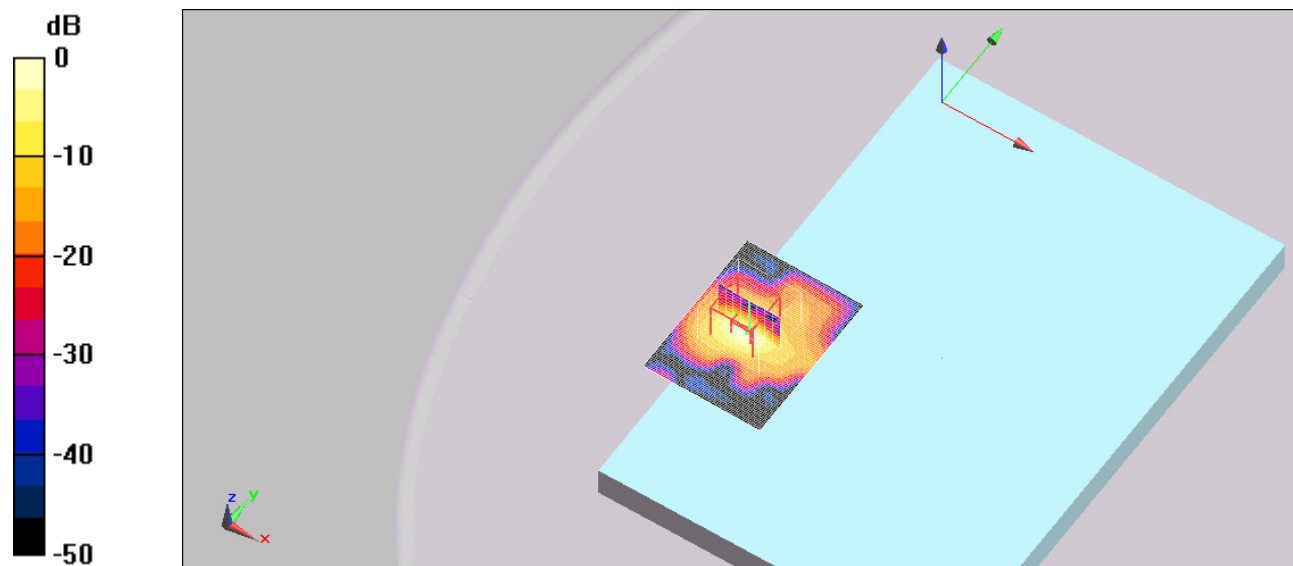

0 dB = 1.66mW/g



< 802.11a CH165\_5 825 MHz 6 Mbps Back Body / Date : Apr 12, 2016 >

DUT: RT100; Type: Sample; Serial: Not Specified

Communication System: 802.11a; Frequency: 5825 MHz; Duty Cycle: 1:1  
 Medium parameters used :  $f = 5825 \text{ MHz}$ ;  $\sigma = 6.32 \text{ mho/m}$ ;  $\epsilon_r = 45.9$ ;  $\rho = 1000 \text{ kg/m}^3$   
 Phantom section: Flat Section

DASY5 Configuration:

- Probe: EX3DV4 - SN3666; ConvF(4.73, 4.73, 4.73); Calibrated: 2015-05-26
- Sensor-Surface: 2mm (Mechanical Surface Detection)
- Electronics: DAE4 Sn444; Calibrated: 2015-11-23
- Phantom: ELI 4.0; Type: QDOVA001BA; Serial: 1030
- Measurement SW: DASY5, V5.0 Build 125; SEMCAD X Version 13.4 Build 125

802.11a\_ch165\_5 825 MHz\_6 Mbps\_Back/Area Scan (61x81x1): Measurement grid: dx=10mm, dy=10mm

Maximum value of SAR (interpolated) = 1.92 mW/g

802.11a\_ch165\_5 825 MHz\_6 Mbps\_Back/Zoom Scan (9x9x12)/Cube 0: Measurement grid: dx=4mm, dy=4mm, dz=2mm

Reference Value = 18.6 V/m; Power Drift = 0.045 dB

Peak SAR (extrapolated) = 3.32 W/kg

SAR(1 g) = 0.771 mW/g; SAR(10 g) = 0.207 mW/g

Maximum value of SAR (measured) = 1.84 mW/g

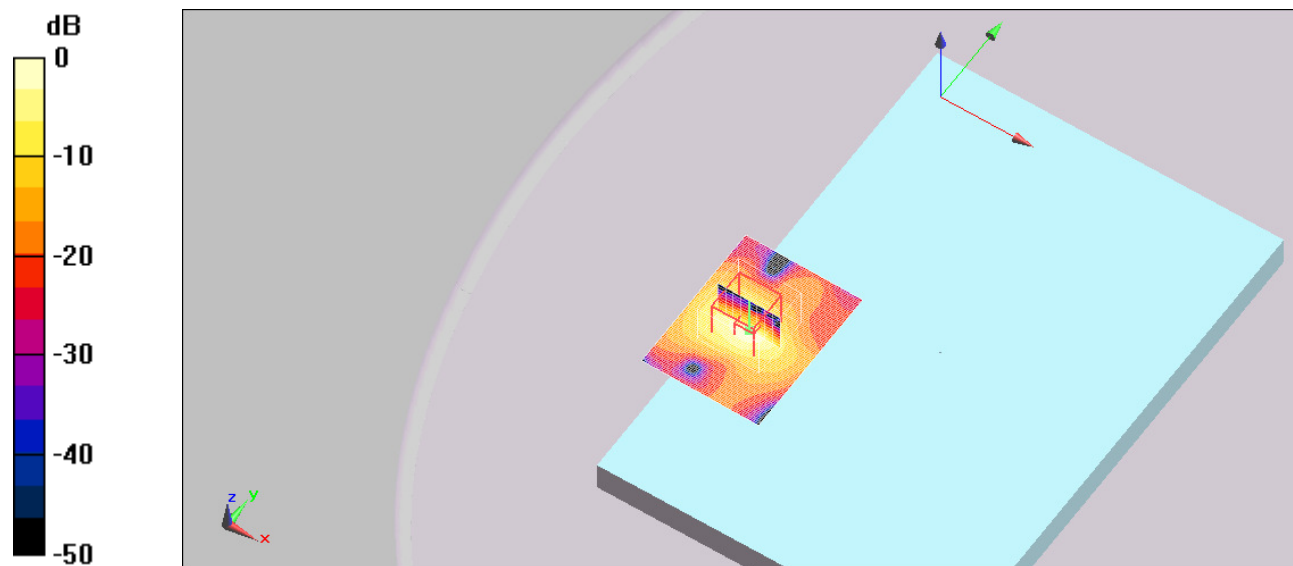

0 dB = 1.84mW/g

## ANNEX C. PHOTOGRAPHS

### < System Verification >

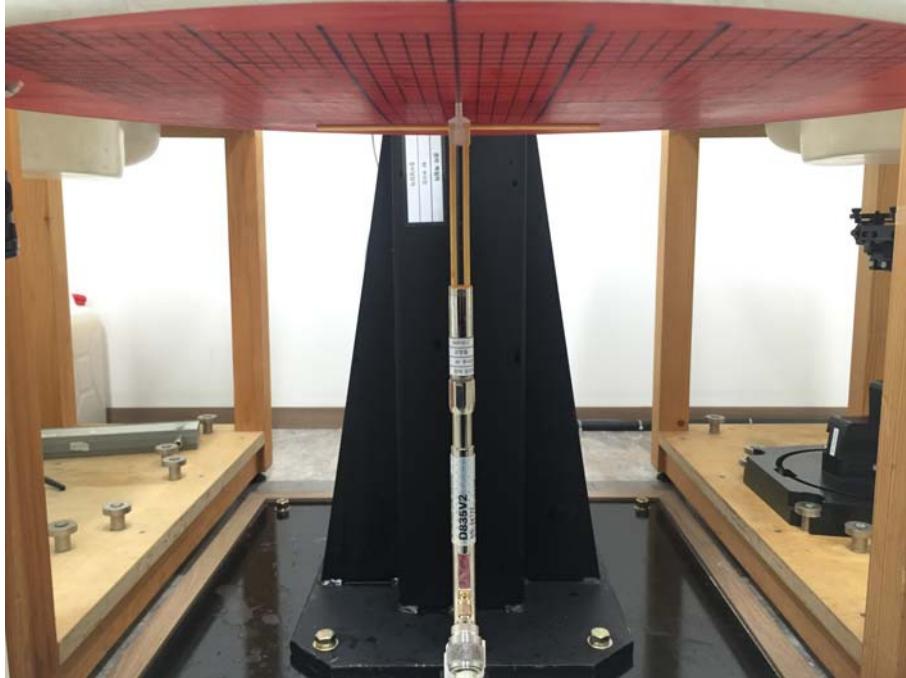

< 835 MHz >

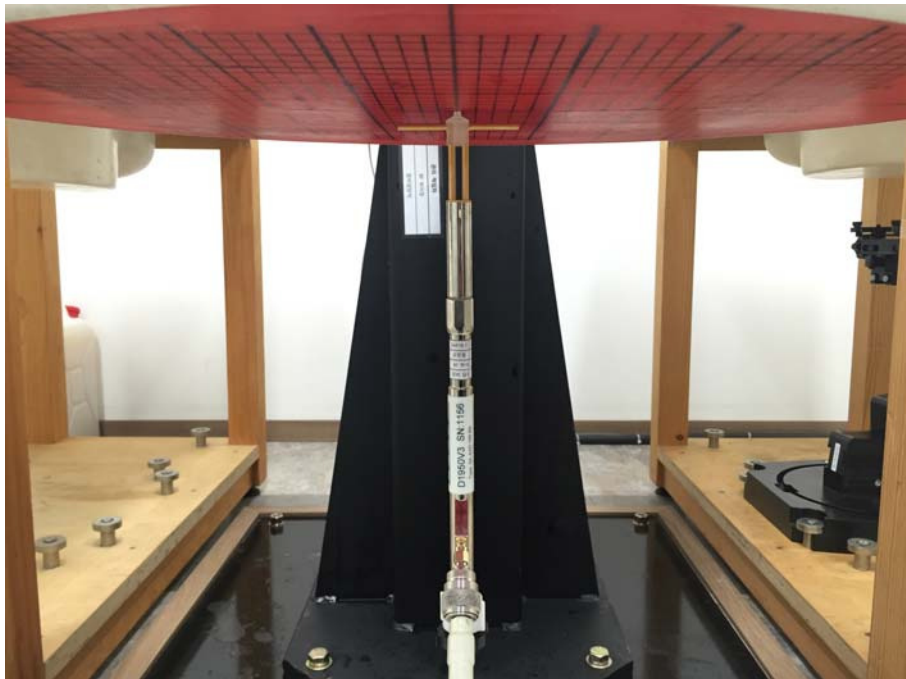

< 1 950 MHz >

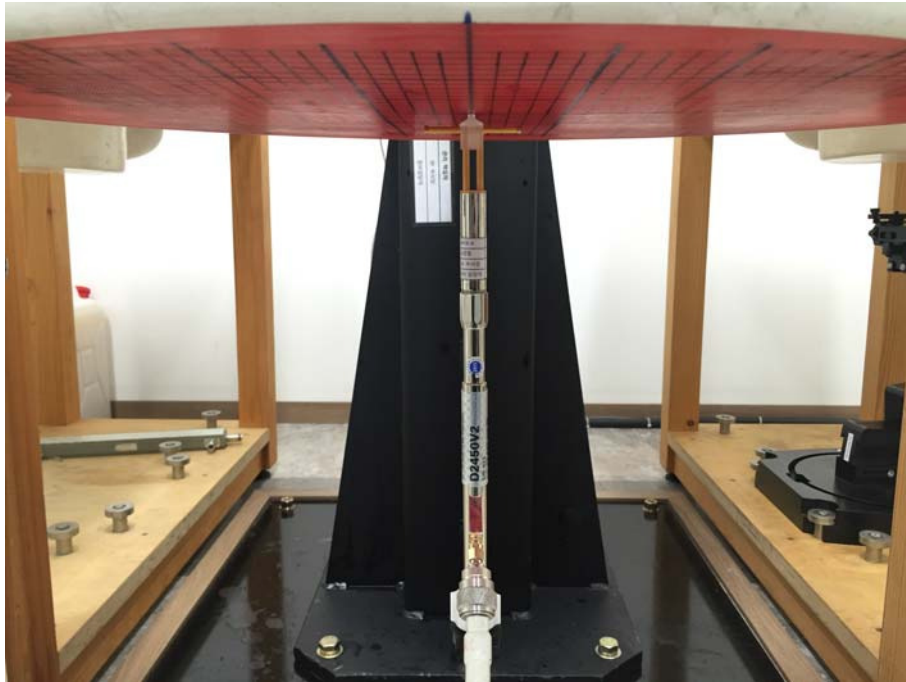

< 2 450 MHz >

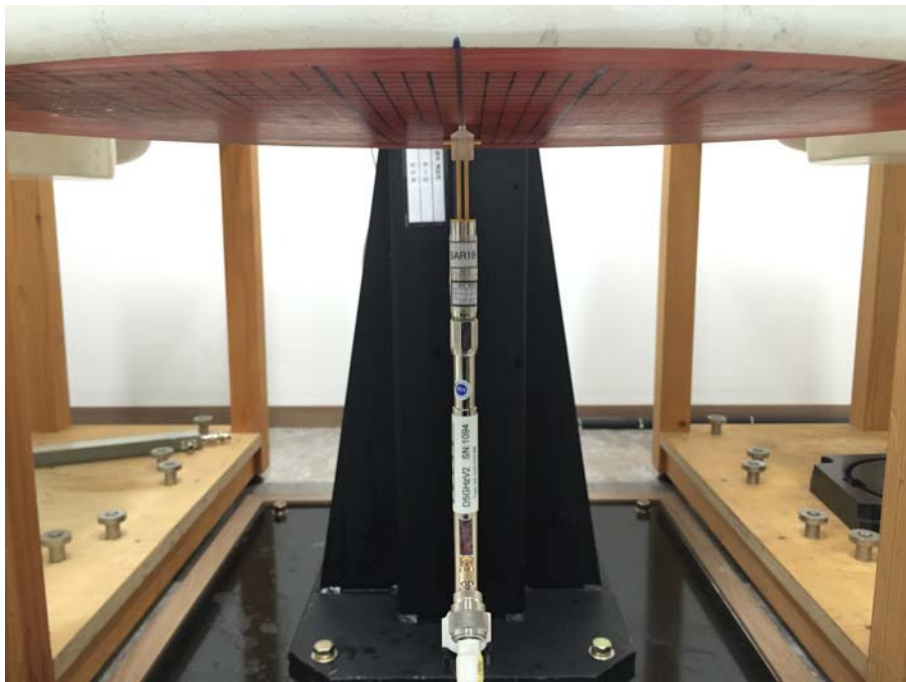

< 5 GHz >

< Test position >



Front view (Front of DUT)

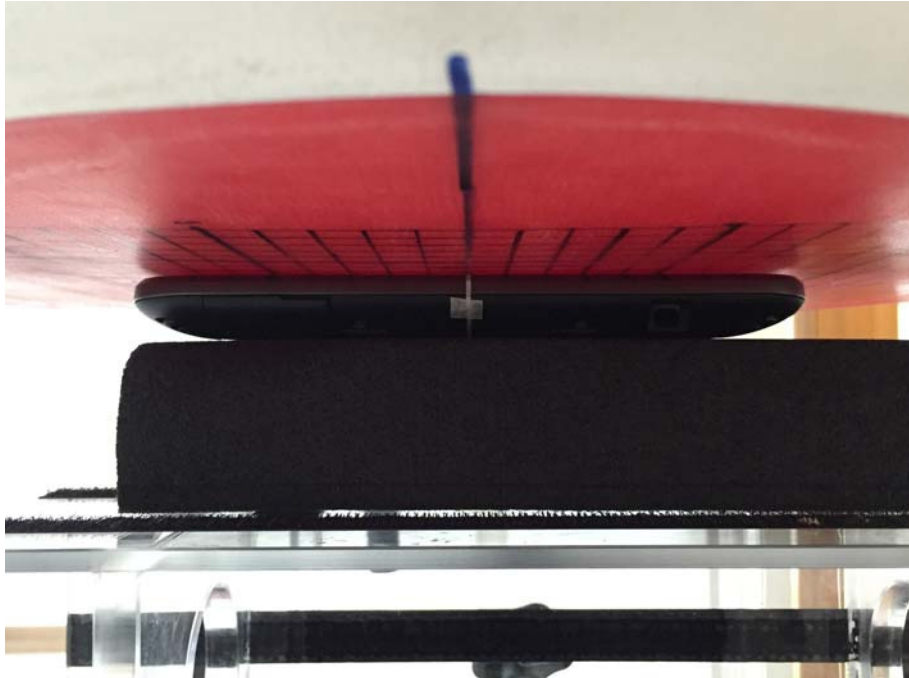

Side view (Front of DUT)



Front view (Back of DUT)



Side view (Back of DUT)



Front view (Top of DUT)



Side view (Top of DUT)



Front view (Right of DUT)

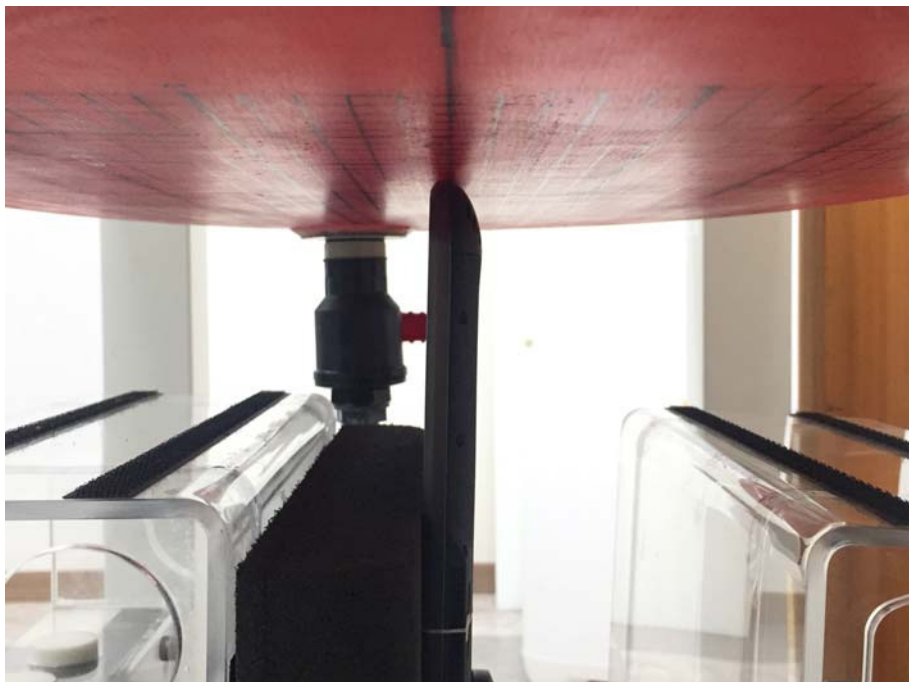

Side view (Right of DUT)

< Liquid Depth >



< 835 MHz >



< 1 950 MHz >





< 2 450 MHz >

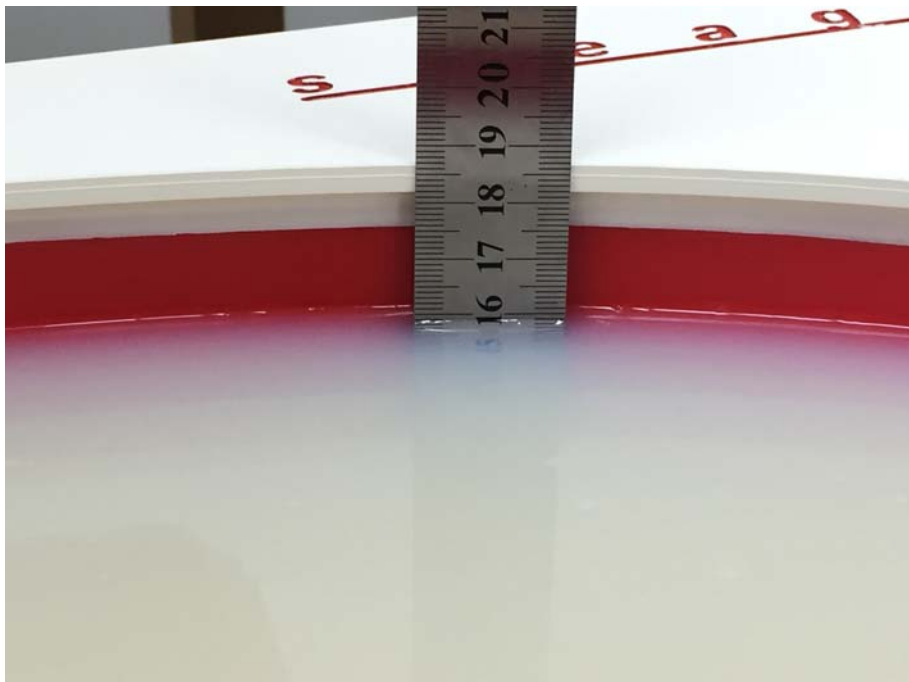

< 5 GHz >

< DUT Photograph >



< Front >



< Back >



< Top >



< Bottom >



< Left >



< Right >

### ANNEX D. ANTENNA INFORMATION

< Antenna location >

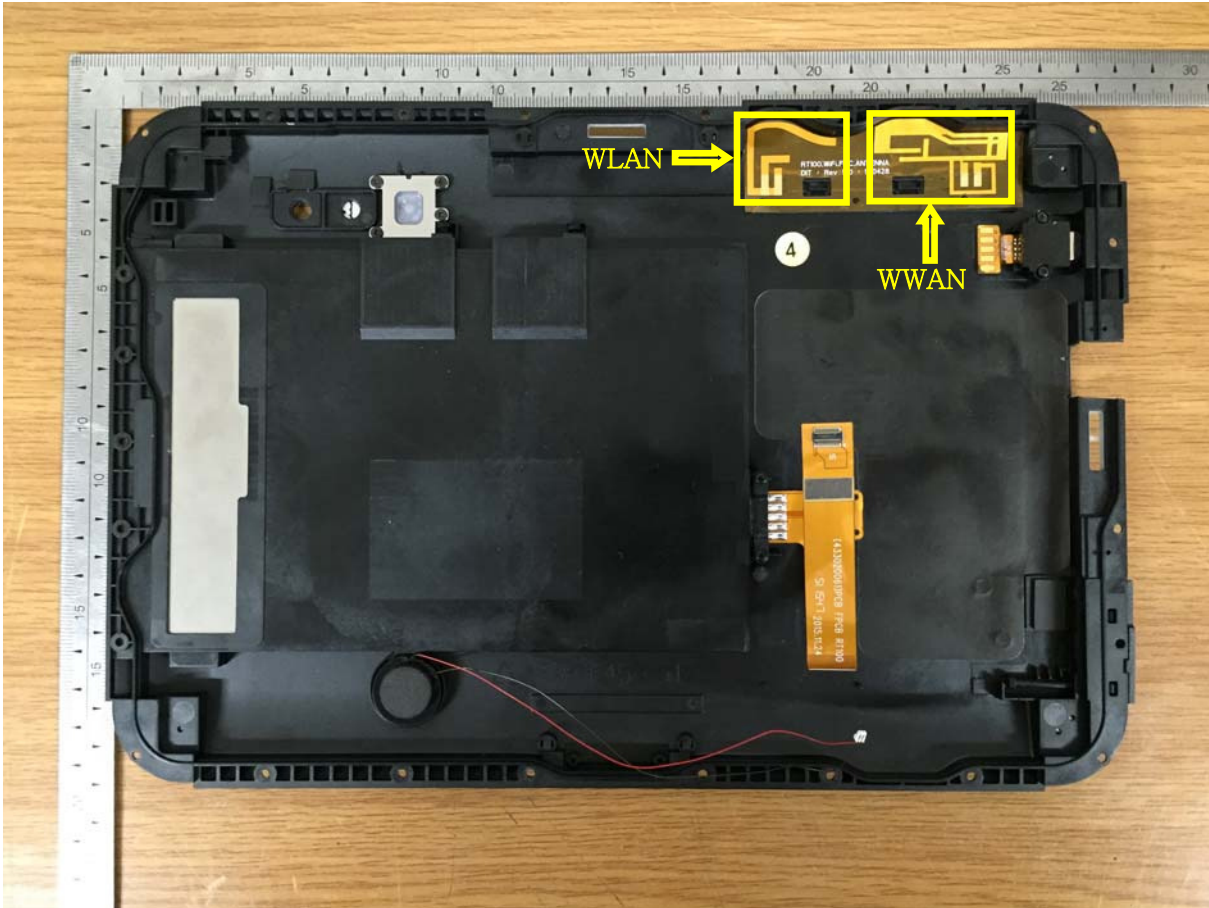

< Back View >

< Antenna Data Sheet >

1. WWAN Antenna Data Sheet

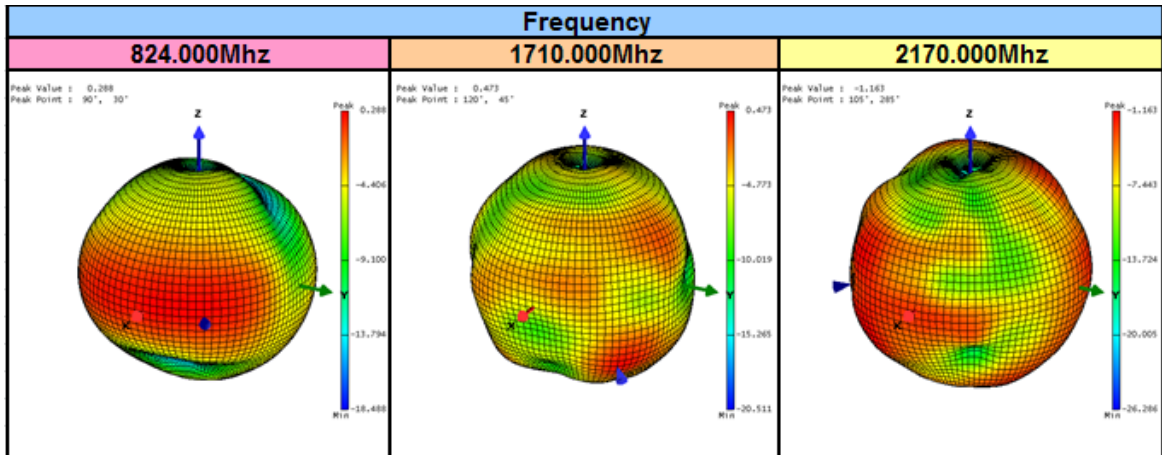

2. Test Results

Frequency [MHz]	Peak Value		Minimum Value		Avg. Gain [dBi]	Efficiency [%]
	Value[dBi]	Degree	Value[dBi]	Degree		
824	0.288	090 / 030	-18.488	030 / 180	-4.116	38.59%
850	1.747	090 / 360	-14.269	030 / 180	-2.52	55.72%
880	2.812	090 / 345	-17.247	150 / 165	-1.175	75.95%
894	1.837	090 / 330	-26.087	150 / 165	-2.118	61.12%
917	2.393	090 / 030	-20.947	150 / 165	-1.716	67.05%
940	2.138	090 / 030	-24.725	045 / 150	-2.404	57.22%
960	2.616	090 / 030	-25.111	045 / 135	-2.235	59.50%
1710	0.473	120 / 045	-20.511	075 / 210	-5.212	29.98%
1780	2.339	120 / 060	-16.717	105 / 300	-3.185	47.81%
1850	2.561	090 / 030	-24.801	060 / 195	-3.268	46.91%
1880	2.187	090 / 030	-17.271	060 / 195	-3.948	40.11%
1920	1.54	120 / 045	-17.315	135 / 285	-4.392	36.21%
1990	2.435	090 / 015	-14.542	105 / 135	-2.979	50.13%
2110	0.62	120 / 270	-25.716	165 / 255	-4.149	38.29%
2170	-1.163	105 / 285	-26.286	165 / 255	-5.309	29.31%

2. WLAN Antenna Data Sheet

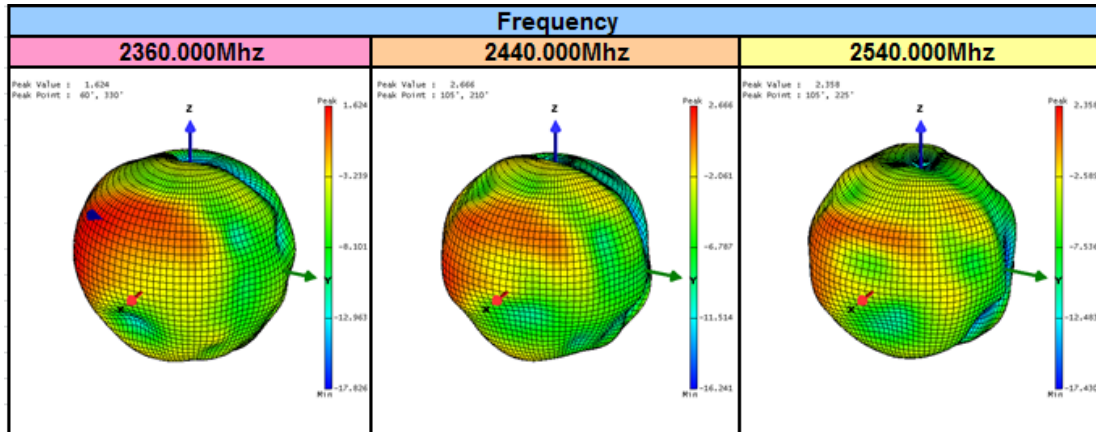

2. Test Results

Frequency [MHz]	Peak Value		Minimum Value		Avg. Gain [dBi]	Efficiency [%]
	Value[dBi]	Degree	Value[dBi]	Degree		
2360	0.124	060 / 330	-17.826	015 / 210	-3.408	45.42%
2380	0.524	075 / 270	-22.812	015 / 210	-3.147	48.23%
2400	0.527	090 / 210	-19.862	015 / 225	-3.306	46.50%
2420	0.519	090 / 210	-15.846	120 / 105	-3.292	46.65%
2440	0.966	105 / 210	-16.241	120 / 105	-2.881	51.27%
2460	1.018	105 / 210	-17.033	030 / 165	-2.795	52.30%
2480	0.983	105 / 210	-24.724	030 / 165	-3.219	47.44%
2500	0.673	105 / 210	-18.025	030 / 195	-3.585	43.60%
2520	0.683	105 / 225	-16.304	090 / 105	-3.42	45.29%
2540	0.858	105 / 225	-17.43	165 / 075	-3.411	45.39%

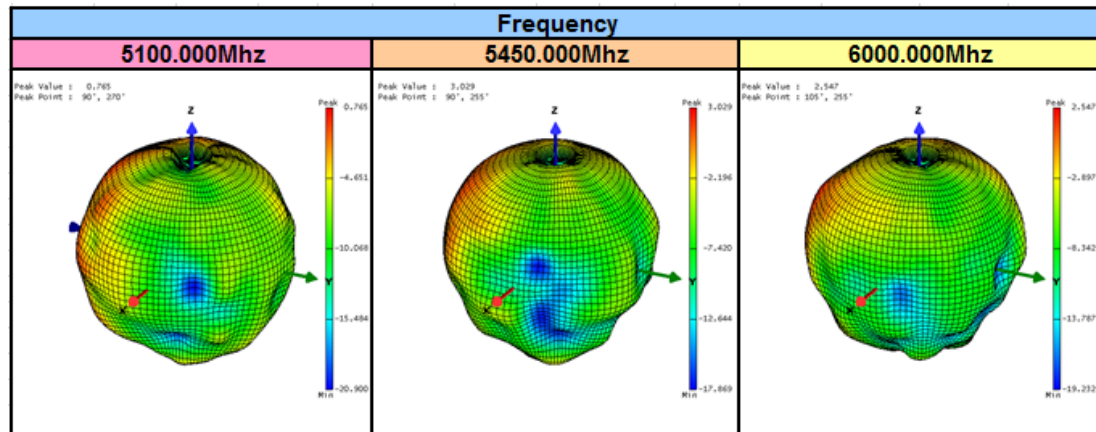

2. Test Results

Frequency [MHz]	Peak Value		Minimum Value		Avg. Gain [dBi]	Efficiency [%]
	Value[dBi]	Degree	Value[dBi]	Degree		
5100	-0.235	090 / 270	-20.9	090 / 030	-5.099	30.77%
5150	0.275	105 / 270	-20.639	135 / 015	-3.969	39.91%
5250	0.556	105 / 270	-24.165	090 / 030	-3.546	44.00%
5350	0.996	090 / 255	-19.254	135 / 105	-3.707	42.39%
5450	1.029	090 / 255	-17.869	135 / 090	-3.298	46.59%
5550	1.057	090 / 255	-15.843	150 / 120	-2.68	53.71%
5650	1.364	090 / 255	-22.33	120 / 105	-2.581	54.94%
5750	1.308	135 / 225	-16.678	135 / 345	-3.166	48.02%
5875	0.852	090 / 255	-24.5	120 / 120	-3.828	41.23%
6000	0.547	105 / 255	-19.232	090 / 135	-3.207	47.56%

## ANNEX E. PROBE AND DIPOLE CALIBRATION CERTIFICATES

### < E-Field Probe : ES3DV3 – SN 3171 >

Calibration Laboratory of  
Schmid & Partner  
Engineering AG  
Zeughausstrasse 43, 8004 Zurich, Switzerland



S Schweizerischer Kalibrierdienst  
C Service suisse d'étalonnage  
S Servizio svizzero di taratura  
S Swiss Calibration Service

Accredited by the Swiss Accreditation Service (SAS)  
The Swiss Accreditation Service is one of the signatories to the EA  
Multilateral Agreement for the recognition of calibration certificates

Accreditation No.: SCS 0108

Client **Onetech (Dymstec)**

Certificate No: **ES3-3171\_Jul15**

CALIBRATION CERTIFICATE	
Object	ES3DV3 - SN:3171
Calibration procedure(s)	QA CAL-01.v9, QA CAL-23.v5, QA CAL-25.v6 Calibration procedure for dosimetric E-field probes
Calibration date:	July 21, 2015
This calibration certificate documents the traceability to national standards, which realize the physical units of measurements (SI). The measurements and the uncertainties with confidence probability are given on the following pages and are part of the certificate.	
All calibrations have been conducted in the closed laboratory facility: environment temperature (22 ± 3)°C and humidity < 70%.	
Calibration Equipment used (M&TE critical for calibration)	

Primary Standards	ID	Cal Date (Certificate No.)	Scheduled Calibration
Power meter E4419B	GB41293874	01-Apr-15 (No. 217-02128)	Mar-16
Power sensor E4412A	MY41498087	01-Apr-15 (No. 217-02128)	Mar-16
Reference 3 dB Attenuator	SN: S5054 (3c)	01-Apr-15 (No. 217-02129)	Mar-16
Reference 20 dB Attenuator	SN: S5277 (20x)	01-Apr-15 (No. 217-02132)	Mar-16
Reference 30 dB Attenuator	SN: S5129 (30b)	01-Apr-15 (No. 217-02133)	Mar-16
Reference Probe ES3DV2	SN: 3013	30-Dec-14 (No. ES3-3013_Dec14)	Dec-15
DAE4	SN: 660	14-Jan-15 (No. DAE4-660_Jan15)	Jan-16
Secondary Standards	ID	Check Date (in house)	Scheduled Check
RF generator HP 8648C	US3642U01700	4-Aug-99 (in house check Apr-13)	In house check: Apr-16
Network Analyzer HP 8753E	US37390585	18-Oct-01 (in house check Oct-14)	In house check: Oct-15

	Name	Function	Signature
Calibrated by:	Jeton Kastrati	Laboratory Technician	
Approved by:	Katja Pokovic	Technical Manager	
			Issued: July 23, 2015
This calibration certificate shall not be reproduced except in full without written approval of the laboratory.			



**Calibration Laboratory of  
Schmid & Partner  
Engineering AG**  
Zeughausstrasse 43, 8004 Zurich, Switzerland



**S** Schweizerischer Kalibrierdienst  
**C** Service suisse d'étalonnage  
**S** Servizio svizzero di taratura  
Swiss Calibration Service

Accredited by the Swiss Accreditation Service (SAS)  
The Swiss Accreditation Service is one of the signatories to the EA  
Multilateral Agreement for the recognition of calibration certificates

Accreditation No.: **SCS 0108**

**Glossary:**

TSL	tissue simulating liquid
NORM <sub>x,y,z</sub>	sensitivity in free space
ConvF	sensitivity in TSL / NORM <sub>x,y,z</sub>
DCP	diode compression point
CF	crest factor (1/duty_cycle) of the RF signal
A, B, C, D	modulation dependent linearization parameters
Polarization φ	φ rotation around probe axis
Polarization θ	θ rotation around an axis that is in the plane normal to probe axis (at measurement center), i.e., θ = 0 is normal to probe axis
Connector Angle	information used in DASY system to align probe sensor X to the robot coordinate system

**Calibration is Performed According to the Following Standards:**

- a) IEEE Std 1528-2013, "IEEE Recommended Practice for Determining the Peak Spatial-Averaged Specific Absorption Rate (SAR) in the Human Head from Wireless Communications Devices: Measurement Techniques", June 2013
- b) IEC 62209-1, "Procedure to measure the Specific Absorption Rate (SAR) for hand-held devices used in close proximity to the ear (frequency range of 300 MHz to 3 GHz)", February 2005
- c) IEC 62209-2, "Procedure to determine the Specific Absorption Rate (SAR) for wireless communication devices used in close proximity to the human body (frequency range of 30 MHz to 6 GHz)", March 2010
- d) KDB 865664, "SAR Measurement Requirements for 100 MHz to 6 GHz"

**Methods Applied and Interpretation of Parameters:**

- **NORM<sub>x,y,z</sub>**: Assessed for E-field polarization θ = 0 (f ≤ 900 MHz in TEM-cell; f > 1800 MHz: R22 waveguide). NORM<sub>x,y,z</sub> are only intermediate values, i.e., the uncertainties of NORM<sub>x,y,z</sub> does not affect the E<sup>2</sup>-field uncertainty inside TSL (see below ConvF).
- **NORM(f)<sub>x,y,z</sub>** = NORM<sub>x,y,z</sub> \* frequency\_response (see Frequency Response Chart). This linearization is implemented in DASY4 software versions later than 4.2. The uncertainty of the frequency response is included in the stated uncertainty of ConvF.
- **DCP<sub>x,y,z</sub>**: DCP are numerical linearization parameters assessed based on the data of power sweep with CW signal (no uncertainty required). DCP does not depend on frequency nor media.
- **PAR**: PAR is the Peak to Average Ratio that is not calibrated but determined based on the signal characteristics
- **A<sub>x,y,z</sub>; B<sub>x,y,z</sub>; C<sub>x,y,z</sub>; D<sub>x,y,z</sub>; VR<sub>x,y,z</sub>**: A, B, C, D are numerical linearization parameters assessed based on the data of power sweep for specific modulation signal. The parameters do not depend on frequency nor media. VR is the maximum calibration range expressed in RMS voltage across the diode.
- **ConvF and Boundary Effect Parameters**: Assessed in flat phantom using E-field (or Temperature Transfer Standard for f ≤ 800 MHz) and inside waveguide using analytical field distributions based on power measurements for f > 800 MHz. The same setups are used for assessment of the parameters applied for boundary compensation (alpha, depth) of which typical uncertainty values are given. These parameters are used in DASY4 software to improve probe accuracy close to the boundary. The sensitivity in TSL corresponds to NORM<sub>x,y,z</sub> \* ConvF whereby the uncertainty corresponds to that given for ConvF. A frequency dependent ConvF is used in DASY version 4.4 and higher which allows extending the validity from ± 50 MHz to ± 100 MHz.
- **Spherical isotropy (3D deviation from isotropy)**: in a field of low gradients realized using a flat phantom exposed by a patch antenna.
- **Sensor Offset**: The sensor offset corresponds to the offset of virtual measurement center from the probe tip (on probe axis). No tolerance required.
- **Connector Angle**: The angle is assessed using the information gained by determining the NORM<sub>x</sub> (no uncertainty required).

ES3DV3 – SN:3171

July 21, 2015

# Probe ES3DV3

## SN:3171

Manufactured: January 23, 2008  
Calibrated: July 21, 2015

Calibrated for DASY/EASY Systems  
(Note: non-compatible with DASY2 system!)

ES3DV3- SN:3171

July 21, 2015

## DASY/EASY - Parameters of Probe: ES3DV3 - SN:3171

### Basic Calibration Parameters

	Sensor X	Sensor Y	Sensor Z	Unc (k=2)
Norm ( $\mu\text{V}/(\text{V}/\text{m})^2$ ) <sup>A</sup>	1.06	1.20	1.19	$\pm 10.1 \%$
DCP (mV) <sup>B</sup>	105.3	96.5	102.7	

### Modulation Calibration Parameters

UID	Communication System Name		A dB	B dB $\sqrt{\mu\text{V}}$	C	D dB	VR mV	Unc <sup>E</sup> (k=2)
0	CW	X	0.0	0.0	1.0	0.00	190.3	$\pm 3.8 \%$
		Y	0.0	0.0	1.0		201.5	
		Z	0.0	0.0	1.0		202.8	

The reported uncertainty of measurement is stated as the standard uncertainty of measurement multiplied by the coverage factor k=2, which for a normal distribution corresponds to a coverage probability of approximately 95%.

<sup>A</sup> The uncertainties of Norm X,Y,Z do not affect the E<sup>2</sup>-field uncertainty inside TSL (see Pages 5 and 6).

<sup>B</sup> Numerical linearization parameter: uncertainty not required.

<sup>E</sup> Uncertainty is determined using the max. deviation from linear response applying rectangular distribution and is expressed for the square of the field value.

ES3DV3- SN:3171

July 21, 2015

## DASY/EASY - Parameters of Probe: ES3DV3 - SN:3171

### Calibration Parameter Determined in Head Tissue Simulating Media

f (MHz) <sup>C</sup>	Relative Permittivity <sup>F</sup>	Conductivity (S/m) <sup>F</sup>	ConvF X	ConvF Y	ConvF Z	Alpha <sup>G</sup>	Depth <sup>G</sup> (mm)	Unc (k=2)
835	41.5	0.90	6.29	6.29	6.29	0.55	1.37	± 12.0 %
1750	40.1	1.37	5.24	5.24	5.24	0.72	1.22	± 12.0 %
1950	40.0	1.40	4.91	4.91	4.91	0.48	1.46	± 12.0 %

<sup>C</sup> Frequency validity above 300 MHz of ± 100 MHz only applies for DASY v4.4 and higher (see Page 2), else it is restricted to ± 50 MHz. The uncertainty is the RSS of the ConvF uncertainty at calibration frequency and the uncertainty for the indicated frequency band. Frequency validity below 300 MHz is ± 10, 25, 40, 50 and 70 MHz for ConvF assessments at 30, 64, 128, 150 and 220 MHz respectively. Above 5 GHz frequency validity can be extended to ± 110 MHz.

<sup>F</sup> At frequencies below 3 GHz, the validity of tissue parameters ( $\epsilon$  and  $\sigma$ ) can be relaxed to ± 10% if liquid compensation formula is applied to measured SAR values. At frequencies above 3 GHz, the validity of tissue parameters ( $\epsilon$  and  $\sigma$ ) is restricted to ± 5%. The uncertainty is the RSS of the ConvF uncertainty for indicated target tissue parameters.

<sup>G</sup> Alpha/Depth are determined during calibration. SPEAG warrants that the remaining deviation due to the boundary effect after compensation is always less than ± 1% for frequencies below 3 GHz and below ± 2% for frequencies between 3-6 GHz at any distance larger than half the probe tip diameter from the boundary.

ES3DV3- SN:3171

July 21, 2015

## DASY/EASY - Parameters of Probe: ES3DV3 - SN:3171

### Calibration Parameter Determined in Body Tissue Simulating Media

f (MHz) <sup>C</sup>	Relative Permittivity <sup>F</sup>	Conductivity (S/m) <sup>F</sup>	ConvF X	ConvF Y	ConvF Z	Alpha <sup>G</sup>	Depth (mm) <sup>G</sup>	Unc (k=2)
835	55.2	0.97	5.97	5.97	5.97	0.80	1.14	± 12.0 %
1750	53.4	1.49	4.87	4.87	4.87	0.39	1.82	± 12.0 %
1950	53.3	1.52	4.84	4.84	4.84	0.57	1.46	± 12.0 %

<sup>C</sup> Frequency validity above 300 MHz of ± 100 MHz only applies for DASY v4.4 and higher (see Page 2), else it is restricted to ± 50 MHz. The uncertainty is the RSS of the ConvF uncertainty at calibration frequency and the uncertainty for the indicated frequency band. Frequency validity below 300 MHz is ± 10, 25, 40, 50 and 70 MHz for ConvF assessments at 30, 64, 128, 150 and 220 MHz respectively. Above 5 GHz frequency validity can be extended to ± 110 MHz.

<sup>F</sup> At frequencies below 3 GHz, the validity of tissue parameters ( $\epsilon$  and  $\sigma$ ) can be relaxed to ± 10% if liquid compensation formula is applied to measured SAR values. At frequencies above 3 GHz, the validity of tissue parameters ( $\epsilon$  and  $\sigma$ ) is restricted to ± 5%. The uncertainty is the RSS of the ConvF uncertainty for indicated target tissue parameters.

<sup>G</sup> Alpha/Depth are determined during calibration. SPEAG warrants that the remaining deviation due to the boundary effect after compensation is always less than ± 1% for frequencies below 3 GHz and below ± 2% for frequencies between 3-6 GHz at any distance larger than half the probe tip diameter from the boundary.

ES3DV3- SN:3171

July 21, 2015

### Frequency Response of E-Field (TEM-Cell:ifi110 EXX, Waveguide: R22)

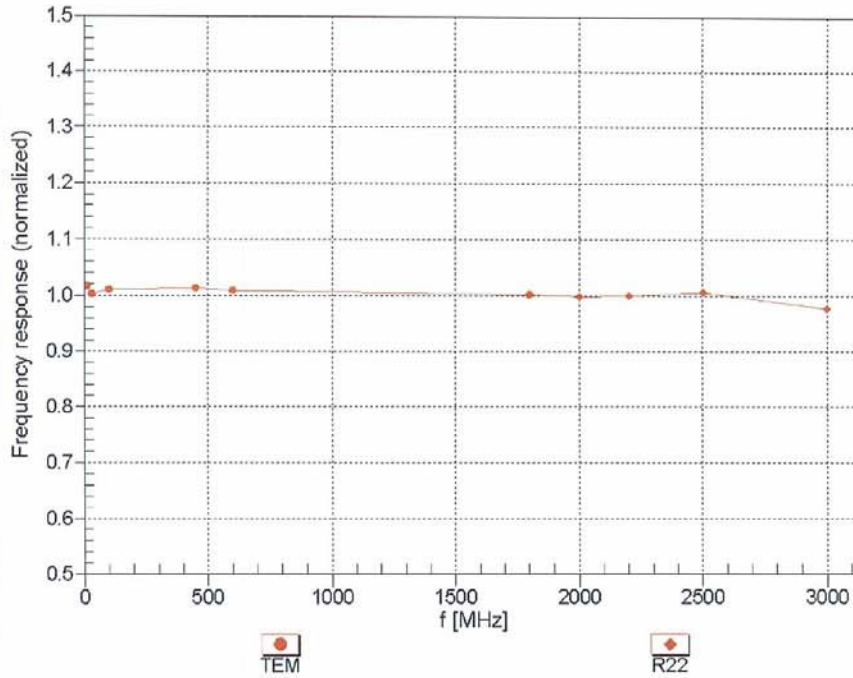

Uncertainty of Frequency Response of E-field:  $\pm 6.3\%$  (k=2)

ES3DV3- SN:3171

July 21, 2015

Receiving Pattern ( $\phi$ ),  $\theta = 0^\circ$

f=600 MHz,TEM

f=1800 MHz,R22

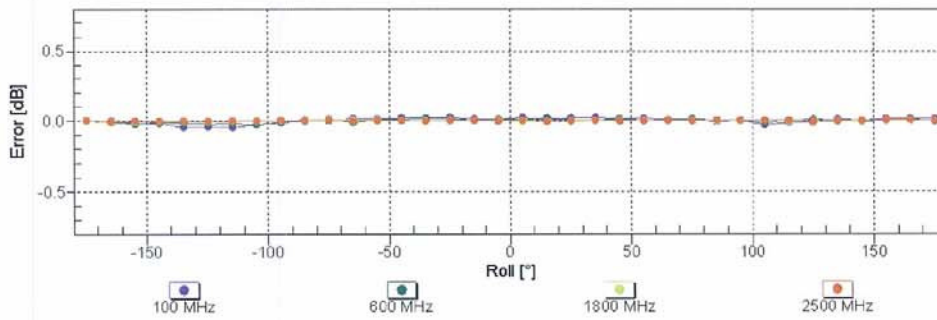
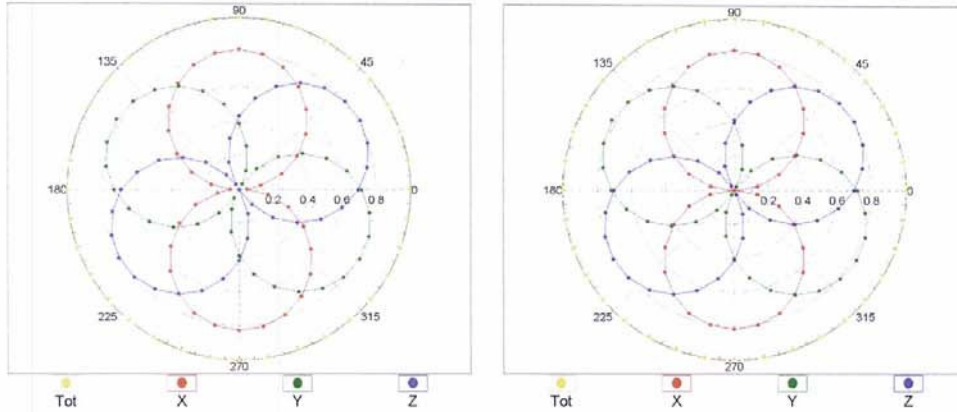

Uncertainty of Axial Isotropy Assessment:  $\pm 0.5\%$  (k=2)

ES3DV3-- SN:3171

July 21, 2015

**Dynamic Range f(SAR<sub>head</sub>)**  
(TEM cell , f<sub>eval</sub>= 1900 MHz)

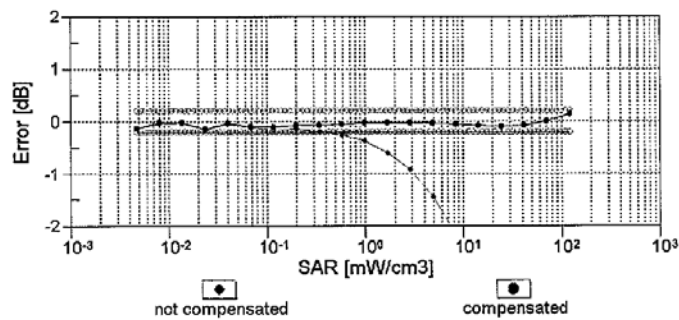
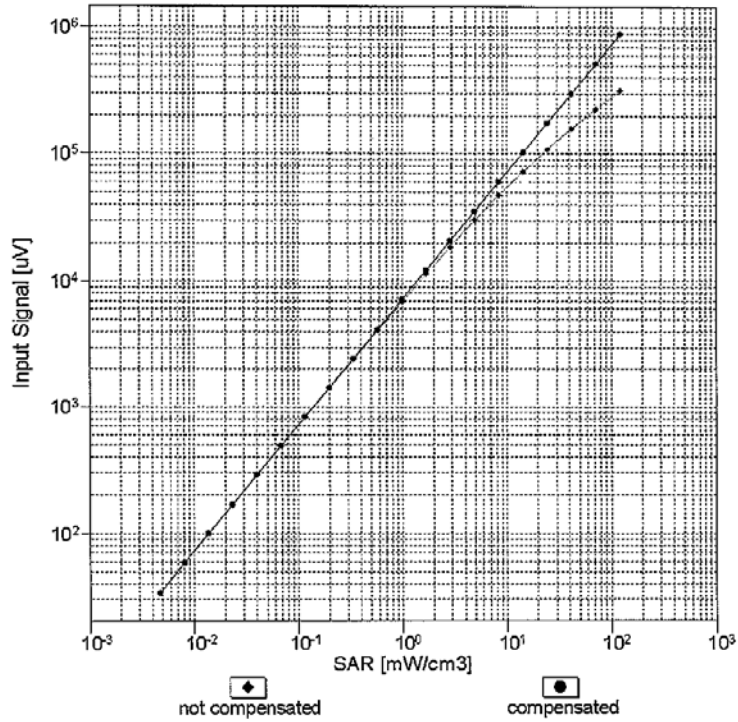

Uncertainty of Linearity Assessment: ± 0.6% (k=2)



ES3DV3- SN:3171

July 21, 2015

### Conversion Factor Assessment

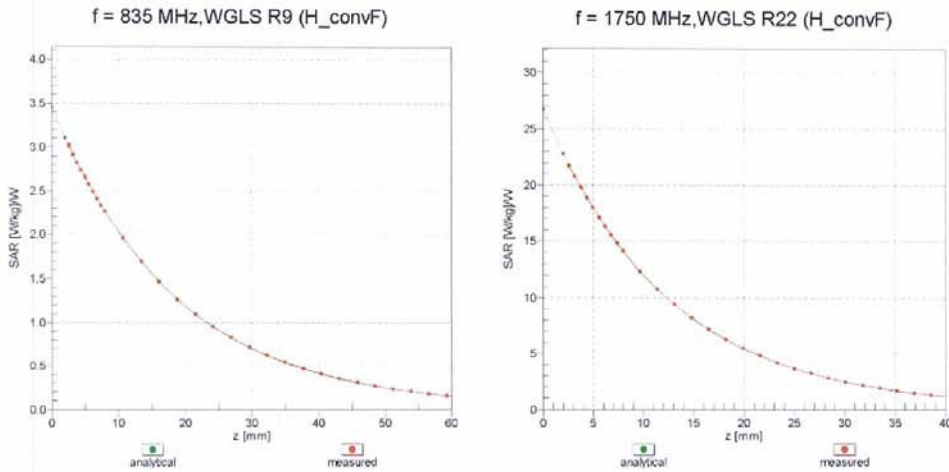

### Deviation from Isotropy in Liquid

Error ( $\phi, \theta$ ),  $f = 900$  MHz

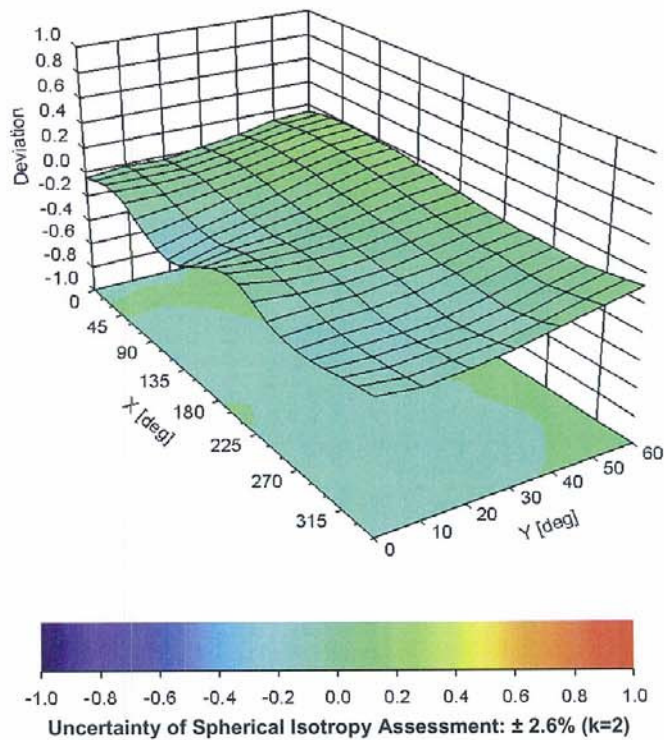

ES3DV3- SN:3171

July 21, 2015

**DASY/EASY - Parameters of Probe: ES3DV3 - SN:3171****Other Probe Parameters**

Sensor Arrangement	Triangular
Connector Angle (°)	105.2
Mechanical Surface Detection Mode	enabled
Optical Surface Detection Mode	disabled
Probe Overall Length	337 mm
Probe Body Diameter	10 mm
Tip Length	10 mm
Tip Diameter	4 mm
Probe Tip to Sensor X Calibration Point	2 mm
Probe Tip to Sensor Y Calibration Point	2 mm
Probe Tip to Sensor Z Calibration Point	2 mm
Recommended Measurement Distance from Surface	3 mm

< Probe : EX3DV4 – SN 3666 >

**Calibration Laboratory of  
Schmid & Partner  
Engineering AG**  
Zeughausstrasse 43, 8004 Zurich, Switzerland



**S** Schweizerischer Kalibrierdienst  
**C** Service suisse d'étalonnage  
**S** Servizio svizzero di taratura  
**S** Swiss Calibration Service

Accredited by the Swiss Accreditation Service (SAS)  
The Swiss Accreditation Service is one of the signatories to the EA  
Multilateral Agreement for the recognition of calibration certificates

Accreditation No.: **SCS 0108**

Client **One-Tech (Dymstec)**

Certificate No: **EX3-3666\_May15**

**CALIBRATION CERTIFICATE**

Object: **EX3DV4 - SN:3666**

Calibration procedure(s): **QA CAL-01.v9, QA CAL-14.v4, QA CAL-23.v5, QA CAL-25.v6  
Calibration procedure for dosimetric E-field probes**

Calibration date: **May 26, 2015**

This calibration certificate documents the traceability to national standards, which realize the physical units of measurements (SI).  
The measurements and the uncertainties with confidence probability are given on the following pages and are part of the certificate.

All calibrations have been conducted in the closed laboratory facility: environment temperature (22 ± 3)°C and humidity < 70%.

Calibration Equipment used (M&TE critical for calibration)

Primary Standards	ID	Cal Date (Certificate No.)	Scheduled Calibration
Power meter E4419B	GB41293874	01-Apr-15 (No. 217-02128)	Mar-16
Power sensor E4412A	MY41498087	01-Apr-15 (No. 217-02128)	Mar-16
Reference 3 dB Attenuator	SN: S5054 (3c)	01-Apr-15 (No. 217-02129)	Mar-16
Reference 20 dB Attenuator	SN: S5277 (20x)	01-Apr-15 (No. 217-02132)	Mar-16
Reference 30 dB Attenuator	SN: S5129 (30b)	01-Apr-15 (No. 217-02133)	Mar-16
Reference Probe ES3DV2	SN: 3013	30-Dec-14 (No. ES3-3013_Dec14)	Dec-15
DAE4	SN: 660	14-Jan-15 (No. DAE4-660_Jan15)	Jan-16
Secondary Standards	ID	Check Date (in house)	Scheduled Check
RF generator HP 8648C	US3642U01700	4-Aug-99 (in house check Apr-13)	In house check: Apr-16
Network Analyzer HP 8753E	US37390585	18-Oct-01 (in house check Oct-14)	In house check: Oct-15

	Name	Function	Signature
Calibrated by:	Jeton Kastrati	Laboratory Technician	
Approved by:	Katja Pokovic	Technical Manager	

Issued: May 28, 2015

This calibration certificate shall not be reproduced except in full without written approval of the laboratory.

**Calibration Laboratory of  
Schmid & Partner  
Engineering AG**  
Zeughausstrasse 43, 8004 Zurich, Switzerland



**S** Schweizerischer Kalibrierdienst  
**S** Service suisse d'étalonnage  
**C** Servizio svizzero di taratura  
**S** Swiss Calibration Service

Accredited by the Swiss Accreditation Service (SAS)  
The Swiss Accreditation Service is one of the signatories to the EA  
Multilateral Agreement for the recognition of calibration certificates

Accreditation No.: **SCS 0108**

**Glossary:**

TSL	tissue simulating liquid
NORM <sub>x,y,z</sub>	sensitivity in free space
ConvF	sensitivity in TSL / NORM <sub>x,y,z</sub>
DCP	diode compression point
CF	crest factor (1/duty_cycle) of the RF signal
A, B, C, D	modulation dependent linearization parameters
Polarization $\phi$	$\phi$ rotation around probe axis
Polarization $\vartheta$	$\vartheta$ rotation around an axis that is in the plane normal to probe axis (at measurement center), i.e., $\vartheta = 0$ is normal to probe axis
Connector Angle	information used in DASY system to align probe sensor X to the robot coordinate system

**Calibration is Performed According to the Following Standards:**

- a) IEEE Std 1528-2013, "IEEE Recommended Practice for Determining the Peak Spatial-Averaged Specific Absorption Rate (SAR) in the Human Head from Wireless Communications Devices: Measurement Techniques", June 2013
- b) IEC 62209-1, "Procedure to measure the Specific Absorption Rate (SAR) for hand-held devices used in close proximity to the ear (frequency range of 300 MHz to 3 GHz)", February 2005

**Methods Applied and Interpretation of Parameters:**

- **NORM<sub>x,y,z</sub>**: Assessed for E-field polarization  $\vartheta = 0$  ( $f \leq 900$  MHz in TEM-cell;  $f > 1800$  MHz: R22 waveguide). NORM<sub>x,y,z</sub> are only intermediate values, i.e., the uncertainties of NORM<sub>x,y,z</sub> does not affect the E<sup>2</sup>-field uncertainty inside TSL (see below ConvF).
- **NORM(f)<sub>x,y,z</sub>** = NORM<sub>x,y,z</sub> \* frequency\_response (see Frequency Response Chart). This linearization is implemented in DASY4 software versions later than 4.2. The uncertainty of the frequency response is included in the stated uncertainty of ConvF.
- **DCP<sub>x,y,z</sub>**: DCP are numerical linearization parameters assessed based on the data of power sweep with CW signal (no uncertainty required). DCP does not depend on frequency nor media.
- **PAR**: PAR is the Peak to Average Ratio that is not calibrated but determined based on the signal characteristics
- **A<sub>x,y,z</sub>; B<sub>x,y,z</sub>; C<sub>x,y,z</sub>; D<sub>x,y,z</sub>; VR<sub>x,y,z</sub>; A, B, C, D** are numerical linearization parameters assessed based on the data of power sweep for specific modulation signal. The parameters do not depend on frequency nor media. VR is the maximum calibration range expressed in RMS voltage across the diode.
- **ConvF and Boundary Effect Parameters**: Assessed in flat phantom using E-field (or Temperature Transfer Standard for  $f \leq 800$  MHz) and inside waveguide using analytical field distributions based on power measurements for  $f > 800$  MHz. The same setups are used for assessment of the parameters applied for boundary compensation (alpha, depth) of which typical uncertainty values are given. These parameters are used in DASY4 software to improve probe accuracy close to the boundary. The sensitivity in TSL corresponds to NORM<sub>x,y,z</sub> \* ConvF whereby the uncertainty corresponds to that given for ConvF. A frequency dependent ConvF is used in DASY version 4.4 and higher which allows extending the validity from  $\pm 50$  MHz to  $\pm 100$  MHz.
- **Spherical isotropy (3D deviation from isotropy)**: in a field of low gradients realized using a flat phantom exposed by a patch antenna.
- **Sensor Offset**: The sensor offset corresponds to the offset of virtual measurement center from the probe tip (on probe axis). No tolerance required.
- **Connector Angle**: The angle is assessed using the information gained by determining the NORM<sub>x</sub> (no uncertainty required).

EX3DV4 – SN:3666

May 26, 2015

# Probe EX3DV4

## SN:3666

Manufactured: October 20, 2008  
Calibrated: May 26, 2015

Calibrated for DASY/EASY Systems  
(Note: non-compatible with DASY2 system!)

EX3DV4– SN:3666

May 26, 2015

## DASY/EASY - Parameters of Probe: EX3DV4 - SN:3666

### Basic Calibration Parameters

	Sensor X	Sensor Y	Sensor Z	Unc (k=2)
Norm ( $\mu\text{V}/(\text{V}/\text{m})^2$ ) <sup>A</sup>	0.57	0.62	0.55	$\pm 10.1\%$
DCP (mV) <sup>B</sup>	98.6	97.5	96.6	

### Modulation Calibration Parameters

UID	Communication System Name		A dB	B dB $\sqrt{\mu\text{V}}$	C	D dB	VR mV	Unc <sup>E</sup> (k=2)
0	CW	X	0.0	0.0	1.0	0.00	129.6	$\pm 3.5\%$
		Y	0.0	0.0	1.0		148.1	
		Z	0.0	0.0	1.0		147.4	

The reported uncertainty of measurement is stated as the standard uncertainty of measurement multiplied by the coverage factor k=2, which for a normal distribution corresponds to a coverage probability of approximately 95%.

<sup>A</sup> The uncertainties of NormX,Y,Z do not affect the E<sup>2</sup>-field uncertainty inside TSL (see Pages 5 and 6).

<sup>B</sup> Numerical linearization parameter: uncertainty not required.

<sup>E</sup> Uncertainty is determined using the max. deviation from linear response applying rectangular distribution and is expressed for the square of the field value.

EX3DV4- SN:3666

May 26, 2015

## DASY/EASY - Parameters of Probe: EX3DV4 - SN:3666

### Calibration Parameter Determined in Head Tissue Simulating Media

f (MHz) <sup>C</sup>	Relative Permittivity <sup>F</sup>	Conductivity (S/m) <sup>F</sup>	ConvF X	ConvF Y	ConvF Z	Alpha <sup>G</sup>	Depth (mm) <sup>G</sup>	Unct. (k=2)
2450	39.2	1.80	7.62	7.62	7.62	0.38	0.80	± 12.0 %
5200	36.0	4.66	5.72	5.72	5.72	0.30	1.80	± 13.1 %
5300	35.9	4.76	5.46	5.46	5.46	0.35	1.80	± 13.1 %
5500	35.6	4.96	5.19	5.19	5.19	0.35	1.80	± 13.1 %
5600	35.5	5.07	4.94	4.94	4.94	0.40	1.80	± 13.1 %
5800	35.3	5.27	5.10	5.10	5.10	0.40	1.80	± 13.1 %

<sup>C</sup> Frequency validity above 300 MHz of ± 100 MHz only applies for DASY v4.4 and higher (see Page 2), else it is restricted to ± 50 MHz. The uncertainty is the RSS of the ConvF uncertainty at calibration frequency and the uncertainty for the indicated frequency band. Frequency validity below 300 MHz is ± 10, 25, 40, 50 and 70 MHz for ConvF assessments at 30, 64, 128, 150 and 220 MHz respectively. Above 5 GHz frequency validity can be extended to ± 110 MHz.

<sup>F</sup> At frequencies below 3 GHz, the validity of tissue parameters ( $\epsilon$  and  $\sigma$ ) can be relaxed to ± 10% if liquid compensation formula is applied to measured SAR values. At frequencies above 3 GHz, the validity of tissue parameters ( $\epsilon$  and  $\sigma$ ) is restricted to ± 5%. The uncertainty is the RSS of the ConvF uncertainty for indicated target tissue parameters.

<sup>G</sup> Alpha/Depth are determined during calibration. SPEAG warrants that the remaining deviation due to the boundary effect after compensation is always less than ± 1% for frequencies below 3 GHz and below ± 2% for frequencies between 3-6 GHz at any distance larger than half the probe tip diameter from the boundary.

EX3DV4- SN:3666

May 26, 2015

## DASY/EASY - Parameters of Probe: EX3DV4 - SN:3666

### Calibration Parameter Determined in Body Tissue Simulating Media

f (MHz) <sup>C</sup>	Relative Permittivity <sup>F</sup>	Conductivity (S/m) <sup>F</sup>	ConvF X	ConvF Y	ConvF Z	Alpha <sup>G</sup>	Depth (mm) <sup>G</sup>	Unct. (k=2)
2450	52.7	1.95	7.76	7.76	7.76	0.28	0.80	± 12.0 %
5200	49.0	5.30	5.05	5.05	5.05	0.40	1.90	± 13.1 %
5300	48.9	5.42	4.73	4.73	4.73	0.40	1.90	± 13.1 %
5500	48.6	5.65	4.33	4.33	4.33	0.45	1.90	± 13.1 %
5600	48.5	5.77	4.25	4.25	4.25	0.45	1.90	± 13.1 %
5800	48.2	6.00	4.73	4.73	4.73	0.45	1.90	± 13.1 %

<sup>C</sup> Frequency validity above 300 MHz of ± 100 MHz only applies for DASY v4.4 and higher (see Page 2), else it is restricted to ± 50 MHz. The uncertainty is the RSS of the ConvF uncertainty at calibration frequency and the uncertainty for the indicated frequency band. Frequency validity below 300 MHz is ± 10, 25, 40, 50 and 70 MHz for ConvF assessments at 30, 64, 128, 150 and 220 MHz respectively. Above 5 GHz frequency validity can be extended to ± 110 MHz.

<sup>F</sup> At frequencies below 3 GHz, the validity of tissue parameters ( $\epsilon$  and  $\sigma$ ) can be relaxed to ± 10% if liquid compensation formula is applied to measured SAR values. At frequencies above 3 GHz, the validity of tissue parameters ( $\epsilon$  and  $\sigma$ ) is restricted to ± 5%. The uncertainty is the RSS of the ConvF uncertainty for indicated target tissue parameters.

<sup>G</sup> Alpha/Depth are determined during calibration. SPEAG warrants that the remaining deviation due to the boundary effect after compensation is always less than ± 1% for frequencies below 3 GHz and below ± 2% for frequencies between 3-6 GHz at any distance larger than half the probe tip diameter from the boundary.